

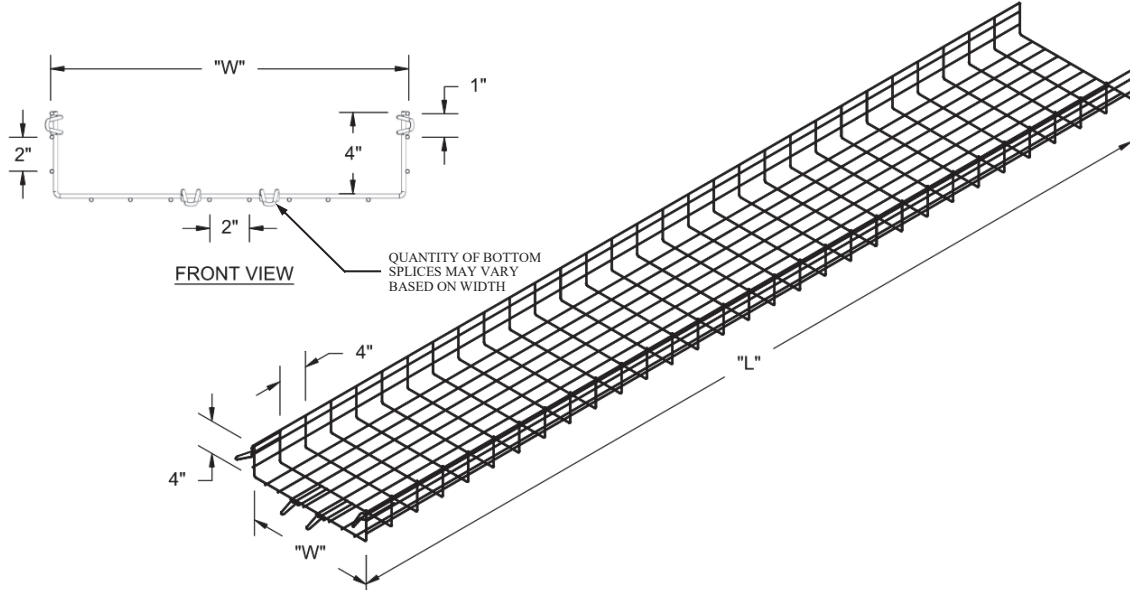

EASYCONNECT[®]

BASKET TRAY

WBS24 - "W" - 3M - EZ



NEMA TRAY TYPE	WIRE BASKET			
NEMA / CSA CLASS	THE TRAYS HAVE BEEN TESTED IN ACCORDANCE WITH NEMA VE-1 AND HAVE A 1.5 SAFETY FACTOR OVER THE LOADS SHOWN IN THE TABLE BELOW UL CLASSIFIED AS AN EGC IF UL MARKING IS 0.2 OR GREATER			
MATERIAL/FINISH	STEEL/ELECTROPLATED ZINC			
CAT# PREFIX	-	CHOOSE WIDTH	-	TRAY LENGTH
WBS24	-	4", 6", 8", 12", 18" & 24"	-	118-1/8" (3m)

SAMPLE CATALOG NUMBER - 4" HIGH, 18" Wide, 3M Long

WBS24- 18- 3M- EZ

NEMA LOAD AND DEFLECTION TABLE				
CATALOG NUMBER	WIDTH	8 FT SPAN lbs/ft (kg/m)	BOTTOM SPLICES REQUIRED	UL MARKING
WBS24-4-3M-EZ	4" (100mm) Wide	14 (20.8)	0	N/A
WBS24-6-3M-EZ	6" (150mm) Wide	19 (28.3)	0	N/A
WBS24-8-3M-EZ	8" (200mm) Wide	24 (35.7)	0	0.2
WBS24-12-3M-EZ	12" (300mm) Wide	29 (43.2)	1	0.2
WBS24-18-3M-EZ	18" (450mm) Wide	32 (47.6)	2	0.2
WBS24-24-3M-EZ	24" (600mm) Wide	40 (59.5)	2	0.4

COMMON ACCESSORIES FOR BASKET SYSTEMS









The following items are available to aid in the installation of our wire basket tray systems.

	<p>WB-SPLICE-VX-K STRAIGHT SPLICE CONNECTOR</p>		<p>WB-LU-VX-EZ STRAIGHT SPLICE</p>
	<p>WB-SC-SET-VX-EZ UNIVERSAL SPLICE</p>		<p>WB-90-VX-K 90° HORIZONTAL KIT</p>
	<p>WB-STRUT-CLP-VX-ZF CLIP MOUNT FOR STRUT</p>		<p>WB-HDC-VX-EZ HOLD DOWN CLAMP</p>
	<p>WBCT WIRE BASKET CUTTING TOOL</p>		<p>SSP-90-VX-EZ 90 DEGREE SQUARE BEND SPLICE</p>
	<p>WB-CG-VX-RADIUS-EZ SNAP-IN CORNER RADIUS INSERT</p>		<p>WB-TEE-VX-K TEE CONNECTOR KIT INCLUDES 2 CORNERS ORDER 2 FOR CROSSES</p>
	<p>CSS SEPARATOR SPLICE CONNECTOR</p>		<p>SFS-VWB-EZ-K VERTICAL HINGE CONNECTOR KIT</p>
	<p>S4S-3M-EZ-VX STRAIGHT SEPARATOR 3M LENGTH</p>		<p>S4S-HA-EZ-VX HORIZONTAL FITTING SEPARATOR</p>

COMMON ACCESSORIES FOR BASKET SYSTEMS

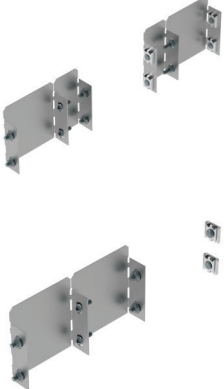
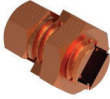

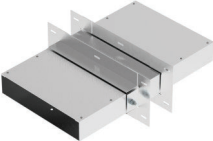
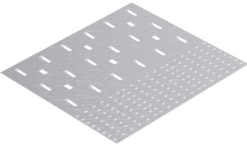
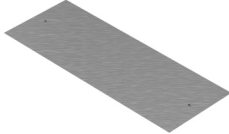

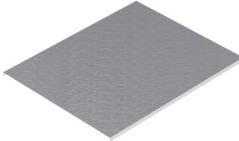

The following items are available to aid in the installation of our wire basket tray systems.

	<p>WB-CH-2X2-VX-EZ CHANNEL HANGER FOR 2" WIDE BASKET</p>		<p>WB-VDS-U-VX-EZ CONDUIT DROPOUT ADAPTER</p>
	<p>END PLATES</p> <p>WBEP-4X4-VX-EZ WBEP-6X4-VX-EZ WBEP-8X4-VX-EZ WBEP-12X4-VX-EZ WBEP-18X4-VX-EZ WBEP-24X4-VX-EZ</p>		<p>END REDUCERS</p> <p>WB-EP-6R4X4-EZ-VX WB-EP-8R4X4-EZ-VX WB-EP-8R6X4-EZ-VX WB-EP-12R4X4-EZ-VX WB-EP-12R6X4-EZ-VX WB-EP-12R8X4-EZ-VX WB-EP-18R4X4-EZ-VX WB-EP-18R6X4-EZ-VX WB-EP-18R8X4-EZ-VX WB-EP-18R12X4-EZ-VX WB-EP-24R4X4-EZ-VX WB-EP-24R6X4-EZ-VX WB-EP-24R8X4-EZ-VX WB-EP-24R12X4-EZ-VX WB-EP-24R18X4-EZ-VX</p>
	<p>WB-GC-6-VX GROUND CONNECTOR #6AWG - #4 AWG</p>		<p>DROPOUTS</p> <p>WB-BD-100-EZ WB-BD-2-EZ WB-BD-4-EZ WB-BD-6-EZ WB-BD-8-EZ WB-BD-12-EZ WB-BD-18-EZ WB-BD-24-EZ</p>
	<p>PWPS-(W)-WBS24 WALL PENETRATION SLEEVE (W) = WIDTH</p>	<p>WB-BD-100-VX-EZ</p> 	<p>END DROPOUT KIT</p>
	<p>SWB0SBI-(W)-3M-VX-EZ SOLID BOTTOM INSERT (W) = WIDTH</p>		<p>CVR-CLIP-VX-EZ COVER CLIP FOR BASKET</p>
	<p>WBCF2-(W)-3M-VX FLANGED COVER FOR BASKET (W) = WIDTH</p>		

COMMON ACCESSORIES FOR BASKET SYSTEMS

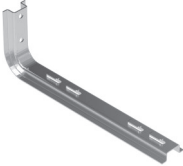
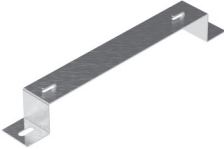
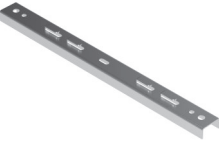

The following items are available to aid in the installation of our wire basket tray systems.

	<p>WB-VHC-VX-EZ VERTICAL SIDE HANGER</p>		<p>WBSVBK-(W)-VX-EZ (W) = WIDTH SHELF WALL BRACKET FOR 6" WIDE, USE WBSVBK-6-H4-VX-EZ</p>
	<p>WBSWLB-(W)-VX-EZ (W) = WIDTH "L" WALL BRACKET FOR 6" WIDE, USE WBSWLB-6-H4-VX-EZ</p>		<p>WB-RS-(W)-VX-EZ FLOOR SUPPORT RAISES TRAY 1.94" OFF THE FLOOR</p>
	<p>WBSUS-(W)-VX-EZ (W) = WIDTH TRAPEZE SUPPORT BRACKET FOR 6" WIDE, USE WBSUS-6-H4-VX-EZ</p>		<p>WB-UFR-VX UNDER RAISED FLOOR SUPPORT ASSEMBLY</p>
			<p>WB-WALL-MOUNT-VX-EZ END WALL MOUNT USED TO MOUNT END OF TRAY AT A WALL</p>

WIRE BASKET SPLICE KITS



Straight Splice Connector
Heavy duty straight splice connector for a very strong splice connection at field cuts. Includes 2 bottom clamps for use on widths that require the bottom clamps.

*Includes: (2) WB-LU-300-VX-EZ (TOP)
(6) WB-SC-BN-VX-EZ (MIDDLE)
(2) WB-SC-SET-VX-EZ (BOTTOM)*

Description	Catalog No.
WB Straight Splice Kit, EZ	WB-SPLICE-VX-K

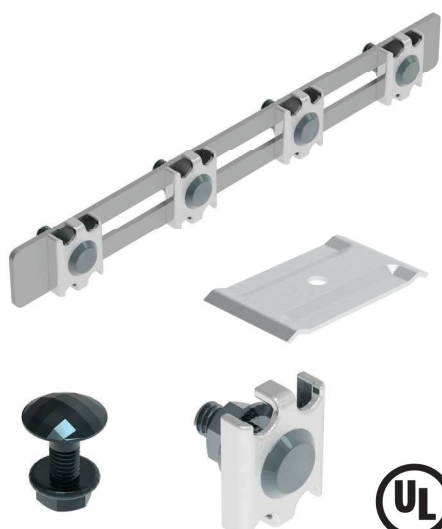



90° Splice Connector
Heavy duty 90° splice connectors for making square or radiused bends.

*Includes: (2) WB-LU-500-VX-EZ (TOP)
(2) WB-HDC-VX-EZ (MIDDLE)
(1) B-120 BOLTS & (1) N-120 NUTS (BOTTOM LEFT)
(8) WB-SC-BN-VX-EZ (BOTTOM RIGHT)*

LINE 002 WB-90-VX-K

Description	Catalog No.
WB 90° Horizontal Kit, EZ	WB-90-VX-K





Horizontal Tee/Cross Connector Kit
This kit is used to construct horizontal tees and crosses by bending the bars in the field. Order two kits to construct a cross.

*Includes: (2) WB-LU-500-VX-EZ (TOP)
(8) WB-SC-BN-VX-EZ (BOTTOM)*

LINE 003 & 004 WB-TEE-VX-K

Description	Catalog No.
WB Tee Kit, EZ	WB-TEE-VX-K



SPLICES & ACCESSORIES

WIRE BASKET SPLICES





Splice Staple Set
 The complete splice/staple set. Splice Staple sets are used to connect bottoms and even sides when making field cuts. They are also used when forming horizontal bends to fasten the segments together. Sold in packs of 100.

Includes: (1) *WB-SC-BN-VX-EZ*
 (1) *WB-SC-BTM-VX-EZ*

LINE 005 WB-SC-SET-VX-EZ-PK

Description	Catalog No.
Splice Staple Set	WB-SC-SET-VX-EZ-PK







Straight Splice
 Heavy duty straight splice connector for a very strong splice connection. Typically used on the sides, but usable on the bottom of the tray. Splice is 12" long. This item doesn't include a bottom connector like in the WB-SPLICE-VX-K. One Splice Connector.

Includes: (1) *WB-LU-300-VX-EZ (TOP)*
 (3) *WB-SC-BN-EZ (BOTTOM)*

Description	Catalog No.
Straight Splice, EZ	WB-LU-VX-EZ





Vertical Hinge Splice
 Vertical hinge connectors are used to slope trays or to make elevation changes. Vertical hinge splices are sold in pairs. Bonding jumpers should be used on both sides of the tray to jump over the splice, unless a separate ground wire is used and attached to each section.

Includes: (4) *WB-LU-300-VX-EZ*
 (8) *WB-SC-BN-EZ (BOTTOM LEFT)*
 (2) *B-120 BOLTS & (2) N-120 NUTS (BOTTOM RIGHT)*

Description	Catalog No.
Vertical Hinge Splice Set	SFS-VWB-VX-EZ-K

SPLICES & ACCESSORIES