

SERIES N1A STOP GATE



www.HallidayProducts.com
 Phone 800-298-1027
 Fax 407-298-4534
 Sales@HallidayProducts.com

STANDARD FEATURES:

- ONE-PIECE 6061-T6 EXTRUDED ALUMINUM FRAME
- ONE-PIECE, WRAP AROUND POLYMER GUIDE
- 1/4" (7 mm) THICK 6061-T6 ALUMINUM GATE REINFORCED TO DEFLECT NO MORE THAN 1/360th OF SPAN (5' MAX HEAD PRESSURE)
- LOW COEFFICIENT OF FRICTION
- NON-OZONE DEPLETING BITUMINOUS COATING ON FRAME
- DEEP SEATING FOR OPTIMUM TRACKING
- STANDARD "R" HANDLE OR OPTIONAL "P" HANDLE
- SERIES N1A AND N1C SUPPLIED WITH $\phi 9/16$ " (14 mm) MOUNTING HOLES AND 1/2" X 4" S.STL. WEDGE ANCHORS
- 3 YEAR GUARANTEE

QUANTITY

SERIES N1A
SERIES N1B
 SERIES N1C

CHANNEL WIDTH 1' 4"

CHANNEL HEIGHT 4'

GATE HEIGHT 3'

STD HANDLE
 PIPE HANDLE

SERIES N1A
 (WALL MOUNTED)

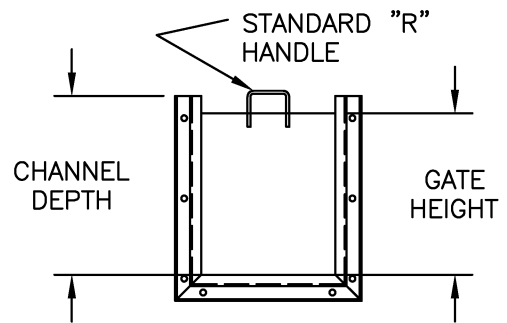
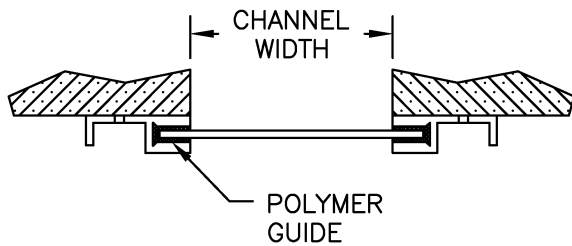

SERIES N1B
 (EMBEDDED)

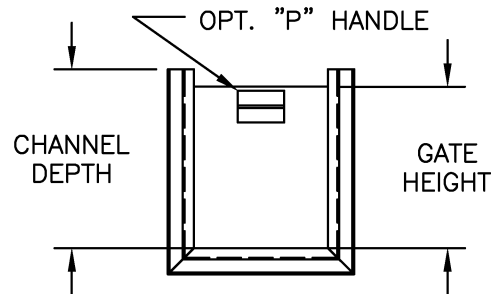
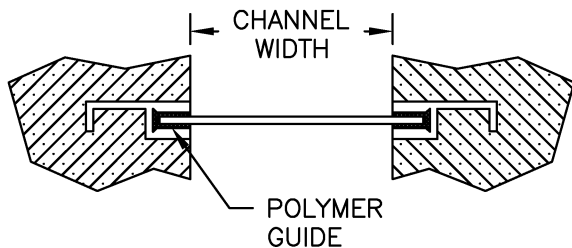

SERIES N1C
 (IN-CHANNEL MOUNTED)

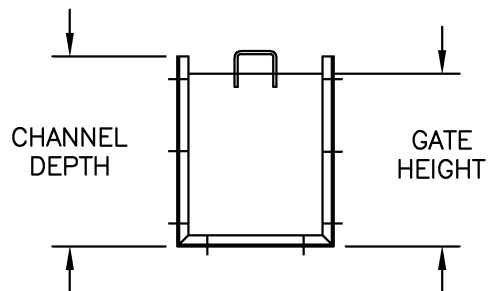
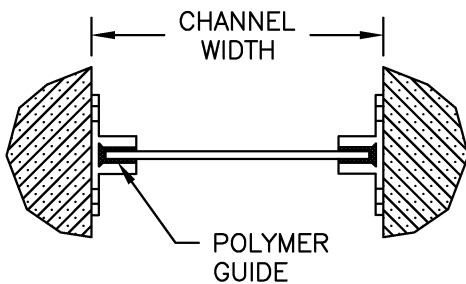

GATE BOTTOM



STANDARD
 "R" HANDLE

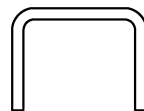

OPTIONAL
 "P" HANDLE

