



KANSAS CITY KANSAS PUBLIC SCHOOLS / USD 500

PURCHASING OFFICE | 2010 N. 59TH STREET ROOM 370 \ KANSAS CITY, KS 66104

WEB SITE: WWW.KCKPS.ORG/PURCHASING

TOILET PARTITION REPLACEMENT & UPGRADES (VARIOUS LOCATIONS)

BID No: IFB 22-017 ISSUE DATE: MAY 4, 2022

Kansas City Kansas Public Schools will receive sealed bids, on this form at the Purchasing Office, 2010 N. 59th Street, Room 370, Kansas City, KS 66104 until **10:00 AM., May 12, 2022**, at which time bids received will be publicly opened and read, all in accordance with bid instructions, specifications and/or bid conditions attached hereto or as shown below.

PRE-BID CONFERENCE (Non-Mandatory)

Date: May 6, 2022

Time: 9:00 AM

**Location: Shop Office
North Central Office, Suite 229
Kansas City, KS 66104**

Information: At which time a pre-bid meeting will be held. Pre-bid meeting is non-mandatory.

Contact/Technical Contact:

Brian Hernandez, Assistant Director of Purchasing | (913) 279-2244 | eMail: brian.hernandez@kckps.org

BID INSTRUCTIONS:

FAXED BIDS WILL NOT BE ACCEPTED / EMAILED BIDS WILL NOT BE ACCEPTED.

Per attached specifications listed in this invitation to bid. Bidders must specify manufacturer/model number/delivery days, and unit price on each item or bid may be determined to be non-responsive.

- Pricing shall be FOB Kansas City, KS (freight and fuel expenses included).
- KCKPS may award to more than one vendor.
- The District reserves the right to reject any or all bids, to waive any informalities, irregularities, or technical defects in bids, and unless otherwise specified by the District to accept any item or groups of items in the bid, as may be in the best interest of the District.
- Time (days, weeks, etc.) required for delivery is a significant consideration with respect to this award process. The time required for delivery must be indicated in the space provided or your bid may be found non-responsive and may not be considered.
- Bid shall include copies of pertinent warranty information pertaining to the product offered. The bidder agrees that equipment furnished under any resultant purchase order issued by Kansas City Kansas Public

Schools shall be covered by commercial warranties the contractor gives to any customer for such supplies. All warranty information and certificates shall be furnished and become the property of the District upon delivery and acceptance of said items and/or the contractor must honor services and all rights and remedies stated in the warranties.

- All items are new manufacture unless otherwise specifically stated in this bid.
- All products must have passed the first line quality standard as set by the manufacturer and no seconds, blemished articles or items having defective workmanship are included.
- Bidder shall notify the District immediately of any changes to specifications made by the manufacturer for the equipment listed.
- Bid may not be considered if a service charge, minimum dollar, or minimum quantity order is applied.
- The outcome of this bid will be posted on the District's Purchasing site www.kckps.org/purchasing under Awards Section and will include a bid tabulation/summary.
- Bidder shall acknowledge all addenda for this bid and include the form acknowledgements with their bid.

INCLEMENT WEATHER/EMERGENCY POLICY

IF THERE IS A BUILDING CLOSING THE DAY OF THE OPENING OF PROPOSALS DUE TO INCLEMENT WEATHER OR AN EMERGENCY, THE OPENING OF PROPOSALS WILL OCCUR AT 2:00PM (CENTRAL) THE NEXT BUSINESS DAY THE DISTRICT IS OPEN.

Reference Attachment B for further Bid Conditions and Instructions

Scope of Work

The Kansas City Kansas Public Schools is seeking bids for replacement of toilet partitions in various schools throughout the district. Additionally, vendor will be responsible for hauling away existing partitions and properly disposing of them.

In all cases the bids will include:

- Metpar Phenolic partitions
 - No continuous hinges
 - Full length wall brackets
 - Head rail where needed
- Removal and disposal of existing

SPECIFICATIONS:

- **Pilaster Shoes:** Formed Stainless steel with a Brush finish, 3" high, concealing floor fasteners.
- **Head Rails:** Anti-Grip Hollow Aluminum tube, and cast socket wall brackets.
- **Pilaster Brackets:** Stainless Steel
- **Wall Brackets:** Full Length- Stainless Steel
- **Screws, Bolts, Fasteners:** Stainless Steel Tamper-proof type
 - For attaching panels and pilasters to brackets: Through-bolts and nuts; tamper-proof.
- **Hardware:**
 - Pivot Hinges: Concentric type, adjustable for door close positioning; two per door; no continuous hinges
 - Door Latch: Slide type
 - Door Strike and Keeper: With rubber bumper; mounted on a pilaster in alignment with the door latch
 - Disabled Stalls: Must be compliant with code specifications
 - All Stalls shall be compliant with applicable codes

Specifications particulars will be discussed at Pre-Bid Conference.

COMPONENTS

- Stalls/Compartments: Solid molded phenolic plastic panels, doors, and pilasters, floor-mounted overhead/headrail braced.
- Color: Stock/Folkstone Celesta
- Door and Panel Dimensions:
 - Thickness: ¾ in Doors
 - Wall panels 1/2in.

Bidders will include proposed timeline for completion and proposed daily work hours.

Bid Security

Bid Bond: Bid security shall be submitted with each bid in the amount of five percent (5%) of the bid amount. No bids may be withdrawn for a period of sixty (60) days after opening of bids. Owner reserves the right to reject any and all bids and to waive informalities and irregularities.

Payment & Performance Bond: Bidder agrees to furnish a Payment & Performance Bond, in the amount

of 100% (one hundred percent) of total contract value after receipt of contract.

Prevailing Wage/Union

Prevailing Wage IS NOT required. There is no union labor requirement for this solicitation.

Time of Completion

Successful bidder shall begin the Work on receipt of the Notice to Proceed and shall complete the Work (Substantial Completion) per agreed upon work schedule and completion date.

Liquidated Damages

Timeley completion of this project by the agreed upon completion date is imperative. At the District's sole discretion, liquidated damages in the amount of Two-Hundred-Fifty Dollars (\$250.00) per calendar day will be assessed against the Contract if the project is not completed by the date indicated.

Clean-Up

The Contractor will keep the premises free from accumulations of debris and waste materials caused by its employees in performance of the work. At completion of the project, Contractor shall remove all crating, packaging, waste and debris from the building and the site, and all tools, scaffolding and surplus materials, and shall leave the building and site "broom clean" or its equivalent.

Permits, Codes and Ordinances

Each Contractor shall file and pay for required permits affecting its work (if applicable). Each contractor shall conform to applicable codes and ordinances, including OSHA requirements.

Damage to District Property

Contractor at its own expense shall promptly remedy and repair all damages or loss to any property caused in whole or part by its employees, subcontractor(s), supplier or anyone directly or indirectly employed by either of them, or by anyone for whose acts either of them may be liable.

No Smoking: The District adheres to the mandatory "No Smoking" policy on school premises and/or at school functions. All bidders shall comply with this "No Smoking" policy.

Provided diagrams are for reference only. Each bidder will be responsible to verify field measurements.

Central Middle School

925 Iwandle St

Kansas City, KS 66101

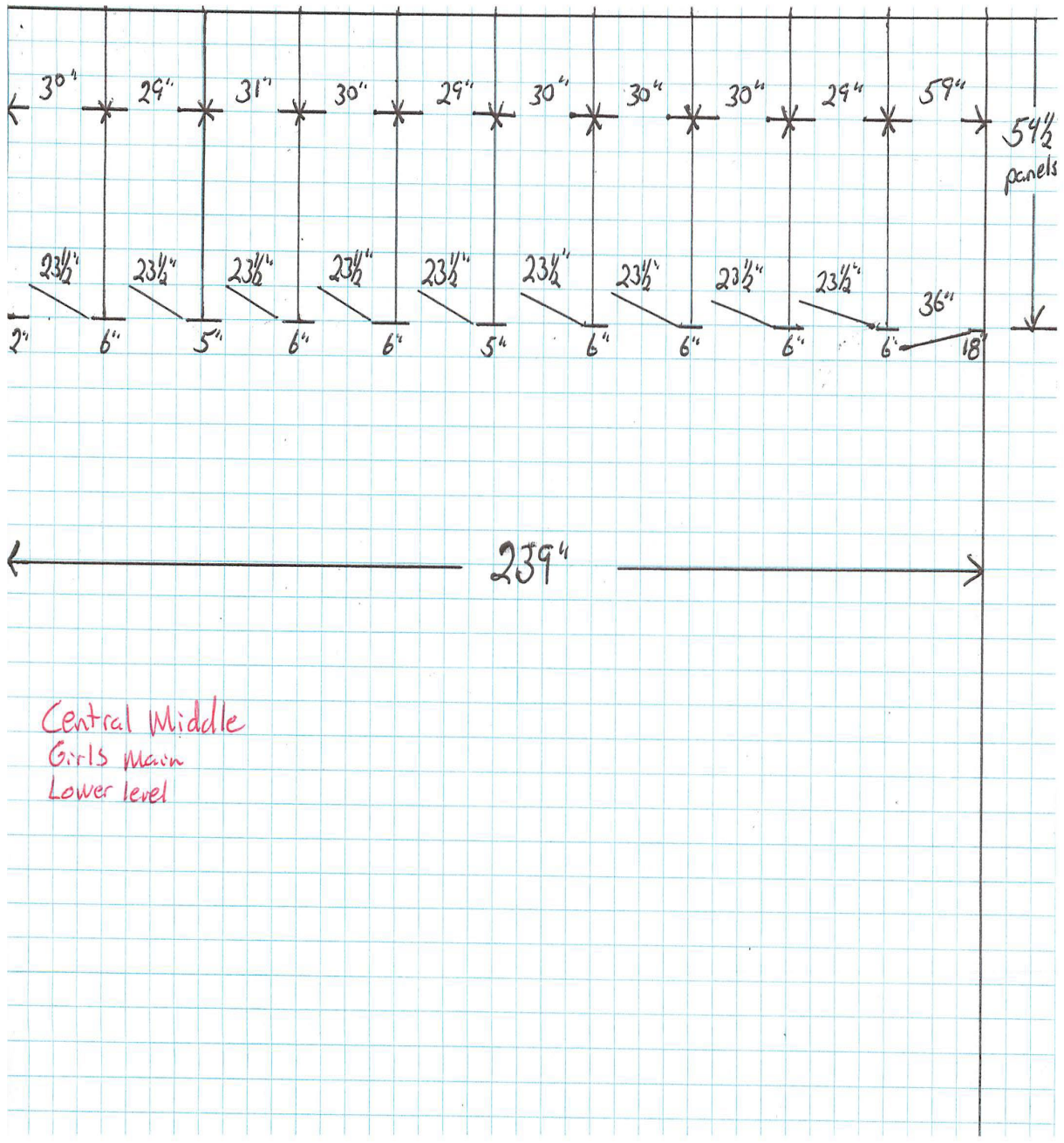

Central Middle
Girls Main
Lower level

Central Middle
Girls by gym.

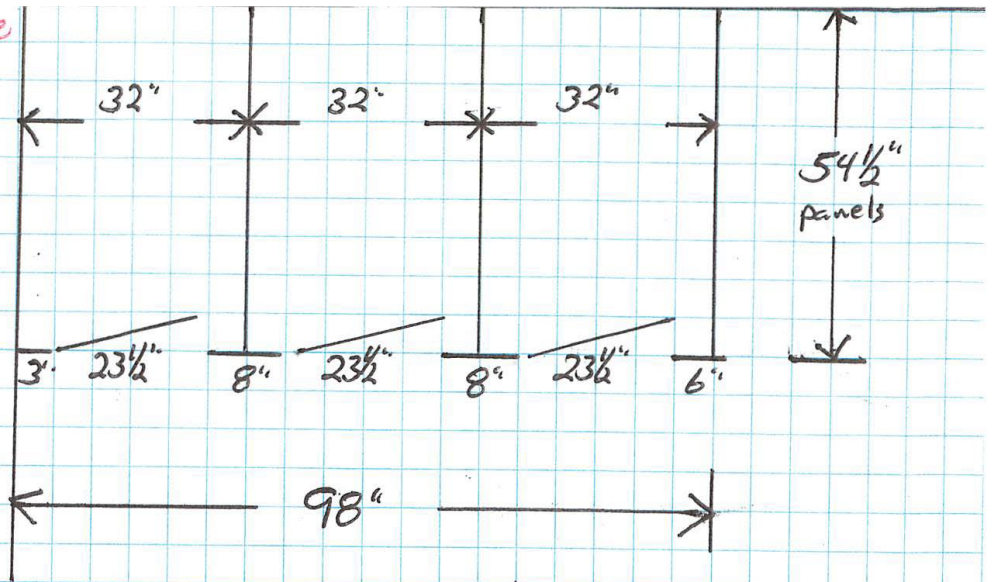

Central Middle
Boys Auditorium

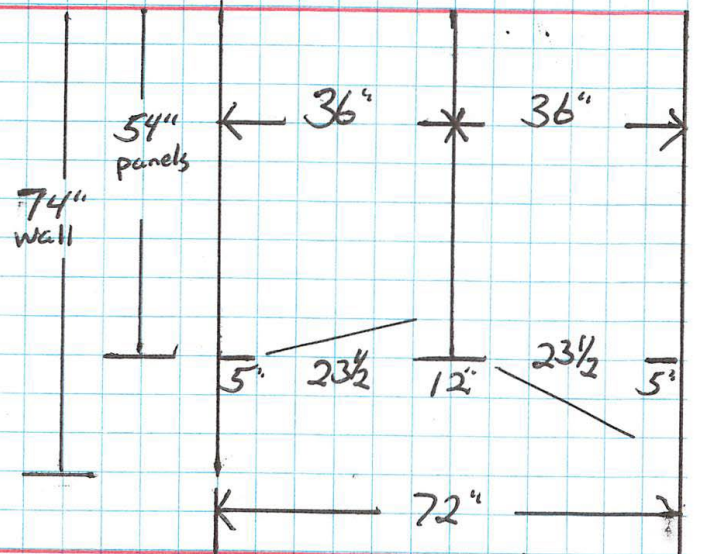

Central Middle
Girls Auditorium

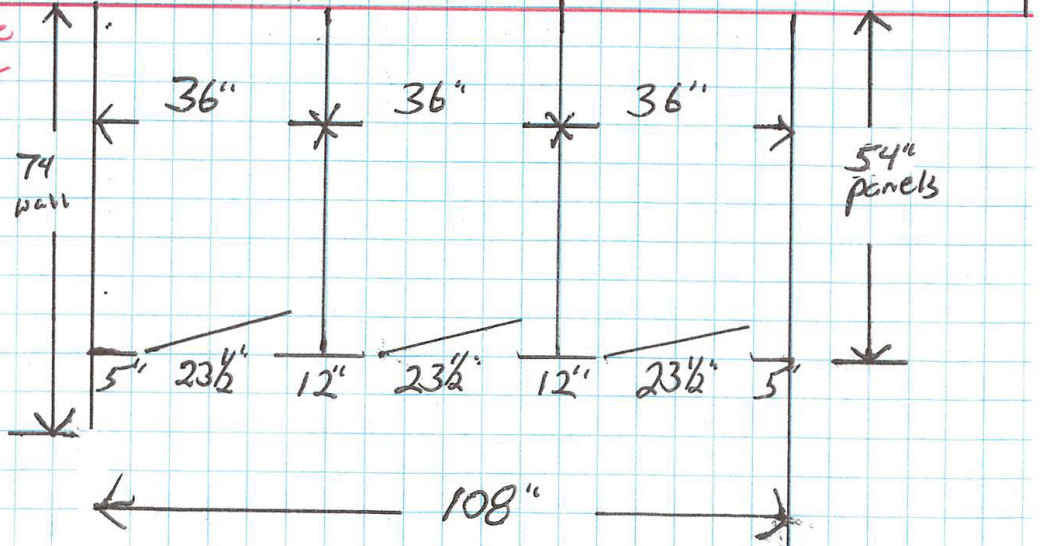

Lindbergh School

641 N 57th St

Kansas City, KS 66102

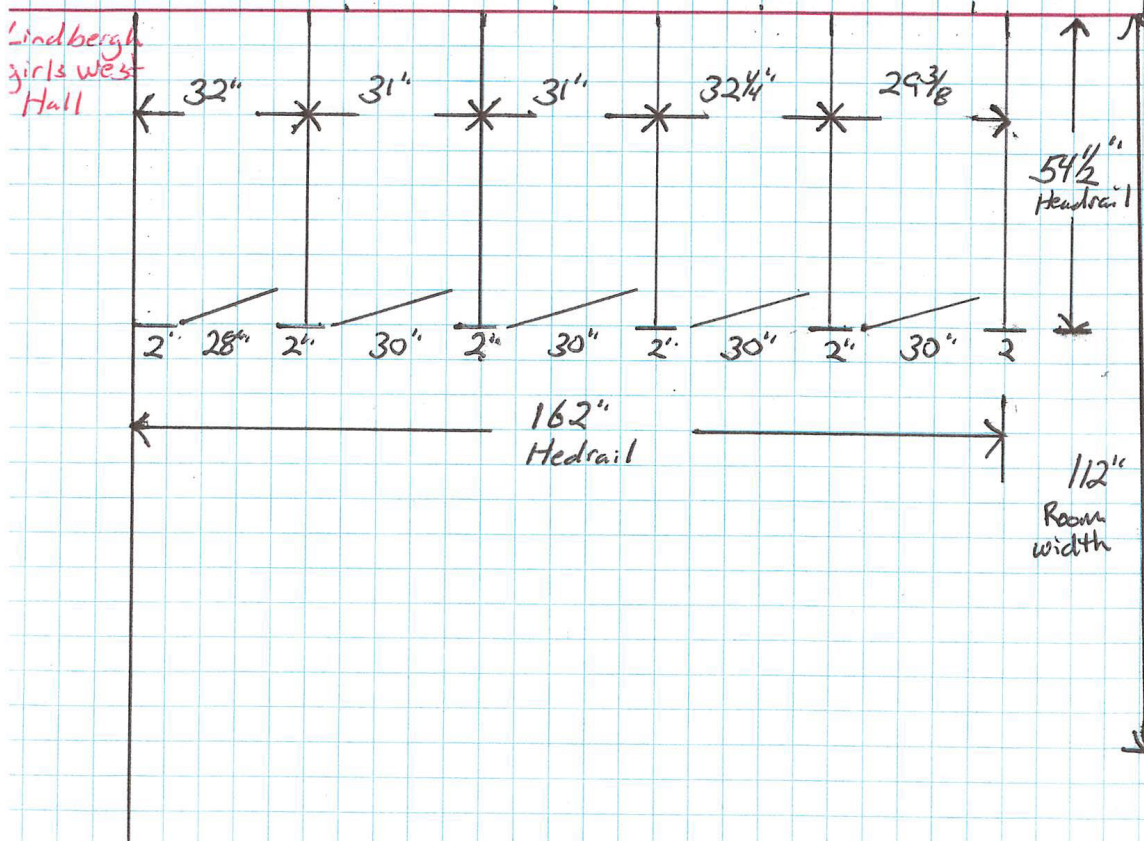
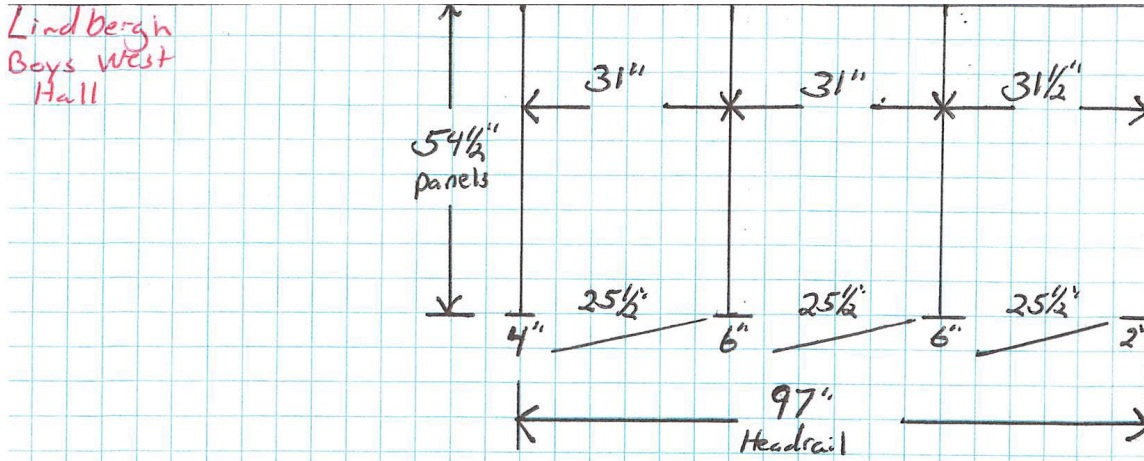

Lindbergh
Boy South
Hall

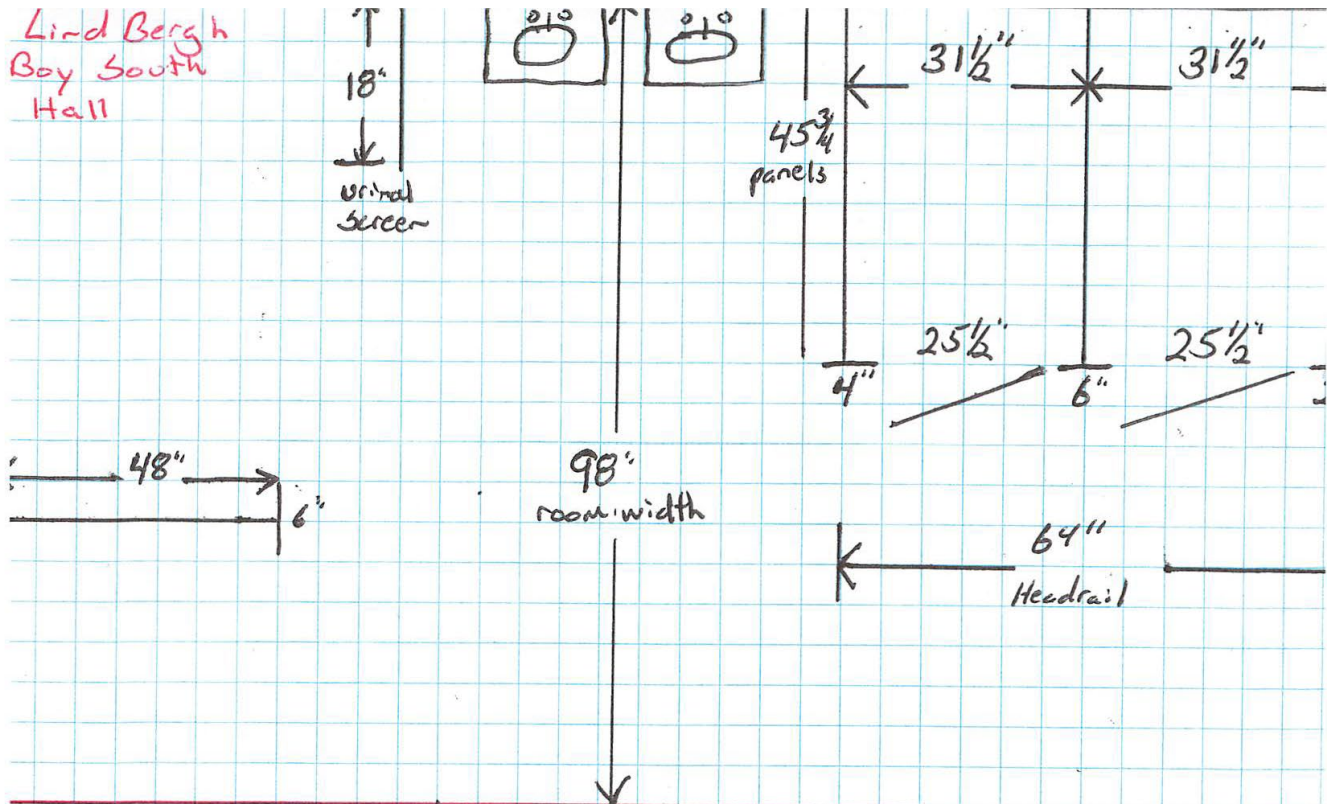

Lindbergh
Girls South
Hall

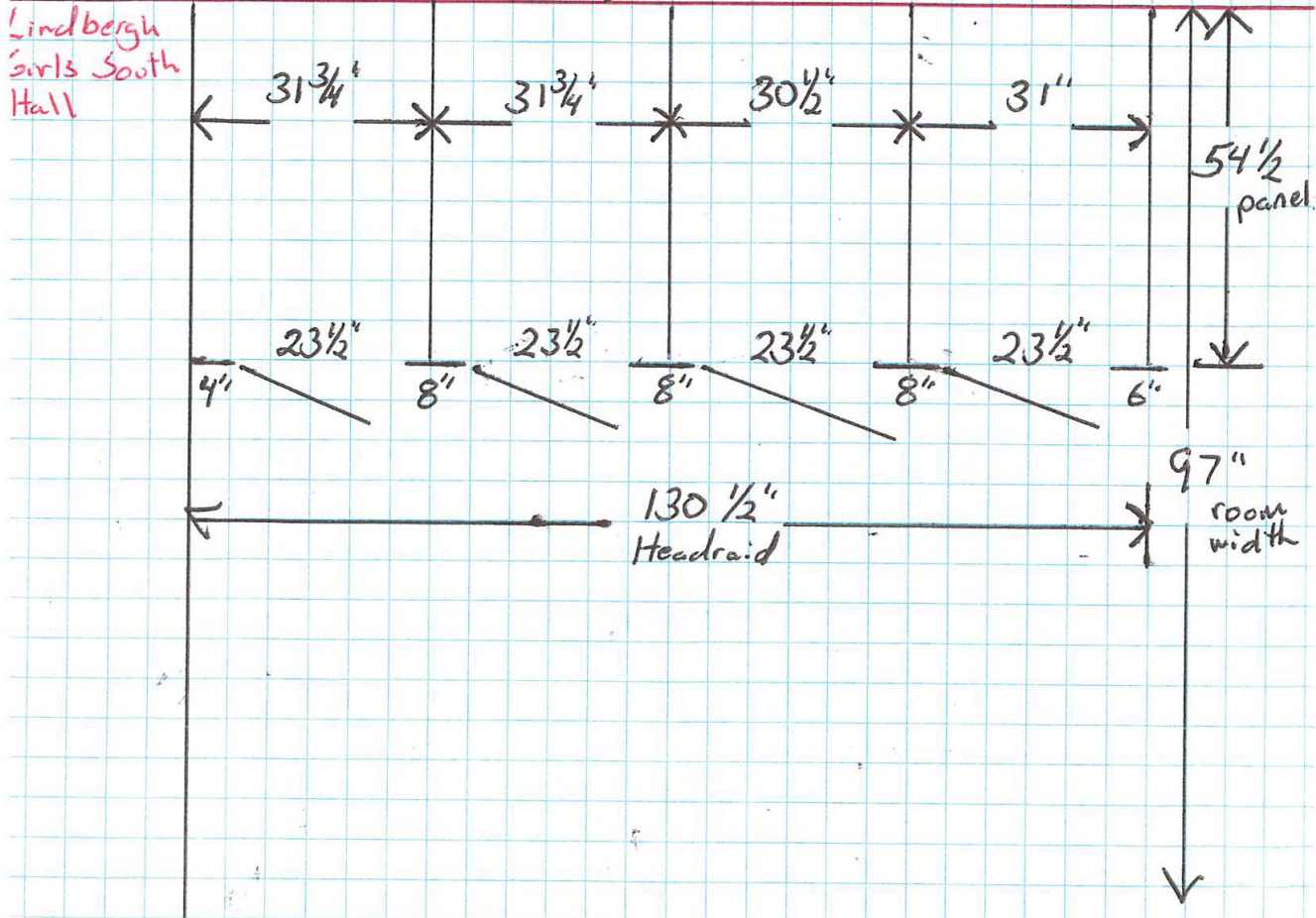

Lindbergh
Boys East Hall

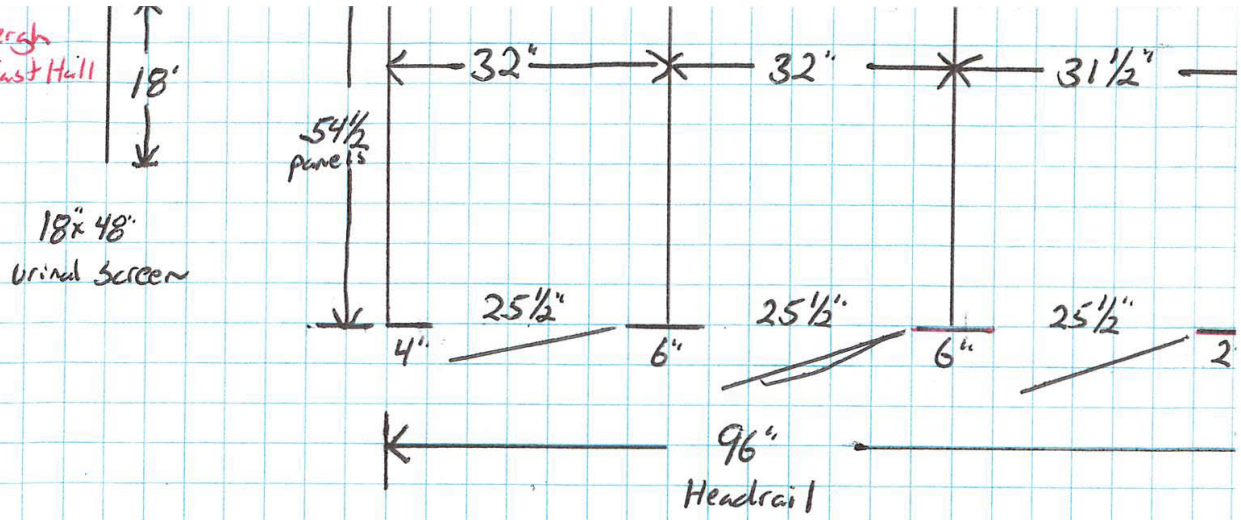

Lindbergh
girls east
Hall

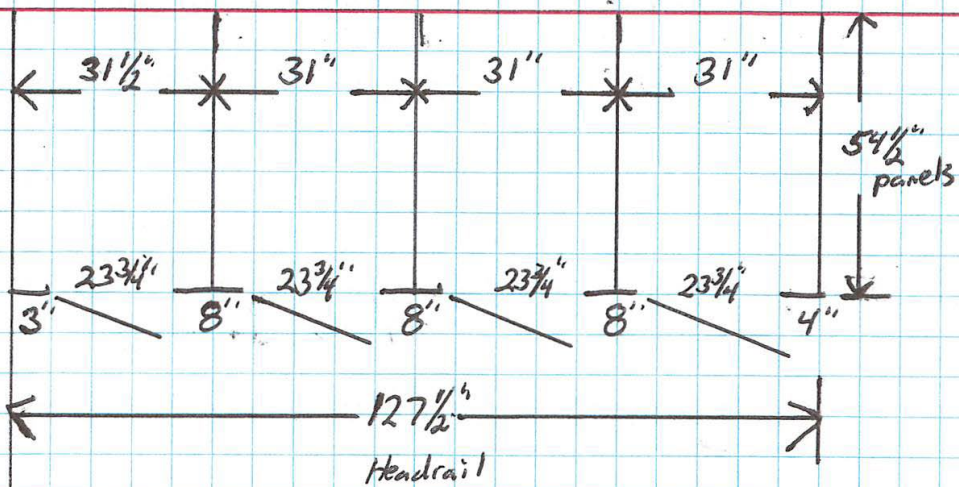

M.E. Pearson

310 N 11th St

Kansas City, KS 66102

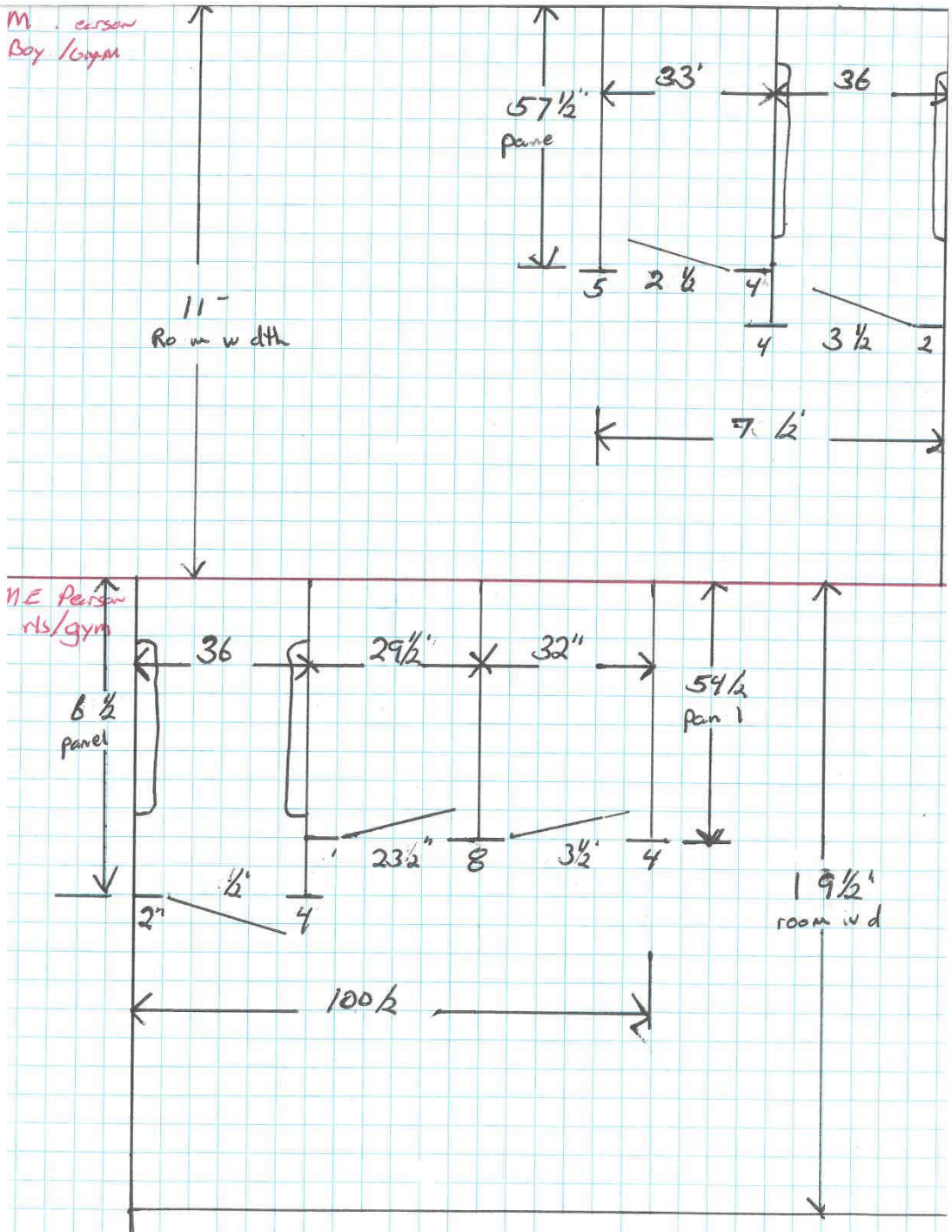

Morse Elementary School

912 S Baltimore St
Kansas City, KS 66105

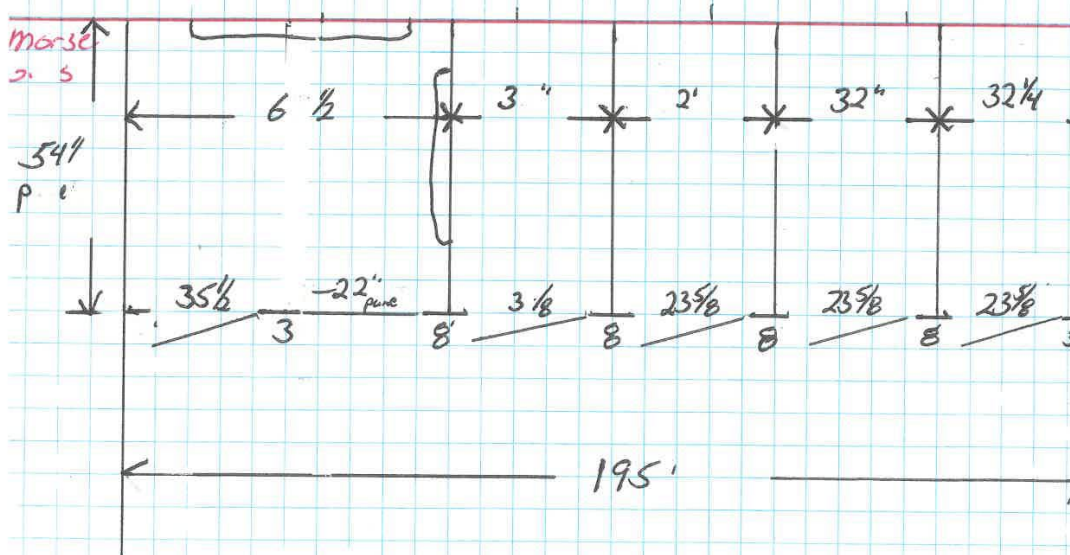
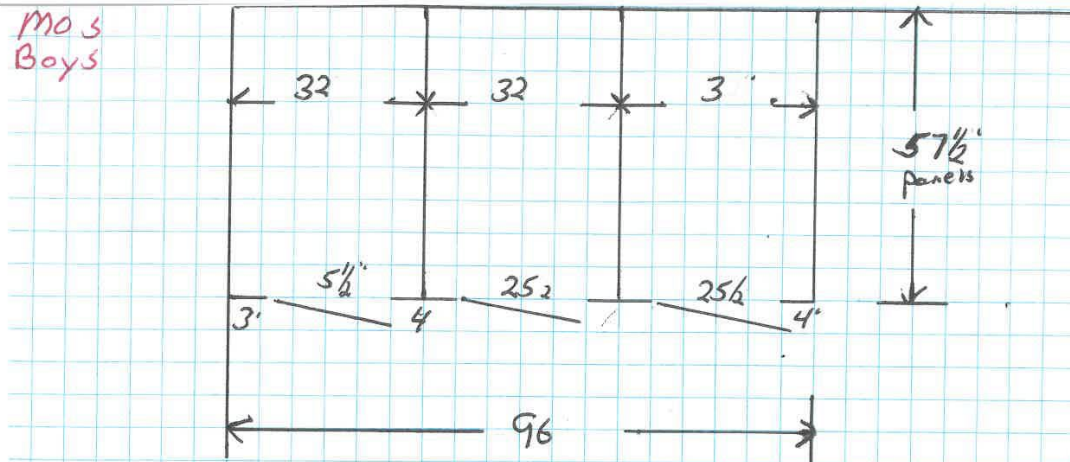

Quindaro Elementary School

2800 Farrow Avenue
Kansas City, KS 66104

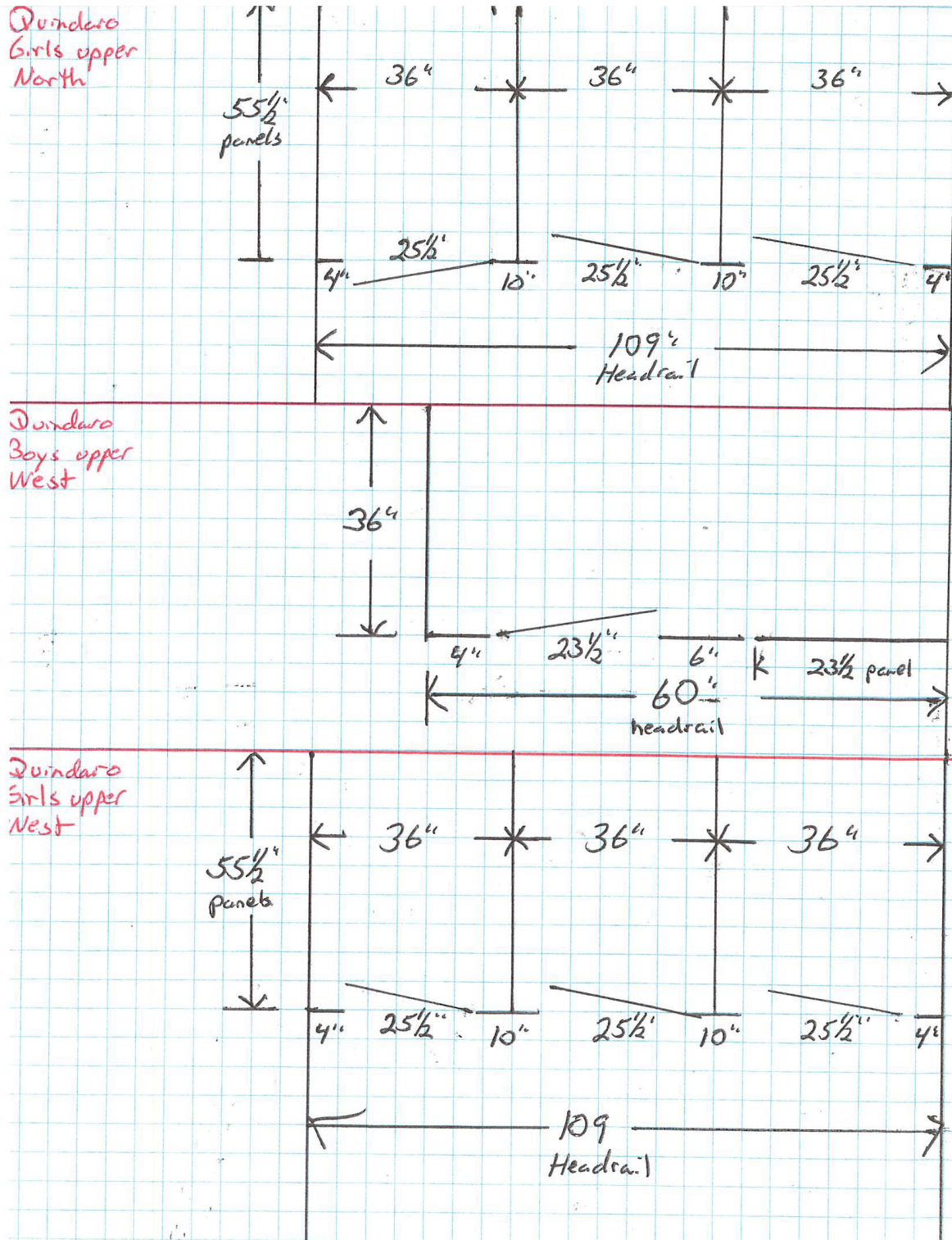

Duindaro
Womens staff
upper

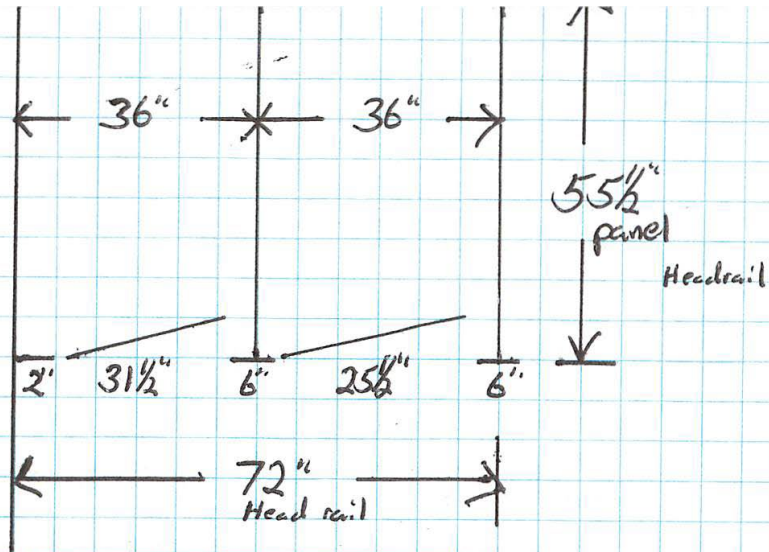

Duindaro
Girls upper
East

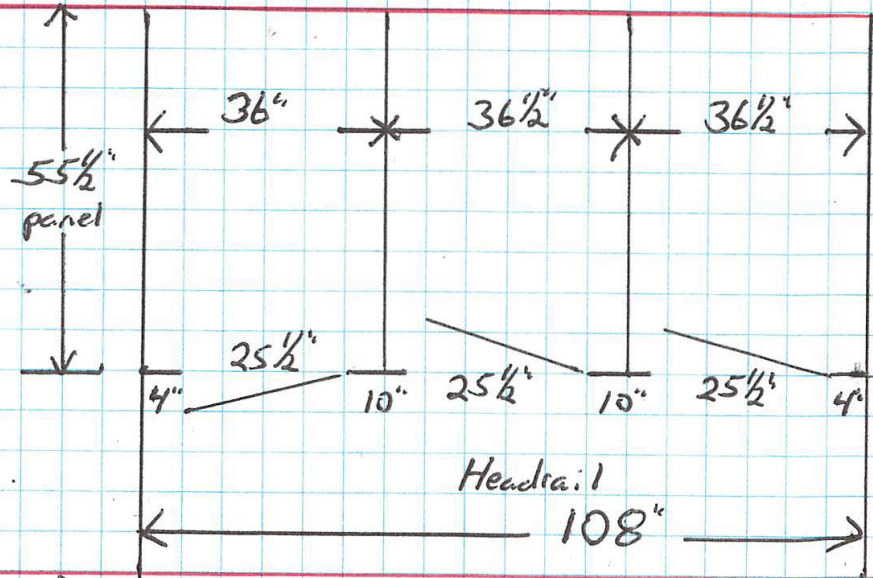

Duindaro
Boys upper
North

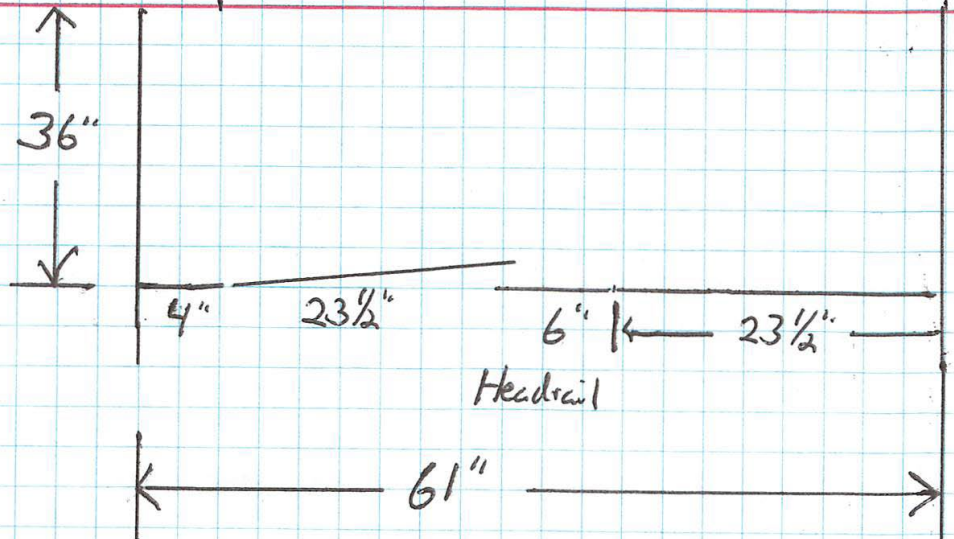

Quindaro
Girls lower
North

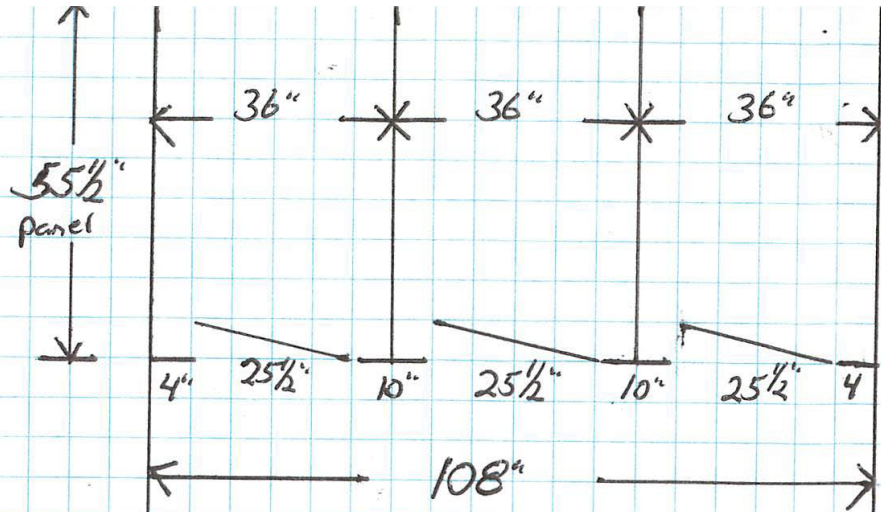

Quindaro
Girls lower
West

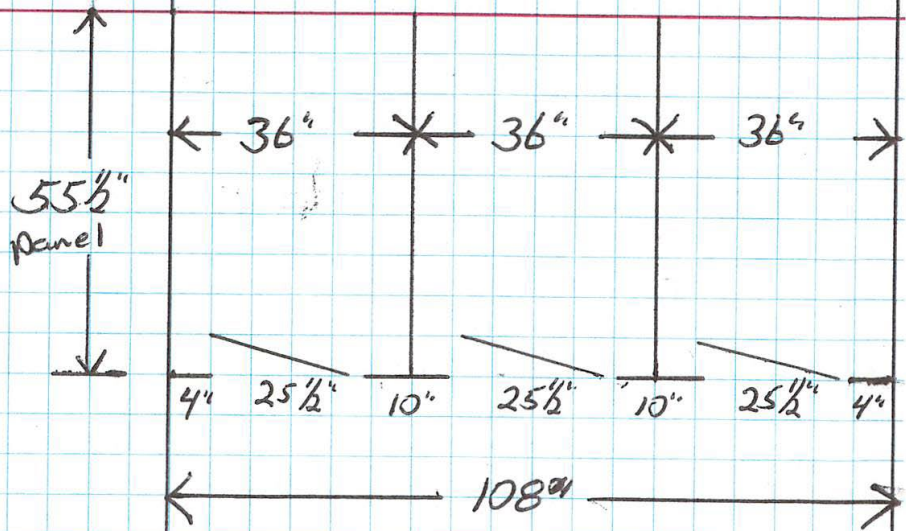

Quindaro
Men's Staff
upper

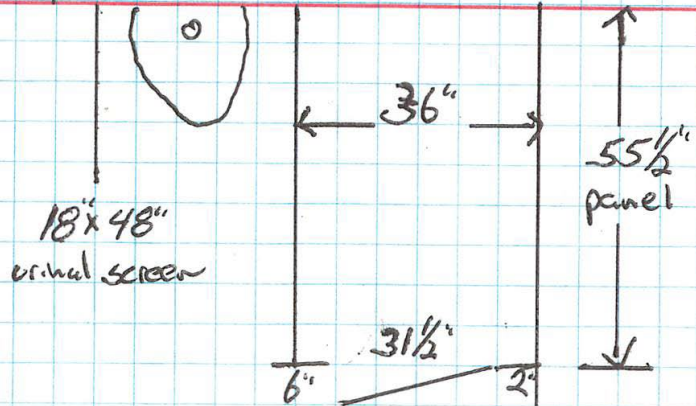

Quindaro
Mens staff
lower

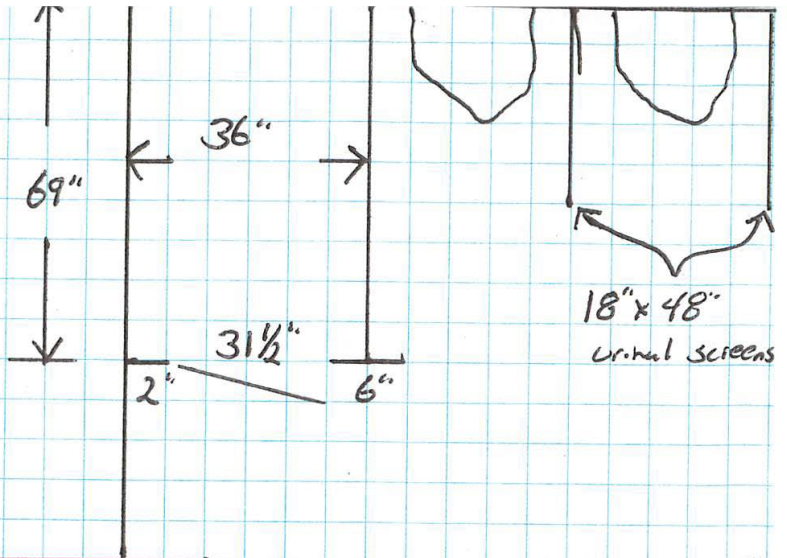

Quindaro
Women staff
lower

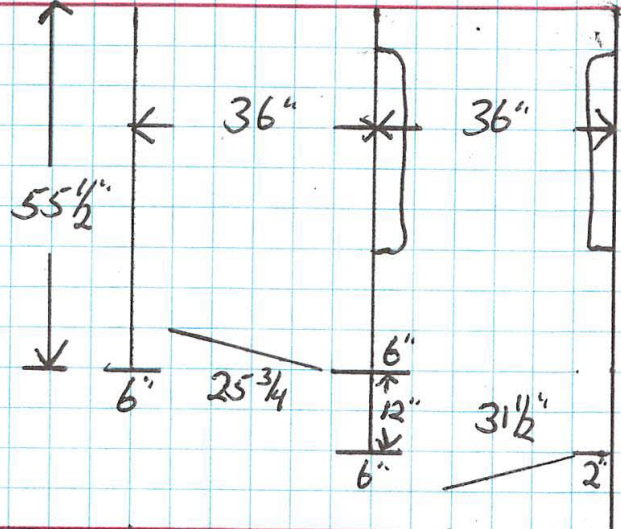

Girls East
Lower

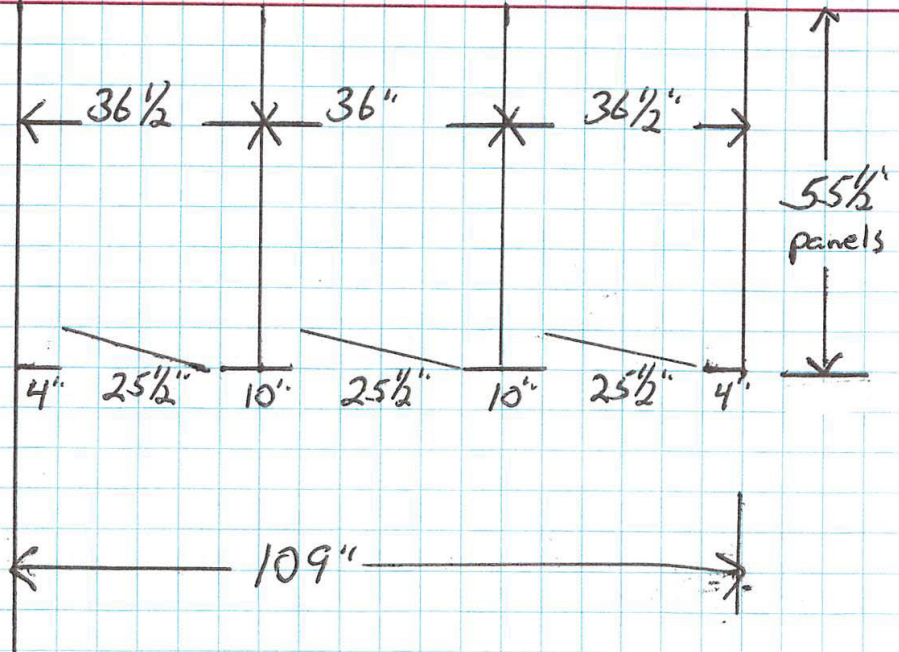

Stony Point South Elementary

158 S 78th Street
Kansas City, KS 66111

North Central Office

2220 N. 59th Street
Kansas City, KS 66104

Stony Point South
Girls Rm 16

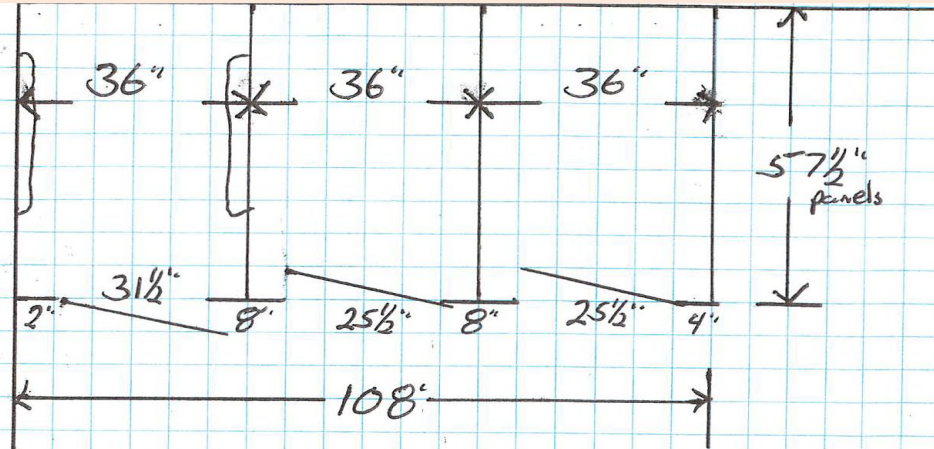

NCO B
MENS by
Fitness Center

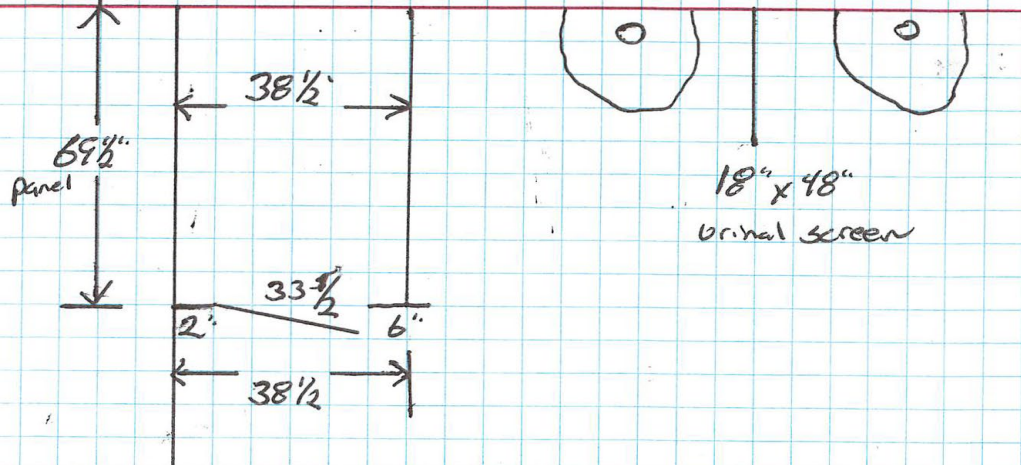

NCO B
WOMENS by
Fitness Center

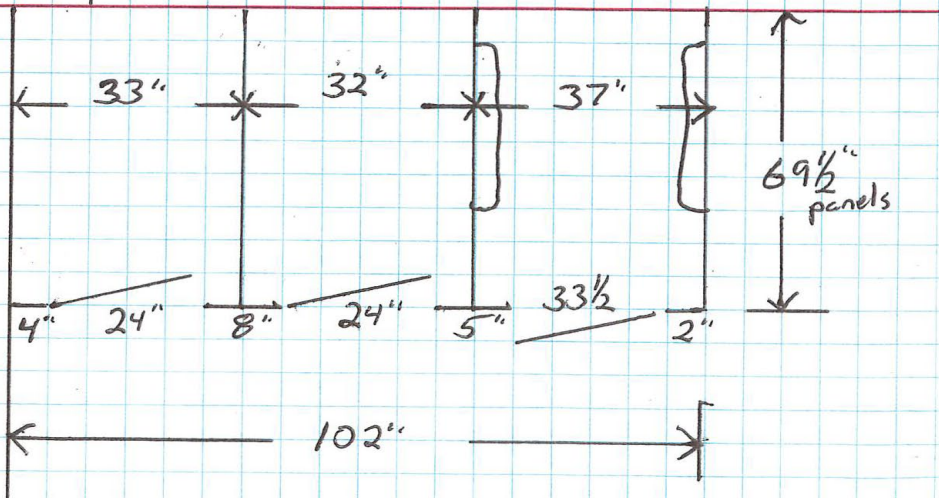

Stony Point South
Womens by Office

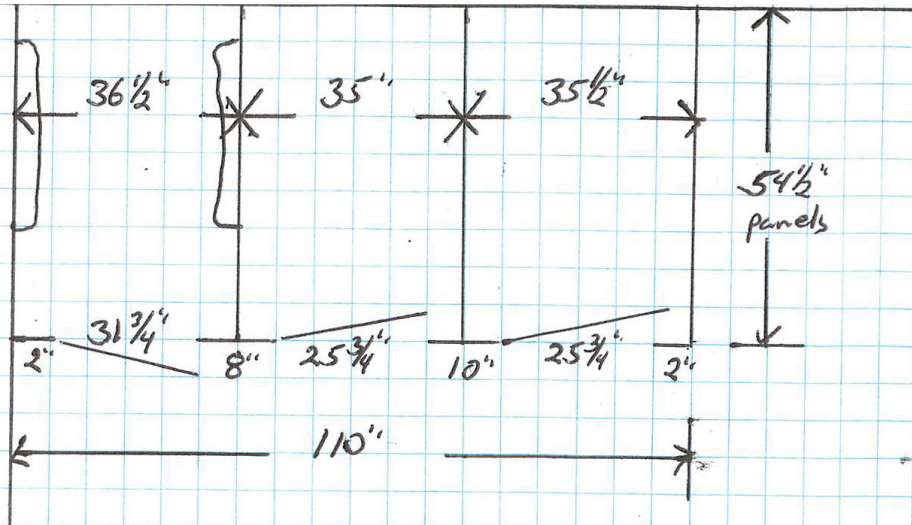

Stony Point South
Girls North Hall
Kindergarten

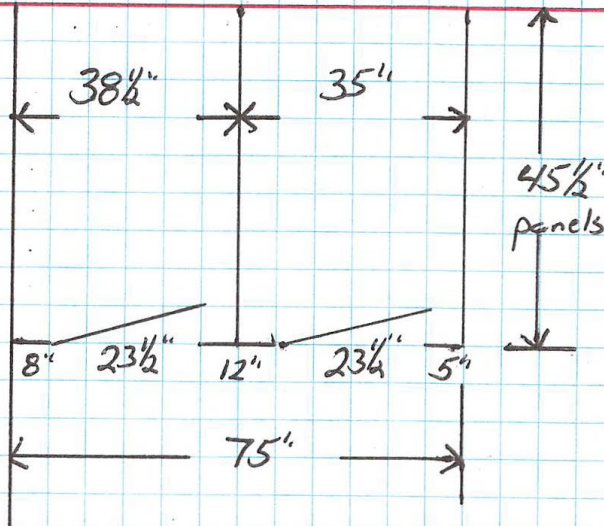

Stony Point South
Girls Rm 9

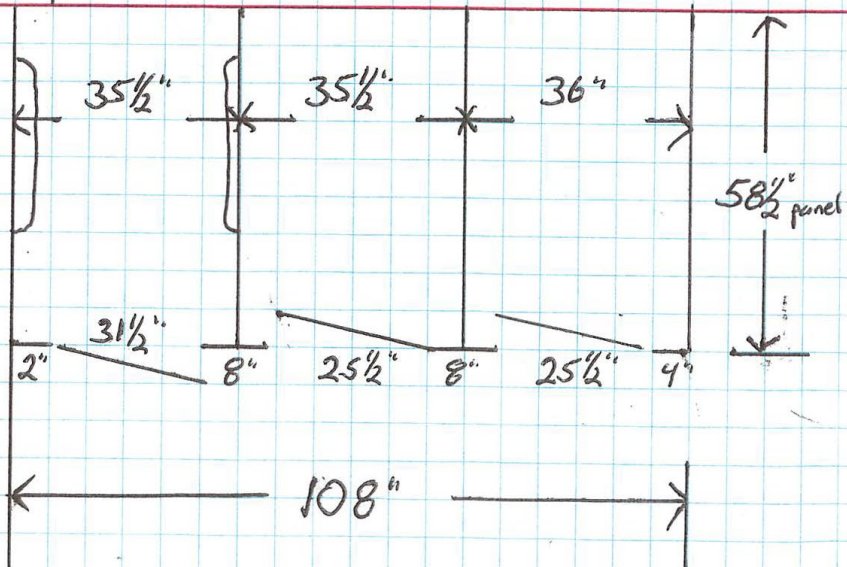

Stony Point South
Girls Rm 313

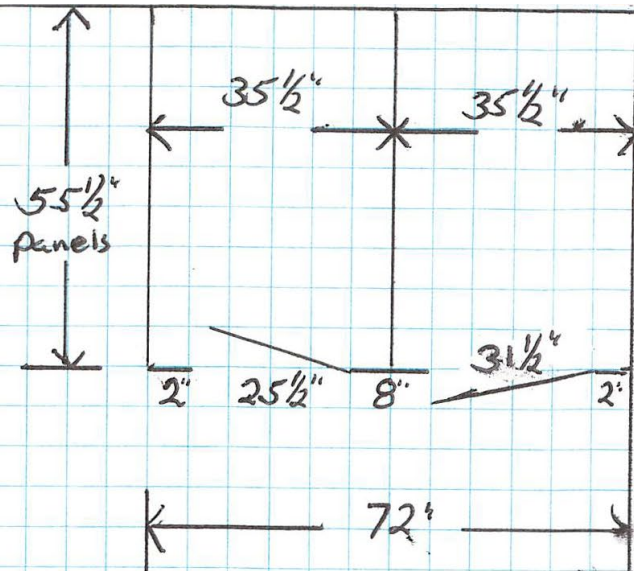

Stony Point South
Girls Rm 30

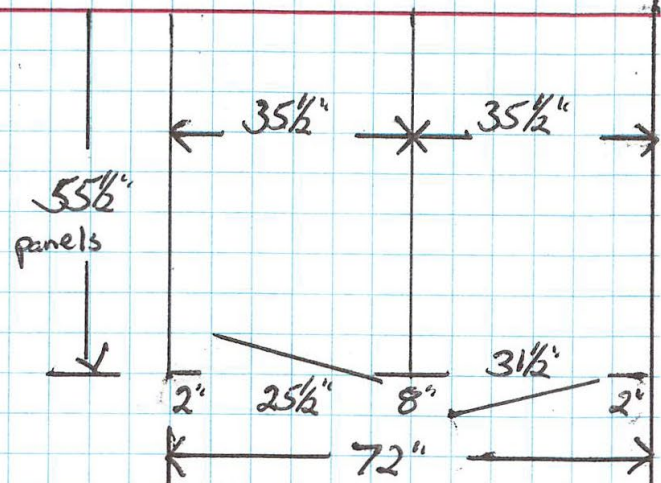

Stony Point South
Mens by Office

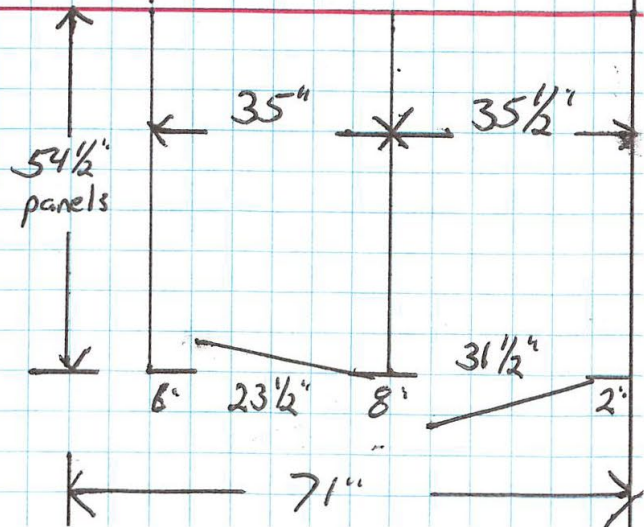

Stoney Point South
Girls West End

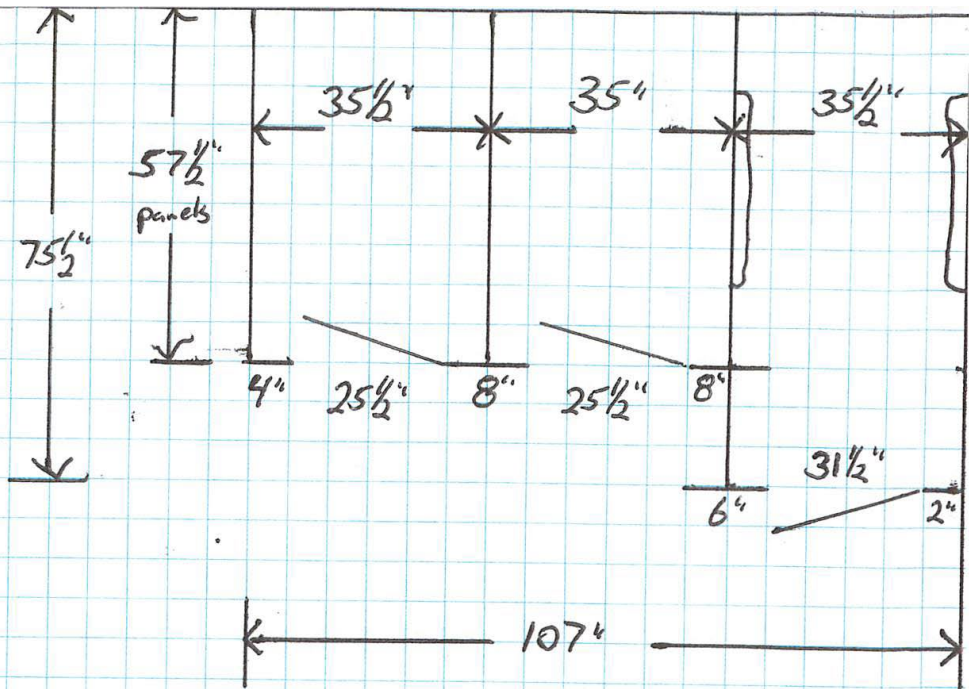

Stoney Point South
Boys West End

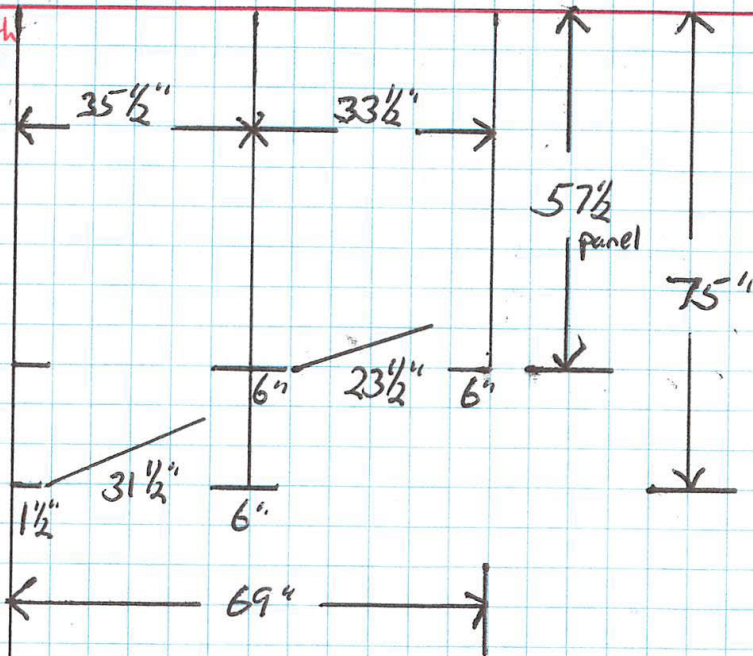

T.A. Edison

1000 Locust St

Kansas City, KS 66103

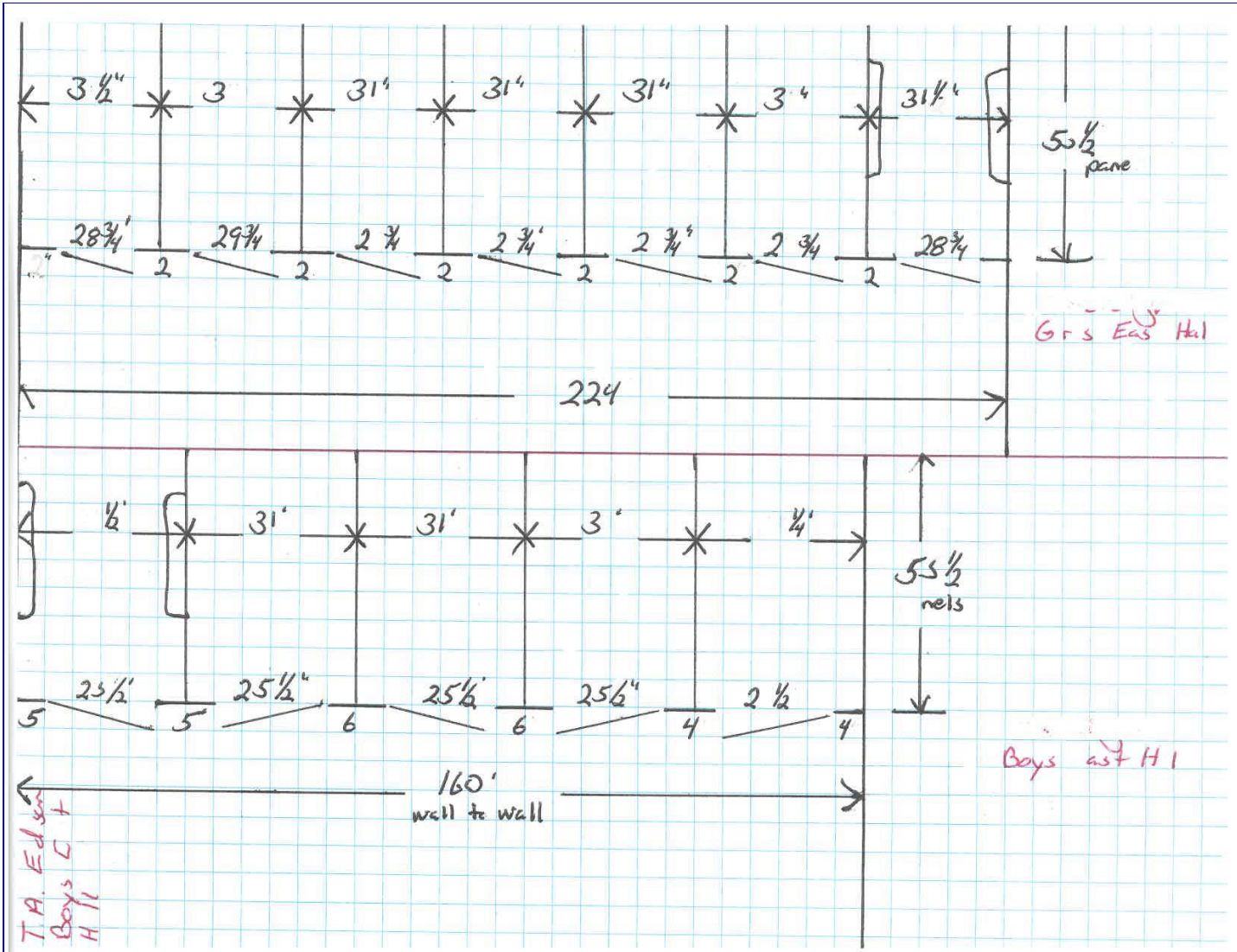

Stoney Point North

8200 Elizabeth Avenue

Kansas City, KS 66112

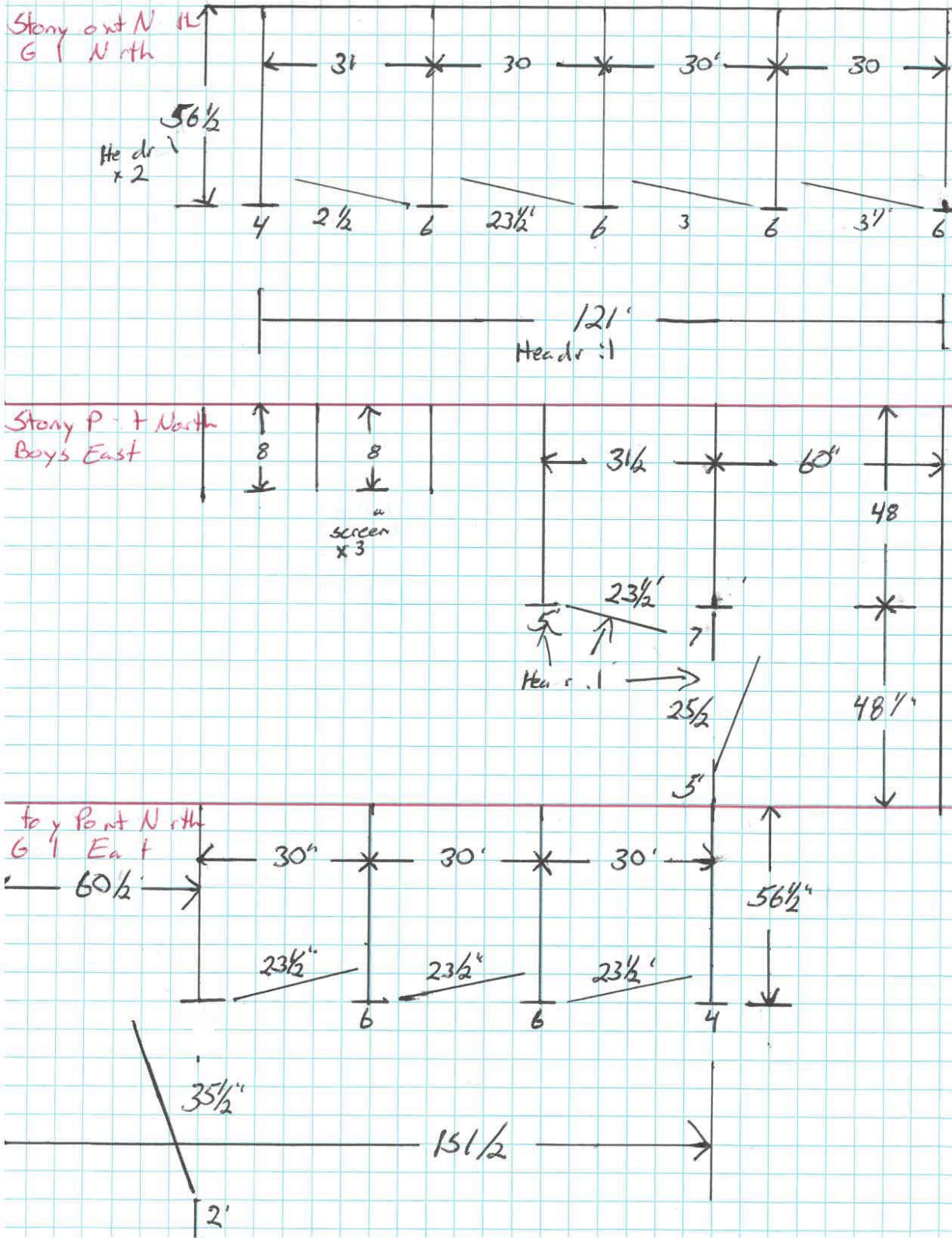

St y Point North
Boys West

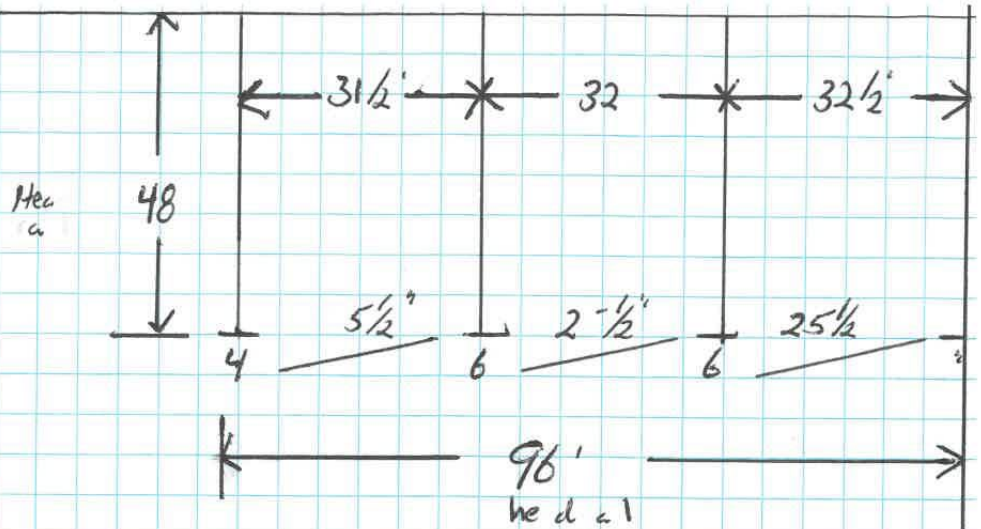

St y Point North
Boys West

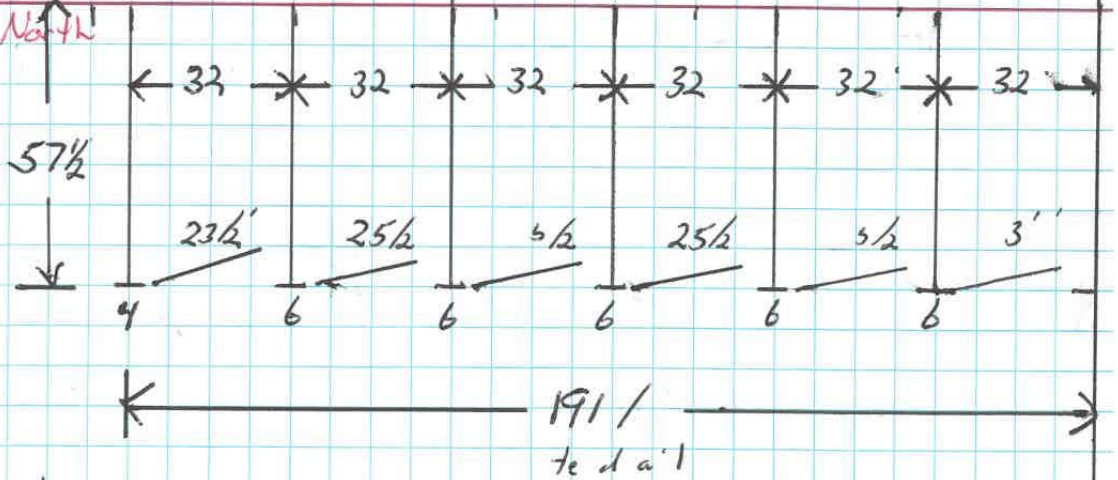

St y Point North
Boys North

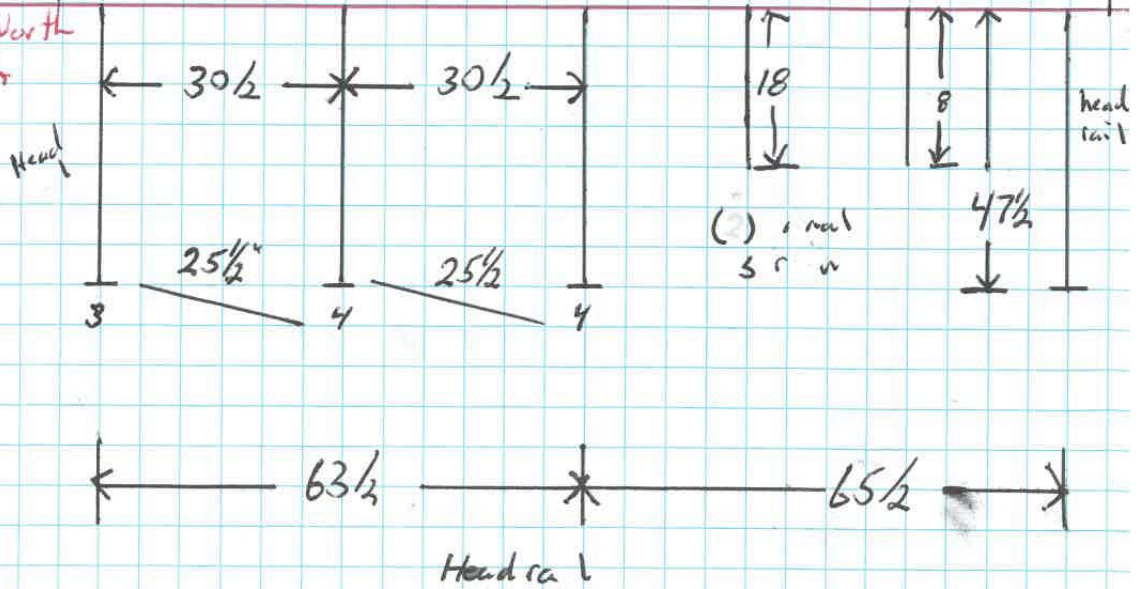

ATTACHMENT A – BID FORM

Central Middle School	
Materials	\$
Labor	\$
Total	
Days to complete Work	
	Days

Lindbergh Elementary	
Materials	\$
Labor	\$
Total	
Days to complete Work	
	Days

M.E Pearson Elementary	
Materials	\$
Labor	\$
Total	
Days to complete Work	
	Days

Morse Early Childhood Center	
Materials	\$
Labor	\$
Total	
Days to complete Work	
	Days

Quindaro Elementary	
Materials	\$
Labor	\$
Total	
Days to complete Work	
	Days

Stony Point South Elementary	
Materials	\$
Labor	\$
Total	
Days to complete Work	
	Days

North Central Office	
Materials	\$
Labor	\$
Total	
Days to complete Work	
	Days

T.A. Edison Elementary	
Materials	\$
Labor	\$
Total	
Days to complete Work	
	Days

Stony Point North Elementary	
Materials	\$
Labor	\$
Total	
Days to complete Work	
	Days

Delivery	
Lead Time ARO From the date of receipt of order, what is the estimated lead time to delivery?	Days

Designations		Certified Designation
MBE/WBE/Other Certification Is your firm certified MBE/WBE or Other? (Circle One)>>	Yes / No	

WE HEREBY AGREE TO FURNISH THE ITEMS ON WHICH PRICES ARE QUOTED ABOVE IN ACCORDANCE WITH ALL TERMS AND CONDITIONS PREVIOUSLY LISTED AND ANY ATTACHED SPECIFICATIONS.

BY: _____ DATE _____
 TITLE: _____ FIRM: _____
 PHONE: _____ EMAIL: _____

ATTACHMENT B – USD 500 STANDARD TERMS AND CONDITIONS

1. SCOPE: The following terms and conditions shall prevail unless otherwise modified by U.S.D. 500 within this bid document. U.S.D. 500 reserves the right to reject any bid which takes exception to these terms and conditions.
2. DEFINITIONS AS USED HEREIN:
 - a. The term "bid request" means a solicitation of a formal sealed bid.
 - b. The term "bid" means the price offered by the bidder.
 - c. The term "bidder" means the offeror or Contractor.
 - d. The term "U.S.D. 500" means Unified School District No. 500.
 - e. The term "Board of Education" or "BOE" means the governing body of Unified School District No.500
3. COMPLETING BID: Bids must be submitted ONLY on the form provided in this bid document. All information must be legible. Any and all corrections and /or erasures must be initialed. Each bid sheet must be signed by the authorized bidder and required information must be provided.
4. CONFIDENTIALITY OF BID INFORMATION: Each bid must be sealed and submitted in or under cover of the enclosed envelope to provide confidentiality of the bid information prior to the bid opening. Supporting documents and/or descriptive literature may be submitted with the bid or in a separate envelope marked "Literature for Bid (Number)." Do NOT indicate bid prices on literature. All bids and supporting bid documents become public information after the bid opening and are available for inspection by the general public in accordance with the Kansas Open Records Act.
5. ACCURACY OF BID: Each bid is publicly opened and is made part of the public record of U.S.D. 500. Therefore, it is necessary that any and all information presented is accurate and/or will be that by which the bidder will complete the contract. If there is a discrepancy between the unit price and extended total, the unit price will prevail.
6. SUBMISSION OF BID: Bids are to be sealed and submitted to the Purchasing Department Office, 2010 North 59th Street, Room 370, Kansas City, Kansas, 66104, prior to the date and time indicated on the cover sheet.
7. ADDENDA: All changes in connection with this bid will be issued by the Purchasing Office in the form of a written addendum. Signed acknowledgement of receipt of each addendum must be submitted with the bid.
8. LATE BIDS AND MODIFICATION OR WITHDRAWALS: Bids received after the deadline designated in this bid document shall not be considered and shall be returned unopened.
9. BIDS BINDING: All bids submitted shall be binding upon the bidder if accepted by U.S.D. 500 within sixty (60) calendar days after the bid opening.
10. EQUIVALENT BIDS: When brand or trade names are used in the bid invitation, it is for the purpose of item identification and to establish standards for quality, style and features. Bids on equivalent items of substantially the same quality, style and features are invited unless items are marked "No Substitute." Equivalent bids must be accompanied by descriptive literature and/ or samples may be required and shall be supplied at no charge to the school district.
11. NEW MATERIALS, SUPPLIES AND EQUIPMENT: Unless otherwise specified, all materials, supplies or equipment offered by a bidder shall be new, unused, of recent manufacture, first class in every respect, and suitable for their intended purpose. All equipment shall be assembled and fully serviced, ready for operation when delivered.
12. WARRANTY: Supplies or services furnished as a result of this bid shall be covered by the most favorable commercial warranties, expressed or implied, that the bidder and/or manufacturer gives to any customer. The rights and remedies provided herein are in addition to and do not limit any rights afforded to U.S.D. 500 by any other clause of this bid reserves the right to request from bidders a separate manufacturer certification of all statements made in the Proposal.
13. METHOD OF AWARD AND NOTIFICATION: Bids will be analyzed and the award made to the lowest and best, responsive and responsible bidder(s) whose bid conforms to the specifications and whose bid is considered to be the best value in the opinion of U.S.D. 500.
14. U.S.D. 500 reserves the right to reject any or all bids and any part of a bid: to waive informalities, technical defects, and minor irregularities in bids received: and to award the bid on an item by item basis by specified groups of items or to consider bids submitted on an "all or nothing "basis if the bid is clearly designed as such or when it is determined to be in the best interest of U.S.D. 500.
15. The signed bid shall be considered an offer on the part of the bidder: such offer shall be deemed accepted upon the issuance by U.S.D. 500 of a Purchase Order or other contractual document.
16. DELIVERY TERMS: All deliveries shall be F.O.B. Destination and all freight charges shall be included in the bid price.
17. DAMAGED AND/OR LATE SHIPMENTS: U.S.D 500 has no obligation to accept damaged shipments and reserves the right to return at the Contractor's expense damaged merchandise even though the damage was not apparent or discovered until after receipt of the items. The Contractor is responsible to notify U.S.D. 500 Purchasing Office of any late or delayed shipments. U.S.D. 500 reserves the right to cancel all or any part of an order if the shipment is not made as promised.
18. CREDIT TERMS: Bidder shall indicate all discounts for full and/or prompt payment. Discounts shall be considered as a cost factor in the determination of award, except discounts offered for payment within less than ten (10) calendar days. Discounts offered shall be computed from date of receipt of correct invoice or receipt and acceptance of products, whichever is later.
19. SELLER'S INVOICE: Invoices shall be prepared and submitted in duplicate to address shown on the Purchase Order. Invoices shall contain the following information: Purchase Order number, contract number, item number, description of supplies or services, sizes, unit of measure, quantity, unit price and extended totals.
20. TAX EXEMPT: U.S.D. 500 is exempt from Federal, State and local taxes by KS-FZLEKBLQ. Sites of all transactions under the order(s) that shall be derived from this bid request shall be deemed to have been accomplished within the State of Kansas.

- 21. SAFETY: All practices, materials, supplies and equipment shall comply with the federal Occupational Safety and Health Act, as well as any pertinent Federal, State and/or local safety or environmental codes.
- 22. DISCLAIMER OR LIABILITY: U.S.D. 500 will not hold harmless or indemnify any bidder for any liability whatsoever.
- 23. TERMINATION RIGHTS: KCKPS shall have the right to terminate/cancel the Agreement for its convenience and without penalty upon thirty (30) days prior written notice to the Contractor.
- 24. HOLD HARMLESS: The Contractor agrees to protect, defend, indemnify and hold the Board of Education, its officers, employees and agents fee and harmless from and against any and all losses, penalties, damages, settlements, costs, charges, professional fees or other expenses or liabilities of every kind and character arising out of or relating to any and all claims, liens, demands, obligations, actions, proceedings or causes of action of every kind and character in connection with or arising directly or indirectly out of this agreement and/or the performance hereof. Without limiting the generality of the foregoing, any and all such claims, etc., relating to personal injury, infringement of any patent trademark, copyright (or application for any thereof) or of any other tangible or intangible personal or property right, or actual or alleged violation of any applicable statute, ordinance, administrative order, rule or regulation, or decree of any court, shall be included in the indemnity hereunder. The Contractor further agrees to investigate, handle, respond to, provide defense for and defend any such claims, etc., at his/her sole expense and agrees to bear all other costs and expenses related thereto, even if such claim is groundless, false or fraudulent.

NO MUTUAL INDEMNIFICATION:

K.S.A.72-8201a: Contracts; indemnification or hold harmless provisions, void.

(a) It is the public policy of the state of Kansas that all contracts entered into by the board of education of a school district, or any officers or employees thereof acting on behalf of the board, provide that the school district and board of education shall be responsible solely for the district's or board's actions or failure to act under a contract.

(b) The board of education of a school district or any officers or employees thereof acting on behalf of the board shall not have the authority to enter into a contract under which the school district or board agrees to, or is required to, indemnify or hold harmless against damages, injury or death resulting from the actions or failure to act on the part of any party to a contract other than the board or district.

(c) The provisions of any contract entered into in violation of this section shall be contrary to the public policy of the state of Kansas and shall be void and unenforceable.

- 25. INSURANCE: Upon receipt of award, Contractor shall provide Certificate of Insurance as required within three (3) days after notification issued by the Purchasing Department.

A. The following general insurance requirements apply to any and all work under this contract by all Contractors and subcontractors of any tier.

- (1) Any and all insurance required by this contract with each and any and all insurance required by this contract shall be maintained during the entire length of this contract, including any extensions thereto, and until all work has been completed to the satisfaction of the Kansas City Kansas Public Schools. Any and all insurance must be on an occurrence basis.
- (2) No Contractor or subcontractor shall commence work under a contract until all insurance requirements contained within the solicitation have been complied with and until evidence of all insurance requirements in each and every contract with each and every subcontractor of any tier and shall require the same to comply with all such requirements.
- (3) The Kansas City Kansas Public Schools shall be covered as an Additional Insured under any and all insurance required by this contract. Confirmation of this shall appear on all certificates of insurance and on any and all applicable policies. The title of the awarded contract shall also appear on any and all applicable policies.
- (4) The Kansas City Kansas Public Schools shall be given no less than thirty (30) days' written notice of cancellation. The Kansas City Kansas Public Schools shall be given not less than thirty (30) days' prior written notice of material changes of any insurance required under this contract. The Kansas City Kansas Public Schools shall be given written notice of renewal of coverage not less than thirty (30) days prior to the expiration of any particular policy.
- (5) Each and every agent shall warrant when signing the certificate of insurance that he is acting as an authorized representative on behalf of the companies affording insurance coverage under the contract and that he is licensed by the State of Kansas to conduct insurance business in the State of Kansas and that the companies affording insurance coverage are currently licensed by the State of Kansas and are currently in good standing with the Commissioner of Insurance for the State of Kansas.
- (6) Any and all companies providing insurance required by this contract shall meet the minimum financial security requirements as set forth below. The rating for each company must be indicated on the certificate of insurance.

For all contracts, regardless of risk, companies providing insurance under this contract must have a current:

- (a) Best's Rating not less than A, and
- (b) Best's Financial Size Category not less than Class VII

- (7) In the event the Contractor neglects, refuses, or fails to provide insurance required by the contract documents, or if such insurance is canceled for any reason, Kansas City Kansas Public Schools shall have the right, but not the duty, to procure the same, and the cost thereof shall be deducted from monies then due or thereafter to become due to the Contractor or Kansas City Kansas Public Schools shall have the right to cancel the contract.

B. Worker's Compensation and Employer's Liability Insurance

The Contractor shall procure and maintain Worker's Compensation and Employer's Liability Insurance in the following limits. Such insurance is to cover each and every employee who is or may be engaged in work under this contract.

Worker's Compensation.....Statutory

Employer's Liability

Bodily Injury by Accident	\$1,000,000 each accident
Bodily Injury by Disease	\$1,000,000 each employee
Bodily Injury by Disease	\$1,000,000 policy limit

C. Comprehensive General Liability Insurance

The Contractor shall procure and maintain Comprehensive Insurance in an amount not less than \$1,000,000 for bodily injury and property damage combined single limit. The following specific extensions of coverage shall be provided and indicated on the certificate of insurance:

- (1) Comprehensive Form
- (2) Contractual Insurance
- (3) Personal Injury
- (4) Broad Form Property Damage
- (5) Premises – Operations
- (6) Completed Operations

This coverage shall cover the use of all equipment, hoists, and vehicles on the site(s) not covered by Automobile Liability under this contract. Policy coverage must be on an occurrence basis.

D. Automobile Liability Insurance

The Contractor shall procure and maintain Automobile Liability Insurance in an amount not less than \$1,000,000 for bodily injury and property damage combined single limit. The following extensions of coverage shall be provided and indicated on the certificate of insurance.

- (1) Comprehensive Form
- (2) Owned, Hired, Leased and non-owned vehicles

If the Contractor does not own any vehicles in the corporate name, non-owned vehicles coverage shall apply and must be endorsed on either the Contractor's personal automobile policy or the Comprehensive General Liability coverage required under this contract.

E. Commercial Crime insurance (when applicable)

The Contractor shall procure and maintain Commercial Crime/Fidelity insurance in an amount not less than \$1,000,000.00, including coverage for theft or loss of KCKPS property.

- 26. LAW GOVERNING: All contractual agreements shall be subject to, governed by, and construed according to the laws of the State of Kansas.
- 27. ANTI-DISCRIMINATION CLAUSE: No bidder on this request shall in any way, directly or indirectly, discriminate against any person because of age, race, color handicap, sex, national origin, or religious creed.
- 28. BID BOND/PERFORMANCE BOND (Applicable to Construction/Remodel/Repair Projects, Unless Waived by the District)
 - A. Each proposal must be accompanied by a certified or cashier's check, or a bid bond in the amount of five percent (5%) of the Contractor's total bid.
 - B. A Performance Bond and a Material and Labor Payment Bond in amounts equal to one hundred percent (100%) of the contract price shall be furnished by the successful bidder. Bonds shall be issued by a surety acceptable to the Board.
- 29. DISQUALIFICATION:
 - A. The Director of Purchasing may, at her/his sole discretion, disqualify a bidder for one or any combination of the following reasons:
 - 1. Bidder's product does not meet the specifications or bid conditions of the solicitation;
 - 2. Bidder's tendered bid is not received on the District's bid form;
 - 3. Bidder's tendered bid is not signed;
 - 4. Required bid bond is not furnished at time of bid opening;
 - 5. Failure to comply with bid instructions, terms and conditions that are judged to be essential to the competitive process and in the best interests of the District.
 - B. Disqualification of bidders on future bids may be considered for any one or combination of the following reasons:
 - 1. Refusal of the bidder to complete a contract or bid;
 - 2. Bidder's past history of late deliveries or partial/incomplete shipments,
 - 3. Bidder's products or services have proven unreliable, unworkable or have not accomplished the result requested in the District's specifications.
- 30. SUPPLIER DIVERSITY: The Kansas City Kansas Public Schools encourages supplier diversity and participation of MBE/WBE/DBE designated businesses. However, such participation will not result in any selection or scoring advantage in the bid evaluation process.
- 31. **INCLEMENT WEATHER / EMERGENCY:**
IF THERE IS A SCHOOL CLOSING THE DAY OF A SCHEDULED BID OPENING DUE TO INCLEMENT WEATHER OR AN EMERGENCY, THE BID OPENING WILL OCCUR AT 2:00 PM (CENTRAL) THE NEXT BUSINESS DAY THAT THE DISTRICT IS OPEN.