

Forest Hills, Tennessee

Construction Specifications and Contract Documents

PW 2021-04

Tara Drive Speed Humps

**September 2021
(Fiscal Year 2021-2022)**

Prepared By:
Neel-Schaffer, Inc.
210 25th Avenue North, Suite 800
Nashville, TN 37215

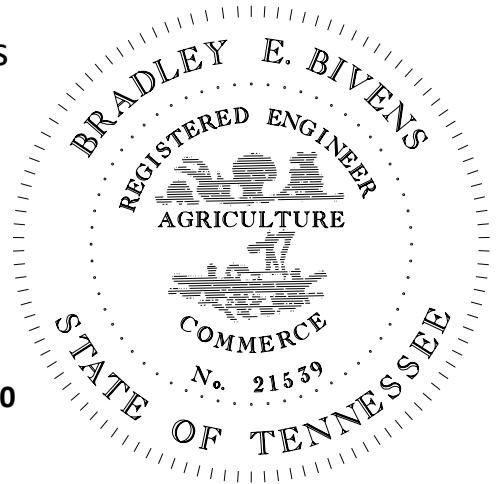

Forest Hills City Government

Mayor Lanson J. Hyde III,
Henry Trost, Vice Mayor
James C. Gardner, Commissioner
Mark Hill, Interim City Manager

CONTENTS

CONTRACT DOCUMENTS

<u>TITLE</u>	<u>PAGE</u>
INVITATION TO BID	3
INSTRUCTIONS TO BIDDERS	4
MINIMUM GENERAL BID CONDITIONS	7
PROPOSAL	9
DRUG-FREE WORKPLACE AFFIDAVIT	11
IRAN DIVESTMENT ACT AFFIDAVIT	12
BIDDER QUALIFICATIONS & REFERENCES	13
PERFORMANCE-PAYMENT BOND	15
DESCRIPTION OF WORK	16
PROPOSAL BID TABULATION FORM	18
CONTRACT	21
SPECIAL CONDITIONS	29
GENERAL CONDITIONS	31
TECHNICAL SPECIFICATIONS	47
TDOT	
Erosion Control	
DETAILED DRAWINGS	48
PW 2021-04 Tara Drive Speed Humps	

INVITATION TO BID

The City of Forest Hills will accept sealed bids for **PW 2021-04 Tara Drive Speed Humps**. This Invitation to Bid is subject to the instructions, conditions, specifications, addenda, and other elements, including those incorporated by reference.

ISSUE DATE: September 28, 2021
BID TITLE: **PW 2021-04 Tara Drive Speed Humps**
CONTACT: Brad Bivens, City Engineer of the City of Forest Hills
TELEPHONE: (615) 383-8420
E-MAIL ADDRESS: brad.bivens@neel-schaffer.com

BID OPENING: **Tuesday, October 12 at 2:00 P.M. CST**
LOCATION: City of Forest Hills, City Hall
6300 Hillsboro Pike, Nashville, TN 37215

Copies of this solicitation may be obtained from the City of Forest Hills Vendor Registry. You may register your business, and obtain the solicitation at the link below:

<https://vrapp.vendorregistry.com/Bids/View/BidsList?BuyerId=bb43feeb-0407-4794-836c-a1aa4278eac4>

Bids must be received by the City of Forest Hills Office on or before **Tuesday, October 12 at 2:00 P.M. CST** (bids received after that time will not be considered), at which time the bids will be publicly opened and read aloud.

SUBMIT BID via electronic submission using the City of Forest Hills Vendor Registry link.

Vendor Registry Link:

<https://vrapp.vendorregistry.com/Bids/View/BidsList?BuyerId=bb43feeb-0407-4794-836c-a1aa4278eac4>

All bids must be made on the forms included in this solicitation. All bids must be signed. Unsigned bid forms or bid proposals will not be considered. The City will not accept faxed, mailed, hand delivered, or emailed.

INSTRUCTIONS TO BIDDERS

The City of Forest Hills will accept bids for **PW 2021-04 Tara Drive Speed Humps**. Bids will be received via electronic submission by the City of Forest Hills Office on or before **Tuesday, October 12, 2021 at 2:00 P.M. CST**, at which time the bids will be publicly opened and read aloud. Bids received after that time will not be considered.

Bids must be received by the City of Forest Hills Office on or before **Tuesday, October 12 at 2:00 P.M. CST** (Bids received after that time will not be considered), at which time the bids will be publicly opened and read aloud.

SUBMIT BID via electronic submission using the City of Forest Hills Vendor Registry link.

Vendor Registry Link:

<https://vrapp.vendorregistry.com/Bids/View/BidsList?BuyerId=bb43feeb-0407-4794-836c-a1aa4278eac4>

All bids must be made on the forms included in this solicitation. All bids must be signed. Unsigned bid forms or bid proposals will not be considered. The City will not accept faxed, mailed, hand delivered, or emailed.

Bid submittals must be received and acknowledged by the City of Forest Hills on or before **Tuesday, October 12, 2021 at 2:00 P.M. CST**. Bids received after the closing time will not be accepted and will be returned to the bidder unopened.

All bidders must satisfy themselves by personal examination of the locations of the proposed work, by examination of the Specifications and requirements of the work and the accuracy of the estimate of the quantities of the work to be done, and shall not at any time after the submission of a bid dispute or complain of such estimate nor assert that there was any misunderstanding in regard to the nature or amount of work to be done. The City shall not be responsible for bidders' errors and misjudgments, nor any information on local conditions or general laws and regulations.

The Documents and Specifications contain the provisions required for the construction of the project. No information obtained from any officer, agent, or employee of the City on any such matters shall in any way affect the risk or obligation assumed by the Contractor or relieve Contractor from fulfilling any of the conditions of the contract.

A **Bid Bond** in a commercially standard form from a Surety Company acceptable to the City, payable to the City of Forest Hills with power of attorney must accompany each bid for ten (10) percent of the total amount of the Base Bid. As soon as the bid prices have been compared, the City will return the Bid Bond of all except the three lowest responsible bidders. When the contract is awarded, the bonds of the unsuccessful bidder(s) will be returned.

Proposals which are incomplete, unbalanced, conditional or obscure or which contain additions not called for, erasures, alterations or irregularities of any kind or which do not comply with the INFORMATION FOR BIDDERS may be rejected at the option of the City. The City reserves the right to reject any and all bids or to accept any bid. The City of Forest Hills may cancel this bid.

The City reserves the right to award the contract to multiple qualified bidders if the City determines that such awards are in the best interest of the City.

A bidder may withdraw any proposal he has submitted at any time prior to the hour set for the closing of the bids provided the request for withdrawal is signed in a manner identical with the proposal being withdrawn. No withdrawal or modification will be permitted for 30 days after the hour and date designated for opening the bids.

The included PROPOSAL BID TABULATION FORM lists the various divisions of construction contemplated in the Specifications, together with an estimate of the units of each. With these units as the basis, the bidder will extend each item, using the cost he inserts in the unit column. Any total cost found inconsistent with the unit cost when the bids are examined will be deemed in error and corrected to agree with the unit cost that shall be considered correct.

The Bidder agrees to maintain a cumulative total of quantities of work installed and work remaining to be performed and shall take all precautions as necessary to prevent installation of quantities with total values exceeding the contract price. The Bidder also agrees that under no circumstances will he be paid any sum in excess of the contract price without the execution of a contract change order.

Questions and Explanations

All questions or explanations requested by Bidders **shall be submitted in writing** to the City Manager in ample time to permit consideration before the bid date. Necessary replies will be issued to all bidders or record as Addenda and receipt thereof shall be acknowledged on the proposal. Bidders shall check with the City prior to bid opening to secure any Addenda that may affect bidding. Oral instructions will not be given and do not form a part of the Bidding Documents.

Project is a Unit Price Contract based on prices stated on PROPOSAL BID TABULATION FORM. Contractor will be paid based on quantities installed and measured based on these unit prices.

All bid proposals must include the following (complete and signed):

- 1. Proposal Signature Page**
- 2. Addendum Acknowledgement**
- 3. Drug Free Workplace Affidavit**
- 4. Iran Divestment Act Affidavit**
- 5. Bidder Qualifications and References**
- 6. Bid Bond**
- 7. Proposal Bid Tabulation Form**

Pursuant to Tennessee Code Annotated Title 62, Chapter 6, Part 1, it is necessary for bidders to provide evidence of compliance with the applicable provisions of Tennessee Code Annotated Title 62-6-119 before any bid can be considered.

The successful bidder must provide the following, each of which shall be in accordance with the contract documents:

1. Certificate of Insurance naming the City of Forest Hills additionally insured with any exclusions listed, including
 - General Liability
 - Worker's Comp
 - Auto Insurance
2. Proof of Worker's Comp for all Subcontractors
3. Bid Bond for 10% of the total Base Bid amount.
4. Performance-Payment Bond for 100% of the total Base Bid amount with Power of Attorney.
5. W-9 Form, if a new vendor

The successful bidder will also be responsible for the following:

1. Payment of all taxes levied under the laws of the State of Tennessee.
2. The successful bidder shall have the responsibility to ensure that all persons employed under a contract with the City, whether directly or by subcontract, be legal residents and be authorized to work in the United States.
3. Affirmative Action compliance is required.

MINIMUM GENERAL BID CONDITIONS

The following Minimum General Bid conditions have been developed and pertain to any and all purchases that may be made as a result of this bid request.

1. The City has the right to accept the lowest responsive and responsible bid.
2. **ACCEPTANCE AND REJECTION.** Each bid submitted by a contractor shall be considered an offer to perform services. The City reserves the right to reject any and all bids, to waive any informality in bids, and unless otherwise specified by the bidder, to accept any item in the bid.
3. **TIME OF ACCEPTANCE.** If a bidder fails to state a time within which a bid must be accepted, it is understood and agreed that the City shall have thirty days to accept.
4. **ERROR IN BID.** In cases of errors in the extension of prices in the bid, the unit price will govern. No bid shall be altered or amended after the specified time for opening bids. After bid opening, a vendor will be permitted to withdraw a bid only when there is obvious clerical error in the bid.
5. **DISCOUNT PERIOD.** Discounts will be taken as written on the invitation to bid.
6. **DEFAULT OF CONTRACTOR.** In case of default of the Contractor, the City may procure the articles of services from other services and hold the Contractor responsible for any excess cost occasioned thereby.
7. **SAMPLE OF MATERIALS.** Samples of items, when required, must be furnished free of expense and if not destroyed, will upon request be returned at the bidder's expense.
8. **SIGNATURE ON BIDS.** Each bid should give the full name and business address of the bidder. Unsigned bids will be rejected. The person signing the bid must show his title, and if requested by the City, must furnish satisfactory proof of his or her authority to bind his or her company in contract. Bids must be type written or in ink, otherwise they may not be considered. Purchase order will be issued to the firm name appearing on the bid.
9. **ALTERNATE BIDS.** Alternate bids will not be considered unless specifically called for in the bid.
10. **BOND REQUIREMENTS.** All bond requirements shall be identified in the invitation to bid. The right is reserved to require the successful bidder to furnish security, free of any expense to the City, to guarantee faithful performance of the contract.
11. **SPECIFICATIONS.** It is understood that reference to available specifications shall be sufficient to make items of such specifications binding on the Contractor. The use of the name

of a manufacturer, or any special brand or make in describing an item does not restrict the bidder to that manufacturer, unless specifically stated. The articles on which proposals are submitted must be equal or superior to that specified. Articles received not equal will be picked up by the vendor or returned to vendor shipping charges collect.

12. INSPECTION. Whether or not an inspection point is specified herein, all material and workmanship shall be subject to inspection and test at all times and places (including inspection and test after arrival at destination) and, when practicable during manufacture. In case any articles are found to be defective in material or workmanship, or otherwise not in conformity with the specification requirements, the City shall have the right to reject such articles or require their correction. Final inspection shall be conclusive except as regards latent defects, fraud, or such gross mistakes as amount to fraud.

13. WARRANTY. State any and all guarantees or warranties that would apply to item/product/service that you are bidding.

14. Faxed or electronically submitted bids will not be accepted.

NO BIDS/PROPOSALS WILL BE ACCEPTED AFTER THE ADVERTISED BID OPENING TIME.

EQUAL OPPORTUNITY TITLE VI POLICY STATEMENT
--

It is the policy of the City of Forest Hills to ensure compliance with Title VI of the Civil Rights Act of 1964; 49 CFR, Part 21; related statutes and regulations to the end that no person shall be excluded from participation in or be denied the benefits of, or be subjected to discrimination under any program or activity receiving federal financial assistance from the U. S. Department of Transportation on the grounds of race, color, sex, age, disability or national origin.

PROPOSAL

MAYOR Lanson J. Hyde, III AND CITY COMMISSION
FOREST HILLS, TENNESSEE 37215

Mayor and Commissioners:

In response to the Notice to Contractors, the undersigned Bidder submits the following proposal for **PW 2021-04 Tara Drive Speed Humps** within the City of Forest Hills as described and specified in the drawings, contract documents, and technical specifications.

Bidder hereby declares that in the event the City accepts this Proposal, Bidder will, within ten (10) business days of the date of a written notice of award, enter into a Contract with the City of Forest Hills, substantially in the form included in the Contract Documents and shall furnish and pay for all labor, materials, plant and equipment necessary to perform the work required as called for in the PROPOSAL BID TABULATION FORM.

The Bidder agrees that the unit quantities are approximate. The City has a right to increase or decrease quantities by Contract Amendment as required for construction or as directed and the total of all payments shall be actual quantities or work installed.

The Contractor shall be paid for the actual quantities installed at the unit price bid.

By submission of this proposal, the Bidder certifies that this Bid has been arrived at independently, without consultation, communication, or agreement as to any matter relating to this Bid with any other Bidder or with competitor.

The Bidder is prepared to submit a Statement of Bidders Qualifications upon the City's request, including but not limited to, a complete financial statement.

The Bidder agrees that if the City accepts his Proposal, Bidder will furnish a Performance-Payment Bond as security for faithful performance of the Contract and for the payment of all persons performing labor or furnishing labor or furnishing materials in connection under the Contract, in the amount of 100% of the project cost, with a Surety acceptable to the City.

Attached is the required Bid Bond or Certified Check in the amount of 10% of the total Base Bid which the Bidder agrees will be retained by the City as liquidated damages in the event that the Bidder's proposal is accepted and the Bidder fails to execute the contract within the time stated in the proposal.

[signature page follows]

PROPOSAL SIGNATURE PAGE

I, the undersigned, do hereby agree to the terms and conditions provided in this solicitation.

Name of Company: _____

Tennessee Contractors License Number: _____

Address: _____

Telephone Number: _____ **Fax Number:** _____

E-mail Address: _____

ADDENDUM ACKNOWLEDGEMENT. Acknowledgment is hereby made for receipt of all addenda issued for this solicitation, the provisions of which are incorporated herein.

Addendum No. _____ Date Issued: _____

Addendum No. _____ Date Issued: _____

Addendum No. _____ Date Issued: _____

Addendum No. _____ Date Issued: _____

Authorized Signature: _____

Printed Name: _____

Title: _____

Signed, this _____ day of _____, 2021.

DRUG-FREE WORKPLACE AFFIDAVIT

State of Tennessee)
County of Davidson)

The undersigned, principal officer of _____, an employer of five (5) or more employees contracting with the City of Forest Hills, 6300 Hillsboro Pike, Nashville, TN 37215 to provide construction services, hereby states under oath as follows:

1. The undersigned is a principal officer of _____ (hereinafter referred to as the "Company"), and is duly authorized to execute this Affidavit on behalf of the Company.

2. The Company submits this Affidavit pursuant to T.C.A. § 50-9-113, which requires each employer with no less than five (5) employees receiving pay who contracts with the state of any local government to provide construction services to submit an affidavit stating that such employer has a drug-free workplace program that complies with Title 50, Chapter 9, of the Tennessee Code Annotated.

3. The Company is in compliance with T.C.A § 50-9-113.

Further affidavit saith not.

Principal Officer

Title

Before me personally appeared _____, with whom I am personally acquainted (or proved to me on the basis of satisfactory evidence), and who acknowledged that such person executed the foregoing affidavit for the purposes therein contained.

Witness my hand and seal the _____ day of _____, 2021.

Notary Public

My commission expires:

IRAN DIVESTMENT ACT AFFIDAVIT

As per Tennessee Code Annotated, Title 12, and effective July 1, 2016:

By submission of this bid, each bidder and each person signing on behalf of any bidder certifies, and in the case of a joint bid, each party thereto certifies as to its own organization, under penalty of perjury, that to the best of its knowledge and belief that each bidder is not on the list created pursuant to T.C.A. § 12-12-106.

Authorized Signature

Signed, this _____ day of _____, 2021

BIDDER QUALIFICATIONS & REFERENCES

All Bidders for these services must have adequate industry experience and professional qualifications for roadway maintenance/roadway construction projects in the City according to these Specifications. The City will confirm the below qualifications and references prior to awarding the Contract.

1. Bidders must be in the regular business of roadway maintenance/roadway construction for **at least three continuous years**.
2. Supervisory personnel performing roadway maintenance/roadway construction must have reasonable training and/or experience, necessary equipment and materials used in the roadway maintenance or roadway construction.
3. Bidders must show evidence that they possess adequate equipment, materials and resources to perform the roadway maintenance/ roadway construction in a timely fashion.

Total number of continuous years in the roadway maintenance/roadway construction business:

Number of Employees: Full-Time: _____ Seasonal/Part-time: _____

Number of separate roadway maintenance or roadway construction type projects in the last 5 years: _____

Largest roadway maintenance or roadway construction project performed by Bidder in the last 5 years:

- Name of Customer/Project Name: _____
- Description: _____

List equipment to be used for the project: _____

Name of the project superintendent planned for this project: _____

Qualifications: _____

Experience: _____

Technical Skills: _____

References for three similar-sized projects, performed in the last **2 years**, preferably located in this geographical region

1. Reference Name: _____

Date of Project: _____ Location: _____

Description: _____

Contact Name: _____

Address: _____

Telephone: _____ Email: _____

2. Reference Name: _____

Date of Project: _____ Location: _____

Description: _____

Contact Name: _____

Address: _____

Telephone: _____ Email: _____

3. Reference Name: _____

Date of Project: _____ Location: _____

Description: _____

Contact Name: _____

Address: _____

Telephone: _____ Email: _____

Note: This Qualifications & References sheet must be returned with the Bid.

PERFORMANCE-PAYMENT BOND

KNOW ALL MEN BY THESE PRESENTS:

That _____, a Tennessee _____ (the "Principal") and _____ of _____, State of _____ (the "Surety"), are held and firmly bound unto the **City of Forest Hills, Tennessee** in the sum of _____ Dollars in lawful money of the United States, for the payment of which sum well and truly to be made, do hereby bind ourselves, our heirs, executors, administrators, and successors, jointly and severally, firmly by these presents.

THE CONDITION OF THIS OBLIGATION is such that whereas, the Principal entered into a certain contract (the "Contract") with the City of Forest Hills, dated the _____ day of _____, 2021, a copy of which is attached hereto and made a part hereof for PW 2021-04 Tara Drive Speed Humps.

NOW, THEREFORE, if the Principal shall well, truly, and faithfully perform its duties, all undertakings covenants, terms, conditions, and agreements of said Contract during the original term thereof, and any extensions thereof, which may be granted by the City of Forest Hills, with or without notice to the Surety, and if the Principal shall satisfy all claims and demands incurred under such Contract, and shall fully indemnify and hold harmless the City of Forest Hills from all costs and damages which it may suffer by reason of failure to do so, and shall reimburse and repay the City of Forest Hills all outlay and expense which the City of Forest Hills may incur in making good any default, and shall promptly make payment to all persons, firms, subcontractors, and corporations furnishing materials for or performing labor in the prosecution of the work provided for under the Contract, and may authorize extension or modification thereof, including all amounts due for materials, lubricants, and other fluids for the use and repair of machinery, equipment, tools, consumed or used in connection with the performance of such work, and all insurance premiums on said work, and for all labor performed whether by subcontractor or otherwise, then this obligation shall be void; otherwise remain in full force and effect.

Signed, this _____ day of _____, 2021.

PRINCIPAL

SURETY

By: _____

By: _____

Its: _____

Its: _____

Date: ____ / ____ / ____

Date: ____ / ____ / ____

DESCRIPTION OF WORK

The work described in these specifications consists of furnishing all labor, materials, tools, incidentals, equipment and services necessary to complete all work in accordance with the specifications using a standard of care consistent with general roadway construction and the General Conditions, Special Conditions, and Technical Specifications and other requirements contained in these specifications. Payment for items shall be as measured and be complete and in-place including all mobilization, labor, materials and incidentals.

Work to be performed shall consist of:

Traffic Calming - Speed Hump: Construction of six speed humps on Tara Drive. Includes street paving, drainage improvement, pavement markings, and signage.

Signs: Removal of signs and sign poles as depicted in plans, installation of new signs and sign poles as depicted in plans.

Pavement Markings: Marking pavements on Tara Drive as depicted in plans.

1. Work to be Completed. Drawings are included that summarize work items to be completed. Refer to drawings on page 49 of this contract for these work item descriptions; and refer to the Proposal Bid Tabulation Form section for a table listing of all anticipated work item quantities.
2. Utilities. The Contractor shall notify Tennessee One Call (1-800-351-1111) three working days prior to excavation in public street right-of-way.
3. Maintenance of Traffic. The contractors traffic control shall conform to the Manual on Uniform Traffic Control Devices for Streets and Highways. The contractor will notify the City Manager three (3) days in advance of lane closures or total road closures for the notification of emergency service providers.
4. Street Paving Marking. The existing pavement surface shall be thoroughly cleaned of all dirt and loose particles prior to the application of tack coat. All material shall be removed and disposed of by the Contractor. Joints and cracks shall be cleaned of dirt and vegetation growth. Tack coat shall be applied on speed humps prior to overlay at a rate of 0.075 gallon per square yard. No additional compensation will be provided for pavement preparation; the cost shall be included in the prices bid.
5. Safety. Safety precautions shall be used at all times during the progress of the work. As appropriate, workmen shall be furnished with hard hats, safety shoes, asbestos gloves, respirators, and any other safety apparel that will reduce the possibility of accidents. All Occupational Safety and Health Act requirements shall be observed.
6. Method of Measurement. Upon completion and acceptance of work performed in accordance with the specifications, payment shall become due and payable at the unit price bid. Payment shall constitute full compensation for completion of the work in-place, and shall include all labor, incidentals and materials furnishing, and for all labor, tools, equipment and incidentals necessary to complete the work in full accordance with the specifications.

PROPOSAL BID TABULATION FORM

CITY OF FOREST HILLS

PW 2021-04 Tara Drive Speed Humps

In compliance with your legal Notice to Bidders for the City of Forest Hills PW 2021-04 Tara Drive Speed Humps, the undersigned bidder, a corporation organized and existing under the laws of the State of _____, or a partnership of _____ or an individual doing business as _____ of the City of _____, State of _____, having examined the specifications and contract forms thereto attached, and being fully advised as to the extent and character of the work to be performed, and the equipment to be furnished, hereby proposes to furnish all labor, tools, material, plant and equipment necessary for the Project.

The quantities presented in the following Proposal Bid Tabulation Form are for bidding purposes and comparison only. The Form includes items of work that is associated with roadway construction.

The City of Forest Hills does not guarantee that the City will issue any work orders for any project under this contract.

The bidder shall complete all tables below to establish his bid.

PROPOSAL BID TABULATION FORM – BASE BID

ITEM NO.	DESCRIPTION	EST. QTY.	PAY UNIT	UNIT PRICE	EXTENDED PRICE
403-02.01	TRACKLESS TACK COAT	0.13	TONS		
712-01	TRAFFIC CONTROL	1	L.S.		
713-13.02	FLAT SHEET ALUMINUM SIGNS (0.080" THICK)	82	S.F.		
716-02.01	4" PLASTIC PVMT MARKING LINE	16,200	L.F.		
716-02.05	PLASTIC PAVEMENT MARKING LINE (STOP LINE)	40	L.F.		
717-01	MOBILIZATION	1	L.S.		
SP-1	MILLING @ EXISTING STREETS AND DRIVEWAYS	300	L.F.		
SP-2	SPEED HUMP INSTALLATION	6	EACH		
SP-3	PLASTIC PAVEMENT MARKING (SPEED HUMP/TABLE)	12	EACH		
SP-4	STEEL SIGN POLE (TRAFFIC SIGN)	13	EACH		
SP-5	SIGN AND SIGN POST REMOVAL	6	EACH		
TOTAL BASE BID _____					DOLLARS

Contractor Initial & Date

The undersigned further proposes to perform all work and furnish all equipment in accordance with the specifications and contract stipulations thereof, within the time limit specified, for the price so stated above.

Bidder understands that the City reserves the right to reject any or all bids, or portions thereof, and to waive any informality in bidding.

The bidder agrees that his bid shall be good and may not be withdrawn for a period of thirty (30) days after the scheduled closing time for receiving bids.

Upon receipt of written notice of acceptance of this bid, Bidder will execute the enclosed formal contract and deliver insurance coverage as required by the INFORMATION FOR BIDDERS within ten (10) business days of notice.

BIDDER/CONTRACTOR

Name of Company: _____

Tennessee Contractors License Number: _____

Address: _____

Telephone Number: _____

Fax Number: _____

E-mail Address: _____

Authorized Signature: _____

Printed Name: _____

Title: _____

Signed, the _____ day of _____, 2021.

**CONTRACT FOR
PW 2021-04 Tara Drive Speed Humps**

This Contract For PW 2021-04 Tara Drive Speed Humps (the "Agreement") is made and entered on _____, 2021 (the "Effective Date") by and between the **City of Forest Hills**, Tennessee (the "City") and _____, a Tennessee _____ (the "Contractor").

This Agreement is made with reference to the following facts:

- A. The intent of this Agreement is to provide for construction and completion of **PW 2021-04 Tara Drive Speed Humps**, as assigned by the City of Forest Hills, in accordance with the specifications herein and using a standard of care consistent with general roadway construction and maintenance and the terms and conditions herein.
- B. Assigned work may or may not include project plans. If project plans are provided, all work will be completed according to those drawings and specifications in addition to the terms and conditions of this Agreement.
- C. Unless otherwise specified, the Contractor will furnish all materials, incidentals, equipment and perform all labor necessary to perform the work authorized by the City and detailed in project plans and specifications.
- D. All work will be assigned by the City Manager as needed. Payment for goods and services shall be as measured and be complete and in-place, including all mobilization, labor, materials and incidentals.

NOW THEREFORE, the City and Contractor, in consideration of the mutual covenants contained herein, the receipt and sufficiency of which are hereby acknowledged, do hereby agree as follows:

- 1 **Definitions.** The following terms have the meanings given in this section:
 - 1.1 "**City Manager**" means the City Manager of the City, or her designee.
 - 1.2 "**Contract Documents**" means this Agreement, those certain Contract Specifications and Contract Documents dated September/October 2021 and prepared by Neel-Schaffer, Inc., and the PROPOSAL BID TABULATION FORM included therein.
 - 1.3 "**Services**" means the furnishing of labor, materials, equipment and services necessary to perform Street Maintenance Projects or Drainage Maintenance Projects, or both, as the case may be.

- 1.4 “**Sign Maintenance Projects**” include, but are not limited to, sign work; sign maintenance, sign repair and installation.
- 1.5 “**Street Paving Projects**” include, but are not limited to, street patching and repair; street paving; shoulder stabilization; curb repair; and pavement markings.

2 **Quantities.**

- 2.1 The City reserves the right to alter the quantities of work to be performed or to extend or to shorten the work at any time, when and as found necessary. The Contractor shall perform the work as altered, increased, or decreased at the unit price provided in enclosed PROPOSAL BID TABULATION FORM. No allowance will be made for any change in anticipated profits nor shall such changes be considered as waiving or invalidating any conditions or provisions of this Agreement.

3 **Time for Performance.**

- 3.1 **Term.** The term of this Agreement shall commence on the Effective Date and continue for one (1) year (the “Term”).
- 3.2 **Mobilization.** Unless otherwise specified in the Final Work Order, within ten (10) business days of the City Manager’s issuance of a Notice to Proceed, the Contractor shall mobilize his forces and commence performance of the Services.
- 3.3 **Time.** Contractor shall not commence performance of Services prior to 7:00 AM, nor extend past sundown, except as directed by the City Manager. All work shall be completed in a timely manner within the specified time frame given by the City Manager for each work order. Delays deemed unacceptable by the City shall be grounds for termination of this Agreement. **All work specifically identified in this Contract shall be substantially complete by December 31, 2021.**

4 **Consideration.**

- 4.1 The City shall pay to the Contractor for the diligent, faithful performance of this Agreement the actual cost of the Services performed and accepted by the City based on the unit prices attached hereto and incorporated herein as “PROPOSAL BID TABULATION FORM.”
- 4.2 The City shall make payments on a monthly basis to the Contractor on the basis of a duly certified and approved invoice of the Services performed during the preceding calendar month.

- 5 **Insurance.** The Contractor shall purchase and maintain insurance for the protection of claims under worker’s compensation acts, for bodily injury and for property damage arising out of Contractor’s obligations and duties under this Agreement as follows:

- 5.1 Comprehensive General Liability with policy limits of not less than One Million Dollars (\$1,000,000.00) for each occurrence and in the aggregate for bodily injury and property damage;
- 5.2 Automobile Liability covering owned and rented vehicles operated by the Contractor with policy limits of not less than One Million Dollars (\$1,000,000.00) combined single limit and aggregate for bodily injury and property damage;
- 5.3 Worker's Compensation at statutory limits and Employers Liability with a policy limit of not less than Five Hundred Thousand Dollars (\$500,000.00) per claim and in the aggregate;

The Contractor may use umbrella or excess liability insurance to achieve the required coverage for Comprehensive General Liability and Automobile Liability, provided that such umbrella or excess insurance results in the same type of coverage as required for the individual policies.

The Contractor shall provide to the City certificates of insurance evidencing compliance with the requirements of this section. The certificates will show the City as an additional insured on the Comprehensive General Liability, Automobile Liability, and umbrella or excess insurance policies and contain a waiver of subrogation clause in favor of the City.

All insurance policies shall include a clause which states, in effect, that the policy shall not be canceled, modified, nor allowed to expire until ten (10) days written notice has been received by the City prior to such cancellation, modification, or expiration.

- 6 **Indemnity.** Contractor agrees to pay, defend, indemnify, and hold the City harmless from and against any and all liabilities, losses, damages, costs, expenses (including all reasonable attorneys' fees and expenses), causes of action, suits, claims, demands, or judgments of any nature whatsoever arising from: (i) any use, trespass or damage to private property occasioned by Contractor's performance of the Services, (ii) the conduct of the Contractor or any of its employees, servants, agents or subcontractors in the performance of this Agreement, or (iii) any injury to or death of any person, or any damage to property caused by Contractor, its employees, servants, agents, or subcontractors. In case any action, suit, or proceeding is brought against the City by reason of any occurrence herein described, Contractor shall, at its own expense, defend such action, suit, or proceeding with counsel acceptable to the City in the City's sole discretion. The indemnity agreement provided herein shall survive the expiration or earlier termination of this Agreement.

- 7 **Performance of Services; Duties of Contractor.**

- 7.1 **License.** Contractor shall maintain a valid Tennessee Contractor's Licenses at all times throughout the Term of this Agreement. Each of Contractor's drivers shall, at all times, carry a valid driver's license for the type of vehicle he is driving.

- 7.2 **Duty of Care.** Contractor shall perform the Services in a good and workmanlike fashion and using the Contractor’s best skill and attention, consistent with the terms and conditions herein, and consistent with any plans and specifications developed by the City.

The Contractor shall provide operating and safety training for all personnel. Contractor shall be responsible for ensuring all employees wear adequate safety equipment at all times, including, but not limited to, hard hats, protective eyewear, protective footwear, and reflective gear as necessary.

- 7.3 **Equipment.** The Contractor shall maintain its equipment in operable condition and suitable capacity and available to the City at all times during the terms of this Agreement.

- 7.4 **Permits, Fees and Specifications.** The Contractor shall obtain and pay for any permits or governmental fees, licenses, or inspections required for proper execution and completion of the Services.

7.4.1 Unless otherwise noted, all Services shall be performed in accordance with the current edition of the Tennessee Department of Transportation “Standard Specifications for Road and Bridge Construction,” including all revisions and special provisions.

7.4.2 The Contractor shall interfere as little as possible with the public use of roads, walks, and entrances to houses, and shall, at its own expense, make such approved temporary provisions as are required to maintain at least one lane of traffic.

7.4.3 All work to be performed within the street right-of-way shall be completed with the appropriate traffic control. Traffic shall be directed with such signs, barricades, devices, flaggers, and pilot vehicles that shall conform to the Manual of Uniform Traffic Control Devices.

7.4.4 Unless otherwise noted, all aspects of work orders shall be constructed in accordance with the current edition of the Tennessee Department of Transportation “Standard Specifications for Road and Bridge Construction,” including all revisions and special provisions.

7.4.5 All Work containing erosion/sediment control components, water quality components, ditch linings, etc., shall be constructed in accordance with the latest edition of the Tennessee Department of Environment and Conservation Erosion and Sediment Control Handbook.

- 7.5 **Taxes.** The Contractor will be responsible for all taxes levied against the Contractor under the laws of the State of Tennessee

7.6 **Warranty.** The Contractor warrants to the City that: (i) materials furnished under this Agreement will be new and of good quality, unless otherwise required or permitted by the City, (ii) the Services will be free from defects not inherent in the quality required or permitted; and (iii) the Services will conform to the requirements of any plans and specifications for a particular project and the terms and conditions of this Agreement.

7.7 **Cleaning Up.** Accumulations of mud or debris that are tracked on to streets or areas adjacent to work sites by construction equipment of the Contractor must be removed promptly and not allowed to create a hazard or an unsightly condition. After completion of all work contemplated under a Work Order and before final payment thereon has been made, the Contractor shall make a final cleanup of the site of each separate part of the work; shall restore all surfaces to a neat and orderly condition; and shall remove all construction equipment, tools, and supplies therefrom.

Where the Contractor has performed work on, or has made use of, private property for storage of materials or for other purposes, he shall obtain a satisfactory release from the owner of said property after completion of the work and the removal of all materials and equipment therefrom.

8 **Independent Contractor.** The Contractor is an independent contractor with respect to the City. Nothing contained herein shall create any association, partnership, joint venture, employment, or agency relationship between the parties.

9 **Conflicts.** In the event of a conflict between the terms of this Agreement and the remainder of the Contract Documents, the terms of this Agreement shall control.

10 **Miscellaneous.**

10.1 **Performance Bond.** Contractor shall provide to the City a performance bond in a form reasonably acceptable to the City's attorney, and in an amount not less than 100% of the Base Bid amount to secure the faithful performance of this Agreement. If the Contractor refuses or fails to provide the Services with such diligence as will ensure its completion within the time specified and in the manner specified, the City may terminate this Agreement and Contractor's right to proceed. In such event, the City may require the surety under the performance bond to fully perform and complete the work in the manner required by the performance bond. In the alternative, the City may take over the work, by contract or otherwise, and the Contractor and its surety shall be liable to the City for any excess cost.

10.2 **Delay Damages.** If Contractor fails to commence a Work Order when scheduled or if work ceases for more than five (5) business days and such failure continues for three (3) business days following notice from the City to commence or resume the Work Order, then the City shall be entitled to: (i) charge the contractor a

\$250.00 per day liquidated damage; (ii) terminate the specific Work Order and assign same to another contractor; or (iii) terminate this Contract. The Contractor and City acknowledge and agree that: ascertaining precisely the damages that would be suffered by the City in the event of Contractor's performance default at any given time during the term of this Contract would be costly, time-consuming and difficult, if not impossible; the amount of the liquidated damages constitutes good faith estimate by the Contractor and City of the damages to the City that would arise from such default by Contractor; and this agreed and stated amount is intended not as a penalty but as fully liquidated damages to the City for such a default by Contractor. If liquidated damages are incurred, the City shall be entitled to deduct and withhold said amount from payments then or thereafter to become due to the Contractor. If payments then or thereafter due to the Contractor are not sufficient to cover such amount, the Contractor shall promptly pay the difference to the City.

- 10.3 **Equal Opportunity.** It is the policy of the City to ensure compliance with Title VI of the Civil Rights Act of 1964, 49 CFR §21, and related statutes and regulations to the end that no person shall be excluded from participation in or be denied the benefits of, or be subject to discrimination under, any program or activity receiving federal financial assistance from the U.S. Department of Transportation on the grounds of race, color, sex, age, disability or national origin. No person shall be denied employment by the Company for reasons of race, color, sex, age, disability or national origin. Affirmative action compliance is required.
- 10.4 **Drug Free Workplace.** Within five (5) days of execution of this Agreement, Contractor shall submit a drug-free workplace affidavit to the City pursuant to T.C.A. § 50-9-113.
- 10.5 **Resident Status.** It shall be the Contractor's responsibility to insure that all persons employed, whether directly or by subcontractor, are legal residents and be authorized to work in the United States of America.
- 10.6 **Certified Public Weigher Law.** The Contractor or materials supplier shall employ a Certified Public Weigher as defined in the Certified Public Weigher Law of 1981. All applicable materials shall be measured in accordance with the Certified Public Weigher Law of 1981 on scales approved by the City Engineer. The Contractor shall provide weigh (haul) tickets for each load delivered to any job site.
- 10.7 **Compliance with Laws.** Contractor agrees that the Services provided pursuant to this Agreement shall be provided in compliance with all laws, ordinances and regulations of the United States, State of Tennessee, Metropolitan Government of Nashville and Davidson County, and the City, now or hereafter in effect during the term of this Agreement.

- 10.8 **Assignment.** The Contractor shall not assign this Agreement, except upon the express prior written consent of the City.
- 10.9 **Cancellation.** The City has a right to cancel this Agreement for convenience on thirty (30) days written notice to the Contractor. The City has a right to cancel this Agreement for failure of Contractor to properly perform the duties herein within ten (10) business days written notice to the Contractor. Also, it is agreed that if Contractor is adjudged bankrupt, either voluntarily or involuntarily, or files a bankruptcy petition, then the City may terminate this Agreement at any time.
- 10.10 **Notice.** All notices, demands and requests required under this Agreement shall be in writing. All such notices, demands and requests shall be deemed to have been properly given if delivered personally or sent by United States Registered or Certified Mail or by nationally recognized guaranteed overnight courier delivery service, postage prepaid, addressed to the City at:

The City of Forest Hills
 Attn: Mark Hill, Interim City Manager
 6300 Hillsboro Road
 Nashville, Tennessee 37215

and to the Contractor at:

Name of Company: _____

Address: _____

- 10.11 **Governing Law.** This Agreement shall be governed by and construed in accordance with the laws of the State of Tennessee without regard to its conflict of law principles. In case of a dispute as to this form or any document required hereunder, this form shall be conclusively deemed reasonable and shall not be presumptively interpreted against either Party.
- 10.12 **Entire Agreement.** This Agreement represents the entire and integrated agreement between the parties and supersedes prior negotiations, representations, or agreements, written or oral. This Agreement may be modified only by written amendment executed by all parties hereto.
- 11 **Counterparts and Signatures.** This Agreement may be executed in multiple counterparts, each of which shall be deemed an original and all of which, collectively, shall be one and

the same instrument. Further facsimile and electronic signatures shall be as binding as originals, and signatures transmitted by facsimile and electronic means shall be deemed originals and shall be binding upon the parties hereto.

IN WITNESS WHEREOF, each party to this Agreement has caused it to be executed on the date first above written.

CONTRACTOR

By: _____

Name: _____

Its: _____

CITY

The City of Forest Hills

By: _____

SPECIAL CONDITIONS

1. **Project Description.** The work to be performed by the Contractor shall consist of **Tara Drive Speed Humps** as specified herein and as directed by the City Manager. The work to be done shall consist of furnishing all materials, supplies, and equipment; performing all labor and services incidental to or necessary for the complete maintenance of streets in accordance with the specifications; and the maintenance of each completed portion of the work until final acceptance of the entire project by the City.
2. **Date of Completion.** Contractor shall commence the work to be performed as soon as practical and in a timely manner as directed by the City Manager. Delays deemed unacceptable by the City shall be grounds for termination of this Contract. **All work specifically identified in this Contract shall be substantially complete by December 31, 2021.**

Measurement: All work shall be paid at the unit price bid, complete and in-place, and shall include all labor, incidentals and materials specified in this contract, or as listed in the current edition of the Tennessee Department of Transportation (TDOT) "Standard Specifications for Road and Bridge Construction" and shown in TDOT Standard Drawings found at the following internet link:

https://www.tn.gov/content/dam/tn/tdot/construction/2021-standard-specifications/January_1_2021_Standard_Specifications.pdf

SP-1: Milling at Existing Streets and Driveways. This work shall consist of milling the existing roadway at start and end of each of the six proposed speed humps on Tara Drive.

SP-2: Speed Hump Installation. This work shall consist of installing six speed humps on Tara Drive as shown in the plans.

SP-3: Plastic Pavement Marking (Speed Hump/Table). This work consists of applying pavement markings on the speed humps as depicted in the plans.

SP-4: Steel Sign Pole (Traffic Sign). This work shall consist of the installation of round sign pole (supplied by the Contractor) and traffic sign (supplied by the Contractor or City) as directed by the City. Cost of installation of round steel sign pole, steel pineapple finial, sign frame, mounting hardware, sign installation, and foundation shall be included in the price bid.

SP-5: Sign and Sign Post Removal. This work consists of removing the signs and sign posts designated for removal in the plans. Once the signs designated for removal are removed, they then become the property of the contractor.

3. **Quantities.** Quantities shown on the PROPOSAL BID TABULATION FORM are estimates and are included for bidding purposes only. Contractor shall be paid for actual quantities established by the City of Forest Hills under this contract and payment will be made only on

the actual quantities of work completed in place, measured on the basis defined in the contract conditions and the specifications.

Estimate shall be itemized per the enclosed PROPOSAL BID TABULATION FORM.

GENERAL CONDITIONS

DEFINITIONS

DEFINITION OF TERMS: Whenever the words, forms or phases defined or pronouns used in their stead, occur in these Specifications, in the Contract or in the Advertisement or any document, or instrument herein contemplated or to which these specifications apply, the intent and meaning shall be construed and interpreted as follows:

ADDENDA: Any changes in specifications after advertisements for bid will be made by Addenda to specifications. After issuance, any Addenda shall become a part of the Specifications, as much as though fully contained therein.

BIDDER: Any individual, firm or corporation submitting a Bid or Proposal for the work contemplated.

CONSTRUCTION BONDS or PERFORMANCE AND PAYMENT BONDS: The approved form of security furnished by the Contractor and his surety as a guarantee of good faith on the part of the Contractor to execute the work in accordance with Specifications and terms of the Contract.

CONTRACT: The written agreement between the City of Forest Hills and the Contractor covering the performance of the work. The Contract includes the Advertisement (Notice to Contractors), Proposal, General Conditions, Special Conditions, Detailed Specifications, Contract Agreement, Construction Bonds, and all Addenda and Change Orders thereto.

CITY: The City of Forest Hills, Tennessee

CITY ENGINEER: The City Engineer of the City of Forest Hills, Tennessee or his duly authorized representative.

CITY MANAGER: The City Manager of the City of Forest Hills, Tennessee or her duly authorized representative.

CONTRACTOR: The individual, firm or corporation selected by the City as the successful bidder who has become a party to the Contract, and his duly authorized representatives.

PROPOSAL: The written and signed statement which includes the completed Proposal form duly filed with the City by the person or persons, partnership, company, firm, corporation proposing to do the work contemplated.

PROPOSAL FORM: The form bound in these Construction Contract Documents on which the formal bids for the work are to be prepared and submitted.

SPECIFICATIONS: The directions, provisions and requirements contained herein pertaining to the method and manner of performing the work or the quantities or qualities of materials to be furnished under the Contract.

SURETY or SURETIES: The corporate body which is bound by such bonds as are required with and for the Contractor, and engages to be responsible for the entire and satisfactory fulfillment of the Contract and for any and all requirements as set out in the Construction Contract Documents.

THE WORK or THE PROJECT: The work or project, including the furnishing of all labor, materials, tools, equipment and incidentals, necessary or required to complete the improvement in conformity with the directions, provisions and requirements of the Specifications, limitations and conditions of the Contract.

Where the following standard specifications are referred to in the Contract, the latest revisions of these specifications shall be used.

AASHTO	-	American Association of State Highways and Transportation Officials
ANSI	-	American National Standards Institute
ASTM	-	American Society for Testing and Materials
ITE	-	Institute of Transportation Engineers
MUTCD	-	Manual on Uniform Traffic Control Devices
TDOT	-	Tennessee Department of Transportation
TDEC	-	Tennessee Department of Environment and Conservation

PROPOSAL REQUIREMENTS AND CONDITIONS:

1. **PROPOSAL FORM.** The PROPOSAL BID TABULATION FORM bound in these Construction Contract Documents contains a list of items for work that may be performed and/or materials to be furnished, upon which bid prices are requested.
2. **INTERPRETATION OF ESTIMATE.** The quantities of the work and materials shown on the PROPOSAL BID TABULATION FORM are estimated and are to be used for comparison of bids. Payment to the Contractor will be made only for the actual quantities of work performed or materials furnished in accordance with the Specifications and it is understood that the quantities may be reasonably increased or decreased as hereinafter provided without in any way invalidating the bid process.
3. **EXAMINATION OF DOCUMENTS AND SITE OF THE WORK.** Bidders are advised that the Specifications, Estimates, and Addenda furnished by the City Manager shall constitute all the information that the City will furnish. No other information given by the City or any representative thereof, prior to their execution of the Contract shall become part of or change the Contract, Specifications, or Estimates or be binding upon the City. Bidders shall rely exclusively upon their own estimates, investigation and other data that are necessary for full and complete information that the Proposal may be based. The City and Bidder

mutually agree that submission of the Proposal will be evidence that the Bidder has made the examination and investigation required herein.

4. **PREPARATION OF PROPOSAL** . The Bidder shall submit his proposal on the forms bound in these Construction Contract Documents. Each item for which a quantity of work is shown shall show a unit price, and each item shall be correctly extended and summarized. Should there develop a discrepancy between the unit price and the extended amount shown, the unit price shall govern and the extended amount shall be corrected. The proposal must be properly signed, with the name and the address of the firm, corporation or individual Bidder clearly shown in the space provided. For a corporation the title of the official signing the Proposal and the state in which the corporation was chartered must be shown, and the corporation seal affixed and attested by the secretary.
5. **PROPOSAL GUARANTY**. Each Bidder must submit with Proposal a Bid Bond made by a company qualified and authorized to transact business in the State of Tennessee, in an amount not less than ten percent (10%) of the total amount of his Proposal as a guaranty that, if awarded a contract the Bidder will execute the required contract and furnish the required Performance-Payment Bond within ten (10) days after date of notice of such award.
6. **FILING OF PROPOSAL**. Each Proposal must be filed in a sealed envelope with the City within the time limit for receiving Proposals as stated in the Advertisement and shall be made on the Proposal form attached to the other Construction Contract Documents. The envelope containing the Proposal and other Construction Contract Documents shall contain the name of the project, name and address of the bidder, the bidder's license number, license classification, associated monetary limits, and the date of license expiration for the Prime and Subcontractor(s); otherwise the bid will not be opened. Proposals filed after the scheduled date and hour of opening will be unopened.
7. **WITHDRAWAL OF PROPOSALS**. A Bidder may withdraw, modify or amend his Proposal at any time prior to the scheduled date of opening Proposals by submitting to the City a written statement setting forth the nature of the desired modification or the reason for withdrawal.
8. **OPENING OF PROPOSALS**. The Proposals filed with the City will be opened and publicly read at the time and place stated in the Advertisement. Bidders are invited to be present. Proposals filed in proper order and accepted by the City for consideration and canvass and which has been opened and read may not be withdrawn for a period of 30 days after the opening.
9. **IRREGULAR PROPOSALS** . Proposals will be considered irregular if they show any omissions, alterations of forms, additions or conditions not called for, or irregularities of any kind.

However, the City reserves the right to waive technicalities and make the award in the best interest of the City.

10. **REJECTION OF PROPOSALS.** Each Proposal submitted by a Bidder shall be considered an offer to perform services. The City reserves the right to reject any or all Proposals.
11. **DISQUALIFICATION OF BIDDERS.** Any Bidder using the same or different names for submitting more than one Proposal for the work will be disqualified for further consideration on the work.
12. **CONSIDERATION OF PROPOSALS.** After the Proposals are opened and read, the City will check and tabulate all Proposals and such tabulations will be made public. Until the final award of the Contract, the City reserves the right to reject any or all Proposals, to waive technicalities, and to advertise for new Proposals.
13. **AWARD OF CONTRACT.** The City will award the Contract or reject all Proposals received within 30 days after date of opening Proposals. The award of the Contract, if made, shall be to the lowest responsive, responsible bidder whose proposal complies with the requirements of the City and is found to be in the best interest of the City. Before an award is made, the City reserves the right to investigate the previous experience, financial status, and general reputation of the three (3) lowest bidders.
14. **RETURN OF PROPOSAL GUARANTY.** Bid Bonds of all bidders, except those posted by the three lowest bidders will be returned within ten (10) days of date of award of Contract. Upon final execution of the Contract, the remaining bonds will be promptly returned.
15. **CONSTRUCTION (SURETY) BONDS.** With the execution and delivery of the Contract, the Contractor shall furnish to the City a Performance-Payment Bond for 100% of the project cost as security for faithful performance of the Contract and for payment of all persons performing labor and furnishing material under the Contract. Maintenance provisions of the bonds shall remain in effect for twelve (12) months after acceptance of the work by the City. The bonds shall be in form satisfactory to the City. The Surety shall be a reputable bonding company authorized to transact business in the state in which the work is located and shall be acceptable to the City.
16. **EXECUTION OF CONTRACT.** The Contract shall be executed by the successful bidder and returned to the City with acceptable construction bonds within ten (10) days after the date of notice of award by the City. The Contract, bonds, and other documents shall be approved by the City's attorney before execution and acceptance by the City.
17. **FAILURE TO EXECUTE CONTRACT.** Should the successful bidder to whom the Contract has been awarded fail to execute the Contract and furnish satisfactory construction (surety) bonds within ten (10) days after the date of award, it shall be consideration that he has abandoned his Proposal; the tender of Contract shall be withdrawn; and the amount of the

Proposal guaranty shall be forfeited to the City as fixed and agreed liquidated damages. The filing of the Proposal by any bidder shall be considered as an acceptance by him of this provision.

SCOPE OF WORK

1. **INTENT OF SPECIFICATIONS.** The intent of the specifications is to prescribe a complete work that the Contractor undertakes to do in full compliance with the Contract. The Contractor shall do all work as assigned by the City Manager or provided in the plans (if provided with a work order), specifications and other parts of the Contract and shall do such additional, extra and incidental work as may be considered necessary to complete the work in a satisfactory and acceptable manner. Any work or material not described in the specifications but which may be fairly implied as included in any item of the Contract shall be performed and/or furnished by the Contractor without additional charge therefore. The Contractor shall furnish all labor, materials, tools, equipment and incidentals necessary to the prosecution of the work.
2. **INCREASE OR DECREASE OF QUANTITIES.** The City reserves the right to alter the quantities of work to be performed or to extend or shorten a project or work order at any time, when and as found necessary; and the Contractor shall perform the work as altered, increased or decreased, at the Contract unit price. No allowance will be made for any change in anticipated profits nor shall such changes be considered as waiving or invalidating any conditions or provisions of the Contract.
3. **ALTERATIONS OF PLANS AND SPECIFICATIONS.** The City reserves the right, at any time, to make such changes in the plans (if plans are provided with a work order) and the character of the work as may be necessary or desirable to ensure completion in the most satisfactory manner, provided such changes do not materially alter the original plans and specifications or change the general nature of the work as a whole. Such changes shall not be considered as waiving or invalidating any condition or provision of the Contract.
4. **EXTRA WORK AND CHANGES IN WORK.** Without invalidating the contract, the City may order extra work or make changes by altering, adding to or deducting from the work. All the work of the kind bid upon shall be paid for at the price stipulated in the Proposal, and no claims for any extra work or materials shall be allowed unless the work is ordered in writing by the City or its City Manager, acting officially for the City, and the price is stated in such order. No changes in the work covered by the approved contract documents shall be made without having prior written approval of the City. Charges or credits for the work covered by the approved change shall be determined by one or more, or a combination of the following method:
 - Unit bid price previously approved.
 - An agreed lump sum.

- Cost reimbursement consisting of actual cost of labor, direct overhead, materials, supplies, equipment, and other services necessary to complete the works plus an amount to be agreed to cover the cost of general overhead and profit.

No claim for extra work or cost shall be allowed unless the same was performed pursuant to a written order of the City Manager, as aforesaid, and the claim presented with the first estimate after the changed or extra work is done. When work is performed under the terms above, the Contractor shall furnish satisfactory bills, payrolls and vouchers covering all items of cost and when requested by the City, give the City access to accounts relating thereto.

5. **CLEANING UP.** Throughout the progress of the work, the Contractor shall keep the construction area, including storage areas used by him, free from accumulations of waste material or rubbish and shall keep his materials and equipment in a neat and orderly manner. Immediately upon completion of any section of work and before payment therefore has been made he shall remove from the site all construction equipment, temporary structures, and debris and shall restore the site to a neat, workmanlike condition. Waste material shall be disposed of at locations satisfactory to the City Manager and at the Contractors expense.
 - a) Accumulations of mud or debris that are tracked on to streets or areas adjacent to the work site by construction equipment of the Contractor or any Subcontractor or Supplier, must be removed promptly and not allowed to create a hazard or an unsightly condition.
 - b) Where the Contractor has performed work on, or has made use of, private property for storage of materials or for other purposes, he shall obtain a satisfactory release from the owner of said property after completion of the work and the removal of all materials and equipment therefrom.
 - c) After completion of all work contemplated under the Contract and before final payment thereon has been made, the Contractor shall make a final cleanup of the site of each separate part of the work; shall restore all surfaces to a neat and orderly condition; and shall remove all construction equipment, tools, and supplies therefrom.
6. **RIGHTS-OF-WAY AND SUSPENSION OF WORK.** The City will furnish all land and rights-of-way necessary for the carrying out of this contract and the completion of the work herein contemplated and will use due diligence in acquiring said land and rights-of-way as speedily as possible. But it is possible that all lands and right-of-way may not be obtained as herein contemplated before construction begins, in which event the Contractor shall begin his work upon such land and rights-of-way as the City may have previously acquired and no claim for damages whatsoever will be allowed by reason of the delay in obtaining the remaining lands and rights-of-way. Should the City be prevented or enjoined from preceding with the work, or from authorizing its prosecution, either before or after the commencement by reason of any litigation, or by reason of its inability to procure any lands or rights-of-way for the said work, the Contractor shall not be entitled to make any claim for damage by reason of said delay, or to withdraw from the contract except by consent of

the City; but the time for completion of the work will be extended to such time as the City determines will compensate for the time lost by such delay, such determination to be set forth in writing.

CONTROL OF WORK AND MATERIALS:

1. **AUTHORITY OF THE CITY MANAGER.** The City Manager shall give all orders and directions contemplated under this contract and specifications relative to the execution of the work. The City Manager shall determine the amount, quality, acceptability and fitness of the several kinds of work and materials that are to be paid for under this contract and shall decide all questions that may arise in relation to said work and the construction thereof. The City Manager's estimates and decisions shall be final and conclusive, except as otherwise expressly provided herein. In case any questions shall arise between the parties hereto relative to said Contract or specifications, the determination or decision of the City Manager shall be a condition precedent to the right of the Contractor to receive any money or payment for work under this Contract affected in any manner or to any extent by such question.
 - a) The City Manager shall decide the meaning and intent of any portion of the specifications and of any plans or drawings where the same may be found obscure or be in disputes.
 - b) Any differences or conflicts in regard to their work, which may arise between the Contractor under this contract and other contractors performing work for the City, shall be adjusted and determined by the City Manager.

2. **SAFETY AND HEALTH REGULATIONS.** The Contractor shall comply with the Department of Labor Safety and Health Regulations for construction promulgated under the Occupational Safety and Health Act of 1970 (PL 91-596) and under Section 107 of the Contract Work Hours and Safety Standards Act (PL 91-54).
 - a) These regulations are administered by the Department of Labor whose representatives shall be allowed access to the project for inspection, etc.
 - b) The Contractor shall be solely and completely responsible for conditions of the job site, including safety of all persons and property during performance of the work. This requirement will apply continuously and will not be limited to normal working hours.
 - c) The Contractor shall designate a competent employee to be responsible for complying with the duties enumerated in Subparagraph (c) above.
 - d) The duty of the City Manager or City Engineer to conduct construction review of the Contractor's performance is not intended to include review of the adequacy of the Contractor's safety measures, in, or near the construction site.

3. **CONTRACTOR'S OBLIGATION.** The Contractor shall and will, in good workmanlike manner, do and perform all work and furnish all supplies and materials, machinery, equipment, facilities and mean, except as otherwise expressly specified herein necessary or proper and complete all the work required by this contract, in a timely manner, in accordance with the provisions of this contract and said specifications and in accordance with the plans and drawings of the work (if provided with a work order) covered by this contract and any/all supplemental plans and drawings, and in accordance with the directions of the City Manager as given from time to time during the progress of the work. He shall furnish, erect, maintain, and remove such construction plant and such temporary works as may be required. He alone shall be responsible for the safety, efficiency, and adequacy of his plant, appliances, and methods, and for any damage that may result from their failure or their improper construction, maintenance, or operation. The Contractor shall observe, comply with, and be subject to all terms, conditions, requirements, and limitations of the contract and specifications; and shall do, carry on, and complete the entire work to the satisfaction of the City Manager and the City.
 - a) The Contractor shall maintain a copy of the plans (if provided with a work order) and specifications available at all times.
 - b) The Contractor shall give to the work the consistent attention necessary to facilitate the progress thereof and shall provide a competent superintendent on the work at all times who is fully authorized as his agent on the work. The superintendent shall be capable of thoroughly understanding the plans (if provided with a work order) and specifications and shall receive and fulfill instructions from the City Manager or his authorized representative.
4. **CONSTRUCTION GRADES AND STAKES.** The City Engineer may furnish the Contractor with bench marks and control points from which all lines, grades and measurements necessary for the proper prosecution and control of the work shall be set by the Contractor. The Contractor shall satisfy himself as to the accuracy of all measurements before proceeding with the work. In the setting of batter boards the Contractor shall furnish all necessary material and labor. The Contractor shall scrupulously preserve all stakes and markings set by the City Engineer for his own use or for the Contractor's guidance. Any stakes or markings lost or destroyed by the Contractor's forces through negligence shall be replaced by the City Engineer at the Contractor's expense when so ordered by the City Manager.
5. **QUALITY OF MATERIALS AND EQUIPMENT.** Only materials and equipment conforming to the requirements of these specifications shall be used in the work. All materials and equipment furnished for the work shall be new and unused and of recent manufacture.
6. **CONSTRUCTION REVIEW.** The City Manager or his representative will review all phases of the work in progress. The Contractor shall furnish the City Manager with every reasonable facility for ascertaining whether or not the work as performed is in accordance with the requirements and intents of the plans (if provided with a work order) and specifications.

Should any work be covered or hidden prior to the approval thereof by the City Manager, it shall be uncovered for examination at the Contractor's expense.

LEGAL RELATIONS AND RESPONSIBILITY TO PUBLIC

1. **LAWS TO BE OBSERVED.** The Contractor shall at all time, observe and comply with all Federal and State Laws and local ordinances and regulations which in any manner affects the conduct of the work and shall observe and comply with all orders and decrees which exist at the present or which may be enacted later, of bodies or tribunals having jurisdiction or authority over the work.
2. **PERMITS AND LICENSES.** The Contractor shall procure all permits and licenses, pay all charges or fees, and give all notices necessary and incidental to the due and lawful prosecution of the work.
3. **PATENTED DEVICES, MATERIALS AND PROCESSES.** The Contractor shall hold and save the City and its officers, agents, servants, and employees harmless from liability of any nature or kind, including cost and expenses, for, or on account of, any patented or unpatented invention, process, article, or appliance manufactured or used in the performance of the contract, including its use by the City, unless otherwise specifically stipulated in the Contract Documents.
 - a) If the Contractor uses any design, device or materials covered by letters, patent or copyright, he shall provide for such use by suitable agreement with the owner of such patented or copyrighted design, device or material. It is mutually agreed and understood, that, with exception, the contract prices shall include all royalties or costs arising from the use of such design, device, or materials, in any way involved in the work. The Contractor and/or his sureties shall indemnify and hold harmless the City from any and all claims for infringement by reason of the use of such patented or copyrighted design, device, or materials or any trademark or copyright in connection with work agreed to be performed under this Contract, and shall indemnify the City for any costs, expenses or damages which it may be obliged to pay by reason of such infringement at any time during the prosecution of the work of after completion of the work.
4. **PUBLIC CONVENIENCE AND SAFETY.** The City's street and road system includes but is not limited to, permanent or temporary highway, street, alley, bikeway, pedestrian pathway, bridge and other road or related structures. Where the work is located in or near city streets, alleys, rights-of-way, or highways the Contractor shall store construction materials, equipment and perform the work in such a manner as will provided reasonably adequate and satisfactory convenience for the general public and residents along the work.
 - a) No street shall be closed without the permission of the City Manager. Where traffic is diverted from the work the Contractor shall provide all materials and perform all work for the construction and maintenance of all required temporary roadways and structures.

- b) Storage of materials and the work shall be arranged so that there shall be free access to all fire hydrants, valves, manholes, and other utility appurtenances.
 - c) Contractor shall take such precautionary measures in the performance of the work as will give maximum protection at all times to persons and property near the work.
5. **BARRICADES AND WARNING SIGNALS.** Where the work is located in or adjacent to any street, alley, or public place, the Contractor shall at his own expense furnish and erect such barricades, fences, and warning lights and shall provide such security guards as are required to protect persons, property and the work. Barricades shall be reflectorized so as to be visible at night. From sunset to sunrise, the Contractor shall furnish and maintain at least one (1) light at each barricade. The Contractor shall be solely responsible for all damages to the work due to failure of barricades, signs, lights, and watchmen to protect it. The Contractor's responsibility for the maintenance of barricades, signs, lights, and security guards shall not cease until the project has been finally accepted by the City.
6. **USE OF EXPLOSIVES.** Should the Contractor elect to use explosives in the prosecution of the work, the Contractor shall exercise the utmost care so as not to danger life or property, and the Contractor shall carry on such work in compliance with the applicable state and local laws and ordinances regulating the use of explosives. Where explosives are stored or kept, they shall be marked plainly, "Dangerous Explosives". When explosives are used, the Contractor shall carry adequate blasting insurance.
7. **PRIVILEGES OF THE CONTRACTOR IN STREETS, ALLEYS, AND RIGHTS-OF-WAY.** For the performance of the contract, the Contractor will be permitted to occupy such portions of the public property as will not unduly restrict traffic or endanger the public.
8. **EXISTING GAS LINES.** The Contractor shall notify Tennessee One Call (1-800-351-1111) three working days prior to any excavation.
- a) Contractor acknowledges that gas lines for the transmission or distribution of natural, manufactured, or liquefied petroleum gas are dangerous to work around and can cause serious accidents, and that accidents can be caused by direct damage to the gas main or service lines during construction or by settlement in the trenches, or settlement of structures after construction is completed. The Contractor shall take every possible precaution to minimize the hazards of working in proximity to gas lines and shall be solely responsible for any danger to them for any injury to persons or damage to property arising from or caused by his operation.
 - b) No excavation or other work shall be done by the Contractor within ten (10) feet of a high pressure gas transmission line until the owner of the gas line has been notified not less than 48 hours in advance of such work and until the gas line has been exposed sufficiently to determine its exact horizontal and vertical location. In addition, the

owner of the gas lines shall be allowed to keep a qualified representative present while any construction work that could damage such line is being done.

- c) Where work is to be done in areas served by medium and low pressure gas distribution systems, the Contractor must notify the owner of such system not less than 24 hours before such work is started and the Contractor must give such owner the opportunity to keep a representative present during this construction work, or to locate and stake out all gas lines. In such case, the Contractor shall cooperate with the representative of the owner of the gas lines as to avoid damage to them.
- d) Should any gas main or service line or other gas facility be damaged during this construction work, the following minimum precautions shall be taken by the Contractor:

Immediately notify the owner of the gas facility of the nature and location of such damage.

Stop all construction work that could cause any further damage to the gas facilities or hazards to other persons or property.

Give adequate warning to any persons or property that could be injured or damaged and take other necessary safety precautions.

Permanent repairs shall be made only by the owners of the gas facility. The inspector, or the City Manager does not have the responsibility or authority to supervise or inspect repairs to damage gas facilities.

- e) Contractor shall not construct any structure over or immediately adjacent to a gas pipeline or gas facility. Gas pipelines shall not pass-through manholes or other structures.

9. **PROTECTION AND RESTORATION OF PROPERTY.** The Contractor shall not enter upon private property for any purpose without first obtaining permission from its owner and he shall be responsible for the preservation of, and shall use every precaution necessary to prevent damage to, all trees, shrubbery, fences, bridges, culverts, pavement, driveways, sidewalks, etc. and to all water sewer, gas, telephone, and electric lines thereof, and to all other public or private property along or adjacent to the work. The Contractor shall notify the proper representative of any public service corporation, any company or individual not less than twenty four (24) hours in advance of any work which might damage or interfere with the operation of their work which might damage or injury to property of any character resulting from any act, omission, neglect, or misconduct in the manner of method of executing the work or due to his non-execution of the work or at any time due to defective work or materials.

- a) When and where any direct or indirect damage or injury is done to public or private property on account of any act, omission, neglect, or misconduct in the execution of the work or in consequence of the non-execution thereof on the part of the Contractor, the Contractor shall restore, at his expense, such property to a condition similar or equal to that existing before such damage or injury was done, by repairing, rebuilding, or otherwise restoring as may be directed, or he shall make good such damages or injury in an acceptable manner.

10. **PUBLIC UTILITIES AND PUBLIC PROPERTY TO BE CHANGED.** Where the proper accomplishment of the work requires that any property of privately owned public utilities be cut, relocated, rebuilt, or otherwise disturbed in any way, the City shall upon proper application by the Contractor, notify the utility owner to make the required changes. The Contractor prior to making application to the City, shall make all preliminary arrangement with the utility owner, including the scheduling of work. The City shall not be responsible for any delays in the accomplishment of the required changes on utility property by reason of the Contractor's failure to schedule the work properly or otherwise; and in no case shall the Contractor be allowed any claim for extension of time or additional compensation based on failure of the utility owner to make the required changes within the stipulated period of time.

11. **SERVICE CONNECTIONS.** Where service connectors or lines from water mains or sewers to the user's premises are disconnected, broken, damaged or otherwise rendered inoperative by the Contractor for any reason, the Contractor shall, at his own expense, repair or replace same and restore service to the premises at the earliest possible time.

- a) Where service connections or lines from gas mains to the user's premises are disconnected, broken, damaged or otherwise rendered inoperative by the Contractor for any reason, Contractor shall immediately notify the user to cut off all gas appliances, and shall notify the gas utility. Under no event shall the Contractor repair the service line or otherwise restore services to the premises.

12. **TEMPORARY SEWER AND DRAIN CONNECTIONS.** When existing storm or sanitary sewers are required to be taken up, moved, or rebuilt, the Contractor, at his own expense, shall provide and maintain temporary outlets and connections for all private or public drains, sewers and sewer outlets connected to or served by the sewers to be rebuilt, and where necessary, shall provide adequate pumping facilities; and shall maintain these services until such time as the permanent sewers and connections are built and in service.

13. **WATER AND ELECTRICITY.** It shall be the responsibility of the Contractor to provide and maintain at his own expense an adequate supply of water and electricity required for the work.

14. **CONTRACTOR'S AND SUBCONTRACTOR INSURANCE.** The Contractor shall provide adequate insurance to protects the Contractor, his subcontractors, the City, and the City Manager and/or his representative against damage claims which may arise out of or result from the

execution of the work whether such execution be by the Contractor, by any subcontractor, by anyone directly or indirectly employed by any of them, or by anyone for whose acts of them may be liable. In all cases, the insurance shall list the City as an additionally insured party.

- a) The Contractor shall not commence work on the project until he has obtained all insurance required under this paragraph and such insurance has been accepted by the City, nor shall the Contractor allow any subcontractor to commence work until the insurance required on the subcontractor has been obtained and accepted.
- b) All insurance policies shall include a clause which states, in effect, that the policy will not be canceled, modified, nor allowed to expire until ten (10) days written notice has been received by the City prior to such cancellation, modification, or expiration.
- c) The Contractor shall furnish the City a certificate or certificates of insurance issued by an insurance company duly licensed to engage in the business of insurance in the state where the work is located as evidence that the required insurance policies have been procured and are in force.
- d) The Contractor shall procure and maintain during the life on the contract the following insurance:
 - i. Comprehensive General Liability with policy limits of not less than One Million Dollars (\$1,000,000.00) for each occurrence and in the aggregate for bodily injury and property damage;
 - ii. Automobile Liability covering owned and rented vehicles operated by the Contractor with policy limits of not less than One Million Dollars (\$1,000,000.00) combined single limit and aggregate for bodily injury and property damage;
 - iii. Worker's Compensation at statutory limits and Employers Liability with a policy limit of not less than Five Hundred Thousand Dollars (\$500,000.00) per claim and in the aggregate; and
 - iv. Builders Risk Insurance, where applicable, as will protect the Contractor and City from loss or damage while the projects under construction and prior to full acceptance thereof by the City. The policies shall be payable to the Contractor and to the Contract specifications, the project(s) covered by the contract, and the Contractor and his Surety shall be obligated for full performance of the Contractor's undertaking.

The Contractor may use umbrella or excess liability insurance to achieve the required coverage for Comprehensive General Liability and Automobile Liability, provided that such umbrella or excess insurance results in the same type of coverage as required for the individual policies.

The Contractor shall provide to the City certificates of insurance evidencing compliance with the requirements of this section. The certificates will show the City as an additional insured on the Comprehensive General Liability, Automobile Liability, and umbrella or excess insurance policies and contain a waiver of subrogation clause in favor of the City.

15. **LIABILITY FOR CLAIMS (CONTRACTUAL INDEMNITY).** In addition to the requirements to procure and maintain the insurance specified above, the Contractor, also, to the fullest extent permitted by law, hereby specifically and distinctly agrees to indemnify, defend, and hold harmless the City or any of its employees, officers or agents, the City Manager as he may act under the Contract, from all suits, actions, legal proceedings, claims, demands, costs, expenses, and attorney's fees (each a "Claim") and, from all expense in defending Claims, including without limitation court cost, attorney's fees, the amount of any judgments recovered, and any other expenses resulting from Claims for bodily injury, sickness or disease, including death resulting therefrom, sustained by any person and/or resulting from Claims for injury to or destruction of property, including loss or use thereof, caused by arising from, incident to, connected with or growing out of the performance of the contract, including without limitations, the act or omission of the Contractor and his agents, servants, or employees, and/or by any subcontractor and his agents, servants or employees.
16. **CONTRACTOR'S RESPONSIBILITY FOR THE WORK.** Until acceptance by the City Manager, or by any of his duly authorized representatives, as provided in these specifications, the work shall be under the charge and care of the Contractor and he shall take every necessary precaution to prevent injury or damage to the work or any part thereof by the action of the elements or from any other cause whatsoever whether arising from the execution or from the non-execution of the work. The Contractor shall rebuild, repair, restore, and make good, at his own expense, all injuries or damage to any portion of the work occasioned by any of the forenamed causes before acceptance.
17. **NO WAIVER OF LEGAL RIGHTS.** Construction review by the City Manager, or by any of his duly authorized representatives, any order, measurement or certificate by the City Manager, any order by the City for payment of money, any payment for, or acceptance of, any work or any extension of time or possession taken by the City, shall not operate as a waiver of any provisions of the Contract or any power therein reserved to the City or any rights of damages therein provided. Any waiver of any breach of contract shall not be held to be a waiver of any other or subsequent breach.
18. **SUBCONTRACT AND ASSIGNMENTS.** The Contractor may utilize the services of specialty subcontractors on those parts of the work that, under normal contracting practices, are performed by specialty subcontractors.
 - a) The Contractor shall not award any work to any subcontractor without prior written approval of the City, which approval will not be given until the Contractor submits to the City a written statement concerning the proposed award to the subcontractor, which

statement shall contain such information as the City may require. All subcontractors shall carry insurance as specified above.

- b) The Contractor shall be fully responsible to the City for the acts and omissions of his subcontractors, and of persons either directly or indirectly employed by them, as he is for the acts and omissions of persons directly employed by him.
- c) The Contractor shall cause appropriate provisions to be inserted in all subcontracts relative to the work to bind subcontractors to the Contractor by the terms of the General Conditions and other Contract Documents insofar as applicable to the Work of Subcontractors and to give the Contractor the same power as regards terminating any subcontract that the City may exercise over the Contractor under any provision of the Contract Documents.
- d) Nothing contained in this Contract shall create any contractual relation between and subcontractor and the City.
- e) The Contractor shall not assign the whole or any part of this Contract or any moneys due or to become due hereunder without written consent of the City. In case the Contractor assigns all or any part of any moneys due or to become due under this Contract, the instrument of assignment shall contain a clause substantially to the effect that it is agreed that the right of the assignee in and to any moneys due or to become due to the Contractor shall be subject to prior liens of all persons, firms and corporations for services rendered or materials supplied for the performance of the work called for in this contract.

19. **CONSTRUCTION SCHEDULE.** Contractor shall not commence performance of Services prior to 7:00 AM, nor extend past sundown, except as directed by the City Manager. All work shall be completed in a timely manner within the specified time frame given by the City Manager for each work order. Delays deemed unacceptable by the City shall be grounds for termination of this Contract.

20. **PROSECUTION OF WORK.** The Contractor shall continually and diligently prosecute the work in such order and manner, and with an ample force of men and equipment that will accomplish the work in as safe and workmanlike manner.

21. **CHARACTER OF WORKERS AND EQUIPMENT.** The Contractor shall comply with all federal, state and local laws, regulations and ordinances governing the employment of labor and the payment of wages thereto for work performed under this Contract. In general, the Contractor shall give preference to qualified local residents but in no case shall he employ any person whose age or physician condition is such as to make his employment dangerous to the health or safety of himself or of others employed on the work.

- a) All workers shall have sufficient skill and experience to properly perform the work assigned to them. On any special or skilled work or in any trade, only qualified careful and efficient mechanics shall be used.
- b) Any employee of the Contractor who may be adjudged by the City to be incompetent, untrustworthy or otherwise undesirable shall be removed from the work immediately upon request of the City and shall not be re-employed on the work thereafter.
- c) The Contractor shall furnish such equipment as is considered necessary for the prosecution of the work in an acceptable manner and at a satisfactory rate of progress.

TECHNICAL SPECIFICATIONS

1. **ROADWAY SPECIFICATIONS.** Unless otherwise noted, all aspects of this project shall be constructed in accordance with, and all materials shall be in compliance with, the current edition of the Tennessee Department of Transportation “Standard Specifications for Road and Bridge Construction,” including all revisions and special provisions. Unless otherwise noted in a Work Order or this Contract, all aspects of this project shall be constructed in accordance with TDOT Standard Drawings, found at the following internet link:

<https://www.tn.gov/tdot/roadway-design/standard-drawings-library.html>

2. **EROSION CONTROL SPECIFICATIONS.** Unless otherwise noted, all work orders containing erosion/sediment control components, water quality components, ditch linings, etc., shall be constructed in accordance with the latest edition of the Tennessee Department of Environment and Conservation Erosion and Sediment Control Handbook.

CITY OF FOREST HILLS DAVIDSON COUNTY, TENNESSEE

2021-2022 PROJECTS

FY 2021 - 2022

(PW 2021-04)

INDEX OF SHEETS

1. LOCATION MAP
2. GENERAL NOTES AND ESTIMATED QUANTITIES
3. TARA DRIVE SPEED HUMPS (1 OF 4)
4. TARA DRIVE SPEED HUMPS (2 OF 4)
5. TARA DRIVE SPEED HUMPS (3 OF 4)
6. TARA DRIVE SPEED HUMPS (4 OF 4)
7. PAVEMENT MARKINGS
8. SIGN LAYOUT SHEET

UTILITY CONTACTS

WATER SERVICE

METRO WATER SERVICES
AND SEWER DEPARTMENT
1600 2ND. AVE. NORTH
NASHVILLE, TN. 37208
(615)-862-4578

CABLE

COMCAST CABLE COMPANY
ENGINEERING DEPARTMENT
660 MAINSTREAM DRIVE
NASHVILLE, TN. 37228
(615)-244-7462

GAS

PIEDMONT NATURAL GAS
83 CENTURY BLVD.
NASHVILLE, TN. 37214
(615)-872-8034

ELECTRICITY

NASHVILLE ELECTRIC
SERVICE
1214 CHURCH STREET
NASHVILLE, TN 37246
(615)-747-3282

TELEPHONE

AT&T
333 COMMERCE STREET
ELEVENTH FLOOR NORTH
NASHVILLE, TN. 37201
(615)-214-4850

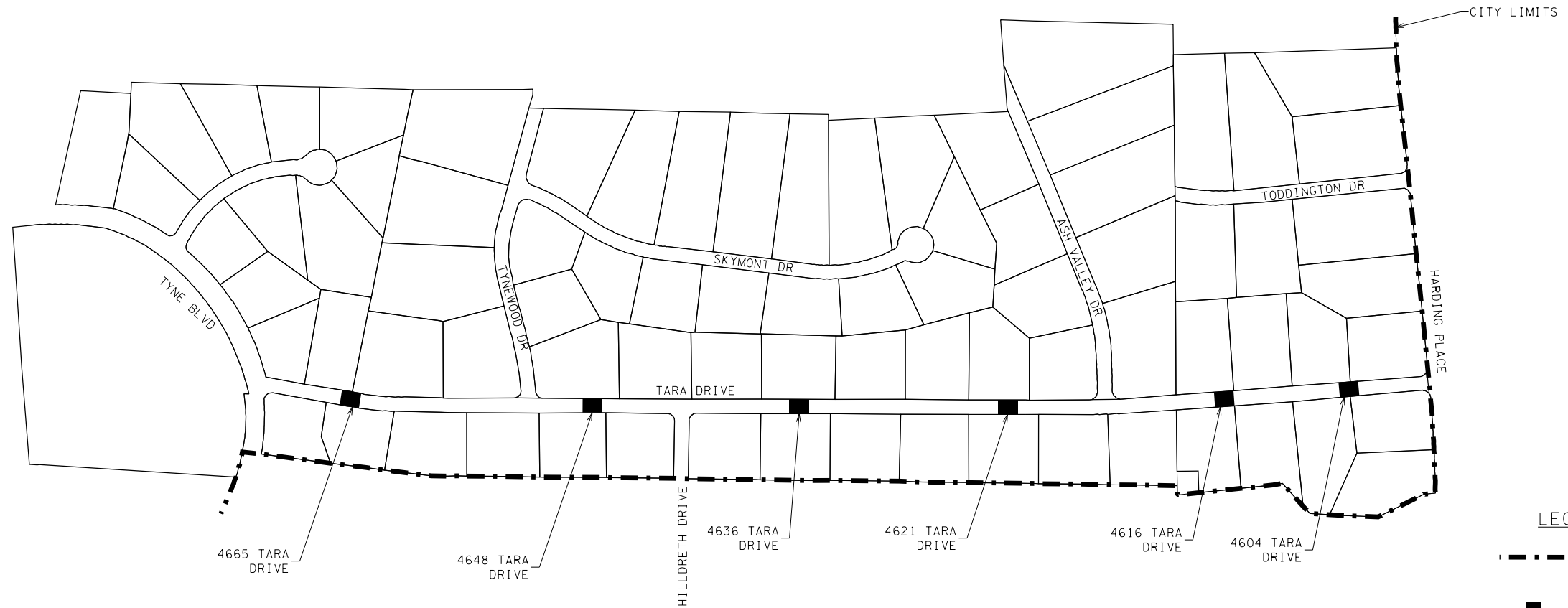

LEGEND:

- FOREST HILLS CITY LIMITS
- PROPOSED SPEED HUMP

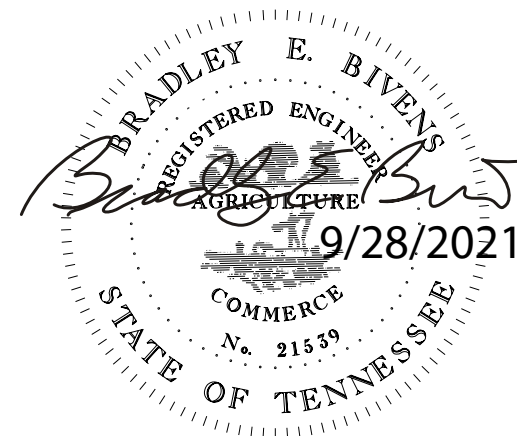

LOCATION MAP

CITY OF FOREST HILLS
DAVIDSON COUNTY, TENNESSEE

DSGN:	BEB	6/30/2020	REVISIONS
DRWN:	JGC	7/31/2020	
CHKD:	BEB	8/4/2020	
SCALE:	NO SCALE		
PROJ. NO:	14615.004		

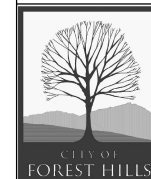

NEEL-SCHAFFER
Solutions you can build upon

DRAWING NO.
1



IF YOU DIG TENNESSEE
CALL US FIRST!
811
(1-800-351-1111)
IT'S THE LAW

PROJECT QUANTITIES			
ITEM NO.	DESCRIPTION	QUANTITY	UNIT
403-02.01	TRACKLESS TACK COAT	0.13	TONS
712-01	TRAFFIC CONTROL	1	L.S.
713-13.02	FLAT SHEET ALUMINUM SIGNS (0.080" THICK)	82	S.F.
716-02.01	4" PLASTIC PVMT MARKING LINE	16,200	L.F.
716-02.05	PLASTIC PAVEMENT MARKING LINE (STOP LINE)	40	L.F.
717-01	MOBILIZATION	1	L.S.
SP-1	MILLING @ EXISTING STREETS & DRIVEWAYS	300	L.F.
SP-2	SPEED HUMP INSTALLATION	6	EACH
SP-3	PLASTIC PAVEMENT MARKING (SPEED HUMP/TABLE)	12	EACH
SP-4	STEEL SIGN POLE (TRAFFIC SIGN)	13	EACH
SP-5	SIGN AND SIGN POST REMOVAL	6	EACH

- ① ITEM INCLUDES 8,100 LF OF SSWL AND 8,100 LF OF DSYL
- ② ITEM INCLUDES ALL HARDWARE, EQUIPMENT, LABOR AND COST TO ERECT AND CONSTRUCT SIGN POLE.
- ③ ITEM INCLUDES REMOVAL OF SIGN AND SIGN POST OF MISCELLANEOUS TRAFFIC CALMING SIGNS ALONG TARA DRIVE

GENERAL NOTES:

1. UNLESS OTHERWISE SPECIFIED WITHIN THIS PLAN SET, ALL MATERIAL SPECIFICATIONS, CONSTRUCTION METHODS, AND OTHER MATTERS RELATED TO THIS PROJECT SHALL CONFORM TO THE TENNESSEE DEPARTMENT OF TRANSPORTATION STANDARD SPECIFICATIONS FOR ROAD AND BRIDGE CONSTRUCTION, DATED JANUARY 1, 2021.
2. PLANS HAVE BEEN DEVELOPED WITH AS MUCH DATA AS WAS AVAILABLE FROM OUTSIDE SOURCES AND FIELD VISITS. ALL ITEMS INCLUDED AND SHOWN HERE ARE BELIEVED TO REFLECT EXISTING CONDITIONS TO A REASONABLE DEGREE OF ACCURACY. HOWEVER THE CONTRACTOR HAS FINAL RESPONSIBILITY TO VERIFY ALL EXISTING CONDITIONS, INCLUDING BUT NOT LIMITED TO UNDERGROUND UTILITIES, PROPERTY LINES, AND DRAINAGE STRUCTURES.
3. CONTRACTOR SHALL CONTACT LOCAL UTILITY OWNERS AND TENNESSEE ONE-CALL TO LOCATE ALL KNOWN UTILITIES PRIOR TO BEGINNING CONSTRUCTION.

GRADING:

4. ANY AREA THAT IS DISTURBED OUTSIDE LIMITS OF CONSTRUCTION DURING THE LIFE OF THIS PROJECT SHALL BE REPAIRED BY THE CONTRACTOR AT HIS EXPENSE.
5. CONTRACTOR SHALL BACKFILL OLD POST HOLES TO FINISHED GRADE.
6. ALL DISTURBED AREAS SHALL BE SEEDED AND MULCHED.

UTILITIES:

7. THE LOCATIONS OF UTILITIES SHOWN WITHIN THESE PLANS ARE APPROXIMATE ONLY. EXACT LOCATIONS SHALL BE DETERMINED IN THE FIELD BY CONTACTING THE UTILITY COMPANIES INVOLVED. NOTIFICATION BY CALLING THE TENNESSEE ONE-CALL SYSTEM, INC. AT 1-800-351-1111 AS REQUESTED BY TCA 65-31-106 WILL BE REQUIRED.
8. UNLESS OTHERWISE NOTED, ALL UTILITY ADJUSTMENTS WILL BE PERFORMED BY THE UTILITY OR IT'S REPRESENTATIVE. THE CONTRACTOR AND UTILITY OWNERS WILL BE REQUIRED TO COOPERATE WITH EACH OTHER IN ORDER TO EXPEDITE THE WORK REQUIRED BY THIS CONTRACT.
9. THE CONTRACTOR WILL PROVIDE ALL NECESSARY PROTECTIVE MEASURES TO SAFEGUARD EXISTING UTILITIES FROM DAMAGE DURING CONSTRUCTION OF THIS PROJECT. IN THE EVENT THAT SPECIAL EQUIPMENT IS REQUIRED TO WORK OVER AND AROUND THE UTILITIES, THE CONTRACTOR WILL BE REQUIRED TO FURNISH SUCH EQUIPMENT. THE COST OF PROTECTING UTILITIES FROM DAMAGE AND FURNISHING SPECIAL EQUIPMENT WILL BE INCLUDED IN THE BID PRICE FOR OTHER ITEMS OF CONSTRUCTION.

MISCELLANEOUS NOTE:

10. NOTHING IN THE GENERAL NOTES OR SPECIAL PROVISIONS SHALL RELIEVE THE CONTRACTOR FROM HIS RESPONSIBILITIES TOWARD THE SAFETY AND CONVENIENCE OF THE GENERAL PUBLIC AND THE RESIDENTS ALONG THE PROPOSED CONSTRUCTION AREA.

CONSTRUCTION WORK ZONE AND TRAFFIC

CONTROL NOTES:

11. ADVANCE WARNING SIGNS SHALL NOT BE DISPLAYED MORE THAN FORTY EIGHT (48) HOURS BEFORE PHYSICAL CONSTRUCTION BEGINS. SIGNS MAY BE ERECTED UP TO ONE WEEK BEFORE NEEDED, IF THE SIGN FACE IS FULLY COVERED.
12. THE PROPOSED LOCATIONS OF ALL PERMANENT SIGNING SHALL BE MARKED IN THE FIELD WITH STAKES PRIOR TO INSTALLATION FOR APPROVAL BY THE ENGINEER.
13. IF THE CONTRACTOR MOVES OFF THE PROJECT, HE SHALL COVER OR REMOVE ALL UNNEEDED SIGNS AS DIRECTED BY THE ENGINEER. COST OF REMOVAL, COVERING, AND REINSTALLING SIGNS SHALL NOT BE MEASURED AND PAID FOR SEPARATELY, BUT ALL COSTS SHALL BE INCLUDED IN THE ORIGINAL UNIT PRICE BID FOR OTHER ITEMS.
14. LONG TERM BUT SPORADIC USE WARNING SIGN, SUCH AS FLAGGER SIGN, MAY REMAIN IN PLACE WHEN NOT REQUIRED PROVIDED THE SIGN FACE IS FULLY COVERED.
15. TRAFFIC CONTROL DEVICES SHALL NOT BE DISPLAYED OR ERECTED UNLESS RELATED CONDITIONS ARE PRESENT NECESSITATING WARNING.
16. ALL DETOUR AND CONSTRUCTION SIGNING SHALL BE IN STRICT ACCORDANCE WITH THE MANUAL ON UNIFORM TRAFFIC CONTROL DEVICES.
17. ALL EXCAVATED AREAS OUTSIDE OF THE ROAD CLOSURE SHALL BE REPAIRED WITH ASPHALT BY THE END OF THE SAME DAY.
18. CONTRACTOR SHALL USE FLAGGERS AND SIGNING DURING ALL CONSTRUCTION OUTSIDE OF THE ROAD CLOSURE.
19. THE CONTRACTOR SHALL DEVELOP CONSTRUCTION STAGING AND TRAFFIC CONTROL PLANS TO BE APPROVED BY THE CITY BEFORE WORK HAS BEGUN.
20. ALL SIGNS SHALL MEET THE REQUIREMENTS OF THE TDOT STANDARD SPECIFICATIONS.

SPECIAL NOTES

21. FINAL PLACEMENT OF INSTALLATION OF SIGNS SHALL FOLLOW THE CURRENT MANUAL ON UNIFORM TRAFFIC CONTROL DEVICES (MUTCD) MOUNTING AND SPACING REQUIREMENTS.
22. REFER TO TDOT STANDARD DRAWINGS T-S-19 AND T-S-20 FOR MOUNTING HEIGHT, PLACEMENT AND LATERAL CLEARANCE REQUIREMENTS.
23. MATERIAL AND INSTALLATION REQUIREMENTS FOR POST SUPPORTS SHALL FOLLOW TDOT STANDARD DRAWINGS, NOTES, AND SPECIFICATION. ALTERNATIVE BREAK AWAY TYPE POST THAT MEETS NCHRP-350 REQUIREMENTS MAY BE PERMITTED WITH PRIOR APPROVAL FROM THE CITY ENGINEER.
24. ALL SIGNS MARKED TO BE REMOVED ARE TO BE REMOVED BY THE CONTRACTOR AND BECOME PROPERTY OF THE CONTRACTOR.



IF YOU DIG TENNESSEE
CALL US FIRST!
811
(1-800-351-1111)
IT'S THE LAW

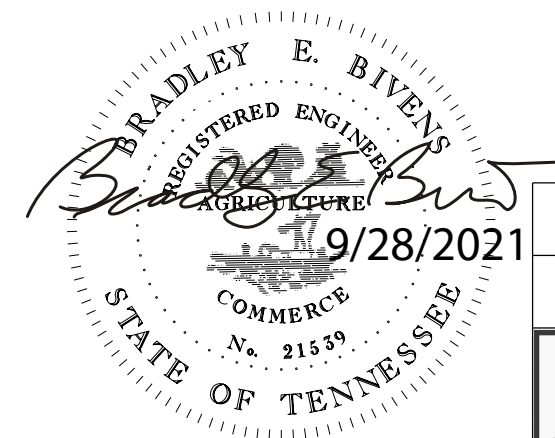

GENERAL NOTES AND QUANTITIES			
CITY OF FOREST HILLS DAVIDSON COUNTY, TENNESSEE			
DSGN: KDF	08/27/21	REVISIONS	
DRWN: KDF	08/27/21		
CHKD: BEB	09/01/21		
SCALE: N.T.S.			
PROJ. NO: 14615.004			
 NEEL-SCHAFFER Solutions you can build upon			DRAWING NO. 2

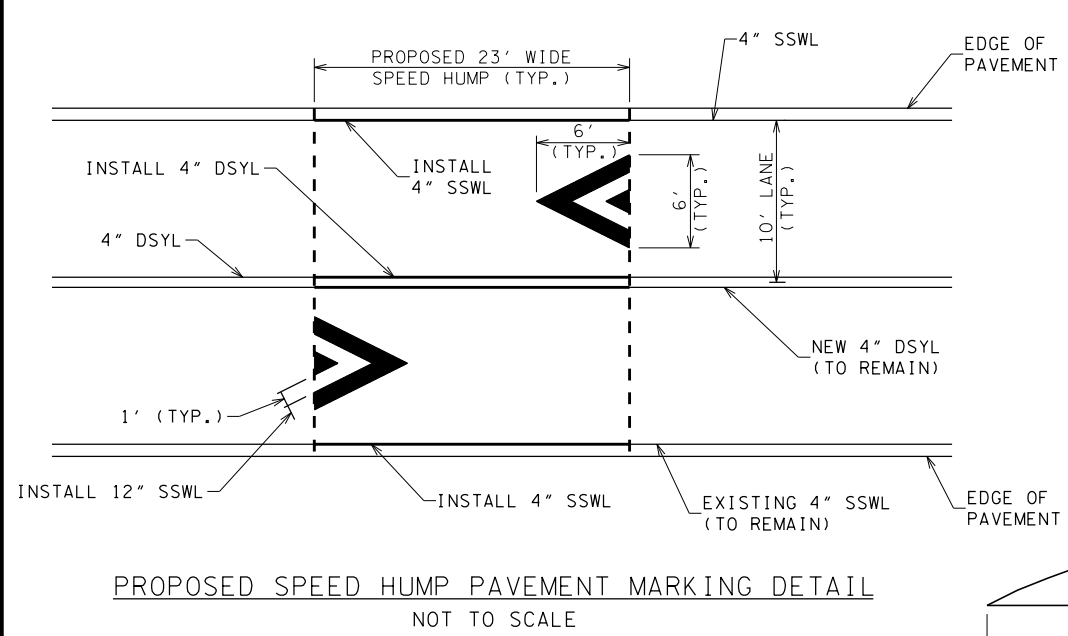
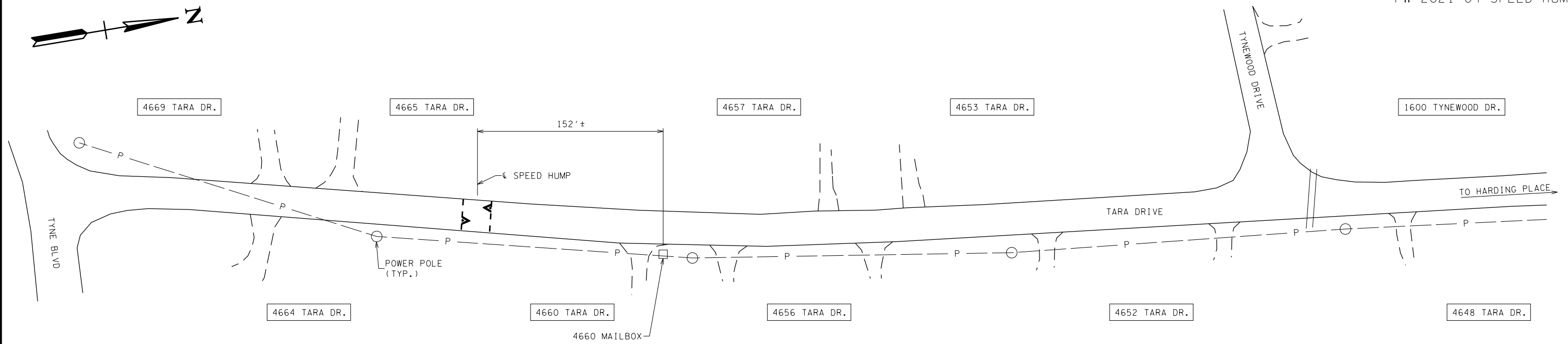
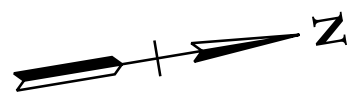

NOTE:
 SSWL: SINGLE SOLID WHITE LINE
 DSYL: DOUBLE SOLID YELLOW LINE

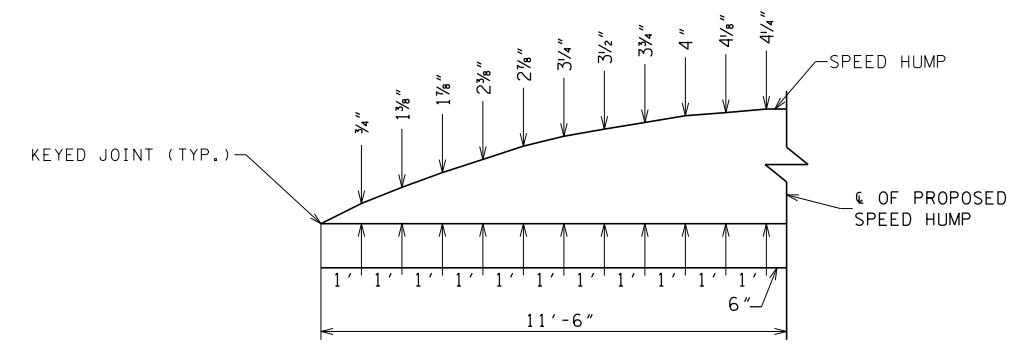

MODIFICATION DETAIL
 NOT TO SCALE
 NOTE: 1/8"± TOLERANCE FOR
 SPEED HUMP HEIGHT DIMENSIONS

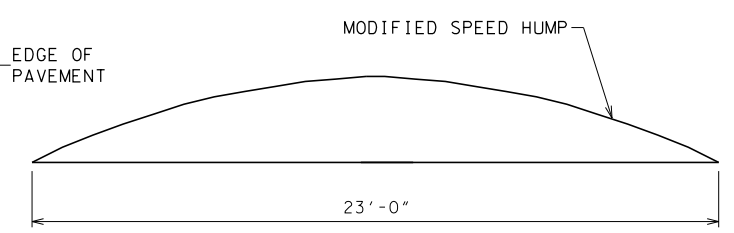

GENERAL NOTES:

1. THE CONTRACTOR SHALL FURNISH ALL MATERIAL, LABOR, AND TRAFFIC CONTROL REQUIRED TO ACCOMPLISH THE WORK AS SHOWN ON THIS SHEET.
2. CONSTRUCTION AND INSTALLATION PROCEDURES SHALL COMPLY WITH THE TENNESSEE DEPARTMENT OF TRANSPORTATION STANDARDS FOR ROAD CONSTRUCTION.
3. ALL MATERIALS AND WORKMANSHIP SHALL BE IN ACCORDANCE WITH THE CITY ENGINEER.
4. THE CONTRACTOR SHALL DEVELOP A TEMPLATE USING THE DIMENSIONS PROVIDED IN THE MODIFICATION DETAIL ON THIS SHEET. THE TEMPLATE WILL BE APPROVED BY THE CITY ENGINEER PRIOR TO CONSTRUCTION.
5. ALL PAVEMENT MARKING INSTALLATION PROCEDURES AND EQUIPMENT SHALL MEET THE SPECIFICATIONS OF THE MANUAL ON UNIFORM TRAFFIC CONTROL DEVICES (MUTCD).
6. ALL TRAFFIC CONTROL DURING INSTALLATION SHALL BE IN STRICT ACCORDANCE WITH THE CURRENT EDITION OF THE MUTCD.
7. ALL PAVEMENT MARKINGS SHALL BE OF A THERMOPLASTIC MATERIAL AND DIMENSIONS DETAILED ON THIS SHEET.
8. THE CONTRACTOR SHALL VERIFY ALL DIMENSIONS BEFORE PROCEEDING WITH THE WORK. ANY ERRORS SHALL BE RESOLVED PRIOR TO CONSTRUCTION.
9. ANY DAMAGE TO THE EXISTING ROADWAY OR ROADSIDE DURING CONSTRUCTION OF THE PROJECT SHALL BE REPAIRED AT THE CONTRACTOR'S EXPENSE.



**IF YOU DIG TENNESSEE
 CALL US FIRST!
 811
 (1-800-351-1111)
 IT'S THE LAW**

TARA DRIVE SPEED HUMP QUANTITIES			
ITEM NO.	DESCRIPTION	UNIT	QUANTITY
SP-1	MILLING AT EXISTING STREETS AND DRIVEWAYS	L.F.	50
① SP-2	SPEED HUMP INSTALLATION	EACH	1
SP-3	PLASTIC PAVEMENT MARKING (SPEED HUMP/TABLE)	EACH	2

① ITEM INCLUDES 10.5 TONS OF ASPHALT

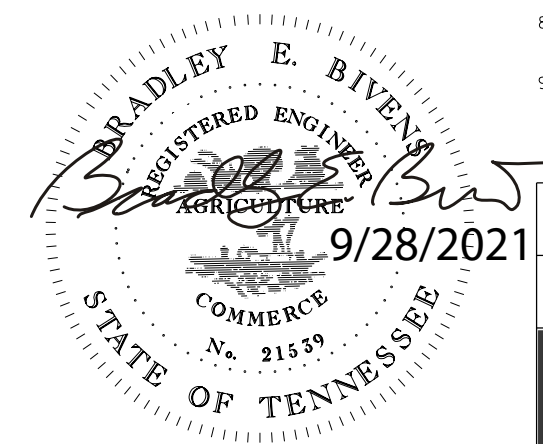

TARA DRIVE SPEED HUMPS (1 OF 4)

CITY OF FOREST HILLS
 DAVIDSON COUNTY, TENNESSEE

DSGN:	KDF	08/27/21	REVISIONS
DRWN:	KDF	08/27/21	
CHKD:	BEB	09/01/21	
SCALE:	N.T.S.		
PROJ. NO.:	14615.004		

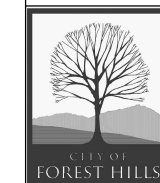

NEEL-SCHAFFER
 Solutions you can build upon

DRAWING NO.
3

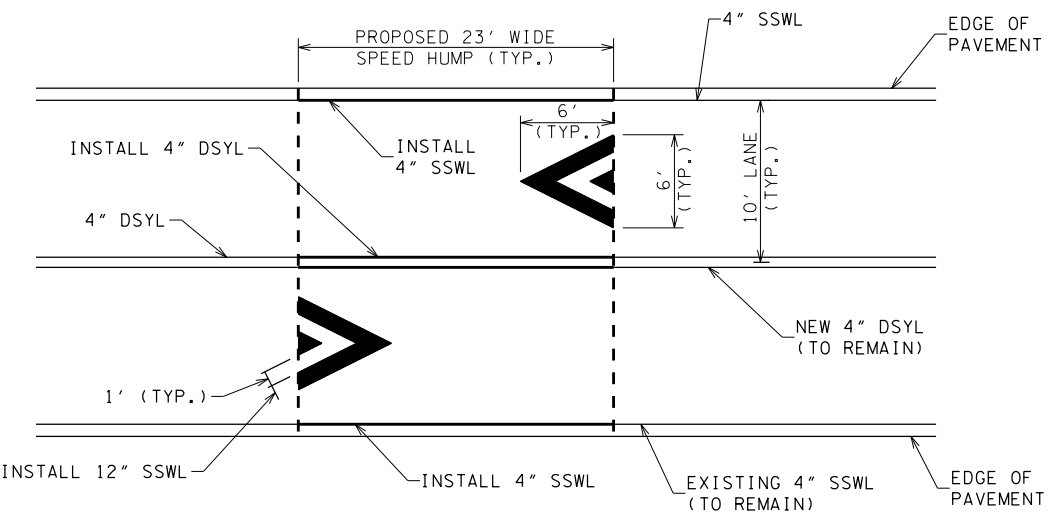
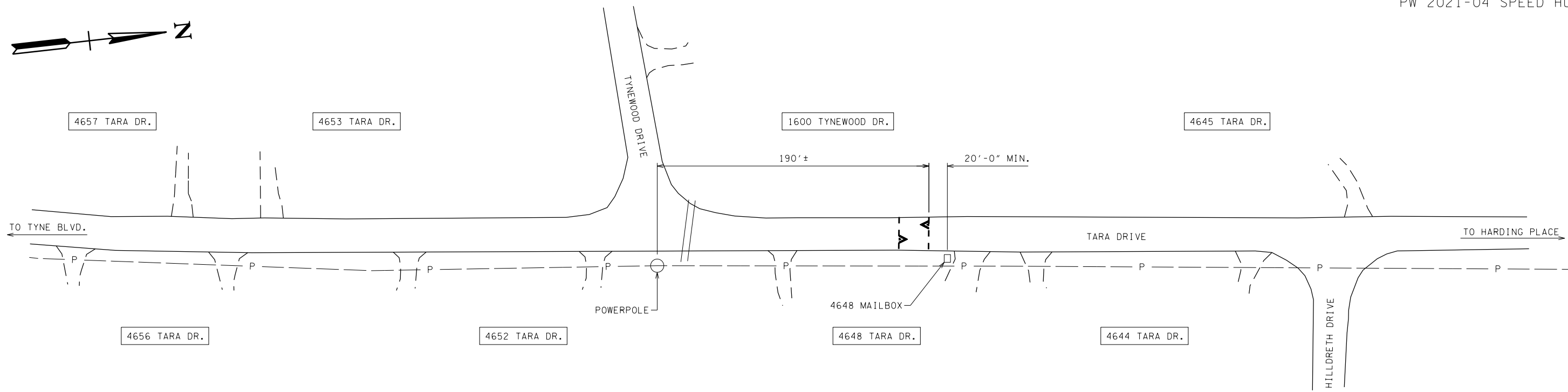
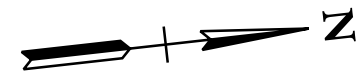

PROPOSED SPEED HUMP PAVEMENT MARKING DETAIL
NOT TO SCALE

NOTE:
SSWL: SINGLE SOLID WHITE LINE
DSYL: DOUBLE SOLID YELLOW LINE

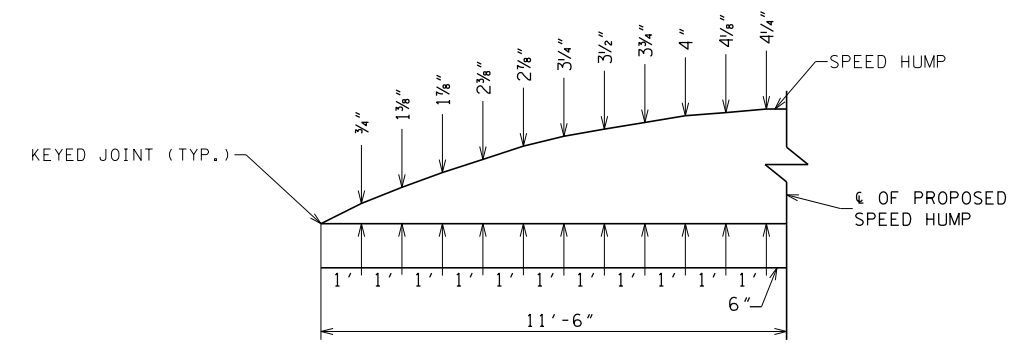

MODIFICATION DETAIL
NOT TO SCALE

NOTE: 1/8" ± TOLERANCE FOR
SPEED HUMP HEIGHT DIMENSIONS

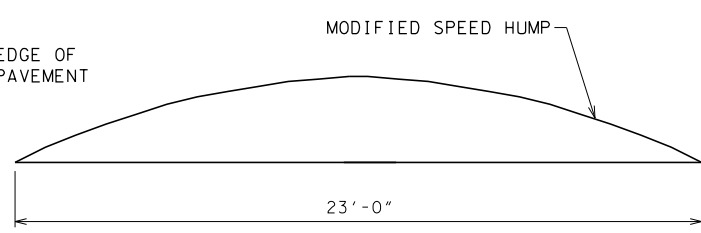

TYPICAL SPEED HUMP CROSS SECTION
NOT TO SCALE

GENERAL NOTES:

1. THE CONTRACTOR SHALL FURNISH ALL MATERIAL, LABOR, AND TRAFFIC CONTROL REQUIRED TO ACCOMPLISH THE WORK AS SHOWN ON THIS SHEET.
2. CONSTRUCTION AND INSTALLATION PROCEDURES SHALL COMPLY WITH THE TENNESSEE DEPARTMENT OF TRANSPORTATION STANDARDS FOR ROAD CONSTRUCTION.
3. ALL MATERIALS AND WORKMANSHIP SHALL BE IN ACCORDANCE WITH THE CITY ENGINEER.
4. THE CONTRACTOR SHALL DEVELOP A TEMPLATE USING THE DIMENSIONS PROVIDED IN THE MODIFICATION DETAIL ON THIS SHEET. THE TEMPLATE WILL BE APPROVED BY THE CITY ENGINEER PRIOR TO CONSTRUCTION.
5. ALL PAVEMENT MARKING INSTALLATION PROCEDURES AND EQUIPMENT SHALL MEET THE SPECIFICATIONS OF THE MANUAL ON UNIFORM TRAFFIC CONTROL DEVICES (MUTCD).
6. ALL TRAFFIC CONTROL DURING INSTALLATION SHALL BE IN STRICT ACCORDANCE WITH THE CURRENT EDITION OF THE MUTCD.
7. ALL PAVEMENT MARKINGS SHALL BE OF A THERMOPLASTIC MATERIAL AND DIMENSIONS DETAILED ON THIS SHEET.
8. THE CONTRACTOR SHALL VERIFY ALL DIMENSIONS BEFORE PROCEEDING WITH THE WORK. ANY ERRORS SHALL BE RESOLVED PRIOR TO CONSTRUCTION.
9. ANY DAMAGE TO THE EXISTING ROADWAY OR ROADSIDE DURING CONSTRUCTION OF THE PROJECT SHALL BE REPAIRED AT THE CONTRACTOR'S EXPENSE.



IF YOU DIG TENNESSEE
CALL US FIRST!
811
(1-800-351-1111)
IT'S THE LAW

TARA DRIVE SPEED HUMP QUANTITIES			
ITEM NO.	DESCRIPTION	UNIT	QUANTITY
SP-1	MILLING AT EXISTING STREETS AND DRIVEWAYS	L.F.	50
① SP-2	SPEED HUMP INSTALLATION	EACH	1
SP-3	PLASTIC PAVEMENT MARKING (SPEED HUMP/TABLE)	EACH	2

① ITEM INCLUDES 10.5 TONS OF ASPHALT

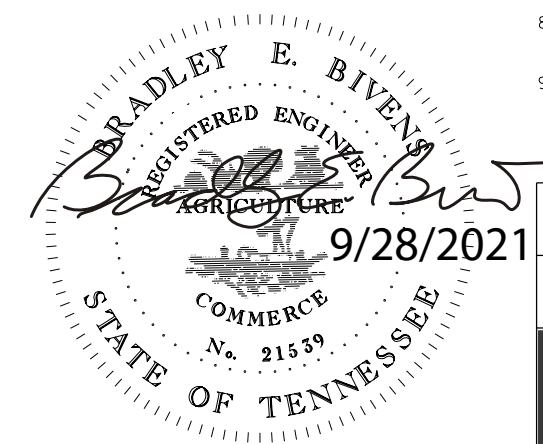

TARA DRIVE SPEED HUMPS (2 OF 4)

CITY OF FOREST HILLS
DAVIDSON COUNTY, TENNESSEE

DSGN:	KDF	08/27/21	REVISIONS
DRWN:	KDF	08/28/21	
CHKD:	BEB	09/02/21	
SCALE:	N.T.S.		
PROJ. NO.:	14615.004		

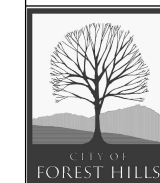

NEEL-SCHAFFER
Solutions you can build upon

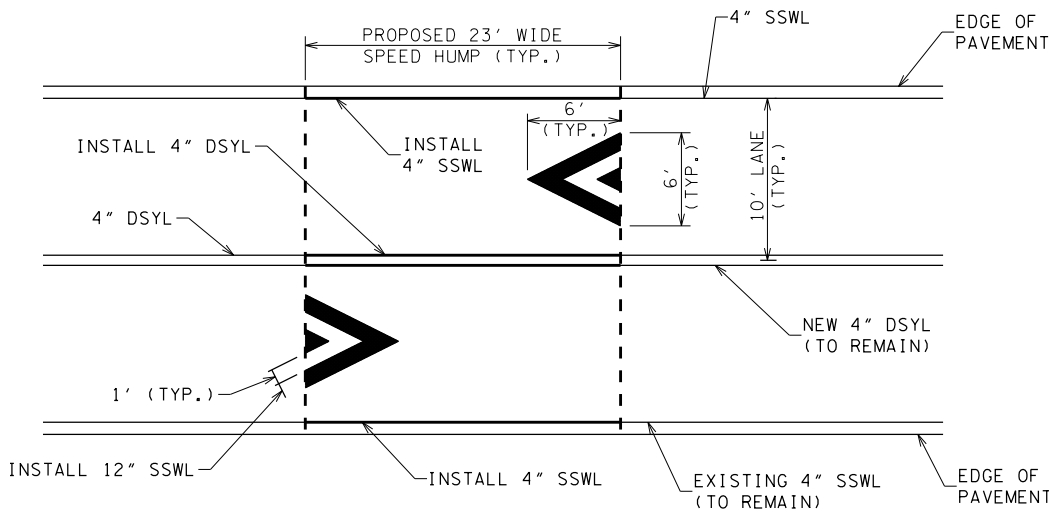
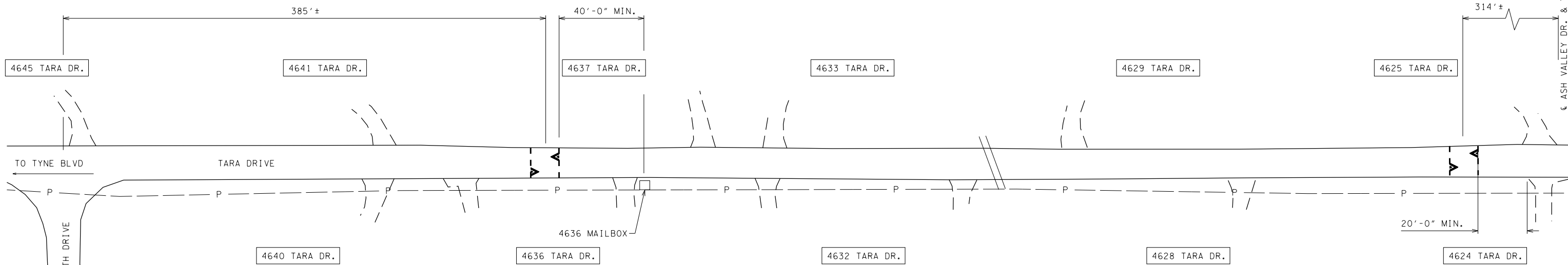

PROPOSED SPEED HUMP PAVEMENT MARKING DETAIL
NOT TO SCALE

NOTE:
SSWL: SINGLE SOLID WHITE LINE
DSYL: DOUBLE SOLID YELLOW LINE

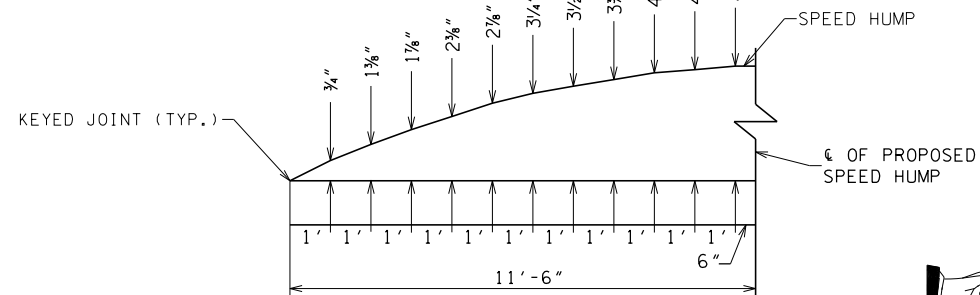

MODIFICATION DETAIL

NOT TO SCALE

NOTE: 1/8\"/>

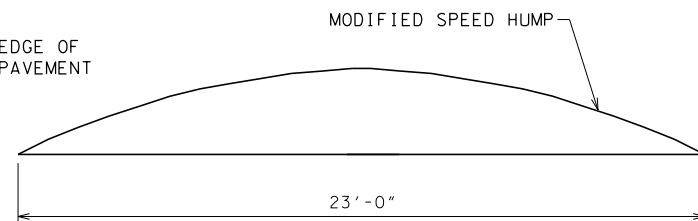

TYPICAL SPEED HUMP CROSS SECTION
NOT TO SCALE

GENERAL NOTES:

1. THE CONTRACTOR SHALL FURNISH ALL MATERIAL, LABOR, AND TRAFFIC CONTROL REQUIRED TO ACCOMPLISH THE WORK AS SHOWN ON THIS SHEET.
2. CONSTRUCTION AND INSTALLATION PROCEDURES SHALL COMPLY WITH THE TENNESSEE DEPARTMENT OF TRANSPORTATION STANDARDS FOR ROAD CONSTRUCTION.
3. ALL MATERIALS AND WORKMANSHIP SHALL BE IN ACCORDANCE WITH THE CITY ENGINEER.
4. THE CONTRACTOR SHALL DEVELOP A TEMPLATE USING THE DIMENSIONS PROVIDED IN THE MODIFICATION DETAIL ON THIS SHEET. THE TEMPLATE WILL BE APPROVED BY THE CITY ENGINEER PRIOR TO CONSTRUCTION.
5. ALL PAVEMENT MARKING INSTALLATION PROCEDURES AND EQUIPMENT SHALL MEET THE SPECIFICATIONS OF THE MANUAL ON UNIFORM TRAFFIC CONTROL DEVICES (MUTCD).
6. ALL TRAFFIC CONTROL DURING INSTALLATION SHALL BE IN STRICT ACCORDANCE WITH THE CURRENT EDITION OF THE MUTCD.
7. ALL PAVEMENT MARKINGS SHALL BE OF A THERMOPLASTIC MATERIAL AND DIMENSIONS DETAILED ON THIS SHEET.
8. THE CONTRACTOR SHALL VERIFY ALL DIMENSIONS BEFORE PROCEEDING WITH THE WORK. ANY ERRORS SHALL BE RESOLVED PRIOR TO CONSTRUCTION.
9. ANY DAMAGE TO THE EXISTING ROADWAY OR ROADSIDE DURING CONSTRUCTION OF THE PROJECT SHALL BE REPAIRED AT THE CONTRACTOR'S EXPENSE.



IF YOU DIG TENNESSEE
CALL US FIRST!
811
(1-800-351-1111)
IT'S THE LAW

TARA DRIVE SPEED HUMP QUANTITIES			
ITEM NO.	DESCRIPTION	UNIT	QUANTITY
SP-1	MILLING AT EXISTING STREETS AND DRIVEWAYS	L.F.	100
① SP-2	SPEED HUMP INSTALLATION	EACH	2
SP-3	PLASTIC PAVEMENT MARKING (SPEED HUMP/TABLE)	EACH	4

① ITEM INCLUDES 10.5 TONS OF ASPHALT

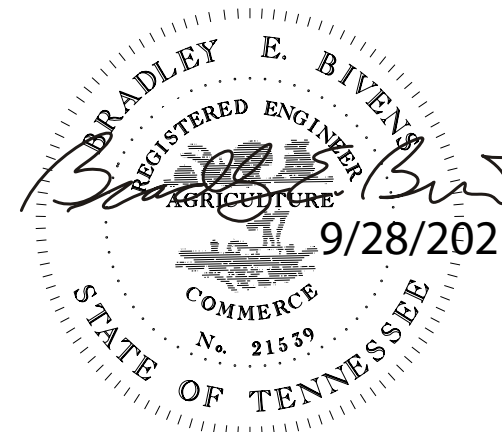

TARA DRIVE SPEED HUMPS (3 OF 4)

CITY OF FOREST HILLS
DAVIDSON COUNTY, TENNESSEE

DSGN:	KDF	08/27/21	REVISIONS
DRWN:	KDF	08/27/21	
CHKD:	BEB	09/01/21	
SCALE:	N.T.S.		
PROJ. NO.:	14615.004		

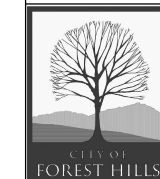

NEEL-SCHAFFER
Solutions you can build upon

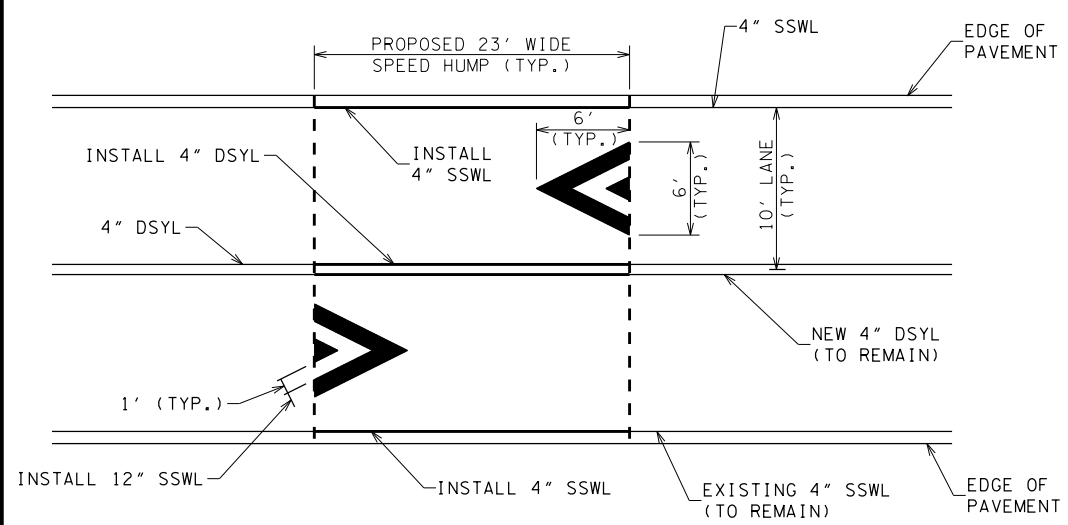
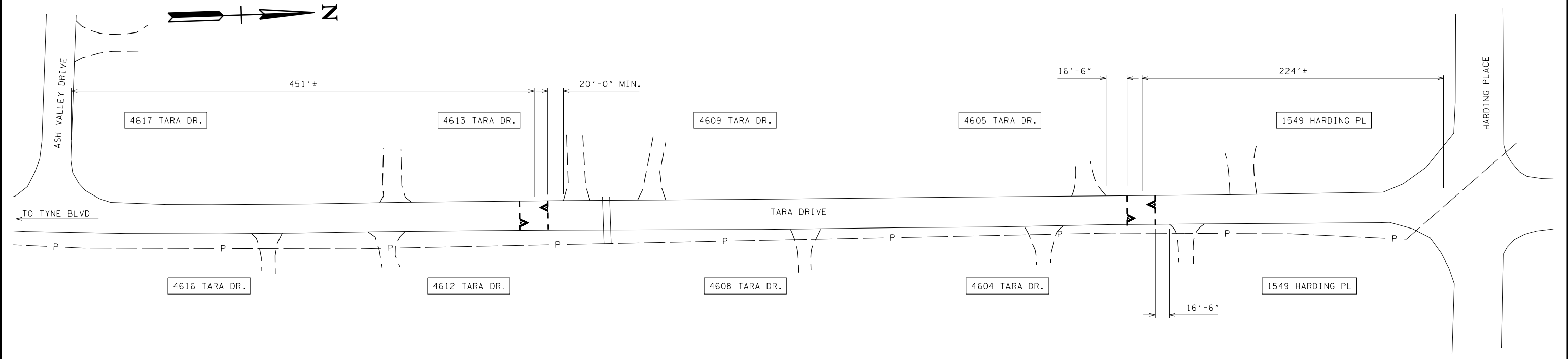

PROPOSED SPEED HUMP PAVEMENT MARKING DETAIL
NOT TO SCALE

NOTE:
SSWL: SINGLE SOLID WHITE LINE
DSYL: DOUBLE SOLID YELLOW LINE

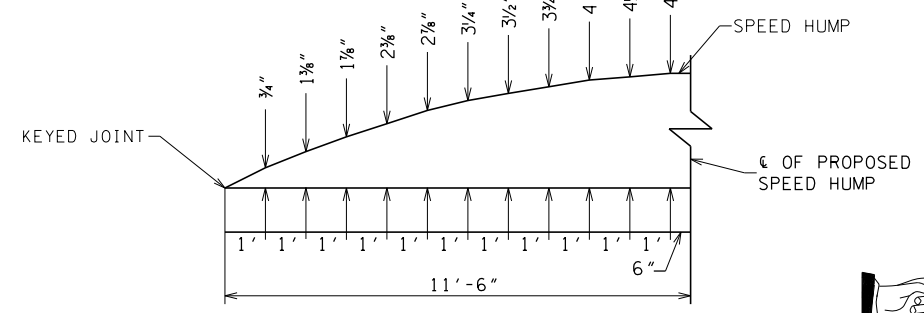

MODIFICATION DETAIL
NOT TO SCALE

NOTE: 1/8"± TOLERANCE FOR SPEED HUMP HEIGHT DIMENSIONS

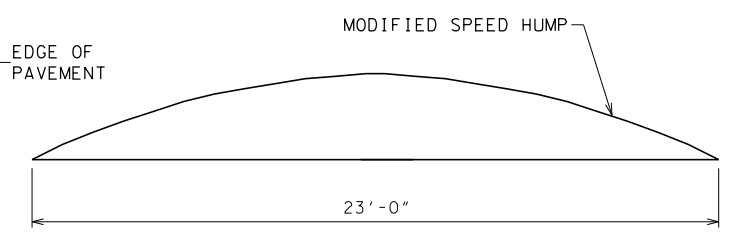

TYPICAL SPEED HUMP CROSS SECTION
NOT TO SCALE

GENERAL NOTES:

1. THE CONTRACTOR SHALL FURNISH ALL MATERIAL, LABOR, AND TRAFFIC CONTROL REQUIRED TO ACCOMPLISH THE WORK AS SHOWN ON THIS SHEET.
2. CONSTRUCTION AND INSTALLATION PROCEDURES SHALL COMPLY WITH THE TENNESSEE DEPARTMENT OF TRANSPORTATION STANDARDS FOR ROAD CONSTRUCTION.
3. ALL MATERIALS AND WORKMANSHIP SHALL BE IN ACCORDANCE WITH THE CITY ENGINEER.
4. THE CONTRACTOR SHALL DEVELOP A TEMPLATE USING THE DIMENSIONS PROVIDED IN THE MODIFICATION DETAIL ON THIS SHEET. THE TEMPLATE WILL BE APPROVED BY THE CITY ENGINEER PRIOR TO CONSTRUCTION.
5. ALL PAVEMENT MARKING INSTALLATION PROCEDURES AND EQUIPMENT SHALL MEET THE SPECIFICATIONS OF THE MANUAL ON UNIFORM TRAFFIC CONTROL DEVICES (MUTCD).
6. ALL TRAFFIC CONTROL DURING INSTALLATION SHALL BE IN STRICT ACCORDANCE WITH THE CURRENT EDITION OF THE MUTCD.
7. ALL PAVEMENT MARKINGS SHALL BE OF A THERMOPLASTIC MATERIAL AND DIMENSIONS DETAILED ON THIS SHEET.
8. THE CONTRACTOR SHALL VERIFY ALL DIMENSIONS BEFORE PROCEEDING WITH THE WORK. ANY ERRORS SHALL BE RESOLVED PRIOR TO CONSTRUCTION.
9. ANY DAMAGE TO THE EXISTING ROADWAY OR ROADSIDE DURING CONSTRUCTION OF THE PROJECT SHALL BE REPAIRED AT THE CONTRACTOR'S EXPENSE.

TARA DRIVE SPEED HUMP QUANTITIES			
ITEM NO.	DESCRIPTION	UNIT	QUANTITY
SP-1	MILLING AT EXISTING STREETS AND DRIVEWAYS	L.F.	100
① SP-2	SPEED HUMP INSTALLATION	EACH	2
SP-3	PLASTIC PAVEMENT MARKING (SPEED HUMP/TABLE)	EACH	4

① ITEM INCLUDES 10.5 TONS OF ASPHALT



TARA DRIVE SPEED HUMP (4 OF 4)

CITY OF FOREST HILLS
DAVIDSON COUNTY, TENNESSEE

DSGN:	KDF	08/27/21	REVISIONS
DRWN:	KDF	08/27/21	
CHKD:	BEB	09/21/21	
SCALE:	N.T.S.		
PROJ. NO:	14615.004		



NEEL-SCHAFFER
Solutions you can build upon



IF YOU DIG TENNESSEE
CALL US FIRST!
811
(1-800-351-1111)
IT'S THE LAW

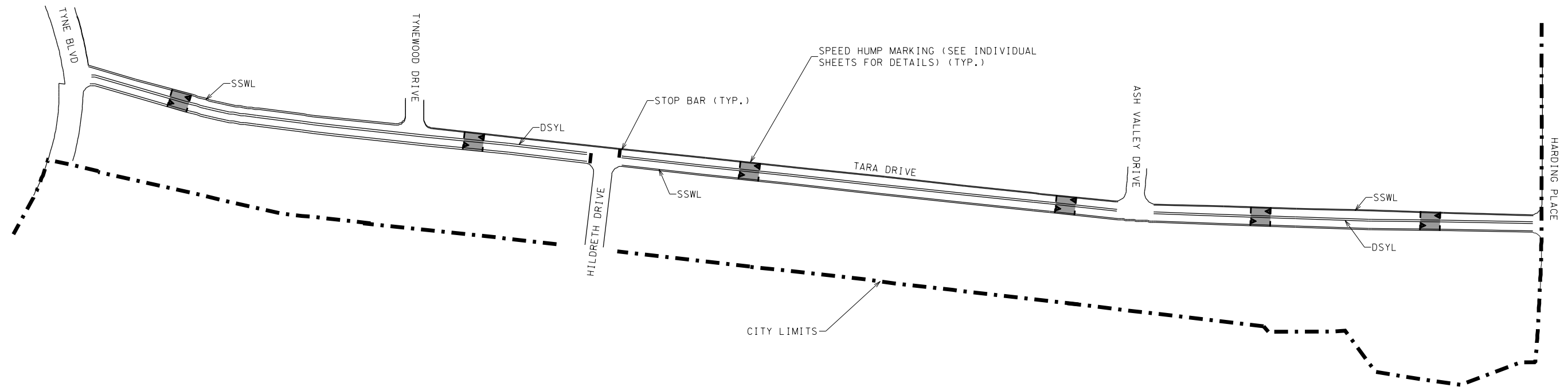
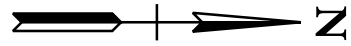

PAVEMENT MARKING QUANTITIES			
ITEM NO.	DESCRIPTION	UNIT	QUANTITY
① 716-02.01	4" PLASTIC PAVEMENT MARKING LINE (4" LINE)	L.F.	16,200
716-02.05	PLASTIC PAVEMENT MARKING LINE (STOP LINE)	L.F.	40

① ITEM INCLUDES: 8,100 LF OF DSYL, 8,100 LF OF SSWL

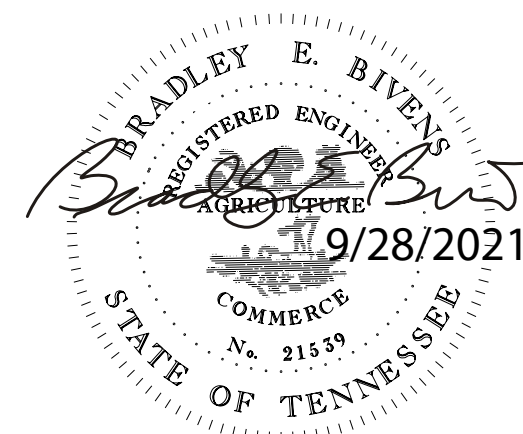

TARA DRIVE PAVEMENT MARKINGS

CITY OF FOREST HILLS
DAVIDSON COUNTY, TENNESSEE

DSGN: BEB	8/27/21	REVISIONS
DRWN: KDF	8/27/21	
CHKD: BEB	9/02/21	
SCALE: NO SCALE		
PROJ. NO: 14615.004		

DRAWING NO. 7



IF YOU DIG TENNESSEE
CALL US FIRST!
811
(1-800-351-1111)
IT'S THE LAW

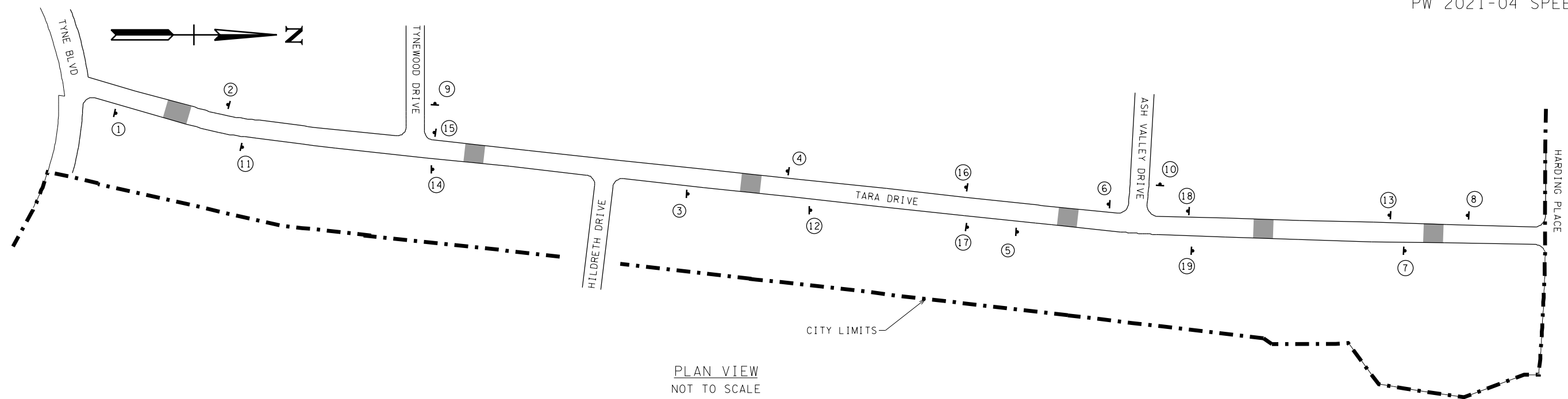

PLAN VIEW
NOT TO SCALE

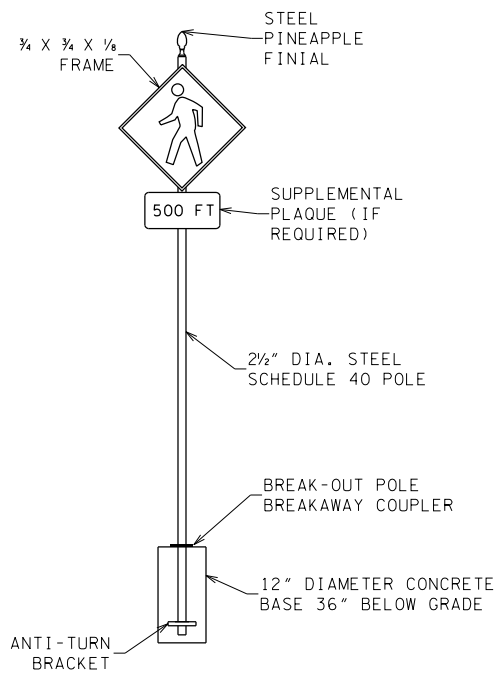

STEEL SIGN POLE
(TRAFFIC SIGN)
NOT TO SCALE

APPEARANCE	SIGN TYPE	NUMBERING	WORK TO BE DONE
	W17-1	2, 3, 4, 5, 6, 7	INSTALL NEW SIGN AND POLE
	W17-1	1, 8	INSTALL NEW SIGNS AND POLE
	W13-1P		
	W14-1	9, 10	REPLACE WITH NEW SIGN, INSTALL DECORATIVE POLE
	R2-1	11, 12, 13	REPLACE WITH NEW SIGN, INSTALL DECORATIVE POLE, REMOVE OTHER SIGNS
	N/A	14, 15, 16, 17, 18, 19	REMOVE SIGN AND POST

NOTE: ALL W17-1 SIGNS SHALL BE MIN. 100'-0" FROM & SPEED HUMPS.
NOTE: W14-1 (DEAD END) SHALL BE LOCATED IN THE SAME PLACE AS THE CURRENT SIGN.

NOTES:

- REFER TO TDOT STANDARD DRAWINGS FOR HEIGHT AND PLACEMENT OF ALL SIGNS.
- STEEL SIGN POLE, FINIAL, CAST STEEL BASE, FRAME, BACK OF SIGN, SCROLL AND MOUNTING HARDWARE TO BE POWDER COATED WITH RAL 6012 BLACK GREEN.
- CONCRETE SHALL BE CLASS A CONCRETE. THE USE OF SAKRETE AND QUIKCRETE IS ACCEPTABLE AS LONG AS IT IS PROPERLY PRE-MIXED ACCORDING TO MANUFACTURER'S SPECIFICATIONS PRIOR TO POURING INTO THE POST HOLE AND THAT IT MEETS THE STRENGTH REQUIREMENTS OF AT LEAST 3500 PSI FOR THE DIRT INSTALLATIONS AND 4000 PSI FOR CONCRETE INSTALLATIONS. THE USE OF MIXERS AT CONSTRUCTION SITES IS ACCEPTABLE TO THE CITY.

TARA DRIVE SIGN QUANTITIES			
ITEM NO.	DESCRIPTION	UNIT	QUANTITY
①	713-13.02 FLAT SHEET ALUMINUM SIGNS (0.080" THICK)	S.F.	82
	SP-4 STEEL SIGN POLE (TRAFFIC SIGN)	EACH	13
②	SP-5 SIGN AND SIGN POST REMOVAL	EACH	6

- ITEM INCLUDES ALL HARDWARE, EQUIPMENT, LABOR AND COST TO ERECT AND CONSTRUCT SIGN POLE.
- ITEM INCLUDES REMOVAL OF SIGN AND SIGN POST OF MISCELLANEOUS TRAFFIC CALMING SIGNS ALONG TARA DRIVE

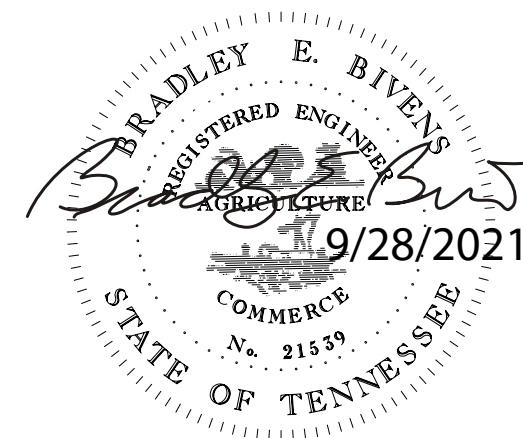

SIGN LAYOUT SHEET

CITY OF FOREST HILLS
DAVIDSON COUNTY, TENNESSEE

DSGN:	BEB	8/25/2021	REVISIONS
DRWN:	KDF	8/30/2021	
CHKD:	BEB	9/01/2021	
SCALE:	NO SCALE		
PROJ. NO.:	14615.004		



NEEL-SCHAFFER
Solutions you can build upon

DRAWING NO.
8



IF YOU DIG TENNESSEE
CALL US FIRST!
811
(1-800-351-1111)
IT'S THE LAW

DETAILED DRAWINGS
PW 2021-04 Tara Drive Speed Humps

 **NEEL-SCHAFFER**
Neel-Schaffer, Inc.
210 25th Avenue North, Suite 800
Nashville, TN 37215
Phone: 615.383.8420
Fax: 615.383.9984
www.neel-schaffer.com