

FIXTURE C

Gardco GeoForm wedge medium LED wall sconce features a geometric wedge shape that will complement a range of architectural styles. GeoForm wedge medium features specialized, highly efficient precision plus optics which balance low glare with excellent performance. Type 2, 3 and 4 optical distributions are available. Emergency battery backup option provides path-of-egress illumination, and multiple control options further enhance energy savings.

Project: _____
 Location: _____
 Cat.No: _____
 Type: _____
 Lamps: _____ Qty: _____
 Notes: _____

Ordering guide

example: GWM-A07-840-T3M-UNV-FAWS-DG

Luminaire	Configuration (nom. lumens)	Color Temperature	Distribution	Voltage	Dimming Controls ²	Options (electrical, mechanical, etc)	Emergency	Finish
GWM								
GWM GeoForm Wedge Medium	A06 2,500 lumens	830 80CRI 3000K	T2M Type 2	120 120V	none	Leave blank (10kV kA dimming driver standard)	none Leave blank (10kV/kA standard)	Textured
	A07 4,000 lumens	840 80CRI 4000K	T3M Type 3	208 208V	DLEA	Dimming Leads Externally Accessible (controls by others)	SP2 Surge protector 20kV/10kA (option)	BK Black
	A08 5,000 lumens	740 70CRI 4000K	T4M Type 4	240 240V	UNV 120-277V (50/60Hz)	DUCC ^{1,7} Dual Circuit Control	FS1 Single fuse (120, 277, or 347VAC)	WH White
	A09 6,000 lumens	750 70CRI 5000K		277 277V	FAWS	Field Adjustable Wattage Selector	FS2 Double fuse (208V, 240V, or 480V)	BZ Bronze
	A10 ¹ 7,500 lumens			347 347V	MW30 ^{1,3}	Microwave motion sensor factory set at 30% dimming	FS3 Double fuse Canadian double pull (208V, 240V, or 480V)	DG Dark Gray
	A11 ¹ 8,500 lumens			480 480V	DynaDimmer: Automatic Profile Dimming	Only offered with A08-A13	PCB ⁵ Photocontrol Button	MG Medium Gray
	A12 ¹ 9,500 lumens			HVU 347-480V (50/60Hz)	CS50 ^{1,4}	Safety 50% dimming, 7 hours		Customer specified
	A13 ¹ 11,000 lumens				CM50 ^{1,4}	Median 50% dimming, 8 hours		RAL Specify optional color or RAL, (ex: OC-LGP or OC-RAL7024)
	A14 ¹ 12,500 lumens				CS30 ^{1,4}	Safety 30% dimming, 7 hours		CC Custom Color (must supply color chip, requires factory quote)
					CM30 ^{1,4}	Median 30% dimming, 8 hours		

- Emergency Battery Pack not available.
- Only one option can be selected from Dimming Controls column.
- Not available in 480V.
- Only available in 120- 277V or UNV.
- Only available in 120-277, must specify voltage.
- 120-277V only. Luminaire must be ordered with DLEA option if using WIAP.
- DUCC only available with A06, A07, A08, A09.
- Available with 120V or 277V only.

Luminaire Accessories (order separately)

GF-WS-BK Wall Mounted Box for surface conduit, painted black



GWM GeoForm wedge medium

Wall sconce

Dimensions

GWM Wedge

Standard

Weight: 7.5 Lbs (3.4kg)

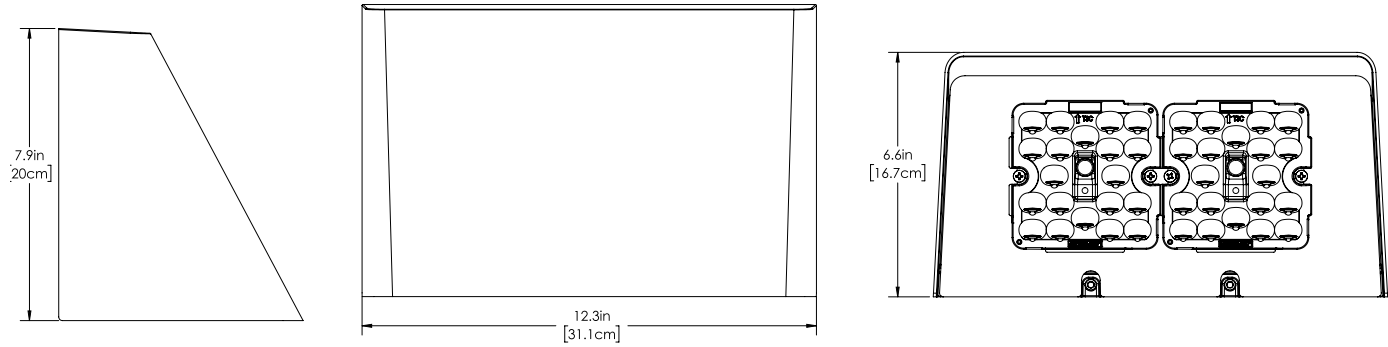

Accessory details

Surface mount conduit box (GF-WS-BK)

GWM Wedge with surface conduit wall mount box

Weight: 8.1 Lbs (3.7kg)

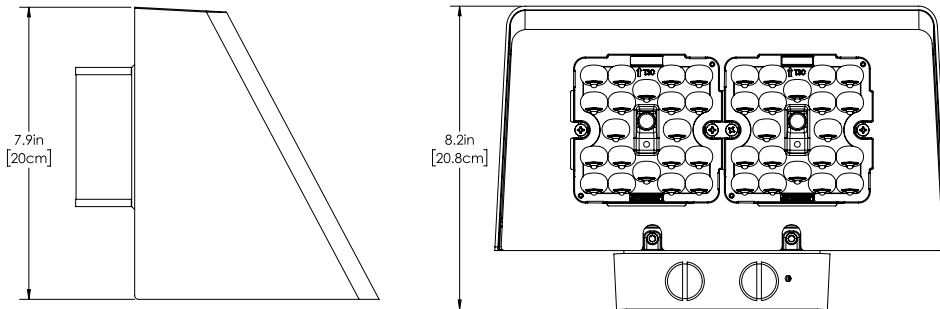

GF-WS-BK Details

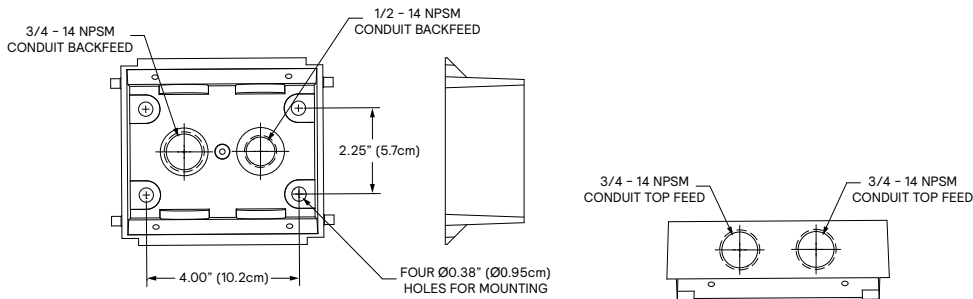

GWM GeoForm wedge medium

Wall sconce

GWM Lumen values

3000K, 80CRI

Ordering Code	CCT	CRI	Average System Wattage	Type 2M			Type 3M			Type 4M		
				Lumen Output	BUG Rating	Efficacy (LPW)	Lumen Output	BUG Rating	Efficacy (LPW)	Lumen Output	BUG Rating	Efficacy (LPW)
GWM-A06-830	3000	80	16	2506	B1-U0-G1	154	2540	B1-U0-G1	156	2480	B1-U0-G1	152
GWM-A07-830	3000	80	23	3522	B1-U0-G1	153	3570	B1-U0-G1	155	3485	B1-U0-G1	152
GWM-A08-830	3000	80	30	4487	B1-U0-G1	150	4548	B1-U0-G1	152	4440	B1-U0-G1	148
GWM-A09-830	3000	80	39	5700	B2-U0-G2	147	5777	B2-U0-G2	149	5640	B1-U0-G2	146
GWM-A10-830	3000	80	45	6521	B2-U0-G2	145	6609	B2-U0-G2	147	6452	B1-U0-G2	143
GWM-A11-830	3000	80	52	7473	B2-U0-G2	145	7575	B2-U0-G2	147	7395	B2-U0-G2	143
GWM-A12-830	3000	80	59	8506	B2-U0-G2	143	8621	B2-U0-G2	145	8417	B2-U0-G2	142
GWM-A13-830	3000	80	66	9423	B2-U0-G2	142	9551	B2-U0-G2	144	9324	B2-U0-G2	140
GWM-A14-830	3000	80	77	10783	B3-U0-G3	139	10929	B3-U0-G3	141	10670	B2-U0-G2	138

4000K, 80CRI

Ordering Code	CCT	CRI	Average System Wattage	Type 2M			Type 3M			Type 4M		
				Lumen Output	BUG Rating	Efficacy (LPW)	Lumen Output	BUG Rating	Efficacy (LPW)	Lumen Output	BUG Rating	Efficacy (LPW)
GWM-A06-840	4000	80	16	2599	B1-U0-G1	159	2634	B1-U0-G1	162	2571	B1-U0-G1	158
GWM-A07-840	4000	80	23	3652	B1-U0-G1	159	3701	B1-U0-G1	161	3614	B1-U0-G1	157
GWM-A08-840	4000	80	30	4653	B1-U0-G1	156	4716	B1-U0-G1	158	4604	B1-U0-G1	154
GWM-A09-840	4000	80	39	5910	B2-U0-G2	153	5990	B2-U0-G2	155	5848	B1-U0-G2	151
GWM-A10-840	4000	80	45	6761	B2-U0-G2	150	6852	B2-U0-G2	152	6690	B1-U0-G2	149
GWM-A11-840	4000	80	52	7749	B2-U0-G2	150	7853	B2-U0-G2	152	7667	B2-U0-G2	149
GWM-A12-840	4000	80	59	8819	B2-U0-G2	149	8939	B2-U0-G2	151	8727	B2-U0-G2	147
GWM-A13-840	4000	80	66	9770	B3-U0-G3	147	9902	B3-U0-G3	149	9668	B2-U0-G2	146
GWM-A14-840	4000	80	77	11180	B3-U0-G3	144	11331	B3-U0-G3	146	11063	B2-U0-G2	143

4000K, 70CRI

Ordering Code	CCT	CRI	Average System Wattage	Type 2M			Type 3M			Type 4M		
				Lumen Output	BUG Rating	Efficacy (LPW)	Lumen Output	BUG Rating	Efficacy (LPW)	Lumen Output	BUG Rating	Efficacy (LPW)
GWM-A06-740	4000	70	16	2928	B1-U0-G1	180	2968	B1-U0-G1	182	2898	B1-U0-G1	178
GWM-A07-740	4000	70	23	4115	B1-U0-G1	179	4171	B1-U0-G1	181	4072	B1-U0-G1	177
GWM-A08-740	4000	70	30	5243	B2-U0-G2	175	5314	B2-U0-G2	178	5188	B1-U0-G1	174
GWM-A09-740	4000	70	39	6660	B2-U0-G2	172	6750	B2-U0-G2	174	6590	B1-U0-G2	170
GWM-A10-740	4000	70	45	7619	B2-U0-G2	169	7722	B2-U0-G2	172	7539	B2-U0-G2	168
GWM-A11-740	4000	70	52	8732	B2-U0-G2	169	8850	B2-U0-G2	172	8640	B2-U0-G2	167
GWM-A12-740	4000	70	59	9938	B3-U0-G3	168	10073	B3-U0-G3	170	9834	B2-U0-G2	166
GWM-A13-740	4000	70	66	11010	B3-U0-G3	166	11159	B3-U0-G3	168	10894	B2-U0-G2	164
GWM-A14-740	4000	70	77	12598	B3-U0-G3	163	12769	B3-U0-G3	165	12466	B2-U0-G2	161

5000K, 70CRI

Ordering Code	CCT	CRI	Average System Wattage	Type 2M			Type 3M			Type 4M		
				Lumen Output	BUG Rating	Efficacy (LPW)	Lumen Output	BUG Rating	Efficacy (LPW)	Lumen Output	BUG Rating	Efficacy (LPW)
GWM-A06-750	5000	70	16	2812	B1-U0-G1	173	2850	B1-U0-G1	175	2783	B1-U0-G1	171
GWM-A07-750	5000	70	23	3952	B1-U0-G1	172	4006	B1-U0-G1	174	3911	B1-U0-G1	170
GWM-A08-750	5000	70	30	5035	B2-U0-G2	168	5103	B2-U0-G2	171	4982	B1-U0-G1	167
GWM-A09-750	5000	70	39	6396	B2-U0-G2	165	6482	B2-U0-G2	167	6329	B1-U0-G2	164
GWM-A10-750	5000	70	45	7317	B2-U0-G2	163	7416	B2-U0-G2	165	7240	B2-U0-G2	161
GWM-A11-750	5000	70	52	8385	B2-U0-G2	163	8499	B2-U0-G2	165	8297	B2-U0-G2	161
GWM-A12-750	5000	70	59	9544	B2-U0-G2	161	9673	B3-U0-G3	163	9444	B2-U0-G2	159
GWM-A13-750	5000	70	66	10573	B3-U0-G3	159	10716	B3-U0-G3	161	10462	B2-U0-G2	158
GWM-A14-750	5000	70	77	12099	B3-U0-G3	156	12262	B3-U0-G3	158	11972	B2-U0-G2	155

GWM GeoForm wedge medium

Wall sconce

LED Wattage and Lumen Values (Emergency Mode)

Ordering Code	CCT	CRI	Avg. System Wattage (W)	Type 2M		Type 3M		Type 4M	
				Lumen Output	BUG Rating	Lumen Output	BUG Rating	Lumen Output	BUG Rating
GWM-AXX-740-X-EM	4000	70	6	1000	B0-U0-G0	1014	B0-U0-G1	838	B0-U0-G0
GWM-AXX-750-X-EM	5000	70	6	960	B0-U0-G0	973	B0-U0-G1	804	B0-U0-G0
GWM-AXX-830-X-EM	3000	80	6	856	B0-U0-G0	868	B0-U0-G1	717	B0-U0-G0
GWM-AXX-840-X-EM	4000	80	6	887	B0-U0-G0	899	B0-U0-G1	743	B0-U0-G0

Optical Distributions

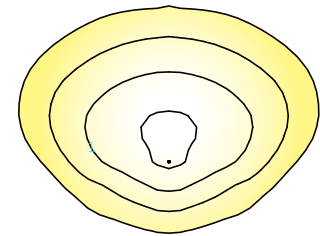
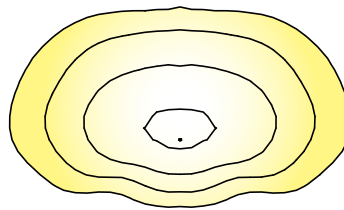
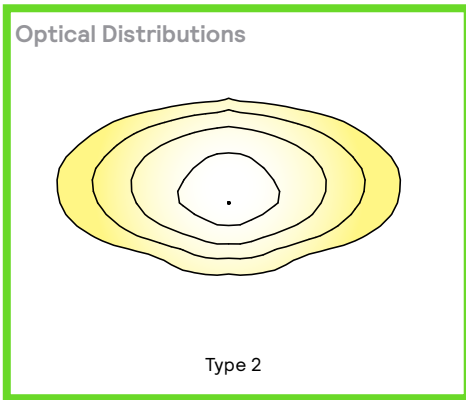

Specifications

Construction

Main body housing and door frame made of low copper die cast aluminum alloy for a high resistance to corrosion. Removable die cast backplate to allow access to driver or other electronic components for servicing. The housing acts as the main heat sinking component, for maximum thermal dissipation. Giving the freedom to have a clean minimalist aesthetic design while allowing it to house emergency battery backup equipment and various other options. Luminaire housing rated to IP65, tested in accordance to Section 9 of IEC 60598-1.

IK Rating IK08 high impact resistance rating for both the housing and optics

IP Rating IP65 rated luminaire with IP66 rated light engine

Light engine

Electrical components are RoHS compliant, IP66 sealed light engine equipped LEDs tested by ISO 17025-2005 accredited lab in accordance with IESNA LM-80 guidelines in compliance with EPA ENERGY STAR, extrapolations in accordance with IESNA TM-21. Metal core board ensures greater heat transfer and longer lifespan.

LED Module

LED PCBA made of 20 LEDs populated on aluminum metal clad board for optimal thermal dissipation ensuring long LED life.

Optical System

Composed of high performance UV stabilized optical grade polymer refractor lenses to achieve desired distribution optimized to get maximum spacing, target lumens and a superior lighting uniformity. Performance tested per LM-63, LM-79 and TM-15 (IESNA) certifying its photometric performance. 0% uplight and U0 per IESNA TM-15.

Mounting

Mounting is achieved through integral back plate that features a hook and lock quick mount plate that secures with two set screws from bottom of luminaire. Mounting plate is located in the center of the luminaire body. Luminaire ships fully assembled, ready to install.

Installation

GeoForm features an integral hook on its mounting plate which allows a single installer to perform wiring without assistance. See installation instructions for complete details.

Control options

0-10V dimming (DLEA): Access to 0-10V dimming leads supplied through back of luminaire (for secondary dimming controls by others). Cannot be used with other control options.

Dual Circuit Control (DUCC): Luminaire equipped with the ability to have two separate circuits controlling drivers and light engines independently. Permits separate switching of separate modules controlled by use of two sets of leads, one for each circuit. Not recommended to be used with other control options, motion response, or photocells.

Field Adjustable Wattage Selector (FAWS): Luminaire equipped with the ability to manually adjust the wattage in the field to reduce total luminaire lumen output and light levels. Comes pre-set to the highest position lumen output selected. Use chart below to estimate reduction in lumen output desired. Cannot be used with other control options or motion response.

FAWS Position	Percent of Typical Lumen Output	FAWS Position	Percent of Typical Lumen Output
1	25%	6	80%
2	50%	7	85%
3	55%	8	90%
4	65%	9	95%
5	75%	10	100%

Note: Typical value accuracy +/- 5%

GWM GeoForm wedge medium

Wall sconce

Specifications (cont'd)

Motion Response (MW30): Motion response luminaires include a high frequency microwave sensor, 5.8GHz+/- 75MHz microwave ISM continuous wave band with 360° coverage area, <0.5 mW transmitting power and <1 W standby power. Factory programmed settings dim fixture to 30% with time delay of 5 minutes with no stand-by period. When motion is detected, the luminaire returns to 100% full light output and will remain on full power for 5 minutes.

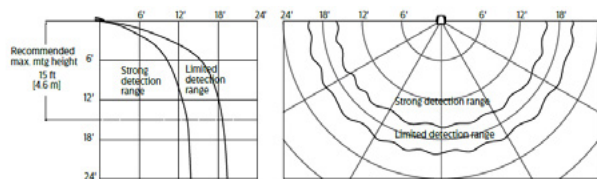

Automatic Profile Dimming (CS/CM): Standard dimming profiles provide flexibility towards energy savings goals while optimizing light levels during specific dark hours. Dimming profiles include two dimming settings including dim to 30% or 50% of the total lumen output. When used in combination with not programmed motion response it overrides the controller's schedule when motion is detected. After 5 minutes with no motion, it will return to the automatic dimming profile schedule. Automatic dimming profile scheduled with the following settings:

- **CS50/CS30:** Security for 7 hours night duration (Ex., 11 PM – 6 AM)
- **CM50/CM30:** Median for 8 hours night duration (Ex., 10 PM – 6 AM)

All above profiles are calculated from mid-point of the night. Dimming is set for 6 hours after the mid-point and 2, or 3 hours before depending on the duration of dimming. Cannot be used with other dimming control options.

Emergency Battery Backup (EC): Emergency battery pack included integral to the luminaire, allowing for a consistent look between emergency and non-emergency luminaires. EC is cold weather rated for use in ambient temperature conditions from -20°C (-4°F) to 40°C (104°F) designed to have a secondary driver with relay to immediately detect AC power loss to power luminaire for a minimum of 90 minutes from the time power is lost. Available with 120 or 277V.

Electrical

Driver: Driver efficiency (>90% standard). 120-480V available (restrictions apply). Open/short circuit protection. 0-10V dimming driver down to 10% standard. RoHS compliant.

Button Photocontrol (PCB): Button style design for internal luminaires mounting applications. The photocontrol is constructed of a high impact UV stabilized polycarbonate housing. Rated voltage of 120V or 208-277V with a load rating of 1000 VA. The photocell will turn on with 1-4Fc of ambient light.

Surge protection (SP1/SP2): Each luminaire is provided as standard with surge protector tested in accordance with ANSI/IEEE C62.45 per ANSI/IEEE C62.41.2 Scenario I Category C High Exposure 10kV/5kA waveforms for Line Ground, Line Neutral and Neutral Ground, and in accordance with U.S. DOE (Department of Energy) MSSLC (Municipal Solid-State Street Lighting Consortium) Model Specification for LED Roadway Luminaires Appendix D Electrical Immunity High Test Level 10kV / 5kA. Optional 20kV is available for additional protection.

Listings

UL/cUL listed to the UL 1598 standard, suitable for wet locations when mounted downward facing. Also listed for damp locations when inverted upward facing when mounted in covered ceiling application. Suitable for use in ambient temperatures from -40° to 40°C (-40° to 104°F). All GeoForm configurations are qualified under Design Lights Consortium® Premium category. Consult DLC Qualified Products List on Specific Classifications and for more details. CCTs 3000K and warmer are IDA Dark Sky Approved. FCC Compliant.

Finish

Each standard color luminaire receives a fade and abrasion resistant, electrostatically applied, thermally cured, triglycidic isocyanurate (TGIC) textured polyester powder coat finish. The surface treatment achieves a minimum of 1000 hours for salt spray resistant finish in accordance with testing performed and per ASTM B117 standard. Standard colors include bronze (BZ), black (BK), white (WH), dark gray (DGY), and medium gray (MGY). Consult factory for specs on optional or custom colors.

Service Tag

Each individual luminaire is uniquely identifiable, thanks to the Service tag application. With a simple scan of a QR code, placed on the inside of the mast door, you gain instant access to the luminaire configuration, making installation and maintenance operations faster and easier, no matter what stage of the luminaire's lifetime. Just download the APP and register your product right away. For more details visit: signify.com

Warranty

GeoForm luminaires feature a 5-year limited warranty. See signify.com/warranties for complete details and exclusions.

Predicted Lumen Depreciation Data

Predicted performance derived from LED manufacturer's data and engineering design estimates, based on IESNA LM-80 methodology. Actual experience may vary due to field application conditions. L₇₀ is the predicted time when LED performance depreciates to 70% of initial lumen output. Calculated per IESNA TM21-11. Published L₇₀ hours limited to 6 times actual LED test hours

Ambient Temperature °C	Drive current	L ₇₀ per TM-21	Lumen Maintenance % at 60,000 hrs
25°C	up to 1200 mA	>102,000 hours	>91%

Buy American Act of 1933 (BAA):

This product is manufactured in one of our US factories and, as of the date of this document, this product was considered a commercially available off-the-shelf (COTS) item meeting the requirements of the BAA. This BAA designation hereunder does not address (i) the applicability of, or availability of a waiver under, the Trade Agreements Act, or (ii) the "Buy America" domestic content requirements imposed on states, localities, and other non-federal entities as a condition of receiving funds administered by the Department of Transportation or other federal agencies. Prior to ordering, please visit www.signify.com/baa to view a current list of BAA-compliant products to confirm this product's current compliance.

