

**HIGHLANDS COUNTY BOARD OF COUNTY COMMISSIONERS**

***Purchasing Department***

600 S. Commerce Avenue

Sebring, Florida 33870

**Purchasing Main Line:** (863) 402-6500

**Purchasing Designated Contact:** Kelli Bronson, Purchasing Analyst

**Email:** kbronson@HighlandsFL.Gov

**Direct Line:** (863) 402-6528



**INVITATION TO BID**

**ITB No: 24-005-KSB Lake June-in-Winter Best Management Practices (BMP's) for Catfish Creek-Floating Islands and Baffle Box Construction Highlands County Project No. 21062**

- ✓ **Non-Mandatory Pre-Solicitation Meeting:** **Tuesday, January 30, 2024, 2:30 PM**
- ✓ **Location:** **LOCATION/ADDRESS**  
**Road and Bridge Conference Room,**  
**4344 George Blvd, Sebring, FL 33875**
- ✓ **Request for Information Deadline:** **Tuesday, February 13, 2024, prior to 5:00 PM**
- ✓ **Submission Deadline:** **Tuesday, February 20, 2024, prior to 3:30PM**

**Advertised Date: January 20, 2024 and January 27, 2024**

***PROHIBITED SUBMISSION TO THIS SOLICITATION/PROPOSAL/QUOTE.*** Any party who is in active litigation with Highlands County on the due date for responses to this solicitation/proposal/quote or who has received notice from Highlands County that the party is in breach of a contractual obligation under a contract with Highlands County and where such breach has not been resolved to the satisfaction of Highlands County on the due date for responses to this solicitation/proposal/quote, shall not submit a response to this solicitation/proposal/quote. In the event of a submission by such a party as described hereinabove, the submission shall be considered non-responsible and shall be rejected.

**TABLE OF CONTENTS**  
**ITB 24-005-KSB**

**LAKE JUNE-IN-WINTER BMP'S FOR CATFISH CREEK-FLOATING ISLANDS  
AND BAFFLE BOX CONSTRUCTION  
HIGHLANDS COUNTY PROJECT NO. 21062**

<b>SECTION</b>	<b>DESCRIPTION</b>
<b>DIVISION 0:</b>	<b>PROCUREMENT AND CONTRACTING REQUIREMENTS</b>
00010	INVITATION TO BID
00100	INSTRUCTIONS TO BIDDERS
00160	CERTIFICATES/FORMS Drug Free Workplace Certification (Section 287.087 FL Statutes) Public Entity Crime Certification (Section 287.133, FL Statutes) Discrimination Certification (Section 287.134, FL Statutes) Scrutinized Companies Certification (Section 287.135, FL Statutes) E-Verify Certification Indemnification Statement Sub-contractors List Trench Safety Certification Sealed Submission Label
00250	GENERAL TERMS AND CONDITIONS
00300	BID FORM
00410	BID BOND
00500	AGREEMENT (WILL BE PROVIDED TO AWARDED BIDDER)
00600	PUBLIC CONSTRUCTION BOND
00700	STANDARD GENERAL CONDITIONS
00800	SUPPLEMENTARY CONDITIONS
00836	WAIVER OF RIGHT TO CLAIM AGAINST THE PAYMENT BOND
<b>APPENDIX:</b>	
A	Lake June-In-Winter_Plans
B	Lake June-In-Winter_Special Provisions
C	Lake June-In-Winter_Technical Specifications
D	Resource Benefit Calculations and Design Methodology
E	SWFWMD Project Agreement

# HIGHLANDS COUNTY BOARD OF COUNTY COMMISSIONERS

*Purchasing Division and Road and Bridge Department*



## DIVISION 0 - SECTION 00010 INVITATION TO BID (“ITB”)

The Board of County Commissioners (“Board”) of Highlands County, Florida (“County”) will receive sealed Bids in the Highlands County Purchasing Division (“Purchasing Division”) for:

**ITB NO. 24-005-KSB Lake June-in-Winter Best Management Practices (BMPs) for Catfish Creek-Floating Islands and Baffle Box Construction, Highlands County Project No. 21062.**

Specifications may be obtained by downloading from our website: [www.highlandsfl.gov](http://www.highlandsfl.gov), or on [www.VendorRegistry.com](http://www.VendorRegistry.com). Questions can be directed at Purchasing Designated Contact noted on the cover page of this solicitation.

**A NON-MANDATORY PRE-BID meeting will be held at 2:30 P.M. on Tuesday, January 30, 2024**, in the Highlands County Road and Bridge Conference Room, 4344 George Blvd. Sebring, Florida 33875.

The purpose of this meeting is to provide a forum where the Bidders can further familiarize themselves with the Specifications of the ITB. The public is invited to attend this meeting.

**SUBMISSIONS and original BID BOND, if applicable, MUST BE DELIVERED** to the Purchasing Department, 600 S. Commerce Avenue., Sebring, FL 33870 to reach said office no later than **3:30 P.M., Tuesday, February 20, 2024**, at which time they will be opened. Responses may be submitted by one of the following methods:

**Electronic submission** to the County website, [www.highlandsfl.gov](http://www.highlandsfl.gov) linking to [VendorRegistry.com](http://VendorRegistry.com) in **one all-inclusive adobe file** of all documents and, if applicable, **additionally one Excel file containing the Itemized Bid Form**. Label each **“24-005 Bidder Name-Submission”** and **“24-005 Bidder Name-Bid Form”**

**OR**

**Hard Copy submission** in a sealed and marked package. Affix the supplied “Sealed Solicitation Label” with the name of the Proposer, solicitation number, and title to the exterior of the package so as to identify the enclosed response. A hard copy response is to include the following: **one (1) original all-inclusive paper copy** (signed in blue ink), of the response, and electronic copy containing **one all-inclusive Adobe file** of all documents and **additionally, if applicable, one Excel file containing the Itemized Bid Form**. Label each **“24-005 Bidder Name Submission”** and **“24-005 Bidder Name Bid Form”** (Thumb drive) of the original response.

**NOTE: Original Bid Bond (hard copy,)** as required, are to be physically received by Purchasing prior to the submission deadline provided on the cover page or as revised via Addendum.

**LATE SUBMISSIONS:** Submissions received later than the date and time as specified will be rejected. The Board shall not be responsible for delays caused by the method of delivery such as, but not limited to; Internet, United States Postal Service, overnight express mail service(s), or delays caused by any other occurrence.

One or more County Commissioners may be in attendance at meetings.

Highlands County's Local Preference Policy and Women/Minority Business Preference Policy will apply to the award of this Bid. Please see the Highlands County Board of County Commissioners Purchasing Manual with an effective date of June 21, 2022.

The County reserves the right to accept or reject any or all Bids or any parts thereof, and the determination of this Award, if an Award is made, will be made to the most responsive and responsible Bidder whose Bid and qualifications indicate that the Award will be in the best interest of the County. The County reserves the right to waive irregularities in the Bid.

**BOND:** To receive consideration, a Bidder must submit a Bid on all Work. An original Bid Bond in an amount of five percent (5%) of the Bid must be included on Bids over one hundred thousand dollars (\$100,000.00). If the successful Bid is greater than two hundred thousand dollars (\$200,000.00), a Public Construction Bond will be required. An Irrevocable Letter of Credit may be considered in lieu of the Public Construction Bond depending on its verbiage. The Bidder must be a Licensed to do this work in the State of Florida. The Bid must be accompanied by evidence of the Bidder's qualifications to do business in the State of Florida.

The principal features of the Project are:

To provide all materials, equipment, and labor to construct baffle box, a 6' x 12' x 9' filter box with filter media and risers, and five 6' x 6.5' floating wetland islands with vegetative plantings and anchoring. Other associated construction activities include minimal clearing/grubbing, excavation, removal, and replacement of concrete slope pavement, 8" PVC pipe, sodding, and other restoration activities. The contractor shall construct the Project in conformance with the final design drawings, specifications, and approved permits.

The County does not discriminate upon the basis of any individual's disability status. This non-discrimination policy involves every aspect of the Board's functions, including one's access to, participation, employment or treatment in its programs or activities. Anyone requiring reasonable accommodation as provided in the Americans with Disabilities Act or Section 286.26, Florida Statutes, should contact Human Resources, ADA Coordinator at: 863-402-6500 (Voice), or via Florida Relay Service 711, or by e-mail: [hrmanager@highlandsfl.gov](mailto:hrmanager@highlandsfl.gov). Requests for CART or interpreter services should be made at least 24 hours in advance to permit coordination of the service.

**Board of County Commissioners, Highlands County, FL**

<http://www.highlandsfl.gov>

**-END OF SECTION-**

**DIVISION 0 - SECTION 00100**  
**INSTRUCTIONS TO BIDDERS**  
**ITB 24-005-KSB**

**Article 1 - Defined Terms**

- 1.01 Terms used in these Instructions to Bidders have the meanings indicated below and in Section 00700 of this ITB which are applicable to both the singular and plural thereof:
- A. Alternative – Amount proposed by Bidder and stated on the Bid Form that will be added to or deducted from the base Bid amount if Engineer decides to accept a corresponding change in either Scope of Work or in products, materials, equipment, systems or installation methods described in Construction Documents.
  - B. Award – The selection by the County of the lowest responsible and responsive Bidder to perform the Work.
  - C. Bid – The Bid Form and other documents submitted by a Bidder in response to this ITB.
  - D. Bidder – The individual or entity who submits a Bid directly to the County.
  - E. Bid Form – Section 00300 of this ITB, which shall be used to submit a Bid. This section may or may not include an Excel Itemized Bid Form.
  - F. Bidding Documents – This ITB, all Addenda to this ITB, and the Construction Documents.
  - G. Board – County’s Board of County Commissioners.
  - H. Construction Documents – The construction Drawings and Specifications for the “LAKE JUNE-IN-WINTER BEST MANAGEMENT PRACTICES (BMP’S) FOR CATFISH CREEK FLOATING ISLANDS AND BAFFLE BOX CONSTRUCTION, Highlands County Project No. 21062”, dated June 2023, consisting of ten (10) sheets.
  - I. County Attorney – Highlands County’s Attorney.
  - J. County Engineer – Highlands County’s Engineer.
  - K. County or Owner – Highlands County, a political subdivision of the State of Florida.
  - L. Engineer – The Engineer of Record.
  - M. Project Manager – Highlands County’s Project Manager
  - N. Purchasing Division - Highlands County’s Purchasing Division, which issues Bidding Documents and administers the bidding procedures.
  - O. Site – The Site described and depicted in the Construction Documents.
  - P. Solicitation Package – Consist of all published Bid Documents. To include, but not limited to; Invitation to Bid, Itemized Bid Form, Addenda, and Plans.
  - Q. Work – The Work described and depicted in the Construction Documents.

## **Article 2 - Copies of Bidding Documents**

- 2.01 Complete sets of the Solicitation Package in the number and for the deposit sum, if any, stated in the Advertisement or this ITB may be obtained from the Purchasing Division.
- 2.02 The official Solicitation Package is available for download through the County's website HighlandsFL.Gov through VendorRegistry.com the County's official advertising mechanism. Information obtained from other sites are to be considered UN-official and possibly incomplete.
- 2.03 Complete a complete Solicitation Package must be used in preparing Bids; neither Owner nor Project Manager assume any responsibility for errors or misinterpretations resulting from the use of incomplete sets of Bidding Documents.
- 2.04 Owner and Project Manager in making copies of Bidding Documents available on the above terms do so only for the purpose of obtaining Bids for the Work and do not confer a license or grant for any other use.

## **Article 3 - Qualifications of Bidders**

- 3.01 To demonstrate Bidder's qualifications to perform the Work, Bidder is to submit detailed written evidence with the Bid Form as follows:
  - A. **Experience:** Bidder is to have completed three (3) jobs within the past five (5) years which are of equal magnitude and complexity as the type of work to be done for the Owner. Provide a list of the three (3) jobs which include the name of the entity, complete address, name, phone number, fax, and email of a responsible individual qualified to respond to questions concerning the Bidder's abilities, costs, schedules, etc. Prior successful, on-time accomplishment of such equal work will be a consideration in determining whether the Bidder is qualified to perform the Work.
  - B. **Contractor License Requirements:** All Contractors performing construction and related work in Highlands County must comply with Highlands County Ordinances, codes, rules and regulations, Florida law, and the requirements of any and all other governmental agencies which have jurisdiction over the work being performed. A copy of the current Contractor License it to be provided.
- 3.02 Each Bid is to contain proof of enrollment in E-Verify.
- 3.03 Provide a printout of the SunBiz.Org registration for your EIN as evidence of Bidder's qualification to do business in the State.
- 3.04 In addition, the bidder may be requested to demonstrate Bidder's qualifications to perform the Work, within ten (10) days and prior to Notice of Award,
  - A. The Bidder may be requested to submit detailed written evidence such as financial data (note if financial data is considered confidential it must be marked as such) and other such data as may be called for below:
  - B. A listing of all Subcontractors is required when the subcontract value exceeds ten percent (10%) of the total contract amount. Provide experience statements for these Subcontractors.

#### **Article 4 - Examination of Bidding Documents, Other Related Data, and Site**

- 4.01 Subsurface and Physical Conditions known to Owner are shown in the Construction Documents. No Site-specific subsurface studies have been done.
- 4.02 Underground Facilities known to Owner are shown on the Construction Documents. No Site-specific utility locates have been done.
- 4.03 No Hazardous Environmental Condition has been identified at the Site.
- 4.04 Provisions concerning responsibilities for the adequacy of data furnished to prospective Bidders with respect to subsurface conditions, other physical conditions and Underground Facilities, and possible changes in the Contract Documents due to differing or unanticipated conditions appear in Paragraphs 5.03, 5.04 and 5.05 of Section 00700 Standard General Conditions. Provisions concerning responsibilities for the adequacy of data furnished to prospective Bidders with respect to Hazardous Environmental Conditions at the Site, if any, and possible changes in the Contract Documents due to Hazardous Environmental Conditions uncovered or revealed at the Site which were not shown or indicated in the Drawings or Specifications or identified in the Contract Documents to be within the scope of the Work appear in Paragraph 5.06 of Section 00700 Standard General Conditions.
- 4.05 On request, the Purchasing Division will provide Bidder access to Site to conduct such examinations, investigations, explorations, tests, and studies, as Bidder deems necessary for submission of a Bid. Bidder shall fill all holes and clean up and restore the Site to its former condition upon completion of such explorations, investigations, tests, and studies.
- 4.06 On request, the Purchasing Division will provide to each Bidder for examination access to or copies of Contract Documents (other than portions thereof related to price) for such other work.
- 4.07 It is the responsibility of each Bidder before submitting a Bid to:
  - A. Examine and carefully study the Solicitation Package, including any Addenda and the other related data identified in the Bidding Documents;
  - B. Visit the Site and become familiar with and satisfy Bidder as to the general, local, and Site conditions that may affect cost, progress, and performance of the Work;
  - C. Become familiar with and satisfy Bidder as to all federal, state, and local Laws and Regulations that may affect cost, progress, or performance of the Work;
  - D. Carefully study all drawings of physical conditions in or relating to existing surface or subsurface structures at or contiguous to the Site;
  - E. Obtain and carefully study (or assume responsibility for doing so) all additional or supplementary examinations, investigations, explorations, test, studies, and data concerning conditions (surface, subsurface, and Underground Facilities) at or contiguous to the Site which may affect cost, progress, or performance of the Work or which relate to any aspect of the means, methods, techniques, sequences, and procedures of construction to be employed by Bidder, including any specific means, methods, techniques, sequences, and procedures of construction expressly required by the Bidding Documents, and safety precautions and programs incident thereto;

- F. Agree at the time of submitting its Bid that no further examinations, investigations, explorations, tests, studies, or data are necessary for the determination of its Bid for performance of the Work at the price bid and within the times and in accordance with the other terms and conditions of the Bidding Document;
  - G. Become aware of the general nature of the Work to be performed by Owner and others at the Site that relates to the Work as indicated in the Bidding Document;
  - H. Correlate the information known to Bidder, information and observations obtained from visits to the Site, reports and drawings identified in the Bidding Documents, and all additional examinations, investigations, explorations, tests, studies, and data with the Bidding Documents;
  - I. Promptly give the Purchasing Division written notice of all conflicts, errors, ambiguities, or discrepancies that Bidder discovers in the Bidding Documents and confirm that the written resolution thereof by Engineer and the Purchasing Division is acceptable to Bidder; and
  - J. Determine that the Bidding Documents are generally sufficient to indicate and convey understanding of all terms and conditions for the performance of the Work.
- 4.08 The submission of a Bid will constitute an incontrovertible representation by Bidder that Bidder has complied with every requirement of this Article 4, that without exception the Bid is premised upon performing and furnishing the Work required by the Bidding Documents and applying any specific means, methods, techniques, sequences, and procedures of construction that may be shown or indicated or expressly required by the Bidding Documents, that Bidder has given Engineer and the Purchasing Division written notice of all conflicts, errors, ambiguities, and discrepancies that Bidder has discovered in the Bidding Documents and the written resolutions thereof by Engineer and the Purchasing Division are acceptable to Bidder, and that the Bidding Documents are generally sufficient to indicate and convey understanding of all terms and conditions for performing and furnishing the Work.

#### **Article 5 - Pre-Bid Meeting**

- 5.01 Pre-Bid Meeting are as specified on the cover page of this solicitation and may be revised via addenda.

#### **Article 6 - Site and Other Areas**

- 6.01 The Site is identified in the Bidding Documents. All additional lands and access thereto required for temporary construction facilities, construction equipment, or storage of materials and equipment to be incorporated in the Work is to be obtained and paid for by the Contractor. Easements for permanent structures or permanent changes in existing facilities are to be obtained and paid for by Owner unless otherwise provided in the Bidding Documents.



## **Article 7 - Interpretation and Addenda**

- 7.01 All questions about the meaning or intent of the Bidding Documents are to be directed to the Purchasing Division. Interpretations or clarifications considered necessary by the Purchasing Division and Project Manager in response to such questions will be issued by Addenda and will be posted on the website under this solicitation by the Purchasing Division. Requests for Information (RFI) received after the set date may not be answered. Only RFI answered by formal written Addenda will be binding. Oral and other interpretations or clarifications will be without legal effect.
- 7.02 Addenda may be issued to clarify, correct, or change the Bidding Documents as deemed advisable by Owner, Engineer or the Purchasing Division.
- 7.03 Addenda will be posted to the County's website; [www.highlandsfl.gov](http://www.highlandsfl.gov). It is the sole responsibility of the Bidder to frequently check the County's website for notifications such as Addendums, meeting notifications.

## **Article 8 - Bid Security**

- 8.01 **Bid Bond:** A Bid Bond in the amount of five percent (5%) of the Bid, must be included on each Bid over one hundred thousand dollars (\$100,000.00). The **Original Bid Bond (hard copy)**, as required, are to be physically received by Purchasing prior to the submission deadline provided on the cover page or as revised via Addendum.
- 8.02 **Public Construction Bond:** If the successful Bid is greater than two hundred thousand dollars (\$200,000.00), a "Public Construction Bond" of not less than one hundred percent (100%) of the Awarded Bid amount will be required. All Bonds must be in a form acceptable to Owner and County Attorney. Awarded Bidder must record Public Construction Bond at the Clerk's Recording Department and comply with Section 255.05, Florida Statutes.

## **Article 9 - Contract Times**

- 9.01 The number of days within which, or the dates by which, the Work is to be (a) Substantially Completed and, (b) final completion and ready for final payment are set forth in the Bid Form.

## **Article 10 - Liquidated Damages**

- 10.01 Owner and Contractor recognize that time is of the essence of this Agreement, Section 00500, to be provided to the awarded Bidder, and that Owner will suffer financial loss if the Work is not completed within the times specified. In agreeing upon the daily liquidated damages amount stated in this paragraph, Owner and Contractor have considered the original Contract Price, the average construction, engineering, and inspection costs experienced by Owner, and anticipated costs of project-related delays and inconveniences to Owner and the public. Owner and Contractor also recognize the delays, expense, and difficulties involved in proving the actual loss suffered by Owner if the Work is not completed on time. Accordingly, instead of requiring any such proof, Owner and Contractor agree that as liquidated damages for delay (and not as a penalty) Contractor shall pay Owner **liquidated damages as shown on the Bid Form, Section 00300** for each calendar day that expires after the time specified as Final Completion on the Bid Form, Section 00300 until the Work is completed and ready for final payment. Liquidated damages shall be deducted by Owner from any balance due Contractor or, if the balance due Contractor is less than the amount of liquidated damages, Contractor shall pay to Owner the remaining unpaid liquidated damages within thirty (30) days after Owner's invoice is sent to Contractor.
- 10.02 Owner does not waive its right to liquidated damages due under this Agreement by allowing Contractor to continue and to finish the Work, or any part of it, after the expiration of the Contract Time.
- 10.03 In the case of a default of this Agreement and the completion of the Work by Owner, Contractor and Contractor's surety are liable for the liquidated damages under this Agreement, but Owner will not charge liquidated damages for any delay in the final completion of Owner's performance of the Work due to any unreasonable action or delay on the part of Owner.

## **Article 11 - Substitute or "Or-Equal" Items**

- 11.01 The Contract, if awarded, will be on the basis of materials and equipment described in the Bidding Documents with consideration of possible substitute or "or-equal" items if allowed within the Bidding Documents. Whenever it is specified or described in the Bidding Documents that a substitute or "or-equal" item of material or equipment may be furnished or used by Contractor if acceptable to Engineer. **Application for such acceptance will be considered only during the allotted time frame for Request for Information (RFI).** Please see the cover page for the RFI deadline or as revised via addendum, if applicable.

## **Article 12 - Subcontractors, Suppliers and Others**

- 12.01 The apparent Successful Bidder, and any other Bidder so requested, shall within five (5) days after Bid opening, submit to Owner a list of all proposed contractors, Suppliers, individuals, or entities proposed for those portions of the Work for which such identifications are required. Such list shall be accompanied by an Experience Statement with pertinent information regarding similar projects and other evidence of qualification for each Subcontractor, Supplier, individual, or entity if requested by Owner. If Owner, Project Manager or the Purchasing Division after due investigation, has reasonable objection to any proposed Subcontractor, Supplier, individual, or entity, Owner may, before the Notice of Award is given, request apparent Successful Bidder to submit a substitute, without an increase in the Bid.

- 12.02 If the apparent Successful Bidder declines to make any such substitution, Owner may Award the Contract to the next lowest Bidder that proposes to use acceptable Subcontractors, Suppliers, individuals, or entities. Declining to make requested substitutions will not constitute grounds for forfeiture of the bid security of any Bidder. Any Subcontractor, Supplier, individual, or entity so listed and against which Owner, Project Manager or the Purchasing Division makes no written objection prior to giving of the Notice of Award will be deemed acceptable to all indicated parties subject to revocation of such acceptance after the Effective Date of the Contract.
- 12.03 Contractor shall not be required to employ any Subcontractor, Supplier, individual, or entity against whom Contractor has reasonable objection.
- 12.04 The Contractor is responsible to ensure all Subcontractors comply with all insurance requirements.

### **Article 13 - Bid Form**

- 13.01 Bidder shall use and/or make necessary copies of Section 00300 "Bid Form" of this ITB for their Submittal Document(s). Should the task itemization portion of the "Bid Form" be provided in Excel format it is to be completed and returned in an unlocked Excel document.
- 13.02 All blanks on the Bid Form shall be completed by printing in black ink or by typewriter and the Bid Form shall be signed by a person with authorization pursuant to Florida law to represent the Bidder. A Bid Price shall be indicated for each unit price item listed therein, if applicable, or the words "No Bid", "No Change", or "Not Applicable" entered. All names shall be typed or printed below the signature line with all signatures in blue ink.
- 13.03 A Bid by a corporation shall be executed in the corporate name by the president or a vice president or other corporate officer accompanied by evidence of authority to sign. The corporate seal shall be affixed and attested by the secretary or an assistant secretary. The corporate address and state of incorporation shall be shown below the signature.
- 13.04 A Bid by a partnership shall be executed in the partnership name and signed by a partner (whose title must appear under the signature), accompanied by evidence of authority to sign. The official address of the partnership and state of organization and type of partnership shall be shown below the signature.
- 13.05 A Bid by a limited liability company shall be executed in the name of the firm by a member and accompanied by evidence of authority to sign. The state of formation of the firm and the official address of the firm must be shown below the signature.
- 13.06 A Bid by an individual shall show the Bidder's name and official address, telephone number, fax number, and email address.
- 13.07 A Bid by a joint venture shall be executed by each participant in the joint venture in accordance with the signature requirements stated in the preceding paragraph and in the manner indicated on the Bid Form. The official address of the joint venture must be shown below the signature.
- 13.08 The Bid is to contain an acknowledgment of receipt of all Addenda, the numbers of which shall be filled in on the Bid Form.

- 13.09 All Bid Forms shall have the name, official address, telephone number, fax number, and email address for communications regarding the Bid.
- 13.10 Attachments to the Bid Form shall include the following:
- A. Documentation as required in Article 3 of this Section including a copy of Contractors License.
  - B. All certificates of insurances from the Contractor required to fulfill the obligations of this Project.
  - C. Certifications from Section 00160, signed and notarized.

**Article 14 - Basis of Bid; Evaluation of Bids**

- 14.01 Bidders shall submit a Bid on a Lump Sum based Unit Price basis as noted on the Bid Form for the Work listed in these Bid Documents.
- 14.02 The Bid price shall include such amounts as the Bidder deems proper for overhead and profit on account of cash allowances.

**Article 15 - Submittal of Bids**

- 15.01 Each prospective Bidder’s to submit the requested documents and if required, the original hard copy Bid Bond Section 00410 of this ITB. ***Any blank spaces on the form(s), qualifying notes or exceptions, counter offers, lack of required submittals, or signatures, on County’s Form may result in the submission being declared non-responsive by the County. Any form not applicable is to be returned marked “N/A”***

***The list of forms below is meant only as a guide. It is the Bidder’s responsibility to review and include all requested and required documentation.***

Forms	YES	NO
Proposal/Bid Form: include acknowledgement of all addenda, original signature.		
Drug-Free Workplace Certification, F.S. 287.087		
Public Entity Crimes Sworn Statement, F.S. 287.133		
Discrimination Certification, F.S. 287.134		
Scrutinized Companies Certification, F.S. 287.135		
Contracting with entities of foreign countries F.S. 287.138		
E Verify Certification		
Statement of Indemnification		
Sub-Contractor List		
Trench Safety Certification		
Bid Security in the form of _____, as required Bid Bond Form Section 00410 <b>Original Hard Copy of Bond</b> sent to Purchasing to arrive prior to the submission deadline		
Miscellaneous Documentation	YES	NO
Woman or Minority Owned Business or Small Business (Include a copy of your certificate, if applicable)		
Required Bidder's Qualification Statement with supporting data included		
A list of three (3) jobs similar in scope in the last 5 years and size included		

	<b>Copy of any applicable Licenses (Contractor's License)</b>		
	<b>Sunbiz.org print-out for bidder EIN#</b>		
	<b>Acord Insurance Certificate (sample included)</b>		
	<b>HARD COPY SUBMISSION: One (1) Original Submission Package, PAPER COPY) and one (1) exact electronic copy, on thumb drive, of the Submission package. With an additional excel file containing the "Itemized Bid Form" to be completed and included as an unlocked Excel file. Excel file titled "24-005 Bidder Name-Bid Form" an all-inclusive file of the submission Titled "24-005 Bidder Name-Submission"</b> <b>OR</b> <b>ELECTRONIC SUBMISSION: Upload one (1) all-inclusive adobe file of the Submission package to the County Website via VendorRegistry.com. With an additional excel file containing the "Itemized Bid Form" to be completed and included as an unlocked Excel file." Files are to be titled "24-005 bidder name-Submission" and an Excel file titled "24-005 Bidder Name-Bid Form." Reminder: Bid Bond Original hard copy to be received in Purchasing Dept prior to submission deadline.</b>		
	<b>Sealed Submission Label</b>		

15.02 A Bid shall be submitted no later than the date and time prescribed and at the place indicated in the advertisement or Invitation to Bid.

15.03 Responses may be submitted prior to the submission deadline date and time by either:

- Electronic submission to the County website using VendorRegistry.com

OR

- Hard Copy submission in a sealed and marked package with the name of the Respondent, solicitation number, and title so as to identify the enclosed response. A hard copy submission shall include one (1) original and one (1) exact electronic copy (thumb drive) of the Submission packet.

Hardcopy shall be enclosed in a sealed opaque envelope or package, plainly marked with the Bid #, Bid / Project Title; (and, if applicable, the designated portion of the Project for which the Bid is submitted), the name and address of Bidder, and shall be accompanied by the bid security and other required documents. The enclosed "Sealed Submission Label" it so be affixed to the exterior of the sealed hard copy submission package.

**Original Bid Bonds (hard copy), as required, are to be received by Purchasing by the deadline provided on the cover page.**

**Article 16 - Modification and Withdrawal of Bids**

16.01 Prior to the date and time for the opening of the Bids, a Bid may be modified or withdrawn by an appropriate document duly executed in the manner that a Bid must be executed and delivered to the place where Bids are to be submitted.

### **Article 17 - Opening of Bids**

- 17.01 Bids will be opened at the time and place indicated in the advertisement or ITB Section 00010 or as revised via Addenda, and, unless obviously non-responsive, read aloud publicly. An abstract of the amounts of the base Bids and major alternates, if any, will be made available to Bidders after the opening of Bids by means of a copy of the "Bid Opening Sheet." The public is invited to attend this meeting.

### **Article 18 - Bids to Remain Subject to Acceptance**

- 18.01 All Bids will remain subject to acceptance for the period of time stated in the Bid Form and as allowed by Section 119.071, Florida Statutes, but Owner may, in its sole discretion, release any Bid and return the bid security prior to the end of this period.

### **Article 19 - Award of Contract**

- 19.01 Owner reserves the right to reject any or all Bids, including without limitation, non-conforming, non-responsive, unbalanced, or conditional Bids. Owner further reserves the right to reject the Bid of any Bidder that it finds, after reasonable inquiry and evaluation, to be non-responsible. Owner may also reject the Bid of any Bidder if Owner believes that it would not be in the best interest of the Project to make an Award to that Bidder. Owner also reserves the right to waive all informalities not involving price, time, or changes in the Work and to negotiate contract terms with the successful Bidder.
- 19.02 More than one Bid for the same Work from an individual or entity under the same or different names will not be considered. Reasonable grounds for believing that any Bidder has an interest in more than one Bid for the Work may be cause of disqualification of that Bidder and the rejection of all Bids in which that Bidder has an interest.
- 19.03 Evaluation of Bids
- A. In evaluating Bids, Owner will consider whether or not the Bids comply with the prescribed requirements, and such alternatives, unit prices, and other data, as may be requested in the Bid Form or prior to the Notice of Award.
  - B. In the comparison of Bids, alternatives will be applied in the same order of priority as listed in the Bid Form. For comparison purposes alternatives may be accepted until doing so would cause the budget to be exceeded. After determination of the successful Bidder based on this comparative process and on the responsiveness, responsibility, and other factors set forth in these Instructions, the award may be made to the successful Bidder on its base Bid and any combination of its additive alternate Bids for which Owner determines funds will be available at the time of award.
  - C. In evaluating Bids, Owner will consider whether or not the Bids comply with the prescribed requirements, and such alternates, unit prices and other data, as may be requested in the Bid Form or prior to the Notice of Award.

D. In evaluating Bidders, Owner will consider the qualifications of Bidders and may consider the qualifications and experience of Subcontractors, Suppliers, and other individuals or the entities proposed for those portions of the Work for which the identity of Subcontractors, Suppliers, and other individuals or entities must be submitted as required by Article 12 of this Section 00100. The County reserves the right to approve subcontractors, Suppliers or the entities proposed for this project.

E. **PROHIBITED SUBMISSION TO THIS SOLICITATION** Any party who is in active litigation with Highlands County on the due date for responses to this solicitation or who has received notice from Highlands County that the party is in breach of a contractual obligation under a contract with Highlands County and where such breach has not been resolved to the satisfaction of Highlands County on the due date for responses to this solicitation, shall not submit a response to this solicitation. In the event of a submission by such a party as described hereinabove, the submission shall be considered non-responsible and shall be rejected.

19.04 Owner may conduct such investigations as Owner deems necessary to establish the responsibility, qualifications, and financial ability of Bidders, proposed Subcontractors, Suppliers, individuals, or entities to perform the Work in accordance with the Contract Documents.

19.05 If the Contract is to be awarded, Owner will Award the Contract to the Bidder whose Bid is determined to be the most advantageous to Owner, taking into consideration those Bids in compliance with the requirements as set forth in this ITB.

19.06 The acceptance of the Bid will be by written Notice of Intent of Award posted in the County's website HighlandsFL.Gov through VendorRegistry.Com. In the event of failure of the lowest responsible qualified Bidder to perform, as prescribed herein, Owner may Award to the next lowest responsible and responsive qualified Bidder.

#### **Article 20 - Insurance**

20.01 The successful Bidder shall provide the required Certificate of Insurance within 15 calendar days from the Notice of Intent to Award or prior to commencement of work whichever is sooner.

#### **Article 21 - Signing of Agreement**

21.01 When Owner gives a Notice of Award to the successful Bidder, it shall be accompanied by the required number of unsigned counterparts of the Agreement with the other Contract Documents, which are identified in the Agreement attached thereto. Within fifteen (15) days thereafter, successful Bidder shall sign and deliver the required number of counterparts of the Agreement and attached Contract Documents to Owner. Within thirty (30) days thereafter, Owner shall deliver one fully signed counterpart to successful Bidder.

#### **Article 22 - Retainage**

22.01 Provisions concerning retainage are set forth in the Contract Documents.

### **Article 23 - Designated Contacts and Request for Information (RFI) Deadline**

- 23.01 All questions regarding this ITB must be submitted in writing.
- A. to the Purchasing Designated Contact (identified on the cover page of this solicitation.)
  - B. Prior to the deadline provided on the cover.
  - C. The County will release responses in the form of an Addendum. Addendums will be posted to the County's website: [www.highlandsfl.gov](http://www.highlandsfl.gov) via [www.VendorRegistry.com](http://www.VendorRegistry.com).
  - D. It is the Contractors responsibility to obtain and review all Addendums prior to bid submittal.
  - E. Note all communications during the solicitation process must be done through the Purchasing Department. If outside communications are determined it may be grounds to declare the Bidder non-responsive.



**DIVISION 00 - SECTION 00160**

**DRUG FREE WORKPLACE CERTIFICATION**

**CERTIFICATION PURSUANT TO SECTION 287.087, FLORIDA STATUTES**

**PREFERENCE TO DO BUSINESS WITH DRUG FREE WORKPLACE PROGRAMS**

**THIS FORM MUST BE SIGNED AND SWORN TO IN THE PRESENCE OF A NOTARY PUBLIC OR OTHER OFFICIAL AUTHORIZED TO ADMINISTER OATHS.**

1. This sworn statement is submitted to the HIGHLANDS COUNTY BOARD OF COUNTY COMMISSIONERS

by \_\_\_\_\_  
[Print individual's name and title]

for \_\_\_\_\_  
[Print name and state of incorporation or other formation of the entity submitting this sworn statement]

whose business address is \_\_\_\_\_ and

whose Federal Employer Identification Number (FEIN) is \_\_\_\_\_ (hereinafter referred to as "Bidder")

2. CERTIFICATION

Bidder hereby certifies that at the time of its Bid the Bidder has a drug free workplace program in place. The program meets the requirements of Section 287.087, Florida Statutes.

**THIS CERTIFICATION IS MADE PURSUANT TO SECTION 287.087, FLORIDA STATUTES, AND IS, UPON DELIVERY, A PUBLIC RECORD.**

\_\_\_\_\_  
Print Name: \_\_\_\_\_ Date: \_\_\_\_/\_\_\_\_/\_\_\_\_

STATE OF FLORIDA  
COUNTY OF \_\_\_\_\_

The foregoing Certification was sworn to before me this \_\_\_\_ day of \_\_\_\_\_, 20\_\_\_\_, by \_\_\_\_\_, as \_\_\_\_\_, the duly authorized officer of \_\_\_\_\_, on its behalf, who is either personally known to me [ ] or has produced \_\_\_\_\_ as identification [ ].

(AFFIX NOTARY SEAL)

Signature: \_\_\_\_\_  
Print Name: \_\_\_\_\_  
Notary Public, State of \_\_\_\_\_  
Commission No. \_\_\_\_\_  
My Commission Expires: \_\_\_\_\_

PUBLIC ENTITY CRIMES CERTIFICATION

**SWORN STATEMENT UNDER SECTION 287.133(3)(a), FLORIDA STATUTES,  
ON PUBLIC ENTITY CRIMES**

**THIS FORM MUST BE SIGNED AND SWORN TO IN THE PRESENCE OF A NOTARY PUBLIC OR OTHER  
OFFICIAL AUTHORIZED TO ADMINISTER OATHS.**

DESCRIPTION OF CONTRACT: \_\_\_\_\_

STATE OF FLORIDA                    }ss  
COUNTY OF \_\_\_\_\_ }

Before me, the undersigned authority, personally appeared \_\_\_\_\_ who, being by me first duly sworn, made the following statement:

1. The business address of \_\_\_\_\_ (name of bidder or contractor), is  
\_\_\_\_\_

2. I understand that a public entity crime as defined in Section 287.133 of the Florida Statutes includes a violation of any state or federal law by a person with respect to and directly related to the transaction of business with any public entity in Florida or with an agency or political subdivision of any other state or with the United States, including, but not limited to, any bid or contract for goods or services to be provided to any public entity or such an agency or political subdivision and involving antitrust, fraud, theft, bribery, collusion, racketeering, conspiracy or material misrepresentation.

3. I understand that "convicted" or "conviction" is defined by the statute to mean a finding of guilt or a conviction of a public entity crime, with or without an adjudication of guilt, in any federal or state trial court of record relating to charges brought by indictment or information after July 1, 1989, as a result of a jury verdict, non-jury trial, or entry of a plea of guilt or nolo contendere.

4. I understand that "affiliate" is defined by the statute to mean (1) a predecessor or successor of a person or a corporation convicted of a public entity crime, or (2) an entity under the control of any natural person who is active in the management of the entity and who has been convicted of a public entity crime, or (3) those officers, directors, executives, partners, shareholders, employees, members, and agents who are active in the management of an affiliate, or (4) a person or corporation who knowingly entered into a joint venture with a person who has been convicted of a public entity crime in Florida during the preceding 36 months.

5. Neither the bidder or contractor nor any officer, director, executive, partner, shareholder, employee, member or agent who is active in the management of the bidder or contractor nor any affiliate of the bidder or contractor has been convicted of a public entity crime subsequent to July 1, 1989.

*(Draw a line through paragraph 5 if paragraph 6 below applies.)*

6. There has been a conviction of a public entity crime by the bidder or contractor, or an officer, director, executive, partner, shareholder, employee, member or agent of the bidder or contractor who is active in the management of the bidder or contractor or an affiliate of the bidder or contractor. A determination has been made pursuant to 287.133(3)

by order of the Division of Administrative Hearings that it is not in the public interest for the name of the convicted person or affiliate to appear on the convicted vendor list. The name of the convicted person or affiliate is

\_\_\_\_\_.

A copy of the order of the Division of Administrative Hearings is attached to this statement.

*(Draw a line through paragraph 6 if paragraph 5 above applies.)*

**THIS SWORN STATEMENT IS MADE PURSUANT TO SECTION 287.133(3)A, FLORIDA STATUTES, AND IS, UPON DELIVERY, A PUBLIC RECORD**

Signature: \_\_\_\_\_

Print Name: \_\_\_\_\_

Print Title: \_\_\_\_\_

On \_\_\_\_ day of \_\_\_\_\_, 20\_\_\_\_.

Sworn and subscribed before me in the State and County first mentioned above on the \_\_\_\_\_ day of \_\_\_\_\_, 20\_\_\_\_.

Signature: \_\_\_\_\_

Print Name: \_\_\_\_\_

Notary Public, State of \_\_\_\_\_

Commission No. \_\_\_\_\_

My Commission Expires: \_\_\_\_\_

(AFFIX NOTARY SEAL)

**DISCRIMINATION CERTIFICATION**

**CERTIFICATION PURSUANT TO SECTION 287.134, FLORIDA STATUTES  
DISCRIMINATION; DENIAL OR REVOCATION OF THE RIGHT TO TRANSACT BUSINESS WITH  
PUBLIC ENTITIES**

**THIS FORM MUST BE SIGNED AND SWORN TO IN THE PRESENCE OF A NOTARY PUBLIC OR OTHER  
OFFICIAL AUTHORIZED TO ADMINISTER OATHS.**

1. This sworn statement is submitted to the HIGHLANDS COUNTY BOARD OF COUNTY COMMISSIONERS

by \_\_\_\_\_  
[Print individual's name and title]

for \_\_\_\_\_  
[Print name and state of incorporation or other formation of the entity submitting this sworn statement]

whose business address is \_\_\_\_\_ and

whose Federal Employer Identification Number (FEIN) is \_\_\_\_\_ (hereinafter referred to as "Bidder")

2. CERTIFICATION

Bidder hereby certifies that at the time of its Bid the Bidder has not been placed on the discriminatory vendor list by the Department of Management Services.

**THIS CERTIFICATION IS MADE PURSUANT TO SECTION 287.134, FLORIDA STATUTES, AND IS, UPON DELIVERY, A PUBLIC RECORD.**

\_\_\_\_\_  
Print Name: \_\_\_\_\_ Date: \_\_\_\_/\_\_\_\_/\_\_\_\_

STATE OF FLORIDA  
COUNTY OF \_\_\_\_\_

The foregoing Certification was sworn to before me this \_\_\_\_ day of \_\_\_\_\_, 20\_\_\_\_, by \_\_\_\_\_, as \_\_\_\_\_, the duly authorized officer of \_\_\_\_\_, on its behalf, who is either personally known to me [ ] or has produced \_\_\_\_\_ as identification [ ].

(AFFIX NOTARY SEAL)

Signature: \_\_\_\_\_  
Print Name: \_\_\_\_\_  
Notary Public, State of \_\_\_\_\_  
Commission No. \_\_\_\_\_  
My Commission Expires: \_\_\_\_\_

SCRUTINIZED COMPANIES CERTIFICATION

**CONTRACTING WITH SCRUTINIZED COMPANIES  
CERTIFICATION PURSUANT TO SECTION 287.135, FLORIDA STATUTES**

**THIS FORM MUST BE SIGNED AND SWORN TO IN THE PRESENCE OF A NOTARY PUBLIC OR  
OTHER OFFICIAL AUTHORIZED TO ADMINISTER OATHS.**

1. This sworn statement is submitted to the HIGHLANDS COUNTY BOARD OF COUNTY COMMISSIONERS

by \_\_\_\_\_  
[Print individual's name and title]

for \_\_\_\_\_  
[Print name and state of incorporation or other formation of the entity submitting this sworn statement]

whose business address is \_\_\_\_\_ and

whose Federal Employer Identification Number (FEIN) is \_\_\_\_\_ (hereinafter referred to as "Bidder")

2. CERTIFICATION

Bidder hereby certifies that at the time of its Bid the Bidder is not on the Scrutinized Companies that Boycott Israel list created pursuant to Section 215.4725, Florida Statutes, is not participating in a boycott of Israel, is not on the Scrutinized Companies with Activities in Sudan List or the Scrutinized Companies with Activities in the Iran Petroleum Energy Sector List and that it does not have business operations in Cuba or Syria.

**THIS CERTIFICATION IS MADE PURSUANT TO SECTION 287.135(5), FLORIDA STATUTES, AND IS, UPON DELIVERY, A PUBLIC RECORD.**

\_\_\_\_\_  
Print Name: \_\_\_\_\_

STATE OF \_\_\_\_\_  
COUNTY OF \_\_\_\_\_

The foregoing Certification was sworn to before me this \_\_\_ day of \_\_\_\_\_, 20\_\_\_, by \_\_\_\_\_, as \_\_\_\_\_, the duly authorized officer of \_\_\_\_\_, on its behalf, who is either personally known to me [ ] or has produced \_\_\_\_\_ as identification [ ].

(AFFIX NOTARY SEAL)

\_\_\_\_\_  
Print Name: \_\_\_\_\_  
Notary Public, State of Florida  
Commission No. \_\_\_\_\_  
My Commission Expires: \_\_\_\_\_



E-VERIFY CERTIFICATION

**CERTIFICATION OF PARTICIPATION IN THE UNITED STATES CITIZENSHIP AND IMMIGRATION SERVICE BUREAU'S E-VERIFY PROGRAM  
THIS FORM MUST BE SIGNED AND SWORN TO IN THE PRESENCE OF A NOTARY PUBLIC OR OTHER OFFICIAL AUTHORIZED TO ADMINISTER OATHS.**

1. This sworn statement is submitted to the HIGHLANDS COUNTY BOARD OF COUNTY COMMISSIONERS

by \_\_\_\_\_  
[Print individual's name and title]

for \_\_\_\_\_  
[Print name and state of incorporation or other formation of the entity submitting this sworn statement]

whose business address is \_\_\_\_\_ and

whose Federal Employer Identification Number (FEIN) is \_\_\_\_\_ (hereinafter referred to as "Bidder")

2. CERTIFICATION

Bidder hereby certifies that at the time of its Bid the Bidder participates in the United States Citizenship and Immigration Services Bureau's E-Verify Program, and does not knowingly employ, hire for employment, or continue to employ an unauthorized alien.

Bidder's E-verify Company ID #: \_\_\_\_\_

**THIS CERTIFICATION IS, UPON DELIVERY, A PUBLIC RECORD.**

\_\_\_\_\_  
Print Name: \_\_\_\_\_ Date: \_\_\_\_/\_\_\_\_/\_\_\_\_

STATE OF FLORIDA  
COUNTY OF \_\_\_\_\_

The foregoing Certification was sworn to before me this \_\_\_\_ day of \_\_\_\_\_, 20\_\_\_\_, by \_\_\_\_\_, as \_\_\_\_\_, the duly authorized officer of \_\_\_\_\_, on its behalf, who is either personally known to me [ ] or has produced \_\_\_\_\_ as identification [ ].

(AFFIX NOTARY SEAL)

Signature: \_\_\_\_\_  
Print Name: \_\_\_\_\_  
Notary Public, State of \_\_\_\_\_  
Commission No. \_\_\_\_\_  
My Commission Expires: \_\_\_\_\_

STATEMENT OF INDEMNIFICATION

The CONTRACTOR agrees to be liable for any and all damages, losses, and expenses incurred, by the COUNTY in any way related to the services provided herein and this Agreement, caused by the acts and/or omissions of the CONTRACTOR, or any of its employees, agents, sub-contractors, representatives, volunteers or the like. The CONTRACTOR agrees to indemnify, defend and hold the COUNTY harmless for any and all such claims, suits, judgments or damages, losses and expenses, including but not limited to, court costs, expert witnesses, consultation services and attorney’s fees, arising from any and all acts and/or omissions of the CONTRACTOR, or any of its employees, agents, sub-contractors, representatives, volunteers, or the like through and including any appeals in any way related to the services provided herein and this Agreement. Said indemnification, defense, and hold harmless actions shall not be limited by any required insurance coverage amounts set forth herein and shall survive termination or natural termination of this Agreement.

It is agreed by the undersigned Contractor that they accept the above conditions:

FOR THE CONTRACTOR:

\_\_\_\_\_

BY \_\_\_\_\_

\_\_\_\_\_  
Printed Name and Title

STATE OF FLORIDA, COUNTY OF \_\_\_\_\_

Sworn to and subscribed before me this on this \_\_\_\_\_ day of \_\_\_\_\_, 20\_\_\_\_.

Personally known \_\_\_\_\_ OR Produced identification \_\_\_\_\_ (Type of Identification)

\_\_\_\_\_  
(Signature of Notary Public)

SEAL

\_\_\_\_\_  
(Commission Expiration Date)





## TRENCH SAFETY CERTIFICATION

### FLORIDA TRENCH SAFETY ACT CERTIFICATION AND DISCLOSURE STATEMENT (MANDATORY)

The undersigned acknowledges the requirements of the Florida Trench Safety Act and hereby certifies that the undersigned is an authorized representative of the bidder and in that capacity commits the bidder to the following in the performance of the work in the event that the subject contract is awarded to and executed by said bidder.

- I. The bidder acknowledges the Florida Trench Safety Act and the requirements established herein.
2. The bidder further acknowledges that the aforementioned Act established the Federal excavation safety standards set forth at 29 CFR Part 1926.650, Subpart P as the interim State standard until such time as the State of Florida, through its Department of Labor and Employment Security, or any successor agency, adopts, updates or reviews said interim standard. This State of Florida standard may be supplemented by special shoring requirements established by the State of Florida or any of its political subdivisions.
3. The bidder, as Contractor, shall comply with all applicable excavation/trench safety standards.
4. The Contractor shall consider the geotechnical information available from the County, its own sources and all other relevant information in its design of the trench safety system it will employ on the subject project. The Contractor acknowledges that it is solely responsible for the selection of the data on which it relies in designing said safety system, as well as for the system itself.
5. The amount the bidder has set forth in the requirement titled "Florida Trench Safety Act" includes the following excavation/trench safety measures and the linear feet of trench excavated under each safety measure. These units, cost and the unit prices inferred shall be disclosed solely for the purpose of compliance with the procedural requirements of the aforementioned Act. No adjustment to the Contract Time or Price shall be made for any difference in the number of linear feet of trench excavation, except as may otherwise be provided in these Contract Documents.

Trench Safety Measure (Description)	Unit (QTY)	Unit of Measure  (LF, SY)	Unit Cost	Extended Cost
A.			\$	\$ _____
B.			\$	\$ _____
C.			\$	\$ _____
D.			\$	\$ _____
			TOTAL	\$ _____

Total above must be identical to cost shown in the requirement titled "Florida Trench Safety Act". (Use additional blank sheets to further itemize if more room is required.)

6. This amount disclosed as the cost of compliance with the applicable trench safety requirement does not constitute the extent of the Contractor's obligation to comply with said standards. Contractor shall expend additional sums, at no additional cost to the County (except as may otherwise be provided), which are necessary to so comply.
7. Acceptance of the bid to which this certification and disclosure applies in no way represents that the County or its representatives has evaluated and thereby determined that the above costs are adequate to comply with the applicable trench safety requirements nor does it in any way relieve the bidder, as Contractor, of its sole responsibility to comply with the applicable trench safety requirements.

\_\_\_\_\_  
(Authorized Signature)

\_\_\_\_\_  
(Typed name of firm, corporation, business or individual)

Sealed Submission Label

Cut along the outer border and affix this label to your sealed submission envelope to identify it as a “Sealed Bid/Proposal”

Deliver to: Highlands County Purchasing Department  
600 S. Commerce Ave., 2<sup>nd</sup> Floor  
Sebring, FL 33870  
Contact Information: Kelli Bronson, Purchasing Analyst  
(863) 402-6528

**PLEASE PRINT CLEARLY**



	<b>SEALED BID/PROPOSAL DOCUMENTS</b> <b>• DO NOT OPEN •</b>
SOLICITATION NO.:	ITB-24-005-KSB
SOLICITATION TITLE:	LAKE JUNE-IN-WINTER BMP'S FOR CATFISH CREEK-FLOATING ISLANDS AND BAFFLE BOX CONSTRUCTION (Project# 21062)
DATE DUE:	Tuesday, February 20, 2024
TIME DUE:	Prior to: 3:30 PM
SUBMITTED BY:	 (Name of Company)
e-mail address	Telephone
<b>DELIVER TO:</b>	Highlands County Board of County Commissioners Attn: Purchasing Department 600 South Commerce Avenue, 2 <sup>nd</sup> Floor Sebring, Florida 33870
<b>Note: submissions received after the time and date above will not be accepted.</b>	

\*Notice: The Date Due/Submission Deadline Date/Opening Date as stated on this label and other forms contained herein may have been updated via issuance of Addenda. It is the sole responsibility of the Contractor/Vendor to monitor the County webpage for any updates. Contractor/Vendor may strike through and update Date Due/Submission Deadline Date/Opening Date to match any updates to this date that have been published via Addenda.

## DIVISION 0 - SECTION 00250

### GENERAL TERMS AND CONDITIONS FOR CONSTRUCTION PROJECTS

- A. All Bidding Documents shall become the property of the County.
- B. Compliance with Florida Statutes Section 287.087, on Drug Free Workplace, Section 287.133(2)(a), on Public Entity Crimes, Section 287.134, on Discrimination, and Section 287.135, Prohibiting contracting with scrutinized companies is required.
- C. Bids are due and must be received in accordance with the instructions given in Section 00010 and 00100 of this ITB.
- D. Owner will not reimburse Bidder(s) for any costs associated with the preparation and submittal of any Bid.
- E. Bidders, their agents and associates shall NOT solicit any County official. Bidders, their agents and associates shall NOT contact any County official other than the Purchasing Designated Contact listed on the cover page of this ITB for additional information and clarification.
- F. Due care and diligence has been exercised in the preparation of this ITB and all information contained herein is believed to be substantially correct; however, the responsibility for determining the full extent of the service required rests solely with those making response. Neither Owner nor its representatives shall be responsible for any error or omission in the Bids submitted, nor for the failure on the part of the Bidders to determine the full extent of the exposures.
- G. All timely responses meeting the specifications set forth in this ITB will be considered. However, Bidders are cautioned to clearly indicate any deviations from these specifications. Any deviations are to be submitted in writing prior to the RFI deadline and approved via addendum to be acceptable. The terms and conditions contained herein are those desired by Owner and preference will be given to those Bids in full or substantially full compliance with them.
- H. Each Bidder is responsible for full and complete compliance with all laws, rules and regulations including those of the Federal Government, the State of Florida and the County of Highlands. Failure or inability on the part of the Bidder to have complete knowledge and intent to comply with such laws, rules and regulations shall not relieve the Bidder from its obligation to honor its Bid and to perform completely in accordance with its Bid.
- I. County, at its discretion, reserves the right to waive minor informalities or irregularities in any Bids, to reject any and all Bids in whole or in part, with or without cause, and to accept that Bid, if any, which in its judgment will be in its best interest.
- J. Award will be made to the Bidder whose Bid is determined to be the most advantageous to Owner, taking into consideration those Bids in compliance with the requirements as set forth in this ITB. The Board reserves the right to reject any and all Bids for any reason or make no Award whatsoever or request clarification of information from the Bidders.
- K. Any interpretation, clarification, correction or change to this ITB will be made by written addendum issued by the Purchasing Division. Any oral or other type of communication concerning this ITB shall not be binding.
- L. Bids must be signed by an individual of the Bidder's organization legally authorized to commit the Bidder to the performance of the product(s) and/or service(s) contemplated by this ITB.

M. The awarded Contractor shall comply with the County's and Florida Department of Transportation (as outlined in Local Agency Program Agreement) insurance requirements.

### **Contractor's Liability Insurance**

1. The Contractor shall not commence any work in connection with an agreement until it has obtained all of the following types of insurance and has provided proof of same to the Owner, in the form of a certificate prior to the start of any work, nor shall the Contractor allow any subcontractor to commence work on its subcontract until all similar insurance required of the subcontractor has been so obtained and approved. All insurance policies shall be with insurers qualified and doing business in Florida.
2. The Contractor and/or subcontractor shall maintain the following types of insurance, with the respective minimum limits:
  - a. GENERAL LIABILITY - One Million Dollars (\$1,000,000) any single occurrence;
  - b. AUTOMOBILE PUBLIC LIABILITY - \$1,000,000 Combined Single Limit
  - c. GENERAL AGGREGATE – Two Million Dollars (\$2,000,000);
  - d. WORKER'S COMPENSATION – covering the statutory obligation for all persons engaged in the performance of the work required hereunder and Employers' Liability insurance with limits not less than \$1,000,000 per occurrence. Evidence of qualified self-insurance status will suffice for this subsection (self-insurance is prohibited on Federal-aid funded projects). In case any class of employees engaged in hazardous work under an agreement at the site of the project is not protected under the Worker's Compensation statute, the Contractor shall provide, and cause each subcontractor to provide, adequate insurance, satisfactory to the COUNTY, for the protection of its employees not otherwise protected.
3. Certificates of Insurance: The Contractor shall provide the COUNTY's Procurement Services Department with a Certificate of Insurance evidencing such coverage for the duration of the awarded agreement. Said certificate shall be dated and show:
  - a. The name of the insured Contractor,
  - b. The specified job by name and job number,
  - c. The name of the insurer,
  - d. The number of the policy
  - e. The effective date
  - f. The termination date.
  - g. A statement that the insurer will mail notice to the COUNTY at least thirty (30) days prior to any material changes in the provisions or cancellation of the policy
4. County and State of Florida, **Southwest Florida Water Management District:**

- a. Additional insured verbiage: "Highlands County, a Political Subdivision of the State of Florida and its elected officials, its agents, employees, and volunteers" and Southwest Florida Water Management District shall be named as an "Additional Insured" on all policies except Worker's Compensation and Professional Liability.

5. Certificate Holder:

Highlands County Board of County Commissioners, Attn: Purchasing, 600 Commerce Ave., 2<sup>nd</sup> Floor, Sebring FL 33870.

6. Waiver: Receipt of certificates or other documentation of insurance or policies or copies of policies by the COUNTY, or by any of its representatives, which indicates less coverage than is required, does not constitute a waiver of the Contractor's obligations to fulfill the insurance requirements specified herein.
7. Loss Deductible Clause: The COUNTY shall be exempt from, and in no way liable for, any sums of money which may represent a deductible in any insurance policy. The payment of such deductible shall be the sole responsibility of the Contractor and/or subcontractor providing such insurance.
8. Additional Requirements: All insurance carriers shall have an AM Best Rating of at least A- and a size of VII or larger. The General Liability and Workers' Compensation policies shall have a waiver of subrogation in favor of Highlands County. The liability policies shall be Primary/Non-Contributory.

**Notice of Occurrence, Accident, Injury or Damage**

1. The Contractor shall promptly notify the County Contact Person, in writing, of any accident or occurrence involving injury to persons or damage of property during the course of construction. The report shall be made notwithstanding the fact that no injury or damage may be apparent at the time of the accident or occurrence. The Contractor shall also provide any supporting documentation reasonably requested by the Owner or the County Contact Person.
- N. If submitting a Bid for more than one ITB, each Bid must be in a separate envelope and correctly marked. Only one (1) Bid per project shall be accepted from any person, corporation or firm. Modifications will not be accepted or acknowledged.
- O. Bond requirements as stated in Section 0100, Article 8 Bonding Security.
- P. Each Bid is to contain proof of enrollment in E-Verify.
- Q. Board policy prohibits any County employee or members of their family from receiving any gift, benefit, and/or profit resulting from any contract or purchase. Board policy also prohibits acceptance of gifts of any kind with the exception of advertising novelties valued less than ten dollars (\$10.00).
- R. Construction Projects that are awarded for less than two hundred thousand dollars (\$200,000.00) and without a Public Construction Bond require the following provisions:
1. At any time prior to final completion of the Contract, Owner will not authorize or make payment to the Contractor in excess of ninety-five percent (95%) of the amount due on the Contract on the basis of the Work suitably completed.
  2. In case of the default by the Contractor, the laborers, materialmen, and Subcontractors, as defined in Section 713.01, Florida Statutes, making claims for unpaid bills, may be paid from the five percent (5%) retainage.

3. The final payment of retainage shall not be made until: (1) the Project has been inspected by the Project Manager or other person designated by the County for the purpose; (2) Project Manager or other designated person has issued a written certificate that the Project has been constructed in accordance with the approved Construction Documents and approved Change Orders; (3) the County has accepted the Project; and (4) the Contractor has supplied the County with signed and dated statements from all laborers, materialmen, and subcontractors as defined in Section 713.01, Florida Statutes, and identified under subparagraph (d) of this paragraph 2, that they have no claims against the Contractor for the Work under the Contract. Said statements shall identify the Project by name and Project number.
4. The Contractor, before beginning Work or within two (2) workdays, thereafter, shall post in a conspicuous place on the Site the following notice.

(remainder of page intentionally left blank)

“Notice is hereby made to all those concerned and affected that

CONTRACTOR’S NAME is performing the

**LAKE JUNE-IN-WINTER BMP’S FOR CATFISH CREEK-FLOATING ISLANDS AND BAFFLE BOX  
CONSTRUCTION**

**Highlands County Project No. 21062**

All parties furnishing labor and/or materials to said project must, within twenty (20) days of first providing such labor and/or materials, deliver notice of such in writing, by certified mail, returned receipt requested, to:

HIGHLANDS COUNTY BOARD OF COUNTY COMMISSIONERS  
ROAD AND BRIDGE DEPARTMENT

ATTN: **Dawn Ritter, Natural Resources Manager**  
4344 GEORGE BLVD. SEBRING, FLORIDA 33875

5. The Contractor shall provide a certified list of all Subcontractors, laborers, and material suppliers to the Owner or Designee within thirty (30) days of receiving the Notice to Proceed with the Work. This list shall be updated thereafter each month with a certified statement that the list and its updates include the names and address of all Subcontractors, laborers, and material suppliers furnishing labor and/or material for the Project.
  6. The Contractor shall provide a written statement with each pay request to the Project Manager which indicates how each payment will be distributed. This pay request breakdown shall define the disbursement intended for all the funds requested. When the Contractor receives any payment, it shall pay such moneys received to each Subcontractor and material supplier as set forth in that written statement.
  7. The Contractor shall provide a written statement with all but the first payment request from each of the Subcontractors, laborers, and material suppliers indicated in paragraph 5 of this Section R that they have in fact received payment as indicated in paragraph 6 of this Section R. In the event a payment is not made as indicated on a prior written statement provided pursuant to paragraph 6 of this Section R, the Contractor shall furnish an explanation as to the reasons for such deviation and shall request approval from the Project Manager.
- S. Late Bids will not be accepted under any circumstances. If Bids are received after the scheduled time of the Bid Opening Meeting, the Bidder will be contacted for disposition. The Purchasing Division, at the Bidder’s expense, can return the unopened envelope, or, at the Bidder’s request, in writing, can destroy it.
- T. Faxed Bids will not be accepted. Any blank spaces on the required Bid Form or the absence of required submittals or signatures may cause the Bid to be declared non-responsive.
- U. The County is not responsible for correcting any errors or typos made on the Bid response. Incorrect calculations may cause the Bid to be declared non-responsive. Where applicable, unit pricing will prevail in determining the extended price.
- V. Minority Owned and Women owned businesses are encouraged to submit a bid.
- W. The Bidder shall comply with the Florida Sales and Use Tax Law as it may apply to this Contract. The quoted amount(s) shall include any and all Florida Sales and Use Tax payment obligations required by Florida Law of the successful Bidder and/or its Subcontractors or material suppliers. The County reserves the right to obtain materials by Direct Purchase method.



- X. Public Records: Any material submitted in response to this ITB will become Public Record pursuant to Section 119(1)(b) and (c), Florida Statutes

1.1 Pursuant to Florida Statutes, Section 119.0701:

**IF YOU HAVE QUESTIONS REGARDING THE APPLICATION OF FLORIDA STATUTES, CHAPTER 119, TO YOUR DUTY TO PROVIDE PUBLIC RECORDS RELATING TO THIS CONTRACT, CONTACT THE COUNTY'S CUSTODIAN OF PUBLIC RECORDS:**

**COUNTY CLERK: GLORIA RYBINSKI  
COUNTY PUBLIC INFORMATION OFFICER  
600 SOUTH COMMERCE AVENUE  
SEBRING, FLORIDA 33870  
TELEPHONE NUMBER: (863) 402-6832  
[HCBCCRECORDS@HIGHLANDSFL.GOV](mailto:HCBCCRECORDS@HIGHLANDSFL.GOV)**

- 1.2 Consultant/Contractor agrees to comply with public records laws, specifically to:
- 1.1.1. Keep and maintain public records required by the County to perform the services set forth herein.
  - 1.1.2. Upon request from the County's custodian of public records, provide the County with a copy of the requested records or allow the records to be inspected or copied within a reasonable time at a cost that does not exceed the cost provided in Florida Statutes, Chapter 119, or as otherwise provided by law.
  - 1.1.3. Ensure that public records which are exempt or confidential and exempt from public records disclosure requirements are not disclosed, except as authorized by law, for the duration of the contract term and following completion of the contract if the Consultant/**Contractor** does not transfer the records to the County.

**Upon completion of the contract, transfer, at no cost, to the County all public records in possession of the Consultant/Contractor or keep and maintain public records required by the County to perform the services set forth herein. If the Consultant/Contractor transfers all public records to the County upon completion of the contract, the Consultant/Contractor shall destroy any duplicate public records that are exempt or confidential and exempt from public records disclosure requirements. If the Consultant/Contractor keeps and maintains public records upon completion of the contract, the Consultant/Contractor shall meet all applicable requirements for retaining public records. All records stored electronically must be provided to the County, upon request from the County's custodian of public records, in a format that is compatible with the information technology systems of the County.**

- Y. All pages included in or attached by reference to this ITB shall be called and constitute the Invitation to Bid.

Z. The Contractor agrees to comply with s.20.055(5), Florida Statutes, and to incorporate in all subcontracts the obligation to comply with s.20.055(5), Florida Statutes as shown below.

(5) It is the duty of every state officer, employee, agency, special district, board, commission, contractor, and subcontractor to cooperate with the inspector general in any investigation, audit, inspection, review, or hearing pursuant to this section. Beginning July 1, 2015, each contract, bid, proposal, and application or solicitation for a contract shall contain a statement that the corporation, partnership, or person understands and will comply with this subsection.

(remainder of page intentionally left blank)

**DIVISION 0 - SECTION 00300**

**BID FORM**

THIS BID IS SUBMITTED TO: Highlands County Board of County Commissioners  
Attn: Purchasing Division  
600 S Commerce Ave., Sebring, FL 33870

SOLICITATION IDENTIFICATION: **ITB 24-005-KSB**  
**Lake June-in-Winter BMP's for Catfish Creek-Floating Islands and Baffle Box Construction**

SOLICITATION NAME: **Highlands County Project No. 21026**

SUBMITTED BY:

\_\_\_\_\_  
Bidder's Name

\_\_\_\_\_  
Bidder's Authorized Representative's Name and Title

\_\_\_\_\_  
Bidder's Address 1

\_\_\_\_\_  
Bidder's Address 2

\_\_\_\_\_  
Contact's Name and Title (Print)

\_\_\_\_\_  
Contact's E-mail Address

\_\_\_\_\_  
Contact's Phone Number

\_\_\_\_\_  
Dun's Number

\_\_\_\_\_  
Employer Identification Number/Federal Employer Identification (as shown on Sunbiz.org)

BIDDER IS: (CHECK ONE)

Individual  
Limited Liability Company

Partnership

Corporation  
Joint Venture\*

\*Each joint venturer must sign. The manner of signing for each individual, partnership and corporation that is a party to the joint venture should be in the manner indicated above for an individual or the appropriate form of entity.)

- A. The Bidder proposes and agrees, if this Bid is accepted, to furnish all labor, materials, and equipment to construct and complete the Work according to and as specified or indicated in the solicitation identified above and the Bidding Documents for the Bid Price and within the time periods stated in this Bid and in accordance with the other terms and conditions of the Contract Documents.
- B. Bidder accepts all of the terms and conditions of the Advertisement or Invitation to Bid and Instructions to Bidders, including without limitation those dealing with the disposition of Bid security. This Bid will remain subject to acceptance for thirty (30) days after the day of Bid opening. Bidder will sign and deliver the required number of the other documents required by this ITB within fifteen (15) days after the date of County's Notice of Award.

C. ACKNOWLEDGEMENT OF ADENDA Bidder/Proposer represents that:

- It is the sole responsibility of the bidder/proposer to check the Purchasing web-site for any addenda issued for this solicitation.
- Bidder/Proposer acknowledges they have examined and carefully studied this solicitation and the following Addenda (receipt of all which is hereby acknowledged):

Addenda Number	Date Issued	Addenda Number	Date Issued	Addenda Number	Date Issued	Addenda Number	Date Issued

1. Bidder has visited the Site and become familiar with and is satisfied as to the general, local, and Site conditions that may affect cost, progress, performance, and furnishing of the Work;
2. Bidder is familiar with and is satisfied as to all Laws and Regulations that may affect cost, progress, performance, and furnishing of the Work.
3. Bidder acknowledges that County and Project Manager do not assume responsibility for the accuracy or completeness of information and data shown or indicated in the Bidding Documents with respect to Underground Facilities at or contiguous to the Site. Bidder has obtained and carefully studied (or assumes responsibility for having done so) all such additional or supplementary examinations, investigations, explorations, tests, studies, and data concerning conditions (surface, subsurface, and Underground Facilities) at or contiguous to the Site or otherwise which may affect cost progress, performance or furnishing of the Work or which relate to any aspect of the means, methods, techniques, sequences, and procedures of construction to be employed by Bidder and safety precautions and programs incident thereto. Bidder does not consider that any additional examinations, investigations, explorations, tests, studies or data are necessary for the determination of this Bid for performance and furnishing of the Work in accordance with the times, price, and other terms and conditions of the Contract Documents.
4. Bidder is aware of the general nature of the Work to be performed by County and others at the Site that relates to the Work.
5. Bidder has correlated information known to Bidder, information and observations obtained from visits to the Site and all additional examinations, investigations, explorations, tests, studies, and data with the Contract Documents.
6. Bidder has given Project Manager written notice of all conflicts, errors, ambiguities or discrepancies that Bidder has discovered in the Bidding Documents and the written resolution thereof by Project Manager is acceptable to Bidder, and the Bidding Documents are generally sufficient to indicate and convey understanding of all terms and conditions for performing and furnishing the Work.
7. This Bid is genuine and not made in the interest of or on behalf of any undisclosed person, firm or corporation and is not submitted in conformity with any agreement or rules of any group, association, organization or corporation. Bidder has not directly or indirectly induced or solicited any other Bidder to submit a false or sham Bid. Bidder has not solicited or induced any person, firm or corporation to refrain from Bidding; Bidder is not privy to any information or have any

knowledge of any information pertaining to this ITB to which other Bidders do not have access; and Bidder has not sought by collusion or any other means to obtain for itself any advantage over any other Bidder or over County.

D. Pricing

1. **Award will be made to the lowest responsive and responsible bidder based on the total Lump Sum Bid Price. In the event of a mathematical error unit pricing shall prevail to determine the extended price.** The awarded Bidder will complete the Work in accordance with the Contract Documents All work for this ITB will be awarded to one (1) Bidder. Bidder agrees to hold pricing for 120 calendar days from the solicitation deadline.

**COSTS:**

**Insert the Itemized Bid Form**

- E. **Term:** Bidder agrees that the Work will be **substantially complete** within **two hundred fifteen (215) calendar days but cannot exceed December 31, 2024**, and achieve **final completion** and ready for final payment within **two-hundred forty-five (245) calendar days** after the date when the Contract Times commence to run. The Contract Times will commence to run on the thirteenth (13<sup>th</sup>) day after the Effective Date of the Agreement or, if a Notice to Proceed is given, on the day indicated in the Notice to Proceed. A Notice to Proceed may be given at any time within thirty (30) days after the Effective Date of the Agreement.
- F. **Liquidated Damages:** Owner and Contractor recognize that time is of the essence of this Agreement, and that Owner will suffer financial loss if the Work is not completed within the times specified. In agreeing upon the daily liquidated damages amount stated in this paragraph, Owner and Contractor have considered the original Contract Price, the average construction, engineering, and inspection costs experienced by Owner, and anticipated costs of project-related delays and inconveniences to Owner and the public. Owner and Contractor also recognize the delays, expense, and difficulties involved in proving the actual loss suffered by Owner if the Work is not completed on time. Accordingly, instead of requiring any such proof, Owner and Contractor agree that as liquidated damages for delay (and not as a penalty) Contractor shall pay Owner **One-Thousand One Hundred Seventy Dollars (\$1,170.00)** for each calendar day that expires after the time specified in paragraph 3.01 of this Article until the Work is completed and ready for final payment. Liquidated damages shall be deducted by Owner from any balance due Contractor or, if the balance due Contractor is less than the amount of liquidated damages, Contractor shall pay to Owner the remaining unpaid liquidated damages within thirty (30) days after Owner's invoice is sent to Contractor.

Owner does not waive its right to liquidated damages due under this Agreement by allowing Contractor to continue and to finish the Work, or any part of it, after the expiration of the Contract Time including granted time extensions.

In the case of a default of this Agreement and the completion of the Work by Owner, Contractor and Contractor's surety are liable for the liquidated damages under this Agreement, but Owner will not charge liquidated damages for any delay in the final completion of Owner's performance of the Work due to any unreasonable action or delay on the part of Owner.

- G. Bidder shall coordinate with the Project Manager in order to comply with all applicable quality control testing in accordance with the Drawings and Specification.
- H. **Statement of Acknowledgement: The Contractor agrees to comply with s.20.055(5), Florida Statutes, and to incorporate in all subcontracts the obligation to comply with s.20.055(5), Florida Statutes as shown below.**

**(5) It is the duty of every state officer, employee, agency, special district, board, commission, contractor, and subcontractor to cooperate with the inspector general in any investigation, audit, inspection, review, or hearing pursuant to this section. Beginning July 1, 2015, each contract, bid, proposal, and application or solicitation for a contract shall contain a statement that the corporation, partnership, or person understands and will comply with this subsection.**

- I. Communications concerning this Bid have been addressed only to the contacts listed in Article 23 of Section 00100 of ITB 24-005-KSB.

Submitted on: \_\_\_\_\_, 20\_\_\_\_\_.

State Contractor License No. \_\_\_\_\_ EXPIRATION \_\_\_\_\_

*If Bidder is an Individual:*

(SEAL)

Individual's name: \_\_\_\_\_

Signature: \_\_\_\_\_

Doing business as: \_\_\_\_\_

Business address: \_\_\_\_\_

Phone No.: \_\_\_\_\_

*If Bidder is a Partnership:*

(SEAL)

Partnership's name: \_\_\_\_\_

State in which organized: \_\_\_\_\_

Type of partnership: \_\_\_\_\_

Name of general partner: \_\_\_\_\_

Signature: \_\_\_\_\_

Business address: \_\_\_\_\_

Phone No.: \_\_\_\_\_

*If Bidder is a Corporation:*

(SEAL)

Corporation's name: \_\_\_\_\_

State of incorporation: \_\_\_\_\_

Name of authorized person to sign: \_\_\_\_\_

Title: \_\_\_\_\_

Signature: \_\_\_\_\_

---

Date of qualification to do business:

Attest:

Business address:

Phone No.:

*If Bidder is a Limited Liability Company:*

Limited Liability Company's name:

State in which registered:

Type of limited liability company  
(member managed or manager  
managed)

Name of manager or authorized  
member to sign:

Signature:

Business address:

Phone No.:



*If Bidder is a Joint Venture:*

(SEAL)

Name 1: \_\_\_\_\_

Signature 1: \_\_\_\_\_

Address 1: \_\_\_\_\_

Name 2: \_\_\_\_\_

Signature 2: \_\_\_\_\_

Address 2: \_\_\_\_\_

Address for receipt of official  
communications: \_\_\_\_\_

Phone number for official  
communications: \_\_\_\_\_

(Each joint venturer must sign. The manner of signing for each individual, partnership and corporation that is a party to the joint venture should be in the manner indicated above for an individual or the appropriate form of entity.)

**Bidder****Name:**

TASK NO.	DESCRIPTION	QUANT ITY	UNIT	UNIT PRICE	Extended Price (Qty*Unit)
<b>BAFFEL/FILTER BOX</b>					
1	MOBILIZATION & DEMOBILIZATION	1	LS		
2	MAINTENACE OF TRAFFIC	1	LS		
3	EROSION CONTROL, SILT FENCE	164	LF		
4	EROSION CONTROL, FLOATING TURBIDITY BARRIER	120	LF		
5	GENERAL REQUIREMENTS (INCLUDING PROJECT INFORMATIONAL SIGN)	1	LS		
6	CLEARING AND DEMOLITION (PARTIOAL REMOVAL OF FABRIFORM FOR PIPE INSTALLATION)	1	LS		
7	EARTHWORK	1	LS		
8	OLDCASTLE NRFS 6'X12' FILTER BOX WITH BOLD & GOLD ECT3 FILTER MEDIA (OR APPROVED EQUAL)	1	EA		
9	PIPE CULVERT (PVC), 8" ROUND	32	LF		
10	EXISTING INLET MODIFICATION (TO TIE-IN PROPOSED 8" PVC PIPE)	1	LS		
11	CONCRETE PIPE BLOCK, 0.5' X 2'	1	LS		
12	CONCRETE SLOPE PAVEMENT, 6" THICK (REPLACING SLOPE PROTECTION WHERE CONCRETE FABRIFORM WAS REMOVED)	1	LS		
13	RIPRAP RUBBLE, DITCH LINING (SUMP AT 8" PVC PIPE INFLOW)	10	TN		
14	RESTORATION SODDING (APPLIED TO ALL DISTURBED AREAS)	800	SY		
<b>FLOATING ISLANDS</b>					
1	MOBILIZATION & DEMOBILIZATION	1	LF		
2	GENERAL REQUIREMENTS (INCLUDING PROJECT INFORMATIONAL SIGN)	1	LS		
3	BIOHAVEN 6.5' X 6' FLOATING TREATMENT WETLAND MATS WITH BOTTOM-MOUNTED ANCHOR POINTS (OR APPROVED EQUAL)	5	EA		
4	CONCRETE ANCHOR (FORMED FROM 12" HIGH, 12" DIAMETER CYLINDRICAL FORM) AND SYNTHETIC BRAIDED TETHERING ROPES	5	EA		

**Bidder**  
**Name:**

TASK NO.	DESCRIPTION	QUANT ITY	UNIT	UNIT PRICE	Extended Price (Qty*Unit)
5	PLANTINGS: PICKERELWEED (MINIMUM 2" CONTRAINER AND 12" HIGH)	100	EA		
6	PLANTINGS: SOFTRUSH (MINIMUM 2" CONTAINER AND 12" HIGH)	85	EA		
<b>TOTAL LUMP SUM BID AMOUNT</b> [numeric]				\$	

**TOTAL LUMP SUM BID AMOUNT [in words]** \_\_\_\_\_

\_\_\_\_\_

**DIVISION 0 – SECTION 00410  
BID BOND  
ITB 24-005-KSB**

STATE OF FLORIDA COUNTY OF  
HIGHLANDS

KNOW ALL MEN BY THESE PRESENTS, that we \_\_\_\_\_  
(hereinafter called "Principal"), and \_\_\_\_\_ as Surety, (hereinafter called "Surety"),  
are held and firmly bound unto the Highlands County, a political subdivision of the State of Florida  
(hereinafter called "Owner"), in the sum of \_\_\_\_\_ Dollars (\$ \_\_\_\_\_), lawful  
money of the United States of America, for the payment of which sum well and truly to be made, we bind  
ourselves, our heirs, executors, administrators and successors, jointly and severally, firmly by these  
presents:

WHEREAS, the "Principal" contemplates submitting or has submitted to bid to the said "Owner"  
for Bid No. ITB 24-005-KSB:

**Lake June-in-Winter BMP's for Catfish Creek-Floating Islands and Baffle Box Construction,  
Highlands County Project No. 21062**

WHEREAS, it was a condition precedent to the submission of said bid that a certified check or  
bid bond in the amount of not less than five percent (5%) of the amount of bid be submitted with said  
bid as a guarantee that the Bidder would, if awarded the contract, enter into a written contract with the  
"Owner" within fifteen (15) consecutive calendar days after having been given notice of award of the  
contract.

NOW, THEREFORE, THE CONDITIONS OF THIS OBLIGATION ARE SUCH, that if the bid of the  
"Principal" herein be accepted and said "Principal", within fifteen (15) consecutive calendar days after  
notice being given of such acceptance, enter into a written contract with the "Owner", then this obligation  
shall be void; otherwise, the sum herein stated shall be due and payable to the "Owner", and the "Surety"  
herein agrees to pay said sum immediately upon demand of said "Owner", in good and lawful money  
of the United States of America; as liquidated damages for failure thereof said "Principal".

IN WITNESS WHEREOF, the said \_\_\_\_\_, as "Principal" herein, has caused these presents to be signed in its name by its \_\_\_\_\_ and attested by its \_\_\_\_\_ under its corporate seal, and the said \_\_\_\_\_ as "Surety" herein, has caused these presents to be signed in its \_\_\_\_\_ and attested by its \_\_\_\_\_ under its corporate seal, this \_\_\_\_\_ day of \_\_\_\_\_, A.D. 20\_\_.

ATTEST:

\_\_\_\_\_

Title: \_\_\_\_\_

CONTRACTOR, AS PRINCIPAL:

\_\_\_\_\_

By: \_\_\_\_\_ (Seal)

Title: \_\_\_\_\_

ATTEST:

\_\_\_\_\_

Title: \_\_\_\_\_

AS SURETY:

\_\_\_\_\_

By: \_\_\_\_\_ (Seal)

Title: \_\_\_\_\_

**DIVISION 0 - SECTION 00600**  
**PUBLIC CONSTRUCTION BOND**  
**ITB 24-005-KSB**  
(Section 255.05(3), Florida Statutes)

Bond No. \_\_\_\_\_

BY THIS BOND, we, \_\_\_\_\_,  
whose principal business address and phone number are \_\_\_\_\_  
(\_\_\_\_\_), as Principal and \_\_\_\_\_, whose principal business  
address and phone number are \_\_\_\_\_ (\_\_\_\_\_), as Surety, are bound to  
Highlands County, a political subdivision of the State of Florida, herein called Owner, whose principal business  
address and telephone number are 600 South Commerce Avenue, Sebring, Florida 33870 (863-402-6500), in  
the sum of \_\_\_\_\_ (\$\_\_\_\_\_), for payment of which we bind ourselves,  
our heirs, personal representatives, successors, and assigns, jointly and severally.

THE CONDITION OF THIS BOND is that if Principal:

1. Performs the Contract dated \_\_\_\_\_, between Principal and Owner for construction of the **Lake June-in-Winter BMPs for Catfish Creek-Floating Islands and Baffle Box Construction, Highlands County Project No. 21062**, that Contract being made a part of this bond by reference, at the times and in the manner prescribed in the contract; and
2. Promptly makes payments to all claimants, as defined in Section 255.05(1), Florida Statutes, supplying Principal with labor, services, materials, or supplies, used directly or indirectly by Principal in the prosecution of the work provided for in that Contract; and
3. Pays Owner all losses, damages, expenses, costs, and attorney's fees, including appellate proceedings, that Owner sustains because of a default by Principal under that Contract; and
4. Performs the Principal's guarantee of all work and materials furnished under that Contract for the time specified in that Contract, then this Bond is void; otherwise it remains in full force.

Any action instituted by a claimant under this Bond for payment must be in accordance with the notice and time limitation provisions in Section 255.05(2) and (10), Florida Statutes.

Any changes in or under the Contract Documents and compliance or noncompliance with any formalities connected with that Contract or the changes does not affect Surety's obligation under this Bond.

Dated \_\_\_\_\_, 20\_\_\_\_\_.

AS SURETY:

CONTRACTOR, AS PRINCIPAL:

\_\_\_\_\_

\_\_\_\_\_

By: \_\_\_\_\_  
(As Attorney in Fact)

By: \_\_\_\_\_  
Title: \_\_\_\_\_

## **INSTRUCTIONS FOR PUBLIC CONSTRUCTION BOND**

1. A good and sufficient Public Construction Bond, in the penal sum of not less than one hundred percent (100%) of the Contract Price, with a Surety Company satisfactory to the County, will be required of Contractor guaranteeing that the contract, including the various guarantee periods thereunder will be faithfully performed; and that Contractor will promptly make payment to all persons supplying Contractor labor, materials, supplies and services used directly or indirectly by Contractor in the prosecution of the work provided for in the Contract.
2. The Surety Company furnishing this Bond shall be authorized to do business in the State of Florida, shall be in compliance with the provisions of the Florida Insurance Code, shall have twice the minimum surplus and capital required by the Florida Insurance Code, and shall hold a currently valid certificate of authority issued by the United States Department of Treasury pursuant to Title 31, Sections 9304-9308, of the United States Code. Surety Company must have a rating of not less than "A-X" by the latest edition of the KEY RATING GUIDE as published by A.M. Best Company, Inc., A.M. Best Road, Oldwick, NJ 08858.
3. The Attorney-in-Fact (Resident Agent) who executes the Public Construction Bond on behalf of the Surety Company must attach a notarized copy of his or her power-of-attorney as evidence of his or her authority to bind the Surety Company on the date of execution of the bonds. All signatures must be original. No copied or facsimile signatures will be accepted. All Contracts, Public Construction Bond, and respective powers-of-attorney will have the same date.
4. In the event the Surety Company becomes unsatisfactory to the County, County may at its discretion, require from Contractor an additional or new bond in the same or lessor penal sum, satisfactory to the County, and to be conditioned as above required. Upon Contractor's failure to furnish such additional or new bond within ten (10) days from the date of written notice to do so, all payments under the Contract will be withheld until such additional bond is furnished.

**DIVISION 0 - SECTION 00700**

**GENERAL CONDITIONS**

**TABLE OF CONTENTS**

ARTICLE 1: DEFINITIONS AND TERMINOLOGY..... 1

    1.01 Defined Terms ..... 1

    1.02 Terminology..... 4

ARTICLE 2: PRELIMINARY MATTERS ..... 5

    2.01 Delivery of Bonds and Evidence of Insurance..... 5

    2.02 Copies of Documents..... 5

    2.03 Before Starting Construction ..... 6

    2.04 Preconstruction Conference; Designation of Authorized Representatives ..... 6

    2.05 Initial Acceptance of Schedules ..... 6

    2.06 Electronic Transmittals ..... 7

ARTICLE 3: DOCUMENTS: INTENT, REQUIREMENTS, REUSE..... 7

    3.01 Intent..... 7

    3.02 Reference Standards ..... 7

    3.03 Reporting and Resolving Discrepancies ..... 7

    3.04 Requirements of the Contract Documents ..... 8

    3.05 Reuse of Documents ..... 9

ARTICLE 4: COMMENCEMENT AND PROGRESS OF THE WORK..... 9

    4.01 Commencement of Contract Times; Notice to Proceed ..... 9

    4.02 Starting the Work ..... 9

    4.03 Reference Points ..... 9

    4.04 Progress Schedule..... 9

    4.05 Delays in Contractor’s Progress..... 9

ARTICLE 5: AVAILABILITY OF LANDS; SUBSURFACE AND PHYSICAL CONDITIONS;  
HAZARDOUS ENVIRONMENTAL CONDITIONS ..... 10

    5.01 Availability of Lands ..... 10

    5.02 Use of Site and Other Areas ..... 11

    5.03 Subsurface and Physical Conditions..... 12

    5.04 Differing Subsurface or Physical Conditions ..... 12

    5.05 Underground Facilities ..... 14

    5.06 Hazardous Environmental Conditions at Site..... 14

ARTICLE 6: CONTRACTOR’S RESPONSIBILITIES ..... 15

    6.01 Supervision and Superintendence ..... 16

    6.02 Labor; Working Hours ..... 16

    6.03 Services, Materials, and Equipment..... 16



6.04	“Or Equals” .....	17
6.05	Substitutes .....	17
6.06	Concerning Subcontractors, Suppliers, and Others .....	19
6.07	Patent Fees and Royalties .....	20
6.08	Permits .....	20
6.09	Taxes .....	20
6.10	Laws and Regulations .....	21
6.11	Record Documents .....	22
6.12	Safety and Protection .....	22
6.13	Safety Representative .....	23
6.14	Hazard Communication Programs .....	23
6.15	Emergencies .....	23
6.16	Shop Drawings, Samples, and Other Submittals .....	23
6.17	Contractor’s General Warranty and Guarantee .....	25
6.18	Indemnification .....	26
6.19	Delegation of Professional Design Services .....	26
6.20	Storage of Materials .....	27
6.21	Erosion and Drainage Control .....	27
6.22	Protection of Trees and Natural Conditions .....	27
6.23	Dewatering .....	27
6.24	Protection of Public and Private Property .....	27
6.25	Maintenance of Traffic .....	28
6.26	Testing .....	28
6.27	Unfavorable Construction Conditions .....	28
6.28	Notices to Owners and Authorities .....	28
6.29	Storage of Fuel or Hazardous Materials .....	29
ARTICLE 7: OTHER WORK AT THE SITE .....		29
7.01	Other Work .....	29
7.02	Coordination .....	29
7.03	Legal Relationships .....	29
ARTICLE 8: OWNER’S RESPONSIBILITIES .....		30
8.01	Communications to Contractor .....	30
8.02	Replacement of Engineer .....	30
8.03	Furnish Data .....	31
8.04	Pay When Due .....	31
8.05	Lands and Easements; Reports, Tests, and Drawings .....	31
8.06	Insurance .....	31
8.07	Change Orders .....	31

8.08	Inspections, Tests, and Approvals .....	31
8.09	Limitations on Owner’s Responsibilities .....	31
8.10	Undisclosed Hazardous Environmental Condition .....	31
8.11	Evidence of Financial Arrangements.....	31
8.12	Safety Programs .....	31
ARTICLE 9:	ENGINEER’S STATUS DURING CONSTRUCTION .....	31
9.01	Owner’s Representative .....	31
9.02	Visits to Site .....	32
9.03	Project Representative .....	32
9.04	Rejecting Defective Work.....	32
9.05	Shop Drawings, Change Orders and Payments .....	32
9.06	Determinations for Unit Price Work.....	32
9.07	Decisions on Requirements of Contract Documents and Acceptability of Work .....	32
9.08	Limitations on Engineer’s Authority and Responsibilities .....	33
9.09	Compliance with Safety Program.....	33
ARTICLE 10:	AMENDING THE CONTRACT DOCUMENTS; CHANGES IN THE WORK.....	33
10.01	Amending and Supplementing Contract Documents .....	33
10.02	Owner-Authorized Changes in the Work.....	34
10.03	Unauthorized Changes in the Work .....	34
10.04	Change of Contract Price.....	34
10.05	Change of Contract Times .....	35
10.06	Change Proposals .....	35
10.07	Execution of Change Orders.....	36
10.08	Notification to Surety.....	36
ARTICLE 11:	CLAIMS .....	36
11.01	Claims.....	37
ARTICLE 12:	COST OF THE WORK; ALLOWANCES; UNIT PRICE WORK.....	38
12.01	Cost of the Work .....	38
12.02	Allowances .....	40
12.03	Unit Price Work.....	40
ARTICLE 13:	TESTS AND INSPECTIONS; CORRECTION, REMOVAL OR ACCEPTANCE OF DEFECTIVE WORK.....	41
13.01	Access to Work.....	41
13.02	Tests, Inspections, and Approvals .....	41
13.03	Defective Work.....	42
13.04	Acceptance of Defective Work.....	42
13.05	Uncovering Work .....	42
13.06	Owner May Stop the Work.....	43
13.07	Owner May Correct Defective Work.....	43

ARTICLE 14:	PAYMENTS TO CONTRACTOR; SET-OFFS; COMPLETION; CORRECTION PERIOD	43
14.01	Progress Payments.....	44
14.02	Contractor's Warranty of Title .....	47
14.03	Substantial Completion .....	47
14.04	Partial Use or Occupancy .....	48
14.05	Final Inspection .....	48
14.06	Final Payment.....	48
14.07	Waiver of Claims.....	49
14.08	Correction Period .....	49
14.09	Local Government Prompt Payment Act .....	50
14.10	Interest.....	50
ARTICLE 15:	SUSPENSION OF WORK AND TERMINATION .....	50
15.01	Owner May Suspend Work .....	50
15.02	Owner May Terminate for Cause .....	51
15.03	Owner May Terminate For Convenience .....	52
15.04	Contractor May Stop Work or Terminate.....	52
ARTICLE 16:	FINAL RESOLUTION OF DISPUTES .....	52
16.01	Methods and Procedures .....	52
ARTICLE 17:	MISCELLANEOUS .....	53
17.01	Giving Notice .....	53
17.02	Computation of Times .....	53
17.03	Cumulative Remedies.....	53
17.04	Limitation of Damages .....	53
17.05	No Waiver.....	53
17.06	Survival of Obligations .....	53
17.07	Controlling Law .....	53
17.08	Headings .....	53

## ARTICLE 1: DEFINITIONS AND TERMINOLOGY

### 1.01 *Defined Terms*

- A. Wherever used in the Bidding Requirements or Contract Documents, a term printed with initial capital letters, including the term's singular and plural forms, will have the meaning indicated in the definitions below. In addition to terms specifically defined, terms with initial capital letters in the Contract Documents include references to identified articles and paragraphs, and the titles of other documents or forms.
1. *Addenda*—Written or graphic instruments issued prior to the opening of Bids which clarify, correct, or change the Bidding Requirements or the proposed Contract Documents.
  2. *Agreement*—The written instrument, executed by Owner and Contractor, that sets forth the Contract Price and Contract Times, identifies the parties and the Engineer, and designates the specific items that are Contract Documents.
  3. *Application for Payment*—The form acceptable to Engineer which is to be used by Contractor during the course of the Work in requesting progress or final payments and which is to be accompanied by such supporting documentation as is required by the Contract Documents.
  4. *Bid*—The offer of a Bidder submitted on the prescribed form setting forth the prices for the Work to be performed.
  5. *Bidder*—An individual or entity that submits a Bid to Owner.
  6. *Bidding Documents*—The Bidding Requirements, the proposed Contract Documents, and all Addenda.
  7. *Bidding Requirements*—The Advertisement or Invitation to Bid, Instructions to Bidders, Bid Bond or other Bid security, if any, the Bid Form, and the Bid with any attachments.
  8. *Change Order*—A document which is signed by Contractor and Owner and authorizes an addition, deletion, or revision in the Work or an adjustment in the Contract Price or the Contract Times, or other revision to the Contract, issued on or after the Effective Date of the Contract.
  9. *Change Proposal*—A written request by Contractor, duly submitted in compliance with the procedural requirements set forth herein, seeking an adjustment in Contract Price or Contract Times, or both; contesting an initial decision by Engineer concerning the requirements of the Contract Documents or the acceptability of Work under the Contract Documents; challenging a set-off against payments due; or seeking other relief with respect to the terms of the Contract.
  10. *Claim*—(a) A demand or assertion by Owner directly to Contractor, duly submitted in compliance with the procedural requirements set forth herein: seeking an adjustment of Contract Price or Contract Times, or both; contesting an initial decision by Engineer concerning the requirements of the Contract Documents or the acceptability of Work under the Contract Documents; contesting Engineer's decision regarding a Change Proposal; seeking resolution of a contractual issue that Engineer has declined to address; or seeking other relief with respect to the terms of the Contract; or (b) a demand or assertion by Contractor directly to Owner, duly submitted in compliance with the procedural requirements set forth herein, contesting Engineer's decision regarding a Change Proposal; or seeking resolution of a contractual issue that Engineer has declined to address. A demand for money or services by a third party is not a Claim.
  11. *Constituent of Concern*—Asbestos, petroleum, radioactive materials, polychlorinated biphenyls (PCBs), hazardous waste, and any substance, product, waste, or other material of any nature whatsoever that is or becomes listed, regulated, or addressed pursuant to (a) the Comprehensive Environmental Response, Compensation and Liability Act, 42 U.S.C. §§9601 et seq. ("CERCLA");

(b) the Hazardous Materials Transportation Act, 49 U.S.C. §§5501 et seq.; (c) the Resource Conservation and Recovery Act, 42 U.S.C. §§6901 et seq. ("RCRA"); (d) the Toxic Substances Control Act, 15 U.S.C. §§2601 et seq.; (e) the Clean Water Act, 33 U.S.C. §§1251 et seq.; (f) the Clean Air Act, 42 U.S.C. §§7401 et seq.; or (g) any other federal, state, or local statute, law, rule, regulation, ordinance, resolution, code, order, or decree regulating, relating to, or imposing liability or standards of conduct concerning, any hazardous, toxic, or dangerous waste, substance, or material.

12. *Contract*—The entire and integrated written contract between the Owner and Contractor concerning the Work.
13. *Contract Documents*—Those items so designated in the Agreement, and which together comprise the Contract.
14. *Contract Price*—The money that Owner has agreed to pay Contractor for completion of the Work in accordance with the Contract Documents. .
15. *Contract Times*—The number of days or the dates by which Contractor shall: (a) achieve Milestones, if any; (b) achieve Substantial Completion; and (c) complete the Work.
16. *Contractor*—The individual or entity with which Owner has contracted for performance of the Work.
17. *Cost of the Work*—See Paragraph 12.01 for definition.
18. *Drawings*—The part of the Contract that graphically shows the scope, extent, and character of the Work to be performed by Contractor.
19. *Effective Date of the Contract*—The date, indicated in the Agreement, on which the Contract becomes effective.
20. *Engineer*—The individual or entity named as such in the Agreement.
21. *Field Order*—A written order issued by Engineer which requires minor changes in the Work but does not change the Contract Price or the Contract Times.
22. *Hazardous Environmental Condition*—The presence at the Site of Constituents of Concern in such quantities or circumstances that may present a danger to persons or property exposed thereto. The presence at the Site of materials that are necessary for the execution of the Work, or that are to be incorporated in the Work, and that are controlled and contained pursuant to industry practices, Laws and Regulations, and the requirements of the Contract, does not establish a Hazardous Environmental Condition.
23. *Laws and Regulations; Laws or Regulations*—Any and all applicable laws, statutes, rules, regulations, ordinances, codes, and orders of any and all governmental bodies, agencies, authorities, and courts having jurisdiction.
24. *Liens*— Charges, security, interests, or encumbrances upon Contract – related funds, real property, or personal property and claims delivered to Owner by laborers, Subcontractors, and Suppliers who have not been paid by Contractor.
25. *Milestone*—A principal event in the performance of the Work that the Contract requires Contractor to achieve by an intermediate completion date or by a time prior to Substantial Completion of all the Work.
26. *Notice of Award*—The written notice by Owner to a Bidder of Owner's acceptance of the Bid.
27. *Notice to Proceed*—A written notice by Owner to Contractor fixing the date on which the Contract Times will commence to run and on which Contractor shall start to perform the Work.
28. *Owner*—The individual or entity with which Contractor has contracted regarding the Work, and which has agreed to pay Contractor for the performance of the Work, pursuant to the terms of the

Contract.

29. *Progress Schedule*—A schedule, prepared and maintained by Contractor, describing the sequence and duration of the activities comprising the Contractor’s plan to accomplish the Work within the Contract Times.
30. *Project*—The total undertaking to be accomplished for Owner by engineers, contractors, and others, including planning, study, design, construction, testing, commissioning, and start-up, and of which the Work to be performed under the Contract Documents is a part.
31. *Project Manual*—The written documents prepared for, or made available for, procuring and constructing the Work, including but not limited to the Bidding Documents or other construction procurement documents, geotechnical and existing conditions information, the Agreement, bond forms, General Conditions, Supplementary Conditions, and Specifications. The contents of the Project Manual may be bound in one or more volumes.
32. *Resident Project Representative*—The authorized representative of Engineer assigned to assist Engineer at the Site. As used herein, the term Resident Project Representative or “RPR” includes any assistants or field staff of Resident Project Representative.
33. *Samples*—Physical examples of materials, equipment, or workmanship that are representative of some portion of the Work and that establish the standards by which such portion of the Work will be judged.
34. *Schedule of Submittals*—A schedule, prepared and maintained by Contractor, of required submittals and the time requirements for Engineer’s review of the submittals and the performance of related construction activities.
35. *Schedule of Values*—A schedule, prepared and maintained by Contractor, allocating portions of the Contract Price to various portions of the Work and used as the basis for reviewing Contractor’s Applications for Payment.
36. *Shop Drawings*—All drawings, diagrams, illustrations, schedules, and other data or information that are specifically prepared or assembled by or for Contractor and submitted by Contractor to illustrate some portion of the Work. Shop Drawings, whether approved or not, are not Drawings and are not Contract Documents.
37. *Site*—Lands or areas indicated in the Contract Documents as being furnished by Owner upon which the Work is to be performed, including rights-of-way and easements, and such other lands furnished by Owner which are designated for the use of Contractor.
38. *Specifications*—The part of the Contract that consists of written requirements for materials, equipment, systems, standards, and workmanship as applied to the Work, and certain administrative requirements and procedural matters applicable to the Work.
39. *Subcontractor*—An individual or entity having a direct contract with Contractor or with any other Subcontractor for the performance of a part of the Work.
40. *Substantial Completion*—The time at which the Work (or a specified part thereof) has progressed to the point where, in the opinion of Engineer, the Work (or a specified part thereof) is sufficiently complete, in accordance with the Contract Documents, so that the Work (or a specified part thereof) can be utilized for the purposes for which it is intended. The terms “substantially complete” and “substantially completed” as applied to all or part of the Work refer to Substantial Completion thereof.
41. *Successful Bidder*—The Bidder whose Bid the Owner accepts, and to which the Owner makes an award of contract, subject to stated conditions.
42. *Supplementary Conditions*—The part of the Contract that amends or supplements these General

Conditions.

43. *Supplier*—A manufacturer, fabricator, supplier, distributor, materialman, or vendor having a direct contract with Contractor or with any Subcontractor to furnish materials or equipment to be incorporated in the Work by Contractor or a Subcontractor.
44. *Technical Data*—Those items expressly identified as Technical Data in the Supplementary Conditions, with respect to either (a) subsurface conditions at the Site, or physical conditions relating to existing surface or subsurface structures at the Site (except Underground Facilities) or (b) Hazardous Environmental Conditions at the Site. If no such express identifications of Technical Data have been made with respect to conditions at the Site, then the data contained in boring logs, recorded measurements of subsurface water levels, laboratory test results, and other factual, objective information regarding conditions at the Site that are set forth in any geotechnical or environmental report prepared for the Project and made available to Contractor are hereby defined as Technical Data with respect to conditions at the Site under Paragraphs 5.03, 5.04, and 5.06.
45. *Underground Facilities*—All underground pipelines, conduits, ducts, cables, wires, manholes, vaults, tanks, tunnels, or other such facilities or attachments, and any encasements containing such facilities, including but not limited to those that convey electricity, gases, steam, liquid petroleum products, telephone or other communications, fiber optic transmissions, cable television, water, wastewater, storm water, other liquids or chemicals, or traffic or other control systems.
46. *Unit Price Work*—Work to be paid for on the basis of unit prices.
47. *Work*—The entire construction or the various separately identifiable parts thereof required to be provided under the Contract Documents. Work includes and is the result of performing or providing all labor, services, and documentation necessary to produce such construction; furnishing, installing, and incorporating all materials and equipment into such construction; and may include related services such as testing, start-up, and commissioning, all as required by the Contract Documents.
48. *Work Change Directive*—A written directive to Contractor issued on or after the Effective Date of the Contract, signed by Owner and recommended by Engineer, ordering an addition, deletion, or revision in the Work.

## 1.02 Terminology

- A. The words and terms discussed in the following paragraphs are not defined but, when used in the Bidding Requirements or Contract Documents, have the indicated meaning.
- B. Intent of Certain Terms or Adjectives:
  1. The Contract Documents include the terms “as allowed,” “as approved,” “as ordered,” “as directed” or terms of like effect or import to authorize an exercise of professional judgment by Engineer. In addition, the adjectives “reasonable,” “suitable,” “acceptable,” “proper,” “satisfactory,” or adjectives of like effect or import are used to describe an action or determination of Engineer as to the Work. It is intended that such exercise of professional judgment, action, or determination will be solely to evaluate, in general, the Work for compliance with the information in the Contract Documents and with the design concept of the Project as a functioning whole as shown or indicated in the Contract Documents (unless there is a specific statement indicating otherwise). The use of any such term or adjective is not intended to and shall not be effective to assign to Engineer any duty or authority to supervise or direct the performance of the Work, or any duty or authority to undertake responsibility contrary to the provisions of Article 9 or any other provision of the Contract Documents.
- C. Day:

1. The word “day” means a calendar day of 24 hours measured from midnight to the next midnight.

D. Defective:

1. The word “defective,” when modifying the word “Work,” refers to Work that is unsatisfactory, faulty, or deficient in that it:
  - a. does not conform to the Contract Documents; or
  - b. does not meet the requirements of any applicable inspection, reference standard, test, or approval referred to in the Contract Documents; or
  - c. has been damaged prior to Engineer’s recommendation of final payment (unless responsibility for the protection thereof has been assumed by Owner at Substantial Completion in accordance with Paragraph 14.03 or 14.04).

E. Furnish, Install, Perform, Provide:

1. The word “furnish,” when used in connection with services, materials, or equipment, shall mean to supply and deliver said services, materials, or equipment to the Site (or some other specified location) ready for use or installation and in usable or operable condition.
2. The word “install,” when used in connection with services, materials, or equipment, shall mean to put into use or place in final position said services, materials, or equipment complete and ready for intended use.
3. The words “perform” or “provide,” when used in connection with services, materials, or equipment, shall mean to furnish and install said services, materials, or equipment complete and ready for intended use.
4. If the Contract Documents establish an obligation of Contractor with respect to specific services, materials, or equipment, but do not expressly use any of the four words “furnish,” “install,” “perform,” or “provide,” then Contractor shall furnish and install said services, materials, or equipment complete and ready for intended use.

F. Unless stated otherwise in the Contract Documents, words or phrases that have a well- known technical or construction industry or trade meaning are used in the Contract Documents in accordance with such recognized meaning.

## **ARTICLE 2: PRELIMINARY MATTERS**

### *2.01 Delivery of Bonds and Evidence of Insurance*

- A. When Contractor delivers the executed counterparts of the Agreement to Owner, Contractor shall also deliver to Owner unexecuted copies of the bonds and related powers of attorney that Contractor will be required to furnish. Within 10 days after execution of the Agreement by Owner, Contractor shall deliver to Owner fully executed bonds, accompanied by a certified copy of the signing individual’s authority to bind the surety establishing that it is effective on the date the agent or attorney-in-fact signed the accompanying bond, as provided in Section 0100, Article 8 Bonding Security.
- B. *Evidence of Contractor’s Insurance:* When Contractor delivers the executed counterparts of the Agreement to Owner, Contractor shall also deliver to Owner, with copies to each named insured and additional insured (as identified in the Supplementary Conditions or elsewhere in the Contract), the certificates and other evidence of insurance required to be provided by Contractor in accordance with Section 00250.

### *2.02 Copies of Documents*

- A. Owner shall furnish Contractor with 1 printed copy of the fully executed Contract Documents. and one copy in electronic portable document format (PDF). Additional printed copies will be furnished upon



request at the cost of reproduction.

- B. Owner shall maintain and safeguard at least one original printed record version of the Contract, including Drawings and Specifications signed and sealed by Engineer and other design professionals. Owner shall make such original printed record version of the Contract available to Contractor for review. Owner may delegate the responsibilities under this provision to Engineer.

#### 2.03 *Before Starting Construction*

- A. *Preliminary Schedules:* Within 10 days after the Effective Date of the Contract (or as otherwise specifically required by the Contract Documents), Contractor shall submit to Engineer for timely review:
  1. a preliminary Progress Schedule indicating the times (numbers of days or dates) for starting and completing the various stages of the Work, including any Milestones specified in the Contract;
  2. a preliminary Schedule of Submittals; and
  3. a preliminary Schedule of Values for all of the Work which includes quantities and prices of items which when added together equal the Contract Price and subdivides the Work into component parts in sufficient detail to serve as the basis for progress payments during performance of the Work. Such prices will include an appropriate amount of overhead and profit applicable to each item of Work.

#### 2.04 *Preconstruction Conference; Designation of Authorized Representatives*

- A. Before any Work at the Site is started, a conference attended by Owner, Contractor, Engineer, and others as appropriate will be held to establish a working understanding among the parties as to the Work and to discuss the schedules referred to in Paragraph 2.03.A, procedures for handling Shop Drawings, Samples, and other submittals, processing Applications for Payment, electronic or digital transmittals, and maintaining required records. Contractor shall be ready, willing, and able to attend this conference within 10 calendar days after the date of award. The date, time, and place of this conference will be set by Engineer.
- B. At this conference, Owner and Contractor each shall designate in writing a specific individual to act as its authorized representative with respect to the services and responsibilities under the Contract. Such individuals shall have the authority to transmit and receive information, render decisions relative to the Contract, and otherwise act on behalf of each respective party.

#### 2.05 *Initial Acceptance of Schedules*

- A. At least 10 days before submission of the first Application for Payment a conference, attended by Contractor, Engineer, and others as appropriate, will be held to review for acceptability to Engineer as provided below the schedules submitted in accordance with Paragraph 2.03.A. Contractor shall have an additional 10 days to make corrections and adjustments and to complete and resubmit the schedules. No progress payment shall be made to Contractor until acceptable schedules are submitted to Engineer.
  1. The Progress Schedule will be acceptable to Engineer if it provides an orderly progression of the Work to completion within the Contract Times. Such acceptance will not impose on Engineer responsibility for the Progress Schedule, for sequencing, scheduling, or progress of the Work, nor interfere with or relieve Contractor from Contractor's full responsibility therefor.
  2. Contractor's Schedule of Submittals will be acceptable to Engineer if it provides a workable arrangement for reviewing and processing the required submittals.
  3. Contractor's Schedule of Values will be acceptable to Engineer as to form and substance if it provides a reasonable allocation of the Contract Price to the component parts of the Work.

## 2.06 *Electronic Transmittals*

- A. Except as otherwise stated elsewhere in the Contract, the Owner, Engineer, and Contractor may transmit, and shall accept, Project-related correspondence, text, data, documents, drawings, information, and graphics, including but not limited to Shop Drawings and other submittals, in electronic media or digital format, either directly, or through access to a secure Project website.
- B. If the Contract does not establish protocols for electronic or digital transmittals, then Owner, Engineer, and Contractor shall jointly develop such protocols.
- C. When transmitting items in electronic media or digital format, the transmitting party makes no representations as to long term compatibility, usability, or readability of the items resulting from the recipient's use of software application packages, operating systems, or computer hardware differing from those used in the drafting or transmittal of the items, or from those established in applicable transmittal protocols.

## **ARTICLE 3: DOCUMENTS: INTENT, REQUIREMENTS, REUSE**

### 3.01 *Intent*

- A. The Contract Documents are complementary; what is required by one is as binding as if required by all.
- B. It is the intent of the Contract Documents to describe a functionally complete project (or part thereof) to be constructed in accordance with the Contract Documents.
- C. Unless otherwise stated in the Contract Documents, if there is a discrepancy between the electronic or digital versions of the Contract Documents (including any printed copies derived from such electronic or digital versions) and the printed record version, the printed record version shall govern.
- D. The Contract supersedes prior negotiations, representations, and agreements, whether written or oral.
- E. Engineer will issue clarifications and interpretations of the Contract Documents as provided herein.

### 3.02 *Reference Standards*

- A. Standards Specifications, Codes, Laws and Regulations
  - 1. Reference in the Contract Documents to standard specifications, manuals, reference standards, or codes of any technical society, organization, or association, or to Laws or Regulations, whether such reference be specific or by implication, shall mean the standard specification, manual, reference standard, code, or Laws or Regulations in effect at the time of opening of Bids (or on the Effective Date of the Contract if there were no Bids), except as may be otherwise specifically stated in the Contract Documents.
  - 2. No provision of any such standard specification, manual, reference standard, or code, or any instruction of a Supplier, shall be effective to change the duties or responsibilities of Owner, Contractor, or Engineer, or any of their subcontractors, consultants, agents, or employees, from those set forth in the part of the Contract Documents prepared by or for Engineer. No such provision or instruction shall be effective to assign to Owner, Engineer, or any of their officers, directors, members, partners, employees, agents, consultants, or subcontractors, any duty or authority to supervise or direct the performance of the Work or any duty or authority to undertake responsibility inconsistent with the provisions of the part of the Contract Documents prepared by or for Engineer.

### 3.03 *Reporting and Resolving Discrepancies*

- A. Reporting Discrepancies:
  - 1. *Contractor's Verification of Figures and Field Measurements:* Before undertaking each part of the

Work, Contractor shall carefully study the Contract Documents, and check and verify pertinent figures and dimensions therein, particularly with respect to applicable field measurements. Contractor shall promptly report in writing to Engineer any conflict, error, ambiguity, or discrepancy that Contractor discovers, or has actual knowledge of, and shall not proceed with any Work affected thereby until the conflict, error, ambiguity, or discrepancy is resolved, by a clarification or interpretation by Engineer, or by an amendment or supplement to the Contract Documents issued pursuant to Paragraph 10.01.

2. *Contractor's Review of Contract Documents:* If, before or during the performance of the Work, Contractor discovers any conflict, error, ambiguity, or discrepancy within the Contract Documents, or between the Contract Documents and (a) any applicable Law or Regulation, (b) actual field conditions, (c) any standard specification, manual, reference standard, or code, or (d) any instruction of any Supplier, then Contractor shall promptly report it to Engineer in writing. Contractor shall not proceed with the Work affected thereby (except in an emergency as required by Paragraph 6.15) until the conflict, error, ambiguity, or discrepancy is resolved, by a clarification or interpretation by Engineer, or by an amendment or supplement to the Contract Documents issued pursuant to Paragraph 10.01.
3. Contractor shall not be liable to Owner or Engineer for failure to report any conflict, error, ambiguity, or discrepancy in the Contract Documents unless Contractor had actual knowledge thereof.

B. Resolving Discrepancies:

1. Except as may be otherwise specifically stated in the Contract Documents, the provisions of the part of the Contract Documents prepared by or for Engineer shall take precedence in resolving any conflict, error, ambiguity, or discrepancy between such provisions of the Contract Documents and:
  - a. the provisions of any standard specification, manual, reference standard, or code, or the instruction of any Supplier (whether or not specifically incorporated by reference as a Contract Document); or
  - b. the provisions of any Laws or Regulations applicable to the performance of the Work (unless such an interpretation of the provisions of the Contract Documents would result in violation of such Law or Regulation).

3.04 *Requirements of the Contract Documents*

- A. During the performance of the Work and until final payment, Contractor and Owner shall submit to the Engineer all matters in question concerning the requirements of the Contract Documents (sometimes referred to as requests for information or interpretation—RFIs), or relating to the acceptability of the Work under the Contract Documents, as soon as possible after such matters arise. Engineer will be the initial interpreter of the requirements of the Contract Documents, and judge of the acceptability of the Work thereunder.
- B. Engineer will, with reasonable promptness, render a written clarification, interpretation, or decision on the issue submitted, or initiate an amendment or supplement to the Contract Documents. Engineer's written clarification, interpretation, or decision will be final and binding on Contractor, unless it appeals by submitting a Change Proposal, and on Owner, unless it appeals by filing a Claim.
- C. If a submitted matter in question concerns terms and conditions of the Contract Documents that do not involve (1) the performance or acceptability of the Work under the Contract Documents, (2) the design (as set forth in the Drawings, Specifications, or otherwise), or (3) other engineering or technical matters, then Engineer will promptly give written notice to the Contractor that Engineer is unable to provide a decision or interpretation. If Owner and Contractor are unable to agree on resolution of such a matter in question, either party may pursue resolution as provided in Article 11.

### 3.05 *Reuse of Documents*

- A. Contractor and its Subcontractors and Suppliers shall not:
  - 1. have or acquire any title to or ownership rights in any of the Drawings, Specifications, or other documents (or copies of any thereof) prepared by or bearing the seal of Engineer or its consultants, including electronic media editions, or reuse any such Drawings, Specifications, other documents, or copies thereof on extensions of the Project or any other project without written consent of Owner and Engineer and specific written verification or adaptation by Engineer; or
  - 2. have or acquire any title or ownership rights in any other Contract Documents, reuse any such Contract Documents for any purpose without Owner's express written consent, or violate any copyrights pertaining to such Contract Documents.
- B. The prohibitions of this Paragraph 3.05 will survive final payment, or termination of the Contract. Nothing herein shall preclude Contractor from retaining copies of the Contract Documents for record purposes.

## **ARTICLE 4: COMMENCEMENT AND PROGRESS OF THE WORK**

### 4.01 *Commencement of Contract Times; Notice to Proceed*

- A. The Contract Times will commence to run on the day indicated in a Notice to Proceed.

### 4.02 *Starting the Work*

- A. Contractor shall start to perform the Work on the date when the Contract Times commence to run. No Work shall be done at the Site prior to such date.

### 4.03 *Reference Points*

- A. Owner shall provide engineering surveys to establish reference points for construction which in Engineer's judgment are necessary to enable Contractor to proceed with the Work. Contractor shall be responsible for laying out the Work, shall protect and preserve the established reference points and property monuments, and shall make no changes or relocations without the prior written approval of Owner. Contractor shall report to Engineer whenever any reference point or property monument is lost or destroyed or requires relocation because of necessary changes in grades or locations and shall be responsible for the accurate replacement or relocation of such reference points or property monuments by professionally qualified personnel.

### 4.04 *Progress Schedule*

- A. Contractor shall adhere to the Progress Schedule established in accordance with Paragraph 2.05 as it may be adjusted from time to time as provided below.
  - 1. Contractor shall submit to Engineer for acceptance (to the extent indicated in Paragraph 2.05) proposed adjustments in the Progress Schedule that will not result in changing the Contract Times.
  - 2. Proposed adjustments in the Progress Schedule that will change the Contract Times shall be submitted in accordance with the requirements of Article 10.
- B. Contractor shall carry on the Work and adhere to the Progress Schedule during all disputes or disagreements with Owner. No Work shall be delayed or postponed pending resolution of any disputes or disagreements, or during any appeal process, except as permitted by Paragraph 15.04, or as Owner and Contractor may otherwise agree in writing.

### 4.05 *Delays in Contractor's Progress*

- A. If Owner, Engineer, or anyone for whom Owner is responsible, delays, disrupts, or interferes with the performance or progress of the Work, then Contractor shall be entitled to an equitable adjustment in

the Contract Times and Contract Price. Contractor's entitlement to an adjustment of the Contract Times is conditioned on such adjustment being essential to Contractor's ability to complete the Work within the Contract Times.

- B. Contractor shall not be entitled to an adjustment in Contract Price or Contract Times for delay, disruption, or interference caused by or within the control of Contractor. Delay, disruption, and interference attributable to and within the control of a Subcontractor or Supplier shall be deemed to be within the control of Contractor.
- C. If Contractor's performance or progress is delayed, disrupted, or interfered with by unanticipated causes not the fault of and beyond the control of Owner, Contractor, and those for which they are responsible, then Contractor shall be entitled to an equitable adjustment in Contract Times. Contractor's entitlement to an adjustment of the Contract Times is conditioned on such adjustment being essential to Contractor's ability to complete the Work within the Contract Times. Such an adjustment shall be Contractor's sole and exclusive remedy for the delays, disruption, and interference described in this paragraph. Causes of delay, disruption, or interference that may give rise to an adjustment in Contract Times under this paragraph include but are not limited to the following:
  - 1. severe and unavoidable natural catastrophes such as fires, floods, epidemics, and earthquakes;
  - 2. abnormal weather conditions;
  - 3. acts or failures to act of utility owners (other than those performing other work at or adjacent to the Site by arrangement with the Owner, as contemplated in Article 7); and
  - 4. acts of war or terrorism.
- D. Delays, disruption, and interference to the performance or progress of the Work resulting from the existence of a differing subsurface or physical condition, an Underground Facility that was not shown or indicated by the Contract Documents, or not shown or indicated with reasonable accuracy, and those resulting from Hazardous Environmental Conditions, are governed by Article 5.
- E. Paragraph 7.03 governs delays, disruption, and interference to the performance or progress of the Work resulting from the performance of certain other work at or adjacent to the Site.
- F. Contractor shall not be entitled to an adjustment in Contract Price or Contract Times for any delay, disruption, or interference if such delay is concurrent with a delay, disruption, or interference caused by or within the control of Contractor.
- G. Contractor must submit any Change Proposal seeking an adjustment in Contract Price or Contract Times under this paragraph within 30 days of the commencement of the delaying, disrupting, or interfering event.

## **ARTICLE 5: AVAILABILITY OF LANDS; SUBSURFACE AND PHYSICAL CONDITIONS; HAZARDOUS ENVIRONMENTAL CONDITIONS**

### *5.01 Availability of Lands*

- A. Owner shall furnish the Site. Owner shall notify Contractor of any encumbrances or restrictions not of general application but specifically related to use of the Site with which Contractor must comply in performing the Work.
- B. Upon reasonable written request, Owner shall furnish Contractor with a current statement of record legal title and legal description of the lands upon which permanent improvements are to be made and Owner's interest therein.
- C. Contractor shall provide for all additional lands and access thereto that may be required for temporary construction facilities or storage of materials and equipment.

## 5.02 Use of Site and Other Areas

### A. Limitation on Use of Site and Other Areas:

1. Contractor shall confine construction equipment, temporary construction facilities, the storage of materials and equipment, and the operations of workers to the Site, adjacent areas that Contractor has arranged to use through construction easements or otherwise, and other adjacent areas permitted by Laws and Regulations, and shall not unreasonably encumber the Site and such other adjacent areas with construction equipment or other materials or equipment. Contractor shall assume full responsibility for (a) damage to the Site; (b) damage to any such other adjacent areas used for Contractor's operations; (c) damage to any other adjacent land or areas; and (d) for injuries and losses sustained by the owners or occupants of any such land or areas; provided that such damage or injuries result from the performance of the Work or from other actions or conduct of the Contractor or those for which Contractor is responsible.
2. If a damage or injury claim is made by the owner or occupant of any such land or area because of the performance of the Work, or because of other actions or conduct of the Contractor or those for which Contractor is responsible, Contractor shall (a) take immediate corrective or remedial action as required by Paragraph 6.12, or otherwise; (b) promptly attempt to settle the claim as to all parties through negotiations with such owner or occupant, or otherwise resolve the claim by arbitration or other dispute resolution proceeding, or at law; and (c) to the fullest extent permitted by Laws and Regulations, indemnify and hold harmless Owner and Engineer, and the officers, directors, members, partners, employees, agents, consultants and subcontractors of each and any of them from and against any such claim, and against all costs, losses, and damages (including but not limited to all fees and charges of engineers, architects, attorneys, and other professionals and all court or arbitration or other dispute resolution costs) arising out of or relating to any claim or action, legal or equitable, brought by any such owner or occupant against Owner, Engineer, or any other party indemnified hereunder to the extent caused directly or indirectly, in whole or in part by, or based upon, Contractor's performance of the Work, or because of other actions or conduct of the Contractor or those for which Contractor is responsible.

B. *Removal of Debris During Performance of the Work:* During the progress of the Work the Contractor shall keep the Site and other adjacent areas free from accumulations of waste materials, rubbish, and other debris. Removal and disposal of such waste materials, rubbish, and other debris shall conform to applicable Laws and Regulations.

C. *Cleaning:* Prior to Substantial Completion of the Work Contractor shall clean the Site and the Work and make it ready for utilization by Owner. At the completion of the Work Contractor shall remove from the Site and adjacent areas all tools, appliances, construction equipment and machinery, and surplus materials and shall restore to original condition all property not designated for alteration by the Contract Documents.

D. *Loading of Structures:* Contractor shall not load nor permit any part of any structure to be loaded in any manner that will endanger the structure, nor shall Contractor subject any part of the Work or adjacent structures or land to stresses or pressures that will endanger them.

E. Contractor shall at all times control dust and keep the Sites free from accumulation of waste materials or rubbish caused by Contractor's employees or subcontractors, and at the completion of the Work, Contractor shall remove all Contractor's rubbish from and about the Sites and all Contractor's tools and surplus materials and shall leave Contractor's Sites and any other Work area clean. Owner may remove the rubbish and charge the cost to Contractor as the Engineer may determine to be just. In the event that Contractor does not keep the Sites and any other Work area free of rubbish or accumulations of waste materials and control dust, Owner will withhold an additional 5% from any pay request, above and beyond the standard 10% retainage.

### 5.03 *Subsurface and Physical Conditions*

- A. *Reports and Drawings:* The Supplementary Conditions identify:
1. those reports known to Owner of explorations and tests of subsurface conditions at or adjacent to the Site;
  2. those drawings known to Owner of physical conditions relating to existing surface or subsurface structures at the Site (except Underground Facilities); and
  3. Technical Data contained in such reports and drawings.
- B. *Reliance by Contractor on Technical Data Authorized:* Contractor may rely upon the accuracy of the Technical Data expressly identified in the Supplementary Conditions with respect to such reports and drawings, but such reports and drawings are not Contract Documents. If no such express identification has been made, then Contractor may rely upon the accuracy of the Technical Data (as defined in Article 1) contained in any geotechnical or environmental report prepared for the Project and made available to Contractor. Except for such reliance on Technical Data, Contractor may not rely upon or make any claim against Owner or Engineer, or any of their officers, directors, members, partners, employees, agents, consultants, or subcontractors, with respect to:
1. the completeness of such reports and drawings for Contractor's purposes, including, but not limited to, any aspects of the means, methods, techniques, sequences, and procedures of construction to be employed by Contractor, and safety precautions and programs incident thereto; or
  2. other data, interpretations, opinions, and information contained in such reports or shown or indicated in such drawings; or
  3. any Contractor interpretation of or conclusion drawn from any Technical Data or any such other data, interpretations, opinions, or information.
- C. *Subsurface Conditions Known to Owner:* The subsurface conditions at or contiguous to the Site known to Owner are shown on the Drawings and Specifications that are Exhibit "A" of the Contract Documents. Contractor is not entitled to rely upon any other information and data known to or identified by Owner or Project Manager.
- D. *Unforeseen Physical Conditions:* Contractor shall notify Engineer in writing of any subsurface or latent physical condition at the Site differing materially from those indicated in the Contract Documents. Engineer shall promptly investigate those conditions and advise Owner in writing if additional information shall be required. Owner shall then obtain such information, and if deemed necessary, shall issue written orders to perform necessary revisions.

### 5.04 *Differing Subsurface or Physical Conditions*

- A. *Notice by Contractor:* If Contractor believes that any subsurface or physical condition that is uncovered or revealed at the Site either:
1. is of such a nature as to establish that any Technical Data on which Contractor is entitled to rely as provided in Paragraph 5.03 is materially inaccurate; or
  2. is of such a nature as to require a change in the Drawings or Specifications; or
  3. differs materially from that shown or indicated in the Contract Documents; or
  4. is of an unusual nature, and differs materially from conditions ordinarily encountered and generally recognized as inherent in work of the character provided for in the Contract Documents;
- then Contractor shall, promptly after becoming aware thereof and before further disturbing the subsurface or physical conditions or performing any Work in connection therewith (except in an emergency as required by Paragraph 6.15), notify Owner and Engineer in writing about such

condition. Contractor shall not further disturb such condition or perform any Work in connection therewith (except with respect to an emergency) until receipt of a written statement permitting Contractor to do so.

- B. *Engineer's Review:* After receipt of written notice as required by the preceding paragraph, Engineer will promptly review the subsurface or physical condition in question; determine the necessity of Owner's obtaining additional exploration or tests with respect to the condition; conclude whether the condition falls within any one or more of the differing site condition categories in Paragraph 5.04.A above; obtain any pertinent cost or schedule information from Contractor; prepare recommendations to Owner regarding the Contractor's resumption of Work in connection with the subsurface or physical condition in question and the need for any change in the Drawings or Specifications; and advise Owner in writing of Engineer's findings, conclusions, and recommendations.
- C. *Owner's Statement to Contractor Regarding Site Condition:* After receipt of Engineer's written findings, conclusions, and recommendations, Owner shall issue a written statement to Contractor (with a copy to Engineer) regarding the subsurface or physical condition in question, addressing the resumption of Work in connection with such condition, indicating whether any change in the Drawings or Specifications will be made, and adopting or rejecting Engineer's written findings, conclusions, and recommendations, in whole or in part.
- D. Possible Price and Times Adjustments:
1. Contractor shall be entitled to an equitable adjustment in Contract Price or Contract Times, or both, to the extent that the existence of a differing subsurface or physical condition, or any related delay, disruption, or interference, causes an increase or decrease in Contractor's cost of, or time required for, performance of the Work; subject, however, to the following:
    - a. such condition must fall within any one or more of the categories described in Paragraph 5.04.A;
    - b. with respect to Work that is paid for on a unit price basis, any adjustment in Contract Price will be subject to the provisions of Paragraph 12.03; and,
    - c. Contractor's entitlement to an adjustment of the Contract Times is conditioned on such adjustment being essential to Contractor's ability to complete the Work within the Contract Times.
  2. Contractor shall not be entitled to any adjustment in the Contract Price or Contract Times with respect to a subsurface or physical condition if:
    - a. Contractor knew of the existence of such condition at the time Contractor made a commitment to Owner with respect to Contract Price and Contract Times by the submission of a Bid or becoming bound under a negotiated contract, or otherwise; or
    - b. the existence of such condition reasonably could have been discovered or revealed as a result of any examination, investigation, exploration, test, or study of the Site and contiguous areas expressly required by the Bidding Requirements or Contract Documents to be conducted by or for Contractor prior to Contractor's making such commitment; or
    - c. Contractor failed to give the written notice as required by Paragraph 5.04.A.
  3. If Owner and Contractor agree regarding Contractor's entitlement to and the amount or extent of any adjustment in the Contract Price or Contract Times, or both, then any such adjustment shall be set forth in a Change Order.
  4. Contractor may submit a Change Proposal regarding its entitlement to or the amount or extent of any adjustment in the Contract Price or Contract Times, or both, no later than 30 days after Owner's issuance of the Owner's written statement to Contractor regarding the subsurface or



physical condition in question.

#### 5.05 *Underground Facilities*

- A. *Contractor's Responsibilities*: The information and data shown or indicated in the Contract Documents with respect to existing Underground Facilities at or adjacent to the Site is based on information and data furnished to Owner or Engineer by the owners of such Underground Facilities, including Owner, or by others. Unless it is otherwise expressly provided in the Supplementary Conditions:
1. Owner and Engineer do not warrant or guarantee the accuracy or completeness of any such information or data provided by others; and
  2. the cost of all of the following will be included in the Contract Price, and Contractor shall have full responsibility for:
    - a. reviewing and checking all information and data regarding existing Underground Facilities at the Site;
    - b. locating all Underground Facilities shown or indicated in the Contract Documents as being at the Site;
    - c. coordination of the Work with the owners (including Owner) of such Underground Facilities, during construction; and
    - d. the safety and protection of all existing Underground Facilities at the Site, and repairing any damage thereto resulting from the Work.
- B. *Protection of Underground Facilities*.
1. Existing utilities and other facilities such as drainage structures have been indicated on the Drawings and Specifications only to the extent that such information was made available to Owner. There is no guarantee as to the accuracy or completeness of this information, and Owner will not be responsible for such accuracy or completeness.
  2. Contractor shall be responsible for protecting all such utilities indicated in the manner determined necessary by the owner of such utilities. Any utilities not indicated on the Drawings and Specifications, which do not require relocation, shall be protected by Contractor. The Work shall be performed at the original Contract Price. All visible surface facilities or underground utilities shown on the Drawings and Specifications, whether or not shown to be relocated, shall be protected or relocated by Contractor at its expense.
  3. Abandoned utilities, when encountered, shall be severed and plugged at Contractor's expense.
  4. the utility during relocation.
  5. Contractor shall be responsible for discovery of existing underground installations, in advance of excavating or trenching, by contacting all local utilities and by prospecting and pot holing. Any damage to facilities not shown shall be solely the responsibility of Contractor.

#### 5.06 *Hazardous Environmental Conditions at Site*

- A. No reports or drawings related to Hazardous Environmental Conditions at the Site are known to Owner.
- B. Contractor shall not be responsible for removing or remediating any Hazardous Environmental Condition encountered, uncovered, or revealed at the Site unless such removal or remediation is expressly identified in the Contract Documents to be within the scope of the Work.
- C. Contractor shall be responsible for controlling, containing, and duly removing all Constituents of Concern brought to the Site by Contractor, Subcontractors, Suppliers, or anyone else for whom Contractor is responsible, and for any associated costs; and for the costs of removing and remediating

any Hazardous Environmental Condition created by the presence of any such Constituents of Concern.

- D. If Contractor encounters, uncovers, or reveals a Hazardous Environmental Condition whose removal or remediation is not expressly identified in the Contract Documents as being within the scope of the Work, or if Contractor or anyone for whom Contractor is responsible creates a Hazardous Environmental Condition, then Contractor shall immediately: (1) secure or otherwise isolate such condition; (2) stop all Work in connection with such condition and in any area affected thereby (except in an emergency as required by Paragraph 6.15); and (3) notify Owner and Engineer (and promptly thereafter confirm such notice in writing). Owner shall promptly consult with Engineer concerning the necessity for Owner to retain a qualified expert to evaluate such condition or take corrective action, if any. Promptly after consulting with Engineer, Owner shall take such actions as are necessary to permit Owner to timely obtain required permits and provide Contractor the written notice required by Paragraph 5.06.F. If Contractor or anyone for whom Contractor is responsible created the Hazardous Environmental Condition in question, then Owner may remove and remediate the Hazardous Environmental Condition, and impose a set-off against payments to account for the associated costs.
- E. Contractor shall not resume Work in connection with such Hazardous Environmental Condition or in any affected area until after Owner has obtained any required permits related thereto, and delivered written notice to Contractor either (1) specifying that such condition and any affected area is or has been rendered safe for the resumption of Work, or (2) specifying any special conditions under which such Work may be resumed safely.
- F. If Owner and Contractor cannot agree as to entitlement to or on the amount or extent, if any, of any adjustment in Contract Price or Contract Times, or both, as a result of such Work stoppage or such special conditions under which Work is agreed to be resumed by Contractor, then within 30 days of Owner's written notice regarding the resumption of Work, Contractor may submit a Change Proposal, or Owner may impose a set-off.
- G. If after receipt of such written notice Contractor does not agree to resume such Work based on a reasonable belief it is unsafe, or does not agree to resume such Work under such special conditions, then Owner may order the portion of the Work that is in the area affected by such condition to be deleted from the Work, following the contractual change procedures in Article 10. Owner may have such deleted portion of the Work performed by Owner's own forces or others in accordance with Article 7.
- H. To the fullest extent permitted by Laws and Regulations, Owner shall indemnify and hold harmless Contractor, Subcontractors, and Engineer, and the officers, directors, members, partners, employees, agents, consultants, and subcontractors of each and any of them from and against all claims, costs, losses, and damages (including but not limited to all fees and charges of engineers, architects, attorneys, and other professionals and all court or arbitration or other dispute resolution costs) arising out of or relating to a Hazardous Environmental Condition, provided that such Hazardous Environmental Condition (1) was not shown or indicated in the Drawings, Specifications, or other Contract Documents, identified as Technical Data entitled to limited reliance pursuant to Paragraph 5.06.B, or identified in the Contract Documents to be included within the scope of the Work, and (2) was not created by Contractor or by anyone for whom Contractor is responsible. Nothing in this Paragraph 5.06.H shall obligate Owner to indemnify any individual or entity from and against the consequences of that individual's or entity's own negligence.
- I. The provisions of Paragraphs 5.03, 5.04, and 5.05 do not apply to the presence of Constituents of Concern or to a Hazardous Environmental Condition uncovered or revealed at the Site.

## **ARTICLE 6: CONTRACTOR'S RESPONSIBILITIES**

### 6.01 *Supervision and Superintendence*

- A. Contractor shall supervise, inspect, and direct the Work competently and efficiently, devoting such attention thereto and applying such skills and expertise as may be necessary to perform the Work in accordance with the Contract Documents. Contractor shall be solely responsible for the means, methods, techniques, sequences, and procedures of construction.
- B. At all times during the progress of the Work, Contractor shall assign a competent resident superintendent who shall not be replaced without written notice to Owner and Engineer except under extraordinary circumstances. The superintendent will be Contractor's representative at the Site and shall have authority to act on behalf of Contractor. All communications given to or received from the superintendent shall be binding on Contractor.

### 6.02 *Labor; Working Hours*

- A. Contractor shall provide competent, suitably qualified personnel to survey and lay out the Work and perform construction as required by the Contract Documents. Contractor shall at all times maintain good discipline and order at the Site.
- B. Except as otherwise required for the safety or protection of persons or the Work or property at the Site or adjacent thereto, and except as otherwise stated in the Contract Documents, all Work at the Site shall be performed during regular working hours, Monday through Friday. Contractor will not perform Work on a Saturday, Sunday, or any legal holiday. Contractor may perform Work outside regular working hours or on Saturdays, Sundays, or legal holidays only with Owner's written consent, which will not be unreasonably withheld.
- C. In all cases, local labor shall be given preference when available.
- D. Whenever Owner shall notify Contractor that any man on the Work is, in his opinion, incompetent, unfaithful, or disorderly, or who uses threatening or abusive language to any person representing Owner when on the Work, such man shall be immediately discharged from the Work and shall not be re-employed thereon except with the consent of Owner.

### 6.03 *Services, Materials, and Equipment*

- A. Unless otherwise specified in the Contract Documents, Contractor shall provide and assume full responsibility for all services, materials, equipment, labor, transportation, construction equipment and machinery, tools, appliances, fuel, power, light, heat, telephone, water, sanitary facilities, temporary facilities, and all other facilities and incidentals necessary for the performance, testing, start up, and completion of the Work, whether or not such items are specifically called for in the Contract Documents.
- B. All materials and equipment incorporated into the Work shall be of good quality and new, except as otherwise provided in the Contract Documents. All special warranties and guarantees required by the Specifications shall expressly run to the benefit of Owner. If required by Engineer, Contractor shall furnish satisfactory evidence (including reports of required tests) as to the source, kind, and quality of materials and equipment.
- C. All materials and equipment shall be stored, applied, installed, connected, erected, protected, used, cleaned, and conditioned in accordance with instructions of the applicable Supplier, except as otherwise may be provided in the Contract Documents.
- D. The responsibility for the protection and safekeeping of equipment and materials on or near the Site will be entirely that of Contractor and that no Claim shall be made against Owner by reason of any act of an employee or trespasser. Should an occasion arise necessitating access to the sites occupied by the stored materials and equipment, Contractor shall immediately move same. No materials or equipment may be placed upon the property of Owner until Owner has approved the location contemplated by Contractor to be used for storage.

#### 6.04 "Or Equals"

- A. Whenever an item of material or equipment is specified or described in the Contract Documents by using the name of a proprietary item or the name of a particular Supplier, the Contract Price has been based upon Contractor furnishing such item as specified. The specification or description of such an item is intended to establish the type, function, appearance, and quality required. Unless the specification or description contains or is followed by words reading that no like, equivalent, or "or equal" item is permitted, Contractor may request that Engineer authorize the use of other items of material or equipment, or items from other proposed suppliers under the circumstances described below.
1. If Engineer in its sole discretion determines that an item of material or equipment proposed by Contractor is functionally equal to that named and sufficiently similar so that no change in related Work will be required, Engineer shall deem it an "or equal" item. For the purposes of this paragraph, a proposed item of material or equipment will be considered functionally equal to an item so named if:
    - a. in the exercise of reasonable judgment Engineer determines that:
      - 1) it is at least equal in materials of construction, quality, durability, appearance, strength, and design characteristics;
      - 2) it will reliably perform at least equally well the function and achieve the results imposed by the design concept of the completed Project as a functioning whole;
      - 3) it has a proven record of performance and availability of responsive service; and
      - 4) it is not objectionable to Owner.
    - b. Contractor certifies that, if approved and incorporated into the Work:
      - 1) there will be no increase in cost to the Owner or increase in Contract Times; and
      - 2) it will conform substantially to the detailed requirements of the item named in the Contract Documents.
- B. *Contractor's Expense:* Contractor shall provide all data in support of any proposed "or equal" item at Contractor's expense.
- C. *Engineer's Evaluation and Determination:* Engineer will be allowed a reasonable time to evaluate each "or-equal" request. Engineer may require Contractor to furnish additional data about the proposed "or-equal" item. Engineer will be the sole judge of acceptability. No "or-equal" item will be ordered, furnished, installed, or utilized until Engineer's review is complete and Engineer determines that the proposed item is an "or-equal", which will be evidenced by an approved Shop Drawing or other written communication. Engineer will advise Contractor in writing of any negative determination.
- D. *Effect of Engineer's Determination:* Neither approval nor denial of an "or-equal" request shall result in any change in Contract Price. The Engineer's denial of an "or-equal" request shall be final and binding, and may not be reversed through an appeal under any provision of the Contract Documents.
- E. *Treatment as a Substitution Request:* If Engineer determines that an item of material or equipment proposed by Contractor does not qualify as an "or-equal" item, Contractor may request that Engineer consider the proposed item as a substitute pursuant to Paragraph 6.05.

#### 6.05 Substitutes

- A. Unless the specification or description of an item of material or equipment required to be furnished under the Contract Documents contains or is followed by words reading that no substitution is permitted, Contractor may request that Engineer authorize the use of other items of material or equipment under the circumstances described below. To the extent possible such requests shall be

made before commencement of related construction at the Site.

1. Contractor shall submit sufficient information as provided below to allow Engineer to determine if the item of material or equipment proposed is functionally equivalent to that named and an acceptable substitute therefor. Engineer will not accept requests for review of proposed substitute items of material or equipment from anyone other than Contractor.
  2. The requirements for review by Engineer will be as set forth in Paragraph 6.05.B, as supplemented by the Specifications, and as Engineer may decide is appropriate under the circumstances.
  3. Contractor shall make written application to Engineer for review of a proposed substitute item of material or equipment that Contractor seeks to furnish or use. The application:
    - a. shall certify that the proposed substitute item will:
      - 1) perform adequately the functions and achieve the results called for by the general design,
      - 2) be similar in substance to that specified, and
      - 3) be suited to the same use as that specified.
    - b. will state:
      - 1) the extent, if any, to which the use of the proposed substitute item will necessitate a change in Contract Times,
      - 2) whether use of the proposed substitute item in the Work will require a change in any of the Contract Documents (or in the provisions of any other direct contract with Owner for other work on the Project) to adapt the design to the proposed substitute item, and
      - 3) whether incorporation or use of the proposed substitute item in connection with the Work is subject to payment of any license fee or royalty.
    - c. will identify:
      - 1) all variations of the proposed substitute item from that specified, and available engineering, sales, maintenance, repair, and replacement services.
    - d. shall contain an itemized estimate of all costs or credits that will result directly or indirectly from use of such substitute item, including but not limited to changes in Contract Price, shared savings, costs of redesign, and claims of other contractors affected by any resulting change.
- B. *Engineer's Evaluation and Determination:* Engineer will be allowed a reasonable time to evaluate each substitute request, and to obtain comments and direction from Owner. Engineer may require Contractor to furnish additional data about the proposed substitute item. Engineer will be the sole judge of acceptability. No substitute will be ordered, furnished, installed, or utilized until Engineer's review is complete and Engineer determines that the proposed item is an acceptable substitute. Engineer's determination will be evidenced by a Field Order or a proposed Change Order accounting for the substitution itself and all related impacts, including changes in Contract Price or Contract Times. Engineer will advise Contractor in writing of any negative determination.
- C. *Special Guarantee:* Owner may require Contractor to furnish at Contractor's expense a special performance guarantee or other surety with respect to any substitute.
- D. *Reimbursement of Engineer's Cost:* Engineer will record Engineer's costs in evaluating a substitute proposed or submitted by Contractor. Whether or not Engineer approves a substitute so proposed or submitted by Contractor, Contractor shall reimburse Owner for the reasonable charges of Engineer for evaluating each such proposed substitute. Contractor shall also reimburse Owner for the reasonable charges of Engineer for making changes in the Contract Documents (or in the provisions of any other direct contract with Owner) resulting from the acceptance of each proposed substitute.

- E. *Contractor's Expense*: Contractor shall provide all data in support of any proposed substitute at Contractor's expense.
  - F. *Effect of Engineer's Determination*: If Engineer approves the substitution request, Contractor shall execute the proposed Change Order and proceed with the substitution. The Engineer's denial of a substitution request shall be final and binding, and may not be reversed through an appeal under any provision of the Contract Documents. Contractor may challenge the scope of reimbursement costs imposed under Paragraph 6.05.D, by timely submittal of a Change Proposal.
- 6.06 *Concerning Subcontractors, Suppliers, and Others*
- A. Contractor may retain Subcontractors and Suppliers for the performance of parts of the Work. Such Subcontractors and Suppliers must be acceptable to Owner.
  - B. Contractor shall retain specific Subcontractors, Suppliers, or other individuals or entities for the performance of designated parts of the Work if required by the Contract to do so.
  - C. Subsequent to the submittal of Contractor's Bid or final negotiation of the terms of the Contract, Owner may not require Contractor to retain any Subcontractor, Supplier, or other individual or entity to furnish or perform any of the Work against which Contractor has reasonable objection.
  - D. Prior to entry into any binding subcontract or purchase order, Contractor shall submit to Owner the identity of the proposed Subcontractor or Supplier (unless Owner has already deemed such proposed Subcontractor or Supplier acceptable, during the bidding process or otherwise). Such proposed Subcontractor or Supplier shall be deemed acceptable to Owner unless Owner raises a substantive, reasonable objection within five days.
  - E. Owner may require the replacement of any Subcontractor, Supplier, or other individual or entity retained by Contractor to perform any part of the Work. Owner also may require Contractor to retain specific replacements; provided, however, that Owner may not require a replacement to which Contractor has a reasonable objection. If Contractor has submitted the identity of certain Subcontractors, Suppliers, or other individuals or entities for acceptance by Owner, and Owner has accepted it (either in writing or by failing to make written objection thereto), then Owner may subsequently revoke the acceptance of any such Subcontractor, Supplier, or other individual or entity so identified solely on the basis of substantive, reasonable objection after due investigation. Contractor shall submit an acceptable replacement for the rejected Subcontractor, Supplier, or other individual or entity.
  - F. If Owner requires the replacement of any Subcontractor, Supplier, or other individual or entity retained by Contractor to perform any part of the Work, then Contractor shall be entitled to an adjustment in Contract Price or Contract Times, or both, with respect to the replacement; and Contractor shall initiate a Change Proposal for such adjustment within 30 days of Owner's requirement of replacement.
  - G. No acceptance by Owner of any such Subcontractor, Supplier, or other individual or entity, whether initially or as a replacement, shall constitute a waiver of the right of Owner to the completion of the Work in accordance with the Contract Documents.
  - H. Prior to submitting the first Application for Payment and within 3 workdays after any change, Contractor shall submit to Engineer a complete list of all Subcontractors and Suppliers having a direct contract with Contractor, and of all other Subcontractors and Suppliers known to Contractor at the time of submittal.
  - I. Contractor shall be fully responsible to Owner and Engineer for all acts and omissions of the Subcontractors, Suppliers, and other individuals or entities performing or furnishing any of the Work just as Contractor is responsible for Contractor's own acts and omissions.
  - J. Contractor shall be solely responsible for scheduling and coordinating the work of Subcontractors, Suppliers, and all other individuals or entities performing or furnishing any of the Work.

- K. Contractor shall restrict all Subcontractors, Suppliers, and such other individuals or entities performing or furnishing any of the Work from communicating with Engineer or Owner, except through Contractor or in case of an emergency, or as otherwise expressly allowed herein.
- L. The divisions and sections of the Specifications and the identifications of any Drawings shall not control Contractor in dividing the Work among Subcontractors or Suppliers or delineating the Work to be performed by any specific trade.
- M. All Work performed for Contractor by a Subcontractor or Supplier shall be pursuant to an appropriate contractual agreement that specifically binds the Subcontractor or Supplier to the applicable terms and conditions of the Contract Documents for the benefit of Owner and Engineer.
- N. Owner may furnish to any Subcontractor or Supplier, to the extent practicable, information about amounts paid to Contractor on account of Work performed for Contractor by the particular Subcontractor or Supplier.
- O. Nothing in the Contract Documents:
  - 1. shall create for the benefit of any such Subcontractor, Supplier, or other individual or entity any contractual relationship between Owner or Engineer and any such Subcontractor, Supplier, or other individual or entity; nor
  - 2. shall create any obligation on the part of Owner or Engineer to pay or to see to the payment of any money due any such Subcontractor, Supplier, or other individual or entity except as may otherwise be required by Laws and Regulations.

#### 6.07 *Patent Fees and Royalties*

- A. Contractor shall pay all license fees and royalties and assume all costs incident to the use in the performance of the Work or the incorporation in the Work of any invention, design, process, product, or device which is the subject of patent rights or copyrights held by others. If a particular invention, design, process, product, or device is specified in the Contract Documents for use in the performance of the Work and if, to the actual knowledge of Owner or Engineer, its use is subject to patent rights or copyrights calling for the payment of any license fee or royalty to others, the existence of such rights shall be disclosed by Owner in the Contract Documents.
- B. To the fullest extent permitted by Laws and Regulations, Contractor shall indemnify and hold harmless Owner and Engineer, and the officers, directors, members, partners, employees, agents, consultants and subcontractors of each and any of them from and against all claims, costs, losses, and damages (including but not limited to all fees and charges of engineers, architects, attorneys, and other professionals and all court or arbitration or other dispute resolution costs) arising out of or relating to any infringement of patent rights or copyrights incident to the use in the performance of the Work or resulting from the incorporation in the Work of any invention, design, process, product, or device not specified in the Contract Documents.

#### 6.08 *Permits*

- A. Unless otherwise provided in the Contract Documents or Section 218.80, Florida Statutes, Contractor shall obtain and pay for all construction permits and licenses. Owner shall reimburse the Contractor at cost, no markup, for permit(s.) Owner shall assist Contractor, when necessary, in obtaining such permits and licenses. Contractor shall pay all governmental charges and inspection fees necessary for the prosecution of the Work which are applicable at the time of the submission of Contractor's Bid (or when Contractor became bound under a negotiated contract). Owner shall pay all charges of utility owners for connections for providing permanent service to the Work.

#### 6.09 *Taxes*

- A. Contractor shall pay all sales, consumer, use, and other similar taxes required to be paid by Contractor

in accordance with the Laws and Regulations of the place of the Project which are applicable during the performance of the Work.

- B. Owner is exempt from payment of sales and compensating use taxes of the State of Florida and of cities and counties thereof on all materials to be incorporated into the Work.
- C. Direct Purchase: Contractor shall provide assistance to Owner for Direct Purchases to enable Owner to purchase tangible personal property needed for this Project which Owner intends to purchase in order to realize savings of sales tax on all tangible personal property needed for this Project. Contractor will recommend direct purchases for items where those direct purchases will result in significant tax savings to Owner. Owner will either accept or reject Contractor's recommendations, and purchases will be made according to Owner's decision. Owner retains the absolute right, with or without Contractor's recommendation, to purchase any or all tangible personal property needed for this Project.
- D. Contractor will provide detailed scoping and pricing for purchase orders with a minimum value of Five Thousand Dollars (\$5,000.00), in harmony with the Subcontractors to Owner for the incorporation in Owner's purchase orders.
- E. Owner will issue purchase orders within three (3) workdays from the date of receipt of requisition, directly to the vendors and provide a copy of each purchase order to Contractor.
- F. Contractor will be responsible for the materials until they are incorporated into the Project and will purchase and/or have ample Builder's Risk insurance for the direct purchased materials.
- G. Contractor will issue a deductive subcontract adjustment to the Subcontractor which will account for the value of the material and the sales tax as it pertains to that Subcontractor's contract. All subcontracts shall include a clause incorporating, by reference, the provisions of this Paragraph 6.09.
- H. As the material is delivered to the Site, the Subcontractor will sign off on the delivery receipt/invoice for the material delivered, store and secure the material adequately at the Site, and forward the invoice to Contractor who will review, approve and forward the invoice to Owner's Representative for approval and processing.
- I. Owner will draft a check for the approved invoice amount and mail that check directly to the vendor. A list of the check numbers with related dates of issue, names of vendors, amounts paid, and paid invoice numbers will be forwarded to Contractor in order that Contractor can accurately track payment.
- J. Contractor and Owner are encouraged to take advantage of all discounts available.
- K. Owner will issue to Contractor a deductive Change Order in the amount of the direct purchased materials. The amount equal to the sales tax which would have been paid if those materials had been purchased by Contractor will be credited to Owner through a Contingency line item on the pay application's schedule of values, and the Contract Price specified in Article 4 of the Agreement shall be reduced by an amount equal to the amounts paid directly by Owner for direct purchases made pursuant to this Article, plus an amount equal to the sales tax that would have been paid if those materials had been purchased by Contractor.

#### 6.10 *Laws and Regulations*

- A. Contractor shall give all notices required by and shall comply with all Laws and Regulations applicable to the performance of the Work. Except where otherwise expressly required by applicable Laws and Regulations, neither Owner nor Engineer shall be responsible for monitoring Contractor's compliance with any Laws or Regulations.
- B. It shall be Contractor's responsibility to make certain that the Work described in the Contract Documents is in accordance with Laws and Regulations. Contractor shall bear all costs and losses, and shall indemnify and hold harmless Owner and Owner's officers and employees from and against



all liabilities, damages, losses, and costs, including, but not limited to, reasonable attorney's fees arising out of or relating to Work or other action that is contrary to Laws or Regulations.

- C. Owner or Contractor may give notice to the other party of any changes after the submission of Contractor's Bid (or after the date when Contractor became bound under a negotiated contract) in Laws or Regulations having an effect on the cost or time of performance of the Work, including but not limited to changes in Laws or Regulations having an effect on procuring permits and on sales, use, value-added, consumption, and other similar taxes. If Owner and Contractor are unable to agree on entitlement to or on the amount or extent, if any, of any adjustment in Contract Price or Contract Times resulting from such changes, then within 30 days of such notice Contractor may submit a Change Proposal, or Owner may initiate a Claim.

#### 6.11 *Record Documents*

- A. Contractor shall maintain in a safe place at the Site one printed record copy of all Drawings, Specifications, Addenda, Change Orders, Work Change Directives, Field Orders, written interpretations and clarifications, and approved Shop Drawings. Contractor shall keep such record documents in good order and annotate them to show changes made during construction. These record documents, together with all approved Samples, will be available to Owner for reference. Upon completion of the Work, Contractor shall deliver these record documents to Engineer.

#### 6.12 *Safety and Protection*

- A. Contractor shall be solely responsible for initiating, maintaining, and supervising all safety precautions and programs in connection with the Work. Such responsibility does not relieve Subcontractors of their responsibility for the safety of persons or property in the performance of their work, nor for compliance with applicable safety Laws and Regulations. Contractor shall take all necessary precautions for the safety of, and shall provide the necessary protection to prevent damage, injury, or loss to:
  - 1. all persons on the Site or who may be affected by the Work;
  - 2. all the Work and materials and equipment to be incorporated therein, whether in storage on or off the Site; and
  - 3. other property at the Site or adjacent thereto, including trees, shrubs, lawns, walks, pavements, roadways, structures, other work in progress, utilities, and Underground Facilities not designated for removal, relocation, or replacement in the course of construction.
- B. Contractor shall comply with all applicable Laws and Regulations relating to the safety of persons or property, or to the protection of persons or property from damage, injury, or loss; and shall erect and maintain all necessary safeguards for such safety and protection. Contractor shall notify Owner; the owners of adjacent property, Underground Facilities, and other utilities; and other contractors and utility owners performing work at or adjacent to the Site, when prosecution of the Work may affect them, and shall cooperate with them in the protection, removal, relocation, and replacement of their property or work in progress.
- C. Contractor shall comply with the applicable requirements of Owner's safety programs, if any. The Supplementary Conditions identify any Owner's safety programs that are applicable to the Work.
- D. Contractor shall inform Owner and Engineer of the specific requirements of Contractor's safety program with which Owner's and Engineer's employees and representatives must comply while at the Site.
- E. All damage, injury, or loss to any property referred to in Paragraph 6.12.A.2 or 6.12.A.3 caused, directly or indirectly, in whole or in part, by Contractor, any Subcontractor, Supplier, or any other individual or entity directly or indirectly employed by any of them to perform any of the Work, or anyone for whose acts any of them may be liable, shall be remedied by Contractor at its expense (except

damage or loss attributable to the fault of Drawings or Specifications or to the acts or omissions of Owner or Engineer or anyone employed by any of them, or anyone for whose acts any of them may be liable, and not attributable, directly or indirectly, in whole or in part, to the fault or negligence of Contractor or any Subcontractor, Supplier, or other individual or entity directly or indirectly employed by any of them).

- F. Contractor's duties and responsibilities for safety and protection shall continue until such time as all the Work is completed and Engineer has issued a notice to Owner and Contractor in accordance with Paragraph 14.06.B that the Work is acceptable (except as otherwise expressly provided in connection with Substantial Completion).
- G. Contractor's duties and responsibilities for safety and protection shall resume whenever Contractor or any Subcontractor or Supplier returns to the Site to fulfill warranty or correction obligations, or to conduct other tasks arising from the Contract Documents.
- H. Contractor shall pay for all damages to private property, public property, and any public utilities.

#### 6.13 *Safety Representative*

- A. Contractor shall designate a qualified and experienced safety representative at the Site whose duties and responsibilities shall be the prevention of accidents and the maintaining and supervising of safety precautions and programs.

#### 6.14 *Hazard Communication Programs*

- A. Contractor shall be responsible for coordinating any exchange of material safety data sheets or other hazard communication information required to be made available to or exchanged between or among employers at the Site in accordance with Laws or Regulations.

#### 6.15 *Emergencies*

- A. In emergencies affecting the safety or protection of persons or the Work or property at the Site or adjacent thereto, Contractor is obligated to act to prevent threatened damage, injury, or loss. Contractor shall give Engineer prompt written notice if Contractor believes that any significant changes in the Work or variations from the Contract Documents have been caused thereby or are required as a result thereof. If Engineer determines that a change in the Contract Documents is required because of the action taken by Contractor in response to such an emergency, a Work Change Directive or Change Order will be issued.

#### 6.16 *Shop Drawings, Samples, and Other Submittals*

- A. Shop Drawing and Sample Submittal Requirements:
  - 1. Before submitting a Shop Drawing or Sample, Contractor shall have:
    - a. reviewed and coordinated the Shop Drawing or Sample with other Shop Drawings and Samples and with the requirements of the Work and the Contract Documents;
    - b. determined and verified all field measurements, quantities, dimensions, specified performance and design criteria, installation requirements, materials, catalog numbers, and similar information with respect thereto;
    - c. determined and verified the suitability of all materials and equipment offered with respect to the indicated application, fabrication, shipping, handling, storage, assembly, and installation pertaining to the performance of the Work; and
    - d. determined and verified all information relative to Contractor's responsibilities for means, methods, techniques, sequences, and procedures of construction, and safety precautions and programs incident thereto.

2. Each submittal shall bear a stamp or specific written certification that Contractor has satisfied

Contractor's obligations under the Contract Documents with respect to Contractor's review of that submittal, and that Contractor approves the submittal.

3. With each submittal, Contractor shall give Engineer specific written notice of any variations that the Shop Drawing or Sample may have from the requirements of the Contract Documents. This notice shall be set forth in a written communication separate from the Shop Drawings or Sample submittal; and, in addition, in the case of Shop Drawings by a specific notation made on each Shop Drawing submitted to Engineer for review and approval of each such variation.

B. *Submittal Procedures for Shop Drawings and Samples:* Contractor shall submit Shop Drawings and Samples to Engineer for review and approval in accordance with the accepted Schedule of Submittals. Each submittal will be identified as Engineer may require.

1. Shop Drawings:

- a. Contractor shall submit the number of copies required in the Specifications.
- b. Data shown on the Shop Drawings will be complete with respect to quantities, dimensions, specified performance and design criteria, materials, and similar data to show Engineer the services, materials, and equipment Contractor proposes to provide and to enable Engineer to review the information for the limited purposes required by Paragraph 6.16.D.

2. Samples:

- a. Contractor shall submit the number of Samples required in the Specifications.
- b. Contractor shall clearly identify each Sample as to material, Supplier, pertinent data such as catalog numbers, the use for which intended and other data as Engineer may require to enable Engineer to review the submittal for the limited purposes required by Paragraph 6.16.D.

3. Where a Shop Drawing or Sample is required by the Contract Documents or the Schedule of Submittals, any related Work performed prior to Engineer's review and approval of the pertinent submittal will be at the sole expense and responsibility of Contractor.

C. *Other Submittals:* Contractor shall submit other submittals to Engineer in accordance with the accepted Schedule of Submittals, and pursuant to the applicable terms of the Specifications.

D. *Engineer's Review:*

1. Engineer will provide timely review of Shop Drawings and Samples in accordance with the Schedule of Submittals acceptable to Engineer. Engineer's review and approval will be only to determine if the items covered by the submittals will, after installation or incorporation in the Work, conform to the information given in the Contract Documents and be compatible with the design concept of the completed Project as a functioning whole as indicated by the Contract Documents.
2. Engineer's review and approval will not extend to means, methods, techniques, sequences, or procedures of construction or to safety precautions or programs incident thereto.
3. Engineer's review and approval of a separate item as such will not indicate approval of the assembly in which the item functions.
4. Engineer's review and approval of a Shop Drawing or Sample shall not relieve Contractor from responsibility for any variation from the requirements of the Contract Documents unless Contractor has complied with the requirements of Paragraph 6.16.A.3 and Engineer has given written approval of each such variation by specific written notation thereof incorporated in or accompanying the Shop Drawing or Sample. Engineer will document any such approved variation from the requirements of the Contract Documents in a Field Order.
5. Engineer's review and approval of a Shop Drawing or Sample shall not relieve Contractor from responsibility for complying with the requirements of Paragraph 6.16.A and B.

6. Engineer's review and approval of a Shop Drawing or Sample, or of a variation from the requirements of the Contract Documents, shall not, under any circumstances, change the Contract Times or Contract Price, unless such changes are included in a Change Order.
7. Neither Engineer's receipt, review, acceptance or approval of a Shop Drawing, Sample, or other submittal shall result in such item becoming a Contract Document.
8. Contractor shall perform the Work in compliance with the requirements and commitments set forth in approved Shop Drawings and Samples, subject to the provisions of Paragraph 6.16.D.4.

E. Resubmittal Procedures:

1. Contractor shall make corrections required by Engineer and shall return the required number of corrected copies of Shop Drawings and submit, as required, new Samples for review and approval. Contractor shall direct specific attention in writing to revisions other than the corrections called for by Engineer on previous submittals.
2. Contractor shall furnish required submittals with sufficient information and accuracy to obtain required approval of an item with no more than three submittals. Engineer will record Engineer's time for reviewing a fourth or subsequent submittal of a Shop Drawings, sample, or other item requiring approval, and Contractor shall be responsible for Engineer's charges to Owner for such time. Owner may impose a set-off against payments due to Contractor to secure reimbursement for such charges.
3. If Contractor requests a change of a previously approved submittal item, Contractor shall be responsible for Engineer's charges to Owner for its review time, and Owner may impose a set-off against payments due to Contractor to secure reimbursement for such charges, unless the need for such change is beyond the control of Contractor.

6.17 *Contractor's General Warranty and Guarantee*

- A. Contractor warrants and guarantees to Owner that all Work will be in accordance with the Contract Documents and will not be defective. Engineer and its officers, directors, members, partners, employees, agents, consultants, and subcontractors shall be entitled to rely on Contractor's warranty and guarantee.
- B. Contractor's warranty and guarantee hereunder excludes defects or damage caused by:
  1. abuse, modification, or improper maintenance or operation by persons other than Contractor, Subcontractors, Suppliers, or any other individual or entity for whom Contractor is responsible; or
  2. normal wear and tear under normal usage.
- C. Contractor's obligation to perform and complete the Work in accordance with the Contract Documents shall be absolute. None of the following will constitute an acceptance of Work that is not in accordance with the Contract Documents or a release of Contractor's obligation to perform the Work in accordance with the Contract Documents:
  1. observations by Engineer;
  2. recommendation by Engineer or payment by Owner of any progress or final payment;
  3. the issuance of a certificate of Substantial Completion by Engineer or any payment related thereto by Owner;
  4. use or occupancy of the Work or any part thereof by Owner;
  5. any review and approval of a Shop Drawing or Sample submittal;
  6. the issuance of a notice of acceptability by Engineer;
  7. any inspection, test, or approval by others; or

8. any correction of defective Work by Owner.

- D. If the Contract requires the Contractor to accept the assignment of a contract entered into by Owner, then the specific warranties, guarantees, and correction obligations contained in the assigned contract shall govern with respect to Contractor's performance obligations to Owner for the Work described in the assigned contract.
- E. All materials incorporated in the Work shall comply with the requirements of the Construction Documents. Any Defective Work which develop within 1 year after the date of final acceptance shall be promptly repaired by or replaced to "as new" condition by Contractor without any additional expense to Owner.

6.18 *Indemnification* The following "Statement of Indemnification" will be incorporated in the contract entered into in connection with this ITB.

COUNTY INDEMNIFICATION:

"The CONTRACTOR agrees to be liable for any and all damages, losses, and expenses incurred, by the COUNTY, in any way related to the services provided herein and this Agreement, caused by the acts and/or omissions of the CONTRACTOR, or any of its employees, agents, sub-contractors, representatives, volunteers or the like. The CONTRACTOR agrees to indemnify, defend and hold the COUNTY harmless for any and all such claims, suits, judgments or damages, losses and expenses, including but not limited to, court costs, expert witnesses, consultation services and attorney's fees, arising from any and all acts and/or omissions of the CONTRACTOR, or any of its employees, agents, sub-contractors, representatives, volunteers, or the like through and including any appeals in any way related to the services provided herein and this Agreement. Said indemnification, defense, and hold harmless actions shall not be limited by any required insurance coverage amounts set forth herein and shall survive termination or natural termination of this Agreement. All pages included in or attached by reference to this ITB shall be called and constitute the Invitation to Bid as stated on the front page of this ITB."

6.19 *Delegation of Professional Design Services*

- A. Contractor will not be required to provide professional design services unless such services are specifically required by the Contract Documents for a portion of the Work or unless such services are required to carry out Contractor's responsibilities for construction means, methods, techniques, sequences and procedures. Contractor shall not be required to provide professional services in violation of applicable Laws and Regulations.
- B. If professional design services or certifications by a design professional related to systems, materials, or equipment are specifically required of Contractor by the Contract Documents, Owner and Engineer will specify all performance and design criteria that such services must satisfy. Contractor shall cause such services or certifications to be provided by a properly licensed professional, whose signature and seal shall appear on all drawings, calculations, specifications, certifications, and other submittals prepared by such professional. Shop Drawings and other submittals related to the Work designed or certified by such professional, if prepared by others, shall bear such professional's written approval when submitted to Engineer.
- C. Owner and Engineer shall be entitled to rely upon the adequacy, accuracy, and completeness of the services, certifications, or approvals performed by such design professionals, provided Owner and Engineer have specified to Contractor all performance and design criteria that such services must satisfy.
- D. Pursuant to this paragraph, Engineer's review and approval of design calculations and design drawings will be only for the limited purpose of checking for conformance with performance and design criteria given and the design concept expressed in the Contract Documents. Engineer's review and approval of Shop Drawings and other submittals (except design calculations and design drawings) will

be only for the purpose stated in Paragraph 6.16.D.1.

- E. Contractor shall not be responsible for the adequacy of the performance or design criteria specified by Owner or Engineer.
- F. If Contractor provides professional design services as a design professional, as that term is defined in Section 725.08(4), Florida Statutes, Contractor shall indemnify and hold harmless Owner and Owner's officers and employees, from liabilities, damages, losses, and costs, including, but not limited to reasonable attorneys' fees, to the extent caused by the negligence, recklessness, or intentionally wrongful conduct of Contractor providing professional design services as a design professional and other persons employed or utilized by Contractor in the performance of the professional design services.

#### **6.20 *Storage of Materials***

- A. The responsibility for the protection and safekeeping of equipment and materials on or near the Site will be entirely that of Contractor, and no claim shall be made against Owner by reason of any act of an employee or trespasser. Should an occasion arise necessitating access to the Sites occupied by these stored materials and equipment, Contractor shall immediately move same. No materials or equipment may be placed upon the property of Owner until Owner has approved the location contemplated by Contractor to be used for storage.

#### **6.21 *Erosion and Drainage Control***

- A. Contractor shall implement Best Management Practices (BMP's) to provide for drainage of storm water and such water as may be applied or discharged on the Site in performance of the Work. Drainage facilities shall be adequate to prevent damage to the Work, the Site and adjacent property.
- B. Contractor shall prevent the pollution of drains and watercourses by sanitary wastes, sediment, debris or other substances resulting from this work. Contractor shall clean up and isolate such materials on a continuing basis to prevent risk of washing into such drainage ways.
- C. Contractor shall determine if a Stormwater Discharge Permit or a Construction Dewatering Discharge Permit applies to the Work. Contractor shall obtain required permit(s) if necessary for completion of the Work.

#### **6.22 *Protection of Trees and Natural Conditions***

- A. No trees or shrubs shall be damaged or removed beyond delineated limits of disturbance except those flagged by Owner. No areas shall be disturbed beyond the designated limits indicated by Owner. Contractor shall install orange safety fence to delineate limits of disturbance, and Contractor shall be responsible for damage mitigation beyond these limits.

#### **6.23 *Dewatering***

- A. If dewatering is required at the Site, Contractor shall comply with all dewatering requirements of governmental agencies.

#### **6.24 *Protection of Public and Private Property***

- A. Contractor shall protect, shore, brace, support and maintain all underground pipes, conduits, drains, and other underground or above ground structures uncovered or otherwise affected by the construction of the Work performed by Contractor. All pavement, surfacing, driveways, curbs, walks, buildings, utility poles, guy wires, fences, guard posts, and other surface structures affected by construction operations, together with all trees, sod and shrubs in yards and parking lots removed or damaged, shall be restored to their original condition or replaced as determined and approved by Owner, whether within or outside Owner's right-of-way. All replacements shall be made with new materials.

- B. Contractor shall be responsible for all damages to streets, roads, highways, shoulders, ditches, embankments, culverts, facilities and utilities, bridges, property corners and monuments and other public or private property, regardless of location or character, which may be caused by construction of the Work or by transporting equipment, materials or men to or from the Work or any part or site thereof, whether by Contractor or Contractor's Subcontractors. Contractor shall make satisfactory and acceptable arrangements with the owner of, or the agency or authority having jurisdiction over, the damaged property concerning its repair or replacement or payment of costs incurred in connection with the damage.
- C. All fire hydrants and water control valves shall be kept free from obstruction and for use at all times.
- D. Contractor shall be responsible for any damage to existing structures during the course of the Work.

#### 6.25 *Maintenance of Traffic*

- A. Contractor shall provide traffic control plans as required by the controlling highway, street or road authority. Contractor shall perform the Work so as to interfere as little as possible with public travel, whether vehicular or pedestrian. Whenever necessary to cross, use, obstruct or close roads, driveways and walks, whether public or private, Contractor shall, at its own expense, provide and maintain suitable and safe bridges, detours or other temporary expedients, for the accommodation of public and private travel, and shall give reasonable notice to owners of private drives before interfering with them. Such maintenance of traffic will not be required when Contractor has obtained permission from the owner and tenant of private property, or from the authority having jurisdiction over the public property involved, to obstruct traffic at the designated point. Obstructions, such as material piles and equipment, shall be provided with appropriate warning signs and lights.
- B. After completion, the roadway shall be restored to original condition, and disturbed areas shall be restored to original condition.

#### 6.26 *Testing*

- A. Contractor shall be responsible for all testing required for sampling and testing of materials to prove compliance with the Contract Documents. This shall include, but not be limited to mix design approvals for concrete and asphalt, pipe bedding gradations and Proctor tests and gradations for imported granular fill materials. Specific requirements shall be included in the applicable specification sections.
- B. Tests required to monitor control performance of the Work in accordance with the Contract Documents such as concrete cylinder tests and compaction tests shall be ordered and paid for by Contractor. Any retesting required as a result of the first test failure will be at Contractor's expense. Contractor will assist in providing locations and allowing the tests to be conducted without obstructions and in accordance with all Laws and Regulations. Contractor shall correct or modify its operations where indicated necessary by the test results.

#### 6.27 *Unfavorable Construction Conditions*

- A. During unfavorable weather, wet ground or other unsuitable construction conditions, Contractor shall confine its operations to work which will not be affected adversely by such conditions. No portion of the Work shall be constructed under conditions which affect adversely the quality or efficiency thereof, unless special means or precautions are taken by Contractor to perform the Work in a proper and satisfactory manner.

#### 6.28 *Notices to Owners and Authorities*

- A. Contractor shall notify owners of adjacent property and utilities when prosecution of Work may affect them.
- B. Utilities and other concerned agencies shall be contracted at least 48 hours prior to cutting or closing streets or other traffic areas or excavating near Underground Facilities or pole lines.

## 6.29 *Storage of Fuel or Hazardous Materials*

- A. No fuel or other hazardous materials shall be stored on the Site. Extreme care and compliance with all regulations shall be required when handling all such materials.

## **ARTICLE 7: OTHER WORK AT THE SITE**

### 7.01 *Other Work*

- A. In addition to and apart from the Work under the Contract Documents, the Owner may perform other work at or adjacent to the Site. Such other work may be performed by Owner's employees, or through contracts between the Owner and third parties. Owner may also arrange to have third-party utility owners perform work on their utilities and facilities at or adjacent to the Site.
- B. If Owner performs other work at or adjacent to the Site with Owner's employees, or through contracts for such other work, then Owner shall give Contractor written notice thereof prior to starting any such other work. If Owner has advance information regarding the start of any utility work at or adjacent to the Site, Owner shall provide such information to Contractor.
- C. Contractor shall afford each other contractor that performs such other work, each utility owner performing other work, and Owner, if Owner is performing other work with Owner's employees, proper and safe access to the Site, and provide a reasonable opportunity for the introduction and storage of materials and equipment and the execution of such other work. Contractor shall do all cutting, fitting, and patching of the Work that may be required to properly connect or otherwise make its several parts come together and properly integrate with such other work. Contractor shall not endanger any work of others by cutting, excavating, or otherwise altering such work; provided, however, that Contractor may cut or alter others' work with the written consent of Engineer and the others whose work will be affected.
- D. If the proper execution or results of any part of Contractor's Work depends upon work performed by others under this Article 7, Contractor shall inspect such other work and promptly report to Engineer in writing any delays, defects, or deficiencies in such other work that render it unavailable or unsuitable for the proper execution and results of Contractor's Work. Contractor's failure to so report will constitute an acceptance of such other work as fit and proper for integration with Contractor's Work except for latent defects and deficiencies in such other work.

### 7.02 *Coordination*

- A. If Owner intends to contract with others for the performance of other work at or adjacent to the Site, to perform other work at or adjacent to the Site with Owner's employees, or to arrange to have utility owners perform work at or adjacent to the Site, the following will be set forth in the Supplementary Conditions or provided to Contractor prior to the start of any such other work:
  - 1. the identity of the individual or entity that will have authority and responsibility for coordination of the activities among the various contractors;
  - 2. an itemization of the specific matters to be covered by such authority and responsibility; and
  - 3. the extent of such authority and responsibilities.
- B. Unless otherwise provided in the Supplementary Conditions, Owner shall have sole authority and responsibility for such coordination.

### 7.03 *Legal Relationships*

- A. If, in the course of performing other work at or adjacent to the Site for Owner, the Owner's employees, any other contractor working for Owner, or any utility owner causes damage to the Work or to the property of Contractor or its Subcontractors, or delays, disrupts, interferes with, or increases the scope



or cost of the performance of the Work, through actions or inaction, then Contractor shall be entitled to an equitable adjustment in the Contract Price or the Contract Times, or both. Contractor must submit any Change Proposal seeking an equitable adjustment in the Contract Price or the Contract Times under this paragraph within 30 days of the damaging, delaying, disrupting, or interfering event. The entitlement to, and extent of, any such equitable adjustment shall take into account information (if any) regarding such other work that was provided to Contractor in the Contract Documents prior to the submittal of the Bid or the final negotiation of the terms of the Contract. When applicable, any such equitable adjustment in Contract Price shall be conditioned on Contractor assigning to Owner all Contractor's rights against such other contractor or utility owner with respect to the damage, delay, disruption, or interference that is the subject of the adjustment. Contractor's entitlement to an adjustment of the Contract Times is conditioned on such adjustment being essential to Contractor's ability to complete the Work within the Contract Times.

- B. Contractor shall take reasonable and customary measures to avoid damaging, delaying, disrupting, or interfering with the work of Owner, any other contractor, or any utility owner performing other work at or adjacent to the Site. If Contractor fails to take such measures and as a result damages, delays, disrupts, or interferes with the work of any such other contractor or utility owner, then Owner may impose a set-off against payments due to Contractor, and assign to such other contractor or utility owner the Owner's contractual rights against Contractor with respect to the breach of the obligations set forth in this paragraph.
- C. When Owner is performing other work at or adjacent to the Site with Owner's employees, Contractor shall be liable to Owner for damage to such other work, and for the reasonable direct delay, disruption, and interference costs incurred by Owner as a result of Contractor's failure to take reasonable and customary measures with respect to Owner's other work. In response to such damage, delay, disruption, or interference, Owner may impose a set-off against payments due to Contractor.
- D. If Contractor damages, delays, disrupts, or interferes with the work of any other contractor, or any utility owner performing other work at or adjacent to the Site, through Contractor's failure to take reasonable and customary measures to avoid such impacts, or if any claim arising out of Contractor's actions, inactions, or negligence in performance of the Work at or adjacent to the Site is made by any such other contractor or utility owner against Contractor, Owner, or Engineer, then Contractor shall (1) promptly attempt to settle the claim as to all parties through negotiations with such other contractor or utility owner, or otherwise resolve the claim by arbitration or other dispute resolution proceeding or at law, and (2) indemnify and hold harmless Owner and Engineer, and the officers, directors, members, partners, employees, agents, consultants and subcontractors of each and any of them from and against any such claims, and against all costs, losses, and damages (including but not limited to all fees and charges of engineers, architects, attorneys, and other professionals and all court or arbitration or other dispute resolution costs) arising out of or relating to such damage, delay, disruption, or interference.

## **ARTICLE 8: OWNER'S RESPONSIBILITIES**

### **8.01 *Communications to Contractor***

- A. Except as otherwise provided in these General Conditions, Owner shall issue all communications to Contractor through Engineer.

### **8.02 *Replacement of Engineer***

- A. Owner may at its discretion appoint an engineer to replace Engineer, provided Contractor makes no reasonable objection to the replacement engineer. The replacement engineer's status under the Contract Documents shall be that of the former Engineer.

### 8.03 *Furnish Data*

- A. Owner shall promptly furnish the data required of Owner under the Contract Documents.

### 8.04 *Pay When Due*

- A. Owner shall make payments to Contractor when they are due as provided in the Agreement.

### 8.05 *Lands and Easements; Reports, Tests, and Drawings*

- A. Owner's duties with respect to providing lands and easements are set forth in Paragraph 5.01.
- B. Owner's duties with respect to providing engineering surveys to establish reference points are set forth in Paragraph 4.03.
- C. Article 5 refers to Owner's identifying and making available to Contractor copies of reports of explorations and tests of conditions at the Site, and drawings of physical conditions relating to existing surface or subsurface structures at the Site.

### 8.06 *Insurance*

- A. Owner's responsibilities, if any, with respect to purchasing and maintaining liability and property insurance are set forth in Section 00250.

### 8.07 *Change Orders*

- A. Owner's responsibilities with respect to Change Orders are set forth in Article 10.

### 8.08 *Inspections, Tests, and Approvals*

- A. Owner's responsibility with respect to certain inspections, tests, and approvals is set forth in Paragraph 13.02.B.

### 8.09 *Limitations on Owner's Responsibilities*

- A. The Owner shall not supervise, direct, or have control or authority over, nor be responsible for, Contractor's means, methods, techniques, sequences, or procedures of construction, or the safety precautions and programs incident thereto, or for any failure of Contractor to comply with Laws and Regulations applicable to the performance of the Work. Owner will not be responsible for Contractor's failure to perform the Work in accordance with the Contract Documents.

### 8.10 *Undisclosed Hazardous Environmental Condition*

- A. Owner's responsibility in respect to an undisclosed Hazardous Environmental Condition is set forth in Paragraph 5.06.

### 8.11 *Evidence of Financial Arrangements*

- A. Upon request of Contractor, Owner shall furnish Contractor reasonable evidence that financial arrangements have been made to satisfy Owner's obligations under the Contract Documents (including obligations under proposed changes in the Work).

### 8.12 *Safety Programs*

- A. While at the Site, Owner's employees and representatives shall comply with the specific applicable requirements of Contractor's safety programs of which Owner has been informed.
- B. Owner shall furnish copies of any applicable Owner safety programs to Contractor.

## **ARTICLE 9: ENGINEER'S STATUS DURING CONSTRUCTION**

### 9.01 *Owner's Representative*

- A. Engineer will be Owner's representative during the construction period. The duties and responsibilities

and the limitations of authority of Engineer as Owner's representative during construction are set forth in the Contract.

**9.02 Visits to Site**

- A. Engineer will make visits to the Site at intervals appropriate to the various stages of construction as Engineer deems necessary in order to observe as an experienced and qualified design professional the progress that has been made and the quality of the various aspects of Contractor's executed Work. Based on information obtained during such visits and observations, Engineer, for the benefit of Owner, will determine, in general, if the Work is proceeding in accordance with the Contract Documents. Engineer will not be required to make exhaustive or continuous inspections on the Site to check the quality or quantity of the Work. Engineer's efforts will be directed toward providing for Owner a greater degree of confidence that the completed Work will conform generally to the Contract Documents. On the basis of such visits and observations, Engineer will keep Owner informed of the progress of the Work and will endeavor to guard Owner against defective Work.
- B. Engineer's visits and observations are subject to all the limitations on Engineer's authority and responsibility set forth in Paragraph 9.08. Particularly, but without limitation, during or as a result of Engineer's visits or observations of Contractor's Work, Engineer will not supervise, direct, control, or have authority over or be responsible for Contractor's means, methods, techniques, sequences, or procedures of construction, or the safety precautions and programs incident thereto, or for any failure of Contractor to comply with Laws and Regulations applicable to the performance of the Work.

**9.03 Project Representative**

- A. If Owner and Engineer have agreed that Engineer will furnish a Resident Project Representative to represent Engineer at the Site and assist Engineer in observing the progress and quality of the Work, then the authority and responsibilities of any such Resident Project Representative will be as provided in the Supplementary Conditions, and limitations on the responsibilities thereof will be as provided in Paragraph 9.08. If Owner designates another representative or agent to represent Owner at the Site who is not Engineer's consultant, agent, or employee, the responsibilities and authority and limitations thereon of such other individual or entity will be as provided in the Supplementary Conditions.

**9.04 Rejecting Defective Work**

- A. Engineer has the authority to reject Work in accordance with Article 13.

**9.05 Shop Drawings, Change Orders and Payments**

- A. Engineer's authority, and limitations thereof, as to Shop Drawings and Samples, are set forth in Paragraph 6.16.
- B. Engineer's authority, and limitations thereof, as to design calculations and design drawings submitted in response to a delegation of professional design services, if any, are set forth in Paragraph 6.19.
- C. Engineer's authority as to Change Orders is set forth in Article 9.
- D. Engineer's authority as to Applications for Payment is set forth in Article 13.

**9.06 Determinations for Unit Price Work**

- A. Engineer will determine the actual quantities and classifications of Unit Price Work performed by Contractor as set forth in Paragraph 12.03.

**9.07 Decisions on Requirements of Contract Documents and Acceptability of Work**

- A. Engineer will render decisions regarding the requirements of the Contract Documents, and judge the acceptability of the Work, pursuant to the specific procedures set forth herein for initial interpretations, Change Proposals, and acceptance of the Work. In rendering such decisions and judgments, Engineer will not show partiality to Owner or Contractor, and will not be liable to Owner, Contractor, or others in

connection with any proceedings, interpretations, decisions, or judgments conducted or rendered in good faith.

**9.08** *Limitations on Engineer's Authority and Responsibilities*

- A. Neither Engineer's authority or responsibility under this Article 10 or under any other provision of the Contract, nor any decision made by Engineer in good faith either to exercise or not exercise such authority or responsibility or the undertaking, exercise, or performance of any authority or responsibility by Engineer, shall create, impose, or give rise to any duty in contract, tort, or otherwise owed by Engineer to Contractor, any Subcontractor, any Supplier, any other individual or entity, or to any surety for or employee or agent of any of them.
- B. Engineer will not supervise, direct, control, or have authority over or be responsible for Contractor's means, methods, techniques, sequences, or procedures of construction, or the safety precautions and programs incident thereto, or for any failure of Contractor to comply with Laws and Regulations applicable to the performance of the Work. Engineer will not be responsible for Contractor's failure to perform the Work in accordance with the Contract Documents.
- C. Engineer will not be responsible for the acts or omissions of Contractor or of any Subcontractor, any Supplier, or of any other individual or entity performing any of the Work.
- D. Engineer's review of the final Application for Payment and accompanying documentation and all maintenance and operating instructions, schedules, guarantees, bonds, certificates of inspection, tests and approvals, and other documentation required to be delivered by Paragraph 14.06.A will only be to determine generally that their content complies with the requirements of, and in the case of certificates of inspections, tests, and approvals, that the results certified indicate compliance with the Contract Documents.
- E. The limitations upon authority and responsibility set forth in this Paragraph 9.08 shall also apply to the Resident Project Representative, if any.

**9.09** *Compliance with Safety Program*

- A. While at the Site, Engineer's employees and representatives will comply with the specific applicable requirements of Owner's and Contractor's safety programs (if any) of which Engineer has been informed.

**ARTICLE 10: AMENDING THE CONTRACT DOCUMENTS; CHANGES IN THE WORK**

**10.01** *Amending and Supplementing Contract Documents*

- A. The Contract Documents may be amended or supplemented by a Change Order, a Work Change Directive, or a Field Order if approved, in writing, by Owner.
  - 1. Change Orders:
    - a. If an amendment or supplement to the Contract Documents includes a change in the Contract Price or the Contract Times, such amendment or supplement must be set forth in a Change Order. A Change Order also may be used to establish amendments and supplements of the Contract Documents that do not affect the Contract Price or Contract Times.
    - b. Owner and Contractor may amend those terms and conditions of the Contract Documents that do not involve (1) the performance or acceptability of the Work, (2) the design (as set forth in the Drawings, Specifications, or otherwise), or (3) other engineering or technical matters, without the recommendation of the Engineer. Such an amendment shall be set forth in a Change Order.
  - 2. *Work Change Directives*: A Work Change Directive will not change the Contract Price or the Contract Times but is evidence that the parties expect that the modification ordered or documented

by a Work Change Directive will be incorporated in a subsequently issued Change Order, following negotiations by the parties as to the Work Change Directive's effect, if any, on the Contract Price and Contract Times; or, if negotiations are unsuccessful, by a determination under the terms of the Contract Documents governing adjustments, expressly including Paragraph 10.04 regarding change of Contract Price. Contractor must submit any Change Proposal seeking an adjustment of the Contract Price or the Contract Times, or both, no later than 30 days after the completion of the Work set out in the Work Change Directive. Owner must submit any Claim seeking an adjustment of the Contract Price or the Contract Times, or both, no later than 60 days after issuance of the Work Change Directive.

3. *Field Orders*: Engineer may authorize minor changes in the Work if the changes do not involve an adjustment in the Contract Price or the Contract Times and are compatible with the design concept of the completed Project as a functioning whole as indicated by the Contract Documents. Such changes will be accomplished by a Field Order and will be binding on Owner and also on Contractor, which shall perform the Work involved promptly. If Contractor believes that a Field Order justifies an adjustment in the Contract Price or Contract Times, or both, then before proceeding with the Work at issue, Contractor shall submit a Change Proposal as provided herein.

#### 10.02 *Owner-Authorized Changes in the Work*

- A. Without invalidating the Contract and without notice to any surety, Owner may, at any time or from time to time, order additions, deletions, or revisions in the Work. Such changes shall be supported by Engineer's recommendation, to the extent the change involves the design (as set forth in the Drawings, Specifications, or otherwise), or other engineering or technical matters. Such changes may be accomplished by a Change Order, if Owner and Contractor have agreed as to the effect, if any, of the changes on Contract Times or Contract Price; or by a Work Change Directive. Upon receipt of any such document, Contractor shall promptly proceed with the Work involved; or, in the case of a deletion in the Work, promptly cease construction activities with respect to such deleted Work. Added or revised Work shall be performed under the applicable conditions of the Contract Documents. Nothing in this paragraph shall obligate Contractor to undertake work that Contractor reasonably concludes cannot be performed in a manner consistent with Contractor's safety obligations under the Contract Documents or Laws and Regulations.

#### 10.03 *Unauthorized Changes in the Work*

- A. Contractor shall not be entitled to an increase in the Contract Price or an extension of the Contract Times with respect to any work performed that is not required by the Contract Documents, as amended, modified, or supplemented, except in the case of an emergency as provided in Paragraph 6.15 or in the case of uncovering Work as provided in Paragraph 13.05.

#### 10.04 *Change of Contract Price*

- A. The Contract Price may only be changed by a Change Order. Any Change Proposal for an adjustment in the Contract Price shall comply with the provisions of Paragraph 10.06. Any Claim for an adjustment of Contract Price shall comply with the provisions of Article 11.
- B. An adjustment in the Contract Price will be determined as follows:
  1. where the Work involved is covered by unit prices contained in the Contract Documents, then by application of such unit prices to the quantities of the items involved (subject to the provisions of Paragraph 12.03); or
  2. where the Work involved is not covered by unit prices contained in the Contract Documents, then by a mutually agreed lump sum (which may include an allowance for overhead and profit not necessarily in accordance with Paragraph 10.04.C.2); or
  3. where the Work involved is not covered by unit prices contained in the Contract Documents and

the parties do not reach mutual agreement to a lump sum, then on the basis of the Cost of the Work (determined as provided in Paragraph 12.01) plus a Contractor's fee for overhead and profit (determined as provided in Paragraph 10.04.C).

- C. *Contractor's Fee:* When applicable, the Contractor's fee for overhead and profit shall be determined as follows:
1. a mutually acceptable fixed fee; or
  2. if a fixed fee is not agreed upon, then a fee based on the following percentages of the various portions of the Cost of the Work:
    - a. for costs incurred under Paragraphs 12.01.B.1 and 12.01.B.2, the Contractor's fee shall be 15 percent;
    - b. for costs incurred under Paragraph 12.01.B.3, the Contractor's fee shall be five percent;
    - c. where one or more tiers of subcontracts are on the basis of Cost of the Work plus a fee and no fixed fee is agreed upon, the intent of Paragraphs 10.01.C.2.a and 10.01.C.2.b is that the Contractor's fee shall be based on: (1) a fee of 15 percent of the costs incurred under Paragraphs 12.01.A.1 and 12.01.A.2 by the Subcontractor that actually performs the Work, at whatever tier, and (2) with respect to Contractor itself and to any Subcontractors of a tier higher than that of the Subcontractor that actually performs the Work, a fee of five percent of the amount (fee plus underlying costs incurred) attributable to the next lower tier Subcontractor; provided, however, that for any such subcontracted work the maximum total fee to be paid by Owner shall be no greater than 27 percent of the costs incurred by the Subcontractor that actually performs the work;
    - d. no fee shall be payable on the basis of costs itemized under Paragraphs 12.01.B.4, 12.01.B.5, and 12.01.C;
    - e. the amount of credit to be allowed by Contractor to Owner for any change which results in a net decrease in cost will be the amount of the actual net decrease in cost plus a deduction in Contractor's fee by an amount equal to five percent of such net decrease; and
    - f. when both additions and credits are involved in any one change, the adjustment in Contractor's fee shall be computed on the basis of the net change in accordance with Paragraphs 10.04.C.2.a through 10.04.C.2.e, inclusive.

#### *10.05 Change of Contract Times*

- A. The Contract Times may only be changed by a Change Order. Any Change Proposal for an adjustment in the Contract Times shall comply with the provisions of Paragraph 10.06. Any Claim for an adjustment in the Contract Times shall comply with the provisions of Article 11.
- B. An adjustment of the Contract Times shall be subject to the limitations set forth in Paragraph 4.05, concerning delays in Contractor's progress.

#### *10.06 Change Proposals*

- A. Contractor shall submit a Change Proposal to Engineer to request an adjustment in the Contract Times or Contract Price; appeal an initial decision by Engineer concerning the requirements of the Contract Documents or relating to the acceptability of the Work under the Contract Documents; contest a set-off against payment due; or seek other relief under the Contract. The Change Proposal shall specify any proposed change in Contract Times or Contract Price, or both, or other proposed relief, and explain the reason for the proposed change, with citations to any governing or applicable provisions of the Contract Documents.

1. *Procedures:* Contractor shall submit each Change Proposal to Engineer promptly (but in no event

later than 30 days) after the start of the event giving rise thereto, or after such initial decision. The Contractor shall submit supporting data, including the proposed change in Contract Price or Contract Time (if any), to the Engineer and Owner within 15 days after the submittal of the Change Proposal. The supporting data shall be accompanied by a written statement that the supporting data are accurate and complete, and that any requested time or price adjustment is the entire adjustment to which Contractor believes it is entitled as a result of said event. Engineer will advise Owner regarding the Change Proposal, and consider any comments or response from Owner regarding the Change Proposal.

2. *Engineer's Action*: Engineer will review each Change Proposal and, within 30 days after receipt of the Contractor's supporting data, either deny the Change Proposal in whole, approve it in whole, or deny it in part and approve it in part. Such actions shall be in writing, with a copy provided to Owner and Contractor. If Engineer does not take action on the Change Proposal within 30 days, then either Owner or Contractor may at any time thereafter submit a letter to the other party indicating that as a result of Engineer's inaction the Change Proposal is deemed denied, thereby commencing the time for appeal of the denial under Article 11.
  3. *Binding Decision*: Engineer's decision will be final and binding upon Owner and Contractor, unless Owner or Contractor appeals the decision by filing a Claim under Article 11.
- B. *Resolution of Certain Change Proposals*: If the Change Proposal does not involve the design (as set forth in the Drawings, Specifications, or otherwise), the acceptability of the Work, or other engineering or technical matters, then Engineer will notify the parties that the Engineer is unable to resolve the Change Proposal. For purposes of further resolution of such a Change Proposal, such notice shall be deemed a denial, and Contractor may choose to seek resolution under the terms of Article 11.

#### 10.07 Execution of Change Orders

- A. Owner and Contractor shall execute appropriate Change Orders covering:
1. changes in the Contract Price or Contract Times which are agreed to by the parties, including any undisputed sum or amount of time for Work actually performed in accordance with a Work Change Directive;
  2. changes in Contract Price resulting from an Owner set-off, unless Contractor has duly contested such set-off;
  3. changes in the Work which are: (a) ordered by Owner pursuant to Paragraph 10.02, (b) required because of Owner's acceptance of defective Work under Paragraph 13.04 or Owner's correction of defective Work under Paragraph 13.07, or (c) agreed to by the parties, subject to the need for Engineer's recommendation if the change in the Work involves the design (as set forth in the Drawings, Specifications, or otherwise), or other engineering or technical matters; and
  4. changes in the Contract Price or Contract Times, or other changes, which embody the substance of any final and binding results under Paragraph 10.06, or Article 11.
- B. If Owner or Contractor refuses to execute a Change Order that is required to be executed under the terms of this Paragraph 10.07, it shall be deemed to be of full force and effect, as if fully executed.

#### 10.08 Notification to Surety

- A. If the provisions of any bond require notice to be given to a surety of any change affecting the general scope of the Work or the provisions of the Contract Documents (including, but not limited to, Contract Price or Contract Times), the giving of any such notice will be Contractor's responsibility. The amount of each applicable bond will be adjusted to reflect the effect of any such change.

### ARTICLE 11: CLAIMS

## 11.01 Claims

- A. *Claims Process:* The following disputes between Owner and Contractor shall be submitted to the Claims process set forth in this Article:
1. Appeals by Owner or Contractor of Engineer's decisions regarding Change Proposals;
  2. Owner demands for adjustments in the Contract Price or Contract Times, or other relief under the Contract Documents; and
  3. Disputes that Engineer has been unable to address because they do not involve the design (as set forth in the Drawings, Specifications, or otherwise), the acceptability of the Work, or other engineering or technical matters.
- B. *Submittal of Claim:* The party submitting a Claim shall deliver it directly to the other party to the Contract promptly (but in no event later than 30 days) after the start of the event giving rise thereto; in the case of appeals regarding Change Proposals within 30 days of the decision under appeal. The party submitting the Claim shall also furnish a copy to the Engineer, for its information only. The responsibility to substantiate a Claim shall rest with the party making the Claim. In the case of a Claim by Contractor seeking an increase in the Contract Times or Contract Price, or both, Contractor shall certify that the Claim is made in good faith, that the supporting data are accurate and complete, and that to the best of Contractor's knowledge and belief the amount of time or money requested accurately reflects the full amount to which Contractor is entitled.
- C. *Review and Resolution:* The party receiving a Claim shall review it thoroughly, giving full consideration to its merits. The two parties shall seek to resolve the Claim through the exchange of information and direct negotiations. The parties may extend the time for resolving the Claim by mutual agreement. All actions taken on a Claim shall be stated in writing and submitted to the other party, with a copy to Engineer.
- D. *Mediation:*
1. At any time after initiation of a Claim, Owner and Contractor may mutually agree to mediation of the underlying dispute. The agreement to mediate shall stay the Claim submittal and response process.
  2. If Owner and Contractor agree to mediation, then after 60 days from such agreement, either Owner or Contractor may unilaterally terminate the mediation process, and the Claim submittal and decision process shall resume as of the date of the termination. If the mediation proceeds but is unsuccessful in resolving the dispute, the Claim submittal and decision process shall resume as of the date of the conclusion of the mediation, as determined by the mediator.
  3. Owner and Contractor shall each pay one-half of the mediator's fees and costs.
- E. *Partial Approval:* If the party receiving a Claim approves the Claim in part and denies it in part, such action shall be final and binding unless within 30 days of such action the other party invokes the procedure set forth in Article 16 for final resolution of disputes.
- F. *Denial of Claim:* If efforts to resolve a Claim are not successful, the party receiving the Claim may deny it by giving written notice of denial to the other party. If the receiving party does not take action on the Claim within 90 days, then either Owner or Contractor may at any time thereafter submit a letter to the other party indicating that as a result of the inaction, the Claim is deemed denied, thereby commencing the time for appeal of the denial. A denial of the Claim shall be final and binding unless within 30 days of the denial the other party invokes the procedure set forth in Article 16 for the final resolution of disputes.
- G. *Final and Binding Results:* If the parties reach a mutual agreement regarding a Claim, whether through approval of the Claim, direct negotiations, mediation, or otherwise; or if a Claim is approved in part



and denied in part, or denied in full, and such actions become final and binding; then the results of the agreement or action on the Claim shall be incorporated in a Change Order to the extent they affect the Contract, including the Work, the Contract Times, or the Contract Price.

## **ARTICLE 12: COST OF THE WORK; ALLOWANCES; UNIT PRICE WORK**

### *12.01 Cost of the Work*

- A. *Purposes for Determination of Cost of the Work:* The term Cost of the Work means the sum of all costs necessary for the proper performance of the Work at issue, as further defined below. The provisions of this Paragraph 12.01 are used for two distinct purposes:
1. To determine Cost of the Work when Cost of the Work is a component of the Contract Price, under cost-plus-fee, time-and-materials, or other cost-based terms; or
  2. To determine the value of a Change Order, Change Proposal, Claim, set-off, or other adjustment in Contract Price. When the value of any such adjustment is determined on the basis of Cost of the Work, Contractor is entitled only to those additional or incremental costs required because of the change in the Work or because of the event giving rise to the adjustment.
- B. *Costs Included:* Except as otherwise may be agreed to in writing by Owner, costs included in the Cost of the Work shall be in amounts no higher than those prevailing in the locality of the Project, shall not include any of the costs itemized in Paragraph 12.01.C, and shall include only the following items:
1. Payroll costs for employees in the direct employ of Contractor in the performance of the Work under schedules of job classifications agreed upon by Owner and Contractor. Such employees shall include, without limitation, superintendents, foremen, and other personnel employed full time on the Work. Payroll costs for employees not employed full time on the Work shall be apportioned on the basis of their time spent on the Work. Payroll costs shall include, but not be limited to, salaries and wages plus the cost of fringe benefits, which shall include social security contributions, unemployment, excise, and payroll taxes, workers' compensation, health and retirement benefits, bonuses, sick leave, and vacation and holiday pay applicable thereto. The expenses of performing Work outside of regular working hours, on Saturday, Sunday, or legal holidays, shall be included in the above to the extent authorized by Owner.
  2. Cost of all materials and equipment furnished and incorporated in the Work, including costs of transportation and storage thereof, and Suppliers' field services required in connection therewith. All cash discounts shall accrue to Contractor unless Owner deposits funds with Contractor with which to make payments, in which case the cash discounts shall accrue to Owner. All trade discounts, rebates, and refunds and returns from sale of surplus materials and equipment shall accrue to Owner, and Contractor shall make provisions so that they may be obtained.
  3. Payments made by Contractor to Subcontractors for Work performed by Subcontractors. If required by Owner, Contractor shall obtain competitive bids from subcontractors acceptable to Owner and Contractor and shall deliver such bids to Owner, who will then determine, with the advice of Engineer, which bids, if any, will be acceptable. If any subcontract provides that the Subcontractor is to be paid on the basis of Cost of the Work plus a fee, the Subcontractor's Cost of the Work and fee shall be determined in the same manner as Contractor's Cost of the Work and fee as provided in this Paragraph 12.01.
  4. Costs of special consultants (including but not limited to engineers, architects, testing laboratories, surveyors, attorneys, and accountants) employed for services specifically related to the Work.
  5. Supplemental costs including the following:
    - a. The proportion of necessary transportation, travel, and subsistence expenses of Contractor's employees incurred in discharge of duties connected with the Work.

- b. Cost, including transportation and maintenance, of all materials, supplies, equipment, machinery, appliances, office, and temporary facilities at the Site, and hand tools not owned by the workers, which are consumed in the performance of the Work, and cost, less market value, of such items used but not consumed which remain the property of Contractor.
- c. Rentals of all construction equipment and machinery, and the parts thereof, whether rented from Contractor or others in accordance with rental agreements approved by Owner with the advice of Engineer, and the costs of transportation, loading, unloading, assembly, dismantling, and removal thereof. All such costs shall be in accordance with the terms of said rental agreements. The rental of any such equipment, machinery, or parts shall cease when the use thereof is no longer necessary for the Work.
- d. Sales, consumer, use, and other similar taxes related to the Work, and for which Contractor is liable, as imposed by Laws and Regulations.
- e. Deposits lost for causes other than negligence of Contractor, any Subcontractor, or anyone directly or indirectly employed by any of them or for whose acts any of them may be liable, and royalty payments and fees for permits and licenses.
- f. Losses and damages (and related expenses) caused by damage to the Work, not compensated by insurance or otherwise, sustained by Contractor in connection with the performance of the Work (except losses and damages within the deductible amounts of property insurance established in accordance with Section 00250), provided such losses and damages have resulted from causes other than the negligence of Contractor, any Subcontractor, or anyone directly or indirectly employed by any of them or for whose acts any of them may be liable. Such losses shall include settlements made with the written consent and approval of Owner. No such losses, damages, and expenses shall be included in the Cost of the Work for the purpose of determining Contractor's fee.
- g. The cost of utilities, fuel, and sanitary facilities at the Site.
- h. Minor expenses such as communication service at the Site, express and courier services, and similar petty cash items in connection with the Work.
- i. The costs of premiums for all bonds and insurance that Contractor is required by the Contract Documents to purchase and maintain.

C. *Costs Excluded:* The term Cost of the Work shall not include any of the following items:

1. Payroll costs and other compensation of Contractor's officers, executives, principals (of partnerships and sole proprietorships), general managers, safety managers, engineers, architects, estimators, attorneys, auditors, accountants, purchasing and contracting agents, expeditors, timekeepers, clerks, and other personnel employed by Contractor, whether at the Site or in Contractor's principal or branch office for general administration of the Work and not specifically included in the agreed upon schedule of job classifications referred to in Paragraph 12.01.B.1 or specifically covered by Paragraph 12.01.B.4. The payroll costs and other compensation excluded here are to be considered administrative costs covered by the Contractor's fee.
2. Expenses of Contractor's principal and branch offices other than Contractor's office at the Site.
3. Any part of Contractor's capital expenses, including interest on Contractor's capital employed for the Work and charges against Contractor for delinquent payments.
4. Costs due to the negligence of Contractor, any Subcontractor, or anyone directly or indirectly employed by any of them or for whose acts any of them may be liable, including but not limited to, the correction of defective Work, disposal of materials or equipment wrongly supplied, and making good any damage to property.

5. Other overhead or general expense costs of any kind and the costs of any item not specifically and expressly included in Paragraph 12.01.B.
- D. *Contractor's Fee*: When the Work as a whole is performed on the basis of cost-plus, Contractor's fee shall be determined as set forth in the Agreement. When the value of any Work covered by a Change Order, Change Proposal, Claim, set-off, or other adjustment in Contract Price is determined on the basis of Cost of the Work, Contractor's fee shall be determined as set forth in Paragraph 10.04.C.
- E. *Documentation*: Whenever the Cost of the Work for any purpose is to be determined pursuant to this Article 12, Contractor will establish and maintain records thereof in accordance with generally accepted accounting practices and submit in a form acceptable to Engineer an itemized cost breakdown together with supporting data.

#### 12.02 Allowances

- A. It is understood that Contractor has included in the Contract Price all allowances so named in the Contract Documents and shall cause the Work so covered to be performed for such sums and by such persons or entities as may be acceptable to Owner and Engineer.
- B. *Cash Allowances*: Contractor agrees that:
  1. the cash allowances include the cost to Contractor (less any applicable trade discounts) of materials and equipment required by the allowances to be delivered at the Site, and all applicable taxes; and
  2. Contractor's costs for unloading and handling on the Site, labor, installation, overhead, profit, and other expenses contemplated for the cash allowances have been included in the Contract Price and not in the allowances, and no demand for additional payment on account of any of the foregoing will be valid.
- C. *Contingency Allowance*: Contractor agrees that a contingency allowance, if any, is for the sole use of Owner to cover unanticipated costs.
- D. Prior to final payment, an appropriate Change Order will be issued as recommended by Engineer to reflect actual amounts due Contractor on account of Work covered by allowances, and the Contract Price shall be correspondingly adjusted.

#### 12.03 Unit Price Work

- A. Where the Contract Documents provide that all or part of the Work is to be Unit Price Work, initially the Contract Price will be deemed to include for all Unit Price Work an amount equal to the sum of the unit price for each separately identified item of Unit Price Work times the estimated quantity of each item as indicated in the Agreement.
- B. The estimated quantities of items of Unit Price Work are not guaranteed and are solely for the purpose of comparison of Bids and determining an initial Contract Price. Payments to Contractor for Unit Price Work will be based on actual quantities.
- C. Each unit price will be deemed to include an amount considered by Contractor to be adequate to cover Contractor's overhead and profit for each separately identified item.
- D. Engineer will determine the actual quantities and classifications of Unit Price Work performed by Contractor. Engineer will review with Contractor the Engineer's preliminary determinations on such matters before rendering a written decision thereon (by recommendation of an Application for Payment or otherwise). Engineer's written decision thereon will be final and binding (except as modified by Engineer to reflect changed factual conditions or more accurate data) upon Owner and Contractor, subject to the provisions of the following paragraph.
- E. Within 30 days of Engineer's written decision under the preceding paragraph, Contractor may submit

a Change Proposal, or Owner may file a Claim, seeking an adjustment in the Contract Price if:

1. the quantity of any item of Unit Price Work performed by Contractor differs materially and significantly from the estimated quantity of such item indicated in the Agreement;
2. there is no corresponding adjustment with respect to any other item of Work; and
3. Contractor believes that it is entitled to an increase in Contract Price as a result of having incurred additional expense or Owner believes that Owner is entitled to a decrease in Contract Price, and the parties are unable to agree as to the amount of any such increase or decrease.

## **ARTICLE 13: TESTS AND INSPECTIONS; CORRECTION, REMOVAL OR ACCEPTANCE OF DEFECTIVE WORK**

### *13.01 Access to Work*

- A. Owner, Engineer, their consultants and other representatives and personnel of Owner, independent testing laboratories, and authorities having jurisdiction will have access to the Site and the Work at reasonable times for their observation, inspection, and testing. Contractor shall provide them proper and safe conditions for such access and advise them of Contractor's safety procedures and programs so that they may comply therewith as applicable.

### *13.02 Tests, Inspections, and Approvals*

- A. Contractor shall give Engineer timely notice of readiness of the Work (or specific parts thereof) for all required inspections and tests and shall cooperate with inspection and testing personnel to facilitate required inspections and tests.
- B. Owner shall retain and Contractor shall pay for the services of an independent inspector, testing laboratory, or other qualified individual or entity to perform all inspections and tests expressly required by the Contract Documents to be furnished by Owner, except that costs incurred in connection with tests or inspections of covered Work shall be governed by the provisions of Paragraph 13.05.
- C. If Laws or Regulations of any public body having jurisdiction require any Work (or part thereof) specifically to be inspected, tested, or approved by an employee or other representative of such public body, Contractor shall assume full responsibility for arranging and obtaining such inspections, tests, or approvals, pay all costs in connection therewith, and furnish Engineer the required certificates of inspection or approval.
- D. Contractor shall be responsible for arranging, obtaining, and paying for all inspections and tests required:
  1. by the Contract Documents, unless the Contract Documents expressly allocate responsibility for a specific inspection or test to Owner;
  2. to attain Owner's and Engineer's acceptance of materials or equipment to be incorporated in the Work;
  3. by manufacturers of equipment furnished under the Contract Documents;
  4. for testing, adjusting, and balancing of mechanical, electrical, and other equipment to be incorporated into the Work; and
  5. for acceptance of materials, mix designs, or equipment submitted for approval prior to Contractor's purchase thereof for incorporation in the Work.

Such inspections and tests shall be performed by independent inspectors, testing laboratories, or other qualified individuals or entities acceptable to Owner and Engineer.

- E. If the Contract Documents require the Work (or part thereof) to be approved by Owner, Engineer, or another designated individual or entity, then Contractor shall assume full responsibility for arranging

and obtaining such approvals.

- F. If any Work (or the work of others) that is to be inspected, tested, or approved is covered by Contractor without written concurrence of Engineer, Contractor shall, if requested by Engineer, uncover such Work for observation. Such uncovering shall be at Contractor's expense unless Contractor had given Engineer timely notice of Contractor's intention to cover the same and Engineer had not acted with reasonable promptness in response to such notice.

#### 13.03 *Defective Work*

- A. *Contractor's Obligation:* It is Contractor's obligation to assure that the Work is not defective.
- B. *Engineer's Authority:* Engineer has the authority to determine whether Work is defective, and to reject defective Work.
- C. *Notice of Defects:* Prompt notice of all defective Work of which Owner or Engineer has actual knowledge will be given to Contractor.
- D. *Correction, or Removal and Replacement:* Promptly after receipt of written notice of defective Work, Contractor shall correct all such defective Work, whether or not fabricated, installed, or completed, or, if Engineer has rejected the defective Work, remove it from the Project and replace it with Work that is not defective.
- E. *Preservation of Warranties:* When correcting defective Work, Contractor shall take no action that would void or otherwise impair Owner's special warranty and guarantee, if any, on said Work.
- F. *Costs and Damages:* In addition to its correction, removal, and replacement obligations with respect to defective Work, Contractor shall pay all claims, costs, losses, and damages arising out of or relating to defective Work, including but not limited to the cost of the inspection, testing, correction, removal, replacement, or reconstruction of such defective Work, fines levied against Owner by governmental authorities because the Work is defective, and the costs of repair or replacement of work of others resulting from defective Work. Prior to final payment, if Owner and Contractor are unable to agree as to the measure of such claims, costs, losses, and damages resulting from defective Work, then Owner may impose a reasonable set-off against payments due under Article 14.

#### 13.04 *Acceptance of Defective Work*

- A. If, instead of requiring correction or removal and replacement of defective Work, Owner prefers to accept it, Owner may do so (subject, if such acceptance occurs prior to final payment, to Engineer's confirmation that such acceptance is in general accord with the design intent and applicable engineering principles and will not endanger public safety). Contractor shall pay all claims, costs, losses, and damages attributable to Owner's evaluation of and determination to accept such defective Work (such costs to be approved by Engineer as to reasonableness), and for the diminished value of the Work to the extent not otherwise paid by Contractor. If any such acceptance occurs prior to final payment, the necessary revisions in the Contract Documents with respect to the Work shall be incorporated in a Change Order. If the parties are unable to agree as to the decrease in the Contract Price, reflecting the diminished value of Work so accepted, then Owner may impose a reasonable set-off against payments due under Article 14. If the acceptance of defective Work occurs after final payment, Contractor shall pay an appropriate amount to Owner.

#### 13.05 *Uncovering Work*

- A. Engineer has the authority to require special inspection or testing of the Work, whether or not the Work is fabricated, installed, or completed.
- B. If any Work is covered contrary to the written request of Engineer, then Contractor shall, if requested by Engineer, uncover such Work for Engineer's observation, and then replace the covering, all at Contractor's expense.

- C. If Engineer considers it necessary or advisable that covered Work be observed by Engineer or inspected or tested by others, then Contractor, at Engineer's request, shall uncover, expose, or otherwise make available for observation, inspection, or testing as Engineer may require, that portion of the Work in question, and provide all necessary labor, material, and equipment.
1. If it is found that the uncovered Work is defective, Contractor shall be responsible for all claims, costs, losses, and damages arising out of or relating to such uncovering, exposure, observation, inspection, and testing, and of satisfactory replacement or reconstruction (including but not limited to all costs of repair or replacement of work of others); and pending Contractor's full discharge of this responsibility the Owner shall be entitled to impose a reasonable set-off against payments due under Article 14.
  2. If the uncovered Work is not found to be defective, Contractor shall be allowed an increase in the Contract Price or an extension of the Contract Times, or both, directly attributable to such uncovering, exposure, observation, inspection, testing, replacement, and reconstruction. If the parties are unable to agree as to the amount or extent thereof, then Contractor may submit a Change Proposal within 30 days of the determination that the Work is not defective.

#### **13.06 Owner May Stop the Work**

- A. If the Work is defective, or Contractor fails to supply sufficient skilled workers or suitable materials or equipment, or fails to perform the Work in such a way that the completed Work will conform to the Contract Documents, then Owner may order Contractor to stop the Work, or any portion thereof, until the cause for such order has been eliminated; however, this right of Owner to stop the Work shall not give rise to any duty on the part of Owner to exercise this right for the benefit of Contractor, any Subcontractor, any Supplier, any other individual or entity, or any surety for, or employee or agent of any of them.

#### **13.07 Owner May Correct Defective Work**

- A. If Contractor fails within a reasonable time after written notice from Engineer to correct defective Work, or to remove and replace rejected Work as required by Engineer, or if Contractor fails to perform the Work in accordance with the Contract Documents, or if Contractor fails to comply with any other provision of the Contract Documents, then Owner may, after seven days written notice to Contractor, correct or remedy any such deficiency.
- B. In exercising the rights and remedies under this Paragraph 13.07, Owner shall proceed expeditiously. In connection with such corrective or remedial action, Owner may exclude Contractor from all or part of the Site, take possession of all or part of the Work and suspend Contractor's services related thereto, and incorporate in the Work all materials and equipment stored at the Site or for which Owner has paid Contractor but which are stored elsewhere. Contractor shall allow Owner, Owner's representatives, agents and employees, Owner's other contractors, and Engineer and Engineer's consultants access to the Site to enable Owner to exercise the rights and remedies under this paragraph.
- C. All claims, costs, losses, and damages incurred or sustained by Owner in exercising the rights and remedies under this Paragraph 13.07 will be charged against Contractor as set-offs against payments due under Article 14. Such claims, costs, losses and damages will include but not be limited to all costs of repair, or replacement of work of others destroyed or damaged by correction, removal, or replacement of Contractor's defective Work.
- D. Contractor shall not be allowed an extension of the Contract Times because of any delay in the performance of the Work attributable to the exercise by Owner of Owner's rights and remedies under this Paragraph 13.07.

### **ARTICLE 14: PAYMENTS TO CONTRACTOR; SET-OFFS; COMPLETION; CORRECTION PERIOD**

#### 14.01 Progress Payments

- A. *Basis for Progress Payments:* The Schedule of Values established as provided in Article 2 will serve as the basis for progress payments and will be incorporated into a form of Application for Payment acceptable to Engineer. Progress payments on account of Unit Price Work will be based on the number of units completed during the pay period, as determined under the provisions of Paragraph 12.03. Progress payments for cost-based Work will be based on Cost of the Work completed by Contractor during the pay period.
- B. Applications for Payments:
1. At least 20 days before the date established in the Agreement for each progress payment (but not more often than once a month), Contractor shall submit to Engineer for review an Application for Payment filled out and signed by Contractor covering the Work completed as of the date of the Application and accompanied by such supporting documentation as is required by the Contract Documents. If payment is requested on the basis of materials and equipment not incorporated in the Work but delivered and suitably stored at the Site or at another location agreed to in writing, the Application for Payment shall also be accompanied by a bill of sale, invoice, or other documentation warranting that Owner has received the materials and equipment free and clear of all Liens, and evidence that the materials and equipment are covered by appropriate property insurance, a warehouse bond, or other arrangements to protect Owner's interest therein, all of which must be satisfactory to Owner. If the payment and performance of the Work is not secured by a payment and performance bond, all applications for payment shall include a written statement that indicates how the payment will be distributed. Contractor shall disburse the payment as provided in that written statement.
  2. Beginning with the second Application for Payment, each Application shall include an affidavit of Contractor stating that all previous progress payments received on account of the Work have been applied on account to discharge Contractor's legitimate obligations associated with prior Applications for Payment.
  3. The amount of retainage with respect to progress payments will be as stipulated in the Agreement.
  4. *If Requested by Owner:*
    - a. Contractor shall deliver a certified list of all Subcontractors, laborers, and material suppliers to Owner within 30 days of receiving the request. This list shall be updated by Contractor thereafter each month with a certified statement by Contractor that the list and its updates include the names and address of all of Subcontractors, laborers, and Suppliers furnishing labor and/or material for the Project.
    - b. Contractor shall provide a written statement with each pay request to the Owner which indicates how each payment will be distributed. This pay request breakdown shall define the disbursement of all the funds requested.
    - c. When Contractor receives any payment pursuant to this Contract, Contractor shall pay laborers and each Subcontractor and Supplier the amounts stated in Contractor's written statement delivered to Owner for that pay request.
    - d. Contractor shall provide a written statement with all but the first payment request from each of the Subcontractors, laborers, and Suppliers identified in Paragraph 14.01.B.4.b., that they have in fact received payment as provided in Paragraph 14.01.B.4.c. In the event a payment will not be made as stated on a prior written statement delivered pursuant to Paragraph 14.01.B.4.b., Contractor shall furnish an explanation as to the reasons for such deviation and shall request approval from the Engineer.
- C. Review of Applications:

1. Engineer will, within 10 days after receipt of each Application for Payment, including each resubmittal, either indicate in writing a recommendation of payment and present the Application to Owner, or return the Application to Contractor indicating in writing Engineer's reasons for refusing to recommend payment. In the latter case, Contractor may make the necessary corrections and resubmit the Application.
2. Engineer's recommendation of any payment requested in an Application for Payment will constitute a representation by Engineer to Owner, based on Engineer's observations of the executed Work as an experienced and qualified design professional, and on Engineer's review of the Application for Payment and the accompanying data and schedules, that to the best of Engineer's knowledge, information and belief:
  - a. the Work has progressed to the point indicated;
  - b. the quality of the Work is generally in accordance with the Contract Documents (subject to an evaluation of the Work as a functioning whole prior to or upon Substantial Completion, the results of any subsequent tests called for in the Contract Documents, a final determination of quantities and classifications for Unit Price Work under Paragraph 12.03, and any other qualifications stated in the recommendation); and
  - c. the conditions precedent to Contractor's being entitled to such payment appear to have been fulfilled in so far as it is Engineer's responsibility to observe the Work.
3. By recommending any such payment Engineer will not thereby be deemed to have represented that:
  - a. inspections made to check the quality or the quantity of the Work as it has been performed have been exhaustive, extended to every aspect of the Work in progress, or involved detailed inspections of the Work beyond the responsibilities specifically assigned to Engineer in the Contract; or
  - b. there may not be other matters or issues between the parties that might entitle Contractor to be paid additionally by Owner or entitle Owner to withhold payment to Contractor.
4. Neither Engineer's review of Contractor's Work for the purposes of recommending payments nor Engineer's recommendation of any payment, including final payment, will impose responsibility on Engineer:
  - a. to supervise, direct, or control the Work, or
  - b. for the means, methods, techniques, sequences, or procedures of construction, or the safety precautions and programs incident thereto, or
  - c. for Contractor's failure to comply with Laws and Regulations applicable to Contractor's performance of the Work, or
  - d. to make any examination to ascertain how or for what purposes Contractor has used the money paid on account of the Contract Price, or
  - e. to determine that title to any of the Work, materials, or equipment has passed to Owner free and clear of any Liens.
5. Engineer may refuse to recommend the whole or any part of any payment if, in Engineer's opinion, it would be incorrect to make the representations to Owner stated in Paragraph 14.01.C.2.
6. Engineer will recommend reductions in payment (set-offs) necessary in Engineer's opinion to protect Owner from loss because:
  - a. the Work is defective, requiring correction or replacement;
  - b. the Contract Price has been reduced by Change Orders;



- c. Owner has been required to correct defective Work in accordance with Paragraph 13.07, or has accepted defective Work pursuant to Paragraph 13.04;
- d. Owner has been required to remove or remediate a Hazardous Environmental Condition for which Contractor is responsible; or
- e. Engineer has actual knowledge of the occurrence of any of the events that would constitute a default by Contractor and therefore justify termination for cause under the Contract Documents.

D. Payment Becomes Due:

- 1. Ten days after presentation of the Application for Payment to Owner with Engineer's recommendation, the amount recommended (subject to any Owner set-offs) will become due, and when due will be paid by Owner to Contractor.

E. Reductions in Payment by Owner:

- 1. In addition to any reductions in payment (set-offs) recommended by Engineer, Owner is entitled to impose a set-off against payment based on any of the following:
  - a. claims have been made against Owner on account of Contractor's conduct in the performance or furnishing of the Work, or Owner has incurred costs, losses, or damages on account of Contractor's conduct in the performance or furnishing of the Work, including but not limited to claims, costs, losses, or damages from workplace injuries, adjacent property damage, non-compliance with Laws and Regulations, and patent infringement;
  - b. Contractor has failed to take reasonable and customary measures to avoid damage, delay, disruption, and interference with other work at or adjacent to the Site;
  - c. Contractor has failed to provide and maintain required bonds or insurance;
  - d. Owner has been required to remove or remediate a Hazardous Environmental Condition for which Contractor is responsible;
  - e. Owner has incurred extra charges or engineering costs related to submittal reviews, evaluations of proposed substitutes, tests and inspections, or return visits to manufacturing or assembly facilities;
  - f. the Work is defective, requiring correction or replacement;
  - g. Owner has been required to correct defective Work in accordance with Paragraph 13.07, or has accepted defective Work pursuant to Paragraph 13.04;
  - h. the Contract Price has been reduced by Change Orders;
  - i. an event that would constitute a default by Contractor and therefore justify a termination for cause has occurred;
  - j. liquidated damages have accrued as a result of Contractor's failure to achieve Milestones, Substantial Completion, or final completion of the Work.
  - k. Liens have been filed in connection with the Work, except where Contractor has delivered a specific bond satisfactory to Owner to secure the satisfaction and discharge of such Liens;
  - l. there are other items entitling Owner to a set off against the amount recommended.
- 2. If Owner imposes any set-off against payment, whether based on its own knowledge or on the written recommendations of Engineer, Owner will give Contractor immediate written notice (with a copy to Engineer) stating the reasons for such action and the specific amount of the reduction, and promptly pay Contractor any amount remaining after deduction of the amount so withheld. Owner shall promptly pay Contractor the amount so withheld, or any adjustment thereto agreed to

by Owner and Contractor, if Contractor remedies the reasons for such action. The reduction imposed shall be binding on Contractor unless it duly submits a Change Proposal contesting the reduction.

3. Upon a subsequent determination that Owner's refusal of payment was not justified, the amount wrongfully withheld shall be treated as an amount due as determined by Paragraph 14.01.C.1 and subject to interest as provided in the Agreement.

#### 14.02 *Contractor's Warranty of Title*

- A. Contractor warrants and guarantees that title to all Work, materials, and equipment furnished under the Contract will pass to Owner free and clear of (1) all Liens and other title defects, and (2) all patent, licensing, copyright, or royalty obligations, no later than seven days after the time of payment by Owner.

#### 14.03 *Substantial Completion*

- A. When Contractor considers the entire Work ready for its intended use Contractor shall notify Owner and Engineer in writing that the entire Work is substantially complete and request that Engineer issue a certificate of Substantial Completion. Contractor shall at the same time submit to Owner and Engineer an initial draft of punch list items to be completed or corrected before final payment.
- B. Promptly after Contractor's notification, Owner, Contractor, and Engineer shall make an inspection of the Work to determine the status of completion. If Engineer does not consider the Work substantially complete, Engineer will notify Contractor in writing giving the reasons therefor.
- C. If Engineer considers the Work substantially complete, Engineer will deliver to Owner a preliminary certificate of Substantial Completion which shall fix the date of Substantial Completion. Engineer shall attach to the certificate a punch list of items to be completed or corrected before final payment. Owner shall have seven days after receipt of the preliminary certificate during which to make written objection to Engineer as to any provisions of the certificate or attached punch list. If, after considering the objections to the provisions of the preliminary certificate, Engineer concludes that the Work is not substantially complete, Engineer will, within 14 days after submission of the preliminary certificate to Owner, notify Contractor in writing that the Work is not substantially complete, stating the reasons therefor. If Owner does not object to the provisions of the certificate, or if despite consideration of Owner's objections Engineer concludes that the Work is substantially complete, then Engineer will, within said 14 days, execute and deliver to Owner and Contractor a final certificate of Substantial Completion (with a revised punch list of items to be completed or corrected) reflecting such changes from the preliminary certificate as Engineer believes justified after consideration of any objections from Owner.
- D. At the time of receipt of the preliminary certificate of Substantial Completion, Owner and Contractor will confer regarding Owner's use or occupancy of the Work following Substantial Completion, review the builder's risk insurance policy with respect to the end of the builder's risk coverage, and confirm the transition to coverage of the Work under a permanent property insurance policy held by Owner. Unless Owner and Contractor agree otherwise in writing, Owner shall bear responsibility for security, operation, protection of the Work, property insurance, maintenance, heat, and utilities upon Owner's use or occupancy of the Work.
- E. After Substantial Completion the Contractor shall promptly begin work on the punch list of items to be completed or corrected prior to final payment. In appropriate cases Contractor may submit monthly Applications for Payment for completed punch list items, following the progress payment procedures set forth above.
- F. Owner shall have the right to exclude Contractor from the Site after the date of Substantial Completion subject to allowing Contractor reasonable access to remove its property and complete or correct items on the punch list.

#### 14.04 *Partial Use or Occupancy*

- A. Prior to Substantial Completion of all the Work, Owner may use or occupy any substantially completed part of the Work which has specifically been identified in the Contract Documents, or which Owner, Engineer, and Contractor agree constitutes a separately functioning and usable part of the Work that can be used by Owner for its intended purpose without significant interference with Contractor's performance of the remainder of the Work, subject to the following conditions:
1. At any time Owner may request in writing that Contractor permit Owner to use or occupy any such part of the Work that Owner believes to be substantially complete. If and when Contractor agrees that such part of the Work is substantially complete, Contractor, Owner, and Engineer will follow the procedures of Paragraph 15.03.A through E for that part of the Work.
  2. At any time Contractor may notify Owner and Engineer in writing that Contractor considers any such part of the Work substantially complete and request Engineer to issue a certificate of Substantial Completion for that part of the Work.
  3. Within a reasonable time after either such request, Owner, Contractor, and Engineer shall make an inspection of that part of the Work to determine its status of completion. If Engineer does not consider that part of the Work to be substantially complete, Engineer will notify Owner and Contractor in writing giving the reasons therefor. If Engineer considers that part of the Work to be substantially complete, the provisions of Paragraph 14.03 will apply with respect to certification of Substantial Completion of that part of the Work and the division of responsibility in respect thereof and access thereto.
  4. No use or occupancy or separate operation of part of the Work may occur prior to compliance with the requirements of Section 00250 regarding builder's risk or other property insurance.

#### 14.05 *Final Inspection*

- A. Upon written notice from Contractor that the entire Work or an agreed portion thereof is complete, Engineer will promptly make a final inspection with Owner and Contractor and will notify Contractor in writing of all particulars in which this inspection reveals that the Work, or agreed portion thereof, is incomplete or defective. Contractor shall immediately take such measures as are necessary to complete such Work or remedy such deficiencies.

#### 14.06 *Final Payment*

- A. Application for Payment:
1. After Contractor has, in the opinion of Engineer, satisfactorily completed all corrections identified during the final inspection and has delivered, in accordance with the Contract Documents, all maintenance and operating instructions, schedules, guarantees, bonds, certificates or other evidence of insurance, certificates of inspection, annotated record documents (as provided in Paragraph 6.11), and other documents, Contractor may make application for final payment.
  2. The final Application for Payment shall be accompanied (except as previously delivered) by:
    - a. all documentation called for in the Contract Documents;
    - b. consent of the surety, if any, to final payment;
    - c. satisfactory evidence that all title issues have been resolved such that title to all Work, materials, and equipment has passed to Owner free and clear of any Liens or other title defects or will so pass upon final payment.
    - d. a list of all disputes that Contractor believes are unsettled; and
    - e. complete and legally effective releases or waivers (satisfactory to Owner) of all Lien rights arising out of the Work, and of Liens filed in connection with the Work.

3. In lieu of the releases or waivers of Liens specified in Paragraph 14.06.A.2 and as approved by Owner, Contractor may furnish receipts or releases in full and an affidavit of Contractor that: (a) the releases and receipts include all labor, services, material, and equipment for which a Lien could be filed; and (b) all payrolls, material and equipment bills, and other indebtedness connected with the Work for which Owner might in any way be responsible, or which might in any way result in liens or other burdens on Owner's property, have been paid or otherwise satisfied. If any Subcontractor or Supplier fails to furnish such a release or receipt in full, Contractor may furnish a bond or other collateral satisfactory to Owner to indemnify Owner against any Lien, or Owner at its option may issue joint checks payable to Contractor and specified Subcontractors and Suppliers.

B. Engineer's Review of Application and Acceptance:

1. If, on the basis of Engineer's observation of the Work during construction and final inspection, and Engineer's review of the final Application for Payment and accompanying documentation as required by the Contract Documents, Engineer is satisfied that the Work has been completed and Contractor's other obligations under the Contract have been fulfilled, Engineer will, within ten days after receipt of the final Application for Payment, indicate in writing Engineer's recommendation of final payment and present the Application for Payment to Owner for payment. Such recommendation shall account for any set-offs against payment that are necessary in Engineer's opinion to protect Owner from loss for the reasons stated above with respect to progress payments. At the same time Engineer will also give written notice to Owner and Contractor that the Work is acceptable, subject to the provisions of Paragraph 14.07. Otherwise, Engineer will return the Application for Payment to Contractor, indicating in writing the reasons for refusing to recommend final payment, in which case Contractor shall make the necessary corrections and resubmit the Application for Payment.

C. *Completion of Work*: The Work is complete (subject to surviving obligations) when it is ready for final payment as established by the Engineer's written recommendation of final payment.

D. *Payment Becomes Due*: Thirty days after the presentation to Owner of the final Application for Payment and accompanying documentation, the amount recommended by Engineer (less any further sum Owner is entitled to set off against Engineer's recommendation, including but not limited to set-offs for liquidated damages and set-offs allowed under the provisions above with respect to progress payments) will become due and shall be paid by Owner to Contractor.

14.07 *Waiver of Claims*

- A. The making of final payment will not constitute a waiver by Owner of claims or rights against Contractor. Owner expressly reserves claims and rights arising from unsettled Liens, from defective Work appearing after final inspection pursuant to Paragraph 14.05, from Contractor's failure to comply with the Contract Documents or the terms of any special guarantees specified therein, from outstanding Claims by Owner, or from Contractor's continuing obligations under the Contract Documents.
- B. The acceptance of final payment by Contractor will constitute a waiver by Contractor of all claims and rights against Owner other than those pending matters that have been duly submitted or appealed under the provisions of Article 16.

14.08 *Correction Period*

- A. If within one year after the date of Substantial Completion (or such longer period of time as may be prescribed by the terms of any applicable special guarantee required by the Contract Documents, or by any specific provision of the Contract Documents), any Work is found to be defective, or if the repair of any damages to the Site, adjacent areas that Contractor has arranged to use through construction easements or otherwise, and other adjacent areas used by Contractor as permitted by Laws and

Regulations, is found to be defective, then Contractor shall promptly, without cost to Owner and in accordance with Owner's written instructions:

1. correct the defective repairs to the Site or such other adjacent areas;
  2. correct such defective Work;
  3. if the defective Work has been rejected by Owner, remove it from the Project and replace it with Work that is not defective, and
  4. satisfactorily correct or repair or remove and replace any damage to other Work, to the work of others, or to other land or areas resulting therefrom.
- B. If Contractor does not promptly comply with the terms of Owner's written instructions, or in an emergency where delay would cause serious risk of loss or damage, Owner may have the defective Work corrected or repaired or may have the rejected Work removed and replaced. Contractor shall pay all claims, costs, losses, and damages (including but not limited to all fees and charges of engineers, architects, attorneys, and other professionals and all court or arbitration or other dispute resolution costs) arising out of or relating to such correction or repair or such removal and replacement (including but not limited to all costs of repair or replacement of work of others).
- C. In special circumstances where a particular item of equipment is placed in continuous service before Substantial Completion of all the Work, the correction period for that item may start to run from an earlier date if so provided in the Specifications.
- D. Where defective Work (and damage to other Work resulting therefrom) has been corrected or removed and replaced under this paragraph, the correction period hereunder with respect to such Work will be extended for an additional period of one year after such correction or removal and replacement has been satisfactorily completed.
- E. Contractor's obligations under this paragraph are in addition to all other obligations and warranties. The provisions of this paragraph shall not be construed as a substitute for, or a waiver of, the provisions of any applicable statute of limitation or repose.

#### *14.09 Local Government Prompt Payment Act*

- A. If the total cost of the construction services purchased by Owner pursuant to this Contract exceeds \$200,000, the provisions of this Article are subject to the provisions of the Local Government Prompt Payment Act, Sections 218.70 through 218.79, inclusive, Florida Statutes, except to the extent provided therein and in that event provisions of this Article are modified and amended to the extent required to be consistent with the Local Government Prompt Payment Act.

#### *14.10 Interest*

- A. All moneys not paid when due as provided in Paragraph 14 shall bear interest at the maximum rate of six (6) percent per annum, simple.

### **ARTICLE 15: SUSPENSION OF WORK AND TERMINATION**

#### *15.01 Owner May Suspend Work*

- A. At any time and without cause, Owner may suspend the Work or any portion thereof for a period of not more than 90 consecutive days by written notice to Contractor and Engineer. Such notice will fix the date on which Work will be resumed. Contractor shall resume the Work on the date so fixed. Contractor shall be entitled to an adjustment in the Contract Price or an extension of the Contract Times, or both, directly attributable to any such suspension. Any Change Proposal seeking such adjustments shall be submitted no later than 30 days after the date fixed for resumption of Work.

## 15.02 Owner May Terminate for Cause

- A. The occurrence of any one or more of the following events will constitute a default by Contractor and justify termination for cause:
1. Contractor's persistent failure to perform the Work in accordance with the Contract Documents (including, but not limited to, failure to supply sufficient skilled workers or suitable materials or equipment or failure to adhere to the Progress Schedule);
  2. Failure of Contractor to perform or otherwise to comply with a material term of the Contract Documents;
  3. Contractor's disregard of Laws or Regulations of any public body having jurisdiction;
  4. Contractor's repeated disregard of the authority of Owner or Engineer; or
  5. Contractor becomes involved as a debtor in a bankruptcy proceeding, or becomes involved in a reorganization, dissolution, or liquidation proceeding, or if a trustee or receiver is appointed over all or a substantial portion of the property of Contractor under federal bankruptcy law or any state insolvency law.
- B. If one or more of the events identified in Paragraph 15.02.A occurs, then after giving Contractor (and any surety) ten (10) days written notice that Owner is considering a declaration that Contractor is in default and termination of the Contract, Owner may proceed to:
1. declare Contractor to be in default, give Contractor (and any surety) notice that the Contract is terminated, and enforce the rights available to Owner under any applicable payment and performance bond; or
  2. notify Contractor of the deficiency with a requirement that the deficiency be corrected within a specified time, otherwise the Contract will be terminated at the end of such time; or
  3. take whatever action is deemed appropriate by Owner.
- C. Subject to the terms and operation of any applicable performance bond, if Owner has terminated the Contract for cause, Owner may exclude Contractor from the Site, take possession of the Work, incorporate in the Work all materials and equipment stored at the Site or for which Owner has paid Contractor but which are stored elsewhere, and complete the Work as Owner may deem expedient.
- D. If Owner proceeds as provided in Paragraph 15.02.B, Contractor shall not be entitled to receive any further payment until the Work is completed. If the unpaid balance of the Contract Price exceeds the cost to complete the Work, including all related claims, costs, losses, and damages (including but not limited to all fees and charges of engineers, architects, attorneys, and other professionals) sustained by Owner, such excess will be paid to Contractor. If the cost to complete the Work including such related claims, costs, losses, and damages exceeds such unpaid balance, Contractor shall pay the difference to Owner. Such claims, costs, losses, and damages incurred by Owner will be reviewed by Engineer as to their reasonableness and, when so approved by Engineer, incorporated in a Change Order. When exercising any rights or remedies under this paragraph, Owner shall not be required to obtain the lowest price for the Work performed.
- E. Where Contractor's services have been so terminated by Owner, the termination will not affect any rights or remedies of Owner against Contractor then existing or which may thereafter accrue, or any rights or remedies of Owner against Contractor or any surety under any payment bond or performance bond. Any retention or payment of money due Contractor by Owner will not release Contractor from liability.
- F. If and to the extent that Contractor has provided a performance bond under the provisions of Section 00250, the provisions of that bond shall govern over any inconsistent provisions of Paragraph 15.02.B.

### 15.03 *Owner May Terminate for Convenience*

- A. Upon seven days written notice to Contractor and Engineer, Owner may, without cause and without prejudice to any other right or remedy of Owner, terminate the Contract. In such case, Contractor shall be paid for (without duplication of any items):
  - 1. completed and acceptable Work executed in accordance with the Contract Documents prior to the effective date of termination, including fair and reasonable sums for overhead and profit on such Work;
  - 2. expenses sustained prior to the effective date of termination in performing services and furnishing labor, materials, or equipment as required by the Contract Documents in connection with uncompleted Work, plus fair and reasonable sums for overhead and profit on such expenses; and
  - 3. other reasonable expenses directly attributable to termination, including costs incurred to prepare a termination for convenience cost proposal.
- B. Contractor shall not be paid on account of loss of anticipated overhead, profits, or revenue, or other economic loss arising out of or resulting from such termination.

### 15.04 *Contractor May Stop Work or Terminate*

- A. If, through no act or fault of Contractor, (1) the Work is suspended for more than 90 consecutive days by Owner or under an order of court or other public authority, or (2) Engineer fails to act on any Application for Payment within 30 days after it is submitted, or (3) Owner fails for 30 days to pay Contractor any sum finally determined to be due, then Contractor may, upon seven days written notice to Owner and Engineer, and provided Owner or Engineer do not remedy such suspension or failure within that time, terminate the contract and recover from Owner payment on the same terms as provided in Paragraph 15.03.
- B. In lieu of terminating the Contract and without prejudice to any other right or remedy, if Engineer has failed to act on an Application for Payment within 30 days after it is submitted, or Owner has failed for 30 days to pay Contractor any sum finally determined to be due, Contractor may, seven days after written notice to Owner and Engineer, stop the Work until payment is made of all such amounts due Contractor, including interest thereon. The provisions of this paragraph are not intended to preclude Contractor from submitting a Change Proposal for an adjustment in Contract Price or Contract Times or otherwise for expenses or damage directly attributable to Contractor's stopping the Work as permitted by this paragraph.

## **ARTICLE 16: FINAL RESOLUTION OF DISPUTES**

### 16.01 *Methods and Procedures*

- A. *Disputes Subject to Final Resolution:* The following disputed matters are subject to final resolution under the provisions of this Article:
  - 1. A timely appeal of an approval in part and denial in part of a Claim, or of a denial in full; and
  - 2. Disputes between Owner and Contractor concerning the Work or obligations under the Contract Documents and arising after final payment has been made.
- B. *Final Resolution of Disputes:* For any dispute subject to resolution under this Article, Owner or Contractor may:
  - 1. elect in writing to invoke the dispute resolution process provided for in the Supplementary Conditions; or
  - 2. agree with the other party to submit the dispute to another dispute resolution process; or
  - 3. if no dispute resolution process is provided for in the Supplementary Conditions or mutually agreed

to, give written notice to the other party of the intent to submit the dispute to a court of competent jurisdiction.

## **ARTICLE 17: MISCELLANEOUS**

### *17.01 Giving Notice*

- A. Whenever any provision of the Contract Documents requires the giving of written notice, it will be deemed to have been validly given if:
  - 1. delivered in person, by a commercial courier service or otherwise, to the individual or to a member of the firm or to an officer of the corporation for which it is intended; or
  - 2. delivered at or sent by registered or certified mail, postage prepaid, to the last business address known to the sender of the notice.

### *17.02 Computation of Times*

- A. When any period of time is referred to in the Contract by days, it will be computed to exclude the first and include the last day of such period. If the last day of any such period falls on a Saturday or Sunday or on a day made a legal holiday by the law of the applicable jurisdiction, such day will be omitted from the computation.

### *17.03 Cumulative Remedies*

- A. The duties and obligations imposed by these General Conditions and the rights and remedies available hereunder to the parties hereto are in addition to and are not to be construed in any way as a limitation of, any rights and remedies available to any or all of them which are otherwise imposed or available by Laws or Regulations, by special warranty or guarantee, or by other provisions of the Contract. The provisions of this paragraph will be as effective as if repeated specifically in the Contract Documents in connection with each particular duty, obligation, right, and remedy to which they apply.

### *17.04 Limitation of Damages*

- A. With respect to any and all Change Proposals, Claims, disputes subject to final resolution, and other matters at issue, neither Owner nor Engineer, nor any of their officers, directors, members, partners, employees, agents, consultants, or subcontractors, shall be liable to Contractor for any claims, costs, losses, or damages sustained by Contractor on or in connection with any other project or anticipated project.

### *17.05 No Waiver*

- A. A party's non-enforcement of any provision shall not constitute a waiver of that provision, nor shall it affect the enforceability of that provision or of the remainder of this Contract.

### *17.06 Survival of Obligations*

- A. All representations, indemnifications, warranties, and guarantees made in, required by, or given in accordance with the Contract, as well as all continuing obligations indicated in the Contract, will survive final payment, completion, and acceptance of the Work or termination or completion of the Contract or termination of the services of Contractor.

### *17.07 Controlling Law*

- A. This Contract is to be governed by the law of the state in which the Project is located.

### *17.08 Headings*

- A. Article and paragraph headings are inserted for convenience only and do not constitute parts of these General Conditions.



**DIVISION 0 - SECTION 00800**  
**SUPPLEMENTARY CONDITIONS**  
**ITB 24-005-KSB**

1. SOUTHWEST FLORIDA WATER MANAGEMENT DISTRICT INDEMNIFICATION: (in addition to Highlands County Indemnification)
  - 1.1. To the extent permitted by Florida law, the Cooperator assumes all risks relating to the Project and shall be solely liable for, and shall indemnify and hold the District harmless from all claims, loss, damage and other expenses, including attorneys' fees and costs and attorneys' fees and costs on appeal, arising from the design, construction, operation, maintenance or implementation of the Project; provided, however, that the Cooperator shall not indemnify for that portion of any loss or damages proximately caused by the negligent act or omission of the District's officers, employees, contractors and agents. The acceptance of the District's funding by the Cooperator does not in any way constitute an agency relationship between the District and the Cooperator.
  - 1.2. The Cooperator shall indemnify and hold the District harmless, to the extent allowed under Section 768.28, F.S., from all claims, loss, damage and other expenses, including attorneys' fees and costs and attorneys' fees and costs on appeal, arising from the negligent acts or omissions of the Cooperator's officers, employees, contractors and agents related to its performance under this Agreement.
  - 1.3. This Paragraph, including all subparagraphs, shall not be construed as a waiver of the Cooperator's sovereign immunity or an extension of the Cooperator's liability beyond the limits established in Section 768.28, F.S. Additionally, this Paragraph, including all subparagraphs, will not be construed to impose contractual liability on the Cooperator for underlying tort claims as described above beyond the limits specified in Section 768.28, F.S., nor be construed as consent by the Cooperator to be sued by third parties in any manner arising out of this Agreement.
  - 1.4. Nothing in this Agreement shall be interpreted as a waiver of the District's sovereign immunity or an extension of its liability beyond the limits established in Section 768.28, F.S., nor be construed as consent by the District to be sued by third parties in any manner arising out of this Agreement.
  - 1.5. This Paragraph, including all subparagraphs, shall survive the expiration or termination of this Agreement.

[Remainder of page intentionally left blank.]

**DIVISION 0 - SECTION 00836  
WAIVER OF RIGHT TO CLAIM AGAINST THE PUBLIC CONSTRUCTION BOND (FINAL PAYMENT)  
ITB 24-005-KSB**

The undersigned, in consideration of the final payment in the amount of \$ \_\_\_\_\_, hereby waives its right to claim against the Public Construction Bond for labor, services, or materials furnished to \_\_\_\_\_  
\_\_\_\_\_ on the job of Highlands County, a political subdivision of the State of Florida, for improvements to the following described project: **“JUNE-IN-WINTER BMPs FOR CATFISH CREEK-FLOATING ISLANDS AND BAFFLE BOX CONSTRUCTION, Highlands County Project No. 21062”**

DATED ON \_\_\_\_\_, 20\_\_\_\_.

By: \_\_\_\_\_

IN WITNESS WHEREOF \_\_\_\_\_ have (has) hereunto set hand and seal this \_\_\_\_\_ day of \_\_\_\_\_, 20\_\_\_\_.

WITNESS:

\_\_\_\_\_

(Seal)

Print Name: \_\_\_\_\_

SWORN AND SUBSCRIBED TO BEFORE ME THIS \_\_\_\_\_ day of \_\_\_\_\_, 20\_\_\_\_.

\_\_\_\_\_  
Notary Public  
State of Florida-at-Large

My Commission Expires: \_\_\_\_\_

**WAIVER OF RIGHT TO CLAIM AGAINST THE PAYMENT BOND (PROGRESS PAYMENT)**  
**ITB 24-005-KSB**

The undersigned, in consideration of the sum of \$\_\_\_\_\_, hereby waives its right to claim against the Public Construction Bond for labor, services, or materials furnished through \_\_\_\_\_(insert date) to \_\_\_\_\_ (insert the name of your customer) on the job of (Highlands County, a political subdivision of the State of Florida), for improvements to the following described project: **“JUNE-IN-WINTER BMPs FOR CATFISH CREEK-FLOATING ISLANDS AND BAFFLE BOX CONSTRUCTION, Highlands County Project No. 21062”**. This waiver does not cover any retention, or any labor, services, or materials furnished after the date specified.

DATED ON \_\_\_\_\_, 20 \_\_\_\_.

By: \_\_\_\_\_

IN WITNESS WHEREOF \_\_\_\_\_ have (has) hereunto set hand and seal this \_\_\_\_\_ day of \_\_\_\_\_, 20\_\_\_\_.

WITNESS:

\_\_\_\_\_

(Seal)

Print Name: \_\_\_\_\_

SWORN AND SUBSCRIBED TO BEFORE ME THIS \_\_\_\_ day of \_\_\_\_\_, 20\_\_\_\_.

\_\_\_\_\_  
Notary Public  
State of Florida-at-Large

My Commission Expires: \_\_\_\_\_



Know what's below.  
Call before you dig.

# CONSTRUCTION PLANS

FOR:

## LAKE JUNE-IN-WINTER CATFISH CREEK BEST MANAGEMENT PRACTICES (BMPs)

CLIENT:

## HIGHLANDS COUNTY DIVISION OF NATURAL RESOURCES

IN CONJUNCTION WITH:

## SOUTHWEST FLORIDA WATER MANAGEMENT DISTRICT



**HIGHLANDS COUNTY PROJECT MANAGER**  
DAWN RITTER

**SWFWMD PROJECT MANAGER**  
NANCY NORTON, PE

**HIGHLANDS COUNTY COMMISSIONERS:**  
DISTRICT 1  
KEVIN ROBERTS, VICE CHAIR  
DISTRICT 2  
DON ELWELL  
DISTRICT 3  
SCOTT KIROUAC

DISTRICT 4  
ARLENE TUCK  
DISTRICT 5  
CHRIS CAMPBELL, CHAIR  
COUNTY ADMINISTRATOR  
LAURIE HURNER

**PROJECT CONSULTANTS:**

**ENGINEER / SURVEYOR:**  
AIM ENGINEERING & SURVEYING, INC.  
2161 FOWLER STREET  
FORT MYERS, FLORIDA 33901  
(239) 332-4569

**ENGINEER OF RECORD**  
DANIEL W. SCHROEDER P.E.  
(239) 823-8171

**UTILITY PROVIDERS:**

**DUKE ENERGY**  
5020 KENILWORTH BLVD,  
SEBRING, FL 33870  
**USIC DISPATCH**  
(800) 778-9140

**PLACID LAKES UTILITIES**  
410 WASHINGTON BLVD NW,  
LAKE PLACID, FL 33852  
**COURTNEY CONKLIN**  
(863) 465-0345

**CENTURYLINK**  
311 US HWY 27 N,  
SEBRING, FL 33870  
**CABLE PROTECTION CENTER**  
(877) 366-8344 X3

**COMCAST**  
3010 HERRING AVE,  
SEBRING, FL 33870  
**USIC DISPATCH**  
(800) 778-9140

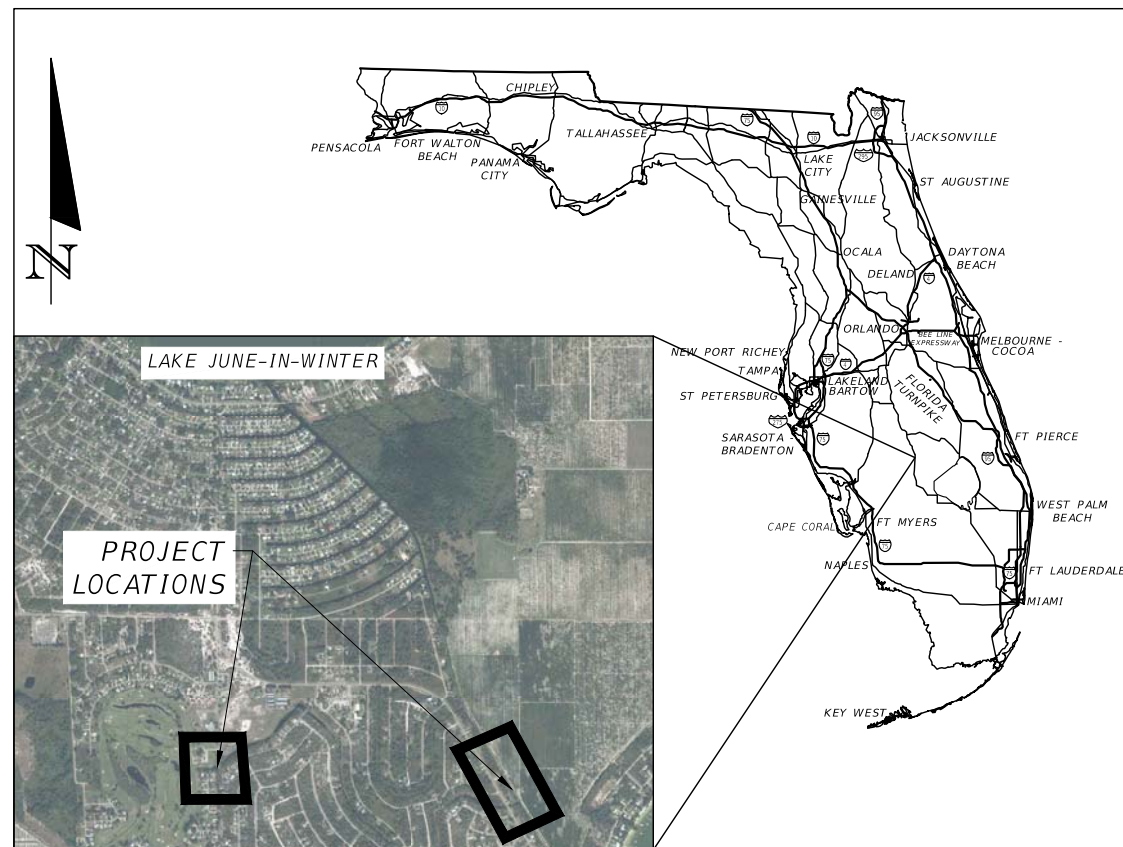

**LOCATION MAP**  
(NOT TO SCALE)

**PROJECT LOCATION INFORMATION:**  
SECTIONS 14 & 15, TOWNSHIP 37S, RANGE 29E  
HIGHLANDS COUNTY  
LAKE PLACID, FLORIDA

PREPARED BY:

**AIM ENGINEERING & SURVEYING, INC.**



2161 FOWLER STREET  
FORT MYERS, FLORIDA 33901  
PHONE (239) 332-4569  
CERTIFICATE OF AUTHORIZATION NO. 3114

INDEX OF PLANS	
NO.	SHEET DESCRIPTION
C-01	COVER SHEET
C-02	AERIAL / KEY MAP
C-03	FILTER BOX PLAN
C-04	FLOATING TREATMENT WETLANDS PLAN
C-05	FILTER BOX DETAILS
C-06	FLOATING TREATMENT WETLANDS TYPICAL DETAIL
C-07	CATFISH CREEK CANAL CROSS SECTIONS (1 OF 2)
C-08	CATFISH CREEK CANAL CROSS SECTIONS (2 OF 2)
C-09	EROSION CONTROL
C-10	CONSTRUCTION NOTES

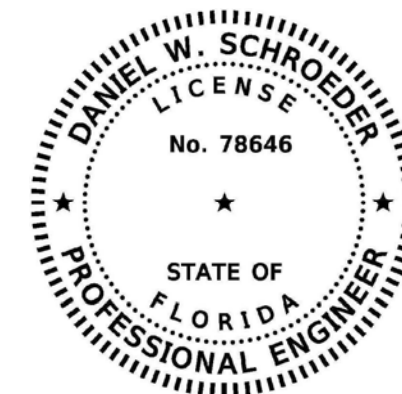

THIS ITEM HAS BEEN DIGITALLY  
SIGNED AND SEALED BY:

ON THE DATE ADJACENT TO THE SEAL

PRINTED COPIES OF THIS DOCUMENT ARE  
NOT CONSIDERED SIGNED AND SEALED  
AND THE SIGNATURE MUST BE VERIFIED  
ON ANY ELECTRONIC COPIES.

AIM ENGINEERING & SURVEYING, INC.  
2161 FOWLER ST., STE. 100  
FORT MYERS, FL. 33901  
CERTIFICATE OF AUTHORIZATION NO.: 3114  
DANIEL W. SCHROEDER, P.E. NO. 78646

NOTE: THE SCALE OF THESE PLANS MAY  
HAVE CHANGED DUE TO REPRODUCTION

ELEVATIONS DEPICTED HEREIN ARE BASED ON THE NORTH  
AMERICAN VERTICAL DATUM OF 1988 (NAVD88).

JUNE 2023

Sheet  
No.

C-01

P:\005\Active\22-1599 Lake June-in-Winter Catfish Creek BMPs\CAD\C01 Cover.dwg Alex Milian

THE OFFICIAL RECORD OF THIS SHEET IS THE ELECTRONIC FILE DIGITALLY SIGNED AND SEALED UNDER RULE 61G15-23.004, F.A.C.

LAKE JUNE-IN-WINTER



**LEGEND**  
 ~~~~~ DIRECTION OF FLOW

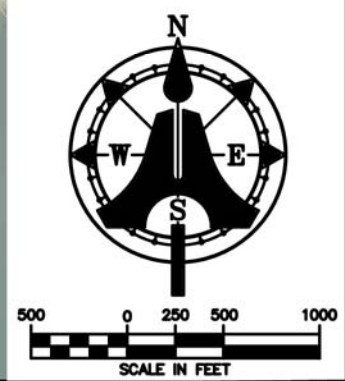

| NO | DATE | DESCRIPTION |
|----|------|-------------|
| 4  |      |             |
| 3  |      |             |
| 2  |      |             |
| 1  |      |             |

**AIM Engineering & Surveying, Inc.**  
 CIVIL ENGINEERING \* LAND SURVEYING \* S.U.E. \* TRANSPORTATION \* UTILITIES  
 \* PROJECT MANAGEMENT \* CONSTRUCTION ENGINEERING & MANAGEMENT  
 2161 FOWLER ST. STE. 100 FORT MYERS, FL 33901 \* PHONE: 239-332-4569  
 EMAIL: ENGINEERING@AIMENGR.COM \* CERTIFICATE OF AUTHORIZATION No. 3114

**HIGHLANDS COUNTY NATURAL RESOURCES DIVISION**  
 4344 GEORGE BLVD., SEBRING, FL. 33875  
 PHONE: (863) 402-6529

DATE: JUN 2023  
 DRAWN BY: AM  
 CHECKED BY: DS  
 DANIEL SCHROEDER  
 PROFESSIONAL ENGINEER  
 P.E. No. 78646

LAKE JUNE-IN-WINTER BMP IMPROVEMENTS  
**AERIAL/KEY MAP**

PROJECT NO. 22-1599  
 SHEET NO. C - 02

P:\JOBS\active\22-1599 Lake June-in-Winter Catfish Creek BMPs\CAD\C-02 AERIAL KEY.dwg

THE OFFICIAL RECORD OF THIS SHEET IS THE ELECTRONIC FILE DIGITALLY SIGNED AND SEALED UNDER RULE 61G15-23.004, F.A.C.

| CONTROL POINTS |                            |              |             |                     |         |          |
|----------------|----------------------------|--------------|-------------|---------------------|---------|----------|
| CONTROL POINT  | TYPE                       | NORTHING     | EASTING     | ELEVATION (NAVD 88) | STATION | OFFSET   |
| 70008          | FIRC 5/8" LB5402           | 1063703.978' | 526397.519' | 98.23'              | 1+06.07 | 210.4' L |
| 70007          | FIRC 5/8" LB5402           | 1063724.066' | 526396.875' | 94.65'              | 1+26.24 | 210.7' L |
| 70013          | FIRC 5/8" LB5402           | 1063724.599' | 526422.076' | 94.66'              | 1+26.28 | 185.5' L |
| 70003          | FIRC 5/8" LB5402           | 1063761.228' | 526555.675' | 100.73'             | 1+60.34 | 51.2' L  |
| 60006          | SIRC 5/8" "CONTROL LB3114" | 1063781.882' | 526592.841' | 99.88'              | 1+80.29 | 13.7' L  |
| 60005          | SIRC 5/8" "CONTROL LB3114" | 1063921.986' | 526618.151' | 100.32'             | 3+19.93 | 14.3' R  |

PLACID LAKES COUNTRY CLUB

GOLF COURSE CANAL

PLACID LAKES DRIVE

PLACID LAKES DRIVE

CANAL

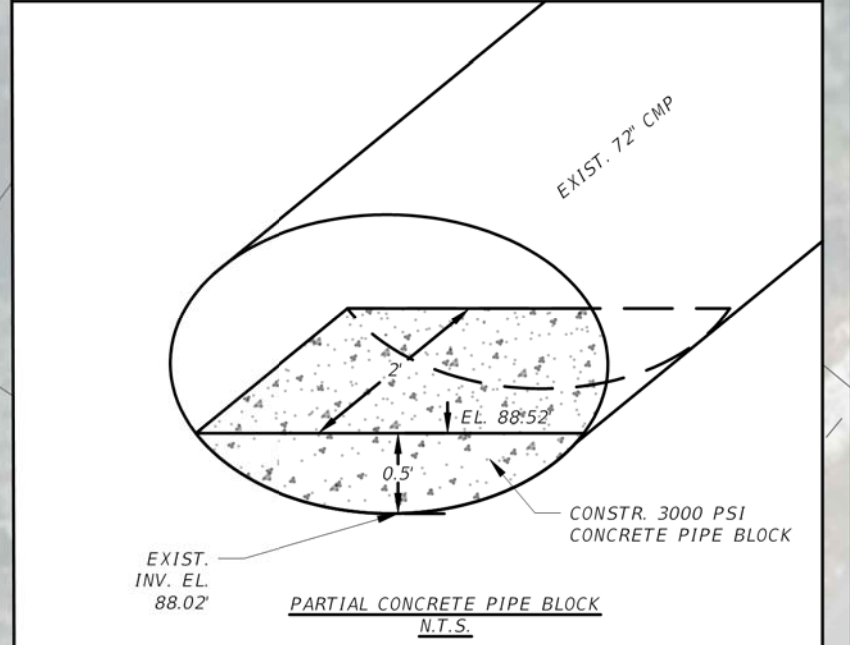
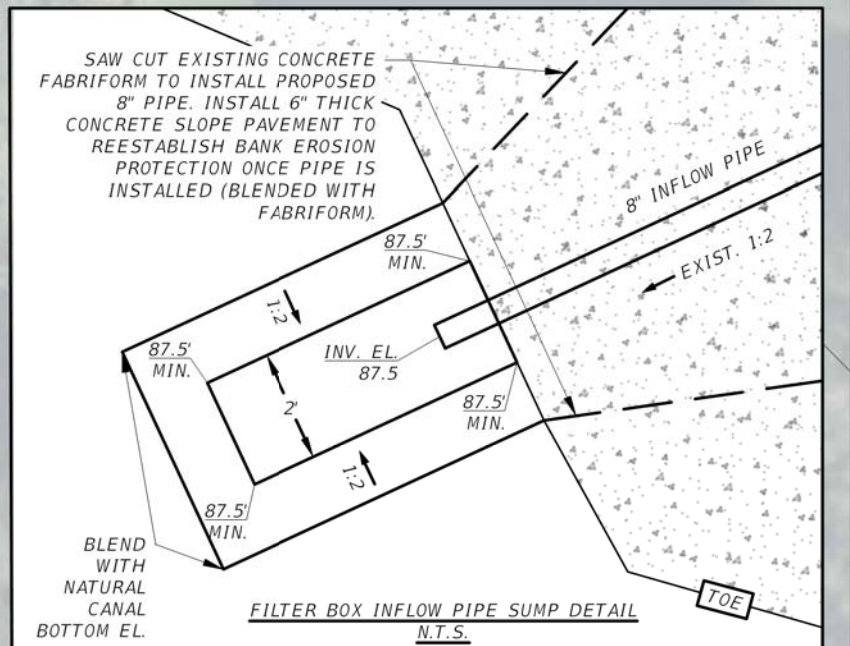

FURNISH & INSTALL 6' X 12' OLDCASTLE NRFS FILTER BOX OR APP. EQ. BOX BOTTOM TO BE SUPPORTED BY 12" GRAVEL BED OR 98% DENSITY COMPACTION. FOR BACKFILL MATERIAL, ACHIEVE 95% DENSITY COMPACTION AT 12" LIFTS AS SPECIFIED BY ASTM D1557 OR AASHTO T180 TESTING STANDARDS. STA 2+29.81 OFFSET 80.9' L SEE SHEET C-05 FOR DETAILS

CONSTRUCT 24 LF OF PVC FILTER BOX INFLOW PIPE INV. EL. 87.5'

CONSTR. 10' WIDE BY 20' LONG X 12" DEEP SUMP AT 1:2 SLOPE TO EL. 87.5' SEE DETAIL ON THIS SHEET

REMOVE & REPLACE SLOPE PAVEMENT

CONSTR. 0.5' HIGH BY 2' LONG PARTIAL CONCRETE PIPE BLOCK TO DIRECT FLOW TO FILTER BOX SEE DETAIL ON THIS SHEET

CONSTR. 8 LF OF 8" PVC FILTER BOX OUTFLOW PIPE INV. EL. 88.3'

EXIST. INV. EL. 88.27'

EXIST. INLET

TIE-IN PROPOSED 8" PVC FILTER BOX OUTFLOW PIPE TO EXISTING CONCRETE INLET AT INV. EL. 88.3'

BEGIN CONSTR. BASELINE NO. 01 STA 1+00 N=1063701.79 E=526608.03

THE CONTRACTOR SHALL CONSTRUCT AN INFORMATIONAL PROJECT SIGN RECOGNIZING SWFWMD AS THE FUNDING ENTITY. THE CONTRACTOR SHALL SUBMIT SIGN DETAILS TO HIGHLANDS COUNTY IN ACCORDANCE WITH LOCAL SIGN ORDINANCES THAT SPECIFY THE SIGN FORM, CONTENT, AND LOCATION. THE COUNTY WILL GAIN WRITTEN APPROVAL FROM SWFWMD BEFORE SIGN APPROVAL AND INSTALLATION AT THE PROJECT SITE.

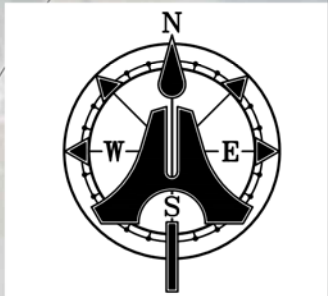
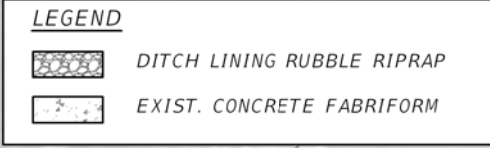

P:\JOBS\active\22-1599 Lake June-in-Winter Catfish Creek BMPs\CAD\C-03 FILTER BOX.dwg

| NO | DATE | DESCRIPTION |
|----|------|-------------|
| 4  |      |             |
| 3  |      |             |
| 2  |      |             |
| 1  |      |             |

**AIM Engineering & Surveying, Inc.**  
 CIVIL ENGINEERING \* LAND SURVEYING \* S.U.E. \* TRANSPORTATION \* UTILITIES  
 \* PROJECT MANAGEMENT \* CONSTRUCTION ENGINEERING & MANAGEMENT  
 2161 FOWLER ST. STE. 100 FORT MYERS, FL 33901 \* PHONE: 239-332-4569  
 EMAIL: ENGINEERING@AIMENGR.COM \* CERTIFICATE OF AUTHORIZATION No. 3114

**HIGHLANDS COUNTY NATURAL RESOURCES DIVISION**  
 4344 GEORGE BLVD., SEBRING, FL. 33875  
 PHONE: (863) 402-6529

DATE: JUN 2023  
 DRAWN BY: AM  
 CHECKED BY: DS  
 DANIEL SCHROEDER  
 PROFESSIONAL ENGINEER  
 P.E. No. 78646

LAKE JUNE-IN-WINTER BMP IMPROVEMENTS  
**FILTER BOX PLAN**

PROJECT NO. 22-1599  
 SHEET NO. C - 03

THE OFFICIAL RECORD OF THIS SHEET IS THE ELECTRONIC FILE DIGITALLY SIGNED AND SEALED UNDER RULE 61G15-23.004, F.A.C.

**CONTROL POINTS**

| CONTROL POINT | TYPE                            | NORTHING     | EASTING     | ELEVATION (NAVD 88) | STATION | OFFSET   |
|---------------|---------------------------------|--------------|-------------|---------------------|---------|----------|
| 60000         | FCM 12" W/ DISK "716755 A 2013" | 1063523.887' | 531490.614' | 94.30'              | 9+16.14 | 205.5' L |
| 60003         | SMAGD "LB3114"                  | 1063528.465' | 531461.208' | 94.69'              | 8+97.31 | 226.4' L |
| 60001         | FCM 12" W/ DISK "716755 b 2013" | 1063499.199' | 531426.798' | 93.81'              | 9+05.12 | 267.2' L |
| 60004         | SMAGD "LB3114"                  | 1063528.465' | 531461.208' | 94.69'              | 5+65.48 | 227.5' L |
| 60567         | SIRC 5/8" "CONTROL LB 3114"     | 1063221.757' | 531912.473' | 97.02'              | 4+09.74 | 101.0' R |
| 60566         | SIRC 5/8" "CONTROL LB 3114"     | 1063640.157' | 531669.086' | 96.85'              | 8+93.77 | 101.4' R |

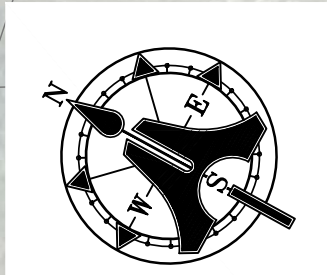
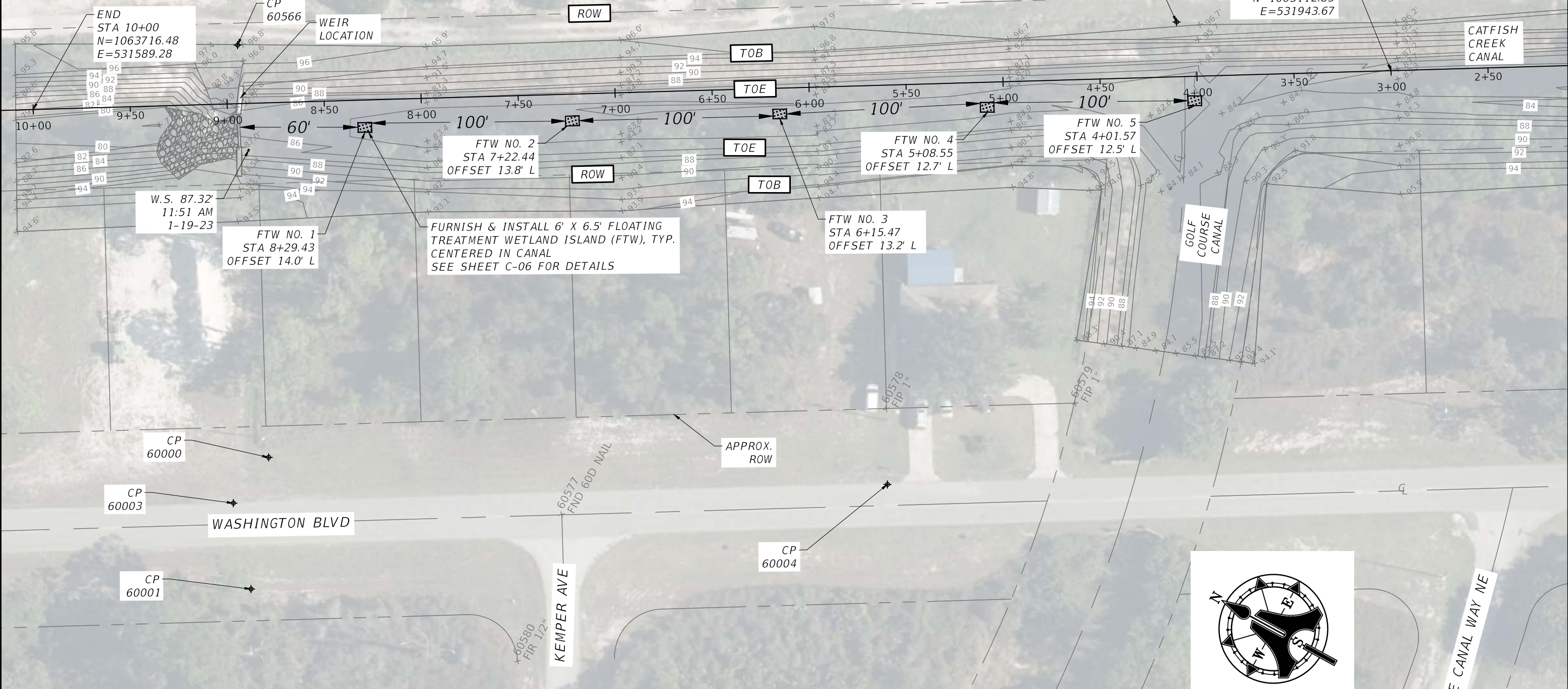

THE CONTRACTOR SHALL CONSTRUCT AN INFORMATIONAL PROJECT SIGN RECOGNIZING SWFWMD AS THE FUNDING ENTITY. THE CONTRACTOR SHALL SUBMIT SIGN DETAILS TO HIGHLANDS COUNTY IN ACCORDANCE WITH LOCAL SIGN ORDINANCES THAT SPECIFY THE SIGN FORM, CONTENT, AND LOCATION. THE COUNTY WILL GAIN WRITTEN APPROVAL FROM SWFWMD BEFORE SIGN APPROVAL AND INSTALLATION AT THE PROJECT SITE.

| NO | DATE | DESCRIPTION |
|----|------|-------------|
| 4  |      |             |
| 3  |      |             |
| 2  |      |             |
| 1  |      |             |

**AIM Engineering & Surveying, Inc.**  
 CIVIL ENGINEERING \* LAND SURVEYING \* S.U.E. \* TRANSPORTATION \* UTILITIES  
 \* PROJECT MANAGEMENT \* CONSTRUCTION ENGINEERING & MANAGEMENT  
 2161 FOWLER ST. STE. 100 FORT MYERS, FL 33901 \* PHONE: 239-332-4569  
 EMAIL: ENGINEERING@AIMENGR.COM \* CERTIFICATE OF AUTHORIZATION No. 3114

**HIGHLANDS COUNTY NATURAL RESOURCES DIVISION**  
 4344 GEORGE BLVD., SEBRING, FL. 33875  
 PHONE: (863) 402-6529

DATE: JUN 2023  
 DRAWN BY: AM  
 CHECKED BY: DS  
 DANIEL SCHROEDER  
 PROFESSIONAL ENGINEER  
 P.E. No. 78646

**LAKE JUNE-IN-WINTER BMP IMPROVEMENTS  
 FLOATING TREATMENT WETLANDS  
 PLAN**

PROJECT NO. 22-1599  
 SHEET NO. C - 04

P:\JOBS\active\22-1599 Lake June-in-Winter Catfish Creek BMPs\CAD\C-04 FTWs Plan.dwg

THE OFFICIAL RECORD OF THIS SHEET IS THE ELECTRONIC FILE DIGITALLY SIGNED AND SEALED UNDER RULE 61G15-23.004, F.A.C.

P:\JOBS\Active\22-1599 Lake June-in-Winter BMPs\CAD\C-05 FILTER BOX DETAILS.dwg

| SITE SPECIFIC DATA                                |           |           |                  |
|---------------------------------------------------|-----------|-----------|------------------|
| Structure ID                                      | NRFS      |           |                  |
| Water Quality Flow Rate (cfs)                     | 0.23      |           |                  |
| Peak Flow Rate (cfs)                              | 0.50      |           |                  |
| Rim Elevation                                     | 99.00'    |           |                  |
| Top of Vault Elevation                            | 91.63'    |           |                  |
| Pipe Data                                         | Pipe Size | Pipe Type | Invert Elevation |
| Inlet                                             | 8"        | PVC       | 87.50'           |
| Outlet                                            | 8"        | PVC       | 88.30'           |
| Notes:<br>WATER TABLE ELEV : 88.40' (CANAL STAGE) |           |           |                  |

**CONTRACTOR TO FURNISH AND INSTALL NUTRIENT REMOVAL FILTRATION SYSTEM (NRFS) WITH ECT3 BOLD & GOLD FILTRATION MEDIA AS MANUFACTURED BY FERGUSON WATERWORKS, OR ENGINEER & OWNER-APPROVED EQUAL. CONTRACTOR TO SUPPLY SHOP DRAWINGS FOR EOR REVIEW AND APPROVAL PRIOR TO FABRICATION AUTHORIZATION.**

| PERFORMANCE SPECIFICATIONS                         |              |
|----------------------------------------------------|--------------|
| Treatment Performance: <sup>*</sup>                |              |
| After Wet Detention, TSS = 60%, TN = 25%, TP = 25% |              |
| As Stand Alone BMP, TSS = 70%, TN = 45%, TP = 45%  |              |
| Treatment Media Area                               | 58.0 sf      |
| Treatment Flow Capacity                            | 1 gal/min/sf |

| COVER DEPTH | WATER TABLE (ABOVE BASE SLAB) |    |    |    |    |             | WT HT AT SF=1.25 |
|-------------|-------------------------------|----|----|----|----|-------------|------------------|
|             | 0'                            | 2' | 4' | 6' | 8' | 8.87' (MAX) |                  |
| 0.0'        | -                             | -  | -  | -  | X  | X           | 7.60'            |
| 1.0'        | -                             | -  | -  | -  | -  | X           | 8.50'            |
| 2.0'        | -                             | -  | -  | -  | -  | -           | 10.20'           |
| 3.0'        | -                             | -  | -  | -  | -  | -           | -                |

\*X : INDICATES ADDL BUOYANCY MEASURES REQUIRED

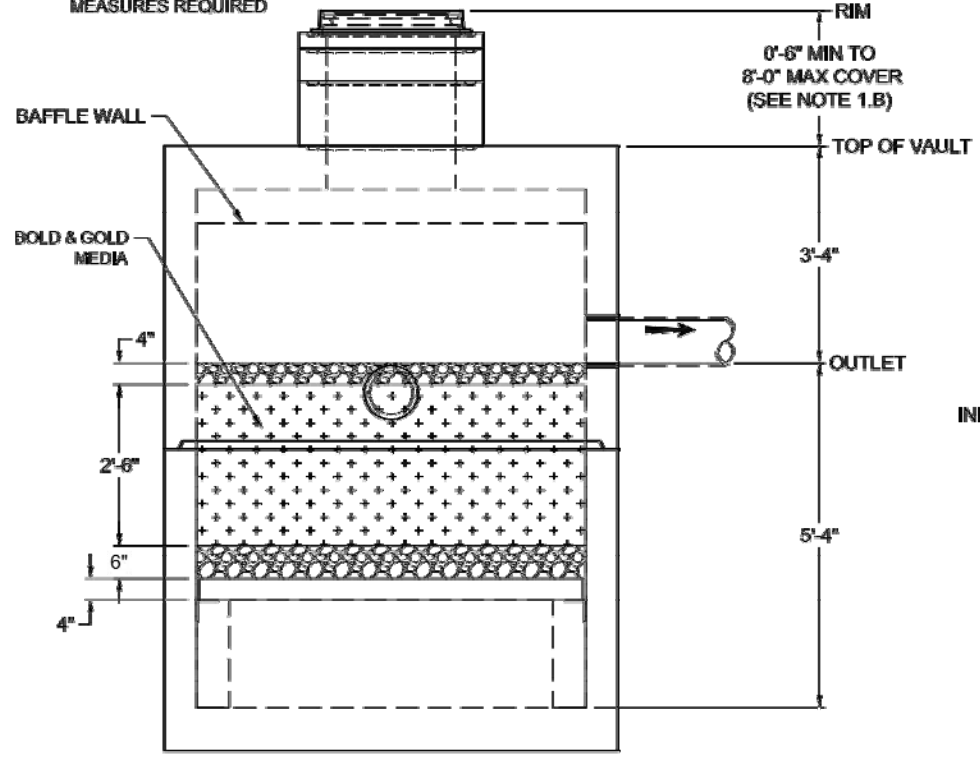

LEFT END VIEW

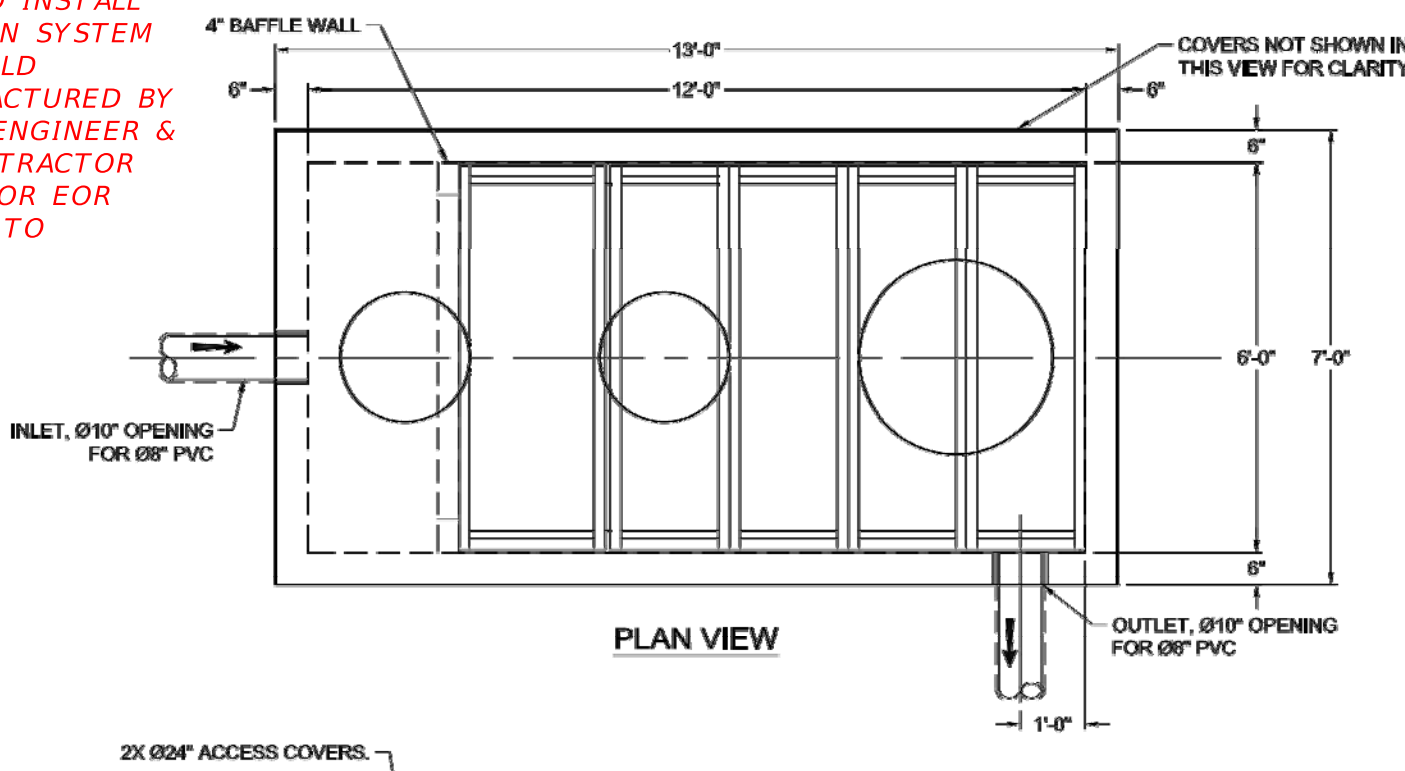

PLAN VIEW

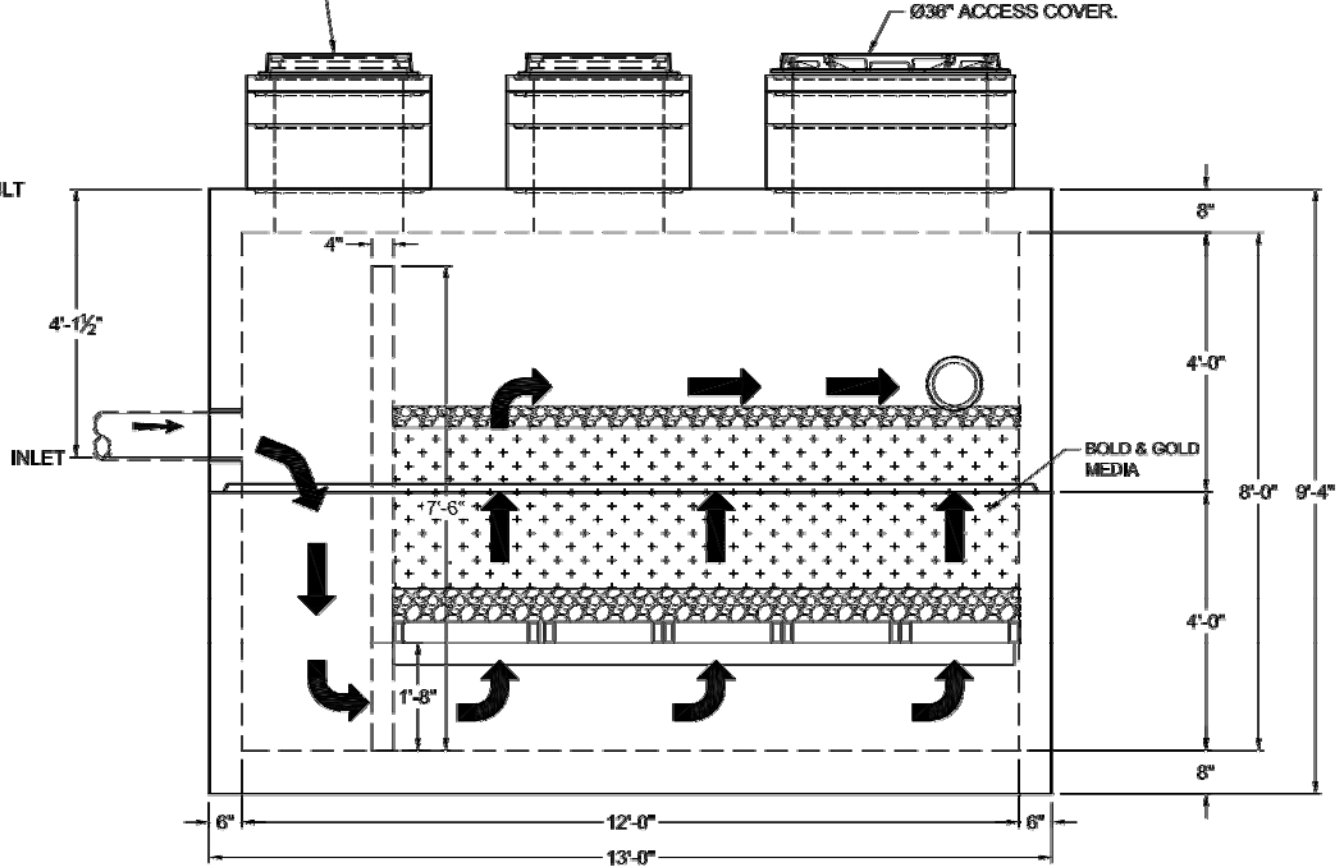

ELEVATION VIEW

- NOTES:**
- DESIGN LOADINGS:
    - A. AASHTO HS-20-44 (WITH IMPACT)
    - B. DESIGN SOIL COVER: 8'-0" MAXIMUM
    - C. ASSUMED WATER TABLE: AT MODULE TOP (ENGINEER-OF-RECORD TO CONFIRM SITE WATER TABLE ELEVATION)
    - D. LATERAL EARTH PRESSURE: 45 PCF (DRAMED)
    - E. LATERAL LIVE LOAD SURCHARGE: 80 PSF (APPLIED TO 8'-0" BELOW GRADE)
    - F. NO LATERAL SURCHARGE FROM ADJACENT BUILDINGS, WALLS, PIERS, OR FOUNDATIONS.
  - CONCRETE 28-DAY MINIMUM COMPRESSIVE STRENGTH: 5,000 PSI MINIMUM.
  - REINFORCING: REBAR, ASTM A618/A706, GRADE 60
  - CEMENT: ASTM C150
  - REQ'D ALLOWABLE SOIL BEARING CAPACITY: 2,500 PSF
  - REFERENCE STANDARD:
    - A. ASTM C880
    - B. ASTM C913
    - C. ACI 318-14
  - THIS STRUCTURE IS DESIGNED TO THE PARAMETERS NOTED HEREIN. ENGINEER-OF-RECORD SHALL VERIFY THAT NOTED PARAMETERS MEET OR EXCEED PROJECT REQUIREMENTS. IF DESIGN PARAMETERS ARE INCORRECT, REVIEWING ENGINEER/AUTHORITY SHALL NOTIFY OLDCASTLE INFRASTRUCTURE UPON REVIEW OF THIS SUBMITTAL.
  - OVERSIZED HOLES TO ACCOMMODATE SPECIFIC PIPE TYPE MUST BE CONCENTRIC TO PIPE ID. AFTER PIPES ARE INSTALLED, ALL ANNULAR SPACES SHALL BE FILLED WITH A MINIMUM OF 3,000 PSI CONCRETE FOR FULL THICKNESS OF PRECAST WALLS. PIPES ARE TO BE FLUSH WITH THE INSIDE SURFACE OF THE CONCRETE STRUCTURE.
  - CONTRACTOR RESPONSIBLE TO VERIFY ALL SIZES, LOCATIONS, AND ELEVATIONS OF OPENINGS.
  - CONTRACTOR RESPONSIBLE TO ENSURE ADEQUATE BEARING SURFACE IS PROVIDED (I.E. COMPACTED AND LEVEL PER PROJECT SPECIFICATIONS).
  - SECTION HEIGHTS, SLAB/WALL THICKNESSES, KEYWAYS AND MEDIA FILTER CHAMBER ARE SUBJECT TO CHANGE AS REQUIRED FOR SITE REQUIREMENTS AND/OR DUE TO PRODUCT AVAILABILITY AND PRODUCTION FACILITY CONSTRAINTS.
  - FOR SITE SPECIFIC DRAWINGS WITH DETAILED STRUCTURE DIMENSIONS AND WEIGHTS, PLEASE CONTACT OLDCASTLE INFRASTRUCTURE.
  - MAXIMUM PICK WEIGHT: 30,000 LBS. (\* COMBINED WEIGHT INCLUDES Baffle WALLS AND PRODUCT INTERNALS.)
  - INTERNALS SHALL CONSIST OF A PANEL, Baffle WALL AND MEDIA.

**- PRELIMINARY - NOT FOR CONSTRUCTION**

**Oldcastle Infrastructure**  
A member of

PH: 800.579.0519 | www.oldcastleinfrastructure.com/dan\_schroeder

THIS DOCUMENT IS THE PROPERTY OF OLDCASTLE INFRASTRUCTURE, INC. IT IS CONFIDENTIAL, SUBMITTED FOR REFERENCE PURPOSES ONLY AND SHALL NOT BE USED IN ANY WAY INJURIOUS TO THE INTERESTS OF, OR WITHOUT THE WRITTEN PERMISSION OF OLDCASTLE INFRASTRUCTURE, INC. COPYRIGHT © 2023 OLDCASTLE INFRASTRUCTURE, INC. ALL RIGHTS RESERVED.

**Nutrient Removing Filtration System™**  
NRFS-612

CUSTOMER: -

PROJECT NAME: Lake June in Winter BMP Improvements - Sebring, FL

|                    |        |          |          |         |             |
|--------------------|--------|----------|----------|---------|-------------|
| DATE               | ISS    | PREPARED | ENGINEER | CHECKED | SALES ORDER |
| 5/10/23            | 374-FL | PPS      | HLA      | HLA     | -           |
| SHEET TITLE        |        |          |          |         | SHEET       |
| 23-837408-NRFS-612 |        |          |          |         | 1 OF 1      |
| REV DATE           |        |          |          |         |             |

THIS PRODUCT IS PROTECTED BY ONE OR MORE OF THE FOLLOWING US PATENT(S): 6,428,692; 7,278,747; 7,981,283; 8,142,688; 8,268,923; 8,491,797; 7,840,327; 8,034,236; RELATED FOREIGN PATENTS, OR OTHER PATENTS PENDING.

| NO | DATE | DESCRIPTION |
|----|------|-------------|
| 4  |      |             |
| 3  |      |             |
| 2  |      |             |
| 1  |      |             |

**AIM Engineering & Surveying, Inc.**  
CIVIL ENGINEERING \* LAND SURVEYING \* S.U.E. \* TRANSPORTATION \* UTILITIES  
\* PROJECT MANAGEMENT \* CONSTRUCTION ENGINEERING & MANAGEMENT

2161 FOWLER ST. STE. 100 FORT MYERS, FL 33901 \* PHONE: 239-332-4569  
EMAIL: ENGINEERING@AIMENGR.COM \* CERTIFICATE OF AUTHORIZATION No. 3114

**HIGHLANDS COUNTY NATURAL RESOURCES DIVISION**  
4344 GEORGE BLVD., SEBRING, FL. 33875  
PHONE: (863) 402-6529

DATE: JUN 2023  
DRAWN BY: AM  
CHECKED BY: DS

DANIEL SCHROEDER  
PROFESSIONAL ENGINEER  
P.E. No. 78646

LAKE JUNE-IN-WINTER BMP IMPROVEMENTS

**FILTER BOX DETAILS**

PROJECT NO. 22-1599  
SHEET NO. C - 05

THE OFFICIAL RECORD OF THIS SHEET IS THE ELECTRONIC FILE DIGITALLY SIGNED AND SEALED UNDER RULE 61G15-23.004, F.A.C.



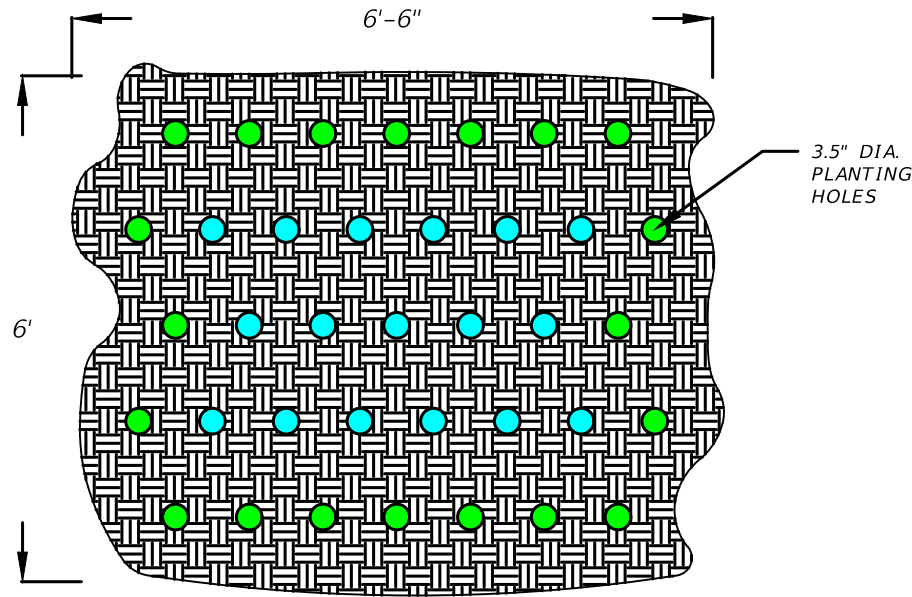

**FLOATING TREATMENT WETLAND DETAIL**  
N.T.S.

**LEGEND**

- PICKERELWEED (PONTEDERIA CORDATA)
- SOFT RUSH (JUNCUS)

CONTRACTOR TO FURNISH AND INSTALL 6' X 6.5' FLOATING TREATMENT WETLANDS AS MANUFACTURED BY MARTIN ECOSYSTEMS, OR ENGINEER & OWNER-APPROVED EQUAL. CONTRACTOR TO SUPPLY SHOP DRAWINGS FOR EOR REVIEW AND APPROVAL PRIOR TO FABRICATION AUTHORIZATION

**PLANTING NOTES:**

1. FURNISH AND INSTALL SOFT RUSH (JUNCUS) PLANTINGS IN THE MIDDLE OF THE FLOATING WETLAND ISLAND PLANTING PORTS AND PICKERELWEED (PONTEDERIA CORDATA) IN THE PERIMETER PLANTING PORTS.
2. PLANTS TO BE MINIMUM OF 12" HIGH AND 2" CONTAINER, OR EQUIVALENT.
3. A MINIMUM OF 80 PERCENT SURVIVABILITY FOR A ONE-YEAR PERIOD OF ALL PLANTINGS IS REQUIRED.
4. THE QUALITY OF ALL PLANT MATERIAL SHALL MEET THE FLORIDA GRADE NO.1 STANDARD (OR BETTER), AS GOVERNED IN "FLORIDA GRADES AND STANDARDS FOR NURSERY PLANTS 2015", AS AMENDED.

**ANCHORING NOTES:**

1. THERE ARE EYE BOLTS AT EACH CORNER OF THE FTW ISLAND (FOUR TOTAL SUPPLIED PER EACH FTW ISLAND). CONTRACTOR TO FURNISH AND INSTALL A SYNTHETIC BRAIDED TETHERING ROPE TO EACH OF THE EYE BOLTS AND SECURE TO A CONCRETE ANCHOR LOCATED ON THE CANAL BOTTOM.
2. THE CONCRETE ANCHOR TO BE FORMED FROM A 12" HIGH, 12" DIAMETER CYLINDRICAL FORM.

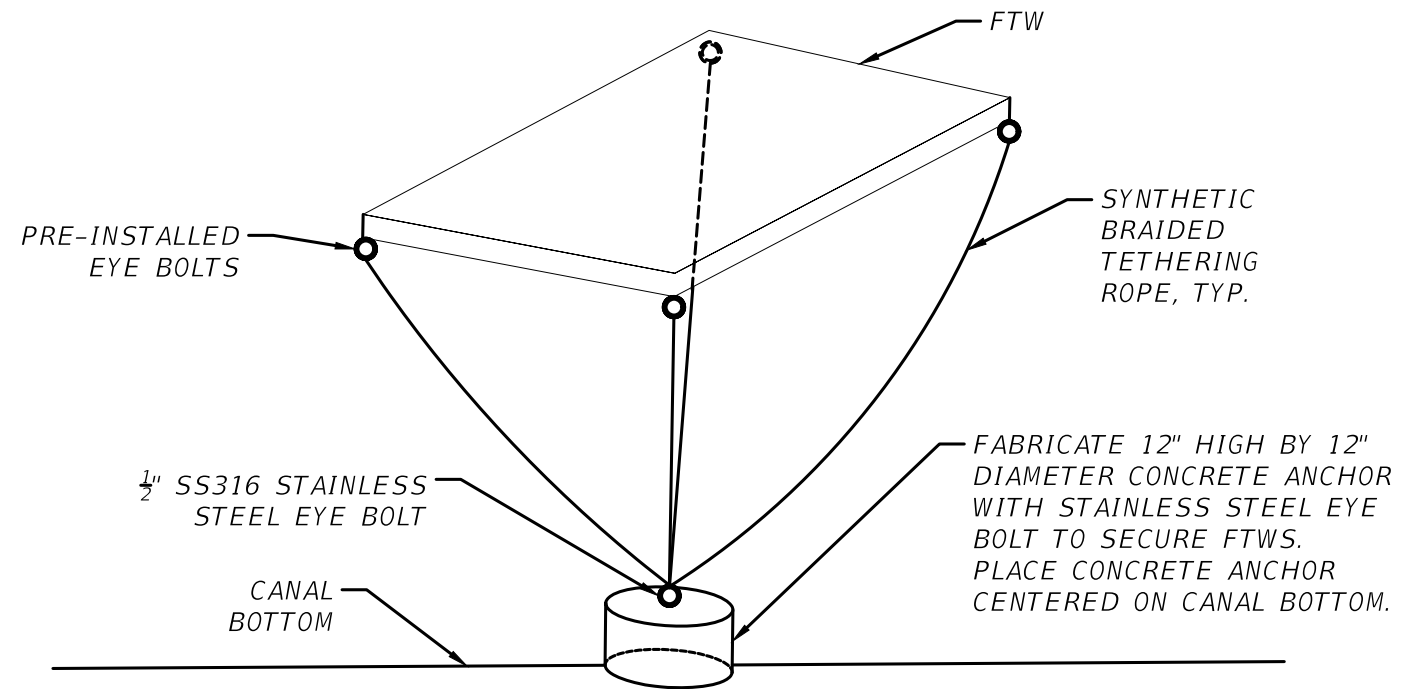

**FTW ANCHORING DETAIL**  
N.T.S.

P:\JOBS\active\22-1599 Lake June-in-Winter Catfish Creek BMPs\CAD\C-06 FLOATING ISLAND TYPICAL DETAIL.dwg

THE OFFICIAL RECORD OF THIS SHEET IS THE ELECTRONIC FILE DIGITALLY SIGNED AND SEALED UNDER RULE 61G15-23.004, F.A.C.

| NO | DATE | DESCRIPTION |
|----|------|-------------|
| 4  |      |             |
| 3  |      |             |
| 2  |      |             |
| 1  |      |             |

**AIM Engineering & Surveying, Inc.**  
 CIVIL ENGINEERING \* LAND SURVEYING \* S.U.E. \* TRANSPORTATION \* UTILITIES  
 \* PROJECT MANAGEMENT \* CONSTRUCTION ENGINEERING & MANAGEMENT  
 2161 FOWLER ST. STE. 100 FORT MYERS, FL 33901 \* PHONE: 239-332-4569  
 EMAIL: ENGINEERING@AIMENGR.COM \* CERTIFICATE OF AUTHORIZATION No. 3114



HIGHLANDS COUNTY NATURAL RESOURCES DIVISION  
 4344 GEORGE BLVD., SEBRING, FL. 33875  
 PHONE: (863) 402-6529

|             |                                                             |
|-------------|-------------------------------------------------------------|
| DATE:       | JUN 2023                                                    |
| DRAWN BY:   | AM                                                          |
| CHECKED BY: | DS                                                          |
|             | DANIEL SCHROEDER<br>PROFESSIONAL ENGINEER<br>P.E. No. 78646 |

LAKE JUNE-IN-WINTER BMP IMPROVEMENTS  
**FLOATING TREATMENT WETLANDS**  
 TYPICAL DETAIL

|             |         |
|-------------|---------|
| PROJECT NO. | 22-1599 |
| SHEET NO.   | C - 06  |

NOTE: EXISTING CATFISH CREEK CANAL CROSS-SECTIONAL CONDITIONS ARE PROVIDED HEREIN FOR INFORMATIONAL USE.

2+96.60

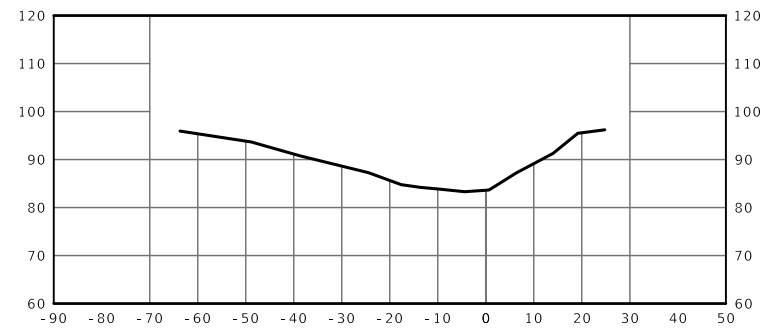

4+59.11

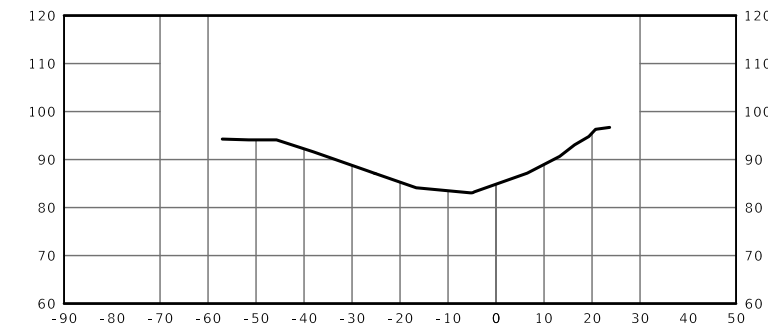

1+89.89

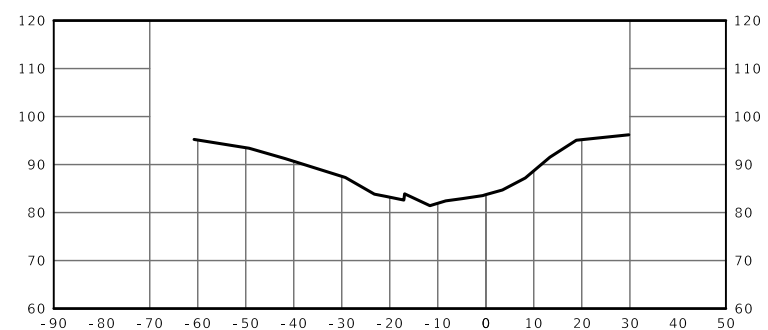

4+08.77

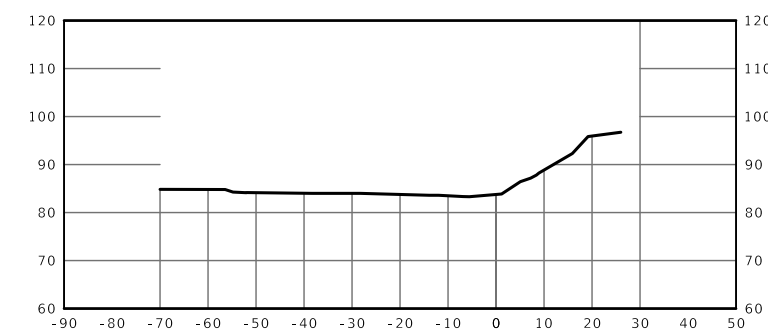

0+96.60

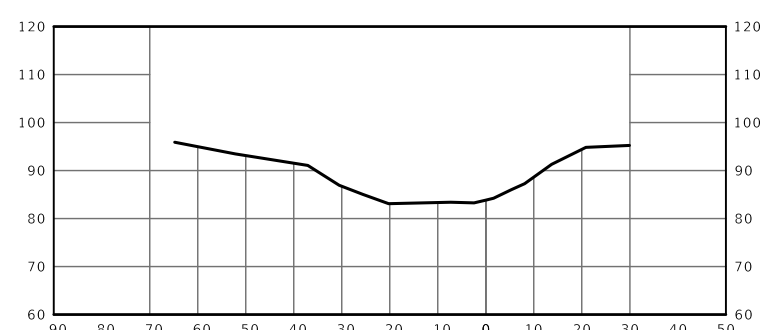

3+51.76

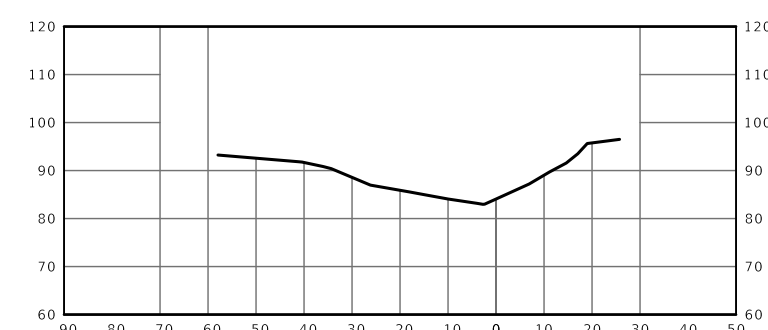

P:\JOBS\active\22-1599 Lake June-in-Winter Catfish Creek BMPs\CAD\C-07 - C-08 CROSS SECTIONS.dwg

THE OFFICIAL RECORD OF THIS SHEET IS THE ELECTRONIC FILE DIGITALLY SIGNED AND SEALED UNDER RULE 61G15-23.004, F.A.C.

| 4  |      |             |
|----|------|-------------|
| 3  |      |             |
| 2  |      |             |
| 1  |      |             |
| NO | DATE | DESCRIPTION |

**AIM Engineering & Surveying, Inc.**  
 CIVIL ENGINEERING \* LAND SURVEYING \* S.U.E. \* TRANSPORTATION \* UTILITIES  
 \* PROJECT MANAGEMENT \* CONSTRUCTION ENGINEERING & MANAGEMENT  
 2161 FOWLER ST. STE. 100 FORT MYERS, FL 33901 \* PHONE: 239-332-4569  
 EMAIL: ENGINEERING@AIMENGR.COM \* CERTIFICATE OF AUTHORIZATION No. 3114

**HIGHLANDS COUNTY NATURAL RESOURCES DIVISION**  
 4344 GEORGE BLVD., SEBRING, FL. 33875  
 PHONE: (863) 402-6529

DATE: JUN 2023  
 DRAWN BY: AM  
 CHECKED BY: DS  
 DANIEL SCHROEDER  
 PROFESSIONAL ENGINEER  
 P.E. No. 78646

**LAKE JUNE-IN-WINTER BMP IMPROVEMENTS  
 CATFISH CREEK CANAL  
 CROSS SECTIONS (1 OF 2)**

PROJECT NO. 22-1599  
 SHEET NO. C - 07

NOTE: EXISTING CATFISH CREEK CANAL CROSS-SECTIONAL CONDITIONS ARE PROVIDED HEREIN FOR INFORMATIONAL USE.

6+97.12

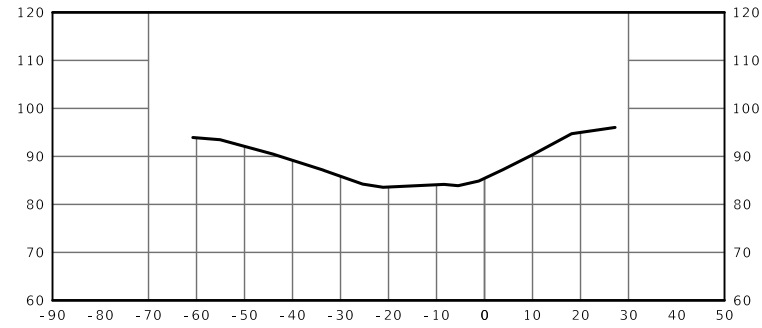

10+07.27

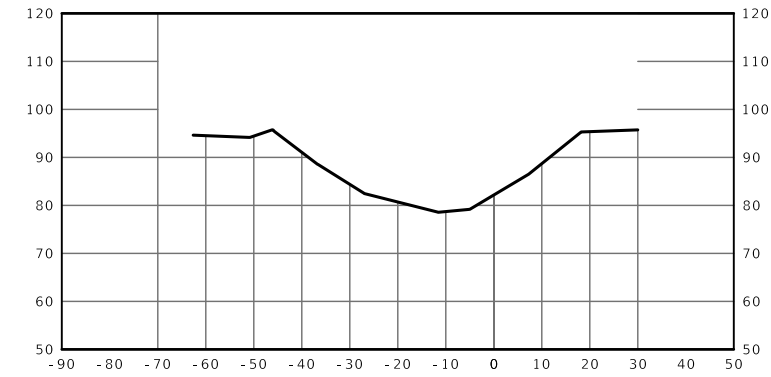

5+96.60

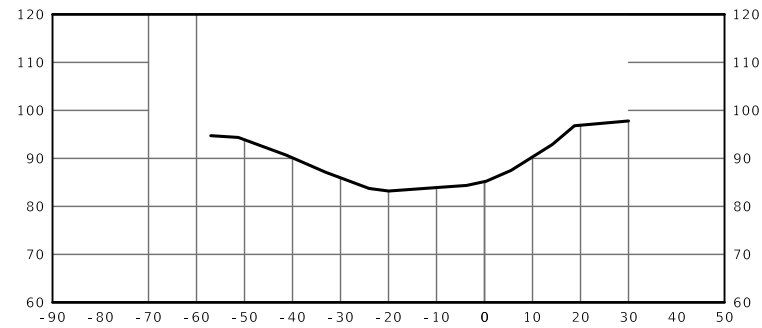

8+88.69

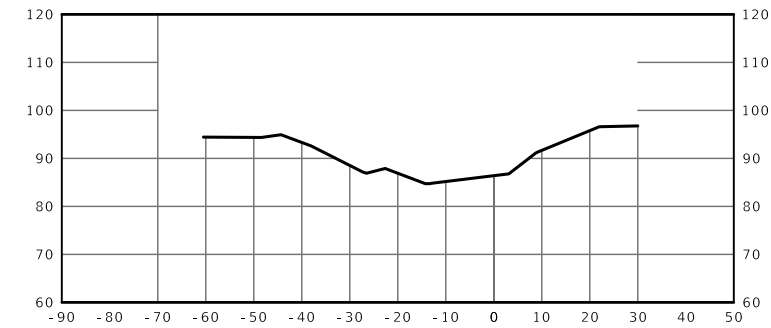

4+96.39

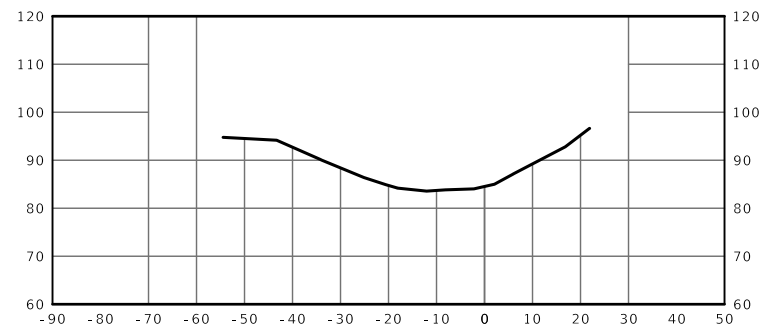

7+98.09

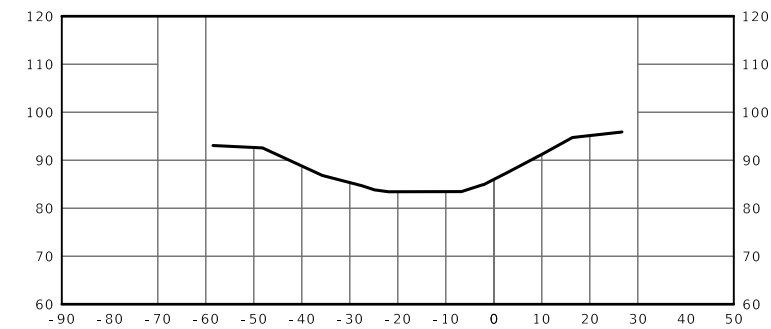

P:\JOBS\active\22-1599 Lake June-in-Winter Catfish Creek BMPs\CAD\C-07 - C-08 CROSS SECTIONS.dwg

| 4  |      |             |
|----|------|-------------|
| 3  |      |             |
| 2  |      |             |
| 1  |      |             |
| NO | DATE | DESCRIPTION |



**AIM Engineering & Surveying, Inc.**  
 CIVIL ENGINEERING \* LAND SURVEYING \* S.U.E. \* TRANSPORTATION \* UTILITIES  
 \* PROJECT MANAGEMENT \* CONSTRUCTION ENGINEERING & MANAGEMENT  
 2161 FOWLER ST. STE. 100 FORT MYERS, FL 33901 \* PHONE: 239-332-4569  
 EMAIL: ENGINEERING@AIMENGR.COM \* CERTIFICATE OF AUTHORIZATION No. 3114



HIGHLANDS COUNTY NATURAL  
 RESOURCES DIVISION  
 4344 GEORGE BLVD.,  
 SEBRING, FL. 33875  
 PHONE: (863) 402-6529

DATE: JUN 2023  
 DRAWN BY: AM  
 CHECKED BY: DS

DANIEL SCHROEDER  
 PROFESSIONAL ENGINEER  
 P.E. No. 78646

LAKE JUNE-IN-WINTER BMP IMPROVEMENTS  
**CATFISH CREEK CANAL**  
**CROSS SECTIONS (2 OF 2)**

PROJECT NO. 22-1599  
 SHEET NO. C - 08

THE OFFICIAL RECORD OF THIS SHEET IS THE ELECTRONIC FILE DIGITALLY SIGNED AND SEALED UNDER RULE 61G15-23.004, F.A.C.

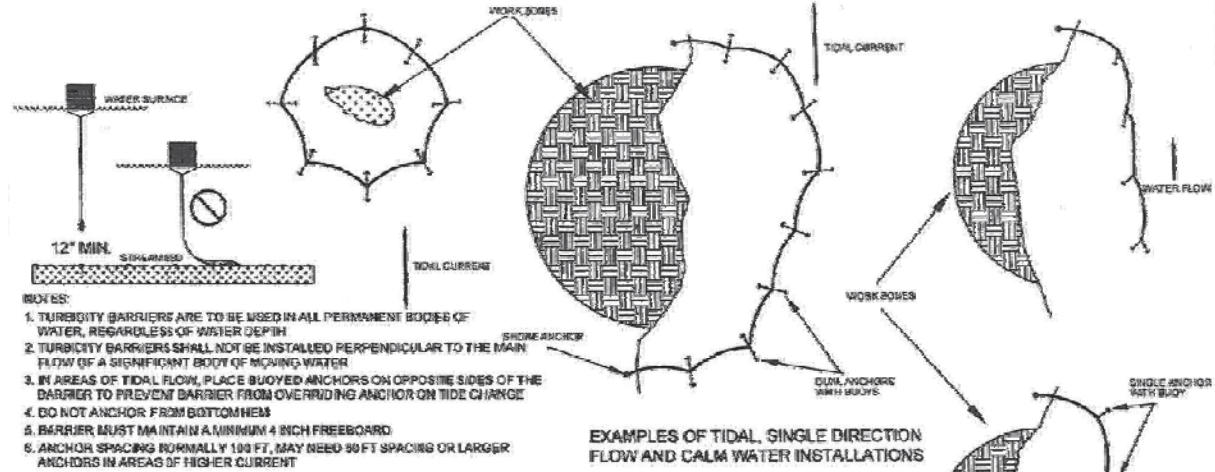

- NOTES:**
1. TURBIDITY BARRIERS ARE TO BE USED IN ALL PERMANENT BODIES OF WATER, REGARDLESS OF WATER DEPTH.
  2. TURBIDITY BARRIERS SHALL NOT BE INSTALLED PERPENDICULAR TO THE MAIN FLOW OF A SIGNIFICANT BODY OF MOVING WATER.
  3. IN AREAS OF TIDAL FLOW, PLACE BUOYED ANCHORS ON OPPOSITE SIDES OF THE BARRIER TO PREVENT BARRIER FROM OVERRIDING ANCHOR ON TIDE CHANGE.
  4. DO NOT ANCHOR FROM BOTTOM MEN.
  5. BARRIER MUST MAINTAIN A MINIMUM 4 INCH FREEBOARD.
  6. ANCHOR SPACING NORMALLY 100 FT., MAY NEED 80 FT SPACING OR LARGER ANCHORS IN AREAS OF HIGHER CURRENT.
  7. SHORE ANCHORS SHALL BE OF SUFFICIENT SIZE, WITH DEADMAN, IF NEEDED.
  8. KEEP CHAIN MEN MINIMUM 1 FT OFF BOTTOM AT LOW TIDE.
  9. DESIGN OF BARRIER AND ANCHOR SYSTEMS SHALL BE IN ACCORDANCE WITH MANUFACTURER'S SPECIFICATIONS THAT MEET OR EXCEED THIS FOOT STANDARD.
  10. LIGHTED BUOYS SHALL BE USED TO MEET REGULATORY STANDARDS.
  11. FOR ADDITIONAL INFORMATION SEE SECTION 104 OF STANDARD SPECIFICATIONS.

**EXAMPLES OF TIDAL, SINGLE DIRECTION FLOW AND CALM WATER INSTALLATIONS**

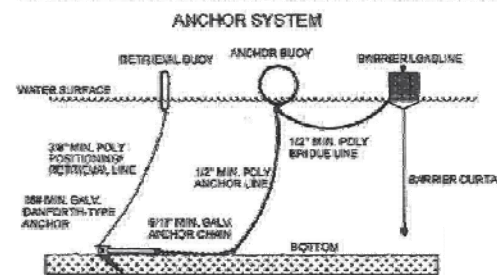

**TURBIDITY BARRIERS N.T.S.**

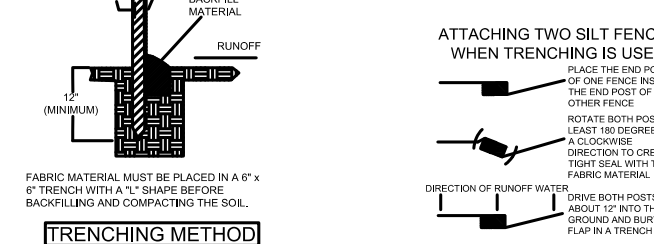
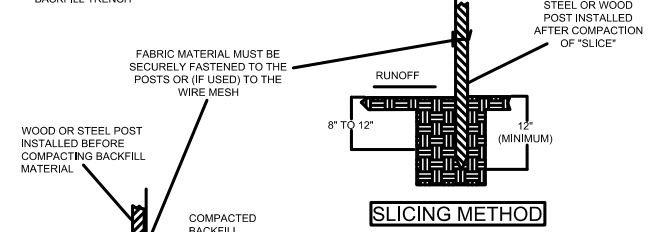
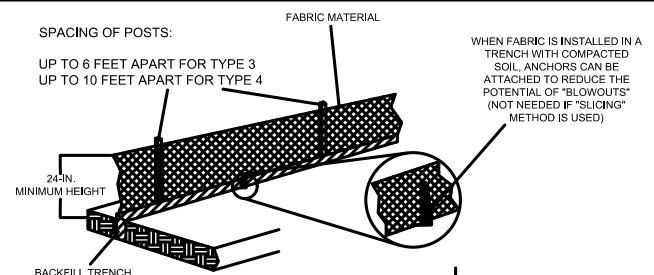

**SILT FENCE BARRIER INSTALLATION N.T.S.**

**EROSION CONTROL NOTES:**

1. IT IS THE CONTRACTOR'S RESPONSIBILITY TO ENSURE THAT CONSTRUCTION ACTIVITIES COMPLY WITH THE NATIONAL POLLUTION DISCHARGE ENVIRONMENTAL STUDY REQUIREMENTS FOR SURFACE WATER RUNOFF AND DO NOT CAUSE EROSION OR TURBIDITY PROBLEMS. THE CONTRACTOR MAY BE REQUIRED TO FILE A NOTICE OF INTENT (NOI) WITH THE FDEP.
2. IT IS THE CONTRACTOR'S RESPONSIBILITY TO ENSURE THAT CONSTRUCTION ACTIVITIES COMPLY WITH NPDES REQUIREMENTS AND DO NOT CAUSE EROSION OR TURBIDITY PROBLEMS. THE CONTRACTOR SHALL TAKE PROPER PRECAUTIONS TO PREVENT SOIL EROSION OR TURBIDITY PROBLEMS FROM OCCURRING IN EITHER ONSITE OR OFFSITE WATER BODIES. FLOATING TURBIDITY BARRIERS, STAKED SILT FENCES OR STAKED SYNTHETIC HAY BALES WILL BE UTILIZED BY THE CONTRACTOR AS NECESSARY TO PREVENT PROBLEMS FROM OCCURRING.
3. PRIOR TO CONSTRUCTION, FILTER FABRIC, SILT SCREENS, SYNTHETIC BALES OR OTHER APPROVED EROSION CONTROL DEVICES SHALL BE INSTALLED BY THE CONTRACTOR TO PREVENT EROSION MATERIAL FROM LEAVING THE CONSTRUCTION AREA, INCLUDING ANY VACANT AREAS USED FOR INGRESS AND EGRESS.
4. ALL AFFECTED STORM WATER PIPES, INLETS AND CATCH BASINS SHALL BE PROTECTED BY EROSION CONTROL DEVICES TO PREVENT CONSTRUCTION RELATED EROSION MATERIAL FROM ENTERING TO STORM WATER SYSTEM.
5. THE EROSION CONTROL DEVICES SHALL BE INSTALLED PRIOR TO ANY CONSTRUCTION PROCESS AND SHALL REMAIN IN PLACE UNTIL STABILIZED WITH SOD AND THE VACANT AREAS ARE SEEDED AND MULCHED.
6. THE CONTRACTOR SHALL MONITOR, MAINTAIN, AND CORRECT DEFICIENCIES OF THE EROSION CONTROL FACILITIES DAILY.
7. AT THE COMPLETION OF CONSTRUCTION AND PRIOR TO ACCEPTANCE OF THE PROJECT BY THE OWNER, THE CONTRACTOR SHALL CLEAN OUT AND DESILT ALL NEW AND EXISTING DRAINAGE FACILITIES.
8. CONTRACTOR SHALL SUBMIT DEMOLITION AND EROSION CONTROL PLAN FOR APPROVAL PRIOR TO COMMENCING CONSTRUCTION ACTIVITIES.

**FLOATING TREATMENT WETLAND EROSION CONTROL PLAN:** CONSTRUCTION ACTIVITIES AT THE FLOATING TREATMENT WETLAND ISLAND PROJECT AREA ARE NOT ANTICIPATED TO REQUIRE FILTER FABRIC, SILT SCREENS, OR SYNTHETIC HAY BALES, AS THE TREATMENT ISLANDS CAN BE INSTALLED BY CARRYING AND PLACING BY HAND WITHOUT THE NEED FOR HEAVY EQUIPMENT OR DISTURBANCE TO THE NATIVE ENVIRONMENT. SHOULD THE CONTRACTOR'S INSTALLATION MEANS AND METHODS INCLUDE DISTURBANCE TO THE NATIVE ENVIRONMENT, EROSION PREVENTION DEVICES SHALL BE UTILIZED.

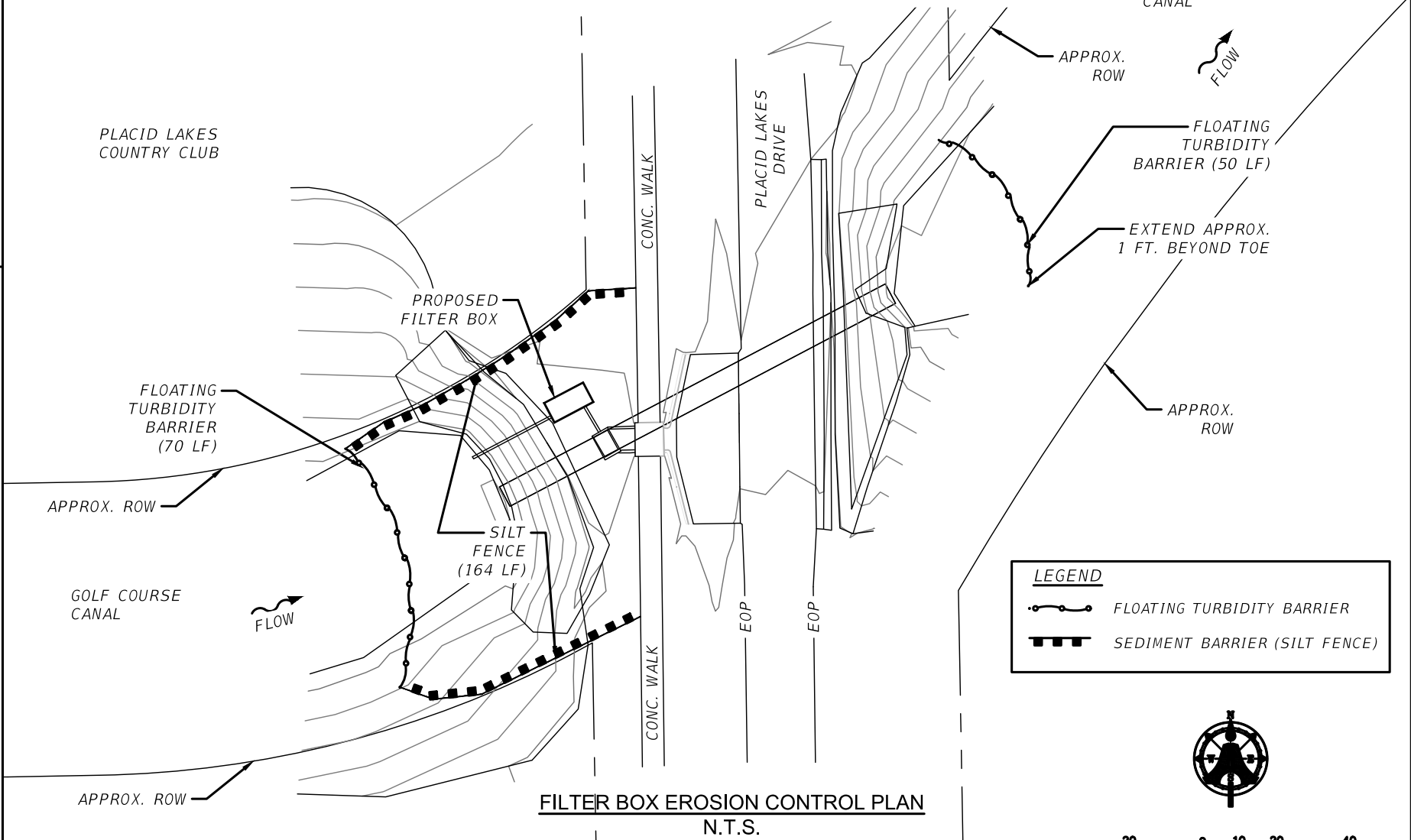

**LEGEND**

- FLOATING TURBIDITY BARRIER
- SEDIMENT BARRIER (SILT FENCE)

P:\JOBS\active\22-1599 Lake June-in-Winter Catfish Creek BMPs\CAD\C-09 EROSION CONTROL.dwg

| NO | DATE | DESCRIPTION |
|----|------|-------------|
| 4  |      |             |
| 3  |      |             |
| 2  |      |             |
| 1  |      |             |

**AIM Engineering & Surveying, Inc.**  
 CIVIL ENGINEERING \* LAND SURVEYING \* S.U.E. \* TRANSPORTATION \* UTILITIES  
 \* PROJECT MANAGEMENT \* CONSTRUCTION ENGINEERING & MANAGEMENT  
 2161 FOWLER ST. STE. 100 FORT MYERS, FL 33901 \* PHONE: 239-332-4569  
 EMAIL: ENGINEERING@AIMENGR.COM \* CERTIFICATE OF AUTHORIZATION No. 3114

**HIGHLANDS COUNTY NATURAL RESOURCES DIVISION**  
 4344 GEORGE BLVD., SEBRING, FL. 33875  
 PHONE: (863) 402-6529

DATE: JUN 2023  
 DRAWN BY: AM  
 CHECKED BY: DS  
 DANIEL SCHROEDER  
 PROFESSIONAL ENGINEER  
 P.E. No. 78646

**LAKE JUNE-IN-WINTER BMP IMPROVEMENTS**  
**EROSION CONTROL**

PROJECT NO. 22-1599  
 SHEET NO. C-09

THE OFFICIAL RECORD OF THIS SHEET IS THE ELECTRONIC FILE DIGITALLY SIGNED AND SEALED UNDER RULE 61G15-23.004, F.A.C.

GENERAL NOTES:

1. THE LOCATION OF EXISTING UTILITIES, PAVEMENT, VEGETATION, AND MISCELLANEOUS IMPROVEMENTS ARE APPROXIMATE ONLY. CONTRACTOR SHALL BE RESPONSIBLE FOR VERIFYING EXACT UTILITY LOCATIONS AND FOR ANY DAMAGE WHICH MAY OCCUR BY FAILING TO PRESERVE THEM.
2. ANY PUBLIC LAND CORNER MONUMENT WITHIN THE LIMITS OF CONSTRUCTION IS TO BE PROTECTED. IF A CORNER MONUMENT IS IN DANGER OF BEING DESTROYED AND HAS NOT BEEN PROPERLY REFERENCED, THE CONTRACTOR SHOULD NOTIFY THE OWNER/ENGINEER WITHOUT DELAY.
3. EXISTING FACILITIES SHALL BE RESTORED TO A CONDITION EQUIVALENT TO THAT WHICH EXISTED PRIOR TO COMMENCING CONSTRUCTION, AT NO ADDITIONAL COST TO OWNER.
4. ALL CONSTRUCTION SHALL BE IN ACCORDANCE WITH STATE OF FLORIDA, DEPARTMENT OF TRANSPORTATION, ROADWAY AND TRAFFIC DESIGN STANDARDS, (LATEST EDITION). AND HIGHLANDS COUNTY STANDARDS, DETAILS, AND SPECIFICATIONS.
5. CONTRACTOR SHALL NOTIFY HIGHLANDS COUNTY A MINIMUM OF 72 HOURS PRIOR TO ALL REQUIRED INSPECTIONS.
6. CONTRACTOR TO PROVIDE AND MAINTAIN SILT FENCE AND OTHER ALL APPROPRIATE MEASURES TO EFFECT THE FILTRATION OF SURFACE WATER FLOWS AND TO PROVIDE EROSION PROTECTION DURING CONSTRUCTION ACTIVITIES. PROTECTION IS TO BE MAINTAINED DURING THE CONSTRUCTION PERIOD UNTIL DISTURBED SOILS HAVE BEEN STABILIZED WITH GRASS OR SUITABLE EROSION PROTECTION TREATMENT.
7. ALL UNPAVED AREAS DISTURBED DURING CONSTRUCTION SHALL BE RESTORED WITH NATIVE GROUND COVER. SEEDING AND MULCHING ARE NOT PERMITTED.
8. EXISTING OFF-SITE DRAINAGE PATTERNS SHALL BE MAINTAINED DURING CONSTRUCTION.
9. CONTRACTOR SHALL RETAIN, ON THE WORK SITE, COPIES OF ANY PERMITS NECESSARY FOR CONSTRUCTION.
10. CONTRACTOR SHALL PROMPTLY REPORT ALL FIELD CHANGES TO THE ENGINEER.
11. CONTRACTOR SHALL CLEAR ALL EXCAVATION AND FILL AREAS; ACTUAL LIMITS OF CLEARING SHALL BE DETERMINED IN THE FIELD BY OWNER OR ENGINEER. EXCESS EXCAVATED MATERIALS SHALL BE REMOVED FROM ALL AREAS AND DISPOSED OF OFF-SITE.
12. CONTRACTOR SHALL REMOVE ALL MUCK AND OTHER UNSUITABLE MATERIAL FROM FILL AREAS PRIOR TO PLACEMENT OF FILL. ALL MUCK AND OTHER UNSUITABLE MATERIAL EXCAVATED OR REMOVED FROM FILL AREAS SHALL BE STOCKPILED AT THE PROPOSED PROJECT AS DETERMINED BY THE OWNER. SITE GRADES MAY BE ADJUSTED IN FIELD BY ENGINEER.
13. EXCESS EXCAVATED MATERIALS SHALL BE REMOVED FROM ALL AREAS AND DISPOSED OF OFF-SITE.
14. LOCATION OF STORM DRAINAGE END TREATMENTS ARE SUBJECT TO MODIFICATION IN THE FIELD BY OWNER OR ENGINEER TO PRESERVE EXISTING VEGETATION.
15. CONTRACTOR SHALL USE DESIGNATED CONSTRUCTION ENTRANCES FOR EMPLOYEES AND DELIVERY OF MATERIALS
16. CONTRACTOR IS REQUIRED TO OBTAIN FROM THE ENGINEER AND OWNER WRITTEN APPROVAL FOR ANY DEVIATIONS FROM THE PLANS AND/OR SPECIFICATIONS.
17. CONTRACTOR SHALL BE RESPONSIBLE FOR MAINTAINING TRAFFIC AND USAGE OF THE EXISTING STREETS ADJACENT TO THE PROJECT. ALL TRAFFIC MAINTENANCE CONTROL SHALL BE IN ACCORDANCE WITH THE FLORIDA MANUAL OF TRAFFIC CONTROL AND SAFE PRACTICES FOR STREET AND HIGHWAY CONSTRUCTION, MAINTENANCE, AND UTILITY OPERATIONS.
18. COMPENSATION FOR THE WORK AS SHOWN ON THE PLANS SHALL BE AT THE UNIT PRICE INCLUDED IN THE BID SCHEDULE. NO SEPARATE PAYMENT WILL BE MADE FOR TASKS (NOT ALL INCLUSIVE) INCLUDING SUCH ITEMS AS FIELD OFFICE, SANITARY FACILITIES, ROCK EXCAVATION, DEWATERING, MATERIAL DELIVERY AND STORAGE, TEMPORARY POWER, ETC. NECESSARY FOR THE COMPLETE EXECUTION OF THE WORK.
19. THE CONTRACTOR SHALL BE RESPONSIBLE FOR OBTAINING ALL REQUIRED FEDERAL, STATE, COUNTY AND/OR LOCAL CONSTRUCTION PERMITS/APPROVALS PRIOR TO STARTING ANY CONSTRUCTION ACTIVITIES. (INCLUDING A DEWATERING PERMIT IF NEEDED.)
20. THE CONTRACTOR SHALL NOTIFY ALL REQUIRED UTILITIES AND GOVERNMENT AGENCIES AT LEAST 48 HOURS PRIOR TO COMMENCEMENT OF CONSTRUCTION. (48 HOURS BEFORE DIGGING CALL TOLL FREE 1-800-432-4770 SUNSHINE ONE CALL CENTER - PREVIOUSLY U.N.C.L.E.).
21. ALL QUANTITIES SHOWN HEREIN ARE APPROXIMATE. THE CONTRACTOR SHALL VERIFY ALL QUANTITIES SHOWN ON THE PLANS AND PROMPTLY NOTIFY THE ENGINEER OF ANY DISCREPANCIES FOUND IN THE QUANTITIES.
22. ENGINEER SHALL BE CONSULTED TO MAKE ANY REQUIRED INTERPRETATIONS OF THE PLANS OR GIVE SUPPLEMENTARY INSTRUCTIONS TO ACCOMPLISH THE INTENT OF THE PLANS.
23. THE INFORMATION PROVIDED IN THESE PLANS IS SOLELY TO ASSIST THE CONTRACTOR IN ASSESSING THE NATURE AND EXTENT OF THE CONDITIONS WHICH MAY BE ENCOUNTERED DURING THE COURSE OF THE WORK. ALL PROSPECTIVE CONTRACTORS ARE ENCOURAGED, PRIOR TO BIDDING, TO CONDUCT ANY SITE INVESTIGATIONS THEY DEEM NECESSARY TO ARRIVE AT THEIR OWN CONCLUSIONS REGARDING THE ACTUAL CONDITIONS THAT MAY BE ENCOUNTERED, AND UPON WHICH THEIR BIDS SHALL BE BASED.
24. ALL MATERIALS, MEANS AND CONSTRUCTION METHODS SHALL CONFORM WITH THE LATEST EDITION OF THE FLORIDA DEPARTMENT OF TRANSPORTATION'S STANDARD SPECIFICATIONS FOR ROAD AND BRIDGE CONSTRUCTION AND ANY SUPPLEMENTAL SPECIFICATIONS THEREOF.
25. THE CONTRACTOR SHALL SECURE ANY TEMPORARY CONSTRUCTION EASEMENTS NECESSARY FOR CONSTRUCTION AND WILL BE RESPONSIBLE FOR RESTORATION OF ALL DISTURBED AREAS.
26. ALL BACKFILLING SHALL BE IN LIFTS OF NOT MORE THAN 12" LOOSE MATERIAL AND COMPACTED TO 100% OF AASHTO T-180 TESTING STANDARDS. CONTRACTOR SHALL PROVIDE DENSITY REPORTS FOR ALL AREAS BACKFILLED (COPIES TO ENGINEER AND OWNER) AND SHALL BEAR ALL COSTS ASSOCIATED WITH TESTING AND/OR ANY RETESTING OF ANY AREAS THAT DO NOT MEET THE ABOVE STANDARDS. EXCESS EXCAVATED MATERIAL SHALL BE HAULED TO AN APPROVED AREA OFF-SITE, IF REQUIRED.
27. THE CONTRACTOR SHALL MAINTAIN A CURRENT SET OF CONSTRUCTION PLANS AND ALL PERMITS ON THE JOB SITE DURING ALL PHASES OF THE WORK. TWO (2) COMPLETE SETS OF "AS-BUILT" DRAWINGS MUST BE DELIVERED TO THE ENGINEER OF RECORD WITHIN FIFTEEN (15) DAYS OF COMPLETING CONSTRUCTION ALONG WITH ELECTRONIC FILES IN AUTOCAD FORMAT. CONTRACTOR SHALL OBTAIN THE SERVICES OF A REGISTERED LAND SURVEYOR TO PERFORM "AS-BUILT" VERIFICATION OF ANY CRITICAL ELEVATIONS ASSOCIATED WITH ANY STRUCTURES AND/OR CULVERTS BUILT AS PART OF THIS PROJECT.

29. ELEVATIONS SHOWN HEREON ARE MEASURED RELATIVE TO THE NORTH AMERICAN VERTICAL DATUM OF 1988 (NAVD 88) BASED ON DIRECT TIES TO THE NATIONAL GEODETIC SURVEY (NGS).
30. COORDINATES SHOWN HEREON ARE REFERENCED TO THE FLORIDA STATE PLANE COORDINATE SYSTEM, EAST ZONE, NORTH AMERICAN DATUM OF 1983 (NAD83/2011) BASED ON DIRECT TIES TO NGS CONTROL POINTS CITED ABOVE.
31. HORIZONTAL AND VERTICAL POSITIONING OF ALL TOPOGRAPHIC DATA WAS DERIVED BY RTK GPS OBSERVATION USING CORRECTIONS RECEIVED FROM A LOCAL GPS BASE STATION ON NGS CONTROL POINTS CITED ABOVE.
32. CONTRACTOR SHALL RECOGNIZE AND ABIDE BY ALL OSHA EXCAVATION SAFETY STANDARDS, INCLUDING THE FLORIDA TRENCH SAFETY ACT, F.S. 553.60-553.64. ANY MATERIAL, CONSTRUCTION METHODS, OR MATERIAL COST TO COMPLY WITH THESE LAWS SHALL BE INCIDENTAL TO THE CONTRACT.
33. ALL EXCAVATIONS SHALL BE MADE BY OPEN CUT UNLESS OTHERWISE INDICATED. SLOPE SIDES OF TRENCHES IN ACCORDANCE WITH OSHA REQUIREMENTS. FURNISH, INSTALL, AND MAINTAIN, WITHOUT ADDITIONAL COMPENSATION, SHEETING, BRACING, AND SHORING SUPPORT REQUIRED TO KEEP EXCAVATIONS WITHIN THE PROPERTY OR EASEMENTS PROVIDED, TO SUPPORT THE SIDES OF THE EXCAVATION, AND TO PREVENT ANY MOVEMENT WHICH MAY DAMAGE ADJACENT PAVEMENTS OR STRUCTURES, DAMAGE OR DELAY THE WORK, OR ENDANGER LIFE AND HEALTH. VOIDS OUTSIDE THE SUPPORTS SHALL BE IMMEDIATELY FILLED AND COMPACTED.
34. DEWATERING ACTIVITIES: CONSTRUCTION IS PROPOSED DURING THE DRY SEASON WITH NO DEWATERING MEASURES ANTICIPATED. IF CONTRACTOR DECIDES DEWATERING IS NECESSARY, DEWATERING SYSTEM SHALL UTILIZE ACCEPTED AND PROFESSIONAL METHODS CONSISTENT WITH CURRENT INDUSTRY PRACTICE. DEWATERING DESIGN AND PERMITS, IF NEEDED, SHALL BE THE RESPONSIBILITY OF THE CONTRACTOR. EXCAVATION OF DETENTION AREAS AND UNDERGROUND UTILITIES WILL BE PERFORMED WITHOUT A DEWATERING PERMIT. IF CONDITIONS PROVE TO MAKE WET EXCAVATION UNDESIRABLE, CONTRACTOR SHALL OBTAIN A DEWATERING PERMIT THROUGH SWFWMD AND/OR HIGHLANDS COUNTY. WHEN COMPLETE, REMOVE ALL DEWATERING EQUIPMENT FROM THE SITE, INCLUDING WELLS AND TEMPORARY ELECTRICAL SERVICE.
35. CONTRACTOR SHALL BE RESPONSIBLE FOR OBTAINING ANY RIGHT-OF-WAY, CLEARING, DEWATERING, TREE REMOVAL, OR VEGETATION REMOVAL PERMITS REQUIRED FOR THIS PROJECT. A VEGETATION REMOVAL PERMIT MAY BE REQUIRED PRIOR TO COMMENCEMENT OF ANY SITE WORK. PROTECTIVE BARRIERS MUST BE CONSTRUCTED AND INSPECTED PRIOR TO PERMIT ISSUANCE, IF APPLICABLE.

| SUMMARY OF PAY ITEMS              |                                                                                                             |      |     |
|-----------------------------------|-------------------------------------------------------------------------------------------------------------|------|-----|
| ITEM                              | DESCRIPTION                                                                                                 | UNIT | QTY |
| <b>FILTER BOX PAY ITEMS</b>       |                                                                                                             |      |     |
| 1                                 | MOBILIZATION & DEMOBILIZATION                                                                               | LS   | 1   |
| 2                                 | MAINTENANCE OF TRAFFIC                                                                                      | LS   | 1   |
| 3                                 | EROSION CONTROL, SILT FENCE                                                                                 | LF   | 164 |
| 4                                 | EROSION CONTROL, FLOATING TURBIDITY BARRIER                                                                 | LF   | 120 |
| 5                                 | GENERAL REQUIREMENTS (INCLUDING PROJECT INFORMATIONAL SIGN)                                                 | LS   | 1   |
| 6                                 | CLEARING AND DEMOLITION (PARTIAL REMOVAL OF FABRIFORM FOR PIPE INSTALLATION)                                | LS   | 1   |
| 7                                 | EARTHWORK                                                                                                   | LS   | 1   |
| 8                                 | OLDCASTLE NRFS 6' X 12' FILTER BOX WITH BOLD & GOLD ECT3 FILTER MEDIA (OR APPROVED EQUAL)                   | EA   | 1   |
| 9                                 | PIPE CULVERT (PVC), 8" ROUND                                                                                | LF   | 32  |
| 10                                | EXISTING INLET MODIFICATION (TO TIE-IN PROPOSED 8" PVC PIPE)                                                | LS   | 1   |
| 11                                | CONCRETE PIPE BLOCK, 0.5' X 2'                                                                              | LS   | 1   |
| 12                                | CONCRETE SLOPE PAVEMENT, 6" THICK (REPLACING SLOPE PROTECTION WHERE CONCRETE FABRIFORM WAS REMOVED)         | LS   | 1   |
| 13                                | RIPRAP RUBBLE, DITCH LINING (SUMP AT 8" PVC PIPE INFLOW)                                                    | TN   | 10  |
| 14                                | RESTORATION SODDING (APPLIED TO ALL DISTURBED AREAS)                                                        | SY   | 800 |
| <b>FLOATING ISLANDS PAY ITEMS</b> |                                                                                                             |      |     |
| 1                                 | MOBILIZATION & DEMOBILIZATION                                                                               | LS   | 1   |
| 2                                 | GENERAL REQUIREMENTS (INCLUDING PROJECT INFORMATIONAL SIGN)                                                 | LS   | 1   |
| 3                                 | BIOHAVEN 6.5' X 6' FLOATING TREATMENT WETLAND MATS WITH BOTTOM-MOUNTED ANCHOR POINTS (OR APPROVED EQUAL)    | EA   | 5   |
| 4                                 | CONCRETE ANCHOR (FORMED FROM 12" HIGH, 12" DIAMETER CYLINDRICAL FORM) AND SYNTHETIC BRAIDED TETHERING ROPES | EA   | 5   |
| 5                                 | PLANTINGS: PICKERELWEED (MINIMUM 2" CONTAINER AND 12" HIGH)                                                 | EA   | 100 |
| 6                                 | PLANTINGS: SOFT RUSH (MINIMUM 2" CONTAINER AND 12" HIGH)                                                    | EA   | 85  |

P:\JOBS\active\22-1599 Lake June-in-Winter Catfish Creek BMPs\CAD\C-10 CONSTRUCTION NOTES.dwg

| 4  |      |             |
|----|------|-------------|
| 3  |      |             |
| 2  |      |             |
| 1  |      |             |
| NO | DATE | DESCRIPTION |

**AIM Engineering & Surveying, Inc.**

CIVIL ENGINEERING \* LAND SURVEYING \* S.U.E. \* TRANSPORTATION \* UTILITIES  
 \* PROJECT MANAGEMENT \* CONSTRUCTION ENGINEERING & MANAGEMENT

2161 FOWLER ST. STE. 100 FORT MYERS, FL 33901 \* PHONE: 239-332-4569  
 EMAIL: ENGINEERING@AIMENGR.COM \* CERTIFICATE OF AUTHORIZATION No. 3114



HIGHLANDS COUNTY NATURAL RESOURCES DIVISION  
 4344 GEORGE BLVD., SEBRING, FL. 33875  
 PHONE: (863) 402-6529

|             |                                                             |
|-------------|-------------------------------------------------------------|
| DATE:       | JUN 2023                                                    |
| DRAWN BY:   | AM                                                          |
| CHECKED BY: | DS                                                          |
|             | DANIEL SCHROEDER<br>PROFESSIONAL ENGINEER<br>P.E. No. 78646 |

**LAKE JUNE-IN-WINTER BMP IMPROVEMENTS**

**CONSTRUCTION NOTES**

|             |         |
|-------------|---------|
| PROJECT NO. | 22-1599 |
| SHEET NO.   | C - 10  |

THE OFFICIAL RECORD OF THIS SHEET IS THE ELECTRONIC FILE DIGITALLY SIGNED AND SEALED UNDER RULE 61G15-23.004, F.A.C.

## SPECIAL PROVISIONS

1. The Contractor is responsible for submitting the Notice of Intent (NOI) and the Stormwater Pollution Prevention Plan (SWPPP) to the Florida Department of Environmental Protection. A copy of the required application is available online at <http://www.dot.state.fl.us/specificationsoffice/DEEPPermit.pdf>. The Contractor shall submit a copy of the NOI and the SWPPP at the pre-construction conference for review. The Contractor will be required to have all erosion control devices in place prior to commencing other work. Costs associated with the Notice of Intent and SWPPP are the responsibility of the Contractor. Contractor shall provide the project manager with a copy of the notice of intent (NOI) and the approved storm water pollution prevention plan (SWP3) in compliance with the Florida Department of Environmental Protection and Highlands County Division of Natural Resources-NPDES program guidelines and criteria prior to the start of construction. Contractor shall be responsible for the fees listed below:

CGP Permit (1 – 5 acres): \$250.00

MSGP permit (5+ acres): \$500.00

All pollution prevention control measures shall be inspected weekly and after any rainfall event(s) greater than ½ inch in a 24-hour period. All pollution prevention control measures shall be maintained in proper working order. All repairs shall be initiated immediately, but no later than twenty-four (24) hours after discovery. All pollution prevention control measures shall be maintained during construction and until all disturbed areas have been suitably stabilized. All sodding on slopes greater than 2.5(h):1(v) shall be staked in place.

2. The Contractor is responsible for dewatering permitting and operation. Costs associated with the dewatering are the responsibility of the Contractor.
3. **SIGNAGE**  
The Contractor shall construct informational project signs at each project location recognizing SWFWMD as the funding entity. The contractor shall submit signage details to Highlands County in accordance with local sign ordinances that specify the sign form, content, and location. The County will gain written approval from SWFWMD before providing sign approval and installation at each project site. Payment for the project signs shall be included in General Conditions pay item for the Baffle Box and Floating Treatment Wetlands.
4. **CONTRACT TIME**  
Contractor shall perform the contracted work fully, entirely, and in accordance with the Contract Documents within the Contract Time specified herein.

Contract Time: Project Final Completion Date: December 31, 2024, in one phase.

5. **PERMITS**  
Permits procured by the County are listed below and attached hereto:

SWFWMD General Stormwater Retrofit Permit – Pending

6. **GEOTECHNICAL INFORMATION**  
No geotechnical evaluation has been performed in association with this project.

Lake June-In-Winter Catfish Creek BMPs, Highlands County, FL

7. CONTRACTOR / SUB-CONTRACTOR QUALIFICATION REQUIREMENTS:

The Prime Contractor or sub-contractor shall be licensed for the work; have the financial capability to complete the project and pay damages if defaulted; have bonding capacity for the work; have satisfactory work experience with projects of similar size and scope within the last five years; and have a history of satisfactory claims resolution.

Coordination and cooperation are required with the adjacent Placid Lakes Golf Course operation while working on the project area.

## TECHNICAL SPECIFICATIONS

### SCOPE OF WORK

The Highlands County "Lake June-In-Winter Catfish Creek Best Management Practices (BMPs)" project includes a proposed nutrient-reducing filter box and five (5) floating treatment wetland islands to be located in Sections 14 and 15, Township 37 South and Range 29 East, Town of Lake Placid, Highlands County, Florida. The two project sites are located within County road and canal right-of-way. The project is funded under a cooperative agreement between Highlands County and Southwest Florida Water Management District (SWFWMD). The project scope generally includes the construction of a 6' x 12' x 9' filter box with filter media and risers, and five 6' x 6.5' floating wetland islands with vegetative plantings and anchoring. Other associated construction activities include minimal clearing/grubbing, excavation, removal and replacement of concrete slope pavement, 8" PVC pipe, sodding, and other restoration activities.

### MEASUREMENT AND PAYMENT

The Contractor shall provide all labor, materials, equipment and incidental work to accomplish the Scope of Work and the items listed on the Bid Schedule for a complete project in accordance with the Special Provisions and the Florida Department of Transportation (FDOT) specifications. The basis of measure and payment shall be as shown on the bid schedule for field-measured quantities.

### INCLUSION OF FDOT SPECIFICATIONS-

The latest edition of the Florida Department of Transportation (FDOT) Standard Specifications for Road and Bridge Construction together with all FDOT supplements thereto shall apply to and form a part of this Contract as it is fully written herein. Where an FDOT Section is cited that contains a reference to other Sections, they shall also be included as though written therein. In case of conflict between the referenced FDOT Specifications and the Bid and Contract Documents, the Bid and Contract Documents shall govern.

<http://www.fdot.gov/design/standardplans/current/default.shtm>

<http://www.fdot.gov/programmanagement/Implemented/SpecBooks/>

### INCLUSION OF HIGHLANDS COUNTY DEVELOPMENT STANDARDS

The Highlands County Development Standards shall apply to and form a part of this Contract as it is fully written herein. Where a conflict between the FDOT and County standards may occur, the stricter of the two standards shall apply.

\*Notes specification section prepared by AIM Engineering & Surveying, Inc. to supplement Highlands County including the following items:

### NUTRIENT REMOVING FILTRATION SYSTEM (NRFS)

Utilize the nutrient removal filtration system (NRFS) with ECT3 BOLD & GOLD Filtration media manufactured by Ferguson Waterworks, or Engineer & Owner-approved equal. Contractor to supply shop drawings for Engineer of Record (EOR) Review and approval prior to fabrication authorization.



**EXPANDED CLAY TIRE (ECT3) MEDIA:**

Description: Bold & Gold ECT filtration media is a biosorption-activated media (BAM) for stormwater treatment in conjunction with other structural or non-structural stormwater BMPs. Bold & Gold (B&G) filtration media is a patented product developed at the Stormwater Management Academy of the University of Central Florida.

1. Responsibility: The Contractor shall be responsible for the satisfactory delivery, stockpiling, installation, and maintenance of the ECT3 filtration media during construction based on information provided in the contract documents and as provided by the supplier. The ECT3 filtration media shall be purchased from an approved source.

Contact the local Ferguson Waterworks branch for pricing information. A certificate of authenticity to the engineer of record at the completion of the project can be provided. The certificate of authenticity includes the quantity of media delivered to the project site and certifies that CTS delivered meets the patent requirements of the University of Central Florida.

2. MATERIAL:

*Composition:* The ECT3 filtration media shall be manufactured with mineral materials and no organic materials. The final product shall have less than 2% passing US #200 (75-micron opening size) sieve. The media mix shall be composed of 75% expanded clay (lightweight aggregate of maximum aggregate size of  $\frac{3}{8}$  inches) and 25% sorption materials composed of recycled tire chip with no measurable metal contents. Percentages shall be determined by in-place volume.

Water passing through the media must not exhibit acute or chronic toxicity and not change the pH of the filtered water by more than 1.0 units. The material shall have a water-holding capacity of at least 5%, as measured by porosity, and a total porosity of 40%. The permeability as measured in the laboratory must be greater than 96 inches per hour at maximum compaction. Note that acute/chronic water toxicity or dramatic pH changes are not anticipated at this location.

*Storage and Handling:* the ECT3 filtration media is delivered pre-mixed and ready to install. Media shall not be stockpiled longer than 30 days before installation and must be covered to prevent separation of the material due to adverse weather and environmental conditions such as but not limited to rainfall and wind.

3. Construction: Delivery of the material: ECT3 filtration media is delivered to the job site pre-mixed and ready for installation. The delivered material is certified to meet the patent requirements and a certificate shall be issued as stated in sections 1 and 2 of this specification.

## FLOATING TREATMENT WETLANDS MATS

1. Terrestrial or aquatic vegetation can be planted and grown hydroponically in BioHaven® Floating Islands. Native vegetation is recommended:
  - Soft rush (*Juncus*) plantings to be utilized in the middle of the floating wetland island planting ports.
  - Pickerelweed (*Pontederia Cordata*) in the perimeter planting ports.
  - Plants to be a minimum of 12" high and 2" container, or equivalent.
  - A minimum of 80 percent survivability of all plantings in a 1-year period is required. If plant replacement is needed within the 1-year warranty period, the county will contact the contractor to perform plant replacement. The contractor shall not be held liable for "acts of God," such as damage due to severe storm events.
  - The quality of all plant material shall meet the Florida Grade No.1 Standard (or better), as governed in "Florida Grades and Standards for Nursery Plants 2015", as amended.
  - Plant Rooting: The buoyancy force of the planting mats is designed to overcome plant rooting force. Should plant rooting occur during low canal stages, the floating islands will break the rooting once the stages recover.
2. Care shall be taken when installing and anchoring BioHaven® floating islands in large lakes with high wind and wave energy. Consult Martin Ecosystems with specific questions or concerns.
3. Basic safety for personal protection is:
  - Wear long sleeves and/or gloves when handling to avoid skin scratching and abrasions.
  - Do not put or use near high heat or open flames.
4. Martin Ecosystems will refund the price of or replace, at its election, this product to the original purchaser, if it finds it to be defective in materials and or workmanship, provided the product has been used properly. Except as stated above, the company makes no warranty of damage caused by the owner modifying, attempting to fix, or otherwise altering the product from its original embodiment and no warranty of installation of product. This warranty lasts one (1) year from the date of original purchase.
5. The anchoring of the FTWs is necessary to stabilize the rafts and secure them into position to avoid rafts migrating downstream. Sufficient flexibility in the anchoring system is necessary to account for changes in water elevation.



Successfully providing our clients and the community with quality planning, engineering and surveying since 1980.

## Resource Benefit Calculations

*For:*

### Lake June-In-Winter Catfish Creek Best Management Practices (BMPs)

*Prepared for:*



## Highlands County Division of Natural Resources in Cooperation with SWFWMD

*Prepared by:*



AIM Engineering  
& Surveying, Inc.

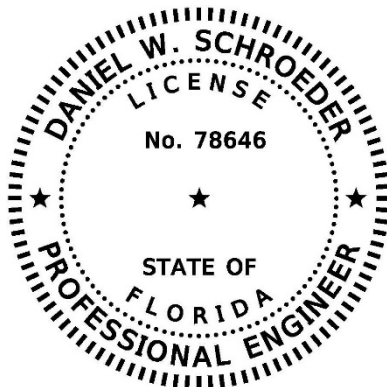

THIS ITEM HAS BEEN DIGITALLY  
SIGNED AND SEALED BY:

ON THE DATE ADJACENT TO THE SEAL

PRINTED COPIES OF THIS DOCUMENT ARE  
NOT CONSIDERED SIGNED AND SEALED  
AND THE SIGNATURE MUST BE VERIFIED  
ON ANY ELECTRONIC COPIES.

AIM ENGINEERING & SURVEYING, INC.  
2161 FOWLER ST., STE. 100  
FORT MYERS, FL. 33901  
CERTIFICATE OF AUTHORIZATION NO.: 3114  
DANIEL W. SCHROEDER, P.E. NO. 78646

June 30, 2023

## **TABLE OF CONTENTS**

|                                                        |    |
|--------------------------------------------------------|----|
| BACKGROUND .....                                       | 3  |
| APPROACH .....                                         | 3  |
| Existing Nutrient Loadings: .....                      | 3  |
| Nutrient Removal Efficiency: .....                     | 3  |
| CONCLUSIONS .....                                      | 3  |
| Nutrient Removal Summary: .....                        | 3  |
| Resource Benefit Analysis: .....                       | 3  |
| APPENDIX A – SUMMARY OF NUTRIENT REMOVAL ANALYSIS..... | 4  |
| Identify Stormwater Catchment Areas.....               | 4  |
| Nutrient Removal Results .....                         | 5  |
| Mean Annual Rainfall.....                              | 6  |
| Land Use Categories .....                              | 7  |
| BMP Trains 2020 Output .....                           | 9  |
| APPENDIX B – SUMMARY OF COST-BENEFIT ANALYSIS.....     | 27 |
| Engineer’s Opinion of Probable Cost: .....             | 27 |
| Cost-Benefit Analysis:.....                            | 27 |
| Maintenance Considerations:.....                       | 27 |

## **LIST OF FIGURES**

|                                                                               |   |
|-------------------------------------------------------------------------------|---|
| Figure 1. Contour map and watershed delineation. ....                         | 4 |
| Figure 2. Catfish Creek Watershed catchment area overview. ....               | 5 |
| Figure 3. Florida Meteorological Zones. ....                                  | 6 |
| Figure 4. Catfish Creek Watershed Rainfall Projections (inches per year)..... | 7 |
| Figure 5. Land Uses, Curve Numbers, and DCIA Percentages. ....                | 8 |

## **LIST OF TABLES**

|                                                            |    |
|------------------------------------------------------------|----|
| Table 1. Total yearly nutrient removal determination. .... | 6  |
| Table 2. EOPC summary for each BMP component.....          | 27 |
| Table 3. Summary of the Cost-Benefit Analysis.....         | 27 |

## **BACKGROUND**

Lake June-In-Winter is one of the largest lakes in the southern half of Highlands County, which includes a 5.8-square-mile lake area that receives much of its water from Lake Placid to the south via Catfish Creek Canal. This region is known for sharp elevation changes, which is not typical for much of Florida. With a growing population, there is an increasing volume of stormwater runoff containing nitrogen and phosphorus contaminants from fertilizers and other pollutants that impact water quality and human health.

AIM Engineering & Surveying (AIM) is tasked to provide design services for two Best Management Practice (BMP) components identified in a BMP Alternative Study prepared by HDR Engineering. The alternative study identified an approximate nutrient removal goal of 205 pounds per year (lbs/yr) for Total Nitrogen (TN) and 42 lbs/yr for Total Phosphorous (TP). Compared to other assessed BMP alternatives, Floating Treatment Wetlands (FTW) and Filter Boxes were identified as optimum BMP components to implement when considering the cost-to-benefit or cost-per-pounds-removed BMP ranking for this application.

## **APPROACH**

The BMP Trains (2020) software was utilized to model the anticipated nutrient removal performance of the BMP components. The Surface Discharge Filter and the User-Defined BMP Train model functions represented the Filter Box and the FTWs, respectively.

**Existing Nutrient Loadings:** The land use for each catchment area was determined from aerial photographs and input into BMP Trains to estimate the nutrient loading from contributing areas.

**Nutrient Removal Efficiency:** The Statewide Best Management Practice (BMP) Efficiencies for Crediting Projects in Basin Management Action Plans (BMAPs) and Alternative Restoration Plans (2021) report was referenced for the anticipated nutrient removal efficiency rates. Values were further refined through coordination and additional information from the manufacturer.

## **CONCLUSIONS**

**Nutrient Removal Summary:** The modeled BMP Trains 2020 results (**Appendix A**) indicate that the designed BMPs are projected to remove more than the targeted removal goals for the project:

| Description                 | Total Nitrogen        |                        |                       |                        | Total Phosphorous           |                        |                       |                        |           |
|-----------------------------|-----------------------|------------------------|-----------------------|------------------------|-----------------------------|------------------------|-----------------------|------------------------|-----------|
|                             | Nutrient Loading (kg) | Removal Efficiency (%) | Nutrient Removed (kg) | Nutrient Removed (lbs) | Nutrient Loading (kg)       | Removal Efficiency (%) | Nutrient Removed (kg) | Nutrient Removed (lbs) |           |
| FTW                         | 4838                  | 1.8%                   | 87                    | 192                    | 742                         | 1.7%                   | 13                    | 28                     |           |
| Filter Box                  | 331                   | 24%                    | 78                    | 171                    | 44                          | 24%                    | 10                    | 23                     |           |
| <b>TN Removed (lbs/yr):</b> |                       |                        |                       | <b>363</b>             | <b>TP Removed (lbs/yr):</b> |                        |                       |                        | <b>51</b> |

**Resource Benefit Analysis:** The summary of the resulting resource benefit analysis can be found in **Appendix B**. An Engineer's Opinion of Probable Cost (EOPC) was developed for each proposed BMP. The EOPC was then divided by the total calculated pounds removed per year to produce a cost-per-pound removed per year for the treatment systems:

| Description | EOPC       | Nutrients Removed per Year |          | Cost Benefit   |                |
|-------------|------------|----------------------------|----------|----------------|----------------|
|             |            | TN (lbs)                   | TP (lbs) | TN (\$/lbs/yr) | TP (\$/lbs/yr) |
| FTW         | \$ 19,425  | 192                        | 28       | \$101          | \$694          |
| Filter Box  | \$ 105,575 | 171                        | 23       | \$617          | \$4,590        |

## APPENDIX A – SUMMARY OF NUTRIENT REMOVAL ANALYSIS

### Identify Stormwater Catchment Areas

After an analysis of the geological contours of the Catfish Creek watershed (Figure 1), the catchment boundaries were modified to reflect existing flow conditions (Figure 2).

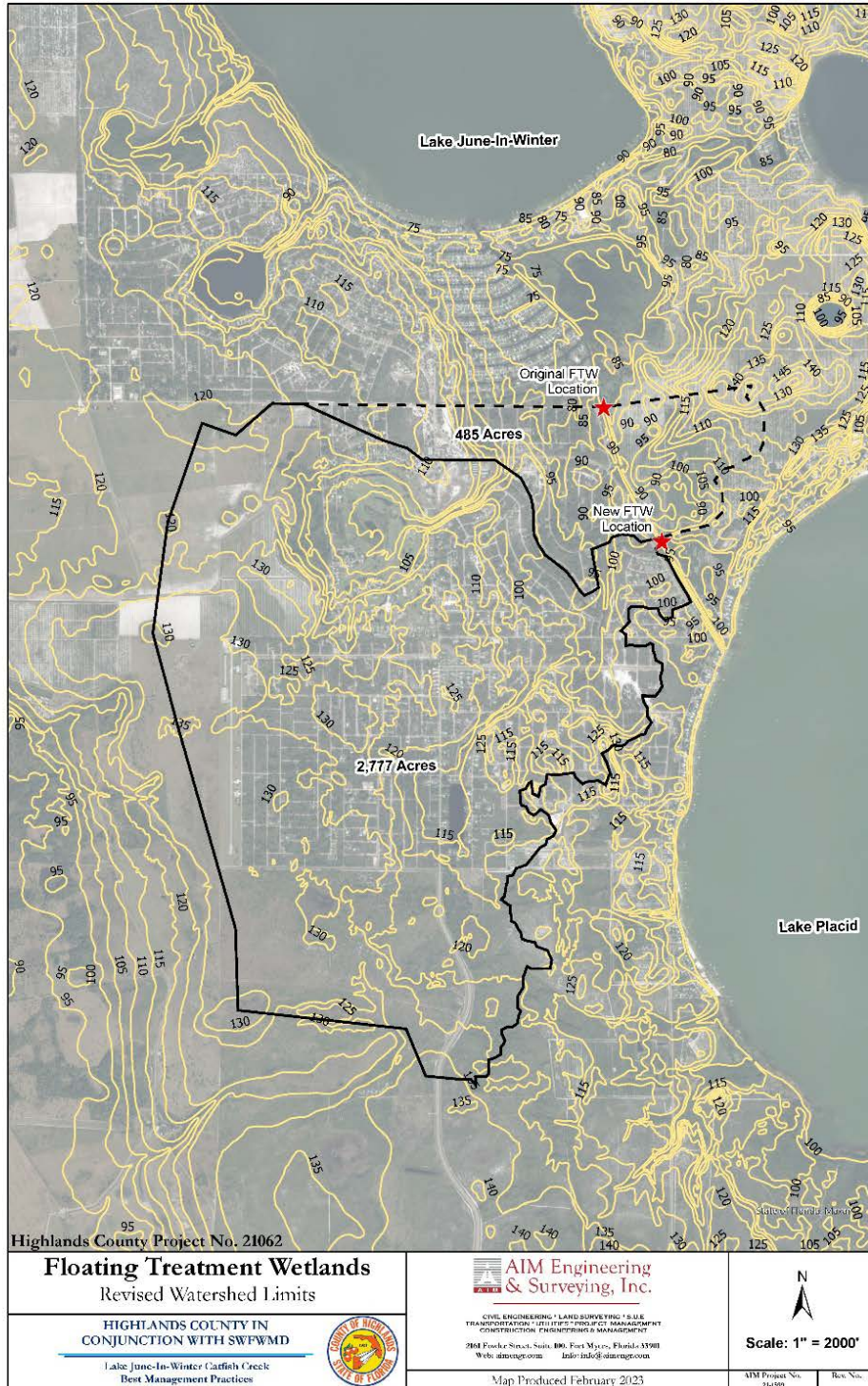

Figure 1. Contour map and watershed delineation.

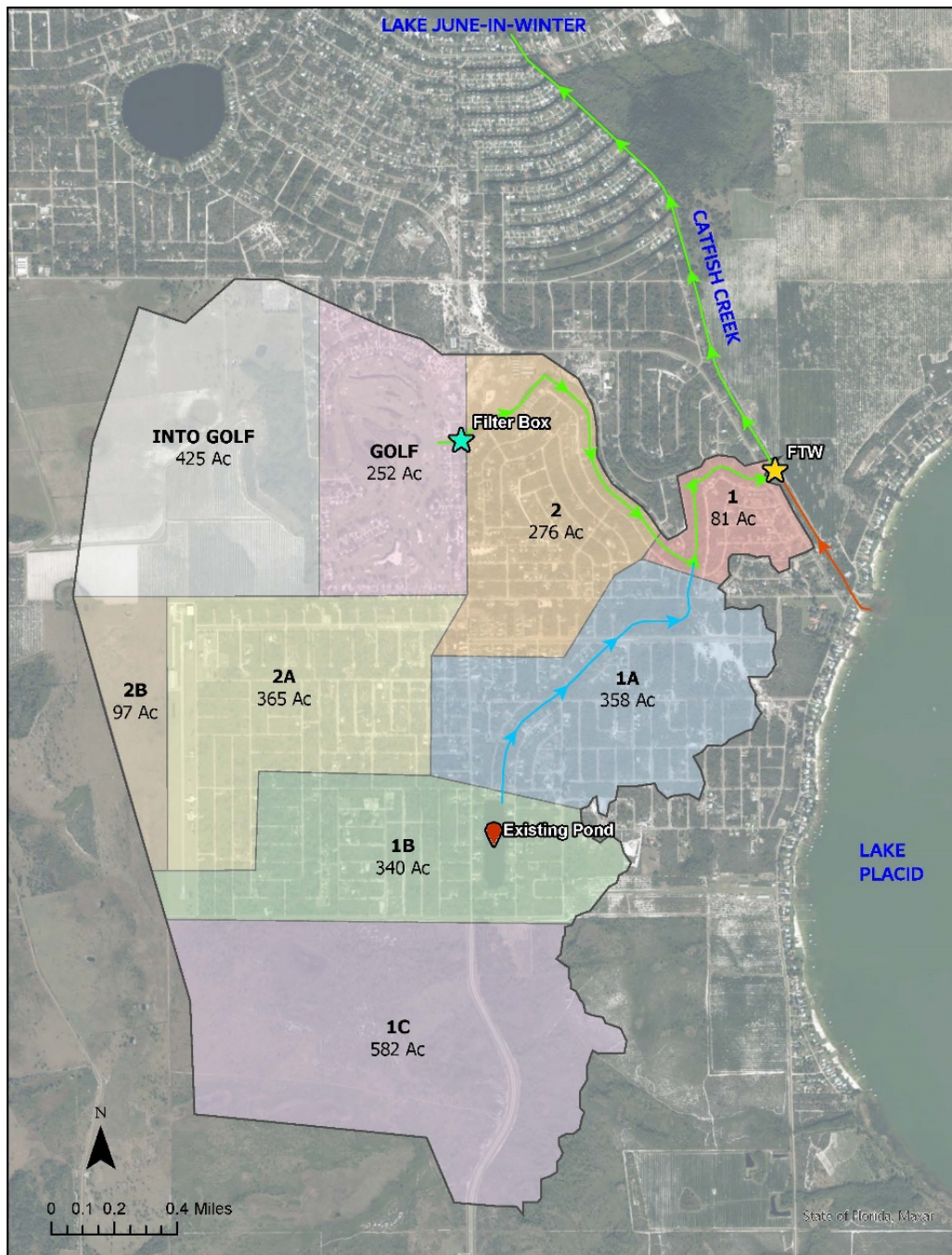

Figure 2. Catfish Creek Watershed catchment area overview.

### Nutrient Removal Results

Utilizing the existing nutrient loadings and anticipated nutrient removal efficiency rates, **Table 1** provides the anticipated pounds of nutrients removed by the BMP projects. **Appendix A** summarizes the BMP Trains nutrient removal calculations. The Filter Box results are outlined in Catchment 8, and the Floating Treatment Wetland results are summarized in Catchment 10.

Table 1. Total yearly nutrient removal determination.

| Description | Total Nitrogen        |                        |                       |                        | Total Phosphorous     |                        |                       |                        |
|-------------|-----------------------|------------------------|-----------------------|------------------------|-----------------------|------------------------|-----------------------|------------------------|
|             | Nutrient Loading (kg) | Removal Efficiency (%) | Nutrient Removed (kg) | Nutrient Removed (lbs) | Nutrient Loading (kg) | Removal Efficiency (%) | Nutrient Removed (kg) | Nutrient Removed (lbs) |
| FTW         | 4838                  | 1.8%                   | 87                    | 192                    | 742                   | 1.7%                   | 13                    | 28                     |
| Filter Box  | 331                   | 24%                    | 78                    | 171                    | 44                    | 24%                    | 10                    | 23                     |
|             | TN Removed (lbs/yr):  |                        |                       | <b>363</b>             | TP Removed (lbs/yr):  |                        |                       | <b>51</b>              |

**FTW Percent Removal Efficiency:** In the “Floating treatment wetland aided remediation of nitrogen and phosphorus from simulated stormwater runoff” 2013 report, FTWs were demonstrated to achieve TN removal rates of about 1 pound per square foot per year (lbs/sf/yr) and TP removal rates of 0.1-0.2 (lbs/sf/yr).

**Filter Box Percent Removal Efficiency:** The Nutrient Removing Filtration System (NRFS), or Filter Box, can provide nutrient removal efficiencies of up to 75% for Nitrogen and 95% for Phosphorous. However, from discussions with NRFS manufacturers, a 24% removal efficiency value was utilized to conservatively model the anticipated nutrient removal rate since stormwater flows can sometimes pass quickly through the biosorption-activated filtration media (such as Bold & Gold).

**Mean Annual Rainfall**

Rainfall is one of the main determinants of the amount of runoff in a watershed. BMP Trains 2020 includes an integrated map of Florida (Figure 3) that shows an average of 50 inches of rainfall per year for the project area (Figure 4).

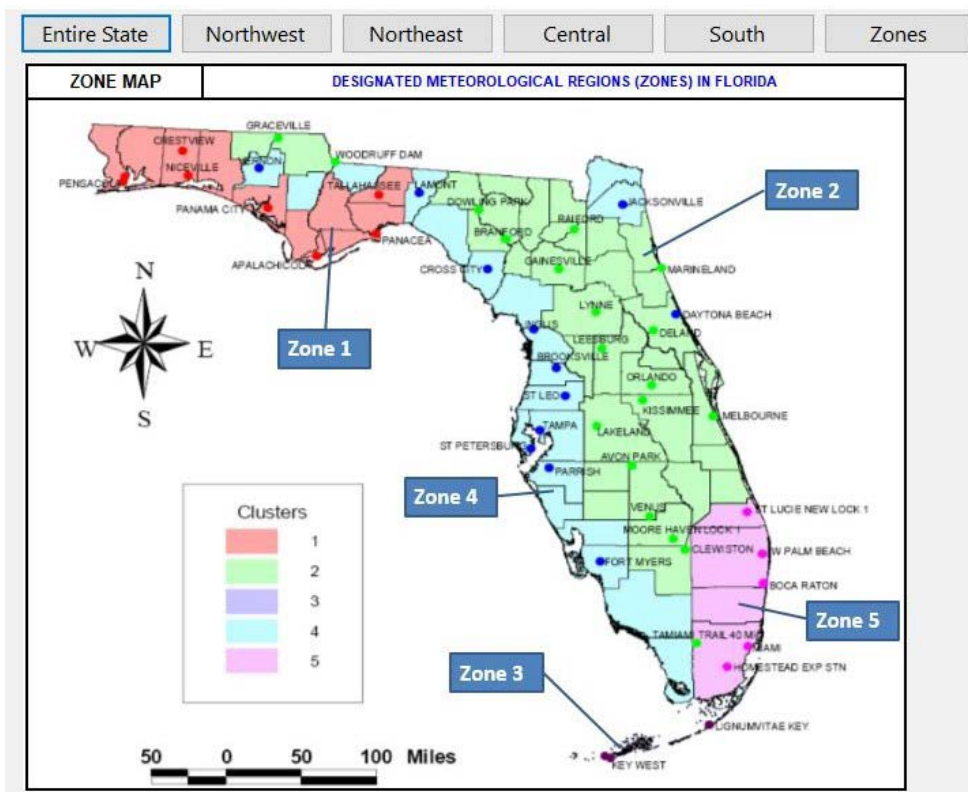

Figure 3. Florida Meteorological Zones.



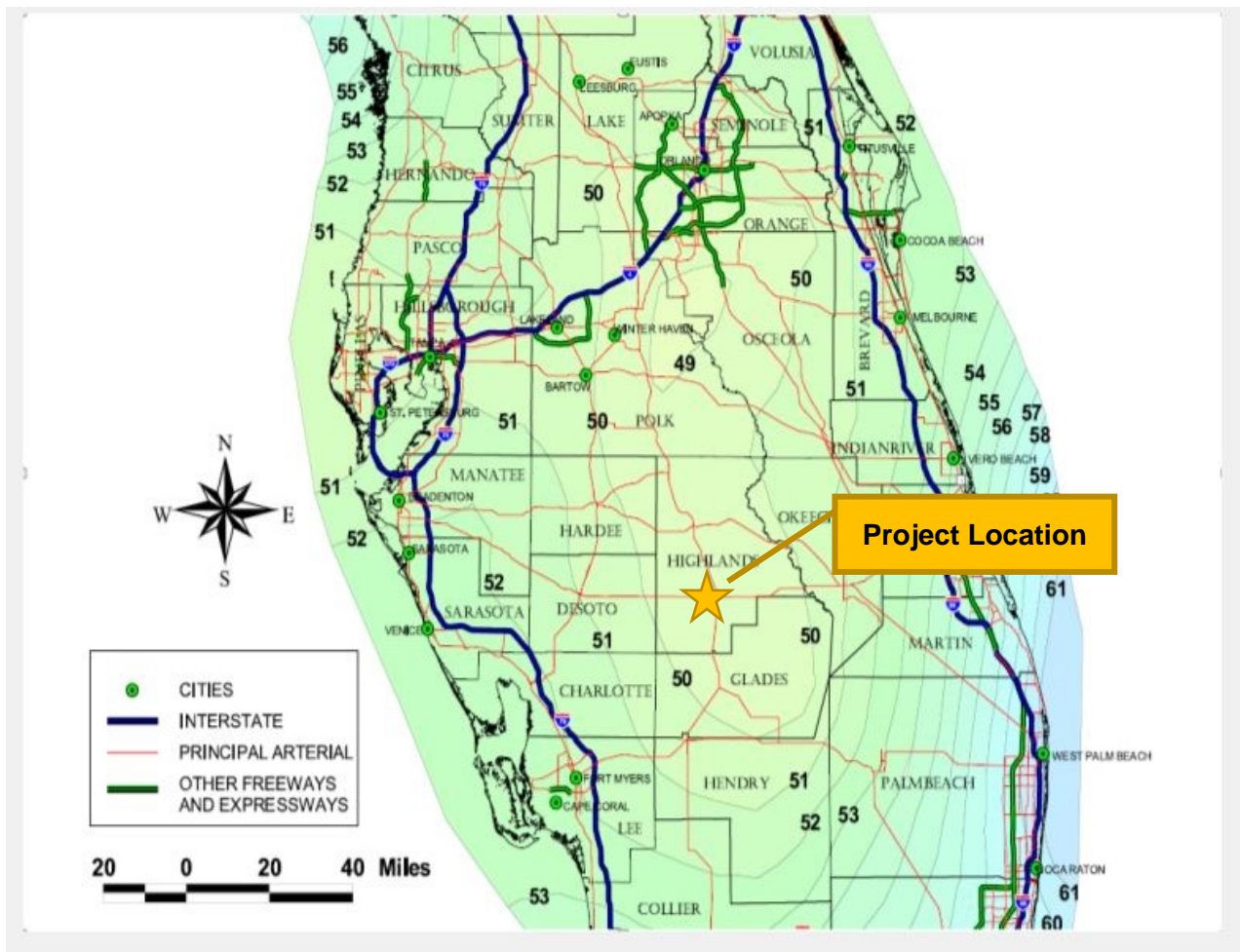

Figure 4. Catfish Creek Watershed Rainfall Projections (inches per year).

### **Land Use Categories**

Land Uses were determined by analyzing aerial photographs to understand and estimate the directly connected impervious areas (DCIA) that factor into runoff calculations. The BMP Trains 2020 manual states that golf courses are categorized as single-family residential with similar pollution patterns.

Curve numbers were derived from the soil groups referenced in the BMP Alternatives Analysis Lake June-in-Winter Watershed Protection Phase II Study. Some areas include agricultural (AG) land use within the watershed, which has less impervious surfaces but includes a substantially higher nutrient pollution (**Figure 5**).

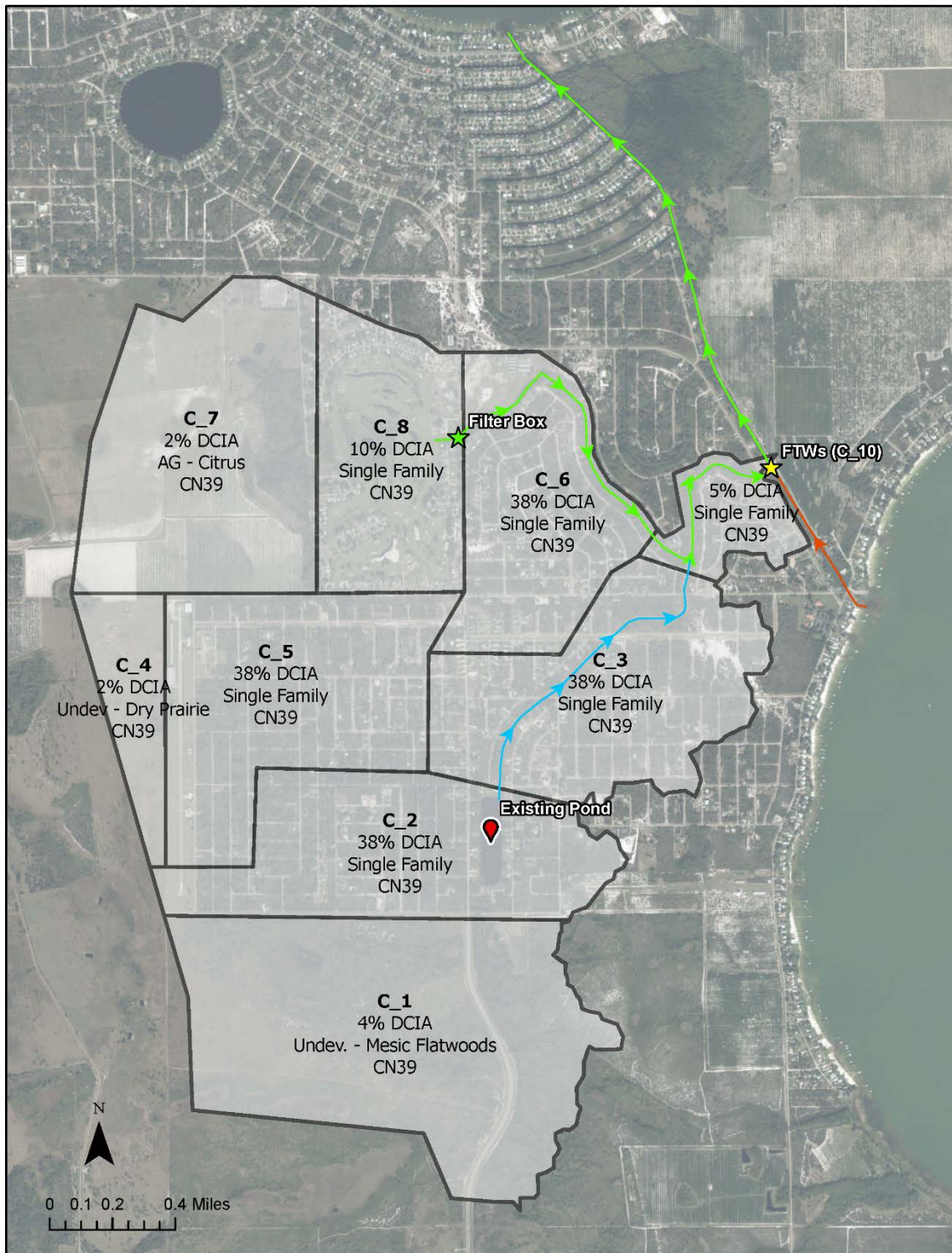

Figure 5. Land Uses, Curve Numbers, and DCIA Percentages.

**BMP Trains 2020 Output**

**Complete Report (not including cost) Ver 4.3.5**

Project: Lake June-in-Winter

Date: 5/9/2023 2:42:14 PM

**Site and Catchment Information**

Analysis: BMP Analysis

| Catchment Name       | 1C             | 1B             | 1A             | 2B             | 2A             | 2              | Into Golf      | Golf           | 1              | Floating Wetland |
|----------------------|----------------|----------------|----------------|----------------|----------------|----------------|----------------|----------------|----------------|------------------|
| Rainfall Zone        | Florida Zone 2 | Florida Zone 2 | Florida Zone 2 | Florida Zone 2 | Florida Zone 2 | Florida Zone 2 | Florida Zone 2 | Florida Zone 2 | Florida Zone 2 | Florida Zone 2   |
| Annual Mean Rainfall | 50.00          | 50.00          | 50.00          | 50.00          | 50.00          | 50.00          | 50.00          | 50.00          | 50.00          | 50.00            |

**Pre-Condition Landuse Information**

| Landuse                    | Undeveloped - Mesic Flatwoods: | Single-Family :      | Single-Family :      | Undeveloped - Dry Prairie: | Single-Family :      | Single-Family :      | Agricultural - Citrus: | Single-Family :      | Single-Family :      | User Defined Values |
|----------------------------|--------------------------------|----------------------|----------------------|----------------------------|----------------------|----------------------|------------------------|----------------------|----------------------|---------------------|
| Area (acres)               | 582.00                         | TN=2.070<br>TP=0.327 | TN=2.070<br>TP=0.327 | TN=2.025<br>TP=0.184       | TN=2.070<br>TP=0.327 | TN=2.070<br>TP=0.327 | TN=2.240<br>TP=0.183   | TN=2.070<br>TP=0.327 | TN=2.070<br>TP=0.327 | 0.01                |
| Rational Coefficient (0-1) | 0.04                           | 0.31                 | 0.31                 | 0.02                       | 0.31                 | 0.31                 | 0.02                   | 0.09                 | 0.05                 | 0.81                |
| Non DCIA Curve Number      | 39.00                          | 39.00                | 39.00                | 39.00                      | 39.00                | 39.00                | 39.00                  | 39.00                | 39.00                | 100.00              |

|                            |         |           |           |        |           |         |         |         |        |        |
|----------------------------|---------|-----------|-----------|--------|-----------|---------|---------|---------|--------|--------|
| DCIA                       |         |           |           |        |           |         |         |         |        |        |
| Percent (0-100)            | 4.00    | 38.00     | 38.00     | 2.00   | 38.00     | 38.00   | 2.00    | 10.00   | 5.00   | 100.00 |
| Nitrogen EMC (mg/l)        | 1.090   | 2.070     | 2.070     | 2.025  | 2.070     | 2.070   | 2.240   | 2.070   | 2.070  | 0.000  |
| Phosphorus EMC (mg/l)      | 0.043   | 0.327     | 0.327     | 0.184  | 0.327     | 0.327   | 0.183   | 0.327   | 0.327  | 0.000  |
| Runoff Volume (ac-ft/yr)   | 93.120  | 441.433   | 464.803   | 9.053  | 473.892   | 358.340 | 39.667  | 90.930  | 15.660 | 0.034  |
| Nitrogen Loading (kg/yr)   | 125.150 | 1,126.675 | 1,186.322 | 22.605 | 1,209.518 | 914.595 | 109.556 | 232.082 | 39.969 | 0.000  |
| Phosphorus Loading (kg/yr) | 4.937   | 177.982   | 187.405   | 2.054  | 191.069   | 144.479 | 8.950   | 36.662  | 6.314  | 0.000  |

### Post-Condition Landuse Information

| Landuse                    | Undeveloped - Mesic Flatwoods: | Single-Family: | Single-Family: | Undeveloped - Dry Prairie: | Single-Family: | Single-Family: | Agricultural - Citrus: | Single-Family: | Single-Family: | User Defined Values |
|----------------------------|--------------------------------|----------------|----------------|----------------------------|----------------|----------------|------------------------|----------------|----------------|---------------------|
| Area (acres)               | 582.00                         | 340.00         | 358.00         | 97.00                      | 365.00         | 276.00         | 425.00                 | 252.00         | 81.00          | 0.01                |
| Rational Coefficient (0-1) | 0.04                           | 0.31           | 0.31           | 0.02                       | 0.31           | 0.31           | 0.02                   | 0.09           | 0.05           | 0.81                |
| Non DCIA Curve Number      | 39.00                          | 39.00          | 39.00          | 39.00                      | 39.00          | 39.00          | 39.00                  | 39.00          | 39.00          | 100.00              |

|                               |         |           |           |        |           |         |         |         |        |        |
|-------------------------------|---------|-----------|-----------|--------|-----------|---------|---------|---------|--------|--------|
| DCIA<br>Percent (0-100)       | 4.00    | 38.00     | 38.00     | 2.00   | 38.00     | 38.00   | 2.00    | 10.00   | 5.00   | 100.00 |
| Wet<br>Pond<br>Area (ac)      | 0.00    | 12.00     | 0.00      | 0.00   | 0.00      | 0.00    | 0.00    | 12.00   | 0.00   | 0.00   |
| Nitrogen<br>EMC (mg/l)        | 1.090   | 2.070     | 2.070     | 2.025  | 2.070     | 2.070   | 2.240   | 2.070   | 2.070  | 0.000  |
| Phosphorus<br>EMC (mg/l)      | 0.043   | 0.327     | 0.327     | 0.184  | 0.327     | 0.327   | 0.183   | 0.327   | 0.327  | 0.000  |
| Runoff<br>Volume (ac-ft/yr)   | 93.120  | 425.853   | 464.803   | 9.053  | 473.892   | 358.340 | 39.667  | 86.600  | 15.660 | 0.034  |
| Nitrogen<br>Loading (kg/yr)   | 125.150 | 1,086.910 | 1,186.322 | 22.605 | 1,209.518 | 914.595 | 109.556 | 221.030 | 39.969 | 0.000  |
| Phosphorus<br>Loading (kg/yr) | 4.937   | 171.700   | 187.405   | 2.054  | 191.069   | 144.479 | 8.950   | 34.916  | 6.314  | 0.000  |

## Catchment Number: 1 Name: 1C

**Project:** Lake June-in-Winter

**Date:** 5/9/2023

**None Design**

### Watershed Characteristics

|                           |                |
|---------------------------|----------------|
| Catchment Area (acres)    | 582.00         |
| Contributing Area (acres) | 582.000        |
| Non-DCIA Curve Number     | 39.00          |
| DCIA Percent              | 4.00           |
| Rainfall Zone             | Florida Zone 2 |
| Rainfall (in)             | 50.00          |

**Surface Water Discharge**

Required TN Treatment Efficiency (%)

Provided TN Treatment Efficiency (%)

Required TP Treatment Efficiency (%)

Provided TP Treatment Efficiency (%)

**Media Mix Information**

Type of Media Mix Not Specified

Media N Reduction (%) 0.000

Media P Reduction (%) 0.000

**Load Diagram for None (stand-alone)**

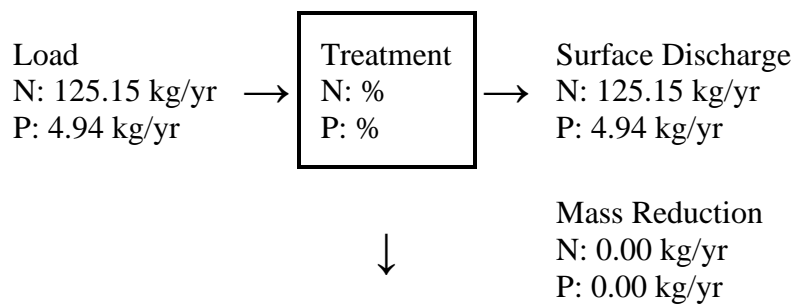

**Load Diagram for None (As Used In Routing)**

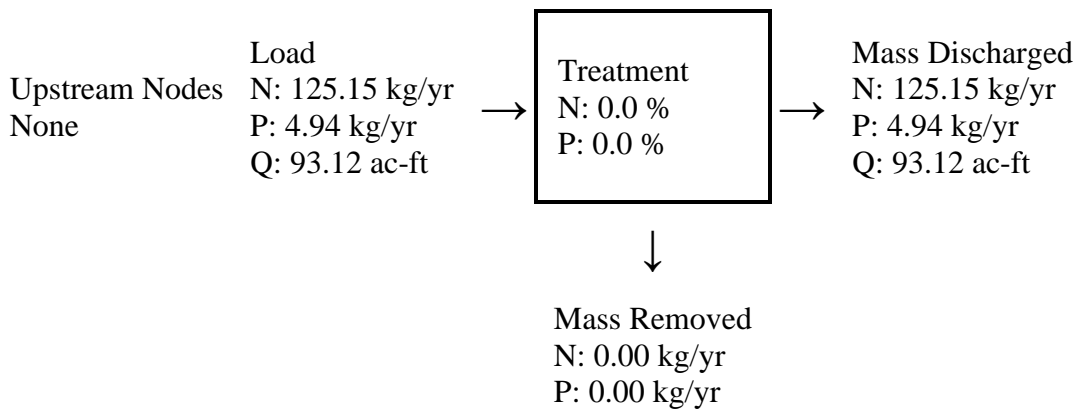

## Catchment Number: 2 Name: 1B

**Project:** Lake June-in-Winter

**Date:** 5/9/2023

### None Design

#### Watershed Characteristics

Catchment Area (acres) 340.00  
Contributing Area (acres) 328.000  
Non-DCIA Curve Number 39.00  
DCIA Percent 38.00  
Rainfall Zone Florida Zone 2  
Rainfall (in) 50.00

#### Surface Water Discharge

Required TN Treatment Efficiency (%)  
Provided TN Treatment Efficiency (%)  
Required TP Treatment Efficiency (%)  
Provided TP Treatment Efficiency (%)

#### Media Mix Information

Type of Media Mix Not Specified  
Media N Reduction (%) 0.000  
Media P Reduction (%) 0.000

### Load Diagram for None (stand-alone)

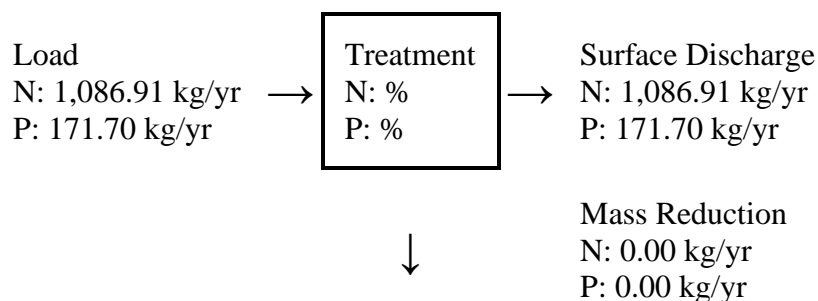

## Load Diagram for None (As Used In Routing)

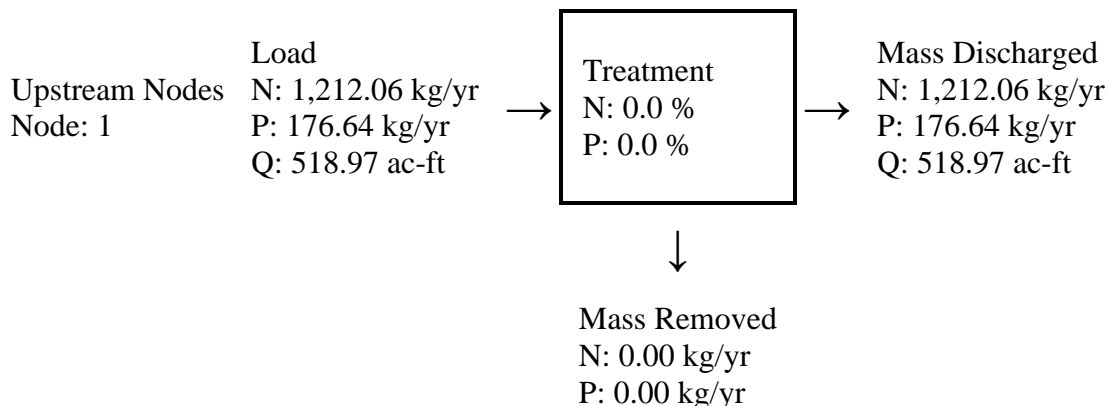

### Catchment Number: 3 Name: 1A

**Project:** Lake June-in-Winter

**Date:** 5/9/2023

#### None Design

#### Watershed Characteristics

|                           |                |
|---------------------------|----------------|
| Catchment Area (acres)    | 358.00         |
| Contributing Area (acres) | 358.000        |
| Non-DCIA Curve Number     | 39.00          |
| DCIA Percent              | 38.00          |
| Rainfall Zone             | Florida Zone 2 |
| Rainfall (in)             | 50.00          |

#### Surface Water Discharge

|                                      |  |
|--------------------------------------|--|
| Required TN Treatment Efficiency (%) |  |
| Provided TN Treatment Efficiency (%) |  |
| Required TP Treatment Efficiency (%) |  |
| Provided TP Treatment Efficiency (%) |  |

#### Media Mix Information

|                       |               |
|-----------------------|---------------|
| Type of Media Mix     | Not Specified |
| Media N Reduction (%) | 0.000         |
| Media P Reduction (%) | 0.000         |



### Load Diagram for None (stand-alone)

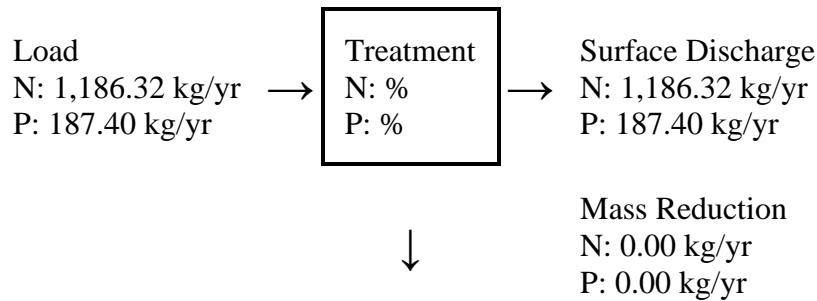

### Load Diagram for None (As Used In Routing)

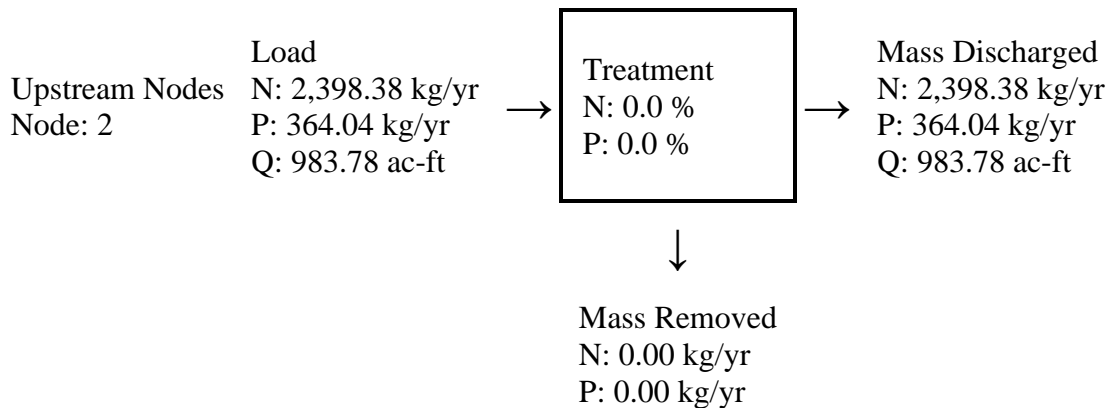

### Catchment Number: 4 Name: 2B

**Project:** Lake June-in-Winter  
**Date:** 5/9/2023

#### None Design

#### Watershed Characteristics

|                           |                |
|---------------------------|----------------|
| Catchment Area (acres)    | 97.00          |
| Contributing Area (acres) | 97.000         |
| Non-DCIA Curve Number     | 39.00          |
| DCIA Percent              | 2.00           |
| Rainfall Zone             | Florida Zone 2 |
| Rainfall (in)             | 50.00          |

### Surface Water Discharge

Required TN Treatment Efficiency (%)

Provided TN Treatment Efficiency (%)

Required TP Treatment Efficiency (%)

Provided TP Treatment Efficiency (%)

### Media Mix Information

Type of Media Mix Not Specified

Media N Reduction (%) 0.000

Media P Reduction (%) 0.000

### Load Diagram for None (stand-alone)

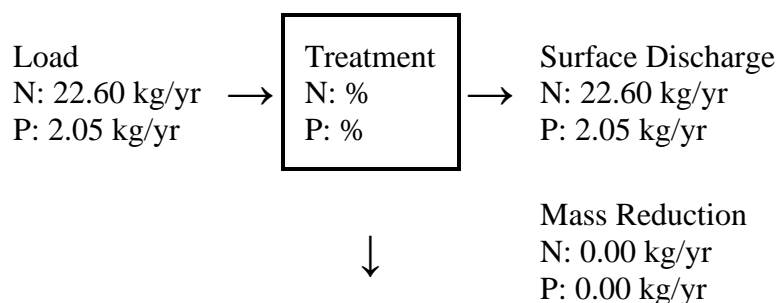

### Load Diagram for None (As Used In Routing)

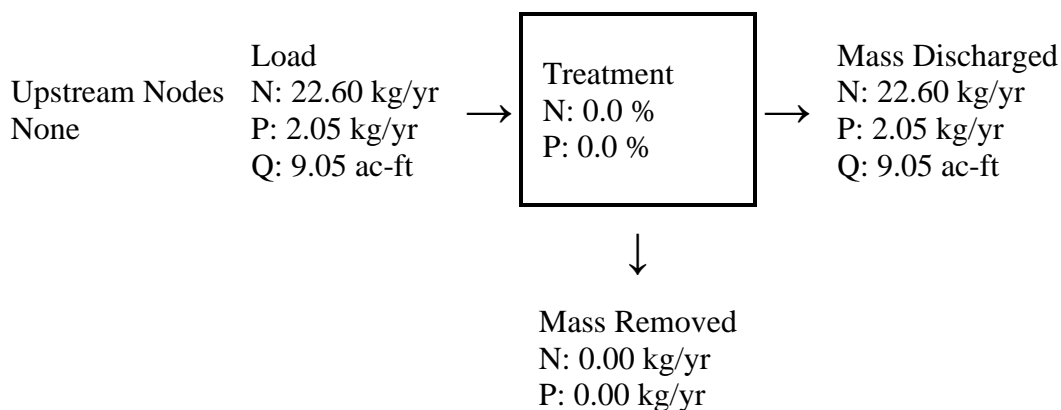

## Catchment Number: 5 Name: 2A

**Project:** Lake June-in-Winter

**Date:** 5/9/2023

### None Design

#### Watershed Characteristics

Catchment Area (acres) 365.00  
Contributing Area (acres) 365.000  
Non-DCIA Curve Number 39.00  
DCIA Percent 38.00  
Rainfall Zone Florida Zone 2  
Rainfall (in) 50.00

#### Surface Water Discharge

Required TN Treatment Efficiency (%)  
Provided TN Treatment Efficiency (%)  
Required TP Treatment Efficiency (%)  
Provided TP Treatment Efficiency (%)

#### Media Mix Information

Type of Media Mix Not Specified  
Media N Reduction (%) 0.000  
Media P Reduction (%) 0.000

### Load Diagram for None (stand-alone)

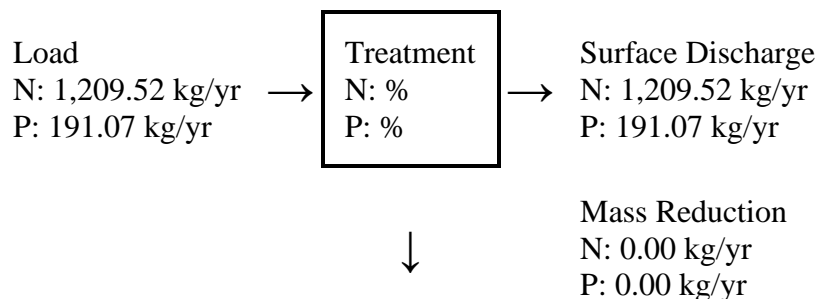

## Load Diagram for None (As Used In Routing)

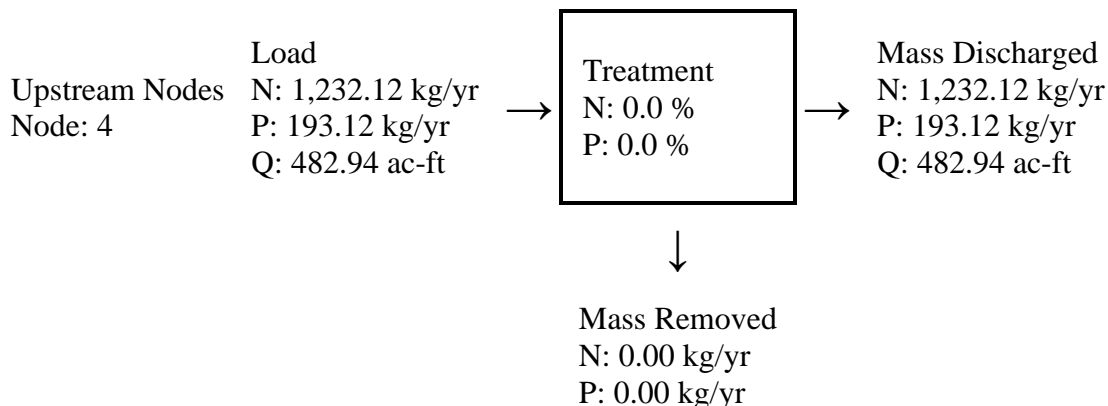

### Catchment Number: 6 Name: 2

**Project:** Lake June-in-Winter

**Date:** 5/9/2023

### None Design

#### Watershed Characteristics

Catchment Area (acres) 276.00  
Contributing Area (acres) 276.000  
Non-DCIA Curve Number 39.00  
DCIA Percent 38.00  
Rainfall Zone Florida Zone 2  
Rainfall (in) 50.00

#### Surface Water Discharge

Required TN Treatment Efficiency (%)  
Provided TN Treatment Efficiency (%)  
Required TP Treatment Efficiency (%)  
Provided TP Treatment Efficiency (%)

#### Media Mix Information

Type of Media Mix Not Specified  
Media N Reduction (%) 0.000  
Media P Reduction (%) 0.000

### Load Diagram for None (stand-alone)

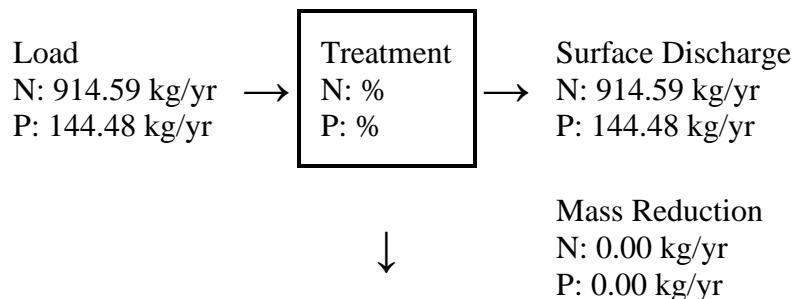

### Load Diagram for None (As Used In Routing)

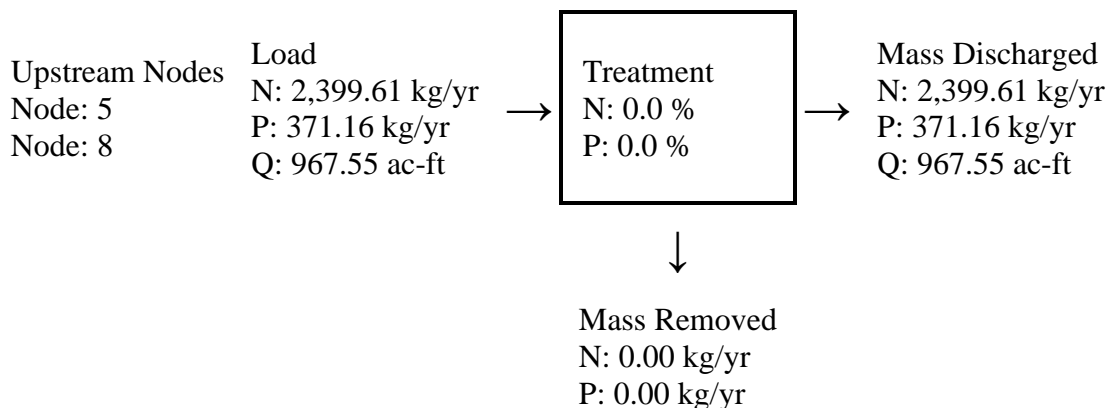

### Catchment Number: 7 Name: Into Golf

**Project:** Lake June-in-Winter  
**Date:** 5/9/2023

#### None Design

#### Watershed Characteristics

|                           |                |
|---------------------------|----------------|
| Catchment Area (acres)    | 425.00         |
| Contributing Area (acres) | 425.000        |
| Non-DCIA Curve Number     | 39.00          |
| DCIA Percent              | 2.00           |
| Rainfall Zone             | Florida Zone 2 |
| Rainfall (in)             | 50.00          |

**Surface Water Discharge**

Required TN Treatment Efficiency (%)  
 Provided TN Treatment Efficiency (%)  
 Required TP Treatment Efficiency (%)  
 Provided TP Treatment Efficiency (%)

**Media Mix Information**

Type of Media Mix Not Specified  
 Media N Reduction (%) 0.000  
 Media P Reduction (%) 0.000

**Load Diagram for None (stand-alone)**

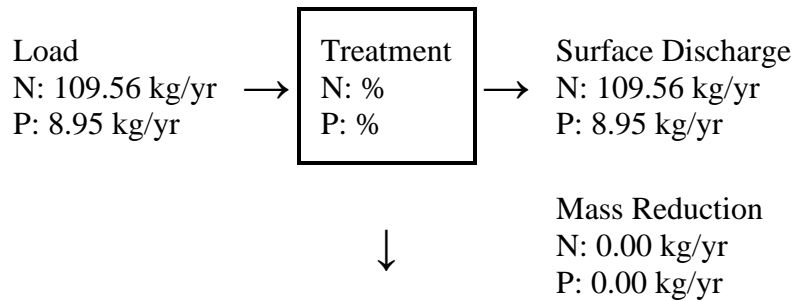

**Load Diagram for None (As Used In Routing)**

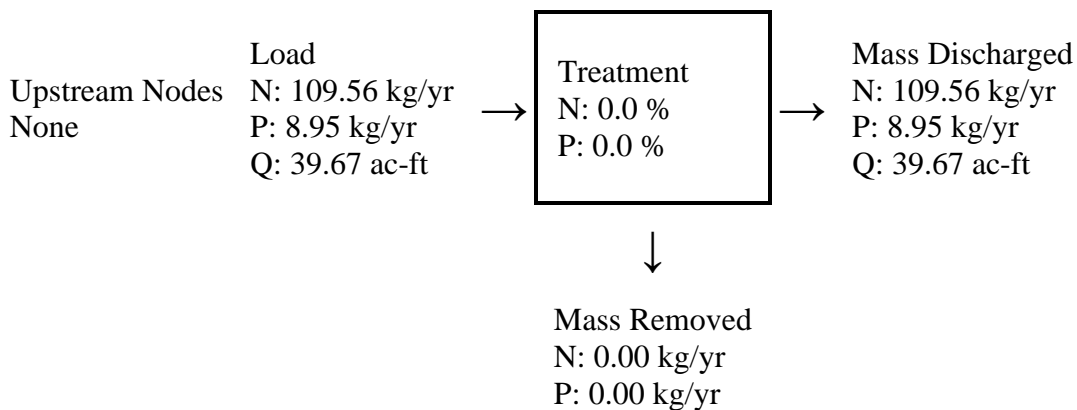

## Catchment Number: 8 Name: Golf

**Project:** Lake June-in-Winter

**Date:** 5/9/2023

### Surface Discharge Filtration Design

|                                  |          |
|----------------------------------|----------|
| Treatment Depth (in)             | 0.15     |
| Hydraulic Capture Efficiency (%) | 52       |
| Media Type                       | B&G ECT3 |
| Media N Reduction (%)            | 45       |
| Media P Reduction (%)            | 45       |

### Watershed Characteristics

|                           |                |
|---------------------------|----------------|
| Catchment Area (acres)    | 252.00         |
| Contributing Area (acres) | 240.000        |
| Non-DCIA Curve Number     | 39.00          |
| DCIA Percent              | 10.00          |
| Rainfall Zone             | Florida Zone 2 |
| Rainfall (in)             | 50.00          |

### Surface Water Discharge

|                                      |    |
|--------------------------------------|----|
| Required TN Treatment Efficiency (%) |    |
| Provided TN Treatment Efficiency (%) | 24 |
| Required TP Treatment Efficiency (%) |    |
| Provided TP Treatment Efficiency (%) | 24 |

### Media Mix Information

|                       |          |
|-----------------------|----------|
| Type of Media Mix     | B&G ECT3 |
| Media N Reduction (%) | 45       |
| Media P Reduction (%) | 45       |

### Load Diagram for Surface Discharge Filtration (stand-alone)

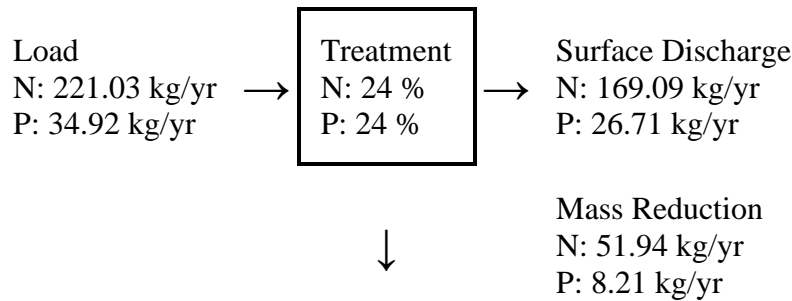

### Load Diagram for Filtration (As Used In Routing)

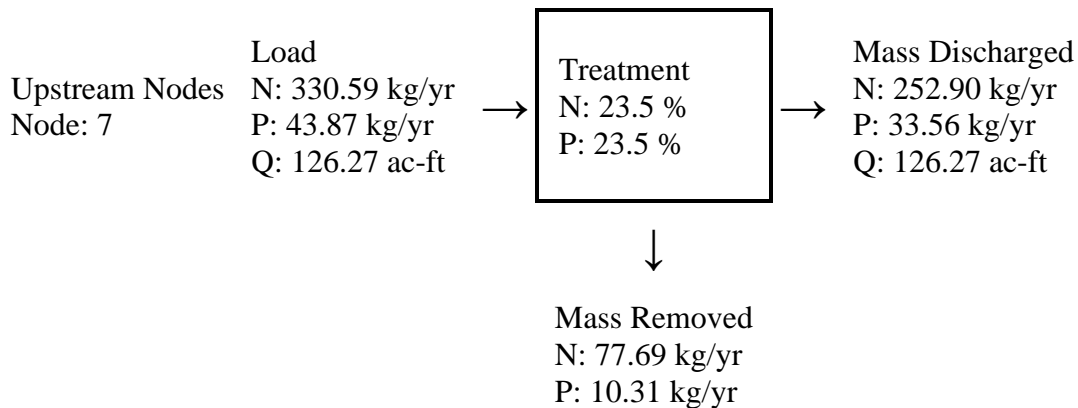

### Catchment Number: 9 Name: 1

**Project:** Lake June-in-Winter

**Date:** 5/9/2023

**None Design**

#### Watershed Characteristics

|                           |                |
|---------------------------|----------------|
| Catchment Area (acres)    | 81.00          |
| Contributing Area (acres) | 81.000         |
| Non-DCIA Curve Number     | 39.00          |
| DCIA Percent              | 5.00           |
| Rainfall Zone             | Florida Zone 2 |
| Rainfall (in)             | 50.00          |



### Surface Water Discharge

Required TN Treatment Efficiency (%)  
Provided TN Treatment Efficiency (%)  
Required TP Treatment Efficiency (%)  
Provided TP Treatment Efficiency (%)

### Media Mix Information

Type of Media Mix Not Specified  
Media N Reduction (%) 0.000  
Media P Reduction (%) 0.000

### Load Diagram for None (stand-alone)

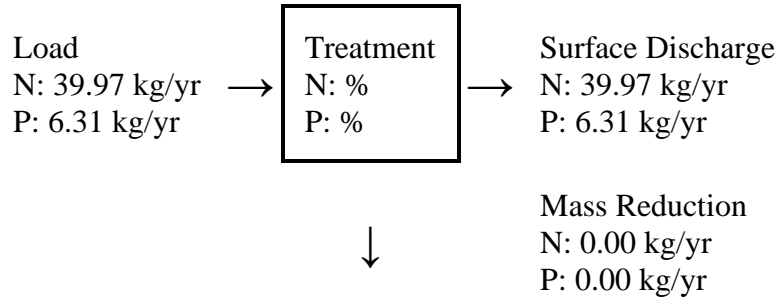

### Load Diagram for None (As Used In Routing)

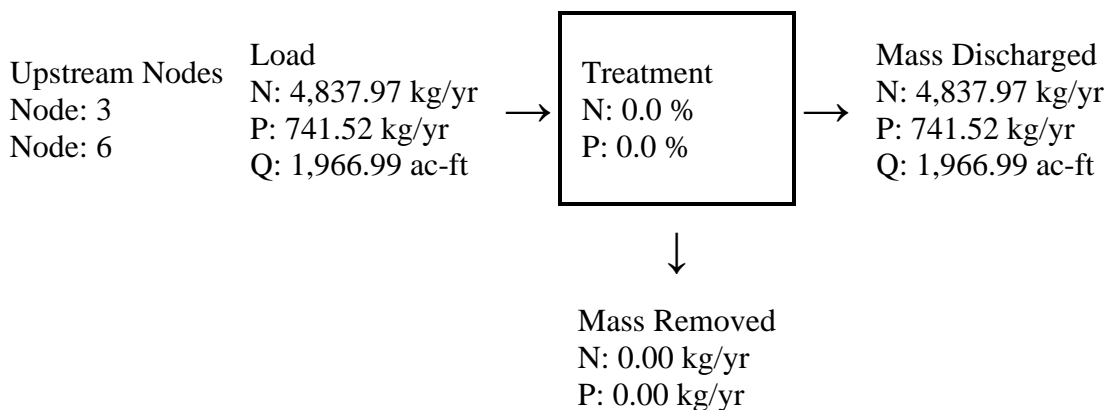

## Catchment Number: 10 Name: Floating Wetland

**Project:** Lake June-in-Winter

**Date:** 5/9/2023

### User Defined BMP Design

Contributing Catchment Area (acres) 0.010

Provided Nitrogen Treatment Efficiency (%) 2

Provided Phosphorus Treatment Efficiency (%) 2

### Watershed Characteristics

Catchment Area (acres) 0.01

Contributing Area (acres) 0.010

Non-DCIA Curve Number 100.00

DCIA Percent 100.00

Rainfall Zone Florida Zone 2

Rainfall (in) 50.00

### Surface Water Discharge

Required TN Treatment Efficiency (%)

Provided TN Treatment Efficiency (%) 2

Required TP Treatment Efficiency (%)

Provided TP Treatment Efficiency (%) 2

### Media Mix Information

Type of Media Mix Not Specified

Media N Reduction (%)

Media P Reduction (%)

### Load Diagram for User Defined BMP (stand-alone)

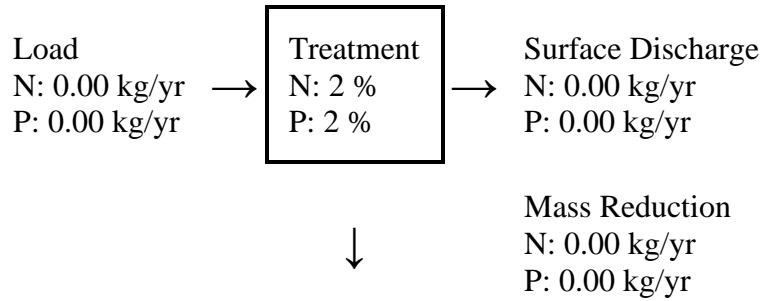

### Load Diagram for User Defined BMP (As Used In Routing)

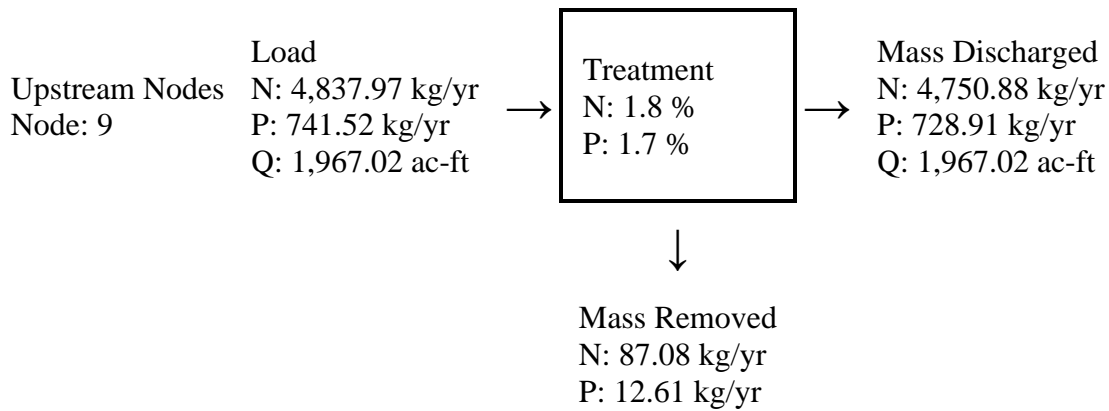

## Summary Treatment Report Version: 4.3.5

Project: Lake June-in-Winter

**Analysis Type:** BMP Analysis

Date:5/9/2023

### BMP Types:

Catchment 1 - (1C) None  
Catchment 2 - (1B) None  
Catchment 3 - (1A) None  
Catchment 4 - (2B) None  
Catchment 5 - (2A) None  
Catchment 6 - (2) None  
Catchment 7 - (Into Golf) None  
Catchment 8 - (Golf) Surface

### Discharge Filtration

Catchment 9 - (1) None  
Catchment 10 - (Floating Wetland)

### User Defined BMP

Based on % removal values to the  
nearest percent

### Routing Summary

Catchment 1 Routed to Catchment 2  
Catchment 2 Routed to Catchment 3  
Catchment 3 Routed to Catchment 9  
Catchment 4 Routed to Catchment 5  
Catchment 5 Routed to Catchment 6  
Catchment 6 Routed to Catchment 9  
Catchment 7 Routed to Catchment 8  
Catchment 8 Routed to Catchment 6  
Catchment 9 Routed to Catchment 10  
Catchment 10 Routed to Outlet

## Summary Report

### Nitrogen

#### Surface Water Discharge

|                           |               |                |
|---------------------------|---------------|----------------|
| Total N post load         | 4915.66 kg/yr |                |
| Percent N load reduction  | 3 %           |                |
| Provided N discharge load | 4750.88 kg/yr | 10475.69 lb/yr |
| Provided N load removed   | 164.77 kg/yr  | 363.33 lb/yr   |

### Phosphorus

#### Surface Water Discharge

|                           |               |               |
|---------------------------|---------------|---------------|
| Total P post load         | 751.825 kg/yr |               |
| Percent P load reduction  | 3 %           |               |
| Provided P discharge load | 728.91 kg/yr  | 1607.25 lb/yr |
| Provided P load removed   | 22.915 kg/yr  | 50.527 lb/yr  |

## APPENDIX B – SUMMARY OF COST-BENEFIT ANALYSIS

### **Engineer’s Opinion of Probable Cost:**

An Engineer’s Opinion of Probable Cost (EOPC) was developed for each proposed BMPs by refining the costs identified in the HDR report through coordination with material suppliers and BMP vendors. Additional costs were also considered for site construction, including general requirements, mobilization, maintenance of traffic, erosion control, clearing and demolition, and earthwork, which will be required to implement the proposed BMPs (**Table 2**).

*Table 2. EOPC summary for each BMP component.*

|                                                       |                      |
|-------------------------------------------------------|----------------------|
| Nutrient Removing Stormwater Filter Box Subtotal EOPC | \$ 105,575.00        |
| Floating Treatment Wetlands (5x) Subtotal EOPC        | \$ 19,425.00         |
| <b>Total EOPC:</b>                                    | <b>\$ 125,000.00</b> |

### **Cost-Benefit Analysis:**

The EOPC for each BMP component was then divided by the total calculated proposed pounds removed by each BMP element to produce the cost-per-pound removed benefit analysis for the treatment systems (**Table 3**).

*Table 3. Summary of the Cost-Benefit Analysis.*

| Description       | EOPC      | Nutrients Removed per Year |          | Cost Benefit   |                |
|-------------------|-----------|----------------------------|----------|----------------|----------------|
|                   |           | TN (lbs)                   | TP (lbs) | TN (\$/lbs/yr) | TP (\$/lbs/yr) |
| <b>FTW</b>        | \$ 19,425 | 192                        | 28       | \$101          | \$694          |
| <b>Filter Box</b> | \$105,575 | 171                        | 23       | \$617          | \$4,590        |

### **Maintenance Considerations:**

**Filter Box:** The life cycle for the biosorption-activated filtration media (Bold & Gold) in the filter box is notably different for nitrogen than for phosphorus. For TN removal, Bold & Gold can theoretically continually remove TN without replacing the media as the media continuously consumes TN. On the contrary, phosphorus binds to the media and eventually limits the media’s ability to remove TP. The media may need to be replaced every 1-6 months to continue meeting the estimated TP removal efficiency. However, a conservative nutrient removal efficiency rating of 24% was utilized. Although not a part of the scope or funding for this project, it is recommended to collect yearly upstream and downstream water quality samples to review the TP nutrient removal efficiency of the filtration media to determine if the media requires replacement.

**Floating Treatment Wetlands:** Yearly inspection of the FTWs is also recommended to review the health of the plantings and ensure the desired nutrient removal efficiency (upstream & downstream water quality sampling).

## Southwest Florida Water Management District Cooperative Funding Initiative (CFI) Project Agreement (Type 1-3)

This Agreement, including any exhibits referenced, attached, or incorporated herein (Agreement) is entered into by and between the Southwest Florida Water Management District (District), 2379 Broad Street, Brooksville, Florida 34604, and the Cooperator named below.

### Project Information

Cooperator Name: Highlands County  
 Cooperator Address: 600 South Commerce Avenue  
Sebring, Florida 33807-3867  
 Project Number: Q298  
 Project Name: Lake June-in-Winter Catfish Creek BMPs  
 Entity Type: Public  
 Project Description: This Project consists of design, permitting and construction of stormwater BMPs in Catfish Creek to improve water quality in Lake June-In-Winter, a Lake Wales Ridge Lake.  
 Electronic Signature: Yes

### Funding/Agreement Information

|                                 |                  |                            |                                  |
|---------------------------------|------------------|----------------------------|----------------------------------|
| Effective Date:                 | <u>10/1/2021</u> | Expiration Date:           | <u>12/31/2025</u>                |
| Type/Risk Level (1-3):          | <u>Type 3</u>    | O&M Expiration Date:       |                                  |
| Anticipated Total Project Cost: | <u>\$260,000</u> | Multi-Year Funded Project: | <u>Yes</u>                       |
| District's Maximum Share:       | <u>\$195,000</u> | Funding Approved:          | FY: <u>2022</u> <u>\$116,250</u> |
|                                 |                  | District Funding:          | <u>75%</u>                       |
| State Funding:                  | <u>No</u>        | CSFA #:                    | Title: _____                     |
| Federal Funding:                | <u>No</u>        | CFDA #:                    | Title: _____                     |
| Cooperator's Total Share:       | <u>\$65,000</u>  | Land Acquisition Cost:     | <u>No</u>                        |
| Third Party Review:             | <u>No</u>        | Conservation Easement:     | <u>No</u>                        |

### Party Contacts

#### District Contract Manager

Name: Nancy Norton, Senior Professional Engineer  
 Address: 7601 U.S. 301 North (Fort King Highway)  
Tampa, Florida 33637  
 Phone: 1-800-423-1476 x2203  
 Email: nancy.norton@swfwmd.state.fl.us

#### Cooperator Project Manager

Name: Dawn Ritter  
 Address: 4344 George Boulevard.  
Sebring, Florida 33875  
 Phone: 863 402 6525  
 Email: dritter@highlandsfl.gov

APPENDIX E

The Parties agree to comply with the terms and conditions of the following checked exhibits and attachments, which are incorporated herein by reference:

|   |                                                                                                                                                       |
|---|-------------------------------------------------------------------------------------------------------------------------------------------------------|
| X | Exhibit A - CFI Standard Terms and Conditions (Public Cooperator)                                                                                     |
|   | Exhibit A - CFI Standard Terms and Conditions (Private Cooperator)                                                                                    |
|   | Exhibit B - CFI Special Terms and Conditions – Standard Construction, Restoration, or Conservation with Construction                                  |
| X | Exhibit B - CFI Special Terms and Conditions – Construction (Water Quality/Flood Protection)                                                          |
|   | Exhibit B - CFI Special Terms and Conditions – Construction (Reclaimed Water)                                                                         |
|   | Exhibit B - CFI Special Terms and Conditions – Construction (Aquifer Storage & Recovery and Recharge)                                                 |
|   | Exhibit B - CFI Special Terms and Conditions – Non-Construction (Study, Conservation, Watershed Management Plan, or Third-Party Review {design only}) |
|   | Exhibit B - CFI Special Terms and Conditions – Construction/Non-Construction (Septic to Sewer)                                                        |
| X | Exhibit C - Project Plan                                                                                                                              |
|   | Exhibit D - State Funding Terms and Conditions                                                                                                        |
|   | Exhibit E - Federal Funding Terms and Conditions                                                                                                      |
|   | Exhibit F - Special Audit Requirements                                                                                                                |
|   | Exhibit G - Miscellaneous                                                                                                                             |
|   | Additional Exhibits (if necessary)                                                                                                                    |
| X | Attachment 1 - Contingency Funds Justification Form                                                                                                   |
| X | Attachment 2 - Minority/Women Owned and Small Business Utilization Report Form                                                                        |
|   | Attachment 3 - Sample Conservation Easement                                                                                                           |
| X | Attachment 4 - Cooperative Funding Agreement Checklist                                                                                                |
|   | Additional Attachments (if necessary)                                                                                                                 |

IN WITNESS WHEREOF, the parties hereto, or their lawful representatives, have executed this Agreement on the day and year set forth next to their signatures below.

Southwest Florida Water Management District

By: \_\_\_\_\_  
 Name: \_\_\_\_\_ Date: \_\_\_\_\_  
 Title: \_\_\_\_\_

Highlands County

By: \_\_\_\_\_  
 Name: \_\_\_\_\_ Date: \_\_\_\_\_  
 Title: \_\_\_\_\_  
 Additional signatures attached on separate page

Exhibit A  
Southwest Florida Water Management District  
Standard Terms and Conditions  
Public Cooperator

1. Project Contacts and Notices.

The individuals identified in the CFI Project Agreement are the prime contacts for matters relating to this Agreement. Each party shall provide notice to the other party of any changes to the prime contact information. All notices under this Agreement shall be in writing to the other party's prime contact and shall be sent by email or overnight mail, except for cure and default notices which shall be sent by certified mail. Unless otherwise indicated in this Agreement, reports may be provided by email. Notices and reports are effective upon receipt. Any notice or report delivered by email shall request a receipt thereof confirmed by email or in writing by the recipient and the effective date shall be the date of receipt, provided such receipt has been confirmed by the recipient.

2. Contact Authority.

The Cooperator's Project Manager is authorized to affirm the invoice certification required by this Agreement. The District's Contract Manager is authorized to approve requests to extend a Project task deadline or to adjust a line item amount of the Project Budget. The District's Contract Manager is not authorized to approve any time extension that will extend a Project task beyond the expiration date of this Agreement or which will result in a change to the total Project cost or the parties' funding shares as identified in the CFI Project Agreement. Changes authorized by this Paragraph do not require a formal written amendment but must be in writing and signed in accordance with each party's signature authority.

3. Agreement Term.

The effective date of this Agreement is identified in the CFI Project Agreement. The expiration date is the date identified in the CFI Project Agreement, or upon the satisfactory completion of the Project and subsequent final reimbursement to the Cooperator, whichever occurs first. If Exhibit B requires the Cooperator to operate and maintain the Project after its completion, the operation and maintenance obligation shall survive the above-referenced expiration date for 20 years, beginning on the date provided in Exhibit B. The Cooperator is not eligible for reimbursement for any Project work conducted or costs incurred prior to the effective date of this Agreement.

4. Scope of Work.

The Cooperator shall perform the services necessary to complete the Project in accordance with Exhibit C, the Project Plan. The Cooperator shall commence and complete Project tasks in accordance with the Project Schedule, including any properly authorized extensions of time. Time is of the essence in the performance of each obligation under this Agreement. The Cooperator shall promptly advise the District of issues that arise that may impact the successful and timely completion of the Project. The Cooperator shall be solely responsible for managing and controlling the Project and its operation and maintenance, including the engagement and supervision of any consultants or contractors.

5. Funding.

5.1. The anticipated total cost of the Project is identified in the CFI Project Agreement. The District's maximum funding share is identified in the CFI Project Agreement, subject to Paragraph 6 below. The Cooperator shall provide all remaining funds necessary for the satisfactory completion of the Project.

5.2. Any state or federal appropriations or grant funds received by the Cooperator for the Project will be applied to reduce each party's share in accordance with their respective funding percentages as described in the CFI Project Agreement. If the District is a recipient of state or federal appropriations or grant funds for the Project, the District's reimbursement obligation of such funding amounts is contingent upon the District's receipt of such funds.



## APPENDIX E

- 5.3. Reimbursement for expenditures of contingency funds is contingent upon the District's approval and determination, in its sole discretion, that the expenditures were necessary to achieve the resource benefit of the Project and were not in excess of what was reasonably necessary to complete the Project. The term "contingency funds" shall include funds that are allocated for unanticipated or extra work needed to complete the Project. Items not considered for reimbursement include those unrelated to the resource benefit or resulting from design errors and defects in the work. The Cooperator may submit up to 5% of the anticipated total cost of the Project for contingency reimbursement. The District's total reimbursement obligation of contingency expenses is limited to its funding percentage identified in CFI Project Agreement. If an invoice includes expenditures of contingency funds, the Cooperator shall complete and submit the Contingency Funds Justification Form exhibit to explain the basis of each line item expenditure.
  - 5.4. The Cooperator shall evaluate the cost benefit of utilizing owner direct purchases for the Project and shall advise the District as to the reason the Cooperator did or did not choose to utilize owner direct purchase for major Project components.
  - 5.5. Costs associated with in-kind services provided by the Cooperator are not reimbursable by the District and may not be included in the Cooperator's share of Project funding.
  - 5.6. Unless otherwise indicated in this Agreement, the District shall withhold a retainage of 10% of its funding share until all submittals and deliverables required by this Agreement have been provided and the District's Contract Manager verifies their compliance with this Agreement.
  - 5.7. If the Project Plan requires the District to contract with a consultant to perform a third-party review of the 30% design package:
    - 5.7.1. The District shall withhold reimbursement of the costs associated with the 30% design package in an amount equivalent to half the cost of the third-party review.
    - 5.7.2. The District has the right to terminate this Agreement without further payment obligation at the option of the District Governing Board, in its sole discretion, after being presented with the third-party review. If the Board decides to terminate this Agreement, the District shall not be obligated to reimburse the Cooperator for any post-30% design work.
6. Funding Contingency.  
The District's performance and payment pursuant to this Agreement are contingent upon the District's Governing Board appropriating funds in its approved budget for the Project in each fiscal year of this Agreement. The District's funding percentage is subject to change due to subsequent Governing Board approvals. However, once funds are appropriated for the Project in a given fiscal year and the Cooperator has expended allowable Project costs, the appropriated amount will not be reduced. If the District does not approve additional funds needed for the Project in a future fiscal year, the District is obligated to reimburse its share of Cooperator expenses incurred in the amount of funds the District appropriated as of the date of the District's non-appropriation. In this event, the District and the Cooperator, by mutual agreement, may reduce the Project scope. The Cooperator's performance and payment pursuant to this Agreement are contingent on the Cooperator's governing body or the Florida Legislature, as applicable, lawfully appropriating legally available funds.
7. Invoice and Payment.
  - 7.1. The District shall reimburse the Cooperator for its share of allowable Project costs in accordance with the Project Budget, subject to its right to withhold funds as provided in this Agreement; however, at no point in time will the District's expenditure amounts under this Agreement exceed the District's funding percentage identified in the CFI Project Agreement.
  - 7.2. Each invoice must include the following certification:

"I certify that the costs requested for reimbursement and the Cooperator's matching funds are directly related to the performance under the Agreement between the Southwest Florida Water Management District and the Cooperator (Agreement No.

## APPENDIX E

\_\_\_\_\_), are allowable, allocable, properly documented, and are in accordance with the approved Project Budget. This invoice includes \$\_\_ of contingency funds expenditures.”

If the invoice includes the use of federal or state appropriations or grant funds, the certification must also include the following sentence:

“The Cooperator received a total of \$\_\_ in federal and state appropriations or grant monies for the Project and \$\_\_ has been allocated to this invoice, reducing the District’s and Cooperator’s share of this invoice to \$\_\_ / \$\_\_ respectively.”

- 7.3. With the exception of the payment of contingency funds, the District shall reimburse the Cooperator within 45 days of receipt of an invoice with adequate supporting documentation to satisfy auditing purposes and submitted in the manner prescribed by this Agreement. The District shall reimburse the Cooperator for expenditures of contingency funds within a reasonable time to accommodate the process provided for in Subparagraph 5.3. The Cooperator shall submit original invoices to the District every 3 months electronically at [invoices@WaterMatters.org](mailto:invoices@WaterMatters.org). If the Cooperator does not have the capability to submit invoices electronically, the invoices may be mailed to the Accounts Payable Section, Southwest Florida Water Management District, Post Office Box 15436, Brooksville, Florida 34604-5436. Copies of invoices may also be submitted to the District’s Contract Manager to expedite the review process.
  - 7.4. Any travel expenses authorized under this Agreement will be reimbursed in accordance with Section 112.061, Florida Statutes (F.S.), as may be amended from time to time.
  - 7.5. Surcharges added to third party invoices are not considered an allowable cost under this Agreement.
  - 7.6. The Cooperator shall comply with applicable procurement laws when procuring consultants and contractors to accomplish the Project. The District shall only be obligated to reimburse the Cooperator for costs incurred under contracts for Project work that is included in the Project Plan and is necessary to achieve the resource benefits of the Project, to be determined by the District in its sole discretion. Additionally, the District shall only be obligated to reimburse the Cooperator for costs that are reasonable, to be determined by the District in its sole discretion. In order for the District to make the above determinations, the Cooperator shall provide all solicitations to the District prior to posting, and contracts prior to execution, unless the solicitation has been posted or contract has been executed before the parties’ execution of this Agreement, in which case, the documents must be provided within 30 days of execution of this Agreement. The District shall provide a response to the Cooperator within 21 days of receipt of the solicitation or contract. Upon written District approval, the budget amounts for the Project work set forth in a contract will refine the Project Budget and be incorporated herein by reference. The District shall not reimburse the Cooperator for costs incurred under consultant and contractor contracts until the requirements of this Subparagraph are satisfied.
8. Dispute Resolution.  
If an issue or dispute arises during the course of the Project, including whether expenses are reimbursable under this Agreement, the Cooperator shall continue to perform the Project work in accordance with the Project Plan. The Cooperator shall seek clarification and resolution of any issue or dispute by providing the details and basis of the issue or dispute to the District’s Contract Manager no later than 10 days after the issue or dispute arises. If not resolved by the District’s Contract Manager, in consultation with his or her Bureau Chief, within 10 days of receipt of notice, the dispute will be forwarded to the District’s Assistant Executive Director. The District’s Assistant Executive Director in consultation with the District’s Office of General Counsel will issue the District’s final determination. The Cooperator’s continuation of the Project work as required under this Paragraph will not constitute a waiver of any legal remedy available to the Cooperator concerning the dispute.

## APPENDIX E

9. Force Majeure.  
In the event of hurricanes, tornados, floods, acts of God, acts of war, or other such catastrophes, or other man-made emergencies such as labor strikes or riots which are beyond the control of the party obligated to perform the work, the party's obligation to meet the timeframes provided in this Agreement shall be suspended for the period of time the condition continues to exist. When the party is able to resume performance of its obligations under this Agreement, in whole or in part, it shall immediately give the other party written notice to that effect and shall resume performance no later than 2 days after the notice is delivered. The suspension of the party's obligations provided for in this Paragraph shall be the party's sole remedy for the delays set forth herein.
10. Project Records and Audit.  
The Cooperator, upon request, shall permit the District to examine or audit all Project related records and documents during or following Project completion at no cost to the District. These records shall be available at all reasonable times for inspection, review, or audit. "Reasonable" shall be construed according to circumstances, but ordinarily shall mean normal business hours of 8:00 a.m. to 5:00 p.m., local time, Monday through Friday. The Cooperator shall similarly require its consultants and contractors to maintain and allow access to such records for inspection, review, or audit purposes. Payments made to the Cooperator under this Agreement shall be reduced for amounts found to be not allowable under this Agreement by an audit. If an audit is undertaken by the District, all required records shall be maintained until the audit has been completed and all questions arising from it are resolved. The Cooperator shall maintain all such records and documents for at least 5 years following completion of the Project. If an audit has been initiated and audit findings have not been resolved at the end of the 5 years, the records shall be retained until resolution of the audit findings, which would include an audit follow-up by the inspector general if the findings result from an external auditor, or any litigation. The Cooperator understands and will comply with its duty, pursuant to Section 20.055(5), F.S., to cooperate with the inspector general in any investigation, audit, inspection, review, or hearing. The Cooperator shall similarly require its consultants and contractors to comply with their duty, pursuant to Section 20.055(5), F.S., to cooperate with the inspector general in any investigation, audit, inspection, review or hearing. This Paragraph shall survive the expiration or termination of this Agreement.
11. Reports.
- 11.1. The Cooperator shall provide the District with a quarterly report describing the progress of the Project tasks, adherence to the Project Schedule and any developments affecting the Project. Quarterly means the calendar quarters ending March 31, June 30, September 30 and December 31. The Cooperator shall submit quarterly reports to the District's Contract Manager no later than 30 days following the completion of the applicable quarter.
- 11.2. Upon request by the District, the Cooperator shall provide the District with copies of data, reports, models, studies, maps and other documents resulting from the Project. This Subparagraph shall survive the expiration or termination of this Agreement.
- 11.3. If required in the Project Plan, the Cooperator shall submit all water resource data collected under this Agreement to the District for upload to District databases, and to the Florida Department of Environmental Protection's (FDEP) database for water quality data in accordance with Rule 62-40.540, Florida Administrative Code. This Subparagraph shall survive the expiration or termination of this Agreement.
- 11.4. The Cooperator shall provide the documents referenced in this Paragraph at no cost to the District.
12. Risk, Liability, and Indemnity.
- 12.1. To the extent permitted by Florida law, the Cooperator assumes all risks relating to the Project and shall be solely liable for, and shall indemnify and hold the District harmless from all claims, loss, damage and other expenses, including attorneys' fees and costs and attorneys' fees and costs on appeal, arising from the design, construction, operation, maintenance or implementation of the Project; provided, however, that the Cooperator shall not indemnify for

## APPENDIX E

that portion of any loss or damages proximately caused by the negligent act or omission of the District's officers, employees, contractors and agents. The acceptance of the District's funding by the Cooperator does not in any way constitute an agency relationship between the District and the Cooperator.

- 12.2. The Cooperator shall indemnify and hold the District harmless, to the extent allowed under Section 768.28, F.S., from all claims, loss, damage and other expenses, including attorneys' fees and costs and attorneys' fees and costs on appeal, arising from the negligent acts or omissions of the Cooperator's officers, employees, contractors and agents related to its performance under this Agreement.
  - 12.3. This Paragraph, including all subparagraphs, shall not be construed as a waiver of the Cooperator's sovereign immunity or an extension of the Cooperator's liability beyond the limits established in Section 768.28, F.S. Additionally, this Paragraph, including all subparagraphs, will not be construed to impose contractual liability on the Cooperator for underlying tort claims as described above beyond the limits specified in Section 768.28, F.S., nor be construed as consent by the Cooperator to be sued by third parties in any manner arising out of this Agreement.
  - 12.4. Nothing in this Agreement shall be interpreted as a waiver of the District's sovereign immunity or an extension of its liability beyond the limits established in Section 768.28, F.S., nor be construed as consent by the District to be sued by third parties in any manner arising out of this Agreement.
  - 12.5. This Paragraph, including all subparagraphs, shall survive the expiration or termination of this Agreement.
13. Default.

A party may terminate this Agreement upon another party's failure to comply with any term or condition of this Agreement, provided the terminating party is not in default of this Agreement at the time of termination. The terminating party shall provide the defaulting party with a written notice stating its intent to terminate and describing all terms and conditions with which the defaulting party has failed to comply (Notice of Termination). If the defaulting party has not remedied its default within 30 days after receiving the Notice of Termination, this Agreement shall automatically terminate. If a default cannot reasonably be cured within 30 days, then the cure time may be extended at the terminating party's discretion if the defaulting party is pursuing a cure of the default with reasonable diligence. The rights and remedies in this Paragraph are in addition to any other rights and remedies provided by law or this Agreement.
  14. Release of Information.

The parties will not initiate any oral or written media interviews or issue press releases on or about the Project without providing notices or copies to the other party no later than 3 business days prior to the interview or press release. This Paragraph shall not be construed as preventing the parties from complying with the public records disclosure laws set forth in Chapter 119, F.S.
  15. District Recognition.

The Cooperator shall recognize District funding in any reports, models, studies, maps or other documents resulting from this Agreement, and the form of said recognition shall be subject to District approval.
  16. Permits and Real Property Rights.

The Cooperator shall obtain all permits, local government approvals and all real property rights necessary to complete and operate the Project prior to commencing any construction of the Project. The District shall not reimburse the Cooperator for allowable costs under this Agreement until the Cooperator has obtained all permits, approvals, and property rights necessary to complete the Project. This Paragraph shall survive the expiration or termination of this Agreement.
  17. Law Compliance.

The Cooperator shall comply with all applicable federal, state and local laws, rules, regulations and guidelines related to performance under this Agreement.

## APPENDIX E

18. Diversity in Contracting and Subcontracting.  
The District is committed to supplier diversity in the performance of all contracts associated with District cooperative funding projects. The Cooperator shall encourage Project participation of minority owned and woman owned and small business enterprises, as prime contractors and subcontractors, in accordance with applicable laws.
- 18.1. If requested, the District shall assist the Cooperator by sharing information to help the Cooperator ensure that minority owned and woman owned and small businesses are afforded an opportunity to participate in the performance of this Agreement.
- 18.2. If the District's share of Project costs is greater than or equal to \$100,000, the Cooperator shall provide the District with the Minority/Women Owned and Small Business Utilization Report attached as an exhibit, indicating all contractors and subcontractors who performed Project work, the amount paid to each contractor or subcontractor, and to the extent such information is known, whether each contractor or subcontractor was a minority owned or woman owned or small business enterprise. The report is required upon Project completion prior to final payment, or within 30 days of the execution of any amendment that increases the total Project cost, for information up to the date of the amendment and prior to the disbursement of any additional funds by the District.
19. Assignment.  
No party may assign any of its rights or obligations under this Agreement, including any operation or maintenance obligations, without the prior written consent of the other party. Any attempted assignment in violation of this Paragraph is void. This Paragraph shall survive the expiration or termination of this Agreement.
20. Miscellaneous.  
Nothing in this Agreement shall be construed or implied to create any relationship between the District and any consultant or contractor of the Cooperator. Nothing in this Agreement shall be construed to benefit any person or entity not a party to this Agreement. This Agreement is governed by Florida law and venue for resolving disputes under this Agreement shall be exclusively in Hillsborough County, Florida. Unless otherwise stated in this Agreement, if a court of competent jurisdiction deems any term or condition of this Agreement to be invalid, illegal, or unenforceable, the remaining terms and conditions are severable and shall remain in full force and effect. This Paragraph shall survive the expiration or termination of this Agreement.
21. Lobbying Prohibition.  
Pursuant to Section 216.347, F.S., the Cooperator is prohibited from using funds provided by this Agreement for the purpose of lobbying the Legislature, the judicial branch or a state agency.
22. Counterparts and Authority to Sign.  
The signatures of all parties need not appear on the same counterpart. Unless otherwise indicated in the CFI Project Agreement, in accordance with the Electronic Signature Act of 1996, electronic signatures, including facsimile transmissions, may be used and shall have the same force and effect as a written signature. Each person signing this Agreement warrants that he or she is duly authorized to do so and to bind the respective party to this Agreement.
23. Entire Agreement.  
This Agreement, including the attached, referenced, and incorporated exhibit(s), constitutes the entire agreement between the parties and, unless otherwise provided herein, may only be amended through a formal amendment, signed by all parties to this Agreement. In the event of a conflict of contract terminology, priority shall be given first to the CFI Project Agreement; the exhibits, in the order presented in the CFI Project Agreement, except that Exhibit B shall take precedence over Exhibit A, and then the attachments in the order presented in the CFI Project Agreement.

Exhibit B  
Southwest Florida Water Management District  
Special Terms and Conditions  
Construction – Water Quality or Flood Protection

1. Project Funding.

- 1.1. The District Governing Board approved the funding of the Project based upon the expectation that the Resource Benefit as provided in the Project Plan would be achieved. Construction of the Project in accordance with the Measurable Benefit as provided in the Project Plan is expected to result in the Resource Benefit. The Cooperator is solely responsible for implementing the Project in such a manner that the Measurable Benefit is achieved. If at any point during the progression of the Project, the District determines that it is likely that the Measurable Benefit will not be achieved, the District shall provide the Cooperator with 15 days advance written notice that the District will withhold payments until such time as the Cooperator demonstrates that the Project will achieve the Measurable Benefit.
- 1.2. Furthermore, if at any point during the progression of the Project, it is determined by the District, in its sole discretion, that the Resource Benefit may not be achieved, the District may terminate this Agreement without any payment obligation. Such termination shall be effective 10 days following the Cooperator's receipt of written notice from the District.
- 1.3. The District shall not reimburse the Cooperator for any costs under this Agreement until the notice to proceed with construction has been issued to the Cooperator's contractor; unless the Project Plan requires the District to perform a third-party review, in which case the District shall reimburse the Cooperator for the 30% design package costs subject to Subparagraph 5.7 in Exhibit A, and shall not reimburse the Cooperator for any post-30% design work until the notice to proceed with construction has been issued.

2. Repayment.

- 2.1. The Cooperator shall repay the District all funds the District paid to the Cooperator under this Agreement, except for the 30% design package costs if a third-party review was performed by the District, if: a) the Cooperator fails to complete the Project in accordance with the terms and conditions of this Agreement; b) the District determines, in its sole discretion, that the Cooperator has failed to maintain scheduled progress of the Project thereby endangering the timely completion of the Project; c) if the Cooperator is a public entity, the Cooperator fails to appropriate sufficient funds to meet the Project task deadlines; d) the District determines, in its sole discretion, that a permit, approval, or property right legal challenge has caused an unreasonable delay or cancellation of the Project; e) the Project is used for compensatory water quality treatment or mitigation or water use permitting withdrawal credits in violation of this Agreement; or f) any contractual requirement or expectation of the resource benefits resulting from the Project, including any requirement applicable to reclaimed water projects, is held to be invalid, illegal or unenforceable during the term of this Agreement, including the O&M Period. Should any of the above conditions exist that require the Cooperator to repay the District, this Agreement shall terminate in accordance with the procedure set forth in the Default Paragraph.
- 2.2. Notwithstanding the above, if the Project fails to achieve the Measurable Benefit, the Cooperator may request the District Governing Board waive the repayment obligation, in whole or in part.
- 2.3. If the Cooperator is obligated to repay the District, the Cooperator shall repay the District within a reasonable time, as determined by the District in its sole discretion.

## APPENDIX E

- 2.4. The Cooperator shall pay attorneys' fees and costs incurred by the District, including appeals, resulting from the Cooperator's failure to repay the District as required by this Agreement.
- 2.5. This Paragraph, including all subparagraphs, shall survive the expiration or termination of this Agreement.
3. Operation and Maintenance.  
The Cooperator shall operate and maintain the Project for at least 20 consecutive years (O&M Period) beginning at Project completion in such a manner that the Project's resource benefits are achieved. If the Cooperator ceases to operate and maintain the Project, the Cooperator shall repay the District 5% of total District monies contributed to the Project for each year or a fraction of a year in which the Project is not operated and maintained. The rights and remedies in this Paragraph are in addition to any other rights and remedies provided by law or this Agreement.
- 3.1. Within 30 days of Project completion, or as extended by the District in writing, the Cooperator shall provide the District with construction record drawings, including Resource Benefit calculations and methodology, signed and sealed by a professional engineer, certifying that the Measurable Benefit has been achieved. If required in the Project Plan, the Cooperator shall provide the District with an operation and maintenance plan that provides reasonable assurance that the Project will be operated and maintained as required by this Agreement. Every 2 years during the O&M Period, the Cooperator shall generate a report certifying that the Project has been maintained in accordance with all permit requirements. The Cooperator's obligation to generate and maintain such reports shall continue throughout the O&M Period.
- 3.2. The District retains the right to audit any certification and, if requested by the District, the Cooperator shall provide documentation to support its certification that the required resource benefits have been achieved.
- 3.3. This Paragraph, including all subparagraphs, shall survive the expiration or termination of this Agreement.
4. Design Submittal. *Checked paragraph applies.*
- The Cooperator shall provide the District with the final design drawings and Resource Benefit calculations and methodology, signed and sealed by a professional engineer, including supporting documentation. The District shall provide written notice to the Cooperator within 15 days of receipt of the design submittal advising if it appears to meet the requirements of this Agreement. The District's acceptance of the design submittal shall not be construed as an approval of the design, or a representation or warranty that the District has verified the architectural, engineering, mechanical, electrical, or other components of the construction bid documents or that such documents are in compliance with applicable rules, regulations or law, including the District's.
  - The Cooperator must ensure that the design of the Project maximizes the resource benefits to the greatest extent practicable. The Cooperator shall provide the District with the 30%, 60%, 90% and final design drawings and Resource Benefit calculations and methodology, including supporting documentation. A professional engineer shall sign and seal the final design drawings and Resource Benefit calculations and methodology. The District shall provide written notice to the Cooperator within 15 days of receipt of each design submittal, advising if it appears to meet the requirements of this Agreement. The District's acceptance of any design submittal shall not constitute an approval of the design, or a representation or warranty that the District has verified the architectural, engineering, mechanical, electrical, or other components of the

## APPENDIX E

construction bid documents or that such documents are in compliance with applicable rules, regulations or law, including the District's.

5. Compensatory Treatment Mitigation.

The Project shall not be used by the Cooperator or any other entity as compensatory water quality treatment or wetland mitigation, or any other required mitigation due to impacts for any projects. The Project shall not be used for water use permitting withdrawal credits. The Project can be used for self-mitigation due to impacts specifically associated with the construction of the Project. This Paragraph shall survive the expiration or termination of this Agreement.

6. Additional Clauses. *Checked paragraphs apply.*

Signage.

The Cooperator shall provide signage at the Project site that recognizes the District's funding for the Project. All signage must receive the District's written approval as to form, content and location, and must be in accordance with local sign ordinances.

Florida Single Audit Act.

Funding for this Agreement includes state financial assistance and is therefore subject to the Florida Single Audit Act (FSAA), Section 215.97, F.S. The Cooperator is a subrecipient of state financial assistance under this Agreement and therefore may be subject to audits and monitoring as described in the Special Audit Requirements exhibit. The Cooperator must also use the attached Florida Single Audit Act Checklist for Non-State Organizations – Recipient/Subrecipient vs. Vendor Determination to evaluate the applicability of the FSAA to non-state organizations to which the Cooperator provides State resources to assist in carrying out activities related to this Agreement. If the Cooperator has a question related to the grant or subgrant of State funding, contact the individual identified below:

Grants Compliance Accountant  
Southwest Florida Water Management District  
2379 Broad Street, Brooksville, Florida 34604  
Phone: (352) 796-7211, Ext. 4104  
GrantsAccounting@watermatters.org

The Cooperator shall provide the District with its grant contact information within 30 days of execution of this Agreement.

The remainder of this page intentionally left blank.



**EXHIBIT C  
PROJECT PLAN**

**PROJECT DESCRIPTION**

The Project is a cooperative funding project located within Highlands County in the Lake June-In-Winter watershed. Lake June-In-Winter is a Lake Wales Ridge Lake.

The Project includes design, permitting and construction of stormwater best management practices in Catfish Creek to improve water quality in Lake June-In-Winter, a Lake Wales Ridge Lake. The drainage area includes approximately 2,760 acres of the Catfish Creek watershed. The general location of the Project is shown on the attached map (Figure 1).

**RESOURCE BENEFIT**

The Resource Benefit of the Project is the reduction of pollutant loads to lake June-In-Winter, a Lake Wales Ridge Lake, by an estimated 205 lbs./yr. TN, and 42 lbs./yr. TP.

**MEASURABLE BENEFIT**

Design, permitting and construction of low impact development (LID) best management practices (BMPs) to provide treatment to 2,760 acres of the Catfish Creek watershed. Construction will be done in accordance with the permitted plans.

**PROJECT TASKS**

Key tasks to be performed by the Cooperator:

1. **DESIGN** – The Cooperator shall provide the necessary services such as survey, geotechnical services, environmental services, and engineering services to develop design drawings and technical specifications for construction. At each design stage submittal, the Cooperator shall provide Resource Benefit calculations and methodology including cost benefit analysis for flood protection projects.
2. **PERMITTING** – The Cooperator shall prepare and submit all necessary permit applications and obtain necessary approvals.
3. **BIDDING AND CONTRACT AWARD** – The Cooperator shall procure a contractor to implement the Project based on the final design drawings and approved permits. The Cooperator shall identify those bid items for which reimbursement will be requested from the District.
4. **CONSTRUCTION** – The Cooperator shall construct the Project in conformance with the final design drawings, specifications and approved permits.
5. **CONSTRUCTION ENGINEERING AND INSPECTION (CEI)** – The Cooperator shall review all shop drawings, complete engineering inspections and monitor all phases of construction by means of survey, observations, and materials testing to give reasonable assurance that the construction work conforms to the permitted drawings and design specifications. The Cooperator shall provide the District with inspection documents and photographs, if requested.

## APPENDIX E

6. **AS-BUILT SURVEY, RECORD DRAWINGS AND CERTIFICATE OF SUBSTANTIAL COMPLETION** – The Cooperator shall obtain and provide to the District, an As-Built Survey signed and sealed and certified by a licensed Florida professional surveyor, the Record Drawings signed and sealed by a professional engineer, and a Certificate of Substantial Completion, signed by the Cooperator, contractor, and professional engineer. The Cooperator shall provide the Resource Benefit calculations and methodology, signed and sealed by a professional engineer, following completion of construction.
7. **OPERATION AND MAINTENANCE** – The Cooperator shall provide for the operation and maintenance of the completed Project to provide pollutant removal and ensure the Project functions in accordance with the final design drawings and conforms to all the conditions specified in the environmental permits issued for the Project. The Cooperator shall be identified as the entity responsible for all operation and maintenance requirements in all permits issued for the Project.

**DELIVERABLES**

- Design drawings at 30%, 60%, 90% and final design levels; include electronic and CAD
- Engineer's opinion of probable cost at 30%, 60%, 90% and final design
- Technical Specifications at 60%, 90% and final design
- Dated color (digital) photographs of the construction site prior to, during, and immediately following completion of construction
- Record Drawings with Resource Benefits and Calculations and Methodology
- Certificate of Substantial Completion

**SPATIAL REFERENCE, CAD DELIVERABLE REQUIREMENTS**

All survey and mapping services and deliverables shall be certified as meeting or exceeding, in quality and precision, the standards applicable for this work, as set forth in Chapter 472, F.S.

Horizontal Datum will be referenced to the Florida State Plane Coordinate System, West Zone (0902), Units US Survey Feet, North American Datum of 1983 (NAD83/2011) Current Adjustment including the most recent NSRS adjustment.

Vertical Datum will be referenced to the North American Vertical Datum of 1988 (NAVD 88), Units US Survey Feet, using the most recent geoid model to compute orthometric heights based on GPS derived ellipsoid heights.

**PROJECT SCHEDULE**

| DESCRIPTION                                                              | COMMENCE   | COMPLETE   |
|--------------------------------------------------------------------------|------------|------------|
| Design                                                                   | 03/01/2022 | 10/31/2022 |
| Permitting                                                               | 08/01/2022 | 10/31/2022 |
| Bidding and Contract Award                                               | 11/01/2022 | 1/31/2023  |
| Construction and Construction Engineering & Inspection (CEI)             | 02/01/2023 | 02/01/2024 |
| As-Built Survey, Record Drawings & Certificate of Substantial Completion | 02/01/2024 | 03/01/2024 |

Additional task deadlines contained in the performance schedules of the consultant and contractor contracts will be incorporated herein by reference.

## APPENDIX E

**PROJECT BUDGET**

| DESCRIPTION                                                               | DISTRICT         | COOPERATOR      | TOTAL            |
|---------------------------------------------------------------------------|------------------|-----------------|------------------|
| Design                                                                    | \$101,250        | \$33,750        | \$135,000        |
| Permitting                                                                | \$0              | \$0             | \$0              |
| Construction                                                              | \$93,750         | \$31,250        | \$125,000        |
| Construction Engineering & Inspection (CEI)                               | \$0              | \$0             | \$0              |
| As-Built Survey, Record Drawings, & Certificate of Substantial Completion | \$0              | \$0             | \$0              |
| <b>TOTAL</b>                                                              | <b>\$195,000</b> | <b>\$65,000</b> | <b>\$260,000</b> |

Reimbursement for expenditures of contingency funds is contingent upon District approval in accordance with the Funding Paragraph in the Agreement. The Cooperator must complete one Cooperative Funding Construction Contingency Justification form, attached to this Agreement, per contingency line item requested for District reimbursement.

The remainder of this page intentionally left blank.

APPENDIX E

FIGURE 1  
Lake June-in-Winter Watershed Catfish Creek Structural BMPs



Cooperative Funding Construction Contingency Justification  
Submit ONE form per contingency line item requested for  
District reimbursement

Project Name:

District Project Number:

Cooperator:

Contract Number:

Contingency Request Number:

Awarded Construction Contract Total (\$):

Contingency Amount Requested (\$):

Cumulative Contingency Amount Authorized to date  
(\$): Total Cumulative Contract Price Including this  
Request (\$): Maximum contingency eligible for  
reimbursement (\$):

up to 5% (2.5% District portion)

Contingency Request Description:

Contingency Line Item Justification<sup>1</sup>:

Cooperative Funding Resource Benefit<sup>2</sup>:

APPENDIX E

Cost/Negotiation Description<sup>3</sup>:

I hereby certify that this contingency request is necessary for the resource benefit required under the cooperative agreement and scope and costs were negotiated in good faith.

Contract Manager or Engineer of Record

Date

<sup>1</sup> Justification must document the need for the contingency line item, the circumstances under which the need was discovered, and why the item was not included within the original project scope. The District may deny reimbursement for additional costs due to design errors, rework and defects in the work.

ALTERNATE LANGUAGE: The District may deny reimbursement for additional costs resulting from delays, inefficiencies, rework or extra work.

<sup>2</sup> Describe why the contingency line item is needed to fulfill the resource benefit required under the cooperative agreement.

<sup>3</sup> Costs need to be justified and demonstrated to be reasonable. Provide unit price comparison, or recent competitive cost proposals, RS Means or FDOT cost data. Attach backup documentation. If no price comparisons or competitive quotes can be provided, a certification from the Engineer of Record or appropriate Professional Engineer stating that the cost is reasonable may be considered. The certification method is not preferred and will require justification that other methods were not available

APPENDIX E

AGREEMENT NO. 22CF0003717

ATTACHMENT 2  
 MINORITY/WOMEN OWNED AND SMALL BUSINESS UTILIZATION REPORT

Projects receiving \$100,000 or more in cooperative funding from the Southwest Florida Water Management District require the submission of the following information within 30 days of any amendment increasing project funding and with the final invoice. Questions regarding use of this form should be directed to Contracts Administration, Phone (352) 796-7211 ext. 4133.

| COOPERATOR: _____<br><br>AGREEMENT NO.: _____<br><br>PROJECT NAME: _____<br><br>TOTAL PROJECT COST: _____ |                   | INDICATE THE ONE CATEGORY THAT BEST DESCRIBES EACH ORGANIZATION LISTED* |                                        |                  |                   |                         |                 |                   |                  |                   |                         |                 |                |  |
|-----------------------------------------------------------------------------------------------------------|-------------------|-------------------------------------------------------------------------|----------------------------------------|------------------|-------------------|-------------------------|-----------------|-------------------|------------------|-------------------|-------------------------|-----------------|----------------|--|
|                                                                                                           |                   | BUSINESS CLASSIFICATION                                                 |                                        | CERTIFIED MBE    |                   |                         |                 | NON-CERTIFIED MBE |                  |                   |                         | UNKNOWN         |                |  |
|                                                                                                           |                   | NON-MINORITY                                                            | SMALL BUSINESS Section 288.703(1) F.S. | AFRICAN AMERICAN | HISPANIC AMERICAN | ASIAN/HAWAIIAN AMERICAN | NATIVE AMERICAN | AMERICAN WOMAN    | AFRICAN AMERICAN | HISPANIC AMERICAN | ASIAN/HAWAIIAN AMERICAN | NATIVE AMERICAN | AMERICAN WOMAN |  |
| NAMES OF CONTRACTORS AND SUBCONTRACTORS UTILIZED                                                          | TOTAL AMOUNT PAID |                                                                         |                                        |                  |                   |                         |                 |                   |                  |                   |                         |                 |                |  |
|                                                                                                           |                   |                                                                         |                                        |                  |                   |                         |                 |                   |                  |                   |                         |                 |                |  |
|                                                                                                           |                   |                                                                         |                                        |                  |                   |                         |                 |                   |                  |                   |                         |                 |                |  |
|                                                                                                           |                   |                                                                         |                                        |                  |                   |                         |                 |                   |                  |                   |                         |                 |                |  |
|                                                                                                           |                   |                                                                         |                                        |                  |                   |                         |                 |                   |                  |                   |                         |                 |                |  |
|                                                                                                           |                   |                                                                         |                                        |                  |                   |                         |                 |                   |                  |                   |                         |                 |                |  |
|                                                                                                           |                   |                                                                         |                                        |                  |                   |                         |                 |                   |                  |                   |                         |                 |                |  |
|                                                                                                           |                   |                                                                         |                                        |                  |                   |                         |                 |                   |                  |                   |                         |                 |                |  |
|                                                                                                           |                   |                                                                         |                                        |                  |                   |                         |                 |                   |                  |                   |                         |                 |                |  |
|                                                                                                           |                   |                                                                         |                                        |                  |                   |                         |                 |                   |                  |                   |                         |                 |                |  |

\*  Our organization does not collect minority status data.

Signature \_\_\_\_\_ Date \_\_\_\_\_

Print Name and Title \_\_\_\_\_

## Attachment 4: Cooperative Funding Agreement Checklist

This checklist is to be used as a tool by the Cooperator and District Contract Manager to monitor and track Cooperative Funding Agreement terms throughout Project implementation.

**Cooperator****District****For Studies and Design:**

- Copy of contract with consultant. If contract is not provided to the District prior to execution, the Cooperator may be executing a contract with consultant that includes items that are not reimbursable
- All Draft and Final Reports and/or design drawings per the Exhibit C Project Plan

**For Construction Reimbursement:**

- Copy of bid documents and bid form. If bid documents and bid form are not provided to the District prior to bidding, the Cooperator may be advertising for items that are not reimbursable
- Copy of contract with contractor. If contract is not provided to the District prior to execution, the Cooperator may be executing a contract with contractor that includes items that are not reimbursable
- Copy of Notice to Proceed to contractor
- Owner Direct Purchase Statement
- Copy of construction permits
- If land acquisition included, review and comment from District's Real Estate Services on appropriate land value
- Any state or federal appropriations or grant funds received by the Cooperator for the Project will be applied to reduce each party's share in accordance with their respective funding percentages as described in the CFI Project Agreement
- Copy of all required federal, state, and local environmental permit approvals and permitted drawings

**During Project Work:**

- Quarterly (see Exhibit A paragraph 11) status reports
- Invoices for reimbursement (per Exhibit A paragraph 7)
- Contingency Form for each contingency item
- Request(s) for changes to prime contacts
- Request(s) to extend project task deadline and/or adjustments to line item budget
- Request(s) for changes to scope, budget, and/or schedule requiring an amendment to the agreement
- M/W/SME Form must be submitted to the District if an amendment is executed that increases the total Project cost. This will apply to amendments when authorizing post-TPR work

**Close Out:**

Prior to Final Payment Reimbursement the Cooperator will provide to the District:

- Minority/Women Owned and Small Business Utilization Report (If District's share is \$100,000 or greater)
- All Deliverables listed in Exhibit C Project Plan as described in the tasks

**Survival of the Agreement:**

Per Exhibit B, the District upon request may review the biennial Operation and Maintenance Report



**Certificate Of Completion**

Envelope Id: 1E49261BBD4B42B2817A46CC5529FA35

Subject: Please DocuSign: Lake June-In-Winter Catfish Creek BMPs Agreement - 22CF0003717

Source Envelope:

Document Pages: 19

Signatures: 0

Certificate Pages: 4

Initials: 0

AutoNav: Enabled

Envelope Stamping: Enabled

Time Zone: (UTC-05:00) Eastern Time (US &amp; Canada)

Status: Sent

Envelope Originator:

Meagan Finneran

2379 Broad Street

Brooksville, FL 34604

meagan.finneran@swfwmd.state.fl.us

IP Address: 192.155.215.34

**Record Tracking**

Status: Original

12/10/2021 5:07:55 PM

Holder: Meagan Finneran

meagan.finneran@swfwmd.state.fl.us

Location: DocuSign

**Signer Events****Signature****Timestamp****In Person Signer Events****Signature****Timestamp****Editor Delivery Events****Status****Timestamp****Agent Delivery Events****Status****Timestamp****Intermediary Delivery Events****Status****Timestamp****Certified Delivery Events****Status****Timestamp**

Mike McMillian

mcmillian@highlandsfl.gov

Security Level: Email, Account Authentication  
(None)**VIEWED**

Sent: 12/10/2021 5:17:41 PM

Viewed: 12/13/2021 6:36:04 AM

Using IP Address: 50.239.62.46

**Electronic Record and Signature Disclosure:**

Accepted: 12/13/2021 6:36:04 AM

ID: 90fcbfb5-3519-43b3-acad-9de6878fe909

Dawn Ritter

dritter@highlandsfl.gov

Security Level: Email, Account Authentication  
(None)

Sent: 12/13/2021 6:36:04 AM

**Electronic Record and Signature Disclosure:**

Not Offered via DocuSign

**Carbon Copy Events****Status****Timestamp**

Nancy Norton

nancy.norton@swfwmd.state.fl.us

Security Level: Email, Account Authentication  
(None)**Electronic Record and Signature Disclosure:**

Not Offered via DocuSign

Johnathon Harrison

jharrison@highlandsfl.gov

Security Level: Email, Account Authentication  
(None)**Electronic Record and Signature Disclosure:**

Not Offered via DocuSign

APPENDIX E

**Witness Events**

**Signature**

**Timestamp**

**Notary Events**

**Signature**

**Timestamp**

**Envelope Summary Events**

**Status**

**Timestamps**

Envelope Sent

Hashed/Encrypted

12/10/2021 5:17:41 PM

**Payment Events**

**Status**

**Timestamps**

**Electronic Record and Signature Disclosure**

## **Your Consent to Use Electronic Records and Signatures**

From time to time, the Southwest Florida Water Management District ("District") may provide you with certain agreements. The federal E-SIGN Act and the Florida Uniform Electronic Transaction Act, Chapter 668, Florida Statutes, allow the District to provide you these agreements electronically and the use of electronic signatures with your consent. Described below are the terms and conditions for providing you such agreements electronically as well as for the use of electronic signatures. This consent relates to your agreement with the District and any associated electronic signatures. If you consent to receive your agreement electronically and to use electronic signatures, you must keep your email address up to date by notifying ESignQuestions at [ESignQuestions@swfwmd.state.fl.us](mailto:ESignQuestions@swfwmd.state.fl.us) of any changes to your contact information.

Please read the information below thoroughly and, if you can access this information electronically to your satisfaction, please confirm your acceptance and understanding that your electronic signature executed in conjunction with the electronic submission of your agreement shall be legally binding and such transaction shall be considered authorized by you by clicking the "I consent to use Electronic Records and Signatures" box located on the previous page. If you do not agree to use electronic signatures, click the link under "Other Options" to print and sign the agreement.

## **Right to Have Records Provided on Paper**

At any time, you may request from the District paper copies of any of your agreements at no cost to you. You may request delivery of paper copies by contacting ESignQuestions at [ESignQuestions@swfwmd.state.fl.us](mailto:ESignQuestions@swfwmd.state.fl.us). Additionally, following your signing session, you will have the ability to download and print your agreement through the DocuSign, Inc. ("DocuSign") system. You will receive an email with a link to access your agreement within the DocuSign system.

## **Right to Withdraw Your Consent to Receive Electronic Records; Consequences**

If you agree to receive your agreement electronically and use electronic signatures, you have the right to withdraw your consent at any time and at no cost to you. You must inform the District of your decision by ESignQuestions at [ESignQuestions@swfwmd.state.fl.us](mailto:ESignQuestions@swfwmd.state.fl.us). Please include your contact information and the agreement number you are declining to sign electronically in your withdrawal notice. If you elect to receive your agreement only in paper format, or refuse to sign electronically, it may slow down the speed at which you receive documents or information.

## **Hardware and Software Minimum Requirements**

## APPENDIX E

To access and retain your agreement, you will need the following:

|                           |                                                                                                                                    |
|---------------------------|------------------------------------------------------------------------------------------------------------------------------------|
| Operating Systems:        | Windows 2000 or Windows XP                                                                                                         |
| Browsers (for SENDERS):   | Internet Explorer 6.0 or above                                                                                                     |
| Browsers (for SIGNERS):   | Internet Explorer 6.0, Mozilla Firefox 1.0, NetScape 7.2 (or above)                                                                |
| Email:                    | Access to a valid email account                                                                                                    |
| Screen Resolution:        | 800 x 600 minimum                                                                                                                  |
| Enable Security Settings: | Allow per session cookies<br><br>Users accessing internet behind a Proxy Server must enable HTTP 1.1 settings via proxy connection |

These minimum requirements are subject to change. If these requirements change such that you may not be able to access or retain the electronic records, we will provide you with an email message at the email address we have on file for you, providing you with the revised hardware and software requirements. At that time, you will have the right to withdraw your consent to receive documents electronically.

## APPENDIX E

### Weekly Meeting

December 13, 2021

#### **JDF**

Monday -

Tuesday –

Wednesday –

Thursday –

#### **Mike McMillian –**

Monday – be ready to move tortoise when Ric says he's ready; Preserve mowing

Tuesday – if trailer returned, scrub debris removal, if not Preserve mowing and trail work

Wednesday – if trailer returned, scrub debris removal, if not Preserve mowing and trail work

Thursday – if trailer returned, scrub debris removal, if not Preserve mowing and trail work

#### **Dawn Ritter**

Review the excel sent for NR Task for remainder of the year-any updates/comments/clarification Working document in G Drive under “Dawn”. I edit information each week.

Along with many How-to documents under “How to Tutorials”

IMWID Phase 2 – Board will decide how to move forward. This will be on December 7<sup>th</sup> Board meeting.

JD-Lake Trout Lake Watch Volunteer- any info? Trained and excel volunteer file updated(jdf)

Admin still has trailer so cannot transport Ranger (Chris' trailer too small).