

Table 647-9 Quadrupole (QP) Loops	
6 ft x 30 ft (2, 4, 2 turns) [1.8 m x 9 m (2, 4, 2, turns)]	l = 269 mH + 23 mH per 100 feet of loop lead-in cable l = 269 mH + 23 mH per 30 m of loop lead-in cable
6 ft x 40 ft (2, 4, 2 turns) [1.8 m x 12 m (2, 4, 2, turns)]	l = 349 mH + 23 mH per 100 feet of loop lead-in cable l = 349 mH + 23 mH per 30 m of loop lead-in cable
6 ft x 50 ft (2, 4, 2 turns) [1.8 m x 15 m (2, 4, 2, turns)]	l = 429 mH + 23 mH per 100 feet of loop lead-in cable l = 429 mH + 23 mH per 30 m of loop lead-in cable
6 ft x 60 ft (2, 4, 2 turns) [1.8 m x 18 m (2, 4, 2, turns)]	l = 509 mH + 23 mH per 100 feet of loop lead-in cable l = 509 mH + 23 mH per 30 m of loop lead-in cable
6 ft x 70 ft (2, 4, 2 turns) [1.8 m x 21 m (2, 4, 2, turns)]	l = 589 mH + 23 mH per 100 feet of loop lead-in cable l = 589 mH + 23 mH per 30 m of loop lead-in cable

3. Leakage Resistance to Ground

The resistance to ground shall be 5 Mohm or more.

4. Loop Resistance

The resistance reading on an ohmmeter is approximately within ten percent (10%) of the calculated value:

- Acceptable Resistance @ (dc @ 68 °F [20 °C]):ohms(μ)
- No. 18 AWG wire: R = 29.4 μ /mile (or) R = 5.5 x 10⁻³ μ /ft. Approximately 5.5 ohms per 1,000 feet of No. 18 AWG wire][R = 18.3 μ /km (or) R=18.3 x 10⁻³ μ /m]
- No. 14 AWG wire: R = 13.32 μ /mile (or) R = 2.523 x 10⁻³ μ /ft. Approximately 2.52 ohms per 1,000 feet of No. 14 AWG wire][R = 8.3 μ /km (or) R=8.3 x 10⁻³ μ /m]
- No. 12 AWG wire: R = 5.2 μ /mile (or) R = 9.85 x 10⁻⁴ μ /ft. Approximately 0.98 ohms per 1,000 feet of No. 12 AWG wire [R = 3.24 μ /km (or) R = 3.24 x 10⁻³ μ /m]

5. Loop Q

Q at 50 kHz is greater than 5.

Report to the Engineer an out-of-range reading on any of the above tests. If a test is found unacceptable, remove the loop, install new wire, and repeat the test procedure.

Include in the test results:

- Type and model number of the equipment used (must be ohmmeter having a high resistance scale of R x 10 KW or greater)
- The last calibration date of the equipment and the scale used

Check the loop using an impedance tester to determine the natural operating frequency and impedance. Ensure that the completed units detect all motor vehicles. If the loop detection system does not meet the above test requirements, payment will not be made for work on the signal installation until corrections are completed.

Table 647-10 Loop Installation Data Sheet	
Conditions	
Project Number:	
Date:	
Contractor:	
Weather:	
Temperature:	
Pavement Condition - Wet () or Dry ()	
Location	
City or County:	Phase:
Intersection Name or Number:	Function:
Route Number(s) or Name (s):	Lane Location:
Installation or Plan Sheet Number:	No. of Turns:
Size and Type of Loop:	Downstream/Upstream: Down () Up ()
Distance from Stop Bar:	Distance E.O.P/Curb to Lead-in:
Distance Lead-in Cable:	
Material	
Loop Wire Color/Insulation Type/Gauge:	
Loop Lead-In Wire Color/Insulation Type/Gauge:	
Splice Point:	
Conduit Length from Curb/E.O.P. to Splice Point:	
Conduit Length from Splice Point to Cabinet:	
Sealant Type and Part Number:	
Sealant Manufacturer and Lot No.:	
Interconnect Wire Type and Length:	
Loop Tests	
1. Induced Voltage ____ 2. Inductance ____ microhenries 3. Leakage Resistance to Ground ____ megohms 4. Loop Resistance ____ ohms 5. Loop Q (Quality) ____ Q	
Comments	
Inspector's Name, and Title	

B. Field Tests

In addition to performing tests during installation and before turning on the equipment, perform the following tests on traffic signal circuits in the presence of the Engineer:

-
- Test each circuit for continuity

Test each circuit for grounds. If a test fails, repair the circuit immediately. New signals shall operate in the flash mode for three (3) days prior to beginning stop-and-go operation unless otherwise directed by the Traffic Engineer.

For Ramp Metering:

The Contractor shall submit to and obtain approval from the Engineer for Ramp Metering testing procedures for each specific Ramp Meter location. The testing procedure shall demonstrate that all components: hardware, cable, and connections furnished and installed by the Contractor operates correctly and that all functions are in conformance with the specifications.

At a minimum, the Contractor shall demonstrate to the Engineer:

- The IVDS and loop detectors at each location are functioning properly with expected accuracy as specified. IVDS burn-in period shall only be in conjunction with the Ramp Meter signal burn-in period of 30 days.
- The Ramp Meter signals function properly at all stages, including non-metering, startup, metering, and shutdown.
- In multi-lane configurations, the Ramp Meter can operate a simultaneous release of vehicles from all lanes and as well as an alternating or staggered release of vehicles from the two (or three) lanes.
- Queue detectors are functioning as specified, including both queue detection and queue override.
- The Ramp Meter functions properly for both local traffic responsive and time of day operations.
- The advance warning sign can be clearly seen and can be activated and deactivated properly.
- The Ramp Meter can communicate properly with the hub/TMC.
- The traffic enforcement heads are operating as per the Plans and can be seen by enforcement personnel.

The Contractor shall coordinate closely with Engineer for conducting Ramp Meter field operational tests.

Note: Pretest should be performed prior to calling the Engineer for formal field tests inspection. Pretest shall be defined as conducting all field tests in accordance with the Ramp Metering field testing procedures submitted and approved. Results of pretests shall be recorded and submitted to the Engineer. The Engineer may require the Contractor to address particular items noted in the pretest before beginning the actual field tests.

Operational test shall not begin until the field tests are accepted by the engineer-that will be performed during the Engineer's inspection. Begin operational tests after the Engineer is satisfied that all work has been completed. After the Ramp Meter has been placed in operation, the Contractor, in coordination with the system integrator, shall demonstrate that all equipment furnished and installed by the Contractor operates with all software and firmware as specified.

After successful completion of the test procedure, each Ramp Meter assembly shall go through a burn-in period for 30 consecutive days of normal Ramp Metering operations. During the burn-in period, the

Contractor shall ensure that all Contractor-supplied equipment operates without failures of any type. If any equipment component malfunctions or fails to provide the specified functionality during the 30-day burn-in period, the Contractor shall replace or repair the defective equipment within 48 hours of notification by the Engineer.

After the malfunctioning component(s) have been repaired or replaced to the satisfaction of the Engineer, the Contractor shall begin a new 30-day burn-in period. The new 30-day burn-in period shall apply only to equipment components supplied by the Contractor. In the event of a failure or malfunctioning of equipment furnished by others which prevents the 30-day burn-in test from continuing, the Engineer will suspend the burn-in test and resume when the other equipment failures are corrected.

C. Operational Tests and Equipment Activation

After the equipment is installed and the field tests are completed successfully the Contractor shall request an initial equipment inspection. The Engineer shall notify in writing the District Signal Engineer a minimum of 14 working days prior to the inspection. The District Signal Engineer shall provide an in depth inspection and provide a written punch list of items for the Contractor to correct. Within fourteen days of the notification the Contractor shall correct the items noted.

Prior to activating new equipment and before removal of any existing intersection control or equipment, test and ensure any communications equipment is functional.

In the event that programming of the controller application is not a pay item for the contract the Engineer will notify the District Signal Engineer a minimum of 14 working days prior to activating the equipment.

Prior to activating equipment all Inductance loop, video detection equipment and detection zones shall be functional and operational.

When defects are resolved, the District Signal Engineer will begin the Contractor's operational test period to demonstrate that every part of the system functions as specified. The operational test shall be concurrent for the entire project.

1. The operational test for the traffic signal and Ramp Metering projects shall be at least thirty (30) days of continuous, satisfactory operation.
2. If a component or system fails or shows unsatisfactory performance, the condition must be corrected and the test repeated until thirty (30) days of continuous satisfactory operation is obtained.
3. The District Traffic Engineer will send the Engineer and Construction Office a letter showing the start, termination, suspension, or successful completion of the operational test period.
4. The District Engineer may recommend payment only after the successful completion of the test period.
5. The Contractor shall obtain written acceptance of the signal installation from the District Traffic Operations Engineer before Final Acceptance.

Costs incurred during operational tests, including power consumption, shall be at the Contractor's expense and included in the price bid for Contract Items.

647.3.07 Contractor Warranty and Maintenance

A. Traffic Signal Equipment Maintenance

See Section 150.

If a signal that is the responsibility of the contractor is not functioning properly:

1. Non-Emergency

Commence work on this signal within three (3) days of the written notice from the Engineer. Failure to respond shall result in a per calendar day charged against monies due or that may become due until the maintenance work is started. See Section 108.

The Contractor shall be responsible for all materials, equipment and expertise necessary to correct signal malfunction or repair.

The Department or local municipality will not be held responsible or liable for any alleged damage to the signal or as a result of the signal malfunction due to problems that may occur after the Department or local municipality forces make repairs.

Upon Notice to Proceed, The Contractor shall check and make any needed adjustments to time clocks on a monthly basis. No additional payment shall be made for this requirement.

2. Emergency

If the Engineer determines that the signal malfunction or failure is an operational hazard, the Contractor is to take corrective action within three (3) hours of the first attempt of notification. Response shall be considered only when qualified personnel and equipment are provided.

Failure to respond within three (3) hours will result in a non-refundable deduction of money of \$1,000.00 with an additional charge of \$500.00 per hour after the first three (3) hours until qualified personnel and equipment arrives on site and begins corrective action.

In addition, the cost of labor and material will be charged by the Department if the Department takes corrective action using its own forces or local municipality forces.

Total charges will not exceed \$5,000.00 (per emergency call) in addition to the material cost and labor incurred to make repairs by the Department or local municipality forces responding to the malfunction.

The Department will not be held responsible or liable for any alleged damage to the signal or as a result of the signal malfunction due to problems that may occur after Department or local municipality forces make emergency repairs.

The Contractor shall be responsible for all materials and equipment necessary to correct signal malfunction or repair.

Final Acceptance will not be given until payment for such work is received.

B. Warranties

Provide manufacturer's warranties or guarantees on electrical, electronic, or mechanical equipment furnished, except state-supplied equipment.

Ensure that warranties and/or guarantees are consistent with those provided as customary trade and industry standard practices; or as otherwise specified in the Plans, Standard Specifications, or Special Provisions.

Upon Final Acceptance, transfer the manufacturer and Contractor warranties or guarantees to the Engineer. Ensure that warranties are continuous and state that they are subject to transfer.

Acceptance or approval of the Work does not waive warranties or guarantees where required by the Specifications. Final Acceptance will not be granted until all warranties and guarantees are received.

C. Guarantees

Repair and/or replace all equipment and material supplied under these Contract Documents which has been determined by the Engineer to not meet Specifications.

The Engineer reserves the sole right to determine suitability or unsuitability of the supplied equipment and material. The Contractor shall bear the total cost of delivery and transportation related to the repair and replacement of equipment and material throughout the duration of the Contract unless otherwise approved by the Engineer.

Transfer to the Engineer any warranties and guarantees remaining on all items after Final Acceptance. Perform transfer at 12:01 AM of the day following Final Acceptance.

647.4 Measurement

647.4.01 General

Traffic signal items complete, in place, and accepted of the kind, size, and type specified are measured as follows:

A. Traffic Signal Installation

Signal installation will be paid for by lump sum, including furnishing labor, materials, tools, equipment, and incidentals required to complete the work unless otherwise specified in this Subsection.

B. Communications Wire, Fiber Optic Cable

The number of feet (meters) of communications cable, wire or fiber optic cable is the actual number of linear feet (meters) of the size installed and accepted. Communications cable shall be paid for under Section 935.

B. Strain Poles, Traffic Signs

Highway signs are measured and paid for under Section 636. Strain poles are measured and paid for under Section 639.

C. Type 4, 4S, 5, 5S, 6 and 7 Pull Boxes

The number of pull boxes will be the actual number of pull boxes installed and accepted.

D. Loop Detector – Maintenance Milling and Resurfacing Projects

The number of loop detectors will be the actual number of loop detectors installed as specified in the Plans or as directed by the Engineer and accepted. Loop detector lead-in cable will not be measured separately for payment but will be included in the price submitted for Loop Detectors.

647.4.02 Limits

General Provisions 101 through 150.

647.5 Payment

647.5.01 General

The lump price bid for Traffic Signal and/or Ramp Meter Installation covers all Items of work in this Specification including furnishing labor, materials, tools, equipment, and incidentals required to complete the work.

Costs for installation, operation, maintenance, and removal of the traffic signal equipment are included under this Item.

Include payment for removal; disposal of existing pavement, shoulder surface, base and sub-grade; and restoration to original condition in the Contract Price for the items to which they pertain. They will not be paid for separately.

Furnishing, installing, and removing sheeting, bracing, and supports will not be paid for separately, but is included in the Contract Prices for other items.

No additional payment will be made for testing and storing State-supplied or Contractor-furnished traffic signal equipment.

No payment will be made for individual items unless a pay item is included in the Plans for the specific item.

Type 4, 4S, 5, 5S, 6, and 7 pull boxes will be paid for per each. Loop Detector will be paid for per each.

Payment will be made under:

Item No. 647	Traffic signal installation no-	Per lump sum
Item No. 647	Pull Box PB4	Per each
Item No. 647	Pull Box PB4S	Per each
Item No. 647	Pull Box PB5	Per each
Item No. 647	Pull Box PB5S	Per each
Item No. 647	Pull Box PB6	Per each
Item No. 647	Pull Box PB7	Per each
Item No. 647	Loop Detector	Per each

Payment for various elements of traffic signals will be as shown on the Plans.

A. Partial Payment

The Contractor may initiate a partial payment process for the lump sum traffic signal Items by submitting a written request to the Engineer. If the Engineer approves this request, payment will be made as follows:

Underground (loops, pull boxes, and conduits)	20%
Overhead (span, heads, poles, push buttons)	30%
Cabinet, contents, and base	20%
Successful completion of operational test	10%

B. Additional Items

Payment Items related to Section 647 are described in the following sections:

Strain Poles	Section 639
Highway Lighting	Section 680
Lighting Standards and Luminaries	Section 681
Electrical Wire, Cable, and Conduit*	Section 682
Grassing	Section 700
Timber Poles	Section 639 and Subsection 861.2.02
Sign Blanks	Section 912
Reflectorization Materials	Section 913
Traffic Signal Equipment/Ramp Metering Equip	Section 925
* Payment for conduit installation shall be as described in Section 682 unless conduit installation is performed as part of a traffic signal installation, in which case measurement and payment is a part of the complete traffic signal installation. Payment is Lump Sum, unless listed as a separate pay item.	

647.5.02 Adjustments

General Provisions 101 through 150.

Office of Traffic Operations

**DEPARTMENT OF TRANSPORTATION
STATE OF GEORGIA**

SPECIAL PROVISION

**PROJECT NO.: 0016-01(092), ROCKDALE COUNTY
P.I. NO.: 0013163**

SECTION 628—PERMANENT SOIL NAILED WALLS

628.1 General Description

This work includes furnishing materials, labor, tools, equipment, and other incidental items to design, detail, and construct a soil nailed wall. This Specification also applies to any Contractor-proposed alternate design of Department-furnished plans.

628.1.1 Definitions

Soil Nail - Synonymous with nail or soil reinforcing

The term Soil Nailed Wall includes the following items:

- Soil nails
- Nails
- Shotcrete (pneumatically applied concrete) – for temporary facing
- Cast-in-place reinforced concrete facing – for permanent facing
- Drainage

628.1.2 Related References

A. Standard Specifications

Section 500 - Concrete Structures
Section 511 - Reinforcement Steel
Section 853 - Reinforcement and Tensioning Steel

B. Referenced Documents

General Provisions 101 through 150.

628.1.3 Submittals

A. Proof of Ability

Submit the following proof of ability (or ability of the subcontractor) when requested by the Department to design or construct soil nailed walls:

- Evidence of successfully completing at least 5 projects similar in concept and scope to the proposed wall.
- Resumes of foremen, nail testing personnel, and drilling operators to be employed on this project. Show the type, length, and number of soil nails each has installed or tested within the past 5 years.
- Evidence of experience in nail testing. Persons performing nail testing shall prove experience by performing sample tests supervised by the Engineer.

The Department is the sole judge of the qualifications of the foreman, drilling operator, and testing personnel. Do not begin wall construction until the Engineer has approved proof of ability.

B. Design Criteria for Alternate Design

If the department receives more than 2 submittals of the Plans and calculations for review, the Contractor will be assessed \$60 per hour of engineering time for reviews in excess of the 2 submittals.

C. Construction Drawings and Design Notes

Submit construction drawings and design notes within 28 days of the award of the Contract. The Design Engineer shall prepare and stamp the submission. Include design notes and reproducible drawings in the submission concerning the following:

- Details, dimensions, and schedules of reinforcing steel including dowels and/or studs for attaching the facing to the soil nailed wall.
- Details of the shotcrete installation and nails, including the thickness of shotcrete and spacing and angle of installation of nails.
- Detailed plans for testing of nails showing loading and measuring devices to be used and procedures to be followed.

D. Final Wall Plans and Calculations

Submit final wall plans and calculations to the Department for review and approval before beginning construction on the wall. The time required for Plan and calculation review will be charged to the allowable Contract time. The Department has 30 days for Plan and calculation review per item after receiving the structure calculations and drawings.

New submittals from the Contractor showing corrections from the Department's review or changes to ease construction or to correct field errors have a 30-day review. The Department is the sole judge of information adequacy.

The Department's review and acceptance of the final Plans and construction methods do not relieve the Contractor from successfully completing the work. Time extensions are not granted for Contractor delays from untimely submissions or insufficient information.

E. Admixture Literature

Before using an admixture, submit the manufacturer's literature to the Engineer. Indicate the admixture type and the manufacturer's recommendations for mixing the admixtures with grout.

628.2 Materials

A. Concrete

Use concrete conforming to Section 500.

B. Reinforcing Steel

Use reinforcing steel conforming to Section 511. Reinforcing steel used as soil nails shall be full length. Couplers will not be allowed.

C. Structural Steel

Use structural steel shapes or plates conforming to Section 501. Use ASTM A 709 Grade 36 (Grade 250) structural steel unless otherwise specified on the plans.

D. Cement Grout

Produce cement grout using Portland cement conforming to AASHTO M-85, Type I, II, or III, and potable water. Use cement that is fresh and free of lumps and hydration.

Follow these restrictions if using admixtures:

1. Do not use admixtures with chemicals that may harm the soil nail, reinforcing steel, or cement.
2. Do not use admixtures that cause air bubbles in the grout.
3. If approved by the Engineer, use admixtures imparting low water content, flowability, and minimum bleeding in the cement grout.

E. Plastic

Use Polyethylene conforming to AASHTO M-252 with a minimum wall thickness of 30 mils (0.76 mm) for corrosion protection.

F. Shotcrete

Use shotcrete conforming to the following:

1. Cement – Section 830.2.01 Type I, II or III.
2. Fine Aggregate – Section 801.2.02.
3. Coarse Aggregate – Section 800.2.01.
4. Fly Ash – Section 831.2.03
5. Silica Fume – AASHTO M-307.
6. Air Entraining Admixtures for wet mix – Section 831.2.01.
7. Plasticizers – AASHTO M-194, Type A, D, F, G.
8. Use accelerating admixtures that are compatible with the cement, are non-corrosive to steel and do not promote other detrimental effects such as cracking and excessive shrinkage and do not contain calcium chloride. Use admixtures in accordance with the manufacturer's recommendations. Silica fume, if used, shall not exceed 10 percent of the cement weight and shall be an admixture with a minimum of 90 percent SiO₂ with a proven record of performance in shotcrete.
9. Use water in shotcrete that is potable, clean, free from substances which may be injurious to concrete and steel, and is free of elements which would cause staining.
10. Provide premixed and prepackaged concrete products specifically manufactured as a shotcrete product for on-site mixed shotcrete, if approved by the engineer. The packages shall contain cement and aggregates conforming to Section 500.

G. Corrosion Inhibitor

Use corrosion inhibitor (grease) conforming to the following:

1. Drop point 300 degrees F (149 degrees C) minimum by ASTM D-566.
2. Flash point 300 degrees F (149 degrees C) minimum by ASTM D-92.
3. Water content 0.1% maximum by ASTM D-95.
4. Rust test – Rust Grade 7 or better after 720 hours, aggressive conditions: Rust Grade 7 or better after 1000 hours by ASTM B-117 and ASTM D-610.
5. Water soluble ions.

Chlorides	10 ppm maximum	by ASTM D-512
Nitrates	10 ppm maximum	by ASTM D-3867
Sulfates	10 ppm maximum	by APHA 427D (15 th ED)
6. Oil separation – 0.5% by weight maximum at 160 degrees F (71 degrees C) by FIMS 719B, Method 321.2.
7. Soak test – 5% Salt Fog at 100 degrees F (38 degrees C), 5 mils (0.13 mm) (Q Panel Type S), immerse panels in 50% salt solution and expose to 5% Salt Fog – no emulsification after 720 hours by ASTM B117 Modified.

628.2.01 Delivery, Storage, and Handling

A. Protection Systems

Protect soil nails against corrosion by properly storing, fabricating, and handling the nail components before inserting them into the borehole. Avoid prolonged exposure of the nail components to the elements, and avoid mechanical or physical damage that reduces or impairs the component's ability to resist adverse conditions during service. Nail components will be rejected for heavy corrosion or pitting, but not for a light coating of rust.

Use the protection systems as follows:

1. Soil Nail

Protect the entire length of the soil nail from the anchor plate to the end of the nail from corrosion.

- a. Encase the nail in a corrugated plastic tube.
- b. Use cement grout to fill the voids between the tube and the nail and the tube and the soil. Place cement grout between the soil and the tube to at least ¼ in (20 mm) thick and extend the entire length of the nail. Cement grout between the tube and the nail shall be a minimum of ½ in (12 mm) thick
- c. Provide centralizers spaced at a maximum of 5 feet (1.5 m) center-to-center throughout the nail length. Do not use wood or material harmful to the soil nail or the corrugated plastic tubing as centralizers.
- d. Provide a smooth piece of plastic sheath to encapsulate the entire free length. Do not splice the sheath. Ensure that the sheath is at least 0.05 in (1.27 mm) thick. Provide a void space between the sheath and the steel as shown on the plans and maintain that space with centralizers. Fill visible void space with grease and seal the bottom to prevent grout intrusion.

2. Area Underneath Anchorage

Protect the area immediately behind the stressing anchorage.

- a. Weld a pipe sleeve to the bearing plate and seal the pipe sleeve to the anchor sheath at the other end of the sleeve.
- b. Clean the pipe sleeve to remove dirt, rust, or other harmful material before inserting the soil nail into the pipe sleeve.
- c. If a seal is not provided at the lower end of the pipe sleeve, during installation and grouting, fill the lower end of the pipe sleeve with grout. Keep the pipe sleeve free of harmful material until the upper portion of the pipe sleeve and anchor head are filled with grout.
- d. Fill the void inside the sleeve and anchor head with anti-bleed expansion grout after the nails have been stressed.

3. Anchorage

Encase the anchorage system head into a corrosion protective system before proceeding to the next lift. Install the protective system for each lift within 30 days after installing the nails for that lift. Ensure that the anchorage system has a cover of at least 3 in (75 mm) once the wall face is placed.

628.3 Construction Requirements

628.3.1 Personnel

A. Contractor Qualifications

The Contractor and Subcontractor shall be experienced in constructing permanent soil nailed walls. Provide at least one Registered Professional Engineer licensed to perform work in the State of Georgia and a supervising Engineer for the Project with at least 5 years of experience in constructing permanent soil nailed walls.

Furnish verification of these qualifications to the Engineer before beginning operations.

B. Design Engineer

The Design Engineer shall:

- Be registered as a Professional Engineer in the State of Georgia
- Have considerable knowledge and experience designing and constructing soil nailed walls
- Be available at any time during the Contract to discuss the design of the walls with the Department.

C. Registered Professional Engineer

Retain the services of a second Professional Engineer licensed to perform work in the State of Georgia and prequalified by the Department. The Engineer shall operate independently from the Professional Engineer of Subsection 628.3.01.B, "Design Engineer."

This Engineer will independently check the design calculations and Plan details for the permanent soil nailed wall before submitting them to the Department.

628.3.2 Equipment

Use anchorage and hardware suitable for the type of soil nails used. Ensure that the anchorage and hardware are capable of the following:

- Developing 75 percent of the yield capacity of the nails when tested in the unbonded state and without failure of the nail
- Holding the soil nail at a load producing a stress of not less than 75 percent of the yield capacity of the nail without exceeding the anticipated set and without causing anchorage or soil nail failure
- Test nails shall be capable of lifting-off, detensioning, or retensioning a nail before secondary grouting to fill voids at the top of the pipe sleeve.

628.3.3 Preparation

Before beginning the work, survey the condition of the adjoining properties. Keep records and photograph settlement or cracking of adjacent structures that may become the subject of possible damage claims. Deliver the report to the Department before beginning work at the site.

Obtain a Foundation Investigation Report from the Geotechnical/Environmental Bureau of the Department to assist in evaluating existing conditions for design and construction.

628.3.4 Fabrication

A. Soil Nails

Fabricate the soil nails according to the approved details.

1. Keep the nails free of dirt, rust, and other harmful substances.
2. Use a plastic sheath that is a single piece without splices.
3. Before installation, handle and store the nails so as to avoid corrosion and physical damage. Nails will be rejected for damage such as abrasions, cuts, nicks, welds, weld splatters, or heavy corrosion and pitting. Replace the nails at the Contractor's expense for material replacements or time delays.

628.3.5 Construction

A. Design Criteria

The design criteria for a proposed design or design include:

1. Design soil nails according to this Specification.
2. Use reinforced concrete facing according to the latest AASHTO Standard Specifications for Highway Bridges, including interims. Ensure that the structural thickness is at least 12 in (300 mm). Provide architectural facing treatment as shown on the Department drawings.
3. Ensure that the concrete strength is at least 3000 psi (20 MPa) 28-day strength. Extend the facing 2 ft (600 mm) below the gutterline or, if applicable, the ground line adjacent to the wall unless otherwise indicated on the Department Plans.
4. Design and install permanent drainage systems behind the wall. Connect the drainage systems to the nearest drop inlet using pipe or free drainage through traffic barriers or other obstructions. Ensure that holes through traffic barriers and/or facing are no higher than 3 in (75 mm) above the gutterline or ground line.
5. Ensure that the wall is compatible with the horizontal and vertical criteria indicated in the Department Plans.
6. Provide a wall design that is adequate to resist sliding, overturning and bearing forces. Safety factors shall be as follows:

Sliding	1.50
Overturning	2.00
Bearing	1.00
7. Design the wall for the design condition shown in Figure 1.
7. See Figure 3 for typical section of permanent soil nail wall.

B. Ground Movements and Load Transfer Instruments

During construction of the wall, the Department may install devices to monitor ground movements and load transfers during or after construction. The Department will schedule installation to minimize interference with the Contractor's operations. Cooperate with the instrumentation installers. Anticipate delays of two to four hours per instrumented nail.

Although the Instrumentation Specialist maintains the instruments, assume responsibility for damage to the instruments, connections or readouts from operations. Replace and install damaged equipment at the Department's approval and at the Contractor's expense.

C. Soil Nail Installation

Install the soil nails as follows:

1. Before installation, visit the site to observe existing conditions that may affect the work or design, if applicable, and to review the geotechnical data available for the Project.
2. Drive or drill the holes for the soil nails by core drilling, rotary drilling, auger drilling, or percussion drilling. If using water in the drilling operation, dispose of the water to minimize wall erosion. Repair water erosion damage to the site at no cost to the Department.
3. If the hole will not stand open, install casing to maintain a clean and open hole. Ensure that the hole diameter is at least 3 in (75 mm) if no pressure grouting is used. Pressure grouting is grouting with a pressure greater than 60 psi (415 kPa).
4. Ensure that the drill bit diameter is not more than 1/8 in (3 mm) smaller than the specified hole diameter.
5. Start soil nail holes within an angle tolerance of 3 degrees from the inclination specified on the approved design Plans. Do not allow the holes to deviate from a straight line by more than 2 in (50 mm) in 10 ft. (3 m). Holes shall not extend past the permanent easement limits shown on the plans. Thoroughly clean the holes of all dust, grease, or other deleterious material before inserting the nail.

6. Install the nail in the casing or the hole drilled for the nail. Ensure that the nail's corrosion protection is not damaged during handling or installation.
7. Install the nail in the bond length to achieve at least 1½ in (38 mm) of grout cover.
8. Do not use nails to ground electric equipment and do not subject the nails to sharp bends.
9. Provide centralizers spaced a maximum of 5 ft (1.5 m) center to center throughout the nail length. Do not use spacers of wood or other material harmful to the nail or corrosion protection.
10. Inject grout at the lowest point of the nail and place over the entire length of the nail.
 - a. Ensure that the grouting equipment can continuously mix and produce lump-free grout. Equip the grout pump nozzle with a grout pressure gauge capable of measuring pressure of at least 150 psi (1 MPa) or twice the actual pressure used.
 - b. Base the material proportions used in the grout on grout tests made before beginning grouting; or select the proportions based on prior documented experience with similar materials and equipment under comparable field conditions.
 - c. Use the minimum water content necessary for proper placement and do not exceed a water-cement ratio of 0.45. Do not leave the grout in the mixer longer than 45 minutes.
11. After grouting, do not disturb the nail until the grout has reached a cube strength of 3500 psi (25 MPa). Keep the mouth of the hole clean after grouting. Record the following data in a Project field book during the grouting operation:
 - Type of mixer
 - Water-cement ratio
 - Type of additives
 - Grout pressure
 - Type of cement
 - Test sample strengths (before stressing)
 - Volume placed in bond and free lengths
12. If using pressure grouting, choose whether to perform a water-tightness test. However, if injecting grout with a pressure of 60 psi (415 kPa) or less, always perform a water-tightness test. Perform the test as follows:
 - a. Fill the entire hole in the rock with water and subject it to a pressure of 5 psi (35 kPa) in excess of the hydrostatic head as measured at the top of the hole.
 - b. If after 10 minutes the leakage rate from the hole exceeds 0.001 gal per inch diameter per foot of depth per minute (0.5 ml per mm diameter per meter of depth per minute), consolidate grout, redrill, and retest the hole. If the second water-tightness test fails, repeat the entire process.
 - c. During the tests, observe holes adjacent to the hole being tested for water-tightness to detect and seal inter-hole connections.
 - d. If artesian or flowing water is encountered in the drilled hole, maintain the pressure on the consolidation grout until the grout has initially set.

D. Temporary Shotcrete Facing

Provide temporary shotcrete facing.

1. Shotcrete Quality - Produce the shotcrete by the wet mix process and achieve a minimum compressive strength of 3000 psi (20 MPa) in seven (7) days and 4600 psi (32 MPa) in 28 days.
2. Mixture Proportions - Submit for acceptance the recommended mixture proportions, strength results, water cement ratio, and source of materials. Select the mixture proportions based on compressive strength tests of specimens continuously moist cured until tested at 28 days in accordance with AASHTO T-22. Use a maximum water cement ratio of 0.40, air content of 6.5% ± 1.5%, slump of 1.5 to 3 inches (38 to 50 mm). The mixture is acceptable if the average core compressive strength is at least 1.2 times the required compressive strength in 628.4.07.A above.
3. Batching and Mixing - Batch aggregate and cement by weight or by volume. Provide mixing equipment capable of thoroughly mixing the materials in sufficient quantity to maintain placing continuity. Provide ready-mix shotcrete complying with AASHTO M-157.
4. Delivery Equipment - Provide equipment capable of delivering the premixed materials accurately, uniformly and continuously through the delivery hose. Follow the recommendations of the equipment manufacturer on the type and size of nozzle to be used, and on cleaning, inspecting and maintaining the equipment. Deliver ready-mix shotcrete in transit mixers that comply with AASHTO M-157. Provide a supply of clean, dry air adequate for maintaining sufficient nozzle velocity for all parts of the work and, if required, for simultaneous operation of a suitable blow pipe for clearing away rebound. Provide a compressor capable of providing a minimum of 315 cfm (8.9 m³/min) per operating nozzle.

5. Curing:
 - a. Keep shotcrete continuously moist for 24 hours after completion by one of the following methods or materials:
 - Continuous sprinkling
 - Absorptive mat or fabric, or other covering kept continuously moist
 - Curing compounds in accordance with Section 500.3.05.Z. On natural gun or flash finishes, apply one gallon per 100 square feet (0.4 l per square meter). Do not use curing compounds on any surfaces against which additional shotcrete or other cementitious finishing materials are to be bonded unless positive measures, such as sandblasting, are taken to completely remove curing compounds prior to application of such additional materials.
 - b. Provide final curing immediately following the initial curing and before the shotcrete has dried by one of the following materials or methods:
 - Continuation of the method used in the initial curing
 - Application of impervious sheet material conforming to AASHTO M-171.
 - c. Continue curing for the first seven days after shotcreting or until the required seven-day strength is obtained. During the curing period, maintain the shotcrete above 38 degrees F (3.3 degrees C) and in a moist condition as specified.
6. Construction Testing - Cut cores from the structure and test in accordance with AASHTO T-24. Take a minimum of three cores from each 1000 square feet (93 square meters) of completed facing. Alternatively, construct a test panel with minimum dimensions of 18 X 18 X 4 in (450 X 450 X 100 mm) gunned in the same position as the work represented for each 1000 square feet (93 square meters) of completed facing. The Contractor's regular nozzle men shall gun the panels during the course of the work. Field cure the panels in the same manner as the work, except that the test panels shall be soaked for a minimum of 40 hours prior to testing. Cut a minimum of three cores from each panel for testing in accordance with AASHTO T-24. The average compressive strength of each core of a set of three cores must equal or exceed 85 percent of the compressive strength specified in 628.3.05.A.

E. Permanent Cast-In-Place Facing

Provide permanent cast-in-place reinforced concrete facing in accordance with the requirements of this specification, as shown in the plans and the following:

1. Provide vertical expansion joints at a maximum spacing of 90'-0"
2. Provide vertical contraction or construction joints at a maximum spacing of 30'-0"
3. Form vertical rustication grooves at a maximum spacing of 10'-0". Rustication grooves are to be equally spaced between expansion joints and coincide with construction joints.
4. Provide studs in the construction of the soil nail system for anchoring the cast-in-place facing.

628.3.6 Quality Acceptance

A. Nail Testing and Acceptance

Perform testing according to this subsection.

Perform load tests on at least 5% of the nails in each row to verify the soil-to-grout bond stress used in the design.

Provide separate nails specifically for the purpose of testing. Test nail locations shall be approved by the Engineer. Test nails will not be considered part of the permanent support system. Install the test nails in accordance with Figure 2.

Grout only the bonded length of the nail prior to testing. Provide and use the following testing equipment:

- A dial gauge that can measure elongation to the nearest 0.001 in (0.025 mm)
- A hydraulic jack and pump with a pressure gauge graduated in increments of 100 psi (690 kPa) or less.

Test by incrementally loading the nail according to the following schedule:

- AL
- 0.25P
- 0.50P
- 0.75P
- 1.00P
- 1.25P
- 1.50P

where:

AL = minimum load required to support the jacking system tightly against the bearing surface = 2 kips (8.9 kN).

P = design load

Measure the nail movement with the dial gauge fixed to an independent reference point. Apply the load with a hydraulic jack and measure it with a hydraulic pressure gauge. Increase the load from one increment to the next immediately after the nail movement is recorded.

Hold the maximum test load for ten (10) minutes. Start the load hold period as soon as the maximum test load is applied, and measure the nail movements at one (1), two (2), three (3), four (4), five (5), six (6), and ten (10) minutes. The nail test is acceptable if the nail carries the maximum test load with less than 0.08 in (2 mm) of movement between one (1) and ten (10) minutes.

If the nail fails the test, determine the cause. If the failure indicates that the nails will not achieve the design soil-to-grout bond stress, then modify the design and/or construction procedures. These modifications may include, but are not limited to, installing replacement nails, reducing the design bond stress by increasing the number of soil nails or by lengthening the nails, or modifying the installation methods. After modifications, test the nails for acceptance of the new design.

Make the modifications of the design and/or construction procedures at no cost to the Department unless the modifications are due to changed conditions.

After completion of testing and determination of acceptance, tension all test nails and all nails shall be tensioned to 200 ft-lb (270 N-m) of torque.

628.4 Measurement

Permanent Soil Nailed Walls are not measured separately for payment.

628.5 Payment

Payment for this work is made per Lump Sum. Payment includes costs for concrete, reinforcing steel, excavation, backfill, shotcrete, soil nails, anchorages, labor, design, and all other materials and equipment. Payment also includes grouting, drilling holes, performing and evaluating all tests, submitting records of tests, all tools and all other items to complete the work.

Payment will be made under:

Item 628	Permanent Soil Nailed Wall, wall no. ____	Per lump sum
----------	---	--------------

628.5.01 Adjustments

Additional wall area required because of unforeseen foundation conditions or other reasons that are approved by the Engineer will be paid for by adjusting the Lump Sum Price Bid. If the wall area is increased or decreased, the Lump Sum Price Bid will be adjusted proportionally based on the change in wall area as determined from the stations, elevations and dimensions on the Plans.

No additional compensation will be made for additional material, equipment, design, or other items to comply with the Project specifications as a result of the Department's review of the contractor's design.

OFFICE OF BRIDGE DESIGN

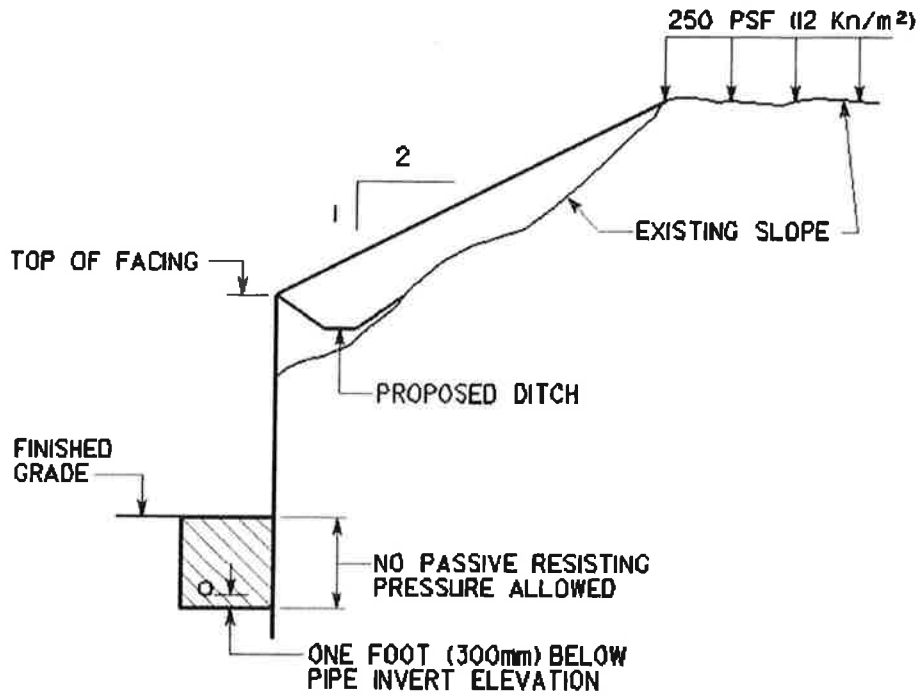

DESIGN CONDITION

FIGURE 1

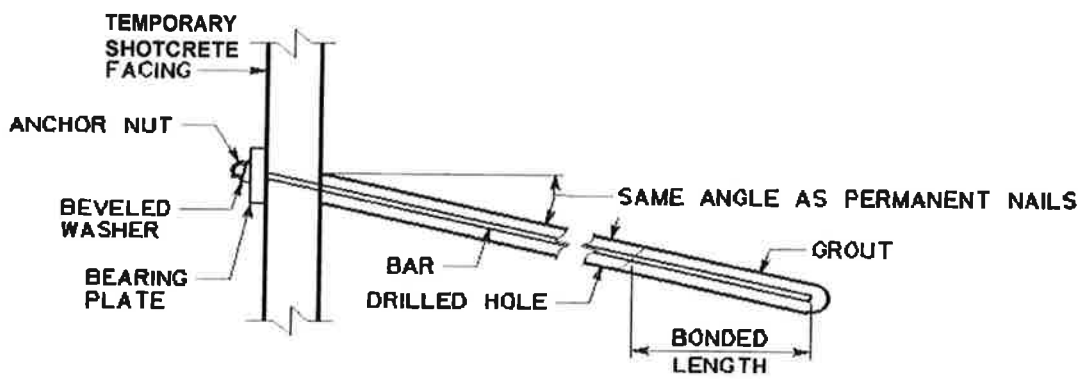

TEST NAIL DETAIL
NO SCALE

FIGURE 2

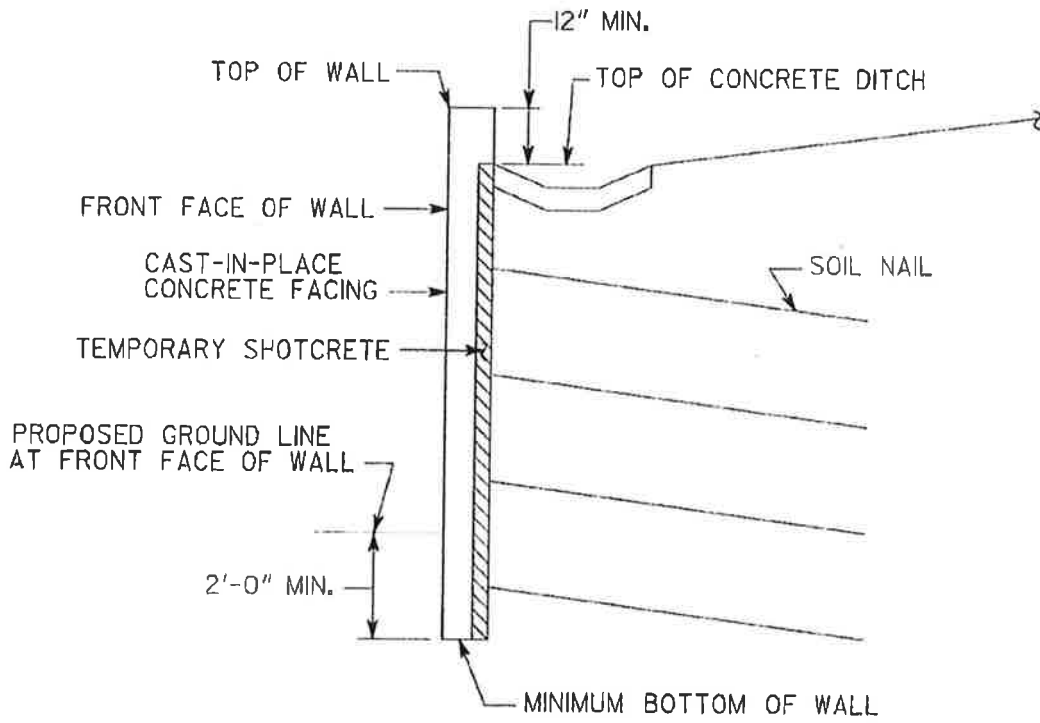

FIGURE NO. 3

Georgia Department of Transportation
State of Georgia
Special Provision

Sigman Road Widening
NHIM0-0016-01(092), P.I. 0013163, Rockdale County

Section 687 - Traffic Signal Timing

Add the following:

687.1 General Description

Develop and implement, by a prequalified Contractor/Consultant, a traffic signal operating plan that provides safe and efficient operation of the Intersections defined in Table 687-4. As a MINIMUM, this work will include:

- Coordinate with local GDOT District and/or local government(s) to gather agency preferred timing parameters and expectations, and to facilitate a smooth transition from existing signal timing plans to new signal timing plans.
- Evaluation of existing traffic operations, system equipment functionality, and inventory of assets.
- Collect two-hour turning movement counts (TMC's) for the AM, mid-day, and PM peak periods at each Intersection. For contractor timing projects (if approved by the Engineer AND the signals reside in a rural area), one-hour TMC's may be collected in lieu of two-hour TMC's.
- Collect directional (tube) counts (7-day/24-hour) per control section, as appropriate or as recommended by the Engineer. A minimum of one (1) directional count is required and additional directional counts are needed if the number of intersections exceeds seven (7) or if there are significant changes in traffic volumes along the corridor.
- Develop, implement and fine-tune a minimum of four (4) signal timing plans per control section, unless otherwise specified by the Engineer. In most cases, more than the minimum required will be needed to successfully complete the project.
- Develop additional timing plans as needed, including holiday, seasonal, weekend and other special plans as requested by the Engineer. The number of additional plans shall be discussed as part of the kickoff meeting. For contractor timing projects, the Consultant will need to address this item prior to providing a fee to the contractor(s).
- Conduct before/after studies and prepare project performance measures to detail signal timing improvements.

687.1.01 Definitions

Use the following definitions for purposes of this section:

- **Prequalified Contractor/Consultant:** One who is qualified to perform work in Area Class Codes 3.06, 3.07, and 3.09 in the Department's Consultant Prequalification regulations.
- **Signal Timing Plan:** A unique combination of cycle length/split/offset for all Intersections within a system or control section.
- **Control Section:** Any portion of a traffic control system, which can be controlled by a single set of timing parameters and in which all Intersections change timing patterns at the same time.
- **Engineer:** The State Signal Timing Engineer or District Traffic Engineer for the District in which the Intersections are located.
- **Intersections:** All the Intersections listed in Table 687-4. In the event there are no Intersections listed, the Contractor/Consultant shall request the list of Intersections to be re-timed from the maintaining agency.

- **Directional (tube) Count:** The measurement of the total traffic volume traveling a roadway in a single direction.
- **Turning Movement Count (TMC):** The measurement of the directional traffic volume traveling through an individual Intersection.
- **Before/After Study:** The measurement of the travel time, stops, and emissions through a control section and the comparison of the before versus after data. "Before" data is gathered prior to making any changes. "After" data is gathered once the new timing plans are implemented, fine-tuned and accepted by the Engineer.
- **Approved or Approval:** Written notice (via letter, memorandum or email) from the Engineer or his designated representative.

687.1.02 Related References

A. Standard Specifications

Section 108 – Prosecution and Progress

Section 647 – Traffic Signal Installation

Section 925 – Traffic Signal Equipment

687.1.03 Submittals

In the sequence and order listed, submit one (1) electronic (.PDF) copy to the Engineer for review and approval. Approval of each submittal must be obtained before conducting work on subsequent submittals. *Hard copies of any/all reports may be requested by the Engineer and/or maintaining agency.*

1. Kickoff Meeting
2. Preliminary Timing Report
3. Final Timing Report
4. Project Closeout

Note: Signal timing performed as part of a GDOT construction project should be submitted to the signal contractor for submission to the Engineer. This will ensure the project inspector from the respective GDOT area office, or from the consulting firm performing project inspections for GDOT, is knowledgeable for purposes of payment requests.

See Table 687-3 for workflow chart.

687.2 Materials

687.2.01 Software

The Department will not provide resources to fulfill any Contractor obligations under this Special Provision. The Department will not furnish any software or equipment for the development and implementation of timing plans. Obtain all necessary licensed software, equipment and materials to support this work effort.

687.3 Construction Requirements

687.3.01 Kickoff Meeting

A kickoff meeting, in person or via conference call (however preferred by the Engineer), with the Engineer and any other parties involved in the timings will be conducted to determine locations to collect Directional Counts, time of day to collect TMC's, travel run routes, local jurisdiction timing preferences, project schedule, whether or not to develop traffic responsive timing plans, and overall project expectations.

After the meeting is complete, an email submission of the meeting minutes shall be sent to all parties involved for verification of project decisions. A project schedule and graphic depicting approved locations for TMCs and Directional Counts should also be submitted as part of the meeting minutes. An example of a system map with count locations is shown in Exhibit 687-3.

At this time, "Before" travel time runs should be collected per the route(s) agreed upon at the Kickoff Meeting. TMC's and Directional Counts should also be collected as agreed upon in the Kickoff Meeting.

687.3.02 Preliminary Timing Report

Visit all Intersections listed in Table 687-4 during the AM, MD and PM peak traffic periods (weekends may also be required) in order to make qualitative assessments of Intersection operation. Make note of queue length, delays, conflicts or any other operational characteristics that should be considered in evaluating and developing coordinated traffic signal timing plans. Make note of the surrounding land use and traffic generators to gain insight on the daily traffic patterns of motorists in the area.

Develop a traffic signal Preliminary Timing Report containing, but not limited to the following data:

1. Intersection Inventory
2. Clearance Calculations
3. Methodology for Evaluating Performance Measures
4. Existing System Evaluation and Operational Analysis
5. Traffic Count Data in Summarized Form
6. Raw Count Data
7. Proposed Time of Day Plans and Comparison to Existing
8. Modeling Analysis and Proposed Improvements

687.3.02.01 Intersection Inventory

Prepare an inventory of the conditions at each Intersection and collect all data required to effectively devise a signal timing plan for the Intersections. Inventory the Intersection configuration, signing and marking, marked and unmarked crosswalk distances, turn lane storage lengths, signal phasing and signal timing at all Intersections as well as any other data required to complete the system timing plans. The minimum limits of this inventory include the vehicle detection locations. The purpose of the inventory is for the preparation of signal timing plans, signal system database and system maps. An example of an Intersection Inventory Sheet is shown in Exhibit 687-1. An example of an Intersection Diagram is shown in Exhibit 687-2. For Intersections with new construction, a copy of the project construction plan sheet is acceptable.

All (cabinet, controller, conflict monitor, battery backup, vehicular and pedestrian signals, communications equipment, signs, etc.) equipment must be inventoried and logged into the current version of the GDOT Signal Inventory Database. An example of the data collected is shown in Exhibit 687-2.

687.3.02.02 Clearance Calculations

Calculation of Pedestrian and Vehicular Clearance Values should follow the MUTCD guidelines, unless the local jurisdiction has its own standard for calculating clearances. The clearance time consists of the yellow change interval and the all-red clearance interval that separates phases. Tables 687-1 and 687-2 should be utilized to calculate vehicular clearance intervals.

The intersection diagrams shall detail where the measurements for both vehicular and pedestrian clearance values were taken.

Yellow Clearance Interval: The length of time such that the distance traveled at the 85th percentile speed in that length of time is equal to the distance required to stop from the posted speed limit. It is calculated using the "ITE Formula" where:

$$Y = t + v/(2a + 2Gg)$$

Where:

Y = yellow change interval (seconds)

t = perception - reaction time (seconds) (assume 1 second)

v = design velocity (feet/sec)

a = deceleration rate (feet/sec.²) (assume 10 ft/sec²)

G = acceleration due to gravity (32.2 ft/sec²)

g = grade in decimal form (1 percent = 0.01) {Round UP to nearest grade}

Table 687-1 Yellow Clearance Time (Y) Chart (Seconds)

		GRADE (PERCENT)											
		5	4	3	2	1	0	-1	-2	-3	-4	-5	
SPEED (MPH)	25	3.0	3.0	3.0	3.0	3.0	3.0	3.0	3.0	3.0	3.0	3.1	3.2
	30	3.0	3.0	3.0	3.1	3.1	3.2	3.3	3.4	3.4	3.5	3.6	3.6
	35	3.2	3.3	3.3	3.4	3.5	3.6	3.7	3.7	3.8	4.0	4.1	4.1
	40	3.5	3.6	3.7	3.8	3.8	3.9	4.0	4.1	4.3	4.4	4.5	4.5
	45	3.8	3.9	4.0	4.1	4.2	4.3	4.4	4.5	4.7	4.8	4.9	4.9
	50	4.2	4.3	4.4	4.5	4.6	4.7	4.8	4.9	5.1	5.2	5.4	5.4
	55	4.5	4.6	4.7	4.8	4.9	5.0	5.2	5.3	5.5	5.6	5.8	5.8
	60	4.8	4.9	5.0	5.1	5.3	5.4	5.6	5.7	5.9	*	*	*
	65	5.1	5.2	5.4	5.5	5.6	5.8	5.9	*	*	*	*	*
	70	5.4	5.6	5.7	5.8	6.0	*	*	*	*	*	*	*

*Minimum Yellow Clearance Time should be 3.0 seconds. If the calculated yellow clearance time is greater than 6.0 seconds, consult with the Engineer.

All-red Clearance Interval: The length of time needed to clear the intersection based on the vehicle speed. It is calculated using the "ITE Formula" where:

$$R = (w + l)/v$$

Where:

R = All-red Clearance Time (seconds)

w = width of the intersection, stop bar to opposite curb (or crosswalk when the crosswalk is greater than 20' from the intersection) OR the furthest point of conflict (feet)

l = length of vehicle (assume 20 feet)

v = design velocity (feet/sec)

Table 687-2 All-red Clearance Time (R) Chart (Seconds)

		WIDTH OF INTERSECTION (FEET)										
		40	50	60	70	80	90	100	110	120	130	140
SPEED (MPH)	25	1.6	1.9	2.2	2.4	2.7	3.0	*	*	*	*	*
	30	1.5	1.6	1.8	2.0	2.3	2.5	2.7	2.9	*	*	*
	35	1.5	1.5	1.6	1.7	1.9	2.1	2.3	2.5	2.7	2.9	*
	40	1.5	1.5	1.5	1.5	1.7	1.9	2.0	2.2	2.4	2.6	2.7
	45	1.5	1.5	1.5	1.5	1.5	1.7	1.8	2.0	2.1	2.3	2.4
	50	1.5	1.5	1.5	1.5	1.5	1.5	1.6	1.8	1.9	2.0	2.2
	55	1.5	1.5	1.5	1.5	1.5	1.5	1.5	1.6	1.7	1.9	2.0
	60	1.5	1.5	1.5	1.5	1.5	1.5	1.5	1.5	1.6	1.7	1.8
	65	1.5	1.5	1.5	1.5	1.5	1.5	1.5	1.5	1.5	1.6	1.7
	70	1.5	1.5	1.5	1.5	1.5	1.5	1.5	1.5	1.5	1.5	1.6

*All-red Clearance Time should be a minimum of 1.5 seconds. If the calculated red time is greater than 3.0 seconds, the additional time should be added to the Yellow Clearance Time, clearly documented as such, and discussed with the Engineer.

Pedestrian Intervals: Pedestrian clearance times should be calculated in accordance with the current GDOT adopted Manual on Uniform Traffic Control Devices (MUTCD).

The pedestrian intervals consist of a Walk Interval, a Pedestrian Change Interval, and a Buffer Interval. The Walk Interval shall be a walk time of 4-7 seconds minimum. The Pedestrian Change Interval should be the calculated pedestrian clearance interval and may be lowered by the amount of the buffer interval or the vehicle clearance time (yellow and all red). The pedestrian clearance interval is calculated using the distance from curb to curb along a crosswalk divided by a walking speed of 3.5 feet per second. Special considerations may require a slower walking speed to be used to calculate this interval. Buffer Intervals shall consist of the Yellow Change Interval plus the Red Clearance Interval.

687.3.02.03 Methodology for Evaluating Performance Measures

An explanation of the travel run methodology and the software being used to conduct the travel runs will be included as part of this report. Also, once the travel runs are complete, explain the procedure for studying the "Before" and the "After" data to show project costs and benefits. Additional performance measures (for example, arrival rate on green) and analysis methodology should be detailed at this time.

687.3.02.04 Existing System Evaluation and Operational Analysis

An evaluation of current system conditions shall be included in the Preliminary Timing Report. Detail about directionality, queues, existing levels of service, and traffic generators are expected. Demonstrate the current operational characteristics of the system using field collected data and the modeling software approved at the kickoff meeting.

"Before" Travel Runs should be conducted at this time.

687.3.02.05 Traffic Count Data in Summarized Form

After the directional count locations have been approved (in the kickoff meeting), conduct the directional counts. In general, directional counts should be taken along major arterials and may be taken on major side streets if needed. Take directional counts for seven (7) consecutive days, twenty-four (24) hours per day. Use an automatic traffic counter that produces a written record of the count and time of day. Summarize the directional count data on a volume summary form. From the count data, develop a tabular and graphic presentation of directional traffic volumes showing 15-minute interval volumes and hourly interval volumes over the seven consecutive day period. An example of tabular 15-minute interval volumes are shown in Exhibit 687-6 and an example of graphical hourly interval volumes is shown in Exhibit 687-7.

After the TMC locations and time periods have been approved (in the kickoff meeting), conduct the TMC's. Summarize peak hour turning movement counts in fifteen (15) minute increments for one-hour intervals. Differentiate in the turning movement counts between trucks and passenger vehicles, and include pedestrian counts. Summarize the count data on turning movement count forms. An example of turning movement count forms is shown in Exhibit 687-8.

Turning Movement Count Data should also be provided at this time in a summarized form, such as an intersection schematic detailing turning movement counts at intersections where data has been collected.

687.3.02.06 Raw Count Data

Provide all raw count data as collected for the project. This may be included as an appendix item to this report.

687.3.02.07 Proposed Time of Day Plans and Comparison to Existing

Describe how the proposed timing plans and TOD compare to the existing system operation. An example of a timing plan and TOD comparison is shown in Exhibit 687-9.

Proposed Timing Plans shall be listed and described individually detailing traffic conditions while the plan is running and what the plan is attempting to achieve. An operational analysis shall be included that details the existing operation and how the proposed timing plans will improve the performance of the signal system. The modeling software files shall also be submitted for review.

687.3.02.08 Modeling Analysis and Proposed Improvements

Develop software models of the proposed timing plans with approved software by the Department. Evaluate each proposed timing plan with the modeling software based on proposed performance measures. Summarize the proposed improvements in tabular or graphical form, clearly demonstrating the before conditions of the project and the proposed after conditions as reported through software modeling. This can be done through approved performance measures, such as Level of Service (LOS), queue analysis, number of stops reduction, overall delay reduction, travel time reduction, emissions reductions, arrival rate on greens, and any other industry accepted metric.

Submit one (1) electronic (.PDF) copy of the Preliminary Timing Report to the Engineer for review and approval. Obtain written approval of the Preliminary Timing Plan Report prior to implementation.

687.3.03 Timing Plan Implementation and Fine Tuning

687.3.03.01 Database Development and Testing

Determine values for all controller parameters (local and coordination) and prepare the system database for the Intersections listed in Table 687-4. Include the entire database for the local and master controllers, as well as central server settings.

Each of the proposed timing plans shall be tested prior to field implementation. Testing results shall be documented and included as part of the Preliminary Timing Report. An example of office testing documentation is shown in Exhibit 687-11.

687.3.03.02 Field Implementation

Upon receipt of written approval of the Preliminary Timing Report by the Engineer, implement the new signal and system timing data for the entire system. Upon approval, Contractor/Consultant shall notify the Engineer at least three (3) working days in advance of the implementation of the system timing plans. Do not schedule implementation on peak traffic days or peak travel times without prior approval from the Engineer. At this stage, if one isn't found in the cabinet, a data key shall be supplied by GDOT or the local jurisdiction and kept inside the cabinet drawer with current timing data. Data keys should be labeled with the applicable controller firmware version and date.

Enter only approved data into the equipment at each location. If an Intersection is ready for turn-on before the initial timing plans are developed, the existing timings (if suitable) or other approved temporary timings may be installed until the initial timing plans are developed. Do not activate any new phases under temporary timings without the approval of the Engineer. Enter the new timing data at each controller, through a master controller, or from a central workstation. If entering the timing data from a central workstation, have a person experienced with controller operation on-site in the field during the implementation process. Obtain approval of the method of data entry from the Engineer prior to the entry of any data. Develop and implement all settings required for the system database. Conduct initial field verifications at time of implementation. Review the operation of equipment in the field to verify that the correct cycle lengths, splits, offsets and phasing sequence are being implemented and that no major operation problems occur. Field testing documentation should be submitted to the Engineer after implementation. An example of field testing documentation is shown in Exhibit 687-12.

Review the timing plans and adjust this data as required by actual field conditions or as directed by the Engineer. Update the data key with the current timing as changes are made.

687.3.03.03 Field Fine Tuning

Fine-tuning consists of an on-street review of the timing plans by the Contractor/Consultant. All timing plans should be verified based on traffic conditions at the time the plan is running in the TOD schedule. Cycle lengths, splits and offset should be field verified based on traffic conditions by the Consultant/Contractor. All adjustments to the timing plans should be uploaded to the final database and the local Intersection data key.

Fine-tuning approval consists of an on-street review (system evaluation) of the timing plans by the Contractor/Consultant, the Department and the Local Agency, if applicable. A written request (via email) is to be sent to the Engineer, the Department and the Local Jurisdiction for the system evaluation at least five (5) working days in advance of the proposed date for the review. It is not the intent of the approval for the Department and the Local Agency to accomplish fine-tuning for the Contractor/Consultant. System evaluations are reserved for the Department and/or Local Agency to review and approve, reject or request changes to the final timings, as installed by the Contractor/Consultant. As directed by the Department, the system evaluation could involve rejection of the timing plans, at which point the Contractor/Consultant must repeat the fine-tuning process and then request a follow-up approval with the Department. If so directed, implement the necessary adjustments and repeat the detailed on-street review. The Department reserves the right to require that adjustments be made due to conditions observed in the field.

Make any adjustments to the timings requested by the Department/Local until the Final Timing Report is submitted for review. Anticipate implementing all plans into the system and fine tuning all plans during the TOD/day-of-week (and season of year, if applicable) that the plans are scheduled to be in effect. Present to the Department for approval any contract scheduling conflicts that may interfere with the proper scheduling of the timing plan implementation along with proposed resolutions.

Perform "After" travel runs upon approval of new timing plans.

687.3.04 Final Timing Report

687.3.04.01 Project Performance Measures – Before/After Analysis

After all necessary field adjustments have been made to the timing and approval of the operation is provided by the Engineer, provide a qualitative assessment of the signal system timing by comparing the “Before” travel time runs with the “After” travel time runs. A Cost/Benefit analysis shall be included as part of the signal timing assessment. *If travel runs are removed from scope at the Kickoff Meeting, the Final Timing Report will consist of the final timing database printouts.*

Develop project performance measures containing, but not limited to the following data:

- Emissions (NO_x, CO, VOC)
- Total travel time (Before and After)
- Stops/Delays (including side streets)
- Fuel consumption
- Benefit/Cost Ratio
- Additional Measures of Effectiveness as directed by the Engineer

Submit a copy of the final local and system timing plans to the Engineer. Use the back-up routine provided in the Department’s signal system software to make a back-up of the system database. Supply this back-up electronic version to the Engineer (Include updated and final signal timing software models and any/all electronic database). Leave the data key in the cabinet drawer. Data keys should be labeled with the applicable controller firmware version and date.

687.3.04.02 As-Built Timing Database

Provide a final timing database that includes all changes made from field fine tuning.

687.3.04.03 As-Built Software Model

Provide a final software model that includes all changes made from field fine tuning.

687.3.04.04 Data Keys/Loadable Media

Provide data keys or other loadable media as approved by the Engineer for each intersection in the project.

Submit one (1) electronic (.PDF) copy of the Final Timing Report to the Engineer for review and approval. Obtain written approval of the Final Timing Report prior to submitting all approved project files to the Engineer.

687.3.05 Training

687.3.05.01 Overview

Training may be requested by the Engineer, Department or Local Jurisdiction.

Provide instructors and all material for training Department and Local Agency personnel in the development and implementation of timing plans specifically related to this project. Submit training course outline to the Engineer for approval at least thirty (30) days prior to the proposed scheduled start of the training session. Obtain written approval of the course content prior to the final scheduling of the training session. Scheduling of training shall be coordinated with the Department and Local agency.

Develop and supply all necessary manuals, displays, class notes, visual aids, and/or other instructional materials as required to provide the training programs described herein. Bind the manuals individually in loose-leaf binders and provide up to ten (10) copies depending on the requested size of the class. Check with the Engineer to determine the final number of required manuals.

Unless otherwise specified, conduct the training session at the District office. Provide up to sixteen (16) hours of training over multiple days. Training could consist of both classroom and field sessions. The dates and times of the training will be approved by the Engineer. The Engineer will determine the personnel who will attend each training session.

687.3.05.02 Recommended Content

Provide a course to instruct the procuring and maintaining agency in the procedures used in the development and implementation of timing plans for this project.

Items to *possibly* be covered:

- Data required for input into the signal timing program and what the signal timing program does with the data
- Program limitations
- Timing plan methodology for the respective project
- Explanation of timing plan development process related to the signal timing program
- Terminology employed, data required, reports and graphics available for evaluation, definition of MOE's, interpretation of results
- Explanation of timing plan development process related to the respective project
- Reasoning for the evaluation and selection of cycle length, splits and offsets and why this is an iterative process
- Conversion of the timing plan output from the signal timing program to the input utilized by the system and controller database
- Installation of the timing plans for manual mode use and TOD use
- Fine-tuning a signal system
- Fine-tuning intersections with light vehicular traffic but high pedestrian demand
- Development of parameters to be used in the database to implement traffic responsive operation based on the data collected from the field
- Data collection to support traffic responsive operation
- Fine-tuning traffic responsive operation
- Reporting project performance measures
- Conducting a Benefit to Cost (B/C) analysis

687.4 Measurement

687.4.01 Construction Contracts

GDOT will provide one (1) data key or other media per controller, as noted in section 687.3.04 Final Timing Report, if one is not currently in the cabinet. The data key shall remain with maintaining local agencies. Consultant shall update data key with current timing plan(s).

Traffic signal timing, complete and accepted is measured for payment per Lump Sum.

- Traffic Signal Timing
- Training

687.5 Payment

687.5.01 Construction Contracts

Traffic signal timing complete and accepted is measured for payment per Lump Sum. Price and payment is full compensation for all materials, labor, tools, equipment, supplies, testing, and incidentals to complete the item of work

Payment will be made under:

Item No. 687	Traffic Signal Timing	Lump Sum
--------------	-----------------------	----------

The GDOT Construction Project Manager, at his/her discretion may choose to pay a partial payment based upon percent complete.

Table 687-3 Signal Timing Flowchart (Workflow)

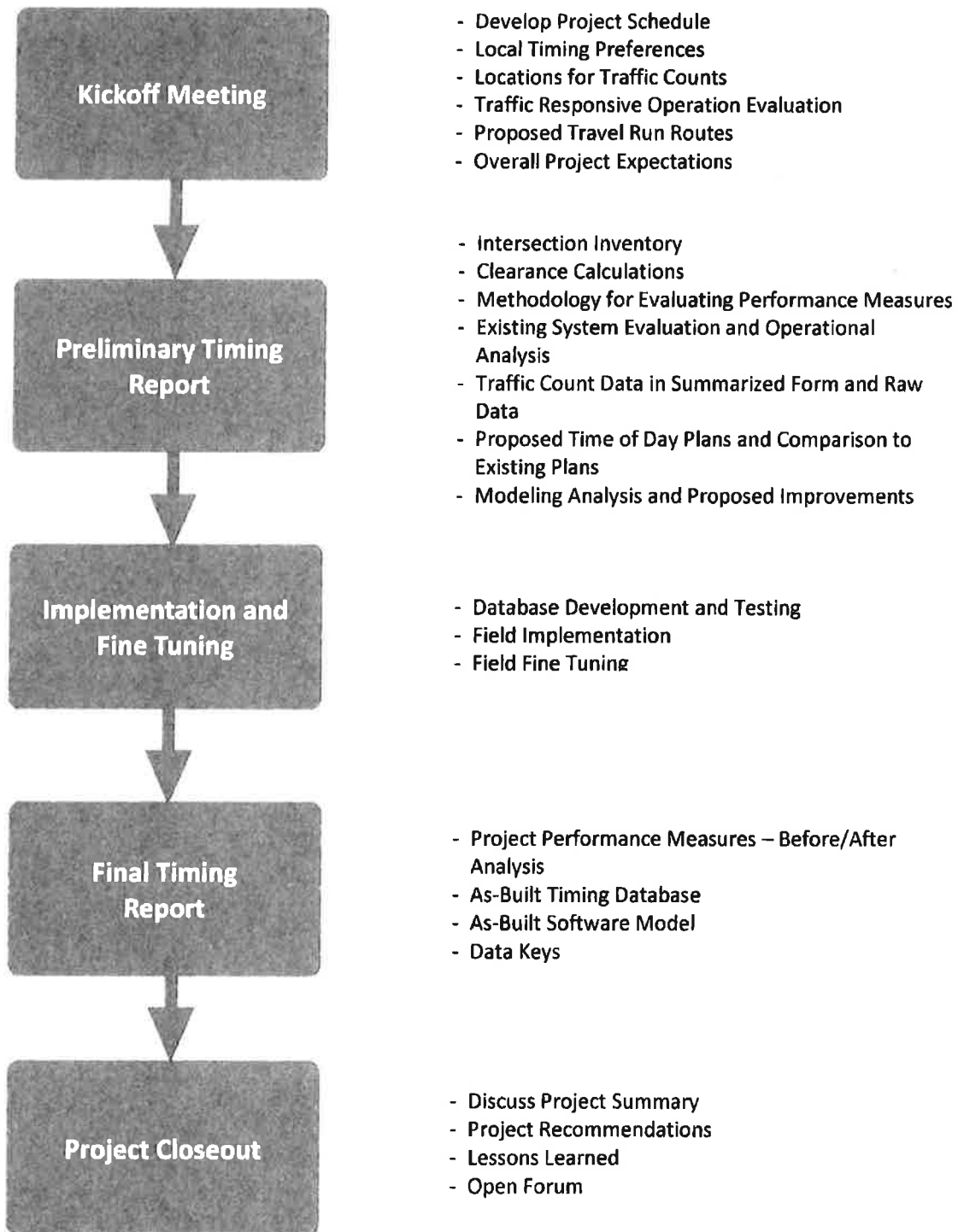

TABLE 687-4 List of Intersections and Count TOD

INTERSECTIONS

Sigman Road at Rockbridge Road
Sigman Road at Irwin Bridge Road

COUNTS

Collect TMC's at the locations listed above, during the days and hours listed below. Any changes to the days and times listed below shall be approved by the Engineer before proceeding.

Monday, Tuesday or Wednesday – TMC's at above listed intersections. Designated times: 7:00-9:00 am, 11:00-1:00 pm, and 4:00-6:00 pm.

Monday, Tuesday or Wednesday – 24-hour bi-directional traffic counts on all roadways of the intersections listed above.

Exhibit 687-1

XX System - XX County

Intersection: _____
 Recorded by: _____

Field Review Date: _____
 Intersection #: _____

Phasing:

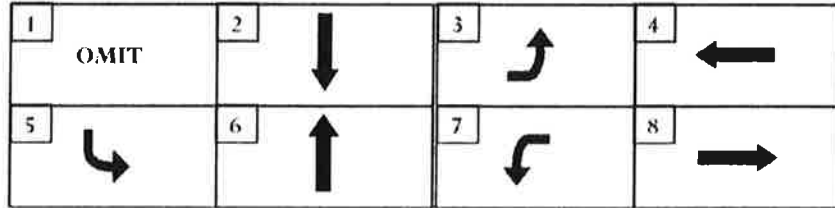

Left Turn Treatment

	Prot	Perm	Bay Length	Bay Length
Northbound		Perm	122'	
Southbound	Prot	Perm	141'	
Eastbound	Prot	Perm	337'	
Westbound	Prot	Perm	420'	393'

Right Turn

Misc. Comments

2070 Controller; 332 Cabinet
NB & SB loop can't be seen in the field - possibly paved over (calls being picked up in cabinet by detector cards)
Peds on Phase 2 and Phase 8
All signal and ped heads are good
Wireless Antenna on strain pole closest to the cabinet
In Free Operation based on TOD (15:56)
30 seconds slower than www.time.gov

Geometrics

	Clearance	Speed
Northbound	58'	40
Southbound	38'	40
Eastbound	62'	35
Westbound	63'	35

Ped Data

	Crosswalk	Heads	PB	* X walk Dx
Northbound				
Southbound		Yes	Yes	6' 60' 5'
Eastbound		Yes	Yes	14' 50' 4'
Westbound				

Detectors

Approach	Size	Type	Dx from SB	Lane
WB	4' x 60'	Quad Pres		Left
WB	4' x 60'	Quad Pres		Thru
NB	6' x 6'	Setback	318'	Thru
EB	4' x 60'	Quad Pres		Thru
EB	4' x 60'	Quad Pres		Left
SB	6' x 6'	Quad Pres		Left
SB	6' x 6'	Setback	287'	Thru

* Note: X walk Dx is a running cumulative distance that includes: button to curb, curb to curb, and curb to button

INTERSECTION DIAGRAM SHEET 1

PHASING DIAGRAM

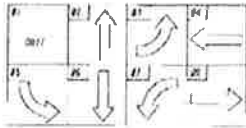

SIGNAL HEADS



2, 4, 6, 8



3/8, 5/2, 7/1

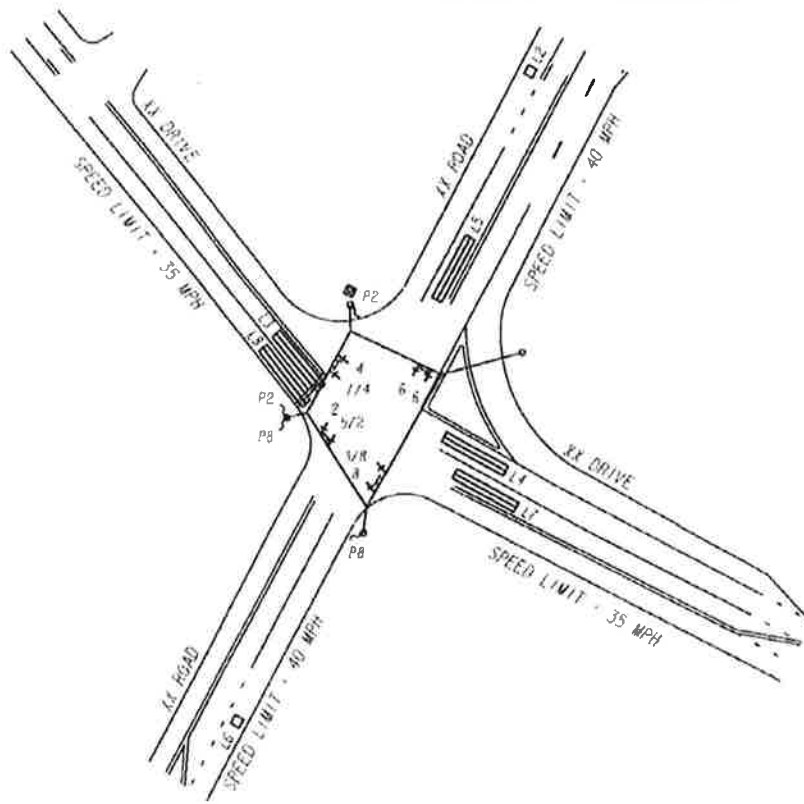

DISTRICT X
XX ROAD
@
XX DRIVE
XX COUNTY

NOT TO SCALE

INTERSECTION DIAGRAM SHEET 2



LEFT TURN CLEARANCE DISTANCE	THRU CLEARANCE DISTANCE	TURN BAY DISTANCE
NBL - 80'	ND - 58'	NBL - 122'
SBL - 95'	SB - 88'	SBL - 141'
EDL - 50'	EB - 62'	EBL - 331'
WBL - 80'	WB - 63'	WBL - 420'
		WBR - 393'

SETBACK LOOP DISTANCE
NB - 318'
SB - 287'

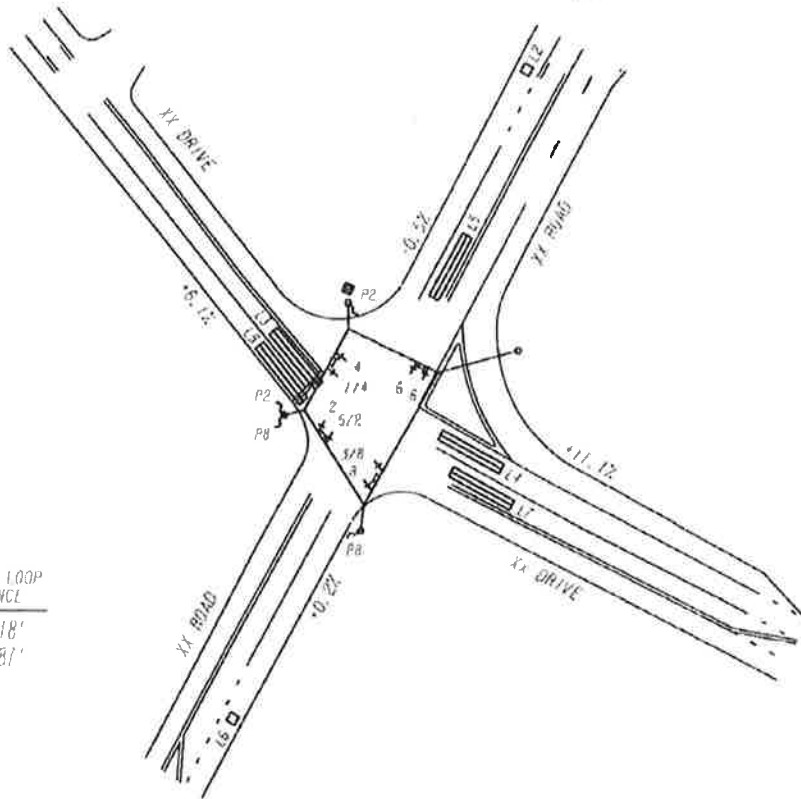

DISTRICT X
XX ROAD
@
XX DRIVE
XX COUNTY

NOT TO SCALE

Exhibit 687-2 cont'd

General Information	Signal Number	Load Switches	Type	
	Owner		Quantity	
	Maintained By		Install Date	
	Primary Route		Trouble Log	Type
	Secondary Route			Location
	Primary Rte Alt Name			Install Date
	Secondary Rte Alt Name		Signal Plan	Type
	City			Location
	County			Plan Date
	District		Communication	Type
	Signal System			Serial Number(s)
	Master or Local			IP Address
	Latitude			Port Number
	Longitude			Phone Number
	Cabinet			Serial Number
Manufacturer		Manufacturer(s)		
Install Date		Install Date		
Type		Loop Detection	Quantity	
Controller	Type		Type	
	Actuation		Number of Channels	
	Software/Firmware Build		Phase	
	Serial Number		Serial Number	
	Manufacturer	Manufacturer		
Install Date	Install Date			
Conflict Monitor	Type	Other Detection	Quantity	
	Serial Number		Type	
	Manufacturer		Activation Mechanism	
	Install Date		Direction/Phase	
Battery Backup	Type		Serial Number	
	Serial Number	Manufacturer		
	Manufacturer	Install Date		
	Install Date	Pedestrian Detection	Quantity	
Pedestrian Signals	Quantity		Type	
	Type		Indication	
	Bulb Type		Direction/Phase	
	Indication Type		Install Location	
	Size		Serial Number	
	Mounted On		Install Date	
	Direction/Phase	Pedestrian Signs	Quantity	
Serial Number	Type			
Manufacturer	MUTCD Designation			
Install Date	Direction/Phase			
Signals	Type		Install Location	
	Quantity		Serial Number	
	Bulb Type		Install Date	
	Usage		Support Poles	Quantity
	Direction/Phase	Type		
	Casing Color	Height		
	Backplate	Owner		
	Enforcement	Serial Number		
	Material	Manufacturer		
	Mounted On	Install Date		
	Section Size	Flashers	Quantity	
	Manufacturer		Type	
	Visor		Bulb Type	
	Serial Number		Direction/Phase	
	Install Date		Activation Mechanism	
Signs	Quantity		Install Date	
	MUTCD Designation		Power Source	
	Direction/Phase	Usage		
	Serial Number	Serial Number		
	Install Location	Manufacturer		
	Install Date			

Exhibit 687-3

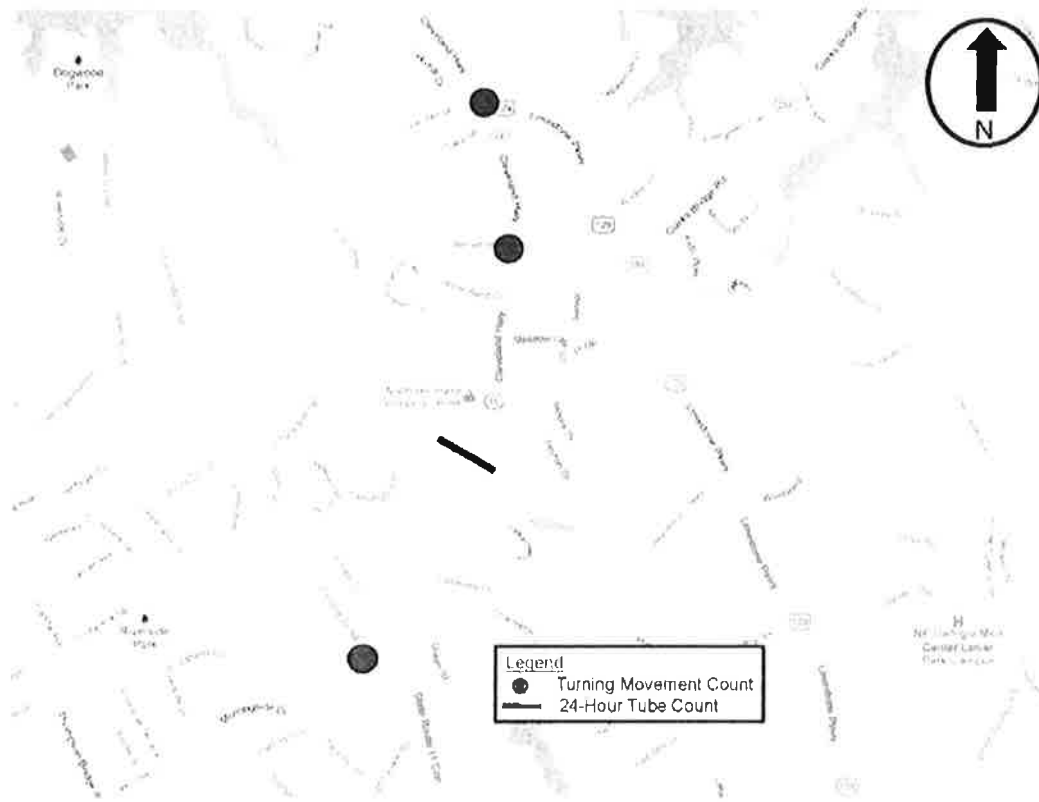

Methodology for Clearance Intervals

Local controller timings will be developed for each of the three (3) intersections in this project. Table 3 details the clearance interval values that will be used for each signal phase.

**Table 3
Clearance Interval Values**

Phase Interval	Interval Value
Walk Interval	4 seconds typical and 7 seconds for intersections near schools or with high pedestrian traffic
Flashing Don't Walk	Distance from the curb to curb divided by 3.5 feet/second (typically) or 3.0 feet/second for schools and elderly Concurrent phases do not need to be equal
Yellow Interval	$t + (V/(2A + 64.4g))$ Concurrently terminating phases should be equal (set to higher)
All Red Interval	$(W + L) / V$ Concurrently terminating phases should be equal (set to higher) Max red interval = 3.0 seconds
	t = perception reaction time (1 second) V = posted speed in feet/second A = deceleration rate (10 feet/second/second) W = intersection width measured from stop bar to edge of through travel lane L = length of vehicle (assume 20 feet) g = The average of three field-measured approach grades, at the stop bar, midway to the setback loop, and at the setback loop, will be used to determine approach grades This value will then be divided by 100.

In addition, left-turn clearance calculations will be based on a turning speed of 25 mph. Through movements will be based on the posted speed limit.

SIGNAL TIMING GUIDELINES

The City of XX Traffic Engineering will use the following guidelines for traffic signal timing. These guidelines are not a substitute for good engineering judgement.

1. Compute minimum green intervals by applying Greenshields formula ($t = 4+2n$) to a minimal queue associated with off-peak conditions. Round off to nearest second as necessary. Typical assignments are as follows:

4 sec - Turn Arrows and Low speed (*30 MPH) minor street approaches controlled by 40 foot presence loops; T intersections.

6 sec - Medium speed (*40 MPH) minor street approaches.

8 sec - High speed (>40 MPH) minor street approaches.

12 sec - Medium speed (*40 MPH) main line approaches.

15 sec - High speed (>40 MPH) main line approaches.

Set the maximum variable initial greater than the maximum time needed to clear the queue of vehicles that has accumulated between the stop line and the loop.

2. Passage time is computed as follows:

$$\text{Distance from stop line}/(\text{Speed Limit}*1.47)$$

3. Determine the maximum green time using the procedures described in chapter nine of the Highway Capacity Manual.
4. Compute the yellow change interval according to the Institute of Transportation Engineers recommended procedure.

$$Y = t + \frac{v}{2a \pm 64.4g}$$

- Where: Y = length of yellow interval to nearest 0.1 second
t = driver perception/reaction time, recommended as 1.0 second.
v = approach speed, in fps (MPH*1.47), taken as the 85th percentile speed or speed limit.
a = deceleration rate stopping, recommended as 10 ft/sec².
g = grade of approach, in percent divided by 100 (downhill is negative)

Note: The City of XX Traffic Engineering will use the 85th percentile speed to enter the table. If a speed study is not available, the speed limit is used. Use 25 MPH for all turning movements.

Exhibit 687-5 cont'd

5. The red clearance interval will follow the Institute of Transportation Engineers recommended procedure

$$R = \frac{W + L}{V}$$

- Where: R = length of red clearance, to the nearest 0.1 second
W = width of intersection, in feet, measured from the nearside stop line to the far edge of the conflicting traffic lane along the actual vehicle path.
L = length of vehicle, recommended as 20 feet
V = speed of the vehicle through the intersection, in ft/sec

Note: The City of XX Traffic Engineering will use the 85th percentile speed to enter the table. If a speed study is not available, the speed limit is used. Use 25 MPH for all turning movements.

6. Calculate the "Pedestrian Clearance" for each leg at which pedestrian crossings are permitted. This is the crossing width divided by the walking speed (4.0 ft/sec, or 3 - 3.5 ft/sec in areas where school children or handicapped pedestrians may be present). This value is used for the flashing "DON'T WALK" interval. The "WALK" interval is 4 to 7 seconds as determined by minimum pedestrian volumes. These values are used for actuated pedestrian phases with or without pedestrian signals.

Crossing leg refers to the leg of the intersection the data applies

Crossing width is the distance for the pedestrian to cross from the point at which he would wait for a crossing opportunity to the middle of the furthest travel lane.

Fixed time controllers or phases on recall, adjust the vehicle minimum green interval to "Pedestrian Minimum Green" (Pedestrian clearance plus Walk). This value is useful since it represents the minimum green split (less vehicle clearance) that must be allowed for in coordination

Note: If the roadway is 28 feet wide or less, then the crossing width is from the edge of pavement to the edge of pavement. Pedestrian Clearance shall not be less than 8 seconds.

Exhibit 687-6

Volume

File Name: C:\Users\Owner\Desktop\New folder\#A US29 WEST OF PATTERSON ROAD If2

Start Date: 11/7/2012

Start Time: 12:00:00 AM

Site Code: A

Station ID: A

Location 1: US29 WEST OF PATTERSON ROAD

Location 2:

Date	Time	EB		WB	
11/7/2012	12:00 AM	20		22	
11/7/2012	12:15 AM	12		22	
11/7/2012	12:30 AM	15		20	
11/7/2012	12:45 AM	14	61	19	83
11/7/2012	01:00 AM	14		8	
11/7/2012	01:15 AM	6		13	
11/7/2012	01:30 AM	10		10	
11/7/2012	01:45 AM	11	41	8	39
11/7/2012	02:00 AM	3		11	
11/7/2012	02:15 AM	10		8	
11/7/2012	02:30 AM	6		11	
11/7/2012	02:45 AM	6	25	8	38
11/7/2012	03:00 AM	5		6	
11/7/2012	03:15 AM	8		10	
11/7/2012	03:30 AM	7		6	
11/7/2012	03:45 AM	6	26	9	31
11/7/2012	04:00 AM	17		10	
11/7/2012	04:15 AM	5		20	
11/7/2012	04:30 AM	21		16	
11/7/2012	04:45 AM	29	72	19	65
11/7/2012	05:00 AM	30		34	
11/7/2012	05:15 AM	52		39	
11/7/2012	05:30 AM	68		78	
11/7/2012	05:45 AM	62	210	80	231
11/7/2012	06:00 AM	68		107	
11/7/2012	06:15 AM	98		182	
11/7/2012	06:30 AM	142		230	
11/7/2012	06:45 AM	130	436	252	751
11/7/2012	07:00 AM	158		266	
11/7/2012	07:15 AM	177		292	
11/7/2012	07:30 AM	252		297	
11/7/2012	07:45 AM	274	861	282	1137
11/7/2012	08:00 AM	252		318	
11/7/2012	08:15 AM	264		292	
11/7/2012	08:30 AM	258		277	
11/7/2012	08:45 AM	246	1018	214	1099
11/7/2012	09:00 AM	198		212	
11/7/2012	09:15 AM	213		219	
11/7/2012	09:30 AM	184		189	
11/7/2012	09:45 AM	176	771	205	825
11/7/2012	10:00 AM	178		166	
11/7/2012	10:15 AM	158		170	
11/7/2012	10:30 AM	166		182	
11/7/2012	10:45 AM	160	658	179	697
11/7/2012	11:00 AM	154		156	
11/7/2012	11:15 AM	174		165	

Exhibit 687-7

US 29 East of Belnesoe Church Road Weekday ADT

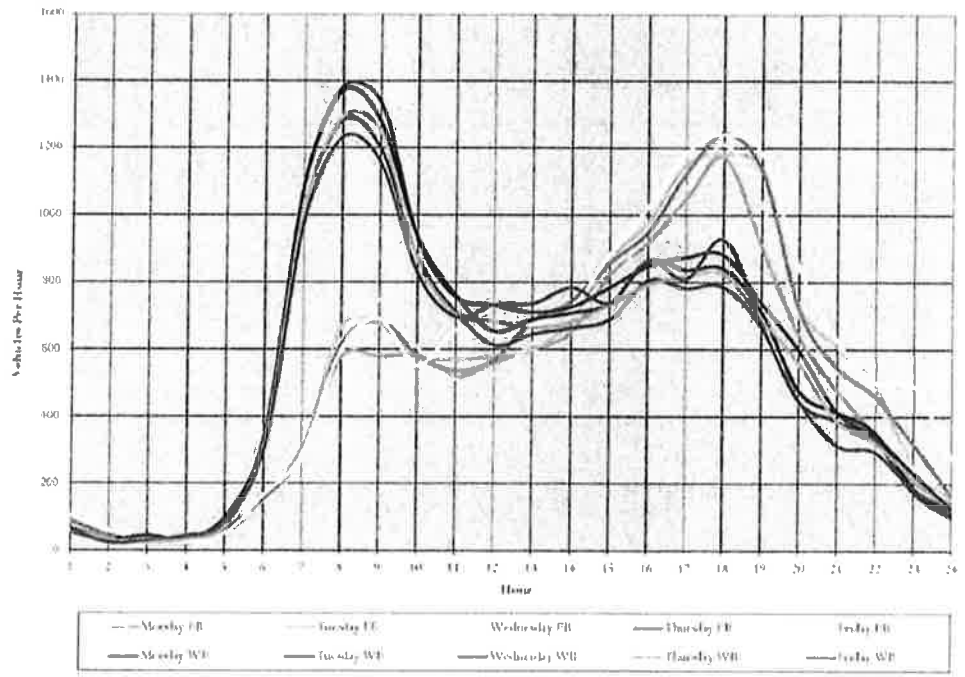

All Traffic Data Services, Inc

1336 Farmer Road
 Conyers, Ga 30012
 404-374-1283

File Name : #1 Patterson Rd @ US 29 Lawrenceville Hwy AM
 Site Code :
 Start Date : 11/7/2012
 Page No : 2

Start Time	PATTERSON RD Southbound					US 29 LAWRENCEVILLE HWY Westbound					PATTERSON RD Northbound					US 29 LAWRENCEVILLE HWY Eastbound					
	Left	Thru	Right	Peds	App	Left	Thru	Right	Peds	App	Left	Thru	Right	Peds	App	Left	Thru	Right	Peds	App	
Peak Hour Analysis From 07:30 AM to 09:15 AM - Peak 1 of 1																					
Peak Hour for Entire Intersection Begins at 07:30 AM																					
07:30 AM	0	0	0	0	0	15	244	0	0	259	55	0	74	0	129	0	226	17	0	243	631
07:45 AM	0	0	0	0	0	18	258	0	0	276	42	0	81	0	123	0	258	16	0	274	673
08:00 AM	0	0	0	0	0	19	270	0	0	289	47	0	76	0	123	0	250	25	0	275	687
08:15 AM	0	0	0	0	0	17	261	0	0	278	27	0	69	0	96	0	244	11	0	255	629
Total Volume	0	0	0	0	0	69	1033	0	0	1102	171	0	300	0	471	0	978	69	0	1047	2620
% App	0	0	0	0	0	63	93.7	0	0	38.3	0	63.7	0	63.4	0	0	0	0	0	0	
Total PHF	0.000	0.000	0.000	0.000	0.000	0.009	0.956	0.000	0.000	0.953	0.000	0.928	0.000	0.913	0.000	0.948	0.000	0.000	0.952	0.953	
Cars	0	0	0	0	0	84	980	0	0	1044	167	0	264	0	461	0	948	66	0	1015	2520
% Cars	0	0	0	0	0	92.8	94.9	0	0	94.7	0	98.0	0	97.9	0	97.0	95.7	0	96.9	98.2	
Trucks	0	0	0	0	0	5	53	0	0	58	4	0	8	0	10	0	29	3	0	32	100
% Trucks	0	0	0	0	0	7.2	5.1	0	0	5.3	2.3	0	2.0	0	2.1	0	3.0	4.3	0	3.1	3.8

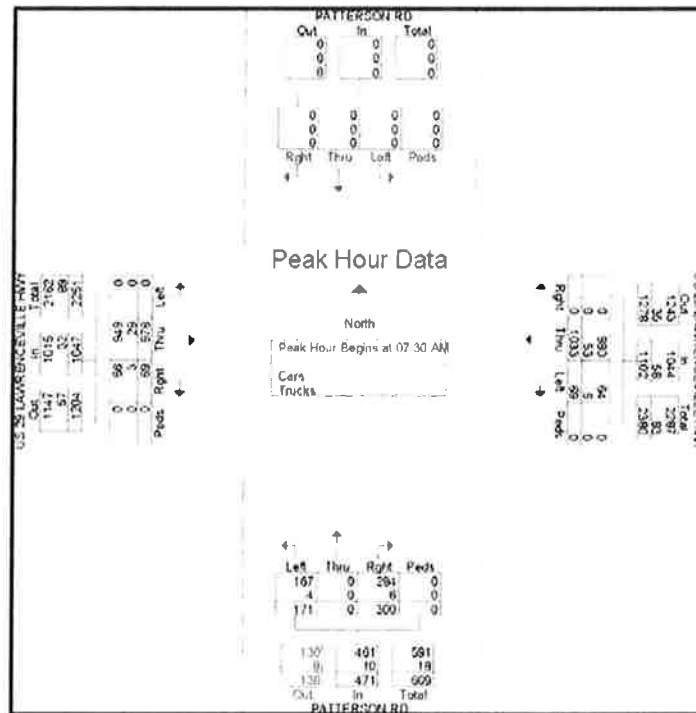

Exhibit 687-9

Shallowford Road		Briarcliff Road	
AM Peak Plan		AM Peak Plan	
Cycle Length		Cycle Length	
Before	After	Before	After
120"	120"	120'	120"
MD Peak Plan		MD Peak Plan	
Cycle Length		Cycle Length	
Before	After	Before	After
120"	110"	Free	Free
PM Peak Plan		PM Peak Plan	
Cycle Length		Cycle Length	
Before	After	Before	After
120"	130"	120"	130"

Exhibit 687-10

SR 11 Business
1: SR 11/Limestone Pkwy & SR 11 Business

4/26/2013

	↙	↖	↑	↗	↘	↓
Lane Group	WBL	WBR	NBT	NBR	SBL	SBT
Lane Configurations	↙	↖	↑	↗	↘	↓
Volumes (vph)	5	183	176	19	626	670
Ideal Flow (vphpl)	1900	1900	1900	1900	1900	1900
Grade (%)	3%		-2%			5%
Storage Length (ft)	0	0		195	310	
Storage Lanes	1	1		1	1	
Taper Length (ft)	25	25		25	60	
Lane Util. Factor	1.00	1.00	1.00	1.00	1.00	1.00
Fit		0.850		0.850		
Fit Protected	0.950				0.950	
Satd. Flow (prot)	1743	1560	1881	1599	1725	1816
Fit Permitted	0.950				0.630	
Satd. Flow (perm)	1743	1560	1881	1599	1053	1816
Right Turn on Red		Yes		Yes		
Satd. Flow (RTOR)		199		36		
Link Speed (mph)	45		40			45
Link Distance (ft)	2012		1703			1068
Travel Time (s)	30.5		29.0			16.2
Peak Hour Factor	0.42	0.92	0.80	0.53	0.86	0.82
Adj. Flow (vph)	12	199	219	36	728	817
Shared Lane Traffic (%)						
Lane Group Flow (vph)	12	199	219	36	728	817
Turn Type		Perm		Perm	pm+pt	
Protected Phases	4		2		1	6
Permitted Phases		4		2	6	
Detector Phase	4	4	2	2	1	6
Switch Phase						
Minimum Initial (s)	4.0	4.0	12.0	12.0	4.0	12.0
Minimum Split (s)	11.0	11.0	19.0	19.0	11.0	19.0
Total Split (s)	15.0	15.0	80.0	80.0	45.0	126.0
Total Split (%)	10.7%	10.7%	57.1%	57.1%	32.1%	89.3%
Yellow Time (s)	4.0	4.0	4.2	4.2	4.0	4.2
All-Red Time (s)	2.5	2.5	2.3	2.3	2.5	2.3
Lost Time Adjust (s)	0.0	0.0	0.0	0.0	0.0	0.0
Total Lost Time (s)	6.5	6.5	6.5	6.5	6.5	6.5
Lead/Lag			Lag	Lag	Lead	
Lead-Lag Optimize?						
Recall Mode	None	None	C-Max	C-Max	None	C-Max
Act Effect Green (s)	7.0	7.0	92.2	92.2	120.0	120.0
Actuated g/C Ratio	0.05	0.05	0.66	0.66	0.86	0.86
w/c Ratio	0.14	0.75	0.18	0.03	0.72	0.52
Control Delay	66.4	25.7	9.5	3.5	7.2	4.0
Queue Delay	0.0	0.0	0.0	0.0	0.0	0.0
Total Delay	66.4	25.7	9.5	3.5	7.2	4.0
LOS	E	C	A	A	A	A
Approach Delay	28.0		8.7			6.5
Approach LOS	C		A			A
Queue Length 50th (ft)	11	0	63	0	118	139
Queue Length 95th (ft)	15	86	114	1	168	178

AM Peak

140 second cycle

Exhibit 687-10 cont'd

SR 11 Business

4/26/2013

1: SR 11/Limestone Pkwy & SR 11 Business

	↙	↖	↑	↗	↘	↓
Lane Group	WBL	WBR	NBT	NBR	SBL	SBT
Internal Link Dist (ft)	1932		1623			988
Turn Bay Length (ft)				196	310	
Base Capacity (vph)	106	282	1238	1065	1088	1557
Starvation Cap Reductn	0	0	0	0	0	0
Spillback Cap Reductn	0	0	0	0	0	0
Storage Cap Reductn	0	0	0	0	0	0
Reduced wt Ratio	0.11	0.71	0.18	0.03	0.67	0.52

Intersection Summary

Area Type: Other

Cycle Length: 140

Actuated Cycle Length: 140

Offset: 125 (89%), Referenced to phase 2:NBT and 6:SBTL, Start of 1st Green

Natural Cycle: 60

Control Type: Actuated-Coordinated

Maximum v/c Ratio: 0.75

Intersection Signal Delay: 3.3

Intersection LOS: A

Intersection Capacity Utilization 64.3%

ICU Level of Service C

Analysis Period (min) 16

95th percentile volume exceeds capacity, queue may be longer.

Queue shown is maximum after two cycles

Splits and Phases: 1: SR 11/Limestone Pkwy & SR 11 Business

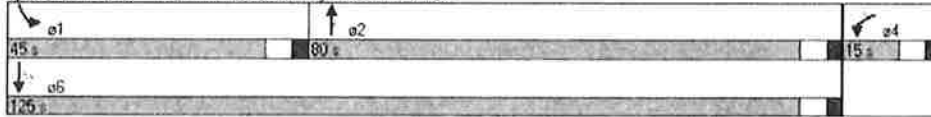
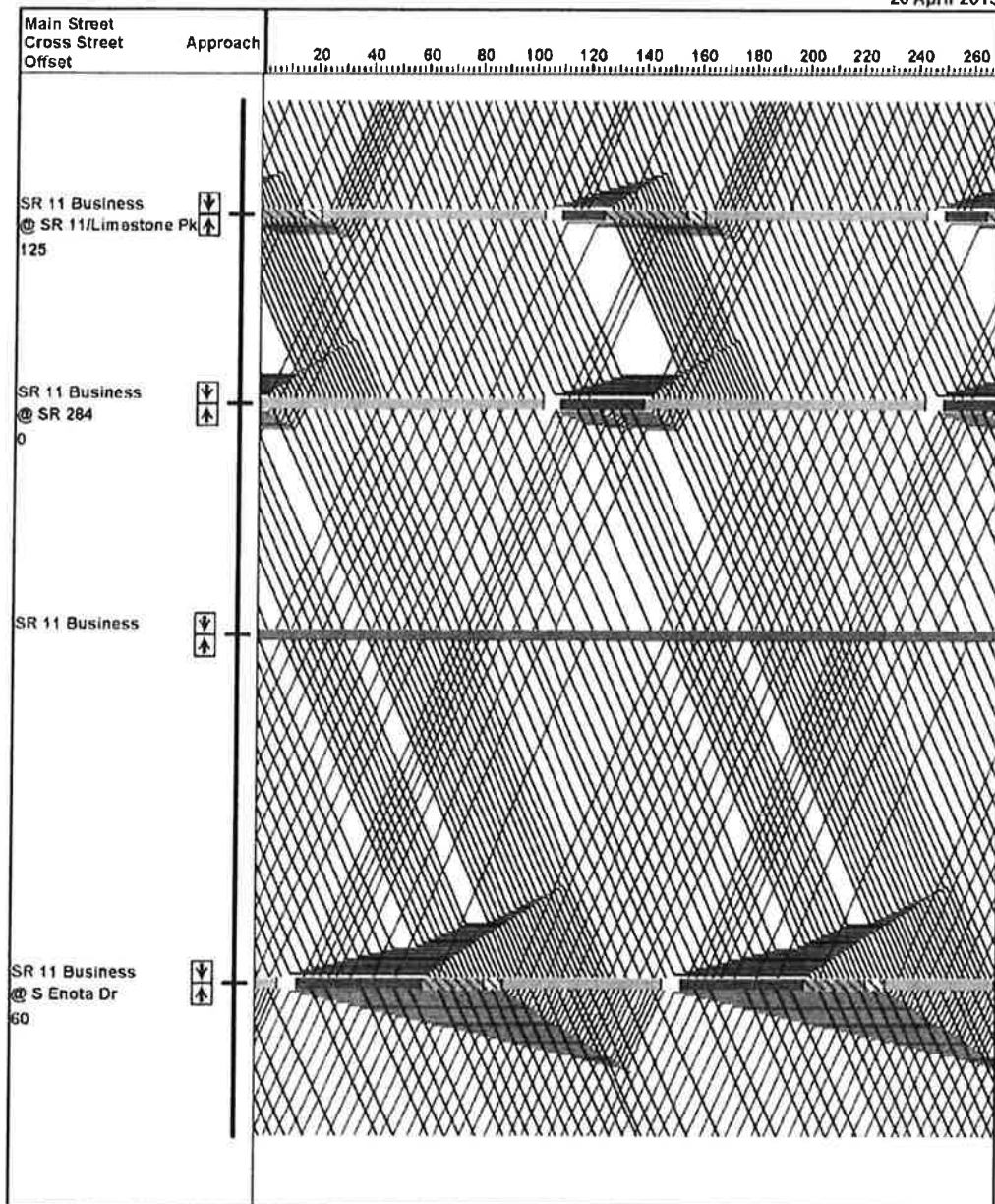

Exhibit 687-10 cont'd

SR 11 Business

Metro TO 191
26 April 2013



AM Peak
4/1/1

140 Second Cycle



Part I – Office Tests

Local Intersection Timing Plan Checklist

Project Name: XX Road Signal Timing
 Project Number: Task Order XX
 Client: City of XXX
 Project Manager: _____

Intersection: _____
 Checked by: _____ Date: _____
 Reviewed by: _____ Date: _____
 Approved by: _____ Date: _____

1. Intersection Phases

___ Verified vehicle and pedestrian phases in use correspond to phases shown on the intersection diagram.

	1	2	3	4	5	6	7	8
Vehicular Phases								
Initialization Status								
Pedestrian Phases								

2. Phasing Sequence

Describe any non standard phasing sequence (non standard phasing orders, exclusive phases). List once only if phasing sequence does not change by time of day; otherwise list for each plan along with the description of the sequence and purpose of the non-standard sequence. Examples are lead/lag, phase-omit by time of day, split phasing and exclusive pedestrian phases.

Non Standard Sequence	Description	Plan	Purpose



Part II – Field Tests

Local Intersection Timing Plan Checklist

Project Number: Task Order XX Intersection: _____
 Project Name: XX Road Signal Timing Checked by: _____ Date: _____
 Client: City of XX Reviewed by: _____ Date: _____
 Project Manager: _____ Approved by: _____ Date: _____

1. Intersection Phases (Check box for phases in use)

___ Verified phases in use correspond to phases shown on intersection diagram and signal heads

	1	2	3	4	5	6	7	8
Vehicular Phases								
Pedestrian Phases								

2. Basic Intersection Operations

- ___1. Verified all vehicular movements are detected by controller
- ___2. Verified all vehicular phases are served and signal heads turned on in the correct sequence.
- ___3. Verified all pedestrian pushes are detected by controller.
- ___4. Verified the pedestrian signal heads are turned on (walk, flashing don't walk, and still don't walk) in the correct sequence.
- ___5. Set controller time clock to the correct date and time.
- ___6. For each test criteria, indicated whether the plan passes or fails the test criteria below in the corresponding boxes.

February 19, 2018

**DEPARTMENT OF TRANSPORTATION
STATE OF GEORGIA
SPECIAL PROVISION**

PROJECT NUMBER: STP00-9335-00(001)

COUNTY: ROCKDALE

P.I. No.: 0013163

SECTION 108 - PROSECUTION AND PROGRESS

Retain Sub-Section 108.08 as written and add the following:

D: Restrictive Work Hours

1. Failure to re-open travel lanes as specified in Special Provision Section 150.6.A will result in the assessment of liquidated damages in the amount of \$1,000, per hour or portion thereof.

The above rates are cumulative and are in addition to any Liquidated Damages which may be assessed for failure to complete the overall project.

February 19, 2018

**DEPARTMENT OF TRANSPORTATION
STATE OF GEORGIA
SPECIAL PROVISION**

**PROJECT NUMBER: STP00-9335-00(001)
ROCKDALE COUNTY
P.I. No.: 0013163**

SECTION 150 – TRAFFIC CONTROL

Add the following:

150.6 Special Conditions:

- A. The contractor shall not install lane closures; perform flagging, or move equipment or materials on the travel way that interferes with traffic flow between the hours of 6:00 A.M. to 9:00 A.M. and 3:00 P.M. to 6:00 PM Monday through Friday.

DEPARTMENT OF TRANSPORTATION
STATE OF GEORGIA

SUPPLEMENTAL SPECIFICATION

0013163 & 0012886 Rockdale County

Section 168—Post-Construction Stormwater BMP Items

168.1 General Description

This work includes constructing the following as shown in the Plans or as directed by the Engineer:

- Dry detention basins
- Enhanced dry swales

168.1.01 Related References

A. Standard Specifications

- Section 109—Measurement and Payment
- Section 161—Control of Soil Erosion and Sedimentation
- Section 208—Embankments
- Section 500—Concrete Structures
- Section 511—Reinforcement Steel
- Section 573—Underdrains
- Section 574—Edge Drains
- Section 603—Riprap
- Section 700—Grassing
- Section 702—Vine, Shrub, and Tree Planting
- Section 708—Plant Topsoil
- Section 711—Turf Reinforcement Matting
- Section 800—Coarse Aggregate
- Section 801—Fine Aggregate
- Section 805—Riprap and Curbing Stone
- Section 806—Aggregate for Drainage
- Section 814—Soil Base Materials
- Section 830—Portland Cement
- Section 839—Corrugated Polyethylene Underdrain Pipe
- Section 846—Polyvinyl Chloride (PVC) Profile Wall Drain Pipe
- Section 853—Reinforcement and Tensioning Steel
- Section 881—Fabrics
- Section 890—Seed and Sod
- Section 893—Miscellaneous Planting Materials
- Section 894—Fencing

Section 910—Sign Fabrication

Section 911—Sign Posts

Section 914—Sign Paint

B. Referenced Documents

AASHTO M-252

AASHTO M-294

AASHTO M-304

AASHTO T 215

ASTM D-422

ASTM D-698

ASTM D-1784

ASTM D-1785

ASTM D-2434

ASTM D-2466

ASTM D-2564

ASTM D-2665

ASTM D-3786

ASTM D-4491

ASTM D-4533

ASTM D-4632

ASTM D-4751

ASTM D-4833

ASTM F-758

ASTM F-949

168.1.02 Submittals

General Provisions 101 through 150.

168.2 Materials

Provide materials shown on the Plans, such as pipe, spillways, wood baffles, plants, and other accessories including an anti-seep collar, when necessary.

Materials may be new or used; however, previously used materials shall be approved by the Engineer before use.

Materials shall meet the requirements of the following Specifications:

Material	GDOT Section/Requirement
Nonwoven Filter Fabric	ASTM D-3786: Mullen burst strength = 280 psi ASTM D-4491: permittivity = 1.30 sec ⁻¹ ASTM D-4533: Trapezoidal tear strength = 60 lb ASTM D-4632: Grab tensile strength = 160 lb ASTM D-4632: Grab tensile elongation = 50% ASTM D-4751: AOS = 70 US standard sieve

Material	GDOT Section/Requirement
Nonwoven Filter Fabric	ASTM D-4833: Puncture Resistance = 85 lb
Class A, AA, and B Concrete	500/ASTM C-76-10
Reinforcement Steel	511
Riprap	603, 805
Permanent Grass, Sod, and Other Vegetation	700
Turf Reinforcement Matting	711
Coarse Aggregate	800
Fine Aggregate	801
Soil Base Materials	814
Riprap and Curbing Stone	805
Portland Cement	830
Corrugated Polyethylene Underdrain Pipe	839/AASHTO M252 or M294
PVC Underdrains	846/ASTM F-758, ASTM F-949
Reinforcement and Tensioning Steel	853
Geosynthetic Fabric	881/ASTM D-3786, ASTM D-4491, ASTM D-4533, ASTM D-4632, ASTM D-4751, ASTM D-4833
Seed	890
Miscellaneous Planting Materials	814, 893
Mulch	893.2.09-A.4
Signage	910, 911, 914
Landscape Plantings	702

Engineered Soil Mix

Requirements

1. Use an engineered soil mix that meets the requirements herein. Do not use a mixture that contains deleterious substances. Obtain the materials from sources approved by the Engineer. Ensure that aggregate retained on No. 10 (2 mm) sieve is of hard, durable particles.
2. Remove particles with a diameter greater than 2 in (50 mm) before placing the engineered soil mix. Remove particles with screens or by hand if few oversized pieces exist. Otherwise, crush the oversized pieces to less than 2 in and use them in the proportions shown by the gradation table below.
3. Use 5-10% by dry weight composted organic matter as topsoil components. All components shall be free of heavy metals, pathogens, pesticides, and herbicides.
4. Use 90-95% by dry weight inorganic topsoil components with the following properties:

Sieve Size	Percent Passing by Weight
Passing 2 in (50 mm)	100
Passing No. 4 (4.75mm)	98-100
Passing No. 8 (2.36 mm) sieve	95-100
Passing No. 10 (2.0 mm)	86-100
Passing No. 16 (1.18 mm) sieve	70-100
Passing No. 30 (600 µm) sieve	40-75
Passing No. 50 (300 µm) sieve	10-35
Passing No. 100 (150 µm) sieve	2-15

Passing No. 200 (75 µm) sieve	0-10
Clay size (< 2 µm)	0-6

5. Ensure that material passing the No. 10 (2 mm) sieve meets the following requirements:

Property	Value
Liquid Limit (LL)	≤25
Plasticity Index (PI)	≤10
Volume Change, Maximum Percent	12
Maximum Dry Density, lb/ft ³ *	105
Permeability (in/hr)	1 – 6
*by standard Proctor	

Fabrication

General Provisions 101 through 150.

Acceptance

The Contractor is required to submit a minimum of three (3) cubic-foot-sized random soil samples per 150 tons of material per each source to the Department's Geotechnical Bureau of the Materials Office 20 working days before placement for testing to ensure acceptability for use as directed by the Project Engineer. The Department's Geotechnical Bureau of the Materials Office reserves the right to disapprove the engineered soil mix for use if test results show that parameters do not meet the acceptable values specified above. Acceptance must be granted prior to placement.

The Department will test engineered soil mix as follows:

Test	Method
Soil Gradation	GDT 4
Volume Change	GDT 6
Maximum Density	GDT 7 or GDT 67
Liquid Limit	AASHTO T 89
Plastic Limit and Plasticity Index	AASHTO T 90
Permeability	AASHTO T 215

168.2.01 Materials Warranty

General Provisions 101 through 150.

168.2.02 Delivery, Storage, and Handling

General Provisions 101 through 150.

168.3 Construction Requirements

168.3.01 Personnel

General Provisions 101 through 150.

168.3.02 Equipment

General Provisions 101 through 150.

168.3.03 Preparation

General Provisions 101 through 150.

168.3.04 Fabrication

General Provisions 101 through 150.

168.3.05 Construction

A. Dry Detention Basins

Construct dry detention basins per the Plans at the required locations, or as modified by the Engineer. Construct the basins complete as shown, including but not limited to: grading, drainage, accessories to complete the dry detention basins and temporary mulching and permanent grassing on external slopes. The contractor may propose alternate construction staging for review and approval. Alternate construction submittals for review shall be provided a minimum of 30 days prior to the construction of a dry detention basin. Contractor shall maintain the dry detention basin after construction as outlined in the GDOT Stormwater System Inspection and Maintenance Manual until the project is turned over.

1. Excavation

Excavation should be limited to the width and length of the dry detention basin per the details shown in the plans or as directed by the Engineer. Embankments shall be constructed using the materials and methods specified in Section 208 and shall be compacted to at least 95 percent of the maximum laboratory dry density. Stabilize the disturbed areas adjacent to dry detention basins per the plans immediately after each dry detention basin is installed.

2. Pretreatment

Install riprap forebays per the details and at the locations specified in the plans. Riprap used in forebays shall meet the requirements outlined in Georgia Department of Transportation Specification Section 603 and woven filter fabric shall meet the requirements outlined in Georgia Department of Transportation Specification Section 881.2.05. Riprap forebays shall be located at major inflow locations or at any inlet contributing more than 10 percent of the total flow to the dry detention basin. Maintenance access shall be provided to the forebay.

3. Signage

Install signage per the details and locations specified in the plans.

D. Enhanced Dry Swales

Construct enhanced dry swales as shown in the Plans, or as modified by the Engineer, after final grade and stabilization of the area upstream of each enhanced dry swale is reached. If this is not feasible, stormwater flow shall be diverted around the swale and the swale protected with temporary erosion and sediment control measures. Contractor shall maintain the enhanced dry swale after construction as outlined in the GDOT Stormwater System Inspection and Maintenance Manual until the project is turned over.

1. Excavation

Excavation should be limited to the width and length of the enhanced dry swale per the details shown in the plans or as directed by the Engineer. Avoid placing excavated material near the open trench so as not to jeopardize the stability of the trench sidewalls. The bottom of the excavated trench shall not be loaded in a way that causes soil compaction, and should be scarified prior to placement of specified materials. The sides of the trench shall be trimmed of all large roots. Sidewalls should be uniform with no voids and scarified prior to placement of materials for specified engineered drainage layers. Trench sidewalls shall be lined with the specified filter fabric. Infiltration testing should be performed prior to excavation of the dry enhanced swale if the enhanced dry swale is designed for infiltration. If infiltration is feasible, a second infiltration test is required prior to the placement of the underdrain system/aggregate layer to ensure that infiltration rates weren't impacted during excavation.

2. Underdrain System/Aggregate Layer

Install underdrain system(s) made of 8-inch diameter perforated polyethylene or perforated PVC pipe at the locations and depth per details shown in the plans for conveyance of stormwater that has filtered through the media. Perforations shall be 3/8-inch diameter and spaced 6-inches on center with four rows running longitudinally while the pipe is placed at a minimum slope of 0.5%. A removable end cap connected to the underdrain system shall be installed per the details shown in the plans. If infiltration is feasible, the end cap shall be closed except for emergency drainage or maintenance purposes. The underdrain pipe shall be surrounded by an aggregate layer as defined in the details and a 2-3-inch filter blanket of size no. 8 or no. 89 aggregate (Georgia Department of Transportation Specification Section 800) shall be used to segregate the aggregate layer from the engineered soil mix. Aggregates used in underdrain systems shall be double washed and free of fines and organic materials. Cleanouts shall be provided at the end of each underdrain branch and placed at a maximum spacing of 100 linear feet. Cleanouts shall extend to an elevation such that they are accessible once the trench is backfilled with the specified media and shall have a locking screw top lid, to discourage vandalism and tampering.

3. Engineered Soil Mix

Install the engineered soil mix specified above for the 30-inch thick engineered soil mix and nonwoven filter fabric per the details shown in the plans. The engineered soil mix shall be placed in a maximum of 12-inch lifts and shall be protected from contamination by foreign matter during installation. If the engineered soil mix becomes contaminated or the filter fabric is damaged, remove contaminated or damaged materials and replace them at no additional cost to the Department. Avoid using heavy equipment on the basin area during installation to maintain hydraulic conductivity of the engineered soil mix and to prevent damage to the underdrains.

4. Sod Layer

The sod layer must be grown in primarily sand/sandy-loam soils with less than 6% clay content. Sod shall be half cut or thin cut to promote infiltration. Sod shall consist of at least 75% of the designated grass species specified in the plans.

5. Pretreatment

Install riprap forebays per the details and at the locations specified in the plans. Riprap used in forebays shall meet the requirements outlined in Georgia Department of Transportation Specification Section 603 and woven filter fabric shall meet the requirements outlined in Georgia Department of Transportation Specification Section 881.2.05. Riprap forebays shall be located at major inflow locations and energy dissipation shall be provided at all concentrated inflow locations. Maintenance access shall be provided to the forebay.

6. Signage

Install signage per the details and locations specified in the plans.

168.3.06 Quality Acceptance

General Provisions 101 through 150.

168.3.07 Contractor Warranty and Maintenance

General Provisions 101 through 150.

168.4 Measurement

A. Dry Detention Basins

Dry detention basins are measured for payment by the entire structure constructed at each location complete in place and accepted. The outlet control structure, any outlet pipe, any pretreatment (e.g. forebay), any signage, and any outlet apron and/or other energy dissipation devices are included in the lump sum cost of the dry detention basin. Permanent grassing is not measured and paid for separately.

B. Enhanced Dry Swales

Enhanced dry swales are measured for payment by the entire structure constructed at each location complete in place and accepted. The outlet control structure, underdrain system, engineered soil mix, any pretreatment (e.g. forebay), any signage, any outlet pipe, and any outlet apron and/or other energy dissipation devices are included in the lump sum cost of the enhanced dry swale.

168.4.01 Limits

General Provisions 101 through 150.

168.5 Payment

A. Dry Detention Basins

Dry detention basins are paid for at the Contract Unit Price per lump sum. The outlet control structure, any outlet pipe, any pretreatment (e.g. forebay), any signage, and any outlet apron and/or other energy dissipation devices are paid for as a lump sum for the overall cost of the dry detention basin. Payment is full compensation for:

- Furnishing the material and labor
- Preparation and grading required to construct dry detention basins
- Any other incidentals such as but not limited to pipe fittings and connections to other specified structures required to construct dry detention basins

B. Enhanced Dry Swales

Enhanced dry swales are paid for at the Contract Unit Price per lump sum. The outlet control structure, any outlet pipe, any pretreatment (e.g. forebay), any signage, and any outlet apron and/or other energy dissipation devices are paid for as a lump sum for the overall cost of the enhanced dry swale. Payment is full compensation for:

- Furnishing the material and labor
- Preparation and grading required to construct enhanced dry swales
- Installation of the drainage aggregate, nonwoven filter fabric, and complete underdrain system as shown in the details for construction of enhanced dry swales
- Installation of the permeable engineered soil mix, and sod if required, as shown in the details for construction of enhanced dry swales
- Any other incidentals such as but not limited to pipe fittings and connections to other specified structures required to construct enhanced dry swales

Payment is made under:

Item No. 168	Construct dry detention basin	Per lump sum
Item No. 168	Construct enhanced dry swale	Per lump sum

168.5.01 Adjustments

General Provisions 101 through 150.

168.6 As-Built Documents

168.6.01 Description

Arrange for the inspection of post-construction stormwater BMPs during construction activities as specified and submit post-construction stormwater BMP as-built documents to the Department within 45 calendar days prior to substantial completion of the Contract.

168.6.02 Construction

Submit to the Department within 45 calendar days of completing construction of all post-construction stormwater BMPs in the Contract post-construction stormwater BMP as-built documents that contain the specified information for each post-construction stormwater BMP constructed. Submit two hard copies and one digital copy in PDF format on a CD. All post-construction stormwater BMPs shall meet the construction tolerances outlined in Georgia Department of Transportation specification 168.6.03 and will require approval from construction engineering and inspection personnel.

The post-construction stormwater BMP as-built documents include the following content, neatly presented and organized in an easy-to-follow format, for each post-construction stormwater BMP in the Contract.

- a) Red line revision data must be overlaid on the appropriate Contract Plan sheet(s). Red line revision data must be red in color, clearly legible, and easily distinguishable. Printed copies must be submitted on 11 in. X 17 in. sheets.
- b) Applicable supporting computations demonstrating that the functionality of the post-construction stormwater BMP meets the approved design requirements as noted in the approved Post-Construction Stormwater Management (PCS) Report for the Contract. Include any necessary revisions to the final PCS Report.

Upon, written request, the Department will provide CADD files in DGN format for the approved plans and a copy of the PCS Report in PDF format to facilitate completion of the post-construction stormwater BMP as-built documents.

168.6.03 Construction Tolerances

Construction tolerances for post-construction stormwater BMPs shall be as follows.

- a) **Depths.** Depths within 5% of the depths specified in the Contract Documents not to exceed 2 in.
- b) **Water Quality and Channel Protection Volumes.**
 - Measurement of Water Quality volume and Channel Protection volume shall be within 5% of the volumes specified in the Contract Documents.

– Outlet structure orifices and weirs shall be within 3/16 inch of the Contract Documents.

c) Dimensions.

- Length of bioslopes, enhanced dry/wet swales, grass channels, infiltration trenches, and filter strips shall be within 5% of the length specified in the Contract Documents not to exceed 10 feet.
- Width of infiltration trenches and filter strips shall be within 5% of the width specified in the Contract Documents.
- Surface area for bioretention basins and sand filters shall be within 5% of the surface area specified in the Contract Documents.
- In lieu of measuring length and width and depth of a post construction structure the average end area method for calculating volume can be used to calculate of post construction structures that have an irregular shape. The accepted tolerance of the difference between the volume measured and the volume derived from the contract documents shall be 10%.

168.6.04 Payment

Post-construction stormwater BMP as-built documents will be paid for at the contract unit price per lump sum. The payment will be full compensation for services of the professional engineer, and for all material, labor, equipment, tools, and incidentals necessary to complete the work.

Subsequent inspections and reconstructed post-construction stormwater BMPs because of failure to address deviations from the Contract Documents that exceed specified tolerances and do not meet the design functions as presented in the approved final PCS Report shall be at no additional cost to the Department.

Subsequent revisions to and submissions of the post-construction stormwater BMP as-built documents following the initial submission shall be at no additional cost to the Department.

ROCKDALE COUNTY, GEORGIA

2017 SPLOST CONSTRUCTION PROGRAM

ITB # 20-06

**Sigman Road Widening and Multi-Use Trail from East of CR 79/Lester
Road to CS 442/Irwin Bridge Road**

P.I. Nos. 0013163 and 0012886

GENERAL CONDITIONS

For

Rockdale County Department of Transportation (RDOT)

CONTRACT # C-2020-_____

GENERAL CONDITIONS

Unless otherwise directed, all work performed under this contract shall be in accordance with the Georgia Department of Transportation Standard Specifications, Construction of Transportation Systems, 2013 Edition, and any Supplemental Specifications modifying them, except as noted below and in the Special Provisions.

Modification of Standard Specifications

SECTION 101 - DEFINITION AND TERMS

Section 101.10 BOARD

Delete as written and substitute the following:

"BOARD OF COMMISSIONERS OF ROCKDALE COUNTY, GEORGIA";

Section 101.13 CHIEF ENGINEER

Delete as written and substitute the following:

"THE ROCKDALE COUNTY DIRECTOR OF TRANSPORTATION"

Section 101.14 COMMISSIONER

Delete as written and substitute the following:

"THE CHAIRMAN OF THE BOARD OF COMMISSIONERS OF ROCKDALE COUNTY"

Section 101.16 CONTRACT

Delete the second paragraph and substitute the following:

"The Contract Documents shall be composed of the Advertisement for Bid; Notice to **Contractors**; Form of Bid Proposal; General Conditions; Special Provisions; Detail Specifications, as identified in Section 105.04; Form of Contract; Form of Bond(s); Addenda; the drawings, including all changes incorporated herein before their execution; and also any Change Orders and Supplemental Agreements that are required to complete the construction of The Work in an acceptable manner, including authorized extensions thereof, all of which constitute one instrument. No oral agreement or orders are to be considered as valid or as a part of the Contract."

Section 101.22 DEPARTMENT

Delete as written and substitute the following:

"THE ROCKDALE COUNTY DEPARTMENT OF TRANSPORTATION"

Section 101.24 ENGINEER

Delete as written and substitute the following:

"THE ROCKDALE COUNTY DIRECTOR OF TRANSPORTATION, ACTING DIRECTLY OR THROUGH HIS DULY AUTHORIZED REPRESENTATIVES."

Section 101.62 STATE HIGHWAY ENGINEER

Delete as written and substitute the following:

"THE ROCKDALE COUNTY DIRECTOR OF TRANSPORTATION, ACTING DIRECTLY OR THROUGH HIS DULY AUTHORIZED REPRESENTATIVES."

Section 101.74 SUPPLEMENTAL AGREEMENT

Retain as written and add the following:

"Any Supplemental Agreement that has a dollar value amount that is less than \$25,000.00 shall not require the assent of the Surety."

Section 101.81 TREASURER

Delete as written and substitute the following:

"THE ROCKDALE COUNTY DIRECTOR OF FINANCE"

Add Section 101.84:

Section 101.84 "COUNTY: THE ROCKDALE COUNTY BOARD OF COMMISSIONERS"

SECTION 102 - BIDDING REQUIREMENTS AND CONDITIONS

Section 102.01 PREQUALIFICATION OF BIDDERS

Delete in its entirety and substitute the following:

"Proposals will be considered only from experienced and well-equipped Contractors engaged in work of this type and magnitude. Contractors must be presently prequalified to do this type of work with the Georgia Department of Transportation and have received a Certificate of Qualification in accordance with the Rules and Regulations approved and adopted by the State Transportation Board.

Bidders may be required to submit evidence setting forth qualifications which entitle him to considerations as a responsible Contractor. A list of work of similar character successfully completed within the last two years may be required giving the location, size and listing equipment available for use on this work. Before accepting any bid, the **County** may require evidence of the Contractor's financial ability to successfully perform the work to be accomplished under the contract.

The **County** may make such investigations as it deems necessary to determine the ability of the **Bidder** to perform the work, and the **Bidder** shall furnish to the **County** all such information and data for this purpose as the **County** may request. The **County** reserves the right to reject any bid if the evidence submitted by, or investigation of, such **Bidder** fails to satisfy the **County** that such **Bidder** is properly qualified to carry out the obligations of the Contract and to complete the work contemplated therein. Conditional bids will not be accepted."

Section 102.03 CONTENTS OF PROPOSAL FORMS

Delete in its entirety and add the following:

"Upon request, the **County** will furnish the prospective **Bidder** with a Proposal Form. This form will state the location and description of the contemplated construction and will show the approximate estimate of the various quantities and kinds of work to be performed or materials to be furnished, and will have a Schedule of Items for which Unit Bid prices are invited. The Proposal Form will state the time in which The Work must be completed, the amount of the Proposal Guaranty, and the date of the opening of Proposals. The form

will also include any Special Provisions or requirements which vary from or are not contained in the Standard Specifications. All papers which are required to be submitted as part of the Proposal are identified in the Proposal Form, and those papers must not be altered except as directed by Addendum. The Plans, Specifications, and other documents designated in the Proposal Form will be considered a part of the Proposal whether attached or not. The prospective **Bidder** will be required to pay the sum stated in the Notice to Contractors for each copy of the Proposal Form and each set of Plans."

Section 102.05 EXAMINATION OF PLANS, SPECIFICATIONS, SPECIAL PROVISIONS, AND SITE OF THE WORK

Add the following:

"Each **Bidder** must inform himself fully of the conditions relating to the construction of the project and the employment of labor thereon. Failure to do so will not relieve a successful **Bidder** of his obligation to furnish all material and labor necessary to carry out the provisions of his Contract. Insofar as possible the **CONTRACTOR**, in carrying out his work, must employ such methods or means as will not cause any interruption of or interference with the work of any other contractor. Bidders, before making proposals, shall examine the plans and specifications and make such examinations on the ground as are necessary to thoroughly familiarize themselves with the nature and extent of the proposed construction and all local conditions affecting the same, as the **County** will not be responsible for **Bidder's** errors or misjudgment, nor for any information on local conditions or general laws or regulations.

No interpretation of the meaning of the plans and specifications or other pre-bid documents will be made to any bidder orally. Every request for such interpretations should be in writing and addressed to:

Rockdale County Finance Department Purchasing Division
Attn: Meagan Porch, Buyer
958 Milstead Avenue
Conyers, GA 30012
Phone: (770) 278-7557, Fax (770) 278-8910
E-mail: meagan.porch@rockdalecountyga.gov

and to be given consideration must be received at least six (6) calendar days prior to the date fixed for the opening of bids. Any and all such interpretations and any supplemental instructions will be in the form of written addenda to the Specifications which, if issued, will be mailed by registered mail, with return receipt requested, to all prospective **Bidders**, at the respective addresses furnished for such purposes, not later than three days prior to the date fixed for the opening of bids. Failure of any bidder to receive any such addendum or interpretation shall not relieve such **Bidder** from any obligation under his bid as submitted. All addenda so issued shall become part of the Contract Documents.

At the time of the opening of bids, each **Bidder** will be presumed to have inspected the site and to have read and to be thoroughly familiar with the plans and Contract Documents (including all addenda). The failure or omission of any **Bidder** to examine any form, instruments or documents shall in no way relieve any bidder from any obligation in respect to his bid."

Section 102.06 PREPARATION OF PROPOSAL

Retain as written except delete the sixth and seventh paragraphs, and add the following:

"If a proposal is made by an individual, his name and post office address must be shown. If made by a firm or partnership, the name and post office address of each member of the firm or partnership must be shown. If made by a corporation, the person or persons signing the proposal must show the name of the state under which the laws of the corporation are chartered and his or their authority for signing same; the names, titles, and address of their President, Secretary, and Treasurer, and the corporate authority for doing business in Georgia."

Section 102.07 REJECTION OF PROPOSALS

Add the following subparagraphs:

I. The **County** reserves the right to reject any and all bids, to waive formalities and to re-advertise. It is understood that all bids are made subject to this Contract Agreement, that the **County** reserves the right to award the bid to the lowest, responsible Bidder, and in arriving at this decision, full consideration will be given to the reputation of the Bidder, his financial responsibility, and work of this type successfully completed.

J. The **County** also reserves the right to reject any and all bids from any person, firm, or corporation who is in arrears in any debt or obligation to Rockdale County, Georgia."

Section 102.08 PROPOSAL GUARANTY

Delete and substitute the following:

"No proposal will be considered unless it is accompanied by a certified check or acceptable Bid Bond in an amount not less than five percent (5%) of the amount bid and made payable to the Board of Commissioners of Rockdale County. Such Bid Bond shall be on the forms provided by the **County**.

Each bid must be accompanied by a Bid Bond prepared on the form of Bid Bond attached hereto, duly executed by the **Bidder** as **Contractor**, and having as surety thereon a surety company approved by the **County** and accepted by the U. S. Department of the Treasury and listed in Department Circular 570. The surety must be licensed to conduct business in the State of Georgia. The Bid Bond must be in the amount of 5% of the bid. No Proposal Guaranty will be considered to cover any Bid except the one to which it is attached.

Attorneys-in-fact who sign Bid Bonds must file a certified and effectively dated copy of their power of attorney."

Section 102.09 DELIVERY OF PROPOSALS

Delete in its entirety and substitute the following:

"All bids must be on forms in conformity with the proposal form included herein and must be for labor and materials called for in the Specifications, shown on the plans and bulletins issued prior to bidding. Bids must be submitted in a sealed envelope of sufficient size with the following clearly typed or printed on the outside:

Rockdale County Department of Finance
Proposal for Construction
Project Name
Date and Hour of Bid Opening
Company Name

If forwarded by mail, the sealed envelope containing the bid must be enclosed in another envelope addressed as specified in the bid form.

The entire proposal package as designated in the Proposal Form must be submitted with the bid. Failure to do so could result in the omission of pertinent documents and the rejection of the apparent low bid."

Four (4) hard copies and one (1) USB flash drive with a copy of the Bid in Adobe PDF format will be required for review purposes.

Section 102.10 WITHDRAWAL OR REVISION OF PROPOSALS

Add the following:

"Any **Bidder** may modify his bid by telegram, letter or facsimile transmission at any time prior to the scheduled closing time for receipt of bids, provided such communication is received by the **County** prior to the closing time and provided, further, the **County** is satisfied that a written confirmation of the transmitted modification over the signature of the bidder was mailed prior to the closing time. If written confirmation is not received within two days from the closing time, no consideration will be given to the transmitted modification."

SECTION 103 - AWARD AND EXECUTION OF CONTRACT

Section 103.01 CONSIDERATION OF PROPOSALS

Delete the third sentence in its entirety and substitute the following:

"In determining Unit Bid Prices, fractional parts of a cent less than one cent (\$0.01) will not be considered significant and will be dropped."

Section 103.02 AWARD OF CONTRACT

Delete in its entirety and substitute the following:

If a Contract is awarded, it will be awarded to the lowest responsible **Bidder**. The **County** will determine that **Bidder**, and, in so doing, the following elements will be considered: whether the **Bidder** involved (a) maintains permanent place of business; (b) has adequate plant equipment to do the work properly and expeditiously; (c) has a suitable financial status to meet obligations incident to the work; and (d) has appropriate technical experience (e) past performance on county contracts (i.e.: scheduling, coordination, cooperation, etc.) (f) past, pending, or threatened litigation, arbitration, or mediation with the County. The Contract will be awarded on the base bid only. Rockdale County reserves the right to exercise its discretion as to the responsibility of any **Bidder**.

When notified by and of the Department's recommendation for award of this Contract, the **Contractor** shall immediately secure Performance and Payment Bonds as per the Contract, properly execute two (2) original Contract Documents and submit them to the **County**, with proof of insurance in accordance with the Special Provision in the Proposal, within five (5) calendar days of notification.

The Board shall have the right to hold bids after bid opening for a period of ninety (90) days."

Section 103.04 RETURN OF PROPOSAL GUARANTY

Delete in its entirety and add the following:

"All Proposal Guaranties (Bid Bonds) will be returned to all except the three lowest **Bidders** within three days after the opening of the bids, and the remaining Bid Bonds will be returned promptly after the **County** and the accepted **Bidder** have executed the Contract, or, if no award has been made within ninety (90) days after the date of the opening of bids, upon demand of the **Bidder** at any time thereafter, so long as he has not been notified of the acceptance of this bid.

The **County** reserves the right to return all Proposal Guaranties by registered or certified mail and its responsibility pertaining to them will end when they are mailed."

Section 103.05 REQUIREMENTS OF PERFORMANCE AND PAYMENT BONDS

Delete in its entirety and substitute the following:

"Simultaneously with his delivery of the executed Contract, the **Contractor** shall furnish a surety bond or bonds, in a sum equal to the full amount of the Contract, as security for faithful performance of the Contract and for the payment of all persons performing labor on the project under this Contract, and furnishing material in connection with this Contract. The surety on such bond or bonds shall be a duly authorized surety company satisfactory to the **County** and be countersigned by the State of Georgia's representative/agent. The surety

issuing the bonds must be accepted by the U.S. Department of the Treasury and listed in Department Circular 570 and approved by the **County**.

Attorneys-in-fact who sign performance and payment bonds must file a certified and effectively dated copy of their power of attorney."

Section 103.06 EXECUTION AND APPROVAL OF CONTRACT

Add the following:

"Execution of the Contract by **Contractor** shall not be considered complete unless **Contractor** submits proper proof of coverage of Insurance in compliance with the following requirements:

- A. **Contractor's Liability Insurance:** **Contractor** shall purchase and maintain such comprehensive general liability and other insurance as will provide protection from claims set forth below which may arise out of or result from **Contractor's** performance or non-performance of the work and **Contractor's** other obligations under the Contract Documents, whether such performance is by the **Contractor's** own organization, its subcontractors or suppliers, or any individual directly or indirectly employed by any of them, or by anyone for whose acts any of them may be liable.

The Contractor, at all times that this Contract is in force, agrees to provide, as a minimum, insurance coverages in accordance with the attached insurance requirements. The **County**, its subcontractors, and affiliated companies, their officers, directors, employees and agents shall be named on the Certificates of Insurance as additional insured and endorsed onto the policies for Comprehensive General Liability, Automobile Liability, Contractor's Pollution Liability and Umbrella Liability Insurance maintained pursuant to this Contract in connection with liability of the **County** and their officers, directors, employees and agents arising out of Contractor's operations. Copies of the endorsements shall be furnished to the **County** prior to execution of the contract. Such insurance is primary insurance and shall contain a severability of interest clause as respects each insured.

- 1) Claims under workers' or workmen's compensation, disability benefits and other similar employees benefit acts;
- 2) Claims for damages because of bodily injury, occupational sickness or disease, or death of **Contractor's** employees;
- 3) Claims for damages because of bodily injury, sickness or disease, or death of any person other than **Contractor's** employees;
- 4) Claims for damages insured by personnel injury liability coverage which are sustained a) by any person as a result of an offense directly or indirectly related to the employment of such person by **Contractor**, or b) by any other person for any other reason;
- 5) Claims for damages, other than to work itself because of injury to or destruction of tangible property, including loss of use resulting therefrom; and,
- 6) Claims for damages because of bodily injury or death of any person or property damage arising out of the ownership, maintenance, or use of any motor vehicle.

The insurance required by this paragraph shall include the specific coverages and be written for not less than the limits of liability and coverages provided in these specifications, or required by law, whichever is greater. The comprehensive general liability insurance shall include completed operations insurance. All such insurance shall contain a provision that the coverage afforded will not be canceled, materially changed, or renewal refused until at least thirty (30) days prior written notice has been given to **County**. All such insurance shall remain in effect until final payment and at all times thereafter when **Contractor** may be correcting, removing, or replacing defective work. In addition, **Contractor** shall maintain such completed

operations insurance for at least one year after final payment and furnish **County** with evidence of continuation of such insurance at final payment.

- B. **County** shall not be responsible for purchasing and maintaining any property insurance to protect the interests of **Contractor** or subcontractors in the work to the extent of any deductible amounts that are provided in the supplemental conditions. If **Contractor** wishes property insurance coverage within the limits of such amounts **Contractor** may purchase and maintain it at his own expense.
- C. If **County** has any objection to the coverage afforded by or other provisions of the insurance required to be purchased and maintained by **Contractor** in accordance with subparagraphs A through E, **County** will notify **Contractor** thereof within ten (10) days of the date of the delivery of such certificates to **County**. **Contractor** will provide to the **County** such additional information in respect of insurance provided by him as **County** may reasonably request. The right of the **County** to review and comment on Certificates of Insurance is not intended to relieve the **Contractor** of his responsibility to provide insurance coverage as specified nor to relieve the **Contractor** of his liability for any claims which might arise.
- D. The limits of liability for the insurance required by paragraph A of these General Conditions shall provide coverage for not less than the following amounts or greater where required by law.

For Claims under paragraphs A.1 and A.2, Workmen's Compensation

State	Statutory
Applicable Federal (e.g.) Longshoremen's Employer's Liability	Statutory \$1,000,000/person \$1,000,000/occurrence

For Claims under A.2 through A.5,

Commercial General Liability

\$1,000,000	Each Occurrence Limit
\$1,000,000	Personal & Advertising Injury Limit
\$2,000,000 (per project)	General Aggregate Limit
\$2,000,000	Products / Completed Ops Aggregate Limit

Bodily Injury:

\$1,000,000	Each Person
\$1,000,000	Each Occurrence
\$1,000,000 Operations	Annual Aggregate Products and Completed

Property Damage Liability Insurance will provide explosion, collapse, and underground coverage where applicable.

Property Coverage or Builders Risk Policy:

\$1,000,000	Each Person
\$1,000,000	Each Occurrence

Personal injury with employment exclusion deleted.

\$1,000,000	Annual Aggregate
-------------	------------------

For Claims under A.6, Comprehensive Automobile Liability:

Bodily Injury:

\$1,000,000	Each Person
\$1,000,000	Each Accident

Property Damage:

\$1,000,000	Each Occurrence
-------------	-----------------

The Contractual Liability required by paragraph B shall provide coverage for not less than the following amounts:

Contractual Liability Insurance:

Bodily Injury:

\$1,000,000	Each Occurrence
-------------	-----------------

Property Damage:

\$1,000,000	Each Occurrence
\$1,000,000	Annual Aggregate

E. Scope of Insurance and Special Hazards

The amounts of insurance in subparagraph "D" above are minimum amounts of insurance to be carried. The **Contractor** shall carry such additional insurance as may be required to provide adequate protection of the **Contractor** and his subcontractors, respectively, against any and all damage claims which may arise from operations under this Contract, whether such operations may be by the insured or by anyone directly or indirectly employed by him and, also, against any of the special hazards which may be encountered in the performance of this Contract.

The **Contractor's** and subcontractors' Public Liability and Property Damage Insurance shall provide adequate protection against the following special hazards: excavation, shoring, underpinning, blasting and explosion to the extent to which such risks are present."

Contractor's Pollution Liability (with 1 year extended reporting period)

\$1,000,000	Each Occurrence
\$2,000,000	Each Aggregate

Excess Umbrella Liability:

\$3,000,000	Excess Umbrella Liability
-------------	---------------------------

Section 103.07 FAILURE TO EXECUTE CONTRACT

Delete in its entirety and substitute the following:

"Failure or refusal to execute and deliver the Contract, Contract Performance and Payment Bond, or furnish satisfactory proof of insurance coverage required within ten (10) days after the date of notice of the Department's recommendation for award shall be just cause for the annulment of the award and for the

forfeiture of the Proposal Guaranty to Rockdale County, not as a penalty, but as liquidation of damages sustained for such failure or refusal. At the discretion of the **County**, the award may then be made to the next lowest responsible Bidder, or the Work may be re-advertised or constructed by County forces.

If the **County** re-advertises the project, the **County** may, at its discretion, not allow the Bidder who refused or failed to execute a contract, or who requested to withdraw any bid, to perform work on that contract or project as a contractor, subcontractor or in any other capacity for any function of construction. The Contract and Contract bonds shall be executed in two (2) original counterparts."

SECTION 105 - CONTROL OF WORK

Section 105.02 PLANS AND WORKING DRAWINGS

Add the following paragraphs:

"If, in the process of the Contract, discrepancies arise, the **Contractor** will be furnished additional instructions and detail drawings as necessary to carry out the work included in the Contract. The additional drawings and instructions thus supplied to the **Contractor** will coordinate with the Contract Documents and will be so prepared that they can be reasonably interpreted as part thereof.

The **Contractor** shall submit promptly to the Engineer six (6) copies of each shop or setting drawing prepared in accordance with the schedule predetermined as aforesaid. After examination of such drawings by the Engineer and the return thereof, the **Contractor** shall make such corrections to the drawings as have been indicated and shall furnish the Engineer with two (2) corrected copies. If requested by the Engineer, the **Contractor** must furnish additional copies. Regardless of corrections made in or approval given to such drawings by the Engineer, the **Contractor** shall nevertheless be responsible for the accuracy of such drawings and for their conformity to the Plans and Specifications at the time he furnishes such drawings."

Section 105.07 COOPERATION BETWEEN CONTRACTORS

Add the following paragraph:

The contractor shall coordinate with other contractors in the area constructing the Salem Gate Market Development. Drainage structures and other adjoining items shall be coordinated to ensure that all connections and proper drainage flow are maintained.

Section 105.14 MAINTENANCE DURING CONSTRUCTION

Retain in its entirety, but insert the following after the first paragraph:

"At all times, the **Contractor** shall perform work as may be required to protect the entire site, including both existing conditions and performed work, from damage. Furthermore, the **Contractor** shall be responsible for all damages to all persons and property due to the non-maintenance of the project site."

SECTION 106 - CONTROL OF MATERIALS

Section 106.03.A.3 SAMPLES, TESTS, CITED SPECIFICATIONS

Add the following paragraphs:

"The costs of any initial tests shall be borne by the **County**. Retesting due to failure of the initial test shall be billed to the **Contractor** by the County to include a ten percent (10%) administrative fee."

"Whenever a material, article, or piece of equipment is identified on the Plans or in the Specifications by reference to manufacturer's or vendor's names, catalog number, etc., it is intended merely to establish a standard; and any material, article, or equipment of the other manufacturers and vendors which will perform adequately the duties imposed by the general design will be considered equally acceptable provided the material, article,

or equipment so proposed is, in the opinion of the Engineer, of equal substance and function. It shall not be purchased or installed by the **Contractor** without the Engineer's written approval."

SECTION 107 - LEGAL REGULATIONS AND RESPONSIBILITY TO THE PUBLIC

Section 107.02 PERMITS AND LICENSES

Add the following paragraphs:

"The **Contractor** shall provide the **County**, on the proper form, proof of being licensed to do business within Rockdale County; proof of proper business licenses shall also be provided by the prime **Contractor** for any and all subcontractors coming under the jurisdiction of this Contract. (See Subcontractors' Notification List.)

Before any work proceeds along areas adjacent to a State Highway, the **Contractor** shall assure that a permit showing that the project is approved by the Georgia Department of Transportation is posted. **The Contractor shall notify both the Engineer and the local Georgia Department of Transportation's representative 48 hours before moving into a new area to begin construction."**

Section 107.07 PUBLIC CONVENIENCE AND SAFETY

Retain as written and add the following:

"The **Inspector** shall distribute a notice to each residence or business adjacent to the roadway *within the limits* of the project. The **County** will provide this notice to the **Inspector**, and it will be the responsibility of the **Inspector** to deliver the notices. To ensure that that these notices will be timely, they shall be distributed by individual road segment (project site), and they shall be distributed at least 24 hours prior to beginning construction activities on the respective road segment.

The notices will be used to inform the affected parties of the activities that will be occurring and will identify the **Contractor**.

The notice will be in the form of a letter and are not to be placed in or on the mailboxes. The **Inspector** will notify the **Contractor** upon completion of this work so that the **Contractor** can perform the work on the roadway. The **Contractor** may not work on a street without the letters being distributed.

Section 107.13 PROTECTION AND RESTORATION OF PROPERTY AND LANDSCAPE

Retain subparagraph C. and add the following paragraph:

"All chemicals used during project construction or furnished for project operation, whether herbicide, pesticide, disinfectant, polymer, reactant, or of other classification, must show approval of either EPA or USDA. Use of all such chemicals and disposal of residues shall be in strict conformance with instructions."

Delete subparagraph F in its entirety and substitute the following:

"The **Contractor** shall have the responsibility for removing and relocating all mailboxes to an area outside of the construction limits but still accessible for mail deliveries and convenient to the mail carrier and the patron during the entire time of construction. It may be necessary for the **Contractor** to confer with the Post Office serving the area.

As soon as construction has progressed to the stage that the mailbox may be erected in its permanent position, the **Contractor** shall coordinate the erection with the patron and the Post Office serving the area. Any damages to the posts or mailboxes due to the removal and/or relocations by the **Contractor** will remain the responsibility of the **Contractor**, all damaged posts and/or mailboxes shall be replaced and installed by the **Contractor** at his expense, including mailbox enclosures of masonry construction.

Any cost or costs to the **Contractor** for removing, relocating or installations of mailboxes as stated above shall be included in the overall bid price. Masonry mail boxes will not be relocated; however, if removed, a standard mail box will be installed."

Section 107.15 RESPONSIBILITY FOR DAMAGE CLAIMS

Add the following paragraph:

"**Contractor** shall indemnify and hold harmless the **County** and its agents, employees, successors, and assigns from and against all loss, cost, damage, claim, suit, and judgment, including attorney's fees, arising out of or resulting from the performance or non-performance of the work. **Contractor's** duty to indemnify applies in connection with, but is not limited to, injury to or death of any person or persons, loss of or damage to property caused by or in any way connected with **Contractor's** performance or non-performance of the work, whether such injury, death, loss, or damage results from any cause whatsoever. The **Contractor's** duty to indemnify shall extend to all claims, damage, loss, or expense caused in whole or in part by any act or omission of the **Contractor**, any subcontractor, or anyone directly or indirectly employed by any of them or anyone for whose acts any of them may be liable, regardless of whether or not it is caused in part by a party indemnified hereunder. The duty of the **Contractor** to indemnify, contained herein, shall not extend to any claim, damage, loss, or expense which results solely from the negligence of a party indemnified hereunder."

Section 107.17 CONTRACTOR'S RESPONSIBILITY FOR THE WORK

Retain in its entirety and add the following new paragraph:

"In case of an emergency which threatens loss or injury of property and/or safety of life, the **Contractor** will be allowed to act, without previous instruction from the Engineer, in a diligent manner. He shall notify the Engineer immediately thereafter. Any claim for compensation by the **Contractor** due to such extra work shall be promptly submitted to the Engineer for approval.

Where the **Contractor** has not taken action but has notified the Engineer of an emergency threatening injury to persons or damage to the work or any adjoining property, he shall act as instructed or authorized by the Engineer."

Section 107.18 AQUISITION OF RIGHT OF WAY

Delete in its entirety and substitute the following:

"The **County** shall furnish all land and right-of-way necessary for the carrying out of this Contract and the completion of the Work herein contemplated and will use due diligence in acquiring said land and rights-of-way as speedily as possible. But it is possible that all lands and rights-of-way as herein contemplated may not be completely secured before construction begins, in which event the **Contractor** shall begin his Work upon such land and rights-of-way as the **County** may have previously acquired, and no claim for damages whatsoever will be allowed by reason of the delay in obtaining the remaining land and rights-of-way. Should the **County** be prevented or enjoined from proceeding with the Work, or from authorizing its prosecution, either before or after the commencement, by reason of any litigation, or by reason of its inability to procure any lands or rights-of-way for the said Work, the **Contractor** shall not be entitled to make or assert claim for damage by reason of said delay, or, to withdraw from the Contract except by consent of the **County**, but time for completion of the Work will be extended to such time as the **County** determines will compensate for the time lost by such delay, such determination to be set forth in writing."

Section 107.20 NO WAIVER OF LEGAL RIGHTS

Retain in its entirety and add the following:

"The **Contractor** shall guarantee the work accomplished under this Contract for a period of twelve (12) months from the date of final acceptance. The **Contractor** shall remedy, at his own expense, and without additional cost to the **County**, all defects arising from either workmanship or materials, as determined by the Engineer. The guarantee shall not cover any accidental or deliberate damage to the work, or any defects occurring due to normal wear and tear during the twelve (12) months.

All equipment of whatever nature incorporated in the work covered by this Contract shall carry the same guarantee as outlined above for construction. Failure of any equipment or part thereof within the specified time shall be corrected to the satisfaction of the **County**, at the **Contractor's** expense. This guarantee does not apply to manufacturing defects of equipment furnished by the **County**.

The Performance Bond shall remain in full force and effect through the guarantee period."

107.23 ENVIRONMENTAL CONSIDERATIONS

Delete Subsection 107.23.A and replace with the following:

All environmental considerations and clearances shall be the responsibility of the County or municipality to meet, including the requirements of Section 404 of the Clean Water Act (33 USC 1344).

After July 1, 1991, State funded projects must comply with the requirements of Chapter 16 of Title 12 of the Official Code of Georgia Annotated, the Georgia Environmental Policy Act (GEPA), of 1991. In the compliance with GEPA, those projects for which Federal funding sought, and NEPA compliance is accomplished, are exempt from the requirements of GEPA.

GEPA requires that environmental documentation be accomplished for County or City projects if more than 50 percent of the total project cost is funded by a grant of a State Agency or a grant or more that \$250,000.00 is made by the State Agency to the municipality or County. The "responsible official of the government agency shall determine if a proposed governmental action is a proposed governmental action which may significantly adversely affect the quality of the environment."

A. The Following Project Would Not Significantly Adversely Affect The Quality Of The Environment:

Non-land disturbing activities and minor land disturbing activities that would not be anticipated to significantly affect the quality of the environment include the following list. These types of projects funded with state money would not be able to subject to environmental assessment of any kind. Hearing procedures outline in GEPA would not be applicable.

1. Minor roadway and non-historic bridge projects.
 - a. Modernization of an existing highway by resurfacing, restoration, rehabilitation, adding shoulders, widening a single lane or less in each direction and the addition of a median within previously disturbed existing right-of-way.
 - b. Adding auxiliary lanes for localized purposes (weaving, climbing, speed changes, etc.) and correction substandard curves and intersections within previously disturbed existing right-of-way.
 - c. Non-historic bridge replacement projects in existing alignment with no detour bridge.
2. Lighting, signing, pavement marking, signalization, freeway surveillance and control systems, and railroad protective devices.
3. Safety projects such as grooving, glazed screen, safety barriers, energy attenuators, median barriers, etc.

4. Highway landscaping and landscaping modification, rest area projects and truck weigh stations within previously disturbed existing right-of-way.
5. Construction of bus shelters and bays within existing right-of-way.
6. Temporary replacement of a highway facility that is commenced immediately after the occurrence of a natural disaster of catastrophic failure to restore the highway for the health, welfare, and safety of the public.

B. The Following Projects May Not Significantly Adversely Affect The Quality of The Environment:

For projects that will cause land disturbance and for which there is no anticipation that the project may significantly adversely affect the quality of the environment, certain studies will be undertaken. These studies would serve to document whether or not the County or municipality should anticipate that a project might significantly adversely affect the quality of the environment. Documentation of the studies will be accomplished through the use of the "GEPA Investigation Studies" checklist.

The types of projects that would fall under the category would include:

1. Bridge replacement projects on new location or with a detour bridge, where there are no significant adverse impacts to historic or archaeological resources, no involvement with Federally listed threatened and endangered species and no significant adverse impact to wetlands.
2. Passing lanes, median additions and widening projects, where there are no significant adverse impacts to historic or archaeological resources, no involvement with Federally listed threatened and endangered species and no significant adverse impact to wetlands.
3. Safety and intersection improvements where there are no significant adverse impacts to historic or archaeological resources, no involvement with Federally listed threatened and endangered species and no significant adverse impact to wetlands.
4. Rest area projects and truck weigh stations with no purchase of additional right-of-way.
5. New location projects where there are no significant adverse impacts to historic or archaeological resources, no involvement with Federally listed threatened and endangered species and no significant adverse impact to wetlands.

If studies demonstrate that the project will not significantly adversely affect the quality of the environment, project files will be documented. If studies demonstrate that the project may significantly adversely affect the quality of the environment, development of an environmental effects report (EER) will be undertaken along with full GEPA compliance.

C. The Following Projects May Not Significantly Adversely Affect The Quality of The Environment:

This category of projects may include major widening and new location projects. If such projects result in a significant adverse effect, an EER shall be prepared.

D. EER Procedure:

GEPA calls for consideration of the "cumulative effect of the proposed government actions on the environment....if a series of proposed government actions are related to either geographically or as logical parts in a chain of contemplated actions." Therefore, EER's for sections of roadways to be widened or built as new location facilities will include all projects that are connected geographically or as logical parts in a chain of contemplated actions.

1. During preparation of an environmental effect report, the County or Municipality will consult with and solicit comments from agencies that have jurisdiction by law, special expertise, or other interest with respect to environmental impacts.
2. In compliance with GEPA the following shall be contained in the EER, at a minimum:

- a. Cover sheet;
 - b. Executive summary;
 - c. Alternatives, including the no-build;
 - d. Relevant environmental setting; Geology, soils, water supply and wetlands, floral fauna, archaeology/history, economic environment, energy, cultural resources;
 - e. The environmental impact of the proposed action of the relevant setting and mitigation measures proposed to avoid or minimize adverse impact;
 - f. Unavoidable adverse environmental effects;
 - g. Value of short-term uses of the environment and maintenance and enhancement of its long-term value;
 - h. Beneficial aspects, both long term and short term and its economic advantages and disadvantages;
 - i. Comments of agencies which have jurisdiction by law, special expertise, or other interest with respect to any environmental impact or resource;
3. At least 45 days prior to making a decision as to whether to proceed with the undertaking, publish in the “legal organ of each County in which the proposed governmental action or any part thereof is to occur, notice that an environmental effects report has been prepared”.
 4. The County or Municipality shall send a copy of the EER and all other comments to the Director, EPD.
 5. The County or Municipality shall make the document available to the public and agencies, upon request.
 6. A public hearing will be held in each affected county if at least 100 residents of the State of Georgia request on within 30 days of publication in the legal organ of an affected County. The responsible official or his designee may hold a public hearing if less than 100 requests are received. (The county or municipality is not relieved of other State legal requirements of public hearings, however.)
 7. Following the public notice period and/or public hearing, a summary of the document, comments received and recommendation as to whether to proceed with the action as originally prepared, to proceed with changes, or not to proceed will be prepared (Notice of Decision).
 8. This decision document, when signed by the responsible official, will be sent to the director, EPD, and an abbreviated notice of the decision will be published in the legal organ of each County in which the proposed governmental action or any part thereof is to occur.
 9. A copy of the decision document, the EER and public hearing comments (if any) will be sent to Rockdale County Department of Transportation, Georgia Department of Transportation, Office of Environment and Location and the Department of Natural Resources, Environmental Protection Division for their files.

**Department of Transportation
Office of Environmental Services
600 W. Peachtree Street, NW
Atlanta, Georgia 30308**

**Department of Natural Resources
Environmental Protection Division
205 Butler Street, SE
Suite 1152
Atlanta, Georgia 30334**

SECTION 108 - PROSECUTION AND PROGRESS

Section 108.01 SUBLETTING OF CONTRACT

Retain as written except as follows:

Delete the second and third paragraph and substitute the following:

In case such consent is given, the Contractor will be permitted to sublet a portion thereof, but shall perform, with his own organization, work amounting to not less than fifty percent (50%) of the total contract cost, including materials, equipment and labor.

All Subcontractors approved by the Engineer must submit a "Noncollusion Affidavit for Subcontractors, before any work by that Subcontractor may proceed."

Add the following:

"In accordance with the provisions stated above, the following items are designated Specialty Items whenever they appear in the Contract:

- All Grassing Items
- All Fencing Items
- All Highway Lighting Items
- All Highway Sign Items
- All Guardrail Items (Except Bridge Handrail)
- All Utility Items
- All Comfort and Convenience Facilities in Rest Areas
- All Landscaping Items
- All Pressure Grouting, Slab Removal and Replacement
- All Permanent Traffic Markings
- All Signal Systems
- All Railroad Trackwork above Sub-ballast
- Construction Layout

The cost of the above items will be subtracted from the original Contract Amount and the subsequent balance used to determine the percent limitation mentioned above.

If the **Contractor** elects to sublet a Specialty Item, no work on any such Specialty Items shall be begun without prior approval of the necessary Subcontract.

The **Contractor's** cost for Construction Layout shall be fully documented prior to deduction from the original Contract amount."

108.03 PROSECUTION AND PROGRESS

Retain Subsection 108.03 except as modified below:

For this Project, the Progress Schedule required by Subsection 108.03 need not be submitted.

108.11 SCHEDULING

Every effort shall be made to meet project schedules submitted and approved by the County. If scheduling changes are necessary, the Contractor shall notify the County 24 hours in advance to allow for rescheduling of field and material testing contractors contracted by the County. The Contractor shall be liable for costs accrued by the field and material testing contractor for work cancellations resulting from insufficient notification.

The County requires five (5) working days to process requests to trim trees, shrubs, or bushes from the right-of-way to accommodate resurfacing operations.

Notify Rockdale County Water Resources two (2) weeks in advance for requests to verify existing utilities which may require lowering of water lines or laterals that may interfere with operations.

The County shall not be liable for delays to schedules as a result of insufficient notice regarding the items above.

SECTION 109 - MEASUREMENT AND PAYMENT

Section 109.07 PARTIAL PAYMENTS

Delete Subsection 109.07.A in its entirety and substitute the following:

"A. General:

The Contractor shall on the first Business Day of each calendar month submit the estimated total value of items complete in place for the previous calendar month to the Engineer for verification for only the roads in which work has been completed. If discrepancies are discovered by the Engineer, he will contact the Contractor to make any necessary corrections as soon as possible. Such estimate is approximate only, and may not necessarily be based on detailed measurements. Value will be computed on the basis of Contract Unit Prices or on percentage of completion of any Lump Sum Item."

Add Subsection 109.07.I to read as follows:

"I. Retainage

Retainage will not be withheld from payments under this Contract"

Section 109.08 FINAL PAYMENT

Delete in its entirety and substitute the following:

"Upon completion by the **Contractor** of The Work, including the receipt of any final written submission of the **Contractor** and the approval thereof by the Department, the **County** will pay the **Contractor** a sum equal to 100 percent (100%) of the compensation set forth herein, less the total of all previous partial payments, paid or in the process of payment.

The **Contractor** agrees that acceptance of this final payment shall be in full and final settlement of all claims arising against the **County** for work done, materials furnished, costs incurred, or otherwise arising out of this Contract Agreement and shall release the **County** from any and all further claims of whatever nature, whether known or unknown for and on account of said Contract Agreement, and for any and all work done, and labor and materials furnished, in connection with same.

No final payment shall be made until the **Contractor AND his Subcontractors** furnish to the **County** a sworn affidavit to the effect that all bills are paid and no suits and/or liens are pending in connection with the work

done or labor and materials furnished under this Contract. Final payment will be made within sixty (60) days after approval by the Engineer.

The **Contractor** will be required to maintain all work done by him in a first-class condition for sixty (60) days after the same has been completed as a whole, and the Engineer has notified the **Contractor** in writing that the work has been finished to his satisfaction. The retained percentage will not be due or payable to the **Contractor** until the 60-day maintenance period has ended."

SECTION 149 - CONSTRUCTION LAYOUT

Section 149.3.05 CONSTRUCTION

Delete Subsection K, paragraph 2, which begins, "For new bridges ..." in its entirety.

SECTION 150 - TRAFFIC CONTROL

Add the following:

150.01 General

This section as supplemented by the Plans, Specifications, and Manual on Uniform Traffic Control Devices (MUTCD) shall be considered the Traffic Control Plan. Activities shall consist of furnishing, installing, maintaining, and removing necessary traffic signs, barricades, lights, signals, cones, pavement markings and other traffic control devices and shall include flagging and other means for guidance and protection of and vehicular pedestrian traffic through the Work Zone. This Work shall include both maintaining existing devices and installing additional devices as necessary in construction work zones.

When any provisions of this Specification or the Plans do not meet the minimum requirements of the MUTCD, the MUTCD shall control. The 2009 with 2012 Revisions 1 and 2 Edition of the MUTCD shall be in effect for the duration of the project.

The Worksite Traffic Control Supervisor (WTCS) shall have a copy of Part VI of the MUTCD on the job site. Copies of the current MUTCD may be obtained from the FHWA web page at <https://mutcd.fhwa.dot.gov/pdfs/2009r1r2/mutcd2009r1r2edition.pdf>

A. WORKER SAFETY APPAREL

All workers exposed to the risks of moving roadway traffic or construction equipment shall wear high-visibility safety apparel meeting the requirements of International Safety Equipment Association (ISEA) American National Standard for High-Visibility Safety Apparel, or equivalent revisions, and labeled as ANSI-2004 Class 2 or 3 risk exposure.

B. Worksite Traffic Control Supervisor

ALL HIGHWAYS (ADDITIONAL REQUIREMENTS BELOW FOR INTERSTATES): The Contractor shall designate a qualified individual as the Worksite Traffic Control Supervisor (WTCS) who shall be responsible for selecting, installing and maintaining all traffic control devices in accordance with the Plans, Specifications, Special Provisions and the MUTCD. A written resume documenting the experience and credentials of the WTCS shall be submitted and accepted by the Engineer prior to beginning any work that involves traffic control.

The WTCS shall be available on a twenty-four (24) hour basis to perform his duties. If the work requires traffic control activities to be performed during the daylight and nighttime hours it may be necessary for the Contractor to designate an alternate WTCS. An alternate WTCS must meet the same requirements and qualifications as the primary WTCS and be accepted by the Engineer prior to beginning any traffic control duties. The Worksite Traffic Control Supervisor's traffic control responsibilities shall have priority over all other assigned duties.

As the representative of the Contractor, the WTCS shall have full authority to act on behalf of the Contractor in administering the Traffic Control Plan. The WTCS shall have appropriate training in safe traffic control practices in accordance with Part VI of the MUTCD. In addition to the WTCS all other individuals making decisions regarding traffic control shall meet the training requirements of the Part VI of the MUTCD.

The WTCS shall supervise the initial installation of traffic control devices. The Engineer prior to the beginning of construction will review the initial installation. Modifications to traffic control devices as required by sequence of operations or staged construction shall be reviewed by the WTCS.

The WTCS shall be available on a full-time basis to maintain traffic control devices with access to all personnel, materials, and equipment necessary to respond effectively to an emergency situation within forty-five (45) minutes of notification of the emergency.

The WTCS shall regularly perform inspections to ensure that traffic control is maintained. Unless modified by the special conditions or by the Engineer, routine deficiencies shall be corrected within a twenty-four (24) hour period. Failure to comply with these provisions shall be grounds for dismissal from the duties of WTCS and/or removal of the WTCS from the project. Failure of the WTCS to execute his duties shall be considered as non-performance under Subsection 150.08.

The Engineer will periodically review the work for compliance with the requirements of the traffic control plan. On projects where traffic control duties will not require full time supervision, the Engineer may allow the Contractor's Project Superintendent to serve as the WTCS as long as satisfactory results are obtained.

CERTIFIED WORKSITE TRAFFIC CONTROL SUPERVISOR

ADDITIONAL REQUIREMENTS FOR INTERSTATE AND LIMITED ACCESS HIGHWAYS: In addition to the requirements above, the WTCS shall have a minimum of one year's experience directly related to work site traffic control in a supervisory or responsible capacity. The WTCS shall be currently certified by the American Traffic Safety Services Association (ATSSA) Work Site Traffic Supervisor Certification program, the National Safety Council Certification program or an equal approved by the Department.

Any work performed on the interstate or limited access highway right-of-way that requires traffic control shall be supervised by the Certified Worksite Traffic Control Supervisor. No work requiring traffic control shall be performed unless the certified WTCS is on the worksite. Failure to maintain a Certified Worksite Traffic Control Supervisor on the work will be considered as non-performance under Subsection 150.08.

The WTCS shall perform, as a minimum, weekly traffic control inspections on all interstate and limited access highways. The inspection shall be reported to the Engineer on a TC-1 report. The Engineer will furnish a blank copy of the TC-1 report to the Contractor prior to the beginning of any work on the interstate or limited access right-of-way.

C. Traffic Control Devices

All traffic control devices used during the construction of a project shall meet the Standards utilized in the MUTCD, and shall comply with the requirements of these Specifications, Project Plans, and Special Provisions. All devices shall be tested at NCHRP Test Level III. Reference is made to Subsections 104.05, 107.07, and 107.09.

D. Reflectorization Requirements

All rigid fluorescent orange construction warning signs (black on fluorescent orange) shall meet the reflectorization and color requirements of ASTM Type VII, VIII, IX or X regardless of the mounting height.

Portable signs which have flexible sign blanks shall meet the reflectorization and color requirements of ASTM Type VI.

Warning signs (W3-1a) for stop conditions that have rumble strips located in the travel way shall be reflectorized with ASTM Type IX fluorescent yellow sheeting.

All other signs shall meet the requirements of ASTM Type III or IV except for "Pass With Care" and "Do Not Pass" signs which may be ASTM Type I unless otherwise specified.

CHANNELIZATION DEVICES: Channelization devices shall meet the requirements of ASTM Type III or IV high intensity sheeting.

E. Implementation Requirements

No work shall be started on any project phase until the appropriate traffic control devices have been placed in accordance with the Project requirements. Changes to traffic flow shall not commence unless all labor, materials, and equipment necessary to make the changes are available on the Project.

When any shift or change is made to the location of traffic or to the flow patterns of traffic, the permanent safety features shall be installed and fully operational before making the change. If staging or site conditions prevent the installation of permanent features then the equivalent interim devices shall be utilized.

Any section of the work that is on new location shall have all permanent safety features installed and fully operational before the work is opened to traffic. Safety features shall include but are not limited to the following items:

- Guardrail including anchors and delineation
- Impact attenuators
- Traffic signals
- Warning devices
- Pavement markings including words, symbols, stop bars, and crosswalks
- Roadway signs including regulatory, warning, and guide

Outdoor lighting shall be considered as a safety feature for welcome centers, rest areas, and weigh station projects. For typical roadway type projects new street lighting is not considered a safety feature unless specifically noted in the plans or in the special conditions.

F. Maintenance of Traffic Control devices

Traffic control devices shall be in acceptable condition when first erected on the project and shall be maintained in accordance with Subsection 104.05 throughout the construction period. All unacceptable traffic control devices shall be replaced within 24 hours. When not in use, all traffic control devices shall be removed, placed or covered so as not to be visible to traffic. All construction warning signs shall be removed within seven calendar days after time charges are stopped or pay items are complete. If traffic control devices are left in place for more than ten days after completion of the Work, the Department shall have the right to remove such devices, claim possession thereof, and deduct the cost of such removal from any monies due, or which may become due, the Contractor.

G. Traffic Interruption Restrictions

The Department reserves the right to restrict construction operations when, in the opinion of the Engineer, the continuance of the Work would seriously hinder traffic flow, be needlessly disruptive or unnecessarily inconvenience the traveling public. The Contractor shall suspend and/or reschedule any work when the Engineer deems that conditions are unfavorable for continuing the Work.

Advanced notification requirements to the Contractor to suspend work will be according to the events and the time restrictions outlined below:

Incident management	No advanced notice required
Threatening/Inclement weather	24 hours
Holidays, sporting events, unfavorable conditions	Three (3) calendar days

If the work is suspended, the Contractor may submit a request for additional contract time as allowed under Section 108. The Department will review the request and may grant additional contract time as justified by the impact to the Contractor's schedule. Compensation for loss of productivity, rescheduling of crews, rental of equipment or delays to the Contractor's schedule will not be considered for payment. Additional contract time will be the only consideration granted to the Contractor.

H. Sequence of Operations

Any Sequence of Operations provided in this Contract in conjunction with any staging details which may be shown in the plans, is a suggested sequence for performing the Work. It is intended as a general staging plan for the orderly execution of the work while minimizing the impact on the mainline, cross-streets and side streets. The Contractor shall develop detailed staging and traffic control plans for performing specific areas of the Work including but not limited to all traffic shifts, detours, bridge widenings, paces, or other activities that disrupt traffic flow. The Engineer may require detailed staging and traffic control plans for lane closures. These plans shall be submitted for approval at least two weeks prior to the scheduled date of the activity. Activities that have not been approved at least seven (7) days prior to the scheduled date shall be rescheduled.

Where traffic is permitted through the work area under stage construction, the Contractor may choose to construct, at no additional expense to the Department, temporary on-site bypasses or detours in order to expedite the work. Plans for such temporary bypasses or detours shall be submitted to the Engineer for review and approval 30 calendar days prior to the proposed construction. Such bypasses or detours shall be removed promptly when in the opinion of the Engineer; they are not longer necessary for the satisfactory progress of the Work. Bypasses and detours shall meet the minimum requirements of Subsection 150.02.B.4.

As an option to the Sequence of Operations in the Contract, the Contractor may submit an alternative Sequence of Operations for review and approval. A twenty calendar day lead time for the Department's review shall be given to this submission so that a decision on its acceptability can be made and presented at the Preconstruction Conference. Insufficient lead time or no submission by the Contractor shall be construed as acceptance of the Sequence of Operations outlined in the Contract and the willingness of the Contractor to execute this as-bid plan.

The Department will not pay, or in any way reimburse the Contractor for claims arising from the Contractor's inability to perform the Work in accordance with the Sequence of Operations provided in the Contract or from an approved Contractor alternate.

The Contractor shall secure the Engineer's approval of the Contractor's proposed plan of operation, sequence of work and methods of providing for the safe passage of vehicular and pedestrian traffic before it is placed in operation. The proposed plan of operation shall supplement the approved traffic control plan. Any major changes to the approved traffic control plan, proposed by the Contractor, shall be submitted to the Department for approval.

Some additional traffic control details will be required prior to any major shifts or changes in traffic. The traffic control details shall include, but not be limited to, the following:

1. A detailed drawing showing traffic locations and laneage for each step of the change.
 - a. The location, size, and message of all signs required by the MUTCD, Plan, Special

Provisions and other signs as required to fit conditions. Any portable changeable message signs used shall be included in the details.

- b. The method to be used in, and the limits of, the obliteration of conflicting lines and markings.
4. Type, location, and extent of new lines and markings.
5. Horizontal and vertical alignment and superelevation rates for detours, including cross-section and profile grades along each edge of existing pavement.
6. Drainage details for temporary and permanent alignments.
7. Location, length, and/or spacing of channelization and protective devices (temporary barrier, guardrail, barricades, etc.)
8. Starting time, duration and date of planned change.
9. For each traffic shift, a paving plan, erection plan, or work site plan, as appropriate, detailing workforce, materials, and equipment necessary to accomplish the proposed work. This will be the minimum resource allocation required in order to start the work.

A minimum of three copies of the above details shall be submitted to the Engineer for approval at least 14 days prior to the anticipated traffic shift. The Contractor shall have traffic control details for a traffic shift which has been approved by the Engineer prior to commencement of the physical shift. All preparatory work relative to the traffic shift, which does not interfere with traffic, shall be accomplished prior to the designated starting time. The Engineer and the Contractor's representative will verify that all conditions have been met prior to the Contractor obtaining materials for the actual traffic shift.

I. Compliance dates for provisions of the MUTCD

Federal law requires that traffic control devices (temporary or permanent) installed on new highway or bikeway construction or reconstruction shall be compliant with the latest version of the MUTCD before the road is opened to the public for unrestricted travel. The latest version of the MUTCD is the 2009 Edition with 2012 Revisions 1 and 2, which the Georgia Department of Transportation has adopted. However, the FHWA, in the introduction to the MUTCD has established alternate compliance dates for some of the new provisions of the 2009 MUTCD. Below is a list of those compliance dates.

The Department may decide to require contractors to implement some or all of these provisions at an earlier date than the compliance dates noted below. However notice will be given in advance of the letting date if these provisions are to be implemented prior to the compliance dates. The contractor may also decide to implement the new provisions in the 2009 MUTCD earlier than required by the compliance dates below.

The target dates established by the FHWA shall be as follows:

Section 6D.03 Worker Safety Considerations – high-visibility apparel requirements – December 31, 2011

Section 6E.02 High-Visibility Safety Apparel – high-visibility apparel requirements for flaggers – December 31, 2011.

150.02 Temporary Traffic Control Zones

A. Devices and Materials

In addition to the other provisions contained herein, work zone traffic control shall be accomplished using the following means and materials:

1. Portable Advance Warning Signs

Portable advance warning signs shall be utilized as per the requirements of the traffic control plans. All signs shall meet the requirements of the MUTCD and shall be NCHRP 350 crashworthy compliant.

2. Arrow Panels

Portable sequential or flashing arrow panels as shown in the Plans or Specifications for use on Interstate or multi-lane highway lane closure only, shall be a minimum size of 48” high by 96” wide with not less than 15 lamps used for the arrow. The arrow shall occupy virtually the entire size of the arrow panel and shall have a minimum legibility distance of one mile. The minimum legibility distance is that distance at which the arrow panel can be comprehended by an observer on a sunny day, or clear night.

Arrow panels shall be equipped with automatic dimming features for use during hours of darkness. The arrow panels shall also meet the requirements for a Type C panel as shown in the MUTCD. The sequential or flashing arrow panels shall not be used for lane closure on two-lane, two-way highways when traffic is restricted to one-lane operations in which case, appropriate signing, flaggers and when required, pilot vehicles will be deemed sufficient.

The sequential or flashing arrow panels shall be placed on the shoulder at or near the point where the lane closing transition begins. The panels shall be mounted on a vehicle, trailer, or other suitable support. Vehicle mounted panels shall be provided with remote controls. Minimum mounting height shall be seven feet above the roadway to the bottom of the panel, except on vehicle mounted panels which should be as high as practical.

For emergency situations, arrow display panels that meet the MUTCD requirements for Type A or Type B panels may be used until Type C panels can be located and placed at the site. The use of Type A and Type B panels shall be held to the minimum length of time possible before having the Type C panel(s) in operation. The Engineer shall determine when conditions and circumstances are considered to be emergencies. The Contractor shall notify the Engineer, in writing, when any non-specification arrow display panel(s) is being used in the work.

3. Portable Changeable Message Signs

Portable changeable message signs meeting the requirements of Section 632 and the MUTCD. Any PCMS in use that is not protected by positive barrier protection shall be delineated by a minimum of three drums that meet the requirement of Subsection 150.05.A.1. The drum spacing shall not exceed a maximum of ten (10’) feet as shown in Detail 150-PCMS. When the PCMS is within twenty (20’) feet of the opposing traffic flow, the trailing end of the PCMS shall be delineated with a minimum of three drums spaced in the same manner as the approach side of the PCMS.

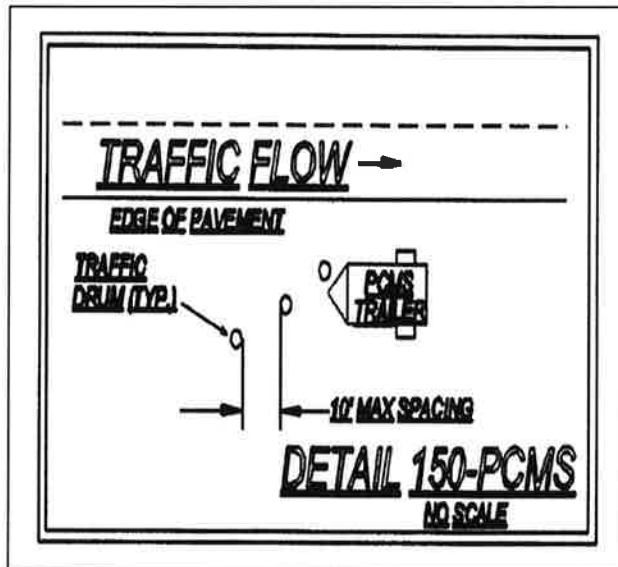

When not in use the PCMS shall be removed from the roadway unless protected by positive barrier protection. If the PCMS is protected by positive barrier protection the sign panel shall be turned away from traffic when not in use.

4. Channelization Devices

Channelization devices shall meet the standards of the MUTCD and Subsection 150.05.

5. Temporary Barrier

Temporary barrier shall meet the requirements of Sections 620.

6. Temporary Traffic Signals

Temporary traffic signals shall meet the requirements of Section 647 and the MUTCD.

7. Pavement Marking

Pavement marking incorporated into the work shall comply with Subsections 150.04.A and 150.04.B.

8. Portable Temporary Traffic Control Signals

The use of Portable Temporary Traffic Control Signals shall meet the following minimum requirements:

Only two-lane two-way roadways will be allowed to utilize Portable Temporary Traffic Control Signals.

All portable traffic control signals shall meet the physical display and operational requirements of conventional traffic signals described in the MUTCD.

Each signal face shall have at least three lenses. The lenses shall be red, yellow, or green in color and shall give a circular type of indication. All lenses shall be twelve (12") inches nominal in diameter.

A minimum of two signal faces shall face each direction of traffic. A minimum of one signal head shall be suspended over the roadway travel lane in a manner that will allow the bottom of the signal head housing to be not less than seventeen (17') feet above and not more than nineteen (19') feet above the pavement grade at the center of the travel lane. The second signal head may be located over the travel lane with the same height requirements or the second signal head may be located on the shoulder. When the signal head is located on the shoulder the bottom of the signal head housing shall be at least eight (8') feet but not more than (15') feet above the pavement grade at the center of highway.

Advance warning signage and appropriate pavement markings shall be installed as part of the temporary signal operation.

The signals shall be operated in a manner consistent with traffic requirements. The signals may be operated in timed-mode or in a vehicle-actuated mode. The signals shall be interconnected in a manner to ensure that conflicting movements cannot occur. To assure that the appropriate operating pattern including timing is displayed to the traveling public, regular inspections including the use of accurate timing devices shall be made by the Worksite Traffic Control Supervisor. If at any time any part of the system fails to operate within these requirements then the use of the signal shall be suspended and the appropriate flagging operation shall begin immediately.

The Worksite Traffic Control Supervisor (WTCS) shall continuously monitor the portable traffic control signal to insure compliance with the requirements for maintenance under the MUTCD. The signal shall be maintained in a manner consistent with the intention of the MUTCD, with

emphasis on cleaning of the optical system. Timing changes shall be made only by the WTCS. The WTCS shall keep a written record of all timing changes.

The portable temporary signal shall have two power sources and shall be capable of running for seven calendar days continuously.

The Contractor shall have an alternate traffic control plan in the event of failure of the signal.

9. Rumble Strips

Rumble strips incorporated into the work shall meet the requirements of Section 429 and the MUTCD. Existing rumble strips that are positioned in the traveled way to warn traffic of a stop condition shall be reinstalled based on the following requirements:

INTERMEDIATE SURFACES: Intermediate surfaces that will be in use for more than forty-five (45) calendar days shall have rumble strips reinstalled on the traveled way in the area of a stop condition. Non-refundable deductions in accordance with Subsection 150.08 will be assessed for any intermediate surface in place for greater than 45 days without rumble strips.

FINAL SURFACES: Rumble strips shall be installed on the final surface within fourteen (14) calendar days of the placement of the final surface in the area of the stop condition. Failure to install within fourteen (14) calendar days will result in assessment of non-refundable deductions in accordance with Subsection 150.08.

Prior to the removal of any rumble strips located in the travel way, stop ahead (W3-1a) warning signs shall be double indicated ahead of the stop condition. These warning signs shall be a minimum of 48 inches by 48 inches. The reflectorization of the warning signs shall be as required by Subsection 150.01.C. These warning signs shall remain in place until the rumble strips have been reinstalled on the traveled way. Any existing warning signs for the stop ahead condition shall be removed or covered while the 48" X 48" (W3-1a) signs are in place. When the rumble strips have been reinstalled these warning signs should be promptly removed and any existing signage placed back in service.

10. Guardrail

When the removal and installation of guardrail is required as a part of the work the following time restrictions shall apply unless modified by the special conditions:

MULTI-LANE HIGHWAYS: From the time that the existing guardrail or temporary positive barrier protection is removed the Contractor has fourteen (14) calendar days to install the new guardrail and anchors. During the interim, the location without guardrail shall be protected with drums spaced at a maximum spacing of twenty (20') feet. The maximum length of rail that can be removed at any time without being replaced with positive barrier protection is a total of 2000 linear feet of existing rail or the total length of one run of existing rail, whichever is greater.

ALL OTHER HIGHWAYS: From the time that the existing guardrail is removed or from the time that temporary positive barrier protection is removed the Contractor has thirty (30) calendar days to install the new guardrail and anchors. During the interim, the location without guardrail shall be protected with drums spaced at a maximum spacing of twenty (20') feet. The maximum length of rail that can be removed at any time without being replaced with positive barrier protection is a total of 1000 linear feet of existing rail or the total length of one run of existing rail, whichever is greater.

Based on existing field conditions, the Engineer may review the work and require that the guardrail be installed earlier than the maximum time allowed above by giving written notification to the Contractor via the TC-1 traffic control report. Failure to comply with the above time and quantity restrictions shall be considered as non-compliance under Subsection 150.08.

11. Stop sign regulated intersections

For intersections that utilize stop sign(s) to control the flow of traffic and to restrict the movement of vehicles, the stop sign(s) shall be maintained for the duration of the work or until such time that the stop condition is eliminated or until an interim or permanent traffic signal can be installed to provide proper traffic control. The traffic signal shall be installed and properly functioning before the removal of the existing stop sign(s) is permitted. If the existing intersection is enhanced traffic control features such as stop bars, double indicated stop signs, oversized signs, advanced warning stop ahead signs, rumble strips on the approaches or flashing beacons located overhead or on the shoulders then these features shall be maintained for the duration of the project or until the permanent traffic control plan has been implemented.

Whenever the staging of the work requires that the traveled-way be relocated or realigned the Contractor shall reinstall all enhanced traffic control features noted above on the newly constructed sections of the work. The cost of relocating the stop bars, stop signs, advanced warning signs, the rumble strips and the flashing beacons shall be included in the price bid for Lump-Sum-Traffic Control unless individual pay items are included in the contract for rumble strips and/or flashing beacons. When pay items are included in the contract for rumble strips or flashing beacons then these items will be paid per each.

When staging requires the relocation or realignment of an existing stop condition it may be necessary to consider the addition of enhanced traffic control features even though none existed at the original location. As a guide for enhanced traffic control features that may be considered, the Engineer or the WTCS may refer to the Department's guidelines for "Opening of New Roadways to Traffic" (Document #6635-2). Horizontal and vertical alignment changes at a new location may have decreased or restricted sight distance or the stop condition may occur sooner than in the previous alignment. If these conditions occur then the Engineer and/or the WTCS should consider additional measures to enhance the motorist's awareness of the changes even though the staging plans may not address enhanced features. Stop signs should be a minimum of 36 inches for interim situations. The use of 48 inch stop signs may be warranted under project specific conditions.

Flags may be used on interim/permanent stop signs that are mounted at seven (7') feet in height for a short duration in order to direct additional attention to a new or relocated stop sign(s). Flags should not be used for durations exceeding two weeks unless unusual or site specific conditions warrant a longer period of time. The use of Type "A" flashing red light(s) attached to the stop sign(s) may be appropriate during the same period that the flags are in use to increase attention.

The use of rumble strips and/or portable changeable message signs may be considered. The use of new rumble strips, where none previously existed, shall have the prior approval of District Traffic Operations before being included as part of the traffic control plan. The message(s) displayed on any PCMS shall have the prior approval of the Engineer and the message(s) shall be included as part of the traffic control plan for the interim staging.

The placement of any additional interim ground-mounted signs and posts or stop bars shall be considered as incidental to the price bid for Lump Sum-Traffic Control. The installation of rumble strips, flashing beacons or the use of Portable Changeable Message Signs (PCMS) shall be considered as Extra Work unless pay items are included in the contract.

B. Work zone restrictions

1. Interstate

The Contractor shall not simultaneously perform work on both the inside shoulder and outside shoulder on either direction of traffic flow when the Work is within 12 feet of the travel-way, unless such areas are separated by at least one-half mile of distance.

2. Non-Interstate Divided Highways

The Contractor shall not simultaneously perform work on both the inside shoulder and outside shoulder on either direction of traffic flow when the Work is within 12 feet of the travel-way, unless such areas are separated by at least one-half mile distance in rural areas or at least 500 feet of distance in urban areas.

3. Non-Divided Highways

The Contractor shall not simultaneously perform work on opposite sides of the roadway when the work is within 12 feet of the travel-way, unless such areas are separated by at least one-half mile of distance in rural areas or at least 500 feet of distance in urban areas.

On two-lane projects where full width sections of the existing subgrade, base or surfacing are to be removed, and new base, subgrade, or surfacing are to be constructed, the Contractor shall maintain one-lane traffic through the construction area by removing and replacing the undesirable material for half the width of the existing roadway at a time. Replacement shall be made such that paving is completed to the level of the existing pavement in the adjacent lane by the end of the workday or before opening all the roadway to traffic.

4. All Highways:

a. There shall be no reduction in the total number of available traffic lanes that existed prior to construction except as specifically allowed by the Contract and as approved by the Engineer.

b. Travel way Clearances: All portions of the work shall maintain the following minimum requirements:

Horizontal: The combined dimensions of the paved shoulder and the roadway surface remaining outside the Work Zone shall be no less than sixteen (16) feet in width at any location.

Vertical: The overhead clearance shall not be reduced to less than fifteen (15) feet at any location.

The restrictions above apply to all shifts, lane closures, on-site detours and off site detours whether shown in the contract or proposed by the Contractor. It shall be the responsibility of the Contractor to verify that these minimum requirements have been met before proceeding with any phase of the Work.

Two-lane two-way roadways may have temporary horizontal restrictions of less than sixteen (16) feet provided a flagger operation for one-way traffic is utilized to restrict access to the work area by over-width loads. The minimum horizontal clearance shall be restored before the flagging operation is removed.

c. Highway Work Zone: All sections or segments of the roadway under construction or reconstruction shall be signed as a Highway Work Zone except non-state highway two-lane two-way resurfacing projects. Two conditions can be applied to a Highway Work Zone. Condition 1 is when no reduction in the existing speed limit is required. Condition 2 is when worksite conditions require a reduction of the speed limit through the designated Work Zone. Properly marking a Highway Work Zone shall include the following minimum requirements:

1) NO REDUCTION IN THE EXISTING POSTED SPEED LIMIT IN HIGHWAY WORK ZONE:

a) Signage (Detail 150-HWZ-2) shall be posted at the beginning point of the Highway Work Zone warning the traveling public that increased penalties for speeding violations are in effect. The HWZ-2 sign shall be placed a minimum of six hundred (600') feet in advance of the Highway Work Zone and shall not be placed more than one thousand (1000') feet in advance of the Work Zone. If no speed reduction is

required it is recommended that the HWZ-2 be placed at 750 feet from the work area between the ROAD WORK 500 FT. and the ROAD WORK 1000 FT. signs. HWZ-2 signs shall be placed at intervals not to exceed one mile for the length of the project. HWZ-2 signs should be placed on the mainline after all major intersections except State Routes. State Routes shall be signed as per the requirements for intersecting roadways below.

- b) The existing speed limit shall be posted at the beginning of the Work Zone. Existing Speed Limit signs (R2-1) shall be maintained.
 - c) INTERSECTING ROADWAYS: Intersecting state routes shall be signed in advance of each intersection with the Work Zone with a HWZ-2 sign to warn motorists that increased fines are in effect. All other intersecting roadways that enter into a designated Highway Work Zone may be signed in advance of each intersection with the Work Zone. When construction equipment and personnel are present in the intersection on the mainline of a multi-lane roadway, the intersecting side roads shall be signed in advance with HWZ-2 signs. As soon as the work operation clears the intersection the signage may be removed.
 - d) Signage (Detail 150-HWZ-3) shall be posted at the end of the Highway Work Zone indicating the end of the zone and indicating that increased penalties for speeding violations are no longer in effect.
 - e) When a designated Highway Work Zone is no longer necessary all signs shall be removed immediately.
2. REDUCING THE SPEED LIMIT IN A HIGHWAY WORK ZONE:
Highway Work Zone signs shall be posted as required in Condition 1 above.

For limited access (interstate) highways and controlled access multi-lane divided highways the posted speed limit shall be reduced as required below.

Speed Limit signage (R2-1) for the reduced speed limit shall be erected at the beginning of the work zone. Additional signs shall be placed to ensure that the maximum spacing of the reduced speed limit signs shall be no greater than one (1) mile apart. Existing speed limit signs shall be covered or removed. On multi-lane divided highways the speed limit signs shall be double indicated when the reduced speed is in use.

When any one or more of the following conditions exist and the existing speed limit is 65 mph or 70 mph, the speed limit shall be reduced by 10 mph. If the existing speed limit is 60 mph, the speed limit should be reduced by 5 mph. If the existing speed limit is 55 mph or less, the Contractor can only reduce the speed limit with the prior approval of the Engineer. The reduction in the speed limit shall be no greater than 10 mph:

- a) Lane closure(s) of any type and any duration.
- b) The difference in elevation exceeds two inches adjacent to a travel lane as shown in Subsection 150.06, Detail 150-B, 150-C.
- c) Any areas where equipment or workers are within ten feet of a travel lane.
- d) Temporary portable concrete barriers located less than two (2') feet from the traveled way.
- e) As directed by the Engineer for conditions distinctive to this project.

When the above conditions are not present the speed limit shall be immediately returned to the existing posted speed limit. A speed reduction shall not be put in place for the entire length of the project unless conditions warranting the speed reduction are present for the entire project length. All existing speed limit signs within the temporary speed reduction zone shall be covered or removed while the temporary reduction in the speed limit is in effect. All signs shall be erected to comply with the minimum requirements of the MUTCD. As a minimum the following records shall be kept by the WTCS:

- a) Identify the need for the reduction.
- b) Record the time of the installation and removal of the temporary reduction.
- c) Fully describe the location and limits of the reduced speed zone.
- d) Document any accident that occurs during the time of the reduction.

A copy of the weekly records for reduced speed zones shall be submitted to the Engineer.

Reduced speed zones shall, as a minimum, be signed as per Detail 150-HWZ-1. Interim signs shall meet the requirements of Subsection 150.03.D. Additional signs may be necessary to adjust for actual field conditions. When a pilot vehicle is used on a two-lane two-way roadway the speed limit should not be reduced. For special conditions specific to the work, on two-lane two-way roadways or multi-lane highways, the contractor may reduce the posted speed limit with the prior approval of the Engineer.

5. Milled surface restrictions:

Unless modified by the special conditions, a milled surface on any asphaltic concrete surface shall not be allowed to remain open to traffic for a period of time that exceeds thirty (30) calendar days. Severely potholed milled surfaces that pose a damage threat to vehicular traffic must be repaired immediately by contractor to the satisfaction of the Engineer. Milled Surface signage shall be placed on roads where milling is not resurfaced within a 7 day period. All variable depth milling shall take place prior to deep patching where both line items occur within the same area.

6. Installation/Removal of work area signage:

No payment will be made for Traffic Control-Lump Sum until the Work has actually started on the project. The installation of traffic control signage does not qualify as the start of work. Advanced warning signs shall not be installed until the actual beginning of work activities. Any permanent mount height signs installed as the work is preparing to start shall be covered until all signs are installed unless all signs are installed within seven (7) calendar days after beginning installation.

All temporary traffic control devices shall be removed as soon as practical when these devices are no longer needed. When work is suspended for short periods of time, temporary traffic control devices that are no longer appropriate shall be removed or covered.

All construction warning signs shall be removed within seven (7) calendar days after time charges are stopped or pay items are complete. If traffic control devices are left in place for more than ten (10) calendar days after completion of the Work, the Department shall have the right to remove such devices, claim possession thereof, and deduct the cost of such removal from any monies due, or which may become due, the Contractor.

PUNCHLIST WORK: Portable signs shall be utilized to accomplish the completion of all punch list items. The portable signs shall be removed daily. All permanent mount height signs shall be removed prior to the beginning of the punch list work except "Low/Soft Shoulder" signs and any signs that have the prior written approval of the Engineer to remain in place while the punch list work is in progress.

Failure to promptly remove the construction warning signs within the seven (7) calendar days after the completion of the Work or failure to remove or cover signs when work is suspended for short periods of time shall be considered as non-performance under Subsection 150.08.

SPEED LIMIT REDUCTION FOR HIGHWAY WORK ZONE
 INTERSTATE AND MULTI-LANE DIVIDED HIGHWAY SIGNING SHALL BE
 DOUBLE INDICATED (RIGHT SHOULDER AND MEDIAN SHOULDER)

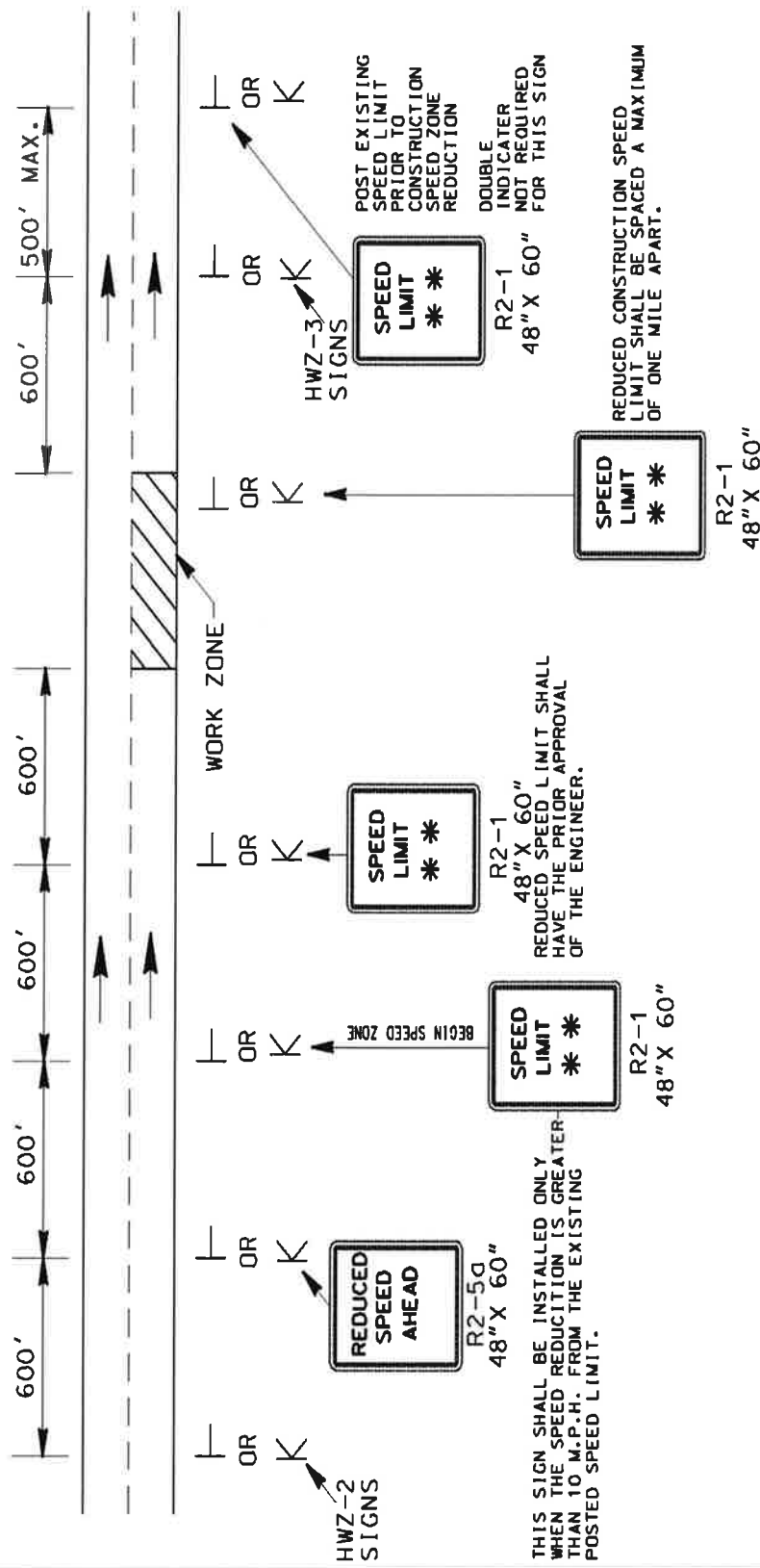

ALL INTERSECTING ROADWAYS SHALL BE SIGNED WITH A HWZ-2 SIGN TO WARN MOTORIST ENTERING THE HIGHWAY WORK ZONE.

INTERSTATE AND MULTI-LANE HIGHWAY SIGNING SHALL BE DOUBLE INDICATED (RIGHT SHOULDER AND MEDIAN SHOULDER).

SIGN SIZES SHOWN ARE FOR INTERSTATE AND MULTI-LANE DIVIDED HIGHWAY. FOR OTHER HIGHWAYS USE STANDARD SIZE SIGNS AS PER THE M.U.T.C.D. EXCEPT HWZ-2 AND HWZ-3 SIGNS.

DETAIL 150-HWZ-1

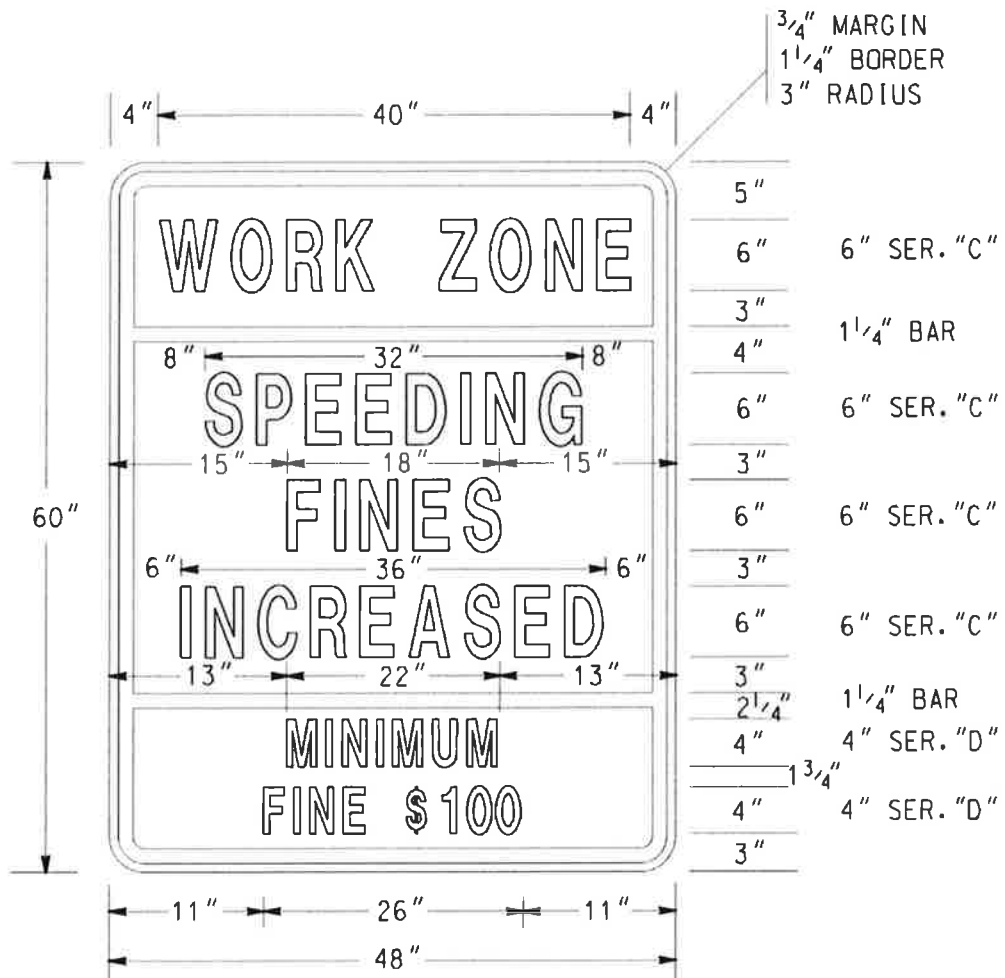

HWZ-2

COLORS

TOP PANEL

LEGEND & BORDER - BLACK (NON-REFL)

BACKGROUND - FLUORESENT ORANGE

(ASTM TYPE VII, VIII, IX or X)

MIDDLE & BOTTOM PANELS

LEGEND & BORDER - BLACK (NON-REFL)

BACKGROUND - WHITE (ASTM TYPE III OR IV REFL SHEETING)

NOTES:

1. ALL HWZ-2 SIGN PANELS SHALL BE RIGID.
2. THE SIZE OF THE HWZ-2 SIGN SHALL NOT BE REDUCED FOR USE ON TWO-LANE ROADWAYS.

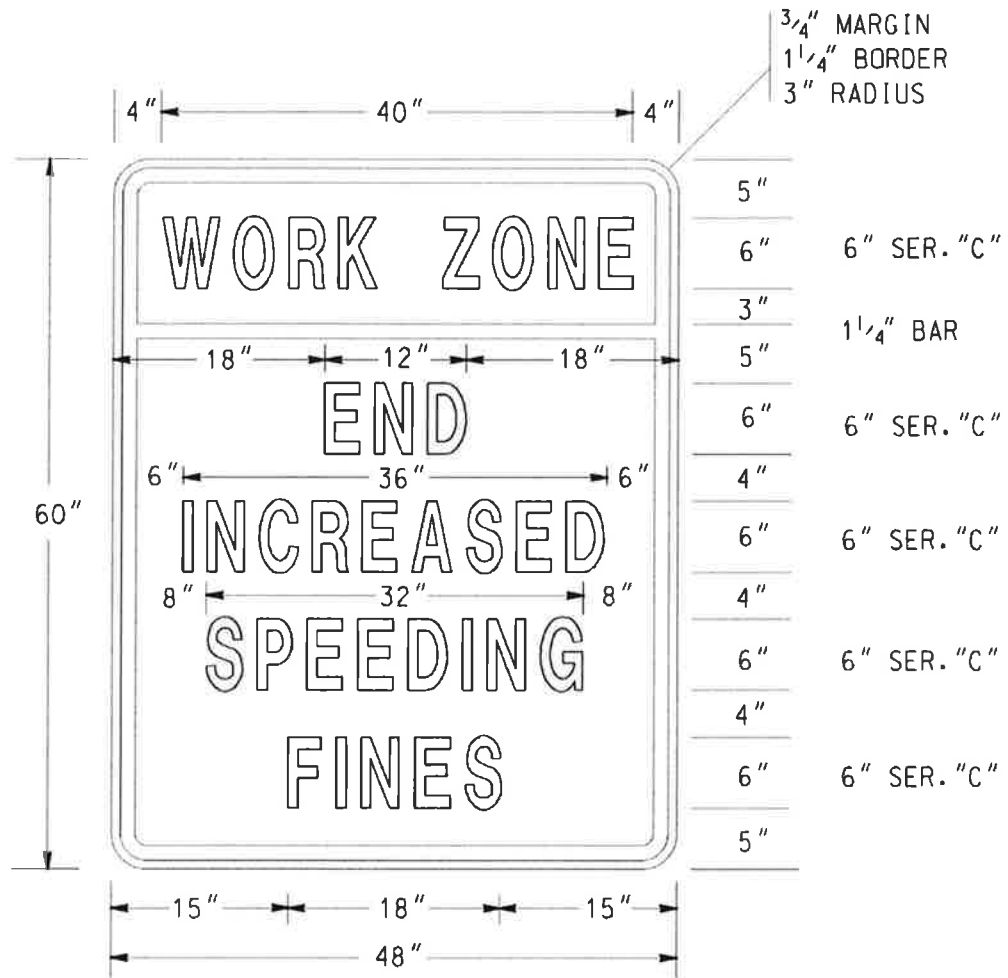

HWZ-3

COLORS

TOP PANEL

LEGEND & BORDER - BLACK (NON-REFL)

BACKGROUND - FLUORESENT ORANGE

(ASTM TYPE VII, VIII, IX or X)

BOTTOM PANEL

LEGEND & BORDER - BLACK (NON-REFL)

BACKGROUND - WHITE (ASTM TYPE III OR IV REFL SHEETING)

NOTES:

1. ALL HWZ-3 SIGN PANELS SHALL BE RIGID.
2. THE SIZE OF THE HWZ-3 SIGN SHALL NOT BE REDUCED FOR USE ON TWO-LANE ROADWAYS.

C. Lane closures

1. Approval/Restrictions

All lane closures of any type or duration shall have the prior approval of the Engineer.

- a. The length of a lane closure shall not exceed two (2) miles in length excluding the length of the tapers unless the prior approval of the Engineer has been obtained. The Engineer may extend the length of a lane closure based upon field conditions however the length of a work zone should be held to the minimum length required to accomplish the Work. Lane closures shall not be spaced closer than one mile. The advanced warning signs for the project should not overlap with the advanced warning signs for lane shifts, lane closures, etc.
- b. Lane closures that require same direction traffic to be split around the Work Area will not be approved for roadways with posted speeds of 35 mph or greater, excluding turn lanes.

2. Removal Of Lane Closures

To provide the greatest possible convenience to the public in accordance with Subsection 107.07, the Contractor shall remove all signs, lane closure markings, and devices immediately when lane closure work is completed or temporarily suspended for any length of time or as directed by the Engineer. All portable signs and portable sign mounting devices shall be removed from the roadway to an area which will not allow the sign to be visible and will not allow the sign or sign mounting device to be impacted by traffic.

3. Exit And Entrance Ramps

On multilane highways where traffic has been shifted to the inside lanes, the exit and entrance ramps shall have channelization devices placed on both sides of the ramp. The temporary ramp taper length shall be greater than, or equal to, the existing taper length. Interim EXIT gore signs shall be placed at the ramp divergence. The "EXIT OPEN" sign shown in Figure TA-42 of the MUTCD shall be utilized. Channelization device spacing shall be 10 feet for 200 feet in advance of the temporary gore, and 10 feet for the first 100 feet of the temporary gore.

4. Lane Drop/Lane Closure

The first seven (7) calendar days of any lane closure shall be signed and marked as per Standard 9106 or 9107. However, lane closures that exist for a duration longer than seven (7) calendar days may be signed and marked as per the details in Standard 9121, provided the prior approval of the Engineer is obtained. The approved lane drop shall utilize only the signs and markings shown for the termination end of the lane drop in Standard 9121. All warning signs in the lane drop sequence shall be used. Drums may be substituted for the Type I Crystal Delineators at the same spacing.

5. Termination Area

The transition to normal or full width highway at the end of a lane closure shall be a maximum of 150 feet.

D. Traffic pacing method

1. Pacing Of Traffic

With prior approval from the Engineer, traffic may be paced allowing the Contractor up to ten (10) minutes maximum to work in or above all lanes of traffic for the following purposes:

- a. Placing bridge members or other bridge work.
- b. Placing overhead sign structures.
- c. Other work items requiring interruption of traffic.

The Contractor shall provide a uniformed police officer with patrol vehicle and blue flashing light for each direction of pacing. The police officer, Engineer, and flaggers at ramps shall be provided with a radio which will provide continuous contact with the Contractor.

When ready to start the work activity, the police vehicle will act as a pilot vehicle slowing the traffic thereby providing a gap in traffic allowing the Contractor to perform the Work. Any on-ramps between the pace and the work area shall be blocked during pacing of traffic, with a flagger properly dressed and equipped with a Stop/Slow paddle. Each ramp should be opened after the police vehicle has passed.

Pilot vehicles shall travel at a safe pace speed, desirably not less than 20 mph interstate and 10 mph non-interstate. The Contractor shall provide a vehicle to proceed in front of the police vehicle and behind the other traffic in order to inform the Contractor's work force when all vehicles have cleared the area.

Traffic will not be permitted to stop during pacing except in extreme cases as approved by the Engineer.

2. Methods Of Signing For Traffic Pacing

At a point not less than 1,000 feet in advance of the beginning point of the pace, the Contractor shall erect and cover a W-special sign (72 inch x 72 inch) with a Type "B" flashing light, with the legend "TRAFFIC SLOWED AHEAD SHORT DELAY" (See Detail 150-A). A portable changeable message sign may be used in lieu of the W-special sign. On divided highways this sign shall be double indicated. A worker with a two-way radio shall be posted at the sign, and upon notice that the traffic is to be paced shall turn on the flashing light and reveal the sign. When traffic is not being paced, the flashing light shall be turned off and the sign covered or removed. W-special signs are reflectorized black on orange, Series "C" letter and border of the size specified.

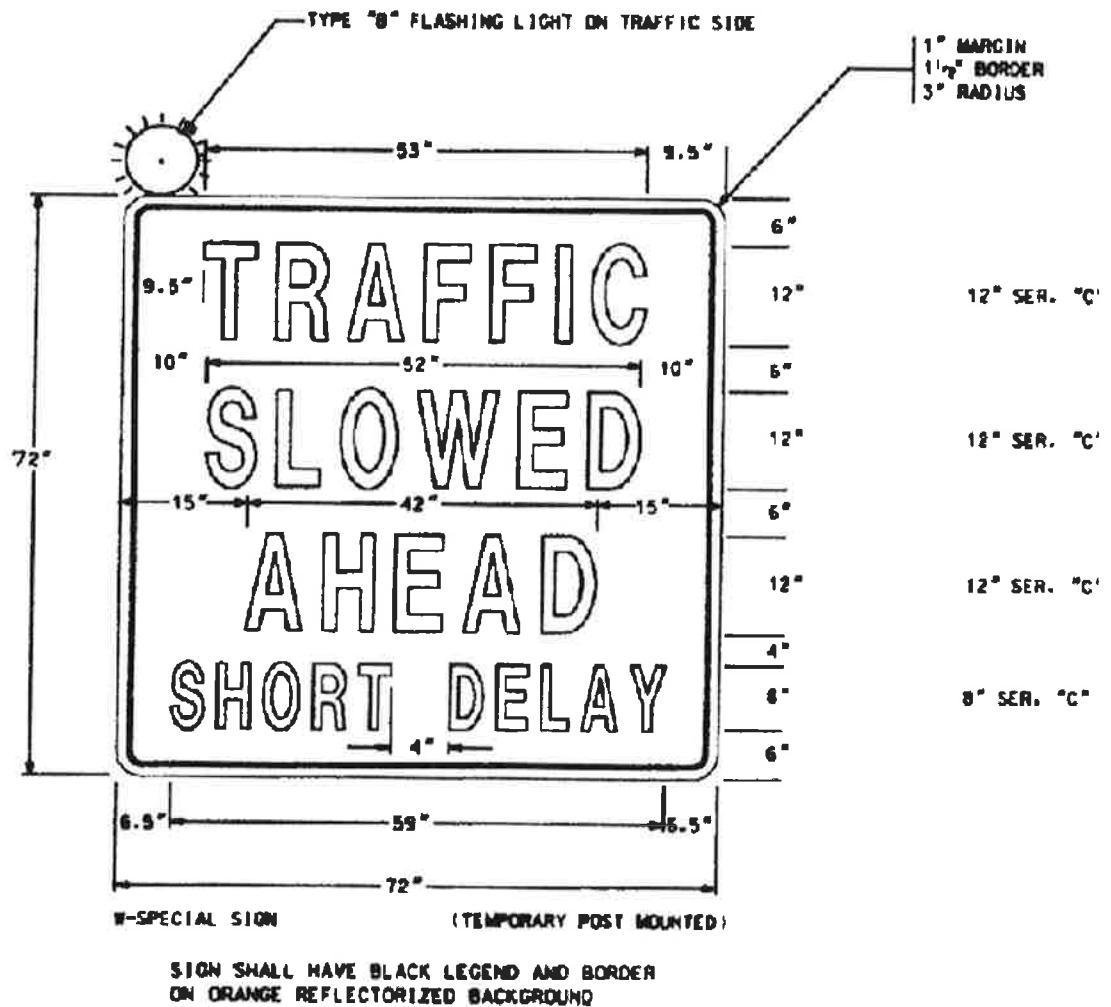

DETAIL 150-A

E. Construction vehicle traffic

The Contractor's vehicles shall travel in the direction of normal roadway traffic and shall not reverse direction except at intersections, interchanges, or approved temporary crossings. The Contractor may submit a plan requesting that construction traffic be allowed to travel in the opposite direction of normal traffic when it would be desirable to modify traffic patterns to accommodate specific construction activities.

Prior approval of the Engineer shall be obtained before any construction traffic is allowed to travel in a reverse direction. If the Contractor's submittal is approved the construction traffic shall be separated from normal traffic by appropriate traffic control devices.

F. Environmental impacts to the traffic control plan

The Contractor shall ensure that dust, mud, and other debris from construction activities do not interfere with normal traffic operations or adjacent properties. All outfall ditches, special ditches, critical storm drain structures, erosion control structures, retention basins, etc. shall be constructed, where possible, prior to the beginning of grading operations so that the best possible drainage and erosion control will be in effect during the grading operations, thereby keeping the roadway areas as dry as possible.

Areas within the limits of the project which are determined by the Engineer to be disturbed or damaged due either directly or indirectly from the progress or the lack of progress of the work shall be cleaned up, redressed, and regrassed. All surplus materials shall be removed and disposed of as required. Surplus materials shall be disposed of in accordance with Subsection 201.02.E.3 of the Specifications.

G. Existing street lights

Existing street lighting shall remain lighted as long as practical and until removal is approved by the Engineer.

H. Night work

Adequate temporary lighting shall be provided at all nighttime work sites where workers will be immediately adjacent to traffic. For their own protection, workers in or adjacent to traffic during nighttime operation shall wear reflectorized vests that meet the requirements of the MUTCD.

I. Construction vehicles in the work zone

The parking of Contractor's and/or workers personal vehicles within the work area or adjacent to traffic is prohibited. It shall be the responsibility of the Worksite Traffic Control Supervisor to ensure that any vehicle present at the worksite is necessary for the completion of the work.

J. Encroachments on the traveled-way

The Worksite Traffic Control Supervisor (WTCS) shall monitor the work to ensure that all the rocks, boulders, construction debris, stockpiled materials, equipment, tools and other potential hazards are kept clear of the travel way. These items shall be stored in a location, in so far as practical, where they will not be subject to a vehicle running off the road and striking them.

K. Pedestrian access to the work

All existing pedestrian walkways shall be maintained. Whenever changes to the worksite necessitate changes to existing walkways, temporary walkways shall be provided and maintained, with appropriate signs as necessary, to allow safe passage of pedestrian traffic.

L. Traffic Signals

If the sequence of operations, staging, or the traffic control plan requires the relocation or shifting of any components of an existing traffic signal system then any work on these traffic signals will be considered as part of Lump Sum- Traffic Control. The contractor becomes responsible for the maintenance of these traffic signals from the time that the system is modified until final acceptance. The maintenance of traffic signals that are not a part of the work and are not in conflict with any portion of the work shall not be the responsibility of the contractor.

When construction operations necessitate an existing traffic signal to be out of service, the Contractor shall furnish off-duty police officers to regulate and maintain traffic control at the site.

M. Removal/Reinstallation of miscellaneous items

In the prosecution of the Work, if it becomes necessary to remove any existing signs, markers, guardrail, etc. not covered by specific pay item, they shall be removed, stored and reinstalled, when directed by the Engineer, to line and grade, and in the same condition as when removed.

150.03 Signs

A. Signing requirements of the traffic control plan

When existing regulatory, warning or guide signs are required for proper traffic control the Contractor shall maintain these signs in accordance with the traffic control plan. The Contractor shall review the status of all existing signs, interim signs added to the work, and permanent sign installations that are part of the work to eliminate any conflicting or non-applicable signage in the Traffic Control Plan. The Contractor's review of all signs in the Traffic Control Plan shall establish compliance with the requirements of the most recent version of the MUTCD and Section 150. Any conflicts shall be

reported to the Engineer immediately and the WTCS shall take the necessary measures to eliminate the conflict.

The Contractor shall make every effort to eliminate the use of interim signs as soon as the Work allows for the installation of permanent signs.

All existing illuminated signs shall remain lighted and be maintained by the Contractor.

Existing street name signs shall be maintained at street intersections.

B. Conflicting or non-applicable signs

Any sign(s) or portions of a sign(s) that are not applicable to the traffic control plan shall be covered so as not to be visible to traffic or shall be removed from the roadway when not in use. The WTCS shall review all traffic shifts and changes in the traffic patterns to ensure that all conflicting signs have been removed. The review shall confirm that the highest priority signs have been installed and that signs of lesser significance are not interfering with the visibility of the high priority signs. High priority signs include signs for road closures, shifts, detours, lane closures and curves. Any signs, such as speed zones and speed limits, passing zones, littering fines and litter pick up, that reference activities that are not applicable due to the presence of the Work shall be removed, stored and reinstalled when the Work is completed.

Failure to promptly eliminate conflicting or non-applicable signs shall be considered as non-performance under Subsection 150.08.

C. Removal of existing signs and supports

The Contractor shall not remove any existing signs and supports without prior approval from the Engineer. All existing signs and supports which are to be removed shall be stored and protected if this material will be required later in the work as part of the traffic control plan. If the signs are not to be utilized in the work then the signs will become the property of the Contractor unless otherwise specified in the contract documents.

D. Interim guide, warning and regulatory signs

Interim guide, warning, or regulatory signs required to direct traffic shall be furnished, installed, reused, and maintained by the Contractor in accordance with the MUTCD, the Plans, Special Provisions, Special Conditions, or as directed by the Engineer. These signs shall remain the property of the Contractor. The bottom of all interim signs shall be mounted at least seven (7') feet above the level of the pavement edge when the signs are used for long-term stationary operations as defined by Section 6G.02 of the most recent version of the MUTCD. Special Conditions under Subsection 150.11 may modify this requirement.

Portable signs may be used when the duration of the work is less than three (3) days or as allowed by the special conditions in Subsection 150.11. Portable signs shall be used for all punch list work. All portable signs and sign mounting devices utilized in work shall be NCHRP 350 compliant. Portable interim signs shall be mounted a minimum of one (1') foot above the level of the pavement edge for directional traffic of two (2) lanes or less and a minimum of seven (7') feet for directional traffic of three (3) or more lanes. Signs shall be mounted at the height recommended by the manufacturer's crashworthy testing requirements. Portable interim signs which are mounted at less than seven (7') feet in height may have two 18 inch x 18 inch fluorescent red-orange or orange-red warning flags mounted on each sign.

All regulatory sign blanks shall be rigid whether the sign is mounted as a portable sign, on a Type III barricade or as a permanent mount height sign.

Any permanent mount height interim sign that is designed to fold in half to cover a non-applicable message on the sign shall have reflectorized material on the folded over portion of the sign. The reflectorized material shall be orange in color with a minimum of ASTM Type I engineering grade

sheeting with a minimum area of six inches by six inches (6" x 6") facing the direction of traffic at all times when the sign is folded.

Interim signs may be either English or metric dimensions.

E. Existing special guide signs

Existing special guide signs on the Project shall be maintained until conditions require a change in location or legend content. When change is required, existing signs shall be modified and continued in use if the required modification can be made within existing sign borders using design requirements (legend, letter size, spacing, border, etc.) equal to that of the existing signs, or of Sub-Section 150.03.E.2. Differing legend designs shall not be mixed in the same sign.

1. Special Guide Signs

Special guide signs are those expressway or freeway guide signs that are designed with a message content (legend) that applies to a particular roadway location. When an existing special guide sign is in conflict with work to be performed, the Contractor shall remove the conflicting sign and reset it in a new, non-conflicting location which has been approved by the Engineer.

2. Interim Special Guide Signs

When it is not possible to utilize existing signs, either in place or relocated, the Contractor shall furnish, erect, maintain, modify, relocate, and remove new interim special guide signs in accordance with the Plans or as directed by the Engineer. Interim special guide signs that may be required in addition to, or a replacement for, existing expressway and freeway (interstate) signs shall be designed and fabricated in compliance with the minimum requirements for guide signing contained in Part 2E "Guide Signs Expressway" and Part 2F "Guide Signs Freeways" of the MUTCD, except that the minimum size of all letters and numerals in the names and places, streets and highways on all signs shall be 16 inches Series "E" initial upper-case and 12 inches lower-case. All interstate shields on these signs shall be 48 inches and 60 inches for two-numeral and three-numeral routes, respectively.

The road name of the exit or route shield shall be placed on the exit gore sign.

3. Interim Overhead Guide Sign Structures

Interim overhead special guide sign structures are not required to be lighted unless specifically required by the Plans. If lighting is required the sign shall be lighted as soon as erected and shall remain lighted, during the hours of darkness, until the interim sign is no longer required. The Contractor shall notify the Power Company at least thirty (30) days prior to desired connection to the power source.

4. Permanent Special Guide Signs

The installation of new permanent special guide signs and the permanent modification or resetting of existing special guide signs, when included in the contract, shall be accomplished as soon as practical to minimize the use of interim special guide signs. If lighting is required by the Plans, all new permanent overhead special guide signs shall be lighted as soon as erected.

F. Materials-Interim signs

1. Posts

Permanent mounting height of seven (7') feet- Posts for all interim signs shall meet the requirements of Section 911 except that green or silver paint may be used in lieu of galvanization for steel posts or structural shape posts. Within the limits of a single project, all metal posts shall be the same color. Wood posts are not required to be pressure treated.

Interim posts may be either metric or English in dimensions.

Posts for all interim signs shall be constructed to yield upon impact unless the posts are protected by guardrail, portable barrier, impact attenuator or other type of positive barrier protection.

Unprotected posts shall meet the breakaway requirements of the "1994 AASHTO Standard Specifications for Structural Support for Highway Signs, Luminaries and Traffic Signals". Unprotected interim posts shall be spliced as shown in Detail 150-F unless full length unspliced posts are used.

Unprotected post splices will not be permitted any higher than four inches above the ground line to lessen the possibility of affecting the undercarriage of a vehicle. Installation of posts may require establishment of openings in existing pavements, islands, shoulders etc.

2. Sign Blanks And Panels- Permanent mounting height of seven (7') feet-

All sign blanks and panels shall conform to Section 912 of the Specifications except that blanks and panels may be ferrous based or other metal alloys. Type 1 and Type 2 sign blanks shall have a minimum thickness of 0.08 inches regardless of the sign type used. Alternative sign blank materials (composites, poly carbonates, fiberglass reinforced plastics, recycled plastics, etc.) shall have a letter of approval from the Office of Materials and Research for use as interim construction signs before these materials are allowed to be incorporated into the work unless these rigid sign blanks are currently approved as a crashworthy sign blank material under QPL 34. The back side of sign panels shall be painted orange to prevent rust if other metals are used in lieu of aluminum. Plywood blanks or panels will not be permitted. The use of flexible signs will not be permitted for permanent mount height signs.

Interim blanks and panels may be either metric or English in dimensions.

3. Portable Sign Mounting Devices, Portable Sign Blanks-

All portable sign mounting devices and sign blanks utilized in the work shall be NCHRP 350 Test Level III compliant. All portable sign mounting devices and sign blanks shall be from the Qualified Products List. Any sign or sign mounting device shall have an identifying decal, logo, or manufacturer's stamping that clearly identifies the device as NCHRP 350 compliant. The Contractor may be required to provide certification from the Manufacturer as proof of NCHRP 350 compliance. All portable signs shall be mounted according to height requirements of Subsection 150.03.D.

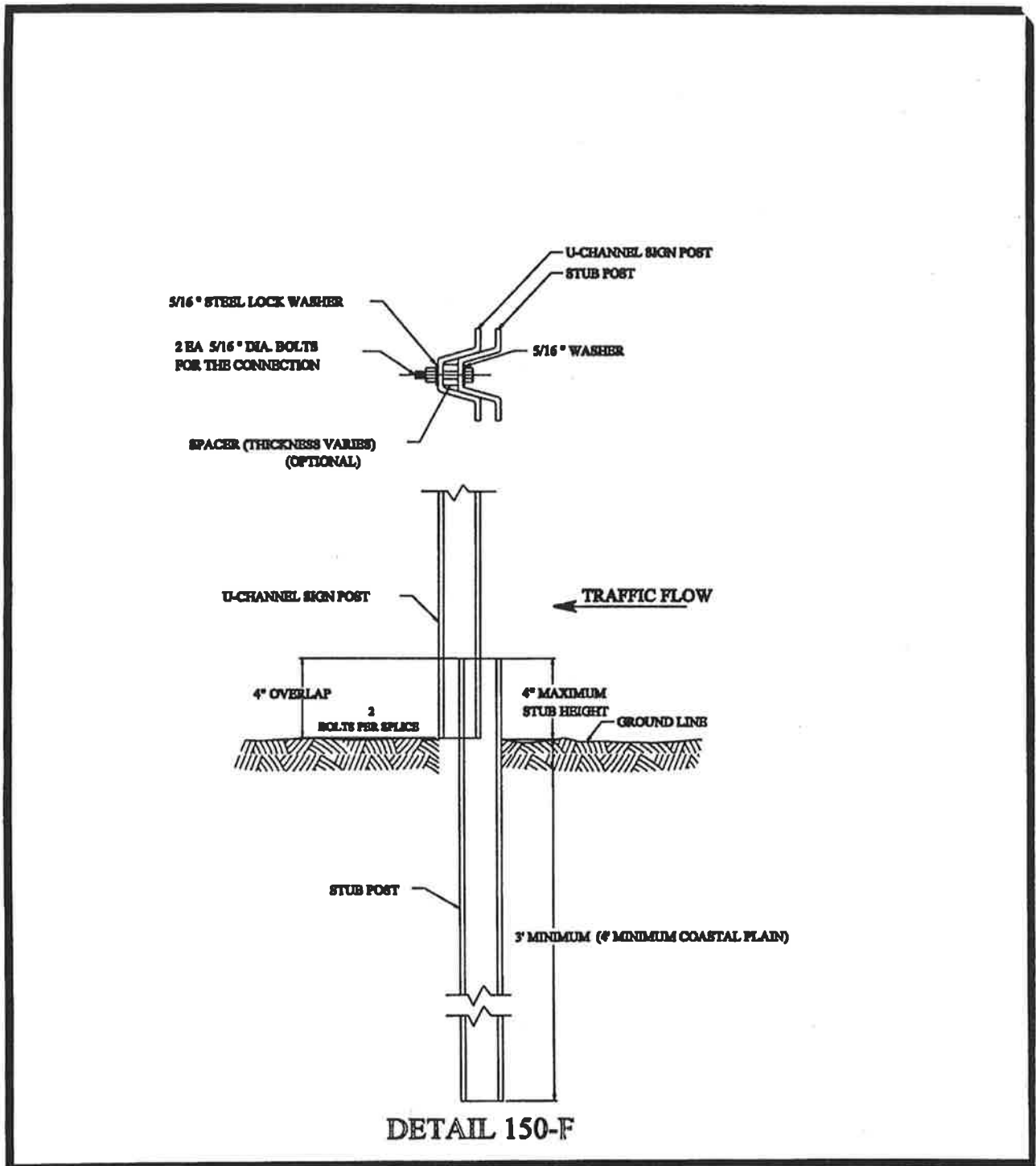

G. Sign visibility and offsets

All existing, interim and new permanent signs shall be installed so as to be completely visible for an advance distance in compliance with the MUTCD. Any clearing required for maintaining the line of sight to existing, interim or permanent signs shall be done as part of the requirements of the traffic control plan. The clearing shall include any advance warning signs, both interim and permanent, that are installed as a part of the work including advance warning signs that are installed outside the limits of the project. Any sign installed behind W-beam or T-beam guardrail with non-breakaway posts shall

be installed with the leading edge of the sign a minimum of four feet and three inches (4'3") behind the face of the guardrail with five feet (5') of clearance being desirable. Limbs, brush, construction equipment and materials shall be kept clear of the driver's line of sight to all signs that are part of the traffic control plan.

H. Advance warning signs

1. All Type Of Highways

Advance warning signs shall be placed ahead of the work area in accordance with Part VI of the most recent version of the MUTCD and shall include a series of at least three advance road work (W20-1) signs placed at the termini of the project. The series shall have the legend ROAD WORK (1500 FEET, 1000 FEET, AND 500 FEET).

At grade intersecting roadways and on-ramps shall be signed with a minimum of one ROAD WORK AHEAD sign.

When work terminates at a "T" intersection, a minimum of one "ROAD WORK AHEAD" sign shall be placed in advance of the intersection and one "END ROAD WORK" sign shall be placed at the termination end of the intersection. Field conditions may require the use of additional warning signage.

Advanced Warning Signs on State Routes shall be a minimum dimension of 48 inches x 48 inches. When a State Route intersects a project which consists of adding travel lanes, reconstructing an existing roadway or new location work, the State Route approaches shall have a minimum of three (W20-1) advanced warning signs (1500 ft., 1000 ft., 500 ft.). The termination end of an intersecting State Route shall have END ROAD WORK signage.

The W20-1 signs shall be placed at the termini of the project or sufficiently in advance of the termini to allow for lane shifts, lane closures and other activities which may also require advanced warning signs. The advanced warning signs for the project should not overlap with the advanced warning signs for lane shifts, lane closures, etc.

The length of a work zone should be held to the minimum length required to accomplish the work. If a project has multiple individual worksites within the overall limits of the project, each site should be signed individually if the advance warning signs for each site can be installed without overlapping an adjacent worksite. As soon as the work is completed at any individual site the warning signs shall be removed from that site. Clean-up work and punch list work shall be performed with portable signage.

Project mileage indicated on the G20-1 sign shall be the actual project mileage rounded up to the nearest whole mile. Projects less than two (2) miles in length or individual worksites that are part of a multiple worksite project may delete this sign. The G20-1 sign shall be 60" X 36" and the G20-2 sign shall be 48" X 24".

2. Interstate, Limited Access And Multilane Divided Highways

In addition to the W20-1 signs required at 500 ft., 1000 ft. and 1500 ft., multi-lane divided highways shall also have additional advanced warning signs installed with the legend "ROAD WORK (2 MILES, 1 MILE and 1/2 MILE). All construction warning signs on divided highways shall be double indicated (i.e., on the left and right sides of the roadway.) If the use of the ½ mile, 1 mile and 2 mile advanced warning signs cause an overlap with other work or do not benefit field conditions then the Engineer may review the use of these signs and eliminate their installation. When the posted speed limit is 50 MPH or less, the ½ mile, 1 mile and 2 mile signs should be eliminated especially in urban areas.

The W20-1 advance warning signs for ROAD WORK 500 FEET; 1000 FEET; and 1500 FEET shall be temporarily covered when work involving the advanced warning signs for lane shifts and

lane closures overlap these signs. The ROAD WORK ½ MILE, ROAD WORK 1 MILE, and ROAD WORK 2 MILES shall be in place when the 500, 1000 and 1500 foot signs are temporarily covered.

When the temporary traffic control zone already has advanced warning (W20-1) signs installed the W20-1 signs required for lane closures under Standard 9106 should be eliminated.

RAMP WORK ON LIMITED ACCESS HIGHWAYS: The work zone shall not be signed for the entire length of the mainline of a limited access highway when only short individual worksites, interchange or ramp work is being performed.

When work is restricted to ramp reconstruction or widening activities, the advance warning signs on the mainline section of the limited access highway shall be limited to the use of portable advance warning signs. These portable advance warning signs shall only be utilized when work activity is within the gore point of the ramp and the mainline traveled way or work is active in the acceleration/deceleration lane adjacent to the mainline traveled way. Portable advance warning signs (W20-1; 1500 ft./1000 ft./500ft.) shall be installed on the traveled way of the limited access highway when the above conditions are present. The advance warning signs shall be installed only in one direction where work is active. All portable signs shall be double indicated. When work is not active, the ramp work shall be advanced warned by the use of a single 48 inch X 48 inch "RAMP WORK AHEAD" sign along the right shoulder of the mainline traveled way prior to the beginning of the taper for the deceleration lane. The "RAMP WORK AHEAD" sign shall be mounted at seven (7') feet in height. Differences in elevation shall be in compliance with the requirements of Subsection 150.06 prior to the removal of the portable (W20-1) advanced warning signs from the mainline.

The G20-1 sign shall be eliminated on limited access highways when the work involves only ramp work, bridge reconstruction, bridge painting, bridge joint repairs, guardrail and anchor replacement or other site specific work which is confined to a short section of limited access highway.

I. Portable changeable message sign

Unless specified as a paid item in the contract the use of a portable changeable message sign will not be required. When specified, a portable changeable message sign (PCMS) shall meet the minimum requirements of Section 632 and the most recent version of the MUTCD. The maximum amount of messages allowed to be flashed on one PCMS is two phases (flashes). The language and the timing of the messages shall comply with the MUTCD and Section 632. When used as an advanced device the PCMS should typically be placed ahead of the construction activities. If the PCMS is used as a substitute for another device then the requirements for the other device apply.

J. Flashing Beacon

The flashing beacon assembly, when specified, shall be used in conjunction with construction warning signs, regulatory, or guide signs to inform traffic of special road conditions which require additional driver attention. The flashing beacon assembly shall be installed in accordance with the requirements of Section 647.

K. Rumble strip signage

Signage for rumble strips located in the travel way shall be as required in Subsection 150.01.C and Subsection 150.02.A.9.

L. Low/soft shoulder signage

Low or soft shoulder signs shall be utilized in accordance with the following conditions:

CONSTRUCTION/RECONSTRUCTION PROJECTS:

“LOW/SOFT SHOULDER” signs shall be erected when a difference in elevation exceeds one (1”) inch but does not exceed three (3”) inches between the travel way and any type of shoulder unless the difference in elevation is four (4’) feet or greater from the edge of the traveled way.

The spacing of the signs shall not exceed one (1) mile and the signs shall be placed immediately past each crossroad intersection. The “Low/Soft” signs shall remain in place until the difference in elevation is eliminated and the shoulder has been dressed and permanently grassed for a minimum of thirty (30) calendar days. These signs shall be furnished, installed, maintained and removed by the Contractor as part of Traffic Control-Lump Sum. These signs shall be orange with black borders and meet the reflectorization requirements of Subsection 150.01.C.

“SHOULDER DROP-OFF” (W8-9a) signs shall be used when a difference in elevation, less than four (4’) feet from the traveled way, exceeds three (3”) inches and is not protected by positive barrier protection. These warning signs shall be placed in advance of the drop-off. For a continuous drop-off condition, the W8-9a) signs shall, as a minimum, be spaced in accordance with the above requirements for “Low/soft shoulder” signs.

PROJECTS CONSISTING PRIMARILY OF ASPHALTIC CONCRETE RESURFACING ITEMS:

“LOW/SOFT SHOULDER” signs shall be erected when a difference in elevation exceeds one (1”) inch but does not exceed three (3”) inches between the travel way and any type of shoulder unless the difference in elevation is four (4’) feet or greater from the edge of the traveled way.

SHOULDER BUILDING INCLUDED IN THE CONTRACT: “Low/Soft Shoulder” signs shall be erected as per the requirement of Standards 9102, 9106, and 9107. “Shoulder Drop-off” signs (W8-9a) shall be erected as per the requirements of the most recent version of the MUTCD. These signs shall be maintained until the conditions requiring their installation have been eliminated. The Contractor shall remove all interim warning signs before final acceptance.

SHOULDER BUILDING NOT INCLUDED IN THE CONTRACT: The Department will furnish the “Low/Soft Shoulder” signs, “Shoulder Drop-off” signs and the posts. The signs shall be erected to meet the minimum requirements of Subsection 150.03. The Contractor shall include the cost of furnishing installation hardware (bolts, nuts, and washers), erection and maintenance of the signs in the bid price for Traffic Control- Lump Sum. The Contractor shall maintain the signs until final acceptance. The Department will remove the signs.

LAU/LAR PROJECTS SHOULDER BUILDING NOT INCLUDED IN THE CONTRACT: The Contractor will furnish, install and maintain LOW/SOFT SHOULDER signs (yellow with black borders, ASTM Type III or IV) at the appropriate spacing, until Final Acceptance of the project by the Department. After Final Acceptance by the Department the signs will become the property and responsibility of the local government.

M. Bump signage

MULTI-LANE DIVIDED HIGHWAYS: A bump sign (W8-1) shall be utilized when a transverse joint in the pavement structure has a vertical difference in elevation of three quarters (3/4”) of an inch or greater in depth with no horizontal taper to ramp the traffic from one elevation to the other. This condition typically occurs at approach slabs during pavement milling operations and at transverse joints in asphaltic pavement lifts.

TWO-LANE TWO-WAY HIGHWAYS: A bump sign (W8-1) shall be utilized when a transverse joint in the pavement structure has a vertical difference in elevation that exceeds one and three quarters (1-3/4”) inches in depth with no horizontal taper to ramp the traffic from one elevation to the other. This includes utility and storm drainage repairs that require concrete placement for patching and/or steel plating.

The (W8-1) sign shall be placed sufficiently in advance to warn the motorist of the condition.

150.04 Pavement Markings

A. General

Full pattern pavement markings in accordance with Section 652 and in conformance with Section 3A and 3B, except 3B.02, of the MUTCD are required on all courses before the roadway is opened to traffic. No passing zones shall be marked to conform to Subsection 150.04.E. During construction and maintenance activities on all highways open to traffic, both existing markings and markings applied under this Section shall be fully maintained until Final Acceptance. If the pavement markings are, or become, unsatisfactory in the judgment of the Engineer due to wear, weathering, or construction activities, they shall be restored immediately.

1. Resurfacing Projects

Pavement markings shall be provided on all surfaces that are placed over existing markings. Interim and final markings shall conform in type and location to the markings that existed prior to resurfacing unless changes or additions are noted in the Contract. The replacement of parking spaces will not be required unless a specific item or note has been included in the Contract. Any work to make additions to the markings that existed prior to resurfacing is to be considered as extra work.

2. Widening And Reconstruction Projects

If the lane configuration is altered from the preconstruction layout then pavement markings will be as required by the plans or the Engineer.

3. New Location Construction Projects

Pavement marking plans will be provided.

B. Materials

All traffic striping applied under this Section shall be a minimum four inches in width or as shown in plans and shall conform to the requirements of Section 652, except as modified herein. Raised pavement markers (RPMs) shall meet the requirements of Section 654. Markings on the final surface course, which must be removed, shall be a removable type. The Contractor will be permitted to use paint, thermoplastic, or tape on pavement which is to be overlaid as part of the project, unless otherwise directed by the Engineer. Partial (skip) reflectorization (i.e. reflectorizing only a portion of a stripe) will not be allowed.

C. Installation and removal of pavement markings

INSTALLATION: All pavement markings, both interim and permanent, shall be applied to a clean surface. The Contractor shall furnish the layout and preline the roadway surface for the placement of pavement markings applied as part of the traffic control plan. All interim marking tape and RPM's on the final surface shall be removed prior to the placement of the final markings.

The Contractor shall sequence the work in such a manner as to allow the installation of markings in the final lane configuration at the earliest possible stage of the work.

REMOVAL: Markings no longer applicable shall be removed in accordance with Subsection 656.2.

THE ELIMINATION OF CONFLICTING PAVEMENT MARKINGS BY OVERPAINTING WITH PAINT OR LIQUID ASPHALT IS NOT ACCEPTABLE.

INTERMEDIATE SURFACE: Interim markings shall be removed by methods that will cause minimal damage to the pavement surface while also ensuring that traveling public will not be confused or misdirected by any residual markings remaining on the intermediate surface. The use of approved black-out tape and black-out paint may be permitted on some interim surfaces, provided the results are satisfactory to the Engineer.

FINAL SURFACE: No interim paint or thermoplastic markings will be permitted on any final surface unless the interim markings are in alignment with the location of the permanent markings and the interim marking will not interfere or adversely affect placement of the permanent markings. The proposed method of removal for layout errors that require markings to be removed from the final surface shall have the prior approval of the Engineer. Any damage to the final pavement surface caused by the pavement marking removal process shall be repaired at the Contractor's expense by methods acceptable and approved by the Engineer. Subsection 400.3.06.C shall apply when corrective measures are required. The use of black-out tape or black-out paint will not be permitted to correct layout errors on any final surface.

Traffic shifts that are done on the final surface shall be accomplished using interim traffic marking tape that can be removed without any blemishing of the final surface. Interim traffic marking tape shall be used on any of the following final surfaces; asphaltic concrete, Portland cement concrete, and bridge deck surfaces. Exceptions to the requirements for interim traffic marking tape shall have the written prior approval of the Engineer before the application of any other method is permitted.

PAY FACTOR REDUCTION FOR ASPHALTIC CONCRETE FINAL SURFACES: When the correction of an error in the layout of the final pavement markings requires the final surface to be grounded, blemished, scarred, or polished the pay factor shall be reduced to 0.95 for the entire surface area of the final topping that has a blemish, polished or a scarred surface. The reduced pay factor shall not be confined to only the width and length of the stripe or the dimensions of the blemished areas, the whole roadway surface shall have the reduced pay factor applied. The area of the reduced pay factor shall be determined by the total length and the total width of the roadway affected. If the affected area is not corrected, the reduction in pay shall be deducted from the final payment for the topping layer of asphaltic concrete. The Engineer shall make the final determination whether correction or a reduced pay factor is acceptable.

The eradication of pavement markings on intermediate and final concrete surfaces shall be accomplished by a method that does not grind, polish, or blemish the surface of the concrete. The method used for the removal of the interim markings shall not chip the joints in the concrete and shall not damage the sealant in the joints. Any joint or sealant repairs shall be included in the bid price for Traffic Control-Lump Sum. The proposed method of removal shall have the prior approval of the Engineer.

Failure to promptly remove conflicting or non-applicable pavement markings shall be considered as non-performance under Subsection 150.08.

PREPARATION AND PLANNING FOR TRAFFIC SHIFTS: When shifting of traffic necessitates removal of centerline, lane lines, or edge lines, all such lines shall be removed prior to, during, or immediately after any change so as to present the least interference with traffic. Interim traffic marking tape shall be used as a temporary substitute for the traffic markings being removed.

Before any change in traffic lane(s) alignment, marking removal equipment shall be present on the project for immediate use. If marking removal equipment failures occur, the equipment shall be repaired or replaced (including leasing equipment if necessary), so that the removal can be accomplished without delay.

Except for the final surface, markings on asphaltic concrete may be obliterated by an overlay course, when approved by the Engineer. When an asphaltic concrete overlay is placed for the sole purpose of eliminating conflicting markings and the in place asphaltic concrete section will allow, said overlay will be eligible for payment only if designated in the Plans. Overlays to obliterate lines will be paid for only once and further traffic shifts in the same area shall be accomplished with removable markings. Only the minimum asphaltic concrete thickness required to cover lines will be allowed. Excessive build-up will not be permitted. When an overlay for the sole purpose of eliminating conflicting

markings is not allowed, the markings no longer applicable shall be removed in accordance with Subsection 656.2.

D. Raised pavement markers

Raised pavement markers (RPMs) are required as listed below for all asphaltic concrete pavements before the roadway is open to traffic. On the final surface, RPM's shall be placed according to the timeframes specified in Subsection 150.04 E. for full pattern pavement markings except Interstate Highways where RPM's shall be placed and/or maintained when the roadway is open to traffic. When Portland Cement Concrete is an intermediate or final surface and is open to traffic, one calendar day is allowed for cleaning and drying before the installation of RPMs is required.

Raised pavement markers are not allowed on the right edge lines under any situation.

1. Interstate Highways

Retro-reflective raised pavement markers (RPM's) shall be placed and/or maintained on intermediate pavement surfaces on all interstate highways that are open to traffic. This includes all resurfacing projects along with widening and reconstruction projects. The spacing and placement shall be as required for MULTI-LANE DIVIDED HIGHWAYS.

2. Multi-Lane Divided Highways

Retro-reflective raised pavement markers (RPMs) shall be placed and/or maintained on intermediate pavement surfaces on all multi-lane divided highways that are opened to traffic when these roadways are being widened or reconstructed. Two lane-two way roadways that are being widened to a multi-lane facility, whether divided or undivided, are included in this provision. Projects consisting primarily of asphalt resurfacing items or shoulder widening items are excluded from this requirement. The RPMs shall be placed as follows:

a. SUPPLEMENTING LANE LINES

80 foot center on skip lines with curvature less than three degrees. (Includes tangents)

40 foot centers on solid lines and all lines with curvature between three degrees and six degrees.

20 foot centers on curves over six degrees.

20 foot centers on lane transitions or shifts.

b. SUPPLEMENTING RAMP GORE LINES

20 foot centers, two each, placed side by side.

c. OTHER LINES

As shown on the plans or directed by the Engineer.

3. Other Highways

On other highways under construction RPMs shall be used and/or maintained on intermediate pavement surfaces as follows:

a. SUPPLEMENTING LANE LINES AND SOLID LINES

40 foot centers except on lane shifts. (When required in the Plans or Contract.)

20 foot centers on lane shifts. (Required in all cases.)

b. SUPPLEMENTING DOUBLE SOLID LINES

40 foot centers (one each beside each line) except on lane shifts. (When required in the Plans or Contract.)

20 foot centers on lane shifts. (Required in all cases.)

E. Exceptions for interim markings

Some exceptions to the time of placement and pattern of markings are permitted as noted below, however, full pattern pavement markings are required for the completed project.

1. Two-Lane, Two-Way Roadways

a. SKIP LINES

All interim skip (broken) stripe shall conform to Section 652 except that stripes shall be at least two feet long with a maximum gap of 38 feet. On curves greater than six degrees, a one-foot stripe with a maximum gap of 19 feet shall be used. In lane shift areas solid lines will be required. Interim skip lines shall be replaced with markings in full compliance with Section 652 prior to expiration of the 14 calendar day period.

Interim raised pavement markers may be substituted for the interim skip (broken) stripes. If raised pavement markers are substituted for the two foot interim skip stripe, three markers spaced at equal intervals over a two foot distance will be required. No separate payment will be made if the interim raised pavement markers are substituted for interim skip lines.

Interim raised pavement markers shall be retro-reflective, shall be the same color as the pavement markers for which they are substituted, and shall be visible during daytime.

The type of interim marker and method of attachment to the pavement shall be approved by the Office of Materials and Research but in no case will the markers be attached by the use of nails. Flexible reflective markers, Type 14 or Type 15, may be used for a maximum of fourteen (14) calendar days as an interim marker. Any flexible reflective markers in use shall be from the GDOT qualified products list (QPL).

The interim raised pavement markers shall be maintained until the full pattern pavement markings are applied. At the time full pattern markings are applied the interim raised markers shall be removed in a manner that will not interfere with application of the full pattern pavement markings.

b. NO PASSING ZONES-TWO-LANE, TWO-WAY ROADWAYS

Passing zones shall be re-established in the locations existing prior to resurfacing. No changes to the location of passing zones shall be done without the written approval of the Engineer. For periods not to exceed three calendar days where interim skip centerlines are in place, no-passing zones shall be identified by using post or portable mounted DO NOT PASS regulatory signs (R4-1 24" x 30") at the beginning and at intervals not to exceed ½ mile within each no-passing zone. A post or portable mounted PASS WITH CARE regulatory sign (R4-1 24" x 30") shall be placed at the end of each no-passing zone. Post mounted signs shall be placed in accordance with the MUTCD. Portable signs shall conform to the requirements of the MUTCD and shall be NCHRP 350 compliant. Portable signs shall be secured in such a manner to prevent misalignment and minimize the possibility of being blown over by weather conditions or traffic.

On new location projects and on projects where either horizontal or vertical alignments has been modified, the location of No-Passing Zones will be identified by the Engineer.

c. EDGELINES

1) Bituminous Surface Treatment Paving

Edge lines will not be required on intermediate surfaces (including asphaltic concrete leveling for bituminous surface treatment paving) that are in use for a period of less than 60 calendar days except at bridge approaches, on lane transitions, lane shifts, and in such other areas as determined by the Engineer. On the final surface, edge lines shall be placed within 30 calendar days of the time that the final surface was placed.

2) All Other Types of Pavement

Edge lines will not be required on intermediate surfaces that are in use for a period of less than 30 calendar days except at bridge approaches, on lane transitions, lane shifts, and in such other areas as determined by the Engineer. On the final surface, edge lines shall be placed within 14 calendar days of the time that the surface was placed.

2. Multi-Lane Highways – With No Paved Shoulder(S) Or Paved Shoulder(S) Four Feet Or Less

a. UNDIVIDED HIGHWAYS (INCLUDES PAVED CENTER TURN LANE)

- 1) Centerlines and No-Passing Barrier-Full Pattern centerlines and no-passing barriers shall be restored before opening to traffic.
- 2) Landlines- Interim skip (broken) stripe as described in Subsection 150.04E.1.a. may be used for periods not to exceed three calendar days. Skip lines are not permitted in lane shift areas. Solid lines shall be used.
- 3) Edge lines- Edge lines shall be placed on intermediate and final surfaces within three calendar days of obliteration.

b. DIVIDED HIGHWAYS (GRASS OR RAISED MEDIAN)

- 1) Landlines- Full pattern skip stripe shall be restored before opening to traffic. Skip lines are not permitted in lane shift areas. Solid lines shall be required.
- 2) Centerline/Edge line- Solid lines shall be placed on intermediate and final surfaces within three calendar days of obliteration.

3. Limited Access Roadways And Roadways With Paved Shoulders Greater Than Four Feet

a. Same as Subsection 150.04.E.2 except as noted in (b) below.

b. EDGELINES-

- 1) Asphaltic Concrete Pavement- Edge lines shall be placed on intermediate and final surfaces prior to opening to traffic.
- 2) Portland Cement Concrete Pavement- Edge lines shall be placed on any surface open to traffic no later than one calendar day after work is completed on a section of roadway. All water and residue shall be removed prior to daily striping.

4. Ramps For Multi-Lane Divided Highways

A minimum of one solid line edge stripe shall be placed on any intermediate surface of a ramp prior to opening the ramp to traffic. The other edge stripe may be omitted for a maximum period of three (3) calendar days on an intermediate surface.

Appropriate channelization devices shall be spaced at a maximum of twenty-five (25') feet intervals until the other stripe has been installed.

The final surface shall have both stripes placed prior to opening the ramp to traffic.

5. Miscellaneous pavement markings

FINAL SURFACE: School zones, railroads, stop bars, symbols, words and other similar markings shall be placed on final surfaces conforming to Section 652 within fourteen (14) calendar days of

completion of the final surface. Final markings shall conform to the type of pay item in the plans. When no pay item exists in the plans the final markings shall conform to Section 652 for painted markings.

INTERMEDIATE SURFACE: Intermediate surfaces that will be in use for more than forty-five (45) calendar days shall have the miscellaneous pavement markings installed to conform to the requirement of Section 652. Under Subsection 150.11, Special Conditions, or as directed by the Engineer these markings may be eliminated.

F. Mobile operations

When pavement markings (centerlines, lane lines, and edge lines) are applied in a continuous operation by moving vehicles and equipment, the following minimum equipment and warning devices shall be required. These devices and equipment are in addition to the minimum requirements of the most current version of the MUTCD.

1. All Roadways

All vehicles shall be equipped with the official slow moving vehicle symbol sign. All vehicles shall have a minimum of two flashing or rotating beacons visible in all directions. All protection vehicles shall have an arrow panel mounted on the rear. All vehicles requiring an arrow panel shall have, as a minimum, a Type B panel. All vehicle mounted signs shall be mounted with the bottom of the sign a minimum height of forty-eight inches (48") above the pavement. All sign legends shall be covered or removed from view when work is not in progress.

2. Two-Lane Two-Way Roadways

a. Lead Vehicles

The lead vehicle may be a separate vehicle or the work vehicle applying the pavement markings may be used as the lead vehicle. The lead vehicle shall have an arrow panel mounted so that the panel is easily visible to oncoming (approaching) traffic. The arrow panel should typically operate in the caution mode.

b. Work Vehicles

The work vehicle(s) applying markings shall have an arrow panel mounted on the rear. The arrow panel should typically operate in the caution mode. The work vehicle placing cones shall follow directly behind the work vehicle applying the markings.

c. Protection Vehicles

A protection vehicle may follow the cone work vehicle when the cones are being placed and may follow when the cones are being removed.

3. Multi-Lane roadways

A lead vehicle may be used but is not required. The work vehicle placing cones shall follow directly behind the work vehicle applying the markings. A protection vehicle that does not function as a work vehicle should follow the cone work vehicle when traffic cones are being placed. A protection vehicle should follow the cone work vehicle when the cones are being removed from the roadway. Protection vehicles shall display a sign on the rear of the vehicle with the legend PASS ON LEFT(RIGHT).

INTERSTATES AND LIMITED ACCESS ROADWAYS: A protection vehicle shall follow the last work vehicle at all times and shall be equipped with a truck mounted attenuator (TMA) that is certified for impacts not less than 62 mph in accordance with NCHRP350 Test Level Three (3).

150.05 Channelization

A. General

Channelization shall clearly delineate the travel way through the work zone and alert drivers and pedestrians to conditions created by work activities in or near the travel way. Channelization shall be done in accordance with the plans and specifications, the MUTCD, and the following requirements.

All Channelization Devices utilized on any project shall be NCHRP 350 compliant. Any device used on the Work shall be from the Qualified Products List. All devices utilized on the work shall have a decal, logo, or manufacturer's stamping that clearly identifies the device as NCHRP 350 compliant. The Contractor may be required to furnish certification from the Manufacturer for any device to prove NCHRP 350 compliance.

1. Types of Devices Permitted for Channelization in Construction Work Zones:

a. DRUMS:

- 1) DESIGN: Drums shall meet the minimum requirement of the MUTCD and shall be reflectorized as required in Subsection 150.01.C. The upper edge of the top reflectorized stripe on the drum shall be located a minimum of 33 inches above the surface of the roadway. A minimum drum diameter of 18 inches shall be maintained for a minimum of 34 inches above the roadway.
- 2) APPLICATION: Drums shall be used as the required channelizing device to delineate the full length of a lane closure, shift, or encroachment, except as modified by this Subsection.
- 3) TRANSITION TAPERS FOR LANE CLOSURES: Drums shall be used on all transition tapers. The minimum length for a merging taper for a lane closure on the travel way shall be as shown in Table 150-1:

TABLE 150-1

Posted Speed Limit, MPH	Lane Width 9 Feet	Lane Width 10 Feet	Lane Width 11 Feet	Lane Width 12 Feet	Maximum Drum Spacing in Tapers, (Feet)
	Minimum Taper Length (L) in Feet				
20	60	70	75	80	20
25	95	105	115	125	25
30	135	150	165	180	30
35	185	205	225	245	35
40	240	270	295	320	40
45	405	450	495	540	45
50	450	500	550	600	50
55	495	550	605	660	55
60	540	600	660	720	60
65	585	650	715	780	65
70	630	700	770	840	70
75	675	750	825	900	75

If site conditions require a longer taper then the taper shall be lengthened to fit particular individual situations.

The length of shifting tapers should be at least ½ L.

The length of a closed lane or lanes, excluding the transition taper(s), shall be limited to a total of two (2) miles. Prior approval must be obtained from the Engineer before this length can be increased.

Night time conditions: When a merge taper exists into the night all drums located in the taper shall have, for the length of the taper only, a six (6") inch fluorescent orange (ASTM Type VII, VIII, IX or X) reflectorized top stripe on each drum. The top six-inch stripe may be temporarily attached to the drum while in use in a taper. All drums that have the six-inch top stripe permanently attached shall not be used for any other conditions.

Multiple Lane Closures:

- (a) A maximum of one lane at a time shall be closed with each merge taper.
- (b) A minimum tangent length of 2 L shall be installed between each individual lane closure taper.

- 4) LONGITUDINAL CHANNELIZATION: Drums shall be spaced as listed below for various roadside work conditions except as modified by Subsection 150.06. Spacing shall be used for situations meeting any of the conditions listed as follows:
 - (a) 40 FOOT SPACING MAXIMUM
 - (1) For difference in elevation exceeding two inches.
 - (2) For healed sections no steeper than 4:1 as shown in Subsection 150.06, Detail 150-E.
 - (b) 80 FOOT SPACING MAXIMUM
 - (1) For difference in elevation of two inches or less.
 - (2) Flush areas where equipment or workers are within ten feet of the travel lane.
 - (c) 200 FOOT SPACING MAXIMUM: Where equipment or workers are more than ten feet from travel lane. Lateral offset clearance to be four feet from the travel lane.
 - (1) For paved areas eight feet or greater in width that are paved flush with a standard width travel lane.
 - (2) For disturbed shoulder areas not completed to typical section that are flush to the travel lane and considered a usable shoulder.

REMOVAL OF DRUMS: Drums may be removed after shoulders are completed to typical section and grassed. Guardrail and other safety devices shall be installed and appropriate signs advising of conditions such as soft or low shoulder shall be posted before the drums are removed.

b. VERTICAL PANELS

- 1) DESIGN: All vertical panels shall meet the minimum requirements of the MUTCD. All vertical panels shall have a minimum of 270 square inches of retro-reflective area facing the traffic and shall be mounted with the top of the reflective panel a minimum of 36" above the roadway.
- 2) APPLICATION: Lane encroachment by the drum on the travel way should permit a remaining lane width of ten feet. When encroachment reduces the travel way to less than ten feet, vertical panels shall be used to restore the travel way to ten feet or greater. No other application of vertical panels will be permitted.

c. CONES

- 1) DESIGN: All cones shall be a minimum of 28 inches in height regardless of application and shall meet the requirement of the most current version of the MUTCD. Reflectorization may be deleted from all cones.
- 2) APPLICATION: For longitudinal channelizing only, cones will be permitted for daylight closures or minor shifts. (Drums are required for all tapers.) The use of cones for

nighttime work will not be permitted. Cones shall not be stored or allowed to be visible on the worksite during nighttime hours.

d. BARRICADES

DESIGN: Type III barricades shall meet the minimum requirements of the MUTCD and shall be reflectorized as required in Subsection 150.01.C.

The Contractor has the option of choosing Type III barricades from the Qualified Products List or the Contractor may utilize generic barricades that are approved by the Federal Highway Administration (FHWA). When barricades have been specifically crash tested with signs attached, the contractor has the responsibility to attach the signs as per the manufacturer's recommendations to ensure crashworthiness. If signs are attached to generic barricades or to barricades from the Qualified Products List (QPL) that have not been crash tested with signs attached then the responsibility for crashworthiness and the liability for mounting these signs to the barricades are assumed by the Contractor and the Contractor shall certify that the barricades are crashworthy under FHWA work zone guidelines for NCHRP 350 crashworthy compliance. Any generic barricades used in the work shall be stamped or stenciled to show compliance with NCHRP 350. The use of Type I and Type II barricades will not be permitted.

- 1) APPLICATION: Type III barricades shall be placed as required by the plans, the Standards, and as directed by the Engineer. All signs mounted on barricades shall be mounted to comply with the requirements of the MUTCD and NCHRP 350 Test Level III. NCHRP 350 crashworthy compliance may require that rigid signs be mounted separate from the Type III barricade.

When a barricade is placed so that it is subject to side impact from a vehicle, a drum shall be placed at the side of the barricade to add target value to the barricade.

e. WARNING LIGHTS:

- 1) DESIGN: All warning lights shall meet the requirements of the MUTCD.

- 2) APPLICATION

- (a) Type A low-intensity flashing lights shall be used as shown in the Plans, the Standards, and as directed by the Engineer. Flashing lights are not required for advance warning signs in Subsection 150.03.H.
- (b) Type C Steady-Burn lights shall be used as shown in the Plans, the Standards, and as directed by the Engineer. Steady-burn lights are not required on drums for merging tapers that exist into the night.

f. TEMPORARY BARRIERS

- 1) DESIGN: Temporary barriers shall meet the requirements of Sections 620.

- 2) APPLICATION: Temporary barriers shall be placed as required by the plans, standards, and as directed by the Engineer. When Temporary barrier is located 20 feet or less from a travel lane, yellow reflectors shall be fixed to the top of the barrier at intervals not greater than 40 feet in the longitudinal section and 20 feet in the taper section and shall be mounted approximately two inches above the barrier. If both lanes of a two-lane two-way roadway are within 20 feet or less of the barrier then the reflectors shall be installed for both directions of traffic.

The reflectors shall be 100 square inches (ASTM Type VII or VIII) reflective sheeting mounted on flat-sheet blanks. The reflectors shall be mounted approximately two inches above the top of the barrier. The reflectors shall be attached to the barrier with adhesive

or by a drilled-in anchor type device. The reflectors shall not be attached to a post or board that is placed between the gap in the barrier sections.

Approach end of Temporary barrier shall be flared or protected by an impact attenuator (crash cushion) or other approved treatment in accordance with Georgia Standard 4960, Construction Details and Standard Specifications.

On interstate or other controlled access highways where lane shifts or crossovers cause opposing traffic to be separated by less than 40 ft., portable barrier shall be used as a separator.

B. Portable impact attenuators

1. Description

This work consists of the furnishing (including spare parts), installation, maintenance, relocation, reuse as required, and removal of Portable Impact Attenuator Unit/Arrays.

2. Materials

Materials used in the Attenuator/Array shall meet the requirements of Section 648 for Portable Impact Attenuators.

3. Construction

Portable Impact Attenuator Unit/Array installation shall conform to the requirements of Section 648, Manufacturer's recommendations, and/or Georgia Standards 4960 & 4962 and shall be installed at locations designated by the Engineer, and/or as shown on the plans.

C. Temporary guardrail anchorage –Type 12

1. Description

This work consists of the furnishing, installation, maintenance and removal of Temporary Guardrail Anchorage- Type 12 used for Portable Barrier or temporary guardrail end treatment.

2. Materials

Materials used in the Temporary Guardrail Anchorage- Type 12 shall meet the requirements of Subsection 641.2 of the Specifications and current Georgia Standards and may be new or used. Materials salvaged from the Project which meet the requirements of Standards may be utilized if available. The use of any salvaged materials will require prior approval of the Engineer.

3. Construction

Installation of the Temporary Guardrail Anchorage- Type 12 shall conform to the requirements of the Plans, current Georgia Standards and Subsection 641.3 of the Specifications. Installation shall also include sufficient additional guardrail and appurtenances to effect the transition and connection to Temporary Concrete Barrier as required by the details in Georgia Standard 4960.

150.06 Differences in elevation between travel lanes and shoulders (See Subsection 150.06G for projects consisting primarily of asphaltic concrete resurfacing items)

Any type of work such as paving, grinding, trenching, or excavation that creates a difference in elevation between travel lanes or between the travel way and the shoulder shall not begin until the Contractor is prepared and able to continuously place the required typical section to within two inches (2") of the existing pavement elevation. For any areas that the two inches minimum difference in elevation cannot be accomplished the section shall be healed as shown in Detail 150-E. If crushed stone materials are used to provide a healed section no separate payment will be made for the material used to heal any section. The Contractor may submit a plan to utilize existing pay items for crushed stone provided the plan clearly demonstrates that the materials used to heal an area will be incorporated into the work with minimal waste. Handling and hauling of any crushed stone used to heal shall be kept to a minimum. The Engineer shall

determine if the crushed stone used to heal meets the specifications for gradation and quality when the material is placed in the final location.

A maximum of sixty (60) calendar days shall be allowed for conditions to exist that require any section or segment of the roadway or ramp to continue to require a healed section as described by Detail 150-E. Failure to meet this requirement shall be considered as non-performance of Work under Subsection 150.08.

When trenching or excavation for minor roadway or shoulder widening is required, all operations at one site shall be completed to the level of the existing pavement in the same work day.

Any channelization devices utilized in the work shall conform to the requirements of Subsection 150.05 and to the placement and spacing requirements in Details 150-B, 150-C, 150-D, and 150-E shown in this section.

Any construction activity that reduces the width of a travel lane shall require the use of a W-20 sign with the legend "LEFT/RIGHT LANE NARROWS". Two 24" x 24" red or red/orange flags may be mounted above the W-20 sign. The W-20 sign shall be located on the side of the travel way that has been reduced in width just off the travel way edge of pavement. The W-20 sign shall be a minimum of 500 feet in advance of any channelization devices that encroach on the surface of travel way. A portable changeable message sign may be used in lieu of the W-20 sign.

General/time restrictions

A. Stone Bases, Soil Aggregate Base and Soil Bases

1. All Highways

Differences in elevation of more than two inches between surfaces carrying or adjacent to traffic will not be allowed for more than a 24-hour period. A single length of excavated area that does not exceed 1000 feet in total length may be left open as a start up area for periods not to exceed 48 hours provided the Contractor can demonstrate the ability to continuously excavate and backfill in a proficient manner. Prior approval of the Engineer shall be obtained before any startup area may be allowed.

2. Limited Access Highway Ramps (Interstates)

On projects that include ramp rehabilitation work, one ramp at a time may be excavated for the entire length of the ramp from the gore point of the ramp with the interstate mainline to the intersection with the crossing highway. This single ramp may remain excavated with a vertical difference in elevation greater than two (2") inches for a maximum of fourteen (14) calendar days with drums spaced at twenty (20') feet intervals as shown in Detail 150-B and a buffer space accepted under Section 150.06.F. After fourteen (14) calendar days the section shall be healed as required for all other highways. This area will be allowed in addition to the 1000 feet allowed for all other highways.

B. Asphalt Bases, Binders and Toppings

1. Differences in elevation between the surfaces of adjacent

Travel lanes shall be paved with a plan that minimizes any difference in elevation between adjacent travel lanes. The following limitations will be required on all work:

- a. Differences of two inches (2") or less may remain for a maximum period of fourteen (14) calendar days.
- b. Differences of greater than two inches (2") shall be permitted for continuous operations only.

EMERGENCY SITUATIONS: Inclement weather, traffic accidents, and other events beyond the control of the Contractor may prevent the work from being completed as required above. The

Contractor shall notify the Engineer in writing stating the conditions and reasons that have prevented the Contractor from complying with the time limitations. The Contractor shall also outline a plan detailing immediate steps to complete the work. Failure to correct these conditions on the first calendar day that conditions will allow corrective work shall be considered as non-performance of Work under Subsection 150.08.

2. Differences in elevation between asphalt travel way and paved

Differences in elevation between the asphalt travel way and asphalt paved shoulders shall not be allowed to exist beyond the maximum durations outlined below for the conditions shown in Details 150-B, 150-C, 150-D, and 150-E:

Detail 150-B conditions shall not be allowed for more than 24 hours. A single length that does not exceed 1000 feet in total length may be left open for periods not to exceed 48 hours provided the Contractor can demonstrate the ability to continuously pave in a proficient manner. Prior approval of the Engineer shall be obtained before any section is allowed to exceed 24 hours. Any other disturbed shoulder areas shall be healed as in Detail 150-E.

Detail 150-C conditions will not be allowed for more than 48 hours.

Detail 150-D conditions will not be allowed for more than 30 calendar days.

Detail 150-E conditions will not be allowed for more than 60 calendar days.

Failure to meet these requirements shall be considered as non-performance of Work under Subsection 150.08.

C. Portland Cement concrete

Work adjacent to a Portland Cement Concrete traveled way which involves the following types of base and shoulders shall be accomplished according to the time restrictions outlined for each type of base or shoulder. Traffic control devices shall be in accordance with Subsection 150.05.

1. Cement stabilized base

Work adjacent to the traveled way shall be healed as per Detail 150-E within forty-eight (48) hours after the seven (7) calendar day curing period is complete for each section placed. During the placement and curing period, traffic control shall be in accordance Detail 150-B.

2. Asphaltic concrete base

When an asphaltic concrete base is utilized in lieu of a cement stabilized base the asphaltic concrete base shall be healed as per Detail 150-E within forty-eight (48) hours after the placement of each section of asphaltic concrete base. For the first forty eight hours traffic control shall be in compliance with Detail 150-B.

3. Concrete paved shoulders

Concrete paved shoulders shall be placed within sixty (60) calendar days after the removal of each section of existing shoulder regardless of the type of base materials being placed on the shoulders. During the placement period, traffic control devices shall be in accordance with the appropriate detail based on the depth of the change in elevation.

4. Asphaltic concrete shoulders

A difference in elevation that meets the requirements of Detail 150-B shall not be allowed to exist for a period greater than forty-eight (48) hours. After the removal of the existing shoulder the section or segment of travel way may be healed with stone as per Detail 150-E for a maximum of fourteen (14) calendar days. Asphaltic concrete shoulders shall be placed within two (2") inches or less of the traveled way surface within fourteen (14) calendar days after the removal of the stone healed section or the removal of each section of the existing shoulder. The two (2") inches or less difference in elevation shall not remain in existence for a period that exceeds thirty (30) calendar

days unless the paved shoulder is utilized as a detour for the traveled way. During the placement period, traffic control shall be in accordance with the appropriate detail based on the depth of the change in elevation.

The Contractor may propose an alternate plan based on Subsection 150.06.F. Failure to meet the above requirements and time restrictions shall be considered as non-performance of Work under Subsection 150.08.

D. Miscellaneous elevation differentials for excavations adjacent to the travel way

Drainage structures, utility facilities, or any other work which results in a difference in elevation adjacent to the travel way shall be planned and coordinated to be performed in such a manner to minimize the time traffic is exposed to this condition. The excavation should be back filled to the minimum requirements of Detail 150-E as soon as practical. Stage construction such as plating or backfilling the incomplete work may be required. The difference in elevation shall not be allowed to exist for more than five (5) calendar days under any circumstances. Failure to correct this condition shall be considered as non-performance of Work under Subsection 150.08.

E. Conduit Installation in paved and dirt shoulders

The installation of conduit and conduit systems along the shoulders of a traveled way shall be planned and installed in a manner to minimize the length of time that traffic is exposed to a difference in elevation condition. The following restrictions and limitations shall apply:

1. Differences in elevation of Two (2") Inches or less

The shoulder may remain open when workers are not present. When workers are present the shoulder shall be closed and the channelization devices shall meet the requirements of Subsection 150.05. The difference in elevation on the shoulder shall remain for a maximum period of fourteen (14) calendar days.

2. Differences in elevation greater than Two (2") Inches

The shoulder shall be closed. The shoulder closure shall not exceed twenty-four (24) hours in duration unless the Special Conditions in Subsection 150.11 modifies this restriction or the Engineer allows the work to be considered as a continuous operation.

Failure to meet these requirements shall be considered as non-performance of Work under Subsection 150.08.

F. Modifications to Details 150-B, 150-C, 150-D AND 150-E

The Contractor may propose any alternate traffic control plan that utilizes a portion of the travel lane as a "buffer space". This buffer space may allow for an enhanced work area that will allow for the placement of materials to proceed at a pace that could not be achieved with the time restriction requirements outlined in Section 150.06.A, 150.06.B, and 150.06.C. The Contractor may propose modified time restrictions based on the use of the buffer space. Any proposed modifications in the time duration allowed for the differences in elevations to exist shall be reviewed by the Engineer as a component of the overall traffic control plan. No modifications shall be made until the proposed plan is accepted by the Engineer. The Engineer shall have no obligation to consider any proposal which results in an increase in cost to the Department.

For the travel lane described in each of the details 150-B, 150-C, 150-D and 150-E it is presumed that the pavement marking edge line (yellow or white solid stripe) is located at the very edge of the travel lane surface. A buffer space (temporary paved shoulder) that utilizes a portion of the travel lane should be six (6') feet in width desirable but shall not be less than four (4') feet in width. Any remaining travel lane(s) shall not be less than ten (10') feet in width.

If the proposed shifting of the traffic to obtain a buffer space and maintain a minimum travel lane(s) of ten (10') feet requires the use of any existing paved shoulders then the cost of maintenance and repair of the existing paved shoulder(s) shall be the responsibility of the Contractor. The Contractor is

responsible for the costs of maintenance and repairs even if the existing paved shoulder(s) is to be removed in a later stage of the work. Existing shoulders that have rumble strips shall have the rumble strips removed before the shoulder can be utilized as part of the travel lane. The cost of the removal of the rumble strips shall be done at no cost to the Department even if the shoulder is to be removed in a later stage of the work.

Any modifications to the staging and time restrictions that are approved as part of the traffic control plan shall be agreed to in writing. Failure to meet these modifications shall be considered as non-performance of the Work under Subsection 150.08.

G. Asphaltic Concrete Resurfacing Projects

SHOULDER CONSTRUCTION INCLUDED AS A PART OF THE CONTRACT: When the placement of asphaltic concrete materials creates a difference in elevation greater than two (2") inches between the earth shoulder (grassed or un-grassed) and the edge of travel way or between the earth shoulder and a paved shoulder that is less than four (4') feet in width, the Contractor shall place and maintain drums in accordance with the requirements of Subsection 150.05A.1.a.4. When the edge of the paved surface is tapered with a 30-45 degree wedge, drums may be spaced at 2.0 times the speed limit in MPH. Drums shall remain in place and be maintained until the difference in elevation has been eliminated by the placement of the appropriate shoulder materials.

SHOULDER CONSTRUCTION NOT INCLUDED AS A PART OF THE CONTRACT: When the placement of asphaltic concrete materials creates a difference in elevation greater than two (2") inches between the earth shoulder (grassed or un-grassed) and the edge of travel way or between the earth shoulder and a paved shoulder that is less than four (4') feet in width, the Contractor shall notify the Engineer, in writing, when the resurfacing work including all punch list items has been completed. See Subsection 150.03.L for the requirements for "LOW/SOFT SHOULDERS" and "SHOULDER DROP-OFF" signage.

Location of drums when Elevation Difference exceeds 4 inches. Drums spaced at 20 foot intervals. Note: If the travel way width is reduced to less than 10 feet by the use of drums, vertical panels shall be used in lieu of drums.
--

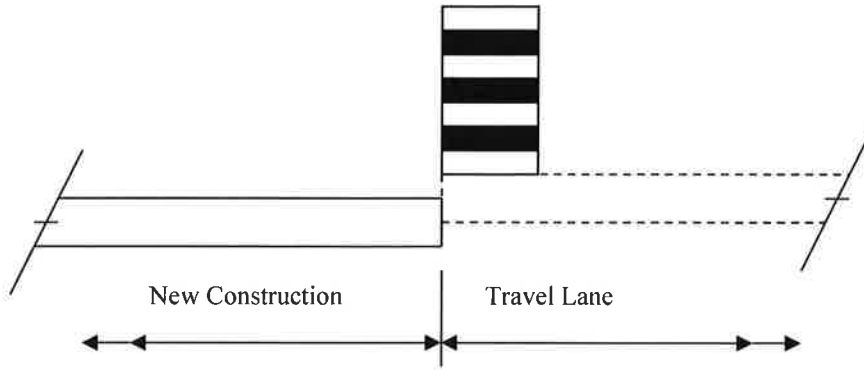

ELEVATION DIFFERENCE GREATER THAN 4 INCHES
DETAIL 150-B

Drums spaced at 40 foot intervals.	Location of drums when Elevation Difference is 2+ inches to 4 inches.
------------------------------------	---

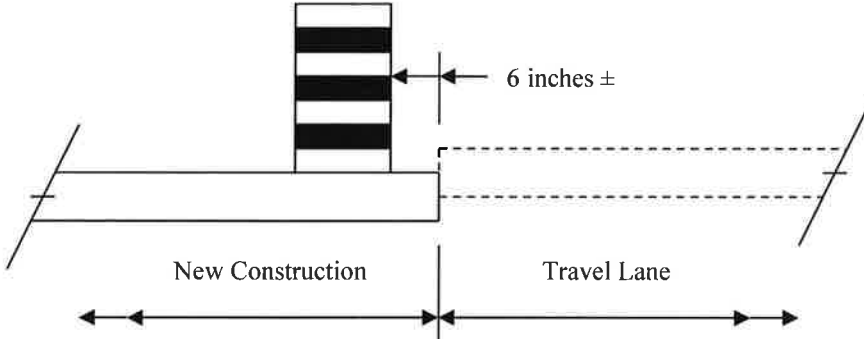

ELEVATION DIFFERENCE 2+ TO 4 INCHES
DETAIL 150-C

Drums spaced at 80 foot intervals.	Location of drums when Elevation Difference is 2 inches or less.
------------------------------------	--

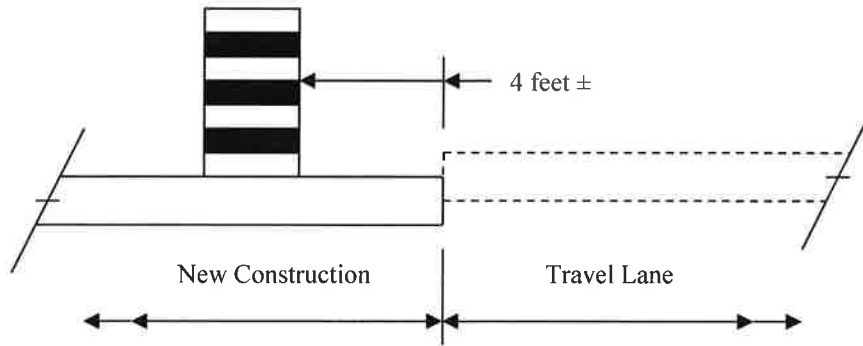

ELEVATION DIFFERENCE OF 2 INCHES OR LESS

DETAIL 150-D

	Location of drums immediately after completion of healed sections spaced at 40 foot intervals.
--	--

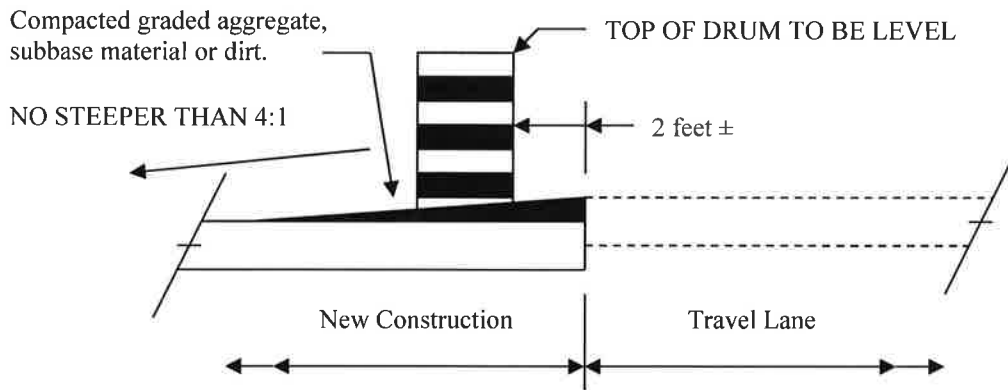

HEALED SECTION

DETAIL 150-E

150.07 Flagging and Pilot cars

A. Flaggers

Flaggers shall be provided as required to handle traffic, as specified in the Plans or Special Provisions, and as required by the Engineer.

B. Flagger Certification

All flaggers shall meet the requirements of the MUTCD and shall have received training and a certificate upon completion of the training from a Department approved training program. Failure to provide certified flaggers as required above shall be reason for the Engineer suspending work involving the flagger(s) until the Contractor provides the certified flagger(s). Flaggers shall have proof of certification and valid identification (photo I.D.) available any time they are performing flagger duties.

C. Flagger Appearance and equipment

Flaggers shall wear high-visibility clothing in compliance with the most current version of the MUTCD and shall use a Stop/Slow paddle meeting the requirements of the MUTCD for controlling traffic. The Stop/Slow paddles shall have a shaft length of seven (7) feet minimum. The Stop/Slow paddle shall be retro-reflectorized for both day and night usage. In addition to the Stop/Slow paddle, a flagger may use a flag as an additional device to attract attention. This flag shall meet the minimum requirements of the MUTCD. The flag shall, as a minimum, be 24" inches square and red or red/orange in color. For night work, the vest shall have reflectorized stripes which meet the requirements of the MUTCD.

D. Flagger warning signs

Signs for flagger traffic control shall be placed in advance of the flagging operation in accordance with the MUTCD. In addition to the signs required by the MUTCD, signs at regular intervals, warning of the presence of the flagger shall be placed beyond the point where traffic can reasonably be expected to stop under the most severe conditions for that day's work.

E. Pilot vehicle requirements

Pilot vehicles will be required during placement of bituminous surface treatment or asphaltic concrete on two-lane roadways unless otherwise specified. Pilot vehicles shall meet the requirements of the MUTCD.

F. Portable temporary traffic control signals

The Contractor may request, in writing, the substitution of portable temporary traffic control signals for flaggers on two-lane two-way roadways provided the temporary signals meets the requirements of the MUTCD, Section 647, and Subsection 150.02.A.8. As a part of this request, the Contractor shall also submit an alternate traffic control plan in the event of a failure of the signals. Any alternate plan that requires the use of flaggers shall include the use of certified flaggers. The Contractor shall obtain the approval of the Engineer before the use of any portable temporary traffic control signals will be permitted.

150.08 Enforcement

The safe passage of pedestrians and traffic through and around the temporary traffic control zone, while minimizing confusion and disruption to traffic flow, shall have priority over all other Contractor activities. Continued failure of the Contractor to comply with the requirements of Section 150 (TRAFFIC CONTROL) will result in non-refundable deductions of monies from the Contract as shown in this Subsection for non-performance of Work.

Failure of the Contractor to comply with this Specification shall be reason for the Engineer suspending all other work on the Project, except erosion control and traffic control, taking corrective action as specified in Subsection 105.15, and/or withholding payment of monies due to the Contractor for any work on the Project until traffic control deficiencies are corrected. These other actions shall be in addition to the deductions for non-performance of traffic control.

SCHEDULE OF DEDUCTIONS FOR EACH CALENDAR DAY OF DEFICIENCIES OF TRAFFIC CONTROL INSTALLATION AND/OR MAINTENANCE		
ORIGINAL TOTAL CONTRACT AMOUNT		
From More Than	To and Including	Daily Charge
\$0	\$100,000	\$200
\$100,000	\$1,000,000	\$500
\$1,000,000	\$5,000,000	\$1,000
\$5,000,000	\$20,000,000	\$1,500
\$20,000,000	\$40,000,000	\$2,000
\$40,000,000	\$-----	\$3,000

150.09 Measurement

A. Traffic Control

When listed as a pay item in the Proposal, payment will be made at the Lump Sum price bid, which will include all traffic control not paid for separately, and will be paid as follows:

When the first Construction Report is submitted, a payment of 25 (twenty-five) percent of the Lump Sum price will be made. For each progress payment thereafter, the total of the Project percent complete shown on the last pay statement plus 25 (twenty-five) percent will be paid (less previous payments), not to exceed one hundred (100) percent.

When no payment item for Traffic Control-Lump Sum is shown in the Proposal, all of the requirements of Section 150 and the Traffic Control Plan shall be in full force and effect. The cost of complying with these requirements will not be paid for separately, but shall be included in the overall bid submittal.

B. Signs

When shown as a pay item in the contract, interim special guide signs will be paid for as listed below. All other regulatory, warning, and guide signs, as required by the Contract, will be paid for under Traffic Control Lump Sum or included in the overall bid submitted.

1. Interim ground mounted or interim overhead special guide signs will be measured for payment by the square foot. This payment shall be full compensation for furnishing the signs, including supports as required, erecting, illuminating overhead signs, maintaining, removing, re-erecting, and final removal from the Project. Payment will be made only one time regardless of the number of moves required.
2. Remove and reset existing special guide signs, ground mount or overhead, complete, in place, will be measured for payment per each. Payment will be made only one time regardless of the number of moves required.
3. Modify special guide signs, ground mount or overhead, will be measured for payment by the square foot. The area measured shall include only that portion of the sign modified. Payment shall include materials, removal from posts or supports when necessary, and remounting as required.

C. Temporary Barrier

Temporary Barrier shall be measured as specified in Section 620.

D. Changeable message sign, portable

Changeable Message Sign, Portable will be measured as specified in Section 632.

E. Temporary Guardrail anchorage, Type 12

Temporary Guardrail Anchorage- Type 12 will be measured by each assembly, complete in place and accepted according to the details shown in the plans, which shall also include the additional guardrail and appurtenances necessary for transition and connection to Temporary Concrete Barrier. Payment shall include all necessary materials, equipment, labor, site preparation, maintenance and removal.

F. Traffic signal installation – Temporary

Traffic Signal Installation- Temporary will be measured as specified in Section 647.

G. Flashing Beacon assembly

Flashing Beacon Assemblies will be measured as specified in Section 647.

H. Portable impact attenuators

Each Portable Impact Attenuator will be measured by the unit/array which shall include all material components, hardware, incidentals, labor, site preparation, and maintenance, including spare parts recommended by the manufacturer for repairing accident damage. Each unit will be measured only once regardless of the number of locations installed, moves required, or number of repairs necessary because of traffic damage. Upon completion of the project, the units shall be removed and retained by the Contractor.

I. Pavement Markings

Pavement markings will be measured as specified in Section 150.

150.10 Payment

When shown in the Schedule of Items in the Proposal, the following items will be paid for separately.

Item No. 150. Traffic Control.....Lump Sum

SECTION 161 CONTROL OF SOIL EROSION AND SEDIMENTATION

The Contractor shall provide sufficient erosion and sedimentation controls as necessary or as directed by the County to prevent stormwater pollution or illicit discharges.

END OF SECTION

ROCKDALE COUNTY, GEORGIA

2017 SPLOST CONSTRUCTION PROGRAM

ITB # 20-06

**Sigman Road Widening and Multi-Use Trail from East of CR 79/Lester
Road to CS 442/Irwin Bridge Road**

P.I. Nos. 0013163 and 0012886

CONTRACT AGREEMENT

For

Rockdale County Department of Transportation (RDOT)

CONTRACT # C-2020 - _____

CONTRACT AGREEMENT

THIS AGREEMENT made by and between ROCKDALE COUNTY, GEORGIA, hereinafter called "**County**", and _____ a contractor doing business as a corporation of the City of _____, County of _____, and State of _____, hereinafter called "**Contractor**".

WITNESSETH: that for and in consideration of the payments and agreements hereinafter mentioned, to be made and performed by the **County**, the **Contractor** hereby agrees to commence and complete the construction described as follows:

Furnishing all labor, materials and equipment for the reconstruction of Sigman Road, in Rockdale County. The project will widen and improve approximately 1.26 miles of Sigman Road from just east of Lester Road to just east of Irwin Bridge Road. Sigman Road would be widened from two lanes to four 12-ft travel lanes with a 20-ft. raised median. The left shoulder will consist of an 18-ft. urban shoulder with a 10-ft. concrete multi-use path and the right shoulder will consist of a 12-ft. urban shoulder with a 5-ft. concrete sidewalk. There will be signals installed at the intersections of Sigman Rd @ Rockbridge Road; and Sigman Road @ Irwin Bridge Road. P.I. # 0012886 is for the construction of the 10-ft concrete multi-use path on the north side of Sigman Road. This project is located in central Rockdale County and partially in the City of Conyers.

hereinafter called the "Project", for the sum of **\$XXX,XXX.XX (XXX, XX, and XX Cents)** and all extra work in connection therewith, under the terms as stated in the General Conditions, Special Provisions, Appendices and Detailed Specifications of the Contract, and at **Contractor's** own cost and expense necessary to furnish all materials, supplies, machinery, equipment, tools, superintendence, labor, insurance, and other accessories and services to complete the said project in accordance with the conditions and prices stated in the proposal, the General Conditions, Special Provisions, Appendices, and Detailed Specifications of the Contract, the plans, which include all explanatory matter thereof, as prepared by Rockdale County, the specifications and contract documents as enumerated in Section 105.04 of the General Conditions, hereinafter called the "**Work**", all of which are made a part hereof and collectively constitute the Contract.

The **Contractor** shall promptly commence the Work with adequate force and equipment within ten (10) calendar days from receipt of Notice to Proceed, or as may be specified by Special Provision, and to complete the Work by **730 Days from Notice to Proceed** or as may be specified by Special Provision.

Time is of the essence and is an essential element of this Contract, and the Contractor shall pay to the County, not as a penalty, but as liquidated damages, the sum of \$100.00 for each calendar day that there is default of completing the Work within the time limit named herein. If the Contractor abandons the Contract before commencement of the Work or defaults in completion of all the Work after commencement thereof, the Contractor shall be liable for such liquidated damages.

These fixed liquidated damages are not established as a penalty but are calculated and agreed upon in advance by the County and the Contractor due to the uncertainty and impossibility of making a determination as to the actual and consequential damages incurred by the County and the general public of Rockdale County, Georgia as a result of the failure on the part of the Contractor to complete the Work on time. Such liquidated damages referred to herein are intended to be and are cumulative and shall be in addition to every other remedy now or hereafter enforceable at law, in equity, by statute, or under the Contract.

The **County** agrees to pay the **Contractor** in current funds for the performance of the Contract subject to additions and deductions as provided in the General Conditions of the Contract, and to make payments on account thereof as provided in Section 109 of the Specifications, as modified in the General Conditions and Special Provisions.

Each party hereby agrees to indemnify and hold harmless the other party from any form of action, lawsuit or claim brought by or on behalf of the indemnifying party's employees, agents or invitees and related in any way to Product/Equipment/Services supplied by Seller under this Agreement. Each party expressly agrees that the obligation of indemnity under this Paragraph extends to an action, lawsuit or claim alleging negligence of the indemnitee.

CONTRACT
page 2 of 2

IN WITNESS WHEREOF, the parties to those presents have executed this Contract in two (2) counterparts, each of which shall be deemed an original.

Executed this ___ day of _____, 202__.

ROCKDALE COUNTY, GEORGIA

ATTEST: _____ By: _____ (Seal)
Ex-Officio Clerk Osborn Nesbitt, Sr.
Chairman, Board of Commissioners

Approved as to Form:

County Attorney

CONTRACTOR

ATTEST: _____ By: _____ (Seal)
Secretary or Assistant

(Print)
President or Vice President

100% PERFORMANCE BOND
page 1 of 2

KNOW ALL MEN BY THESE PRESENTS: that, _____, as Principal, hereinafter called **Contractor**, and _____, a corporation organized and existing under the laws of the State of _____, hereinafter called **Surety**, are held and firmly bound unto ROCKDALE COUNTY, GEORGIA, as obligee, hereinafter called **County**, in the amount of **\$XXX,XXX.XX (XXX, XXX, XXX and XX Cents)** for the payment whereof **Contractor** and **Surety** bind themselves, their heirs, executors, administrators, successors and assigns, jointly and severally, firmly by these presents.

WHEREAS, **Contractor** has by written agreement dated _____, 202__, entered into a contract with the **County** to:

Furnishing all labor, materials and equipment for the reconstruction of Sigman Road, in Rockdale County. The project will widen and improve approximately 1.26 miles of Sigman Road from just east of Lester Road to just east of Irwin Bridge Road. Sigman Road would be widened from two lanes to four 12-ft travel lanes with a 20-ft. raised median. The left shoulder will consist of an 18-ft. urban shoulder with a 10-ft. concrete multi-use path and the right shoulder will consist of a 12-ft. urban shoulder with a 5-ft. concrete sidewalk. There will be signals installed at the intersections of Sigman Rd @ Rockbridge Road; and Sigman Road @ Irwin Bridge Road. P.I. # 0012886 is for the construction of the 10-ft concrete multi-use path on the north side of Sigman Road. This project is located in central Rockdale County and partially in the City of Conyers.

in accordance with drawings and specifications prepared by Rockdale County, which contract is by reference made a part hereof, and is hereinafter referred to as the Contract.

NOW, THEREFORE, the condition of this obligation is such that, if **Contractor** shall promptly and faithfully perform said Contract, then this obligation shall be null and void, otherwise it will remain in full force and effect.

The **Surety** hereby waives notice of any alteration or extension of time made by the **County**.

Whenever **Contractor** shall be, and declared by **County** to be, in default under the Contract, the **County** having performed **County's** obligation thereunder, the **Surety** may promptly remedy the default, or shall promptly:

1. Complete the Contract in accordance with its terms and conditions; or,
2. Obtain a bid or bids for completing the Contract in accordance with its terms and conditions, and upon determination by **Surety** of the lowest bidder, or, if the **County** elects, upon determination by the **County** and **Surety** jointly of the lowest responsible bidder, arrange for a Contract between such Bidder and the **County**, and make available as work progresses (even though there should be

100% PERFORMANCE BOND
page 2 of 2

a default or a succession of defaults under the Contract or Contract of Completion arranged under this paragraph) sufficient funds to pay the cost of completion less the balance of the Contract price; but not exceeding, including other costs and damages for which the **Surety** may be liable hereunder, the amount set forth in the first paragraph hereof. The term "Balance of the Contract Price", as used in this paragraph shall mean the total amount payable by **County** to **Contractor** under the Contract and any amendments hereto, less the amount properly paid by **County** to **Contractor**.

No action can be instituted on this bond after one year from the completion of the Contract and the acceptance by the **County** of the work thereunder.

Signed and sealed this ___ day of _____, 202__.

in the presence of:

Contractor

_____ By: _____ (SEAL)
Witness

Surety

_____ By: _____ (SEAL)
Witness

100% LABOR AND MATERIAL PAYMENT BOND
page 1 of 2

KNOW ALL MEN BY THESE PRESENTS: that, _____, as Principal, hereinafter called **Contractor**, and _____, a corporation organized and existing under the laws of the State of _____, hereinafter called **Surety**, are held and firmly bound unto ROCKDALE COUNTY, GEORGIA, as obligee, hereinafter called **County**, in the amount of **\$XXX,XXX.XX (XXX, XXX, XXX, XXX, and XX cents)** for the payment whereof **Contractor** and **Surety** bind themselves, their heirs, executors, administrators, successors and assigns, jointly and severally, firmly by these presents.

WHEREAS, Contractor as by written agreement dated _____, 202__, entered into a Contract with County to:

Furnishing all labor, materials and equipment for the reconstruction of Sigman Road, in Rockdale County. The project will widen and improve approximately 1.26 miles of Sigman Road from just east of Lester Road to just east of Irwin Bridge Road. Sigman Road would be widened from two lanes to four 12-ft travel lanes with a 20-ft. raised median. The left shoulder will consist of an 18-ft. urban shoulder with a 10-ft. concrete multi-use path and the right shoulder will consist of a 12-ft. urban shoulder with a 5-ft. concrete sidewalk. There will be signals installed at the intersections of Sigman Rd @ Rockbridge Road; and Sigman Road @ Irwin Bridge Road. P.I. # 0012886 is for the construction of the 10-ft concrete multi-use path on the north side of Sigman Road. This project is located in central Rockdale County and partially in the City of Conyers.

in accordance with drawings and specifications prepared by Rockdale County, which contract is by reference made a part hereof, and is hereafter referred to as the Contract.

NOW, THEREFORE, the condition of this obligation is such that if the Contractor shall promptly make payment to all claimants as is herein below defined, for all labor and materials used or reasonably required for use in the performance of the Contract, this obligation shall be null and void; otherwise, it shall remain in full force and effect subject, however, to the following conditions:

1. A claimant is defined as one having a direct contract with the Contractor or with a Subcontractor of the Contractor for labor, material, or both, used or reasonably required for use in the performance of the Contract; labor and material being construed to include that part of water, gas, power, light, heating oil, gasoline, telephone service, rental of equipment, or repair of equipment directly applicable to the Contract.
2. The above-named Contractor and Surety hereby jointly and severally agree with the County that every claimant as herein defined, who has not been paid in full before the expiration of a period of ninety (90) days after the date on which the last of such claimant's work or labor was done or performed, or materials were furnished by such claimant, may sue on this bond for the use of such claimant, prosecute the suit to final judgment for such sum or sums as may be justly due claimant,

100% LABOR AND MATERIAL PAYMENT BOND
page 2 of 2

and have execution thereon. The County shall not be liable for the payment of any costs or expenses of any such suit.

3. No suit or action shall be commenced hereunder by any claimant:

A. Unless claimant, other than one having a direct contract with the Contractor, shall have given written notice to any two of the following: the Contractor, the County, or the Surety above-

named, within ninety (90) days after such claimant did or performed the last of the work or labor, or furnished the last of the materials for which said claim is made, stating with substantial accuracy the amount claimed and the name of the party to whom the materials were furnished, or for whom the work or labor was done or performed. Such notice shall be served by mailing the same by registered mail or certified mail, postage prepaid, in an envelope addressed to the Contractor, the County, or the Surety, at any place where an office is regularly maintained for the transaction of business, or served in any manner in which legal process may be served in the State in which the aforesaid project is located, save that such service need not be made by a public officer.

B. After one year from the completion of the Contract and the acceptance by County of the Work thereunder; it being understood, however, that if any limitation embodied in this bond is prohibited by any law controlling the construction hereof, such limitation shall be deemed to be amended so as to be equal to the minimum period of limitation permitted by such law.

C. Other than in a state court of competent jurisdiction in and for the County or other political subdivision of the State in which the Project, or any part thereof, is situated, or in the United States District Court for the district in which the Project, or any part thereof, is situated and not elsewhere.

4. The amount of this bond shall be reduced by and to the extent of any payment or payments made in good faith hereunder, inclusive of the payment by Surety for mechanics' liens which may be filed on record against improvement, whether or not claim for the amount of such lien be presented under and against this bond.

Signed and sealed this ____ day of _____, 202__.

Contractor

By: _____ (Seal)

Witness

Surety

By: _____ (Seal)

Witness

Georgia Representative

This bond is issued simultaneously with Performance Bond in favor of the County.

SUBCONTRACTOR NOTIFICATION LIST

Required information on Subcontractors doing work in Rockdale County:

Please list any Subcontractors, the address, Business License number, scope of work and start date, and percent of work assigned for each Subcontractor who may be doing work in the County.

General Contractor/Developer: _____

License Number: _____

Subcontractor: _____

License Number: _____ Start Date: _____

Scope of Work: _____ Percent of Work: _____

Subcontractor: _____

License Number: _____ Start Date: _____

Scope of Work: _____ Percent of Work: _____

Subcontractor: _____

License Number: _____ Start Date: _____

Scope of Work: _____ Percent of Work: _____

Subcontractor: _____

License Number: _____ Start Date: _____

Scope of Work: _____ Percent of Work: _____

Subcontractor: _____

License Number: _____ Start Date: _____

Scope of Work: _____ Percent of Work: _____

cc: Rockdale County Department of Transportation
Rockdale County Department of Finance

NON-COLLUSION AFFIDAVIT OF SUBCONTRACTOR

State of _____)

County of _____)

_____, being first duly sworn, deposes, and says that:

1. He is _____ (Owner, Partner, Officer, Representative, or Agent) of _____, hereinafter referred to as the "Subcontractor";
2. He is fully informed respecting the preparation and contents of the Subcontractor's Proposal submitted by the Subcontractor to _____, the Contractor, for certain work in connection with the _____ Contract pertaining to the Project in Rockdale County, Georgia;
3. Such Subcontractor's Proposal is genuine and is not a collusive or sham Proposal;
4. Neither the Subcontractor nor any of its officers, partners, owners, agents, representatives, employees, or parties in interest, including this affiant, has in any way colluded, conspired, connived, or agreed, directly or indirectly, with any other Bidder, firm or person to submit a collusive or sham Proposal in connection with such Contract or to refrain from submitting a Proposal in connection with such Contract or has in any manner, directly or indirectly, sought by unlawful agreement or connivance with any other Bidder, firm, or person to fix the price or prices in said Subcontractor's Proposal, or to secure through collusion, conspiracy, connivance, or unlawful agreement any advantage against Rockdale County or any person interested in the proposed Contract; and,
5. The price or prices quoted in the Subcontractor's Proposal are fair and proper and are not tainted by any collusion, conspiracy, connivance, or unlawful agreement on the part of the Bidder or any of its agents, representatives, owners, employees, or parties in interest, including this affiant.

(Signed) _____

Name _____ (Print)

Title _____

Subscribed and Sworn to before me

this ____ day of _____, 202__.

_____ (SEAL)

Title

FINAL AFFIDAVIT

TO: ROCKDALE COUNTY, GEORGIA

I, _____, hereby certify that all suppliers of materials, equipment and service, Subcontractors, mechanics, and laborers employed by _____ or any of his Subcontractors in connection with the construction of

Furnishing all labor, materials and equipment for the reconstruction of Sigman Road, in Rockdale County. The project will widen and improve approximately 1.26 miles of Sigman Road from just east of Lester Road to just east of Irwin Bridge Road. Sigman Road would be widened from two lanes to four 12-ft travel lanes with a 20-ft. raised median. The left shoulder will consist of an 18-ft. urban shoulder with a 10-ft. concrete multi-use path and the right shoulder will consist of a 12-ft. urban shoulder with a 5-ft. concrete sidewalk. There will be signals installed at the intersections of Sigman Rd @ Rockbridge Road; and Sigman Road @ Irwin Bridge Road. P.I. # 0012886 is for the construction of the 10-ft concrete multi-use path on the north side of Sigman Road. This project is located in central Rockdale County and partially in the City of Conyers.

in ROCKDALE COUNTY have been paid and satisfied in full as of _____, 201__, and that there are no outstanding obligations or claims of any kind for the payment of which Rockdale County on the above named project might be liable, or subject to, in any lawful proceeding at law or in equity.

Signature _____

Title _____

Personally appeared before me this _____ day of _____, 202__.

_____, who under oath deposes and says that he is of the firm of _____ that he has read the above statement and that to the best of his knowledge and belief same is an exact true statement.

Notary Public _____

My Commission Expires _____

Date _____

CONTRACT SCHEDULE OF ITEMS

Furnishing all labor, materials and equipment for the reconstruction of Sigman Road, in Rockdale County. The project will widen and improve approximately 1.26 miles of Sigman Road from just east of Lester Road to just east of Irwin Bridge Road. Sigman Road would be widened from two lanes to four 12-ft travel lanes with a 20-ft. raised median. The left shoulder will consist of an 18-ft. urban shoulder with a 10-ft. concrete multi-use path and the right shoulder will consist of a 12-ft. urban shoulder with a 5-ft. concrete sidewalk. There will be signals installed at the intersections of Sigman Rd @ Rockbridge Road; and Sigman Road @ Irwin Bridge Road. P.I. # 0012886 is for the construction of the 10-ft concrete multi-use path on the north side of Sigman Road. This project is located in central Rockdale County and partially in the City of Conyers.

**Contract
Scope:**

Vendor: _____

Signature: _____

**A COPY OF THE BID SCHEDULE WILL BE DUPLICATED AS PART OF
THE CONTRACT.**

END OF SECTION