



Code Compliance Research Report

CCRR-0177

Subject to Renewal: 04/11/2018
Visit www.ati-es.com for current status

Issued: 04/18/2017
Page 1 of 6

TAMKO Building Products
220 West 4th Street
Joplin, Missouri 64801
(800) 641-4691

www.tamko.com

1.0 Subject

EverGrain® Decking – 1x6 and 2x6

2.0 Research Scope

2.1. Building Codes:

2009, 2012, 2015 International Building Code (IBC)

2009, 2012, 2015 International Residential Code (IRC)

2.2. Properties:

Structural Performance

Durability

Surface Burning

Decay Resistance

Termite Resistance

3.0 Description

3.1. General – *EverGrain*® boards are intended for use as a walking surface on exterior decks, balconies, porches, and walkways, including stairs as described further herein.

3.1.1. Materials and Processes – *EverGrain*® boards are a compression molded composite material comprised of part wood fiber and part plastic in the following colors: Redwood, Cedar, Weathered Wood, Cape Cod Grey, and Forest Green.

3.2. *EverGrain*® 1x6 board is produced in both solid and grooved rectangular profiles and is a nominal 1 inch thick and 5.5 inches wide. The 2x6 board is produced in a solid rectangular profile and is a nominal 1.4" inches thick and 5.5 inches wide. See Figure 1 and Figure 2.

3.3. Walking Surface – All *EverGrain*® boards use an embossed simulated wood-grain pattern on the walking surface.

4.0 Performance Characteristics

4.1. The *EverGrain*® 1x6 and *EverGrain*® 2x6 boards are rated for the uniform live loads and snow loads as identified in Table 1.

4.2. Both the *EverGrain*® 1x6 and 2x6 boards may be used as stair treads when installed in a minimum two-span condition and are rated for the code-prescribed concentrated load equal to 300 lb. when installed with a maximum span as shown in Table 1.

4.3. *EverGrain*® boards have wind uplift resistance ratings as determined by the fastening method. See Table 2.

4.4. Composite materials used have a flame spread index of 90 when tested in accordance with ASTM E 84. The referenced criteria, AC174, requires the material to have a flame spread index not greater than 200 when tested according to ASTM E 84.

4.5. Materials used are deemed equivalent to preservative treated or naturally durable wood for resistance to weathering effects, attack from Formosan termites, and fungus decay.

4.6. Structural performance has been demonstrated for a temperature range from -20°F to 125°F for live load and -20°F to 70°F for snow load.

5.0 Installation

Installation shall be in accordance with the manufacturer's installation instructions and this report. Where differences occur between this report and the manufacturer's installation instructions, this report shall govern.

5.1. *EverGrain*® 1x6 solid boards are face-fastened with two #10 x 2-1/2" TrapEase® composite deck screws at each support. Minimum edge distance for fasteners is 1.0 inch from the board edge, and minimum end distance for fasteners is 0.75 inch from the end of each board. See Table 1 and Table 2.

5.2. *EverGrain*® 1x6 grooved boards are secured at each joist with the hidden fasteners as specified in Table 2. The first and last *EverGrain*® grooved deck boards are face fastened using fasteners as identified in Table 2 for the equivalent solid deck board. Fasteners must be

spaced so that no part of the fastener is within 1.375 inches from the board edge, and at least 0.75 inch from the end of each board.

5.3. *EverGrain*® 2x6 solid boards are fastened with two #10 x 3" *TrapEase*® composite deck screws at each support. Minimum edge distance for fasteners is 1.0 inch from the board edge, and minimum end distance for fasteners is 0.75 inch from the end of each board. See Table 1 and Table 2.

5.4. *EverGrain*® 1x6 and 2x6 solid boards may be installed with the EG 1-2-3 hidden fastener system. The EG 1-2-3 hidden fastener is comprised of a painted metal clip attached to the bottom surface of the deck board which is then attached to the joist. See Table 1 and Table 2.

6.0 Supporting Evidence

6.1. Manufacturer's drawings and installation instructions

6.2. Reports of testing and engineering demonstrating compliance with ICC-ES AC174, Acceptance Criteria for Deck Board Span Ratings and Guardrail Systems (Guards and Handrails), Revised February 2014 and ASTM D 7032-08.

6.3. Engineering calculations for snow load analysis by licensed Professional Engineer.

6.4. Documentation of an approved quality control system for the manufacturing of products recognize in this report.

7.0 Conditions of Use

7.1. The *EverGrain*® board applications identified in this report are deemed to comply with the intent of the provisions of the referenced building codes are subject to the following conditions:

7.2. The The deck boards identified in this report may be used in One- and Two-Family Dwellings regulated by the IRC and other construction types regulated by the IBC in accordance with IBC Section 1406.3 as follows:

7.3. Construction Type IIB, IIIB & VB per IBC §1406.3 and Table 601 (No fire resistance rating required for floors)

7.4. Construction Type IIIA, IV & VA per IBC §1406.3, Exception 3 (Sprinkler protection required)

7.5. Boards placed at an angle other than 90 degrees to the supporting joist will require support framing at a reduced spacing such that the span of the deck board does not exceed 17 inches for *EverGrain*® 1x6 boards and 24 inches for *EverGrain*® 2x6 boards.

7.6. The wind uplift resistance rating recognized in this report is based on attachment to treated Southern Pine framing (specific gravity, G=0.55). Installation on wood framing with a lesser specific gravity may result in a lower wind uplift rating.

7.7. Where required by the building official, engineering calculations and details shall be provided. The calculations shall verify that the anchorage complies with the building code for the type of framing and condition of the supporting construction.

7.8. Compatibility of the supporting construction materials with all fasteners is subject to approval by the code official.

7.9. Only those types of fasteners and fastening methods described in this report have been evaluated for the installation of the *EverGrain*® boards; other methods of attachment are outside the scope of this report.

7.10. All products are manufactured in Lamar, Missouri by TAMKO Building Products in accordance with the manufacturer's approved quality control system with inspections by PFS Corporation (IAS AA-652).

8.0 Identification

Boards produced in accordance with this report shall be identified with labeling on the individual deck boards that includes the following information:

8.1. Name and/or trademark of manufacturer;

8.2. The name and/or mark of the independent inspection agency, PFS Corporation, Inc.

8.3. The Architectural Testing Code Compliance Research Report identification and number (ATI CCRR-0177); and

8.4. The following statement: "ASTM D 7032 compliant. See CCRR-0177 at www.ati-es.com for uses and performance levels."

9.0 Code Compliance Research Report Use

9.1. Approval of building products and/or materials can only be granted by a building official having legal authority in the specific jurisdiction where approval is sought.

9.2. Code Compliance Research Reports shall not be used in any manner that implies an endorsement of the product or manufacturer by Architectural Testing.

9.3. Reference to the Architectural Testing internet web site address at www.ati-es.com is recommended to ascertain the current version and status of this report.

Table 1 – Span / Load Ratings and Stair Tread Support Spacing

EverGrain® Board	Span / Load Ratings			Stair Tread Support Spacing ⁽²⁾ (in)
	Live Load (in / lb/ft ²)	Snow Load ⁽¹⁾ (in / lb/ft ²)		
1x6 Solid	17 / 100	17 / 250	14 / 350	12
	12 / 296			
1x6 Grooved	17 / 100	17 / 250	14 / 350	N/A
2x6	24 / 100	24 / 250	20 / 350	16

⁽¹⁾ The maximum allowable loads indicated include applicable end use factors. No additional adjustments should be taken.

⁽²⁾ Continuous two-span installation.

Table 2 – Uplift Resistance Rating

EverGrain® Board	Support Spacing (in)	Fastener ⁽¹⁾	Uplift Resistance (lb/ft ²)
1x6 Grooved	16	Tiger-Claw TC-G Hidden Fastener System	145
		EverClip Hidden Fastener	326
1x6 Solid	16	#10 x 2-1/2" TrapEase® Composite Deck Screw	455
		EG 1-2-3 Hidden Fastener System	117
2x6	24	#10 x 3" TrapEase® Composite Deck Screw	322
		EG 1-2-3 Hidden Fastener System	94

⁽¹⁾ As described in Table 3 below.

Table 3 – Fastener Description

Generic Fastener Description	Uses	Detailed Fastener Description
#10 x 2-1/2" TrapEase® Composite Deck Screw	Face fastening for 1x6 (see Section 5.1)	11 TPI with a 0.75 in length of reverse pitch, 2.51 in overall length, 0.190 in major dia., 0.145 in shank dia., 0.315 in head dia., square drive trim head, type A point
#10 x 3" TrapEase® Composite Deck Screw	Face fastening for 2x6 (see Section 5.2)	11 TPI with a 0.80 in length of reverse pitch, 2.98 in overall length, 0.190 in major dia., 0.145 in shank dia., 0.315 in head dia., square drive trim head, type A point
EG 1-2-3 (Figure 3)	Hidden Fastening Clips for solid deck boards (see Section 5.4)	Painted metal clip – attached to joist with one #6 x 1-1/2 in. screw, 12 TPI with an 1.47 in overall length, 0.145 in major dia., 0.088 in shank dia., 0.261 in head dia., square drive trim head, Type 17 point -- attached to underside of deck board with one #6 x 3/4" screw, 12 TPI, 0.73 in overall length, 0.145 in major dia., 0.088 in shank dia., 0.261 in head dia., square drive trim head, Type 17 point
TigerClaw TC-G Hidden Fastener System (Figure 4)	Hidden Fastening Clips for 1x6 grooved deck boards	Clips are attached to joists with a 1.63 in. long stainless steel screw (0.164 in. major dia., 0.113 in. minor dia., 0.229 in. dia.)
EverClip Hidden Fastener (Figure 5)	Hidden Fastening Clips for 1x6 grooved deck boards	Clips are attached to joists with one #10 x 2-1/2" deck screw (8 TPI, 0.179 in. major dia., 0.126 in. shank dia., 0.323 in. head dia., Phillips drive, trim head, Type A point)

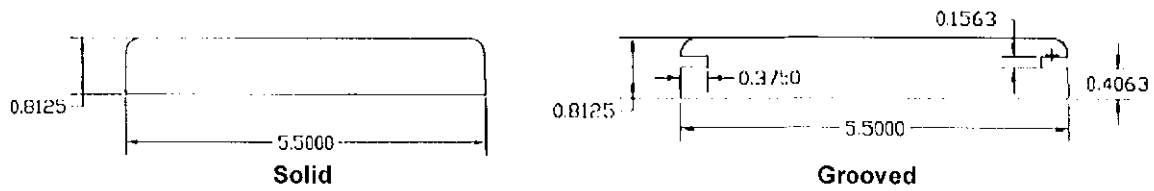
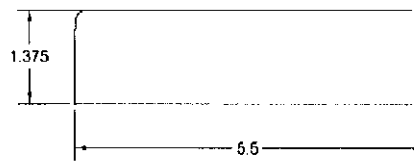
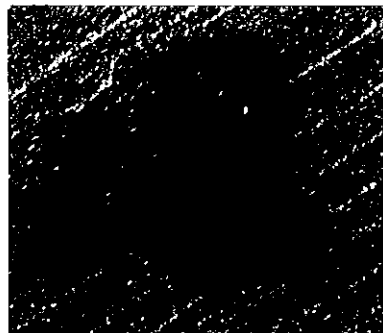
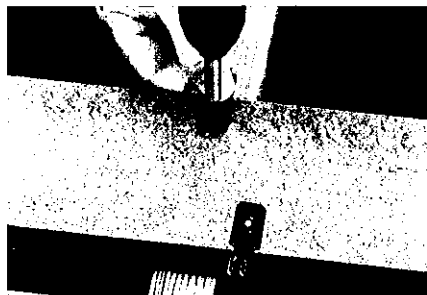
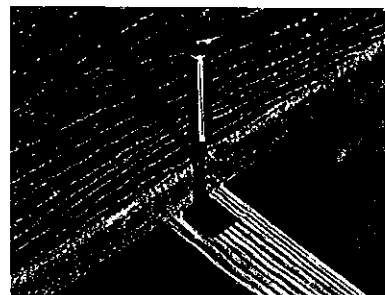
Figure 1 – EverGrain® 1x6 Board

Figure 2 – EverGrain® 2x6 Board

EG 1-2-3 Hidden Fastener System with Fasteners

Hidden Fastener Installation to Bottom Surface of Board

Hidden Fastener Installation to Joist
Figure 3 – EG 1-2-3 Hidden Fastener System

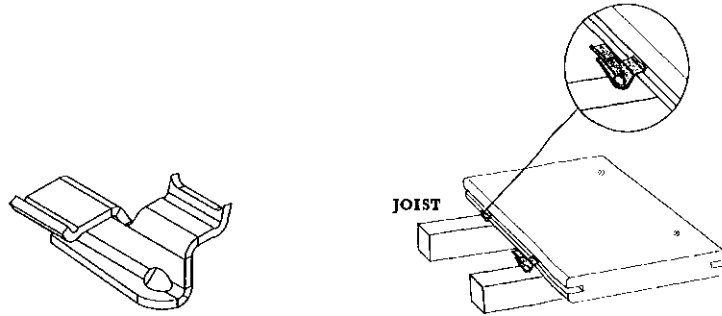

Figure 4 – FastenMaster TC-G Clips

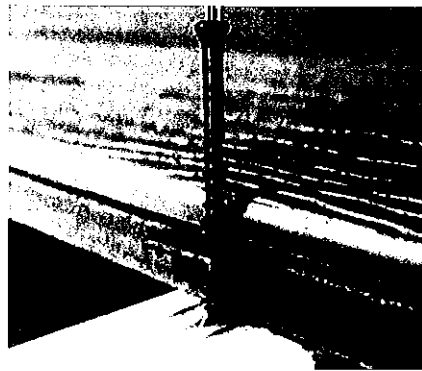

Figure 5 – EverClip Hidden Fastener System