

BIDDING AND CONTRACT DOCUMENTS

ITB 17-039

**MARTIN LUTHER KING JR. BOULEVARD SIDEWALK
EXTENSION
HIGHLANDS COUNTY PROJECT NO. 15005**



**ENGINEERING DEPARTMENT
505 S. COMMERCE AVENUE
SEBRING, FLORIDA
(863) 402-6877**

August 2017

**MARTIN LUTHER KING JR. BOULEVARD SIDEWALK
EXTENSION**

**HIGHLANDS COUNTY PROJECT NO. 15005
TABLE OF CONTENTS
ITB 17-039**

DIVISION 0 – BIDDING AND CONTRACT DOCUMENTS

SECTION 00010 - INVITATION TO BID

SECTION 00100 - INSTRUCTIONS TO BIDDERS

SECTION 00160 - CERTIFICATION PURSUANT TO SECTION 287.135, FLORIDA
STATUTES

SECTION 00250 - GENERAL TERMS AND CONDITIONS

SECTION 00300 - BID FORM

SECTION 00410 - BID BOND

SECTION 00500 - AGREEMENT

SECTION 00600 - PUBLIC CONSTRUCTION BOND

SECTION 00700 - STANDARD GENERAL CONDITIONS

SECTION 00800 - SUPPLEMENTARY CONDITIONS

EXHIBIT A – DRAWINGS AND SPECIFICATIONS FOR MARTIN LUTHER KING JR.
BOULEVARD SIDEWALK EXTENSION: PROJECT NO. 15005



HIGHLANDS COUNTY
BOARD OF COUNTY COMMISSIONERS
Purchasing Division

SECTION 00010
INVITATION TO BID (“ITB”)
ITB 17-039

The Board of County Commissioners (“Board”) of Highlands County, Florida (“County”) will receive sealed Bids in the Highlands County Purchasing Division (“Purchasing Division”) for:

ITB – 17-039 MARTIN LUTHER KING JR. BOULEVARD SIDEWALK EXTENSION
PROJECT NO.: 15005

Construction Documents may be obtained by downloading from our website: www.hbcc.net, or by contacting: Danielle Gilbert, Purchasing Division Manager; 4320 George Blvd., Sebring, Florida 33875-5803; Phone: 863-402-6524; Fax: 863-402-6735; or Email: dgilbert@hbcc.org.

A **NON-MANDATORY PRE-BID meeting will be held at 2:00 P.M. on Wednesday, September 6, 2017** in the County Engineering Training Room, 505 South Commerce Avenue, Sebring, Florida 33870. The purpose of this meeting is to provide a forum where the Bidders can familiarize themselves with the Specifications of the Project with County staff and the Engineer. The Public is invited to attend this meeting.

Each submittal shall include **one (1) original, one (1) exact paper copy and one (1) exact electronic copy (CD or thumb drive)** of the Bid submission packet. **BIDS MUST BE DELIVERED** to the Purchasing Division, 600 S. Commerce Ave., Sebring, FL 33870 no later than **4:00 P.M., Thursday, September 14, 2017** at which time they will be opened. The public is invited to attend this meeting. Bid envelopes must be sealed and marked with the ITB number and name to identify the enclosed Bid. Bids received later than the date and time specified will be rejected. The County will not be responsible for the late deliveries of Bids that are incorrectly addressed, delivered in person, by mail or any other type of delivery service.

One or more County Commissioners may be in attendance at the Pre-Bid meeting.

The Board’s Local Preference Policy (“Local Preference Policy”) will apply to the award of this ITB.

The County reserves the right to accept or reject any or all Bids or any parts thereof, and the determination of this Award, if an Award is made, will be made to the most responsive and responsible Bidder whose Bid and qualifications indicate that the Award will be in the best interest of the County. The County reserves the right to waive irregularities in the Bid.

A Bidder must submit a Bid on all Work to receive consideration. A Bid Bond or Cashier’s Check in an amount of five percent (5%) of the Bid must be included on Bids over one hundred thousand dollars (\$100,000.00). If the successful Bid is greater than two hundred thousand dollars (\$200,000.00), a Public

Construction Bond will be required. An Irrevocable Letter of Credit may be considered in lieu of the Public Construction Bond depending on its verbiage. The Bidder must be a Licensed General Contractor in the State of Florida. The Bid must be accompanied by evidence of the Bidder's qualifications to do business in the State of Florida, in accordance with Chapter 489, Florida Statutes.

The principal features of the Project are:

The Project consists of providing all labor, materials and equipment to construct the MARTIN LUTHER KING JR. BOULEVARD SIDEWALK EXTENSION: PROJECT NO. 15005. The Work consists of constructing approximately two thousand five hundred eighty-four (2,584) linear feet of sidewalk. Contractor will have sixty (60) days to complete the Project after the date when the Contract Times commence to run.

The Board, does not discriminate upon the basis of any individual's disability status. This non-discrimination policy involves every aspect of the Board's functions, including one's access to, participation, employment or treatment in its programs or activities. Anyone requiring reasonable accommodation as provided for in the Americans with Disabilities Act or Section 286.26, Florida Statutes, should contact Ms. Pamela Rogers, ADA Coordinator at: 863-402-6509 (Voice), or via Florida Relay Service 711, or by e-mail: progers@hcbcc.org. Requests for CART or interpreter services should be made at least 24 hours in advance to permit coordination of the service.

Board of County Commissioners, Purchasing Division
Highlands County, FL

Website: www.hcbcc.net

SECTION 00100
INSTRUCTIONS TO BIDDERS
ITB 17-039

Article 1. - Defined Terms

- 1.01 Terms used in these Instructions to Bidders have the meanings indicated below and in Section 00700 of this ITB which are applicable to both the singular and plural thereof:
- A. Alternative – Amount proposed by Bidder and stated on the Bid Form that will be added to or deducted from the base Bid amount if Engineer decides to accept a corresponding change in either Scope of Work or in products, materials, equipment, systems or installation methods described in Construction Documents.
 - B. Award - The selection by the County of the lowest responsible and responsive Bidder to perform the Work.
 - C. Bid - The Bid Form and other documents submitted by a Bidder in response to this ITB.
 - D. Bidder - The individual or entity who submits a Bid directly to the County.
 - E. Bid Form - Section 00300 of this ITB, which shall be used to submit a Bid.
 - F. Bidding Documents - This ITB, all Addenda to this ITB, and the Construction Documents.
 - G. Board - County’s Board of County Commissioners.
 - H. County Attorney - The County’s County Attorney.
 - I. Construction Documents - The construction Drawings and Specifications for the MARTIN LUTHER KING JR. BOULEVARD SIDEWALK EXTENSION: PROJECT NO. 15005, dated June 19, 2017, consisting of seventeen (15) sheets.
 - J. County Engineer - The County’s County Engineer.
 - K. County or Owner - Highlands County, a political subdivision of the State of Florida.
 - L. Engineer - The Engineer of Record.
 - M. Purchasing Division - The County’s Purchasing Division, which issues Bidding Documents and administers the bidding procedures.
 - N. Site - The Site described and depicted in the Construction Documents.
 - O. Work - The Work described and depicted in the Construction Documents.

Article 2. - Copies of Bidding Documents

- 2.01 Complete sets of the Bidding Documents in the number and for the deposit sum, if any, stated in the Advertisement or this ITB may be obtained from the Purchasing Division.
- 2.02 Complete sets of Bidding Documents must be used in preparing Bids; neither Owner nor Engineer assume any responsibility for errors or misinterpretations resulting from the use of incomplete sets of Bidding Documents.
- 2.03 Owner and Engineer in making copies of Bidding Documents available on the above terms do so only for the purpose of obtaining Bids for the Work and do not confer a license or grant for any other use.

Article 3. - Qualifications of Bidders

- 3.01 To demonstrate Bidder's qualifications to perform the Work, Bidder shall submit detailed written evidence with the Bid Form as follows:
 - A. A list of a minimum of five (5) jobs that the Bidder has performed within the past three (3) years which are of equal magnitude and complexity as the type of work to be done for the Owner. The list should include the name of the entity, complete address, name, phone number, fax, and email of a responsible individual qualified to respond to questions concerning the Bidder's abilities, costs, schedules, etc. Prior successful, on-time accomplishment of such equal work will be a consideration in determining whether the Bidder is qualified to perform the Work.
 - B. Supervisory and staffing capabilities with resumes of supervisory personnel planned for the Work and the number and classification of personnel required per shift.
 - C. List of equipment available for use on this Project. Identify if equipment is owned or leased.
 - D. A minimum of five (5) references of clients for whom similar work has been performed.
- 3.02 Each Bid must contain evidence of Bidder's qualification to do business in the State of Florida, in accordance with Chapter 489, Florida Statutes.
- 3.03 In addition, to demonstrate Bidder's qualifications to perform the Work, within ten (10) days and prior to Notice of Award, Bidder shall submit detailed written evidence such as financial data (note if financial data is considered confidential it must be marked as such) and other such data as may be called for below:
 - A. A listing of all Subcontractors is required when the subcontract value exceeds ten percent (10%) of the total contract amount. Provide experience statements for these Subcontractors.
 - B. List of present commitments (workload), including name of project, location, and value of contract.

3.04 Each Bid must contain proof of enrollment in E-Verify.

Article 4. - Examination of Bidding Documents, Other Related Data, and Site

4.01 Subsurface and Physical Conditions known to Owner are shown in the Construction Documents. No Site specific subsurface studies have been done.

4.02 Underground Facilities known to Owner are shown on the Construction Documents. No Site specific utility locates have been done.

4.03 No Hazardous Environmental Condition has been identified at the Site.

4.04 Provisions concerning responsibilities for the adequacy of data furnished to prospective Bidders with respect to subsurface conditions, other physical conditions and Underground Facilities, and possible changes in the Contract Documents due to differing or unanticipated conditions appear in Paragraphs 5.03, 5.04, and 5.05 of Section 00700 Standard General Conditions of the Construction Contract as modified in Section 00800 Supplementary Conditions of the Contract Documents. Provisions concerning responsibilities for the adequacy of data furnished to prospective Bidders with respect to Hazardous Environmental Conditions at the Site, if any, and possible changes in the Contract Documents due to Hazardous Environmental Conditions uncovered or revealed at the Site which were not shown or indicated in the Drawings or Specifications or identified in the Contract Documents to be within the scope of the Work appear in Paragraph 5.06 of Section 00700 Standard General Conditions of the Construction Contract as modified in Section 00800 Supplementary Conditions of the Contract Documents.

4.05 On request, the Purchasing Division will provide Bidder access to Site to conduct such examinations, investigations, explorations, tests, and studies, as Bidder deems necessary for submission of a Bid. Bidder shall fill all holes and clean up and restore the Site to its former conditions upon completion of such explorations, investigations, tests, and studies.

4.06 On request, the Purchasing Division will provide to each Bidder for examination access to or copies of Contract Documents (other than portions thereof related to price) for such other work.

4.07 It is the responsibility of each Bidder before submitting a Bid to:

- A. Examine and carefully study the Bidding Documents, including any Addenda and the other related data identified in the Bidding Documents;
- B. Visit the Site and become familiar with and satisfy Bidder as to the general, local, and Site conditions that may affect cost, progress, and performance of the Work;
- C. Become familiar with and satisfy Bidder as to all federal, state, and local Laws and Regulations that may affect cost, progress, or performance of the Work;
- D. Carefully study all drawings of physical conditions in or relating to existing surface or subsurface structures at or contiguous to the Site;

- E. Obtain and carefully study (or assume responsibility for doing so) all additional or supplementary examinations, investigations, explorations, test, studies, and data concerning conditions (surface, subsurface, and Underground Facilities) at or contiguous to the Site which may affect cost, progress, or performance of the Work or which relate to any aspect of the means, methods, techniques, sequences, and procedures of construction to be employed by Bidder, including any specific means, methods, techniques, sequences, and procedures of construction expressly required by the Bidding Documents, and safety precautions and programs incident thereto;
 - F. Agree at the time of submitting its Bid that no further examinations, investigations, explorations, tests, studies, or data are necessary for the determination of its Bid for performance of the Work at the price bid and within the times and in accordance with the other terms and conditions of the Bidding Document;
 - G. Become aware of the general nature of the Work to be performed by Owner and others at the Site that relates to the Work as indicated in the Bidding Document;
 - H. Correlate the information known to Bidder, information and observations obtained from visits to the Site, reports and drawings identified in the Bidding Documents, and all additional examinations, investigations, explorations, tests, studies, and data with the Bidding Documents;
 - I. Promptly give Engineer and the Purchasing Division written notice of all conflicts, errors, ambiguities, or discrepancies that Bidder discovers in the Bidding Documents and confirm that the written resolution thereof by Engineer and the Purchasing Division is acceptable to Bidder; and
 - J. Determine that the Bidding Documents are generally sufficient to indicate and convey understanding of all terms and conditions for the performance of the Work.
- 4.08 The submission of a Bid will constitute an incontrovertible representation by Bidder that Bidder has complied with every requirement of this Article 4, that without exception the Bid is premised upon performing and furnishing the Work required by the Bidding Documents and applying any specific means, methods, techniques, sequences, and procedures of construction that may be shown or indicated or expressly required by the Bidding Documents, that Bidder has given Engineer and the Purchasing Division written notice of all conflicts, errors, ambiguities, and discrepancies that Bidder has discovered in the Bidding Documents and the written resolutions thereof by Engineer and the Purchasing Division are acceptable to Bidder, and that the Bidding Documents are generally sufficient to indicate and convey understanding of all terms and conditions for performing and furnishing the Work.

Article 5. - Pre-Bid Meeting

- 5.01 There will be a **NON-MANDATORY** Pre-Bid Meeting as specified in ITB Section 00010 at the County Engineering Training Room, 505 South Commerce Ave., Sebring, FL 33870.

Article 6. - Site and Other Areas

6.01 The Site is identified in the Bidding Documents. All additional lands and access thereto required for temporary construction facilities, construction equipment, or storage of materials and equipment to be incorporated in the Work is to be obtained and paid for by the Contractor. Easements for permanent structures or permanent changes in existing facilities are to be obtained and paid for by Owner unless otherwise provided in the Bidding Documents.

Article 7. - Interpretation and Addenda

7.01 All questions about the meaning or intent of the Bidding Documents are to be directed to the Purchasing Division. Interpretations or clarifications considered necessary by the Purchasing Division and Engineer in response to such questions will be issued by Addenda and will be mailed, emailed, or delivered to all parties recorded by the Purchasing Division as having received the Bidding Documents. (RFI) Request for Information received after a set date may not be answered. Only RFI answered by formal written Addenda will be binding. Oral and other interpretations or clarifications will be without legal effect.

7.02 Addenda may be issued to clarify, correct, or change the Bidding Documents as deemed advisable by Owner, Engineer or the Purchasing Division.

7.03 Addenda(s) will be posted to the County's website; www.hcbcc.net. It is the sole responsibility of the Bidder to frequently check the County's website for Addenda.

Article 8. - Bid Security

8.01 A "Bid Bond" or Cashier's Check, in the amount of five percent (5%) of the Bid, must be included on each Bid over one hundred thousand dollars (\$100,000.00). If the successful Bid is greater than two hundred thousand dollars (\$200,000.00) a "Public Construction Bond" of not less than one hundred percent (100%) of the Awarded Bid amount will be required. All Bonds must be in a form acceptable to Owner and County Attorney.

8.02 Within thirty (30) days after the Award, Owner will return the bid securities to all Bidders whose Bids are not to be further considered in awarding the Contract. Retained bid securities will be held until the Agreement has been finally executed, after which all bid securities, other than Bidder's bond and any guarantees which have been forfeited, will be returned to the respective Bidders whose Bids they accompanied.

Article 9. - Contract Times

9.01 The number of days within which, or the dates by which, the Work is to be (a) Substantially Completed and, (b) also completed and ready for final payment are set forth in the Bid Form.

Article 10. - Liquidated Damages

10.01 Provisions for liquidated damages, if any, are set forth in the Agreement.

Article 11. - Substitute or "Or-Equal" Items

11.01 The Contract, if awarded, will be on the basis of materials and equipment described in the Bidding Documents with consideration of possible substitute or "or-equal" items if allowed within the Bidding Documents. Whenever it is specified or described in the Bidding Documents that a substitute or "or-equal" item of material or equipment may be furnished or used by Contractor if acceptable to Engineer, application for such acceptance will be considered by Engineer during the allotted time frame for Request for Information (RFI).

Article 12. - Subcontractors, Suppliers and Others

12.01 The apparent successful Bidder, and any other Bidder so requested, shall within five (5) days after Bid opening, submit to Owner a list of all proposed contractors, Suppliers, individuals, or entities proposed for those portions of the Work for which such identifications are required. Such list shall be accompanied by an experience statement with pertinent information regarding similar projects and other evidence of qualification for each Subcontractor, Supplier, individual, or entity if requested by Owner. If Owner, Engineer or the Purchasing Division after due investigation, has reasonable objection to any proposed Subcontractor, Supplier, individual, or entity, Owner may, before the Notice of Award is given, request apparent successful Bidder to submit a substitute, without an increase in the Bid.

12.02 If the apparent successful Bidder declines to make any such substitution, Owner may Award the Contract to the next lowest Bidder that proposes to use acceptable Subcontractors, Suppliers, individuals, or entities. Declining to make requested substitutions will not constitute grounds for forfeiture of the bid security of any Bidder. Any Subcontractor, Supplier, individual, or entity so listed and against which Owner, Engineer or the Purchasing Division makes no written objection prior to giving of the Notice of Award will be deemed acceptable to all indicated parties subject to revocation of such acceptance after the Effective Date of the Contract as provided in Paragraph 7.06 of Section 00700 Standard General Conditions of the Construction Contract as modified in Section 00800 Supplementary Conditions of the Contract Documents.

12.03 Contractor shall not be required to employ any Subcontractor, Supplier, individual, or entity against whom Contractor has reasonable objection.

12.04 It is the responsibility of the Contractor to insure that all Subcontractors comply with all insurance requirements.

Article 13. - Bid Form

13.01 Bidder shall use and/or make necessary copies of Section 00300 "Bid Form" of this ITB for their Submittal Document(s).

- 13.02 All blanks on the Bid Form shall be completed by printing in black ink or by typewriter and the Bid Form shall be signed. A Bid Price shall be indicated for each unit price item listed therein, if applicable, or the words “No Bid”, “No Change”, or “Not Applicable” entered. All names shall be typed or printed below the signature line with all signatures in blue ink.
- 13.03 A Bid by a corporation shall be executed in the corporate name by the president or a vice president or other corporate officer accompanied by evidence of authority to sign. The corporate seal shall be affixed and attested by the secretary or an assistant secretary. The corporate address and state of incorporation shall be shown below the signature.
- 13.04 A Bid by a partnership shall be executed in the partnership name and signed by a partner (whose title must appear under the signature), accompanied by evidence of authority to sign. The official address of the partnership and state of organization and type of partnership shall be shown below the signature
- 13.05 A Bid by a limited liability company shall be executed in the name of the firm by a member and accompanied by evidence of authority to sign. The state of formation of the firm and the official address of the firm must be shown below the signature.
- 13.06 A Bid by an individual shall show the Bidder’s name and official address, telephone number, fax number, and email address.
- 13.07 A Bid by a joint venture shall be executed by each joint venture in the manner indicated on the Bid Form. The official address of the joint venture must be shown below the signature.
- 13.08 The Bid shall contain an acknowledgment of receipt of all Addenda, the numbers of which shall be filled in on the Bid Form.
- 13.09 All Bid Forms shall have the name, official address, telephone number, fax number, and email address for communications regarding the Bid.
- 13.10 Attachments to the Bid Form shall include the following:
- A. Documentation as required in Article 3 of this Section including a copy of Contractors License.
 - B. All insurances from both Contractor and Subcontractor (if applicable) required to fulfill the obligations of this project.

Article 14. - Basis of Bid; Evaluation of Bids

- 14.01 Bidders shall submit a Bid on a Lump Sum and Unit Price basis as noted on the Bid Form for the Work listed in these Bid Documents.

14.02 The Bid price shall include such amounts as the Bidder deems proper for overhead and profit on account of cash allowances.

Article 15. - Submittal of Bid

15.01 Each prospective Bidder is furnished one copy of the Bidding Documents and if required, the Bid Bond Section 00410 of this ITB. An unbound copy of the Bid Form is to be completed and submitted with the bid security and the following data:

- A. A current copy of Bidder's Certificate of Insurance and a statement of Bidder's ability to acquire the insurance limits and requirements stated in Paragraphs 6.2 and 6.3 of Section 00700 Standard General Conditions of the Construction Contract as modified in Section 00800 Supplementary Conditions of the Contract Documents.
- B. An executed Statement of Indemnification.
- C. Acknowledgement of Addenda (if applicable).
- D. All documentation from Subcontractors (if applicable) including their ability to acquire the insurance limits and requirements stated in Paragraphs 6.2 and 6.3 of Section 00700 Standard General Conditions of the Construction Contract as modified in Section 00800 Supplementary Conditions of the Contract Documents.

15.02 A Bid shall be submitted no later than the date and time prescribed and at the place indicated in the advertisement or Invitation to Bid and shall be enclosed in a sealed opaque envelope or package plainly marked with the Bid #, Bid /Project Title (and, if applicable, the designated portion of the Project for which the Bid is submitted), the name and address of Bidder, and shall be accompanied by the bid security and other required documents. If a Bid is sent by mail or other delivery system, the sealed envelope containing the Bid shall be enclosed in a separate envelope plainly marked on the outside with the notation BID ENCLOSED - ITB 17-039 - " MARTIN LUTHER KING JR. BOULEVARD SIDEWALK EXTENSION: PROJECT NO. 15005". A mailed Bid shall be addressed to the Highlands County BCC; Attn: Purchasing Division, 4320 George Boulevard, Sebring, FL 33875-5803.

Article 16. - Modification and Withdrawal of Bids

16.01 Prior to the date and time for the opening of Bids, a Bid may be modified or withdrawn by an appropriate document duly executed in the manner that a Bid must be executed and delivered to the place where Bids are to be submitted.

Article 17. - Opening of Bids

17.01 Bids will be opened at the time and place indicated in the advertisement or ITB Section 00010 and, unless obviously non-responsive, read aloud publicly. An abstract of the amounts of the base Bids

and major alternates, if any, will be made available to Bidders after the opening of Bids by means of a copy of the "Bid Opening Sheet."

Article 18. - Bids to Remain Subject to Acceptance

18.01 All Bids will remain subject to acceptance for the period of time stated in the Bid Form and as allowed by Section 119.071, Florida Statutes, but Owner may, in its sole discretion, release any Bid and return the bid security prior to the end of this period.

Article 19. - Award of Contract

19.01 Owner reserves the right to reject any or all Bids, including without limitation, non-conforming, non-responsive, unbalanced, or conditional Bids. Owner further reserves the right to reject the Bid of any Bidder that it finds, after reasonable inquiry and evaluation, to be non-responsible. Owner may also reject the Bid of any Bidder if Owner believes that it would not be in the best interest of the Project to make an Award to that Bidder. Owner also reserves the right to waive all informalities not involving price, time, or changes in the Work and to negotiate contract terms with the successful Bidder.

19.02 More than one Bid for the same Work from an individual or entity under the same or different names will not be considered. Reasonable grounds for believing that any Bidder has an interest in more than one Bid for the Work may be cause of disqualification of that Bidder and the rejection of all Bids in which that Bidder has an interest.

19.03 Evaluation of Bids

- A. In evaluating Bids, Owner will consider whether or not the Bids comply with the prescribed requirements, and such alternatives, unit prices, and other data, as may be requested in the Bid Form or prior to the Notice of Award.
- B. In the comparison of Bids, alternatives will be applied in the same order of priority as listed in the Bid Form. To determine the Bid prices for purposes of comparison, Owner shall announce to all Bidders a "Base Bid plus alternatives" budget after receiving all Bids, but prior to opening them. For comparison purposes alternatives will be accepted, following the order of priority established in the Bid Form, until doing so would cause the budget to be exceeded. After determination of the successful Bidder based on this comparative process and on the responsiveness, responsibility, and other factors set forth in these Instructions, the award may be made to the successful Bidder on its base Bid and any combination of its additive alternate Bids for which Owner determines funds will be available at the time of award.
- C. In evaluating Bids, Owner will consider whether or not the Bids comply with the prescribed requirements, and such alternates, unit prices and other data, as may be requested in the Bid Form or prior to the Notice of Award.
- D. In evaluating Bidders, Owner will consider the qualifications of Bidders and may consider the qualifications and experience of Subcontractors, Suppliers, and other individuals or the

entities proposed for those portions of the Work for which the identity of Subcontractors, Suppliers, and other individuals or entities must be submitted as required by Article 12 of this Section 00100.

- 19.04 Owner may conduct such investigations as Owner deems necessary to establish the responsibility, qualifications, and financial ability of Bidders, proposed Subcontractors, Suppliers, individuals, or entities to perform the Work in accordance with the Contract Documents.
- 19.05 If the Contract is to be awarded, Owner will Award the Contract to the Bidder whose Bid is determined to be the most advantageous to Owner, taking into consideration those Bids in compliance with the requirements as set forth in this ITB.
- 19.06 Within thirty-five (35) days after the opening of Bids, unless otherwise stated in this ITB, Owner will accept one of the Bids or will act in accordance with these Instructions to Bidders or the Section 00250 General Terms and Conditions for Construction Projects. The acceptance of the Bid will be by written Notice of Intent of Award with an attached copy of the signed Bid tabulation, emailed, mailed or delivered to the office designated in the Bid, with a copy: to all other Bidders. In the event of failure of the lowest responsible qualified Bidder to sign and return the Agreement, as prescribed herein, Owner may Award to the next lowest responsible and responsive qualified Bidder. Such Award, if made will be made within ninety (90) days after opening Bids.

Article 20. - Insurance

- 20.01 When the successful Bidder delivers the executed Agreement to Owner, it must be accompanied by the required Certificate of Insurance.

Article 21. - Signing of Agreement

- 21.01 When Owner gives a Notice of Award to the successful Bidder, it shall be accompanied by the required number of unsigned counterparts of the Agreement with the other Contract Documents, which are identified in the Agreement attached thereto. Within fifteen (15) days thereafter, successful Bidder shall sign and deliver the required number of counterparts of the Agreement and attached Contract Documents to Owner. Within thirty (30) days thereafter, Owner shall deliver one fully signed counterpart to successful Bidder.

Article 22. - Retainage

- 22.01 Provisions concerning retainage are set forth in the Contract Documents.

Article 23. - Designated Contacts and Request for Information (RFI) Deadline

- 23.01 All questions regarding this ITB must be submitted in writing to:

Ms. Danielle Gilbert, CPPB
HCBCB Purchasing Manager
4320 George Boulevard, Sebring, Florida 33875-5803
Phone: (863) 402-6524; Fax: (863) 408-6735
Email: dgilbert@hcbcc.org

The deadline to submit questions is 5 P.M. on September 8, 2017. The County will release responses in the form of an Addendum to all Pre-Bid attendees via email. This Addendum will be posted to the County's website: www.hbcc.net.

Article 24. - Direct Material Purchase Procedure

The Owner and the Contractor will utilize the Direct Material Purchase Procedure of Paragraph 7.09 of Section 00700 Standard General Conditions of the Construction Contract as modified in Section 00800 Supplementary Conditions of the Contract Documents.

-END OF SECTION-

SECTION 00160
CERTIFICATION PURSUANT TO SECTION 287.135, FLORIDA STATUTES
ITB 17-039

**THIS FORM MUST BE SIGNED AND SWORN TO IN THE PRESENCE OF A NOTARY PUBLIC OR
OTHER OFFICIAL AUTHORIZED TO ADMINISTER OATHS.**

1. This sworn statement is submitted to the HIGHLANDS COUNTY BOARD OF COUNTY COMMISSIONERS

by _____
[Print individual's name and title]

for _____
[Print name and state of incorporation or other formation of the entity submitting this sworn statement]

whose business address is _____ and

whose Federal Employer Identification Number (FEIN) is _____ (hereinafter referred to as
"Bidder")

2. CERTIFICATION

Bidder hereby certifies that at the time of its Bid the Bidder is not on the Scrutinized Companies that Boycott Israel list created pursuant to Section 215.4725, Florida Statutes, is not participating in a boycott of Israel, is not on the Scrutinized Companies with Activities in Sudan List or the Scrutinized Companies with Activities in the Iran Petroleum Energy Sector List and that it does not have business operations in Cuba or Syria.

THIS CERTIFICATION IS MADE PURSUANT TO SECTION 287.135(5), FLORIDA STATUTES, AND IS, UPON DELIVERY, A PUBLIC RECORD.

Print Name: _____

STATE OF _____
COUNTY OF _____

The foregoing Certification was sworn to before me this ___ day of _____, 2017, by _____, as _____, the duly authorized officer of _____, on its behalf, who is either personally known to me [] or has produced _____ as identification [].

(AFFIX NOTARY SEAL)

Print Name: _____
Notary Public, State of Florida
Commission No. _____
My Commission Expires: _____

**CERTIFICATION PURSUANT TO SECTION 287.087, FLORIDA STATUTES
PREFERENCE TO DO BUSINESS WITH DRUG FREE WORKPLACE PROGRAMS
ITB 17-039**

**THIS FORM MUST BE SIGNED AND SWORN TO IN THE PRESENCE OF A NOTARY PUBLIC OR OTHER
OFFICIAL AUTHORIZED TO ADMINISTER OATHS.**

1. This sworn statement is submitted to the HIGHLANDS COUNTY BOARD OF COUNTY COMMISSIONERS

by _____
[Print individual's name and title]

for _____
[Print name and state of incorporation or other formation of the entity submitting this sworn statement]

whose business address is _____ and

whose Federal Employer Identification Number (FEIN) is _____ (hereinafter referred to as
"Bidder")

2. CERTIFICATION

Bidder hereby certifies that at the time of its Bid the Bidder has a drug free workplace program in place. The program meets the requirements of Section 287.087, Florida Statutes.

**THIS CERTIFICATION IS MADE PURSUANT TO SECTION 287.087, FLORIDA STATUTES, AND IS, UPON
DELIVERY, A PUBLIC RECORD.**

Print Name: _____ Date: ____/____/____

STATE OF FLORIDA
COUNTY OF _____

The foregoing Certification was sworn to before me this ____ day of _____, 20____, by _____,
as _____, the duly authorized officer of _____, on its behalf, who is
either personally known to me [] or has produced _____ as identification [].

(AFFIX NOTARY SEAL)

Signature: _____

Print Name: _____

Notary Public, State of _____

Commission No. _____

My Commission Expires: _____

**SWORN STATEMENT UNDER SECTION 287.133(3)(A), FLORIDA STATUTES,
ON PUBLIC ENTITY CRIMES**

ITB 17-039

**THIS FORM MUST BE SIGNED AND SWORN TO IN THE PRESENCE OF A NOTARY PUBLIC OR OTHER
OFFICIAL AUTHORIZED TO ADMINISTER OATHS.**

DESCRIPTION OF CONTRACT: _____

STATE OF FLORIDA }ss
COUNTY OF _____ }

Before me, the undersigned authority, personally appeared _____ who, being by me first duly sworn, made the following statement:

1. The business address of _____ (name of bidder or contractor), is

2. I understand that a public entity crime as defined in Section 287.133 of the Florida Statutes includes a violation of any state or federal law by a person with respect to and directly related to the transaction of business with any public entity in Florida or with an agency or political subdivision of any other state or with the United States, including, but not limited to, any bid or contract for goods or services to be provided to any public entity or such an agency or political subdivision and involving antitrust, fraud, theft, bribery, collusion, racketeering, conspiracy or material misrepresentation.

3. I understand that "convicted" or "conviction" is defined by the statute to mean a finding of guilt or a conviction of a public entity crime, with or without an adjudication of guilt, in any federal or state trial court of record relating to charges brought by indictment or information after July 1, 1989, as a result of a jury verdict, non-jury trial, or entry of a plea of guilt or nolo contendere.

4. I understand that "affiliate" is defined by the statute to mean (1) a predecessor or successor of a person or a corporation convicted of a public entity crime, or (2) an entity under the control of any natural person who is active in the management of the entity and who has been convicted of a public entity crime, or (3) those officers, directors, executives, partners, shareholders, employees, members, and agents who are active in the management of an affiliate, or (4) a person or corporation who knowingly entered into a joint venture with a person who has been convicted of a public entity crime in Florida during the preceding 36 months.

5. Neither the bidder or contractor nor any officer, director, executive, partner, shareholder, employee, member or agent who is active in the management of the bidder or contractor nor any affiliate of the bidder or contractor has been convicted of a public entity crime subsequent to July 1, 1989.

(Draw a line through paragraph 5 if paragraph 6 below applies.)

6. There has been a conviction of a public entity crime by the bidder or contractor, or an officer, director, executive, partner, shareholder, employee, member or agent of the bidder or contractor who is active in the management of the bidder or contractor or

an affiliate of the bidder or contractor. A determination has been made pursuant to 287.133(3) by order of the Division of Administrative Hearings that it is not in the public interest for the name of the convicted person or affiliate to appear on the convicted vendor list. The name of the convicted person or affiliate is _____.

A copy of the order of the Division of Administrative Hearings is attached to this statement.

(Draw a line through paragraph 6 if paragraph 5 above applies.)

THIS SWORN STATEMENT IS MADE PURSUANT TO SECTION 287.133(3)A, FLORIDA STATUTES, AND IS, UPON DELIVERY, A PUBLIC RECORD

Signature: _____

Print Name: _____

Print Title: _____

On ____ day of _____, 20____.

Sworn and subscribed before me in the State and County first mentioned above on the _____ day of _____, 20____.

Signature: _____

Print Name: _____

Notary Public, State of _____

Commission No. _____

My Commission Expires: _____

(AFFIX NOTARY SEAL)

**CERTIFICATION PURSUANT TO SECTION 287.134, FLORIDA STATUTES
DISCRIMINATION; DENIAL OR REVOCATION OF THE RIGHT TO TRANSACT BUSINESS WITH
PUBLIC ENTITIES**

ITB 17-039

**THIS FORM MUST BE SIGNED AND SWORN TO IN THE PRESENCE OF A NOTARY PUBLIC OR OTHER
OFFICIAL AUTHORIZED TO ADMINISTER OATHS.**

1. This sworn statement is submitted to the HIGHLANDS COUNTY BOARD OF COUNTY COMMISSIONERS

by _____
[Print individual's name and title]

for _____
[Print name and state of incorporation or other formation of the entity submitting this sworn statement]

whose business address is _____ and

whose Federal Employer Identification Number (FEIN) is _____ (hereinafter referred to as
"Bidder")

2. CERTIFICATION

Bidder hereby certifies that at the time of its Bid the Bidder has not been placed on the discriminatory vendor list by the
Department of Management Services.

**THIS CERTIFICATION IS MADE PURSUANT TO SECTION 287.134, FLORIDA STATUTES, AND IS, UPON
DELIVERY, A PUBLIC RECORD.**

Print Name: _____ Date: ____/____/____

STATE OF FLORIDA
COUNTY OF _____

The foregoing Certification was sworn to before me this ____ day of _____, 20____, by _____,
as _____, the duly authorized officer of _____, on its behalf, who is
either personally known to me [] or has produced _____ as identification [].

(AFFIX NOTARY SEAL)

Signature: _____
Print Name: _____
Notary Public, State of _____
Commission No. _____
My Commission Expires: _____

**CERTIFICATION OF PARTICIPATION IN THE UNITED STATES CITIZENSHIP AND IMMIGRATION
SERVICE BUREAU'S E-VERIFY PROGRAM**

ITB 17-039

**THIS FORM MUST BE SIGNED AND SWORN TO IN THE PRESENCE OF A NOTARY PUBLIC OR OTHER
OFFICIAL AUTHORIZED TO ADMINISTER OATHS.**

1. This sworn statement is submitted to the HIGHLANDS COUNTY BOARD OF COUNTY COMMISSIONERS

by _____
[Print individual's name and title]

for _____
[Print name and state of incorporation or other formation of the entity submitting this sworn statement]

whose business address is _____ and

whose Federal Employer Identification Number (FEIN) is _____ (hereinafter referred to as
"Bidder")

2. **CERTIFICATION**

Bidder hereby certifies that at the time of its Bid the Bidder participates in the United States Citizenship and Immigration Services Bureau's E-Verify Program, and does not knowingly employ, hire for employment, or continue to employ an unauthorized alien.

Bidder's E-verify Company ID #: _____

THIS CERTIFICATION IS, UPON DELIVERY, A PUBLIC RECORD.

Print Name: _____ Date: ___/___/___

STATE OF FLORIDA
COUNTY OF _____

The foregoing Certification was sworn to before me this ___ day of _____, 20___, by _____,
as _____, the duly authorized officer of _____, on its behalf, who is
either personally known to me [] or has produced _____ as identification [].

(AFFIX NOTARY SEAL)

Signature: _____
Print Name: _____
Notary Public, State of _____
Commission No. _____
My Commission Expires: _____

**SECTION 00250
GENERAL TERMS AND CONDITIONS
FOR CONSTRUCTION PROJECTS
ITB 17-039**

- A. All Bidding Documents shall become the property of the County.
- B. Compliance with Florida Statutes Section 287.087, on Drug Free Workplace, Section 287.133(2)(a), on Public Entity Crimes, Section 287.134, on Discrimination, and Section 287.135, Prohibiting contracting with scrutinized companies is required.

FLORIDA STATUTES

Section 287.087, Florida Statutes. Preference to businesses with drug-free workplace programs.

In order to have a drug free workplace program, a business shall:

1. Publish a statement notifying employees that the unlawful manufacture, distribution, dispensing, possession, or use of a controlled substance is prohibited in the workplace and specifying the actions that will be taken against employees for violations of such prohibition.
2. Inform employees about the dangers of drug abuse in the workplace, the business's policy of maintaining a drug free workplace, any available drug counseling, rehabilitation, and employee assistance programs, and the penalties that may be imposed upon employees for drug abuse violations.
3. Give each employee engaged in providing the commodities or contractual services that are under bid a copy of the statement specified in subsection (1).
4. In the statement specified in subsection (1), notify the employees that, as a condition of working on the commodities or contractual services that are under bid, the employee will abide by the terms of the statement and will notify the employer of any conviction of, or plea of guilty or nolo contendere to, any violation of Chapter 893, Florida Statutes, or of any controlled substance law of the United States or any state, for a violation occurring in the workplace no later than five (5) days after such conviction.
5. Impose a sanction on, or require the satisfactory participation in a drug abuse assistance or rehabilitation program if such is available in the employee's community by, any employee who is so convicted.
6. Make a good faith effort to continue to maintain a drug-free workplace through implementation of this section.

NOTE: PLEASE INCLUDE YOUR “DRUG FREE” STATUS AS PART OF THE GENERAL COMMENTS IN YOUR PROPOSAL OR WHERE INDICATED ON THE BID FORM.

Section 287.133, Florida Statutes. Public entity crime; denial or revocation of the right to transact business with public entities:

(2)(a) A person or affiliate who has been placed on the convicted vendor list following a conviction for a public entity crime may not submit a bid, proposal, or reply on a contract to provide any goods or services to a public entity; may not submit a bid, proposal, or reply on a contract with a public entity for the construction or repair of a public building or public work; may not submit bids, proposals, or replies on leases of real property to a public entity; may not be awarded or perform work as a contractor, supplier, subcontractor, or consultant under a contract with any public entity; and may not transact business with any public entity in excess of the threshold amount provided in Section 287.017, Florida Statutes for CATEGORY TWO for a period of 36 months following the date of being placed on the convicted vendor list.

Section 287.134, Florida Statutes. Discrimination; denial or revocation of the right to transact business with public entities:

(2)(a) An entity or affiliate who has been placed on the discriminatory vendor list may not submit a bid, proposal, or reply on a contract to provide any goods or services to a public entity; may not submit a bid, proposal, or reply on a contract with a public entity for the construction or repair of a public building or public work; may not submit bids, proposals, or replies on leases of real property to a public entity; may not be awarded or perform work as a contractor, supplier, subcontractor, or consultant under a contract with any public entity; and may not transact business with any public entity.

Section 287.135, Florida Statutes. Prohibition against contracting with scrutinized companies:

(2) A company is ineligible to, and may not, bid on, submit a proposal for, or enter into or renew a contract with an agency or local governmental entity for goods or services of \$1 million or more if at the time of bidding or submitting a proposal for a new contract or renewal of an existing contract, the company:

- (a) Is on the Scrutinized Companies that Boycott Israel List, created pursuant to Section 215.4725, Florida Statutes, or is engaged in a boycott of Israel;
- (b) Is on the Scrutinized Companies with Activities in Sudan List or the Scrutinized Companies with Activities in the Iran Petroleum Energy Sector List, created pursuant to Section 215.473, Florida Statutes.
- (c) Is engaged in business operations in Cuba or Syria.

(5) At the time a company submits a bid or proposal for a contract or before the company enters into or renews a contract with an agency or governmental entity for goods or services of \$1 million or more, the company must certify that the company is not participating in a boycott of Israel, on the Scrutinized Companies with Activities in Sudan List or the Scrutinized Companies with Activities in the Iran Petroleum Energy Sector List, or that it does not have business operations in Cuba or Syria.

- C. Bids are due and must be received in accordance with the instructions given in Section 00010 of this ITB.
- D. Owner will not reimburse Bidder(s) for any costs associated with the preparation and submittal of any Bid.
- E. Bidders, their agents and associates shall NOT solicit any County official. Bidders, their agents and

associates shall NOT contact any County official other than the individual(s) listed in Article 23 of Section 00100 of this ITB for additional information and clarification.

- F. Due care and diligence has been exercised in the preparation of this ITB and all information contained herein is believed to be substantially correct; however, the responsibility for determining the full extent of the service required rests solely with those making response. Neither Owner nor its representatives shall be responsible for any error or omission in the Bids submitted, nor for the failure on the part of the Bidders to determine the full extent of the exposures.
- G. All timely responses meeting the specifications set forth in this ITB will be considered. However, Bidders are cautioned to clearly indicate any deviations from these specifications. The terms and conditions contained herein are those desired by Owner and preference will be given to those Bids in full or substantially full compliance with them.
- H. Each Bidder is responsible for full and complete compliance with all laws, rules and regulations including those of the Federal Government, the State of Florida and the County of Highlands. Failure or inability on the part of the Bidder to have complete knowledge and intent to comply with such laws, rules and regulations shall not relieve the Bidder from its obligation to honor its Bid and to perform completely in accordance with its Bid.
- I. County, at its discretion, reserves the right to waive minor informalities or irregularities in any Bids, to reject any and all Bids in whole or in part, with or without cause, and to accept that Bid, if any, which in its judgment will be in its best interest.
- J. Award will be made to the Bidder whose Bid is determined to be the most advantageous to Owner, taking into consideration those Bids in compliance with the requirements as set forth in this ITB. The Board reserves the right to reject any and all Bids for any reason or make no Award whatsoever or request clarification of information from the Bidders.
- K. Any interpretation, clarification, correction or change to this ITB will be made by written addendum issued by the Purchasing Division. Any oral or other type of communication concerning this ITB shall not be binding.
- L. Bids must be signed by an individual of the Bidder's organization legally authorized to commit the Bidder to the performance of the product(s) and/or service(s) contemplated by this ITB.
- M. The insurance requirements of Paragraphs 6.02, 6.03, and 6.06 of the Standard General Conditions, as amended by the Supplementary Conditions, found in Sections 00700 and 00800 of this ITB must be satisfied before delivery of goods and performance of services.
- N. If submitting a Bid for more than one ITB, each Bid must be in a separate envelope and correctly marked. Only one (1) Bid per project shall be accepted from any person, corporation or firm. Modifications will not be accepted or acknowledged.
- O. If the successful Bid is greater than two hundred thousand dollars (\$200,000.00), a Public Construction Bond will be required. **Awarded Bidder must record Public Construction Bond at the Clerk's Recording Division and comply with Section 255.05, Florida Statutes.** All Bonds must be in a form acceptable to Owner and County Attorney.

- P. Each Bid must contain proof of enrollment in E-Verify.
- Q. Board policy prohibits any County employee or members of their family from receiving any gift, benefit, and/or profit resulting from any contract or purchase. Board policy also prohibits acceptance of gifts of any kind other than advertising novelties valued less than ten dollars (\$10.00).
- R. Construction Projects that are awarded for less than two hundred thousand dollars (\$200,000.00) and without a Public Construction Bond require the following:
1. At any time prior to final completion of the Contract, Owner will not authorize or make payment to the Contractor in excess of ninety percent (90%) of the amount due on the Contract on the basis of the Work suitably completed.
 2. In case of the default by the Contractor, the laborers, materialmen, and Subcontractors, as defined in Section 713.01, Florida Statutes, making claims for unpaid bills, may be paid from the ten percent (10%) retainage.
 3. The final payment of retainage shall not be made until: (1) the Project has been inspected by the Engineer or other person designated by the County for the purpose; (2) Engineer or other designated person has issued a written certificate that the Project has been constructed in accordance with the approved Construction Documents and approved Change Orders; (3) the County has accepted the Project; and (4) the Contractor has supplied the County with signed and dated statements from all laborers, materialmen, and subcontractors as defined in Section 713.01, Florida Statutes, and identified under subparagraph (d) of this paragraph 2, that they have no claims against the Contractor for the Work under the Contract. Said statements shall identify the Project by name and Project number.
 4. The Contractor, before beginning Work or within two (2) workdays thereafter, shall post in a conspicuous place on the Site the following notice.

“Notice is hereby made to all those concerned and affected that
(Contractor’s name) is performing the “MARTIN LUTHER KING JR.
BOULEVARD SIDEWALK EXTENSION; PROJECT NO. 15005.”

All parties furnishing labor and/or materials to said project must, within twenty (20) days of first providing such labor and/or materials, deliver notice of such in writing, by certified mail, returned receipt requested, to:

HIGHLANDS COUNTY BOARD OF COUNTY COMMISSIONERS
ENGINEERING DEPARTMENT
ATTN: CLINTON HOWERTON, JR., P.E.
505 SOUTH COMMERCE AVE., SEBRING, FLORIDA 33870-3869

5. The Contractor shall provide a certified list of all Subcontractors, laborers, and material suppliers to the Owner or Designee within thirty (30) days of receiving the Notice to Proceed with the Work. This list shall be updated thereafter each month with a certified statement that the list and its

updates include the names and address of all of those Subcontractors, laborers, and material suppliers furnishing labor and/or material for the Project.

6. The Contractor shall provide a written statement with each pay request to the Engineer which indicates how each payment will be distributed. This pay request breakdown shall define the disbursement intended for all the funds requested. When the Contractor receives any payment it shall pay such moneys received to each Subcontractor and material supplier as set forth in that written statement.
 7. The Contractor shall provide a written statement with all but the first payment request from each of the Subcontractors, laborers, and material suppliers indicated in paragraph 5 of this Section R that they have in fact received payment as indicated in paragraph 6 of this Section R. In the event a payment is not made as indicated on a prior written statement provided pursuant to paragraph 5 of this Section R, the Contractor shall furnish an explanation as to the reasons for such deviation and shall request approval from the Engineer.
- S. Late Bids will not be accepted under any circumstances. If Bids received after the scheduled time of the Bid Opening Meeting, the Bidder will be contacted for disposition. The Purchasing Division, at the Bidder's expense, can return the unopened envelope, or, at the Bidder's request, in writing, can destroy it.
- T. Electronically submitted Bids and faxed Bids will not be accepted. Any blank spaces on the required Bid Form or the absence of required submittals or signatures may cause the Bid to be declared non-responsive.
- U. The County is not responsible for correcting any errors or typos made on the Bid response. Incorrect calculations may cause the Bid to be declared non-responsive.
- V. Minority Owned and Women owned businesses must submit a copy of the certificate to receive credit.
- W. The Bidder shall comply with the Florida Sales and Use Tax Law as it may apply to this Contract. The quoted amount(s) shall include any and all Florida Sales and Use Tax payment obligations required by Florida Law of the successful Bidder and/or its Subcontractors or material suppliers.
- X. Public Records: Any material submitted in response to this ITB will become Public Record pursuant to Section 119(1)(b) and (c), Florida Statutes.

ADDITIONAL TERMS AND CONDITIONS

All pages included in or attached by reference to this ITB shall be called and constitute the Invitation to Bid.

Bidders who will not be bidding on this ITB are requested to notify the County and indicate why they are not bidding. Bidders who fail to respond to two (2) or more consecutive ITB's may be removed from the County's Bid notification mailing list.

END OF SECTION

G:\COUNTY\ENGINEERING DEPT\ITB 17-011\17-011 - ITB - SECTION 00250 Gen Terms Conditions 10142016.doc

SECTION 00300

BID FORM

ITB 17-039

PROJECT IDENTIFICATION: MARTIN LUTHER KING JR. BLVD SIDEWALK EXTENSION
PROJECT NO. 15005
ITB No. 17-039

THIS BID IS SUBMITTED TO: Highlands County Board of County Commissioners
Attn: Purchasing Division
600 S. Commerce Ave.,
Sebring, FL 33870

BID SUBMITTED BY:

[Bidding Company's Name]

[Bidder's Authorized Representative's Name]

[Bidder's Address 1]

[Bidder's Address 2]

[Print Contact Person's Name for this Bid]

[Contact Person's Email Address]

[Contact Person's Phone Number]

1. The Bidder proposes and agrees, if this Bid is accepted, to furnish all labor, materials, and equipment to construct and complete the Work according to and as specified or indicated in ITB 17-039 and the Bidding Documents for the Bid Price and within the time periods stated in this Bid and in accordance with the other terms and conditions of the Contract Documents.
2. Bidder accepts all of the terms and conditions of the Advertisement or Invitation to Bid and Instructions to Bidders, including without limitation those dealing with the disposition of Bid security. This Bid will remain subject to acceptance for thirty (30) days after the day of Bid opening. Bidder will sign and deliver the required number of the other documents required by this ITB within fifteen (15) days after the date of County's Notice of Award.
3. In submitting this Bid, Bidder represents that:

- a. Bidder has examined and carefully studied the Bidding Documents, including the following Addenda, receipt of all of which is hereby acknowledged:

<i>Date</i>	<i>Number</i>	<i>Date</i>	<i>Number</i>
_____	_____	_____	_____
_____	_____	_____	_____

- b. Bidder has visited the Site and become familiar with and is satisfied as to the general, local, and Site conditions that may affect cost, progress, performance, and furnishing of the Work;
- c. Bidder is familiar with and is satisfied as to all Laws and Regulations that may affect cost, progress, performance, and furnishing of the Work.
- d. Bidder acknowledges that County and Engineer do not assume responsibility for the accuracy or completeness of information and data shown or indicated in the Bidding Documents with respect to Underground Facilities at or contiguous to the Site. Bidder has obtained and carefully studied (or assumes responsibility for having done so) all such additional or supplementary examinations, investigations, explorations, tests, studies, and data concerning conditions (surface, subsurface, and Underground Facilities) at or contiguous to the Site or otherwise which may affect cost progress, performance or furnishing of the Work or which relate to any aspect of the means, methods, techniques, sequences, and procedures of construction to be employed by Bidder and safety precautions and programs incident thereto. Bidder does not consider that any additional examinations, investigations, explorations, tests, studies or data are necessary for the determination of this Bid for performance and furnishing of the Work in accordance with the times, price, and other terms and conditions of the Contract Documents
- e. Bidder is aware of the general nature of the Work to be performed by County and others at the Site that relates to the Work.
- f. Bidder has correlated information known to Bidder, information and observations obtained from visits to the Site and all additional examinations, investigations, explorations, tests, studies, and data with the Contract Documents.
- g. Bidder has given Engineer written notice of all conflicts, errors, ambiguities or discrepancies that Bidder has discovered in the Bidding Documents and the written resolution thereof by Engineer is acceptable to Bidder, and the Bidding Documents are generally sufficient to indicate and convey understanding of all terms and conditions for performing and furnishing the Work.
- h. This Bid is genuine and not made in the interest of or on behalf of any undisclosed person, firm or corporation and is not submitted in conformity with any agreement or rules of any group, association, organization or corporation. Bidder has not directly or indirectly induced or solicited any other Bidder to submit a false or sham Bid. Bidder has not solicited or induced any person, firm or corporation to refrain from Bidding, and Bidder has not sought by collusion to obtain for itself any advantage over any other Bidder or over County.

4. Documentation included with Bid packet

		Required?	Included (check if yes)
1.	One (1) original (signed in blue ink), one (1) exact paper copy, and one (1) exact electronic copy (CD or thumb drive) of the submitted Bid. Bid form signed, addendums acknowledged.	Yes	
2.	Certificates from Section 00160 <ul style="list-style-type: none"> • F.S. 287.135 • F.S. 287.087 • F.S. 287.133(3)(A) • F.S. 287.134 • Participation in E-Verify 	Yes	
3.	Certificate from Section 00420 (Statement of Indemnification)	Yes	
4.	Waiver of right to claim against payment/construction bond (Section 00836)	Yes	
5.	Woman or Minority Owned Business Certificate	If applicable	
6.	Qualifications (See Section 00100, Article 3) <ul style="list-style-type: none"> • List of 5 jobs of similar magnitude • Resumes • List of available equipment • Five (5) reference letters • Copies of required licenses • List of sub-contractors, if applicable • List of present commitments 	Yes	
7.	Bid security in the form of _____	Yes, over \$100,000.00	
8.	Accord Insurance Form	Yes	

5. Pricing

This is a Lump Sum and Unit Price Bid. Bidder will complete the Work in accordance with the Contract Documents for the following Lump Sum and Unit Price Bid items. Award will be based on the total Lump Sum Bid Price, sum of Unit Price items, and requirements of Bidder. All work for this ITB will be awarded to one (1) Bidder.

BASE BID:

TABULATION OF QUANTITIES

ITEM NUMBER	ITEM DESCRIPTION	QUANTITY	UNIT	UNIT PRICE
S-1	MOBILIZATION	1	LS	
S-2	BONDS AND INSURANCE	1	LS	
S-3	MAINTENANCE OF TRAFFIC	1	LS	
S-4	SEDIMENT BARRIER - STAKED SILT FENCE	1759	LF	
S-5	CONSTRUCTION SURVEY STAKEOUT AND AS-BUILT DRAWINGS	1	LS	

S-6	CLEARING AND GRUBBING	0.95	AC	
S-7	REMOVAL OF CONCRETE PAVEMENT (SIDEWALK)	33	SY	
S-8	REGULAR EXCAVATION	350	CY	
S-9	EMBANKMENT	392	CY	
S-10	OPTIONAL BASE GROUP NO. 1 (4" THICK)	1567	SY	
S-11	MILL EXISTING ASPHALT PAVEMENT - 3/4" AVERAGE DEPTH	36	SY	
S-12	FDOT TYPE 'C' INLET W/ GALVANIZED STEEL GRATE	1	EA	
S-13	DESILT STORM PIPE - 12"X18" ERCP	193	LF	
S-14	4" CONCRETE SIDEWALK	1287	SY	
S-15	6" CONCRETE SIDEWALK	32	SY	
S-16	6" CONCRETE DRIVEWAY	230	SY	
S-17	DETECTABLE WARNING SURFACE (EMBEDDED - YELLOW)	18	SY	
S-18	PERFORMANCE TURF - SOD (INCL. TOP SOIL & WATER FOR 14 DAYS AT LEAST TWICE A WEEK AFTER INITIAL ESTABLISHMENT)	2408	SY	
S-19	TEMPORARY 12" SOLID WHITE PAINT STRIPE - CROSSWALK	397	LF	
S-20	TEMPORARY 24" SOLID WHITE PAINT STRIPE - STOP BAR	35	LF	
S-21	12" SOLID WHITE THERMOPLASTIC STRIPE - CROSSWALK	360	LF	
S-22	24" SOLID WHITE THERMOPLASTIC STRIPE - STOP BAR	52	LF	
S-23	RELOCATE EXISTING SIGNS	7	EA	
S-24	RELOCATE EXISTING MAIL BOXES	7	EA	
S-25	TESTING	1	LS	

LS = Lump Sum, SY = Square Yard, LF = Linear Foot, AC = Acre, CY = Cubic Yards and EA = Each

BASE BID TOTAL \$ _____

[Numbers]

\$ _____

[Words]

6. Bidder agrees that the Work will be substantially complete within forty-five (45) days and completed and ready for final payment within sixty (60) days after the date when the Contract Times commence to run. The Contract Times will commence to run on the thirteenth (13th) day after the Effective Date of the Agreement or, if a Notice to Proceed is given, on the day indicated in the Notice to Proceed. A Notice to Proceed may be given at any time within thirty (30) days after the Effective Date of the Agreement.

7. Bidder shall coordinate with the Project Manager in order to comply with all applicable quality control testing in accordance with the Drawings and Specification.
8. Communications concerning this Bid have been addressed only to the contacts listed in Article 23 of Section 00100 of ITB 17-039.

SUBMITTED on _____, 2017

State Contractor License No. _____.

If Bidder is an Individual:

(SEAL)

Individual's name: _____

Signature: _____

Doing business as: _____

Business address: _____

Phone No.: _____

If Bidder is a Partnership:

(SEAL)

Partnership's name: _____

State in which organized: _____

Type of partnership: _____

Name of general partner: _____

Signature: _____

Business address: _____

Phone No.: _____

If Bidder is a Corporation:

(SEAL)

Corporation's name: _____

State of incorporation: _____

Name of authorized person to sign: _____

Title: _____

Signature: _____

Date of qualification to do business: _____

Attest: _____

Business address: _____

Phone No.: _____

If Bidder is a Joint Venture:

(SEAL)

Name 1: _____

Signature 1: _____

Address 1: _____

Name 2: _____

Signature 2: _____

Address 2: _____

Address for receipt of official
communications: _____

Phone number for official
communications: _____

(Each joint venturer must sign. The manner of signing for each individual, partnership and corporation that is a party to the joint venture should be in the manner indicated above for an individual or the appropriate form of entity.)

SECTION 00410
BID BOND
ITB 17-039

STATE OF FLORIDA COUNTY
OF HIGHLANDS

KNOW ALL MEN BY THESE PRESENTS, that we _____
(hereinafter called “Principal”), and _____ as Surety, (hereinafter called
“Surety”), are held and firmly bound unto the Highlands County, a political subdivision of the State of
Florida (hereinafter called “Owner”), in the sum of _____ Dollars (\$ _____),
lawful money of the United States of America, for the payment of which sum well and truly to be made,
we bind ourselves, our heirs, executors, administrators and successors, jointly and severally, firmly
by these presents:

WHEREAS, the “Principal” contemplates submitting or has submitted to bid to the said
“Owner” for Bid No. ITB 17-039.

MARTIN LUTHER KING JR. BOULEVARD SIDEWALK EXTENSION:
PROJECT NO. 15005

WHEREAS, it was a condition precedent to the submission of said bid that a certified check
or bid bond in the amount of not less than five percent (5%) of the amount of bid be submitted with
said bid as a guarantee that the Bidder would, if awarded the contract, enter into a written contract with
the “Owner” within fifteen (15) consecutive calendar days after having been given notice of award of
the contract.

NOW, THEREFORE, THE CONDITIONS OF THIS OBLIGATION ARE SUCH, that if the bid
of the “Principal” herein be accepted and said “Principal”, within fifteen (15) consecutive calendar
days after notice being given of such acceptance, enter into a written contract with the “Owner”, then this
obligation shall be void; otherwise, the sum herein stated shall be due and payable to the “Owner”, and
the “Surety” herein agrees to pay said sum immediately upon demand of said “Owner”, in good and

lawful money of the United States of America; as liquidated damages for failure thereof said "Principal".

IN WITNESS WHEREOF, the said _____, as "Principal" herein, has caused these presents to be signed in its name by its _____ and attested by its _____ under its corporate seal, and the said _____ as "Surety" herein, has caused these presents to be signed in its _____ and attested by its _____ under its corporate seal, this _____ day of _____, A.D. 2017.

ATTEST:

CONTRACTOR, AS PRINCIPAL:

Title: _____

By: _____ (Seal)

Title: _____

ATTEST:

AS SURETY:

Title: _____

By: _____ (Seal)

Title: _____

END OF SECTION

**SECTION 00500
AGREEMENT
ITB 17-039**

THIS AGREEMENT made this ____ day of _____, 2017, by and between Highlands County, a political subdivision of the State of Florida, 600 South Commerce Avenue, Sebring, Florida 33870, (hereinafter called "Owner") and _____ (hereinafter called "Contractor"). Owner and Contractor, in consideration of the mutual covenants hereinafter set forth, agree as follows:

Article 1. - WORK

Contractor shall provide all labor, materials, and equipment to construct the MARTIN LUTHER KING JR. BOULEVARD SIDEWALK EXTENSION: PROJECT NO. 15005. Contractor shall complete the Work as specified or indicated in the Contract Documents. The Work is generally described as follows:

The Work consists of constructing approximately two thousand five hundred eighty-four (2,584) linear feet of sidewalk.

The principal features, as defined above, are not intended to cover every aspect of the Project details. Contractor shall be responsible for reviewing the Contract Documents to determine the full scope of the Work and specific requirements of the Project, which include familiarity and compliance with all Laws and Regulations.

Article 2. - ENGINEER

The Engineer of Record (hereinafter called "Engineer") is Michael J. Giardullo., P.E.

Article 3. - CONTRACT TIMES

3.1 Contractor agrees that the Work will be substantially complete within forty-five (45) days and completed and ready for final payment within sixty (60) days after the date when the Contract Times commence to run. The Contract Times will commence to run on the thirteenth (13th) day after the Effective Date of this Agreement or, if a Notice to Proceed is given, on the day indicated in the Notice to Proceed. A Notice to Proceed may be given at any time within thirty (30) days after the Effective Date of this Agreement.

3.2 Liquidated Damages:

3.2.1 Owner and Contractor recognize that time is of the essence of this Agreement and that Owner will suffer financial loss if the Work is not completed within the times specified in paragraph 3.1 of this Article. In agreeing upon the daily liquidated damages amount stated in this paragraph, Owner and Contractor have considered the original Contract Price stated in Article 4 of this Agreement, the average construction, engineering, and inspection costs experienced

by Owner, and anticipated costs of project-related delays and inconveniences to Owner and the public. Owner and Contractor also recognize the delays, expense, and difficulties involved in proving the actual loss suffered by Owner if the Work is not completed on time. Accordingly, instead of requiring any such proof, Owner and Contractor agree that as liquidated damages for delay (and not as a penalty) Contractor shall pay Owner Five Hundred Dollars (\$500.00) for each day that expires after the time specified in paragraph 3.1 of this Article until the Work is completed and ready for final payment. Liquidated damages shall be deducted by Owner from any balance due Contractor or, if the balance due Contractor is less than the amount of liquidated damages, Contractor shall pay to Owner the remaining unpaid liquidated damages within thirty (30) days after Owner's invoice is sent to Contractor.

- 3.2.2 Owner does not waive its right to liquidated damages due under this Agreement by allowing Contractor to continue and to finish the Work, or any part of it, after the expiration of the Contract Time including granted time extensions.
- 3.2.3 In the case of a default of this Agreement and the completion of the Work by Owner, Contractor and Contractor's surety are liable for the liquidated damages under this Agreement, but Owner will not charge liquidated damages for any delay in the final completion of Owner's performance of the Work due to any unreasonable action or delay on the part of Owner.

Article 4. - CONTRACT PRICE

Owner shall pay Contractor for completion of the Work in accordance with the Contract Documents an amount in current funds equal to the amount determined pursuant to paragraph 4.1 below:

- 4.1 For all Work as listed on the Bid Form and described in the Drawings and Specifications as Exhibit "A", attached hereto and included herein by this reference, a Lump Sum of:

(USE WORDS)

(USE FIGURES)

Contractor has included all costs in the Contract Price and shall cause the Work to be completed for the Contract Price. The Contract Price shall be reduced in the manner described in SC-7.09 of Section 00800 of the Supplementary Conditions of this Agreement.

Article 5. - PAYMENT PROCEDURES

- 5.1 Deliverables must be received and accepted in writing by the Engineer prior to reimbursements. Supporting documentation with the invoices must establish that the deliverables were received and

accepted in writing by the Engineer. Contractor may receive progress payments for deliverables based on the Contractor's Schedule of Values and on a percentage of services that have been completed, approved, and accepted to the satisfaction of Owner when properly supported by detailed invoices and acceptable evidence of payment. All costs charged to the Project by Contractor shall be supported by detailed invoices, proof of payments, contracts or vouchers evidencing in proper detail the nature and propriety of the charges.

5.2 Progress Payments; Retainage: Contractor shall deliver Contractor's Applications for Payment to Engineer on or before the third (3rd) day of each month. Owner shall make progress payments on account of the Contract Price on the basis of Contractor's Applications for Payment as recommended by Engineer, on or about the twenty-sixth (26th) day of each month during construction as provided in paragraphs 5.2.A and 5.2.B below.

A. Prior to fifty percent (50%) of the Work being completed, progress payments will be made in an amount equal to the percentage indicated below, but in each case, less the aggregate of payments previously made and less such amounts as Project Manager shall determine, or Owner may withhold. Owner will withhold ten percent (10%) of each application for progress payment until:

50 % of the Work is completed, and

0 % of materials and equipment not incorporated in the Work (but delivered, suitably stored, and accompanied by documentation satisfactory to the Owner).

B. After fifty percent (50%) of the Work is completed, progress payments will be made in an amount equal to the percentage indicated below, but in each case, , less the aggregate of payments previously made and less such amounts as Project Manager shall determine, or Owner may withhold. Owner will withhold five percent (5%) of each application for progress payment until:

100 % of the Work is completed, and

100 % of materials and equipment not incorporated in the Work (but delivered, suitably stored, and accompanied by documentation satisfactory to the Owner).

5.3 Final Payment: Upon completion of the Work, Contractor shall notify Owner in writing of the completion. The certification shall state that the Work has been completed in compliance with the Drawings and Specifications. If any deviations are noted from the approved Drawings and Specifications, the certification shall include a list of all deviations along with an explanation that justifies the reason to accept each deviation. After Contractor has, in the opinion of Engineer, satisfactorily completed all corrections identified during the final inspection and deviations not accepted by Owner and has delivered to Owner, in accordance with the Contract Documents, schedules, guarantees, Bonds, certificates or other evidence of insurance, certificates of inspection, permits, marked-up record documents, paper final as-built Drawings and Specifications, signed, sealed, and certified by a Professional Surveyor, registered in the State of Florida, and all applicable permits, final releases from Contractor and all Subcontractors and Suppliers at every level, all

warranties, and all other documents reasonably required by Owner pertaining to the Work, and provided verification of compliance with the requirements of Article 12 of this Agreement, Contractor may make application for final payment.

Article 6. - CONTRACTOR'S REPRESENTATIONS

In order to induce Owner to enter into this Agreement, Contractor makes the following representations:

- 6.1 Contractor has examined and carefully studied the Contract Documents (including any Addenda) and the other related data identified in the ITB 17-039 Documents.
- 6.2 Contractor has visited the Site and become familiar with and is satisfied as to the general, local and Site conditions that may affect cost, progress, performance or furnishing of the Work.
- 6.3 Contractor is familiar with and will comply with all Laws and Regulations whether or not the Laws or Regulations affect cost, progress, performance and furnishing of the Work.
- 6.4 Contractor has carefully studied all reports of explorations and tests of subsurface conditions at or contiguous to the Site and all drawings of physical conditions in or relating to existing surface or subsurface structures at or contiguous to the Site (except Underground Facilities) Contractor acknowledges that such reports and drawings are not Contract Documents and may not be complete for Contractor's purposes. Contractor acknowledges that Owner and Engineer do not assume responsibility for the accuracy or completeness of information and data shown or indicated in the Contract Documents with respect to Underground Facilities at or contiguous to the Site. Contractor has obtained and carefully studied (or assumes responsibility for having done so) all such additional supplementary examinations, investigations, explorations, tests, studies and data concerning conditions (surface, subsurface and Underground Facilities) at or contiguous to the Site or otherwise which may affect cost, progress, performance or furnishing of the Work or which relate to any aspect of the means, methods, techniques, sequences and procedures of construction to be employed by Contractor and safety precautions and programs incident thereto. Contractor does not consider that any additional examinations, investigations, explorations, tests, studies or data are necessary for the performance and furnishing of the Work at the Contract Price, within the Contract Times and in accordance with the other terms and conditions of the Contract Documents.
- 6.5 Contractor is aware of the general nature of work to be performed by Owner and others at the Site that relates to the Work as indicated in the Contract Documents.
- 6.6 Contractor has correlated the information known to Contractor, information and observations obtained from visits to the Site, reports, Drawings and Specifications identified in the Contract Documents and all additional examinations, investigations, explorations, tests, studies and data with the Contract Documents.

- 6.7 Contractor has not given Engineer written notice of any conflicts, errors, ambiguities or discrepancies that Contractor has discovered in the Contract Documents, and Contractor agrees that the Contract Documents are generally sufficient to indicate and convey understanding of all terms and conditions for performance and furnishing of the Work.
- 6.8 Contractor certifies by signing this Agreement that no Commissioner or employee of the Highlands County Board of County Commissioners has solicited or accepted gratuities, favors, or anything of monetary value from Contractor or parties to subcontracts. Contractor and Subcontractors shall not pay any gratuities, favors, or anything of monetary value to any Commissioner or employee of the Highlands County Board of County Commissioners.

Article 7. - CONTRACT DOCUMENTS

The Contract Documents which comprise the entire Contract between Owner and Contractor concerning the Work consist of the following:

- 7.1 This Agreement (pages 00500-1 to 00500-11, inclusive).
- 7.2 The Standard General Conditions of the Construction Contract, EJCDC C-700 (2013 Edition).
- 7.3 ITB 17-039 Section 00800 Supplementary Conditions to EJCDC C-700 (2013 Edition).
- 7.4 EXHIBIT “A”- Drawings and Specifications dated June 19, 2017, consisting of a cover sheet bearing the title “CONSTRUCTION PLANS FOR MARTIN LUTHER KING JR. BOULEVARD SIDEWALK EXTENSION; PROJECT NO. 15005” dated June 19, 2017, sheet 1 of 15 and sheets numbered 2 to 15, inclusive, with each sheet bearing the following general title: “ MARTIN LUTHER KING JR. BOULEVARD SIDEWALK EXTENSION”
- 7.5 Except as expressly otherwise noted in this paragraph and paragraph 7.6 of this Article, there are no Contract Documents other than those listed in paragraphs 7.1 through 7.4 of this Article. In the event of a conflict among the provisions of the Contract Documents, the order of precedence shall be this Agreement, followed by the Supplementary Conditions, followed by EJCDC C-700 (2013 Edition). The Contract Documents may only be amended to provide for additions, deletions, and revisions in the Work or to modify the terms and conditions thereof in one or more of the following ways:
- (a) Written Amendment signed by both parties
 - (b) Change Order signed by both parties
 - (c) Work Change Directive signed by both parties
- 7.6 The requirements of the Contract Documents may be supplemented and minor variations and deviations in the Work may be authorized, by one or more of the following ways:

- (a) A Field Order issued by the Engineer
- (b) Engineer's approval of a Shop Drawing
- (c) Engineer's written interpretation or clarification

Article 8. - MISCELLANEOUS

- 8.1 No assignment by a party hereto of any rights under or interests in the Contract Documents will be binding on another party hereto without the written consent of the party sought to be bound; and specifically but without limitation, moneys that may become due and moneys that are due may not be assigned without such consent (except to the extent that the effect of this restriction may be limited by Laws and Regulations), and unless specifically stated to the contrary in any written consent of an assignment no assignment will release or discharge the assignor from any duty or responsibility under the Contract Documents.
- 8.2 Owner and Contractor each binds itself, its partners, successors, assigns and legal representatives to the other party hereto, its partners, successors, assigns and legal representatives in respect to all covenants, agreements and obligations contained in the Contract Documents.
- 8.3 Any provision or part of the Contract Documents held to be void or unenforceable under any Law or Regulation shall be deemed stricken, and all remaining provisions shall continue to be valid and binding upon Owner and Contractor, who agree that the Contract Documents shall be reformed to replace such stricken provision or part thereof with a valid and enforceable provision that comes as close as possible to expressing the intention of the stricken provision.
- 8.4 Upon the occurrence of any event of default, all obligations on the part of Owner to make any further payments of funds pursuant to this Agreement shall, if Owner so elects, terminate but Owner may make any payments or parts of payments after the happening of any event of default without thereby waiving the right to exercise any remedy which it may have and without becoming liable to make any further payment.
- 8.5 No funds received pursuant to this Agreement may be expended for lobbying the Legislature, the judicial branch, any state agency, Owner or Owner's elected officials, employees or agents.
- 8.6 By entering into this Agreement, Contractor agrees and promises that, during and after a public emergency, disaster, hurricane, flood, or acts of God, Owner shall be given "first priority" for all goods and services under this Agreement. Contractor agrees to provide all goods and services to Owner during and after the emergency at the terms, conditions, and prices as provided in this Agreement on a "first priority" basis. Contractor shall furnish a twenty-four (24) hour phone number to Owner in the event of such an emergency. Failure to provide the stated priority during and after an emergency shall constitute a breach of Contract and make Contractor subject to sanctions from doing further business with Owner. For purposes of this paragraph, the term "first priority" means priority over all other contracts and agreements between Contractor and any person or entity other than Owner and requires Contractor to

deliver the goods and services described in this Agreement to Owner prior to providing those goods and services to any other person or entity during and after the emergency.

- 8.7 Owner shall not be obligated or liable hereunder to any person, organization or entity other than Contractor. No provision in this Agreement is intended to, or shall be construed to, create any third party beneficiary or to provide any rights to any person, organization or entity not a party to this Agreement, including, but not limited to, any citizen or employees of the Owner and/or Contractor.
- 8.8 In no event shall the making by Owner of any payment to Contractor constitute or be construed as a waiver by Owner of any breach of covenant or any default which may then exist, on the part of Contractor, and the making of such payment by Owner while any such breach or default exists shall in no way impair or prejudice any right or remedy available to Owner with respect to such breach or default.
- 8.9 No waiver by either Contractor or Owner with respect to any breach or default of or with respect to any provisions or conditions of this Agreement shall be deemed to constitute a continuing waiver of any other breach or default of or with respect to the same or any other provision or condition of this Agreement. No claim or right arising out of a breach of this Agreement can be discharged in whole or in part by a waiver or renunciation of the claim or right unless the waiver or renunciation is supported by consideration and is in writing signed by the aggrieved party.
- 8.10 This Agreement, including exhibits and amendments, and all matters relating to the validity, interpretation, and performance of this Agreement (whether in contract, statute, tort, or otherwise) shall be governed and construed in accordance with the laws of the State of Florida, without giving effect to principles of conflict of laws. Venue for any legal action shall lie in Highlands County, Florida, and any proceedings to enforce or interpret any provision of the Contract Documents shall be brought exclusively in a court of competent jurisdiction in Highlands County, Florida.
- 8.11 Owner is an Equal Employment Opportunity (“EEO”) employer and as such encourages Contractor to voluntarily comply with EEO regulations with regards to gender, age, race, veteran status, country of origin, and creed. In addition, Contractor or anyone under its employ shall comply with all applicable Laws and Regulations thereby pertaining to the avoidance or appearance of sexual harassment or on the job discrimination. Contractor shall maintain a work environment free of discrimination or unwelcome action of a personal nature. Any subcontracts entered into shall make deference to this clause with the same degree of application being encouraged. When applicable, Contractor shall comply with all new Laws and Regulations.
- 8.12 Contractor may only subcontract a portion of the Work to a Subcontractor or Subcontractors approved in advance, in writing by Engineer, but Contractor shall perform with its own employees and equipment work amounting to not less than forty percent (40%) of the total Contract amount.
- 8.13 This Agreement shall be effective upon execution by both parties and shall continue in effect and be binding on the parties until the Project is completed and accepted by Owner, and payment made by Owner or until this Agreement is terminated in accordance with Article 16 of Section 00700 Standard

General Conditions of the Construction Contract as modified in Section 00800 Supplementary Conditions of the Contract Documents.

8.14 Contractor shall be responsible for all quality control testing requirements.

8.15 In the event there is a discrepancy between this Agreement and the Contract Documents, the provisions of this Agreement shall govern.

Article 9. - EMPLOYMENT ELIGIBILITY VERIFICATION

9.1 Definitions. As used in this Article:

9.1.1 Employee assigned to this Agreement means an employee who was hired after November 6, 1986, who is directly performing work, in the United States, under this Agreement. An employee is not considered to be directly performing work under this Agreement if the employee.

- (a) Normally performs support work, such as indirect or overhead functions; and
- (b) Does not perform any substantial duties applicable to the Agreement.

9.1.2 Subcontract means any contract entered into by a Subcontractor to furnish supplies or services for performance of this Agreement or a subcontract under this Agreement. It includes but is not limited to purchase orders, and changes and modifications to purchase orders.

9.1.3 Subcontractor means any supplier, distributor, vendor, or firm that furnishes supplies or services to or for Contractor or another subcontractor.

9.1.4 United States, as defined in 8 U.S.C. 1101(a)(38), means the 50 States, the District of Columbia, Puerto Rico, Guam, and the U.S. Virgin Islands.

9.2 Enrollment and verification requirements.

9.2.1 Contractor must be enrolled in E-Verify at time of Contract award, and Contractor shall use E-Verify to initiate verification of employment eligibility of

- (a) All new employees,
 - (1) Enrolled thirty (30) calendar days or more. Contractor shall initiate verification of employment eligibility of all new hires of Contractor, who are working in the State of Florida, whether or not assigned to this Agreement, within three (3) business days after the date of hire; or
 - (2) Enrolled less than thirty (30) calendar days. Within thirty (30) calendar days after enrollment in E-Verify, Contractor shall initiate verification of employment eligibility of all new hires of Contractor who are

working in the State of Florida, whether or not assigned to this Agreement, within three (3) business days after the date of hire; or

- (b) Employees assigned to this Agreement. For each employee assigned to this Agreement, Contractor shall initiate verification of employment eligibility, to the extent allowed by the E-Verify program, within thirty (30) calendar days after date of Contract award or within thirty (30) calendar days after assignment to this Agreement, whichever date is later.

9.2.2 Contractor shall comply, for the period of performance of this Agreement, with the requirements of the E-Verify program Memorandum of Understanding (MOU). Termination of Contractor's MOU and denial access to the E-Verify system by the Department of Homeland Security or the Social Security Administration or the U.S. Citizenship and Immigration Service is an event of default under this Agreement.

9.3 Website. Information on registration for and use of the E-Verify program can be obtained via the Internet at the U.S. Citizenship and Immigration Service's Web site: <http://www.uscis.gov>.

9.4 Individuals previously verified. Contractor is not required by this Article to perform additional employment verification using E-Verify for any employee whose employment eligibility was previously verified by Contractor through the E-Verify program.

9.5 Subcontracts. Contractor shall include, and shall require the inclusion of, the requirements of this Article, including this paragraph (9.5) (appropriately modified for identification of the parties), in each subcontract that includes work performed in the United States under this Agreement.

Article 10. - COMPLIANCE WITH SECTION 287.135(3)(c), FLORIDA STATUTES

Pursuant to Section 287.135(3)(c), Florida Statutes, Owner may terminate this Contract, at the option of its Board of County Commissioners, if the Contractor is found to have submitted a certification required by Section 287.135(5), Florida Statutes, that is false or if Contractor is or has been placed on the Scrutinized Companies that Boycott Israel List, or is engaged in a boycott of Israel or if Contractor is or has been placed on the Scrutinized Companies with Activities in Sudan List or the Scrutinized Companies with Activities in the Iran Petroleum Energy Sector List or if Contractor is or has been engaged in business operations in Cuba or Syria.

Article 11. - NOTICES AND DESIGNATED CONTACT PERSON

Any notice required or permitted by this Contract to be given shall be deemed to have been duly given if in writing and delivered personally or five (5) days after mailing by first class registered or certified mail, return receipt requested, postage prepaid or by Federal Express, UPS or other nationally recognized delivery service, with confirmation of delivery requested, and addressed as follows:

To County:

Highlands County Board of County Commissioners
600 South Commerce Ave.
Sebring, FL 33870
Attn: _____

To Contractor:

Article 12. - PUBLIC RECORDS COMPLIANCE

If by providing services to Owner pursuant to this Contract Contractor is a contractor, as defined by Section 119.0701, Florida Statutes, Contractor shall:

- 12.1 Keep and maintain public records required by the County to perform the services.
- 12.2 Upon request from the County’s custodian of public records, provide the County with a copy of the requested records or allow the records to be inspected or copied within a reasonable time at a cost that does not exceed the cost provided in Chapter 119, Florida Statutes, or as otherwise provided by law.
- 12.3 Ensure that public records that are exempt or confidential and exempt from public records disclosure requirements are not disclosed except as authorized by law for the duration of the term of this Contract and following completion of this Contract if Contractor does not transfer the records to the County.
- 12.4 Upon completion of this Contract, transfer to the County, at no cost, all public records in possession of Contractor or keep and maintain public records required by the County to perform the services. If Contractor transfers all public records to the County upon completion of this Contract, Contractor shall destroy any duplicate public records that are exempt or confidential and exempt from public records disclosure requirements. If Contractor keeps and maintains public records upon completion of this Contract, Contractor shall meet all applicable requirements for retaining public records. All records stored electronically must be provided to the County upon request from the County’s custodian of public records, in a format that is compatible with the information technology systems of the County.

IF THE CONTRACTOR HAS QUESTIONS REGARDING THE APPLICATION OF CHAPTER 119, FLORIDA STATUTES, TO THE CONTRACTOR'S DUTY TO PROVIDE PUBLIC RECORDS RELATING TO THIS CONTRACT, CONTACT THE CUSTODIAN OF PUBLIC RECORDS AT:

Gloria Rybinski
County Public Information Officer
Telephone Number: 863-402-6836
E-mail Address: grybinski@hcbcc.org
Mailing Address: 600 South Commerce Avenue
Sebring, FL 33870

(THIS AREA INTENTIONALLY LEFT BLANK)

IN WITNESS WHEREOF, the parties of these presents have executed this Agreement in three (3) counterparts, each of which shall be deemed an original, but all of which constitute the same Agreement, in the year and day first shown and mentioned.

**OWNER: HIGHLANDS COUNTY, A POLITICAL SUBDIVISION OF THE STATE OF FLORIDA,
BY ITS BOARD OF COUNTY COMMISSIONERS**

Don Elwell, Chairman

505 S. Commerce Ave.
Sebring, FL 33870-3869

ATTEST:

Robert W. Germaine, Clerk

[SEAL]

CONTRACTOR:

Print Name: _____

Print Title: _____

ATTEST:

[CORPORATE SEAL]

Print Name: _____

Print Title: _____

SECTION 00600
PUBLIC CONSTRUCTION BOND
(Section 255.05(3), Florida Statutes)

Bond No. _____

BY THIS BOND, we, _____,
whose principal business address and phone number are _____
(_____), as Principal and _____, whose principal business
address and phone number are _____ (_____), as Surety, are bound to
Highlands County, a political subdivision of the State of Florida, herein called Owner, whose principal
business address and telephone number are 600 South Commerce Avenue, Sebring, Florida 33870 (863-402-
6500), in the sum of _____ (\$_____), for payment of which we bind
ourselves, our heirs, personal representatives, successors, and assigns, jointly and severally.

THE CONDITION OF THIS BOND is that if Principal:

1. Performs the Contract dated _____, between Principal and Owner for construction of the MARTIN LUTHER KING JR. BOULEVARD SIDEWALK EXTENSION; PROJECT NO. 15005, that Contract being made a part of this bond by reference, at the times and in the manner prescribed in the Contract; and
2. Promptly makes payments to all claimants, as defined in Section 255.05(1), Florida Statutes, supplying Principal with labor, services, materials, or supplies, used directly or indirectly by Principal in the prosecution of the work provided for in that Contract; and
3. Pays Owner all losses, damages, expenses, costs, and attorney's fees, including appellate proceedings, that Owner sustains because of a default by Principal under that Contract; and
4. Performs the Principal's guarantee of all work and materials furnished under that Contract for the time specified in that Contract, then this bond is void; otherwise it remains in full force.

Any action instituted by a claimant under this bond for payment must be in accordance with the notice and time limitation provisions in Section 255.05(2) and (10), Florida Statutes.

Any changes in or under the Contract Documents and compliance or noncompliance with any formalities connected with that Contract or the changes does not affect Surety's obligation under this bond.

Dated _____, 2017.

AS SURETY:

CONTRACTOR, AS PRINCIPAL:

By: _____
(As Attorney in Fact)

By: _____

Title: _____

INSTRUCTIONS FOR PUBLIC CONSTRUCTION BOND

1. A good and sufficient Public Construction Bond, in the penal sum of not less than one hundred percent (100%) of the Contract Price, with a surety company satisfactory to Owner, will be required of Contractor guaranteeing that the Contract, including the various guarantee periods thereunder will be faithfully performed; and that Contractor will promptly make payment to all persons supplying Contractor labor, materials, supplies and services used directly or indirectly by Contractor in the prosecution of the work provided for in the Contract.
2. The surety company furnishing this bond shall be authorized to do business in the State of Florida, shall be in compliance with the provisions of the Florida Insurance Code, shall have twice the minimum surplus and capital required by the Florida insurance code, and shall hold a currently valid certificate of authority issued by the United States Department of Treasury pursuant to Title 31, Sections 9304-9308, of the United States Code. The surety company must have a rating of not less than "A-X" by the latest edition of the KEY RATING GUIDE as published by A.M. Best Company, Inc., Ambest Road, Oldwick, NJ 08858.
3. The Attorney-in-Fact (Resident Agent) who executes the Public Construction Bond on behalf of the surety company must attach a notarized copy of his or her power-of-attorney as evidence of his or her authority to bind the surety on the date of execution of the bonds. All signatures must be original. No copied or facsimile signatures will be accepted. All Contracts, Public Construction Bond, and respective powers-of-attorney will have the same date.
4. In the event the surety company becomes unsatisfactory to Owner, Owner may at its discretion, require from Contractor an additional or new bond in the same or lessor penal sum, satisfactory to the Owner, and to be conditioned as above required. Upon Contractor's failure to furnish such additional or new bond within ten (10) days from the date of written notice to do so, all payments under the Contract will be withheld until such additional bond is furnished.

This document has important legal consequences; consultation with an attorney is encouraged with respect to its use or modification. This document should be adapted to the particular circumstances of the contemplated Project and the controlling Laws and Regulations.

STANDARD GENERAL CONDITIONS OF THE CONSTRUCTION CONTRACT

Prepared by



Issued and Published Jointly by



These General Conditions have been prepared for use with the Agreement Between Owner and Contractor for Construction Contract (EJCDC® C-520, Stipulated Sum, or C-525, Cost-Plus, 2013 Editions). Their provisions are interrelated and a change in one may necessitate a change in the other.

To prepare supplementary conditions that are coordinated with the General Conditions, use EJCDC's Guide to the Preparation of Supplementary Conditions (EJCDC® C-800, 2013 Edition). The full EJCDC Construction series of documents is discussed in the Commentary on the 2013 EJCDC Construction Documents (EJCDC® C-001, 2013 Edition).

Copyright © 2013:

National Society of Professional Engineers
1420 King Street, Alexandria, VA 22314-2794
(703) 684-2882
www.nspe.org

American Council of Engineering Companies
1015 15th Street N.W., Washington, DC 20005
(202) 347-7474
www.acec.org

American Society of Civil Engineers
1801 Alexander Bell Drive, Reston, VA 20191-4400
(800) 548-2723
www.asce.org

The copyright for this document is owned jointly by the three sponsoring organizations listed above. The National Society of Professional Engineers is the Copyright Administrator for the EJCDC documents; please direct all inquiries regarding EJCDC copyrights to NSPE.

NOTE: EJCDC publications may be purchased at www.ejcdc.org, or from any of the sponsoring organizations above.

STANDARD GENERAL CONDITIONS OF THE CONSTRUCTION CONTRACT

TABLE OF CONTENTS

	Page
Article 1 – Definitions and Terminology	1
1.01 Defined Terms	1
1.02 Terminology	5
Article 2 – Preliminary Matters	6
2.01 Delivery of Bonds and Evidence of Insurance	6
2.02 Copies of Documents	6
2.03 Before Starting Construction	6
2.04 Preconstruction Conference; Designation of Authorized Representatives	7
2.05 Initial Acceptance of Schedules	7
2.06 Electronic Transmittals.....	7
Article 3 – Documents: Intent, Requirements, Reuse	8
3.01 Intent.....	8
3.02 Reference Standards	8
3.03 Reporting and Resolving Discrepancies	8
3.04 Requirements of the Contract Documents	9
3.05 Reuse of Documents	10
Article 4 – Commencement and Progress of the Work	10
4.01 Commencement of Contract Times; Notice to Proceed	10
4.02 Starting the Work.....	10
4.03 Reference Points	10
4.04 Progress Schedule	10
4.05 Delays in Contractor’s Progress	11
Article 5 – Availability of Lands; Subsurface and Physical Conditions; Hazardous Environmental Conditions	12
5.01 Availability of Lands	12
5.02 Use of Site and Other Areas	12
5.03 Subsurface and Physical Conditions.....	13
5.04 Differing Subsurface or Physical Conditions	14
5.05 Underground Facilities	15

5.06	Hazardous Environmental Conditions at Site	17
Article 6 – Bonds and Insurance		19
6.01	Performance, Payment, and Other Bonds	19
6.02	Insurance—General Provisions	19
6.03	Contractor’s Insurance	20
6.04	Owner’s Liability Insurance	23
6.05	Property Insurance.....	23
6.06	Waiver of Rights	25
6.07	Receipt and Application of Property Insurance Proceeds	25
Article 7 – Contractor’s Responsibilities		26
7.01	Supervision and Superintendence	26
7.02	Labor; Working Hours	26
7.03	Services, Materials, and Equipment.....	26
7.04	“Or Equals”	27
7.05	Substitutes	28
7.06	Concerning Subcontractors, Suppliers, and Others	29
7.07	Patent Fees and Royalties	31
7.08	Permits	31
7.09	Taxes	32
7.10	Laws and Regulations.....	32
7.11	Record Documents.....	32
7.12	Safety and Protection.....	32
7.13	Safety Representative	33
7.14	Hazard Communication Programs	33
7.15	Emergencies	34
7.16	Shop Drawings, Samples, and Other Submittals.....	34
7.17	Contractor’s General Warranty and Guarantee.....	36
7.18	Indemnification	37
7.19	Delegation of Professional Design Services	37
Article 8 – Other Work at the Site		38
8.01	Other Work	38
8.02	Coordination	39
8.03	Legal Relationships.....	39

Article 9 – Owner’s Responsibilities.....	40
9.01 Communications to Contractor.....	40
9.02 Replacement of Engineer	40
9.03 Furnish Data	40
9.04 Pay When Due.....	40
9.05 Lands and Easements; Reports, Tests, and Drawings	40
9.06 Insurance.....	40
9.07 Change Orders.....	40
9.08 Inspections, Tests, and Approvals.....	41
9.09 Limitations on Owner’s Responsibilities	41
9.10 Undisclosed Hazardous Environmental Condition.....	41
9.11 Evidence of Financial Arrangements.....	41
9.12 Safety Programs	41
Article 10 – Engineer’s Status During Construction.....	41
10.01 Owner’s Representative.....	41
10.02 Visits to Site.....	41
10.03 Project Representative.....	42
10.04 Rejecting Defective Work.....	42
10.05 Shop Drawings, Change Orders and Payments.....	42
10.06 Determinations for Unit Price Work	42
10.07 Decisions on Requirements of Contract Documents and Acceptability of Work	42
10.08 Limitations on Engineer’s Authority and Responsibilities.....	42
10.09 Compliance with Safety Program.....	43
Article 11 – Amending the Contract Documents; Changes in the Work	43
11.01 Amending and Supplementing Contract Documents	43
11.02 Owner-Authorized Changes in the Work	44
11.03 Unauthorized Changes in the Work.....	44
11.04 Change of Contract Price	44
11.05 Change of Contract Times	45
11.06 Change Proposals.....	45
11.07 Execution of Change Orders.....	46
11.08 Notification to Surety.....	47
Article 12 – Claims.....	47

12.01	Claims	47
Article 13 –	Cost of the Work; Allowances; Unit Price Work.....	48
13.01	Cost of the Work	48
13.02	Allowances	50
13.03	Unit Price Work	51
Article 14 –	Tests and Inspections; Correction, Removal or Acceptance of Defective Work.....	52
14.01	Access to Work.....	52
14.02	Tests, Inspections, and Approvals.....	52
14.03	Defective Work.....	53
14.04	Acceptance of Defective Work.....	53
14.05	Uncovering Work	53
14.06	Owner May Stop the Work	54
14.07	Owner May Correct Defective Work.....	54
Article 15 –	Payments to Contractor; Set-Offs; Completion; Correction Period	55
15.01	Progress Payments.....	55
15.02	Contractor’s Warranty of Title	58
15.03	Substantial Completion.....	58
15.04	Partial Use or Occupancy	59
15.05	Final Inspection	59
15.06	Final Payment.....	59
15.07	Waiver of Claims	61
15.08	Correction Period	61
Article 16 –	Suspension of Work and Termination	62
16.01	Owner May Suspend Work	62
16.02	Owner May Terminate for Cause	62
16.03	Owner May Terminate For Convenience	63
16.04	Contractor May Stop Work or Terminate	63
Article 17 –	Final Resolution of Disputes	64
17.01	Methods and Procedures.....	64
Article 18 –	Miscellaneous	64
18.01	Giving Notice	64
18.02	Computation of Times.....	64
18.03	Cumulative Remedies	64

18.04 Limitation of Damages 65
18.05 No Waiver 65
18.06 Survival of Obligations 65
18.07 Controlling Law 65
18.08 Headings..... 65

ARTICLE 1 – DEFINITIONS AND TERMINOLOGY

1.01 *Defined Terms*

- A. Wherever used in the Bidding Requirements or Contract Documents, a term printed with initial capital letters, including the term's singular and plural forms, will have the meaning indicated in the definitions below. In addition to terms specifically defined, terms with initial capital letters in the Contract Documents include references to identified articles and paragraphs, and the titles of other documents or forms.
1. *Addenda*—Written or graphic instruments issued prior to the opening of Bids which clarify, correct, or change the Bidding Requirements or the proposed Contract Documents.
 2. *Agreement*—The written instrument, executed by Owner and Contractor, that sets forth the Contract Price and Contract Times, identifies the parties and the Engineer, and designates the specific items that are Contract Documents.
 3. *Application for Payment*—The form acceptable to Engineer which is to be used by Contractor during the course of the Work in requesting progress or final payments and which is to be accompanied by such supporting documentation as is required by the Contract Documents.
 4. *Bid*—The offer of a Bidder submitted on the prescribed form setting forth the prices for the Work to be performed.
 5. *Bidder*—An individual or entity that submits a Bid to Owner.
 6. *Bidding Documents*—The Bidding Requirements, the proposed Contract Documents, and all Addenda.
 7. *Bidding Requirements*—The advertisement or invitation to bid, Instructions to Bidders, Bid Bond or other Bid security, if any, the Bid Form, and the Bid with any attachments.
 8. *Change Order*—A document which is signed by Contractor and Owner and authorizes an addition, deletion, or revision in the Work or an adjustment in the Contract Price or the Contract Times, or other revision to the Contract, issued on or after the Effective Date of the Contract.
 9. *Change Proposal*—A written request by Contractor, duly submitted in compliance with the procedural requirements set forth herein, seeking an adjustment in Contract Price or Contract Times, or both; contesting an initial decision by Engineer concerning the requirements of the Contract Documents or the acceptability of Work under the Contract Documents; challenging a set-off against payments due; or seeking other relief with respect to the terms of the Contract.
 10. *Claim*—(a) A demand or assertion by Owner directly to Contractor, duly submitted in compliance with the procedural requirements set forth herein: seeking an adjustment of Contract Price or Contract Times, or both; contesting an initial decision by Engineer concerning the requirements of the Contract Documents or the acceptability of Work under the Contract Documents; contesting Engineer's decision regarding a Change Proposal; seeking resolution of a contractual issue that Engineer has declined to address; or seeking other relief with respect to the terms of the Contract; or (b) a demand or assertion by Contractor directly to Owner, duly submitted in compliance with the procedural requirements set forth herein, contesting Engineer's decision regarding a Change Proposal; or seeking resolution of a contractual issue that Engineer

has declined to address. A demand for money or services by a third party is not a Claim.

11. *Constituent of Concern*—Asbestos, petroleum, radioactive materials, polychlorinated biphenyls (PCBs), hazardous waste, and any substance, product, waste, or other material of any nature whatsoever that is or becomes listed, regulated, or addressed pursuant to (a) the Comprehensive Environmental Response, Compensation and Liability Act, 42 U.S.C. §§9601 et seq. (“CERCLA”); (b) the Hazardous Materials Transportation Act, 49 U.S.C. §§5501 et seq.; (c) the Resource Conservation and Recovery Act, 42 U.S.C. §§6901 et seq. (“RCRA”); (d) the Toxic Substances Control Act, 15 U.S.C. §§2601 et seq.; (e) the Clean Water Act, 33 U.S.C. §§1251 et seq.; (f) the Clean Air Act, 42 U.S.C. §§7401 et seq.; or (g) any other federal, state, or local statute, law, rule, regulation, ordinance, resolution, code, order, or decree regulating, relating to, or imposing liability or standards of conduct concerning, any hazardous, toxic, or dangerous waste, substance, or material.
12. *Contract*—The entire and integrated written contract between the Owner and Contractor concerning the Work.
13. *Contract Documents*—Those items so designated in the Agreement, and which together comprise the Contract.
14. *Contract Price*—The money that Owner has agreed to pay Contractor for completion of the Work in accordance with the Contract Documents. .
15. *Contract Times*—The number of days or the dates by which Contractor shall: (a) achieve Milestones, if any; (b) achieve Substantial Completion; and (c) complete the Work.
16. *Contractor*—The individual or entity with which Owner has contracted for performance of the Work.
17. *Cost of the Work*—See Paragraph 13.01 for definition.
18. *Drawings*—The part of the Contract that graphically shows the scope, extent, and character of the Work to be performed by Contractor.
19. *Effective Date of the Contract*—The date, indicated in the Agreement, on which the Contract becomes effective.
20. *Engineer*—The individual or entity named as such in the Agreement.
21. *Field Order*—A written order issued by Engineer which requires minor changes in the Work but does not change the Contract Price or the Contract Times.
22. *Hazardous Environmental Condition*—The presence at the Site of Constituents of Concern in such quantities or circumstances that may present a danger to persons or property exposed thereto. The presence at the Site of materials that are necessary for the execution of the Work, or that are to be incorporated in the Work, and that are controlled and contained pursuant to industry practices, Laws and Regulations, and the requirements of the Contract, does not establish a Hazardous Environmental Condition.
23. *Laws and Regulations; Laws or Regulations*—Any and all applicable laws, statutes, rules, regulations, ordinances, codes, and orders of any and all governmental bodies, agencies, authorities, and courts having jurisdiction.

24. *Liens*—Charges, security interests, or encumbrances upon Contract-related funds, real property, or personal property.
25. *Milestone*—A principal event in the performance of the Work that the Contract requires Contractor to achieve by an intermediate completion date or by a time prior to Substantial Completion of all the Work.
26. *Notice of Award*—The written notice by Owner to a Bidder of Owner’s acceptance of the Bid.
27. *Notice to Proceed*—A written notice by Owner to Contractor fixing the date on which the Contract Times will commence to run and on which Contractor shall start to perform the Work.
28. *Owner*—The individual or entity with which Contractor has contracted regarding the Work, and which has agreed to pay Contractor for the performance of the Work, pursuant to the terms of the Contract.
29. *Progress Schedule*—A schedule, prepared and maintained by Contractor, describing the sequence and duration of the activities comprising the Contractor’s plan to accomplish the Work within the Contract Times.
30. *Project*—The total undertaking to be accomplished for Owner by engineers, contractors, and others, including planning, study, design, construction, testing, commissioning, and start-up, and of which the Work to be performed under the Contract Documents is a part.
31. *Project Manual*—The written documents prepared for, or made available for, procuring and constructing the Work, including but not limited to the Bidding Documents or other construction procurement documents, geotechnical and existing conditions information, the Agreement, bond forms, General Conditions, Supplementary Conditions, and Specifications. The contents of the Project Manual may be bound in one or more volumes.
32. *Resident Project Representative*—The authorized representative of Engineer assigned to assist Engineer at the Site. As used herein, the term Resident Project Representative or “RPR” includes any assistants or field staff of Resident Project Representative.
33. *Samples*—Physical examples of materials, equipment, or workmanship that are representative of some portion of the Work and that establish the standards by which such portion of the Work will be judged.
34. *Schedule of Submittals*—A schedule, prepared and maintained by Contractor, of required submittals and the time requirements for Engineer’s review of the submittals and the performance of related construction activities.
35. *Schedule of Values*—A schedule, prepared and maintained by Contractor, allocating portions of the Contract Price to various portions of the Work and used as the basis for reviewing Contractor’s Applications for Payment.
36. *Shop Drawings*—All drawings, diagrams, illustrations, schedules, and other data or information that are specifically prepared or assembled by or for Contractor and submitted by Contractor to illustrate some portion of the Work. Shop Drawings, whether approved or not, are not Drawings and are not Contract Documents.

37. *Site*—Lands or areas indicated in the Contract Documents as being furnished by Owner upon which the Work is to be performed, including rights-of-way and easements, and such other lands furnished by Owner which are designated for the use of Contractor.
38. *Specifications*—The part of the Contract that consists of written requirements for materials, equipment, systems, standards, and workmanship as applied to the Work, and certain administrative requirements and procedural matters applicable to the Work.
39. *Subcontractor*—An individual or entity having a direct contract with Contractor or with any other Subcontractor for the performance of a part of the Work.
40. *Substantial Completion*—The time at which the Work (or a specified part thereof) has progressed to the point where, in the opinion of Engineer, the Work (or a specified part thereof) is sufficiently complete, in accordance with the Contract Documents, so that the Work (or a specified part thereof) can be utilized for the purposes for which it is intended. The terms “substantially complete” and “substantially completed” as applied to all or part of the Work refer to Substantial Completion thereof.
41. *Successful Bidder*—The Bidder whose Bid the Owner accepts, and to which the Owner makes an award of contract, subject to stated conditions.
42. *Supplementary Conditions*—The part of the Contract that amends or supplements these General Conditions.
43. *Supplier*—A manufacturer, fabricator, supplier, distributor, materialman, or vendor having a direct contract with Contractor or with any Subcontractor to furnish materials or equipment to be incorporated in the Work by Contractor or a Subcontractor.
44. *Technical Data*—Those items expressly identified as Technical Data in the Supplementary Conditions, with respect to either (a) subsurface conditions at the Site, or physical conditions relating to existing surface or subsurface structures at the Site (except Underground Facilities) or (b) Hazardous Environmental Conditions at the Site. If no such express identifications of Technical Data have been made with respect to conditions at the Site, then the data contained in boring logs, recorded measurements of subsurface water levels, laboratory test results, and other factual, objective information regarding conditions at the Site that are set forth in any geotechnical or environmental report prepared for the Project and made available to Contractor are hereby defined as Technical Data with respect to conditions at the Site under Paragraphs 5.03, 5.04, and 5.06.
45. *Underground Facilities*—All underground pipelines, conduits, ducts, cables, wires, manholes, vaults, tanks, tunnels, or other such facilities or attachments, and any encasements containing such facilities, including but not limited to those that convey electricity, gases, steam, liquid petroleum products, telephone or other communications, fiber optic transmissions, cable television, water, wastewater, storm water, other liquids or chemicals, or traffic or other control systems.
46. *Unit Price Work*—Work to be paid for on the basis of unit prices.
47. *Work*—The entire construction or the various separately identifiable parts thereof required to be provided under the Contract Documents. Work includes and is the result of performing or providing all labor, services, and documentation necessary to produce such construction; furnishing, installing, and incorporating all materials and equipment into such construction; and may include related services such as testing, start-up, and commissioning, all as required by the Contract Documents.

48. *Work Change Directive*—A written directive to Contractor issued on or after the Effective Date of the Contract, signed by Owner and recommended by Engineer, ordering an addition, deletion, or revision in the Work.

1.02 Terminology

- A. The words and terms discussed in the following paragraphs are not defined but, when used in the Bidding Requirements or Contract Documents, have the indicated meaning.
- B. *Intent of Certain Terms or Adjectives:*
 1. The Contract Documents include the terms “as allowed,” “as approved,” “as ordered,” “as directed” or terms of like effect or import to authorize an exercise of professional judgment by Engineer. In addition, the adjectives “reasonable,” “suitable,” “acceptable,” “proper,” “satisfactory,” or adjectives of like effect or import are used to describe an action or determination of Engineer as to the Work. It is intended that such exercise of professional judgment, action, or determination will be solely to evaluate, in general, the Work for compliance with the information in the Contract Documents and with the design concept of the Project as a functioning whole as shown or indicated in the Contract Documents (unless there is a specific statement indicating otherwise). The use of any such term or adjective is not intended to and shall not be effective to assign to Engineer any duty or authority to supervise or direct the performance of the Work, or any duty or authority to undertake responsibility contrary to the provisions of Article 10 or any other provision of the Contract Documents.
- C. *Day:*
 1. The word “day” means a calendar day of 24 hours measured from midnight to the next midnight.
- D. *Defective:*
 1. The word “defective,” when modifying the word “Work,” refers to Work that is unsatisfactory, faulty, or deficient in that it:
 - a. does not conform to the Contract Documents; or
 - b. does not meet the requirements of any applicable inspection, reference standard, test, or approval referred to in the Contract Documents; or
 - c. has been damaged prior to Engineer’s recommendation of final payment (unless responsibility for the protection thereof has been assumed by Owner at Substantial Completion in accordance with Paragraph 15.03 or 15.04).
- E. *Furnish, Install, Perform, Provide:*
 1. The word “furnish,” when used in connection with services, materials, or equipment, shall mean to supply and deliver said services, materials, or equipment to the Site (or some other specified location) ready for use or installation and in usable or operable condition.
 2. The word “install,” when used in connection with services, materials, or equipment, shall mean to put into use or place in final position said services, materials, or equipment complete and ready for intended use.

3. The words “perform” or “provide,” when used in connection with services, materials, or equipment, shall mean to furnish and install said services, materials, or equipment complete and ready for intended use.
 4. If the Contract Documents establish an obligation of Contractor with respect to specific services, materials, or equipment, but do not expressly use any of the four words “furnish,” “install,” “perform,” or “provide,” then Contractor shall furnish and install said services, materials, or equipment complete and ready for intended use.
- F. Unless stated otherwise in the Contract Documents, words or phrases that have a well-known technical or construction industry or trade meaning are used in the Contract Documents in accordance with such recognized meaning.

ARTICLE 2 – PRELIMINARY MATTERS

2.01 *Delivery of Bonds and Evidence of Insurance*

- A. *Bonds*: When Contractor delivers the executed counterparts of the Agreement to Owner, Contractor shall also deliver to Owner such bonds as Contractor may be required to furnish.
- B. *Evidence of Contractor’s Insurance*: When Contractor delivers the executed counterparts of the Agreement to Owner, Contractor shall also deliver to Owner, with copies to each named insured and additional insured (as identified in the Supplementary Conditions or elsewhere in the Contract), the certificates and other evidence of insurance required to be provided by Contractor in accordance with Article 6.
- C. *Evidence of Owner’s Insurance*: After receipt of the executed counterparts of the Agreement and all required bonds and insurance documentation, Owner shall promptly deliver to Contractor, with copies to each named insured and additional insured (as identified in the Supplementary Conditions or otherwise), the certificates and other evidence of insurance required to be provided by Owner under Article 6.

2.02 *Copies of Documents*

- A. Owner shall furnish to Contractor four printed copies of the Contract (including one fully executed counterpart of the Agreement), and one copy in electronic portable document format (PDF). Additional printed copies will be furnished upon request at the cost of reproduction.
- B. Owner shall maintain and safeguard at least one original printed record version of the Contract, including Drawings and Specifications signed and sealed by Engineer and other design professionals. Owner shall make such original printed record version of the Contract available to Contractor for review. Owner may delegate the responsibilities under this provision to Engineer.

2.03 *Before Starting Construction*

- A. *Preliminary Schedules*: Within 10 days after the Effective Date of the Contract (or as otherwise specifically required by the Contract Documents), Contractor shall submit to Engineer for timely review:
 1. a preliminary Progress Schedule indicating the times (numbers of days or dates) for starting and completing the various stages of the Work, including any Milestones specified in the Contract;
 2. a preliminary Schedule of Submittals; and

3. a preliminary Schedule of Values for all of the Work which includes quantities and prices of items which when added together equal the Contract Price and subdivides the Work into component parts in sufficient detail to serve as the basis for progress payments during performance of the Work. Such prices will include an appropriate amount of overhead and profit applicable to each item of Work.

2.04 *Preconstruction Conference; Designation of Authorized Representatives*

- A. Before any Work at the Site is started, a conference attended by Owner, Contractor, Engineer, and others as appropriate will be held to establish a working understanding among the parties as to the Work and to discuss the schedules referred to in Paragraph 2.03.A, procedures for handling Shop Drawings, Samples, and other submittals, processing Applications for Payment, electronic or digital transmittals, and maintaining required records.
- B. At this conference Owner and Contractor each shall designate, in writing, a specific individual to act as its authorized representative with respect to the services and responsibilities under the Contract. Such individuals shall have the authority to transmit and receive information, render decisions relative to the Contract, and otherwise act on behalf of each respective party.

2.05 *Initial Acceptance of Schedules*

- A. At least 10 days before submission of the first Application for Payment a conference, attended by Contractor, Engineer, and others as appropriate, will be held to review for acceptability to Engineer as provided below the schedules submitted in accordance with Paragraph 2.03.A. Contractor shall have an additional 10 days to make corrections and adjustments and to complete and resubmit the schedules. No progress payment shall be made to Contractor until acceptable schedules are submitted to Engineer.
 1. The Progress Schedule will be acceptable to Engineer if it provides an orderly progression of the Work to completion within the Contract Times. Such acceptance will not impose on Engineer responsibility for the Progress Schedule, for sequencing, scheduling, or progress of the Work, nor interfere with or relieve Contractor from Contractor's full responsibility therefor.
 2. Contractor's Schedule of Submittals will be acceptable to Engineer if it provides a workable arrangement for reviewing and processing the required submittals.
 3. Contractor's Schedule of Values will be acceptable to Engineer as to form and substance if it provides a reasonable allocation of the Contract Price to the component parts of the Work.

2.06 *Electronic Transmittals*

- A. Except as otherwise stated elsewhere in the Contract, the Owner, Engineer, and Contractor may transmit, and shall accept, Project-related correspondence, text, data, documents, drawings, information, and graphics, including but not limited to Shop Drawings and other submittals, in electronic media or digital format, either directly, or through access to a secure Project website.
- B. If the Contract does not establish protocols for electronic or digital transmittals, then Owner, Engineer, and Contractor shall jointly develop such protocols.
- C. When transmitting items in electronic media or digital format, the transmitting party makes no representations as to long term compatibility, usability, or readability of the items resulting from the recipient's use of software application packages, operating systems, or

computer hardware differing from those used in the drafting or transmittal of the items, or from those established in applicable transmittal protocols.

ARTICLE 3 – DOCUMENTS: INTENT, REQUIREMENTS, REUSE

3.01 *Intent*

- A. The Contract Documents are complementary; what is required by one is as binding as if required by all.
- B. It is the intent of the Contract Documents to describe a functionally complete project (or part thereof) to be constructed in accordance with the Contract Documents.
- C. Unless otherwise stated in the Contract Documents, if there is a discrepancy between the electronic or digital versions of the Contract Documents (including any printed copies derived from such electronic or digital versions) and the printed record version, the printed record version shall govern.
- D. The Contract supersedes prior negotiations, representations, and agreements, whether written or oral.
- E. Engineer will issue clarifications and interpretations of the Contract Documents as provided herein.

3.02 *Reference Standards*

- A. Standards Specifications, Codes, Laws and Regulations
 - 1. Reference in the Contract Documents to standard specifications, manuals, reference standards, or codes of any technical society, organization, or association, or to Laws or Regulations, whether such reference be specific or by implication, shall mean the standard specification, manual, reference standard, code, or Laws or Regulations in effect at the time of opening of Bids (or on the Effective Date of the Contract if there were no Bids), except as may be otherwise specifically stated in the Contract Documents.
 - 2. No provision of any such standard specification, manual, reference standard, or code, or any instruction of a Supplier, shall be effective to change the duties or responsibilities of Owner, Contractor, or Engineer, or any of their subcontractors, consultants, agents, or employees, from those set forth in the part of the Contract Documents prepared by or for Engineer. No such provision or instruction shall be effective to assign to Owner, Engineer, or any of their officers, directors, members, partners, employees, agents, consultants, or subcontractors, any duty or authority to supervise or direct the performance of the Work or any duty or authority to undertake responsibility inconsistent with the provisions of the part of the Contract Documents prepared by or for Engineer.

3.03 *Reporting and Resolving Discrepancies*

- A. *Reporting Discrepancies:*
 - 1. *Contractor's Verification of Figures and Field Measurements:* Before undertaking each part of the Work, Contractor shall carefully study the Contract Documents, and check and verify pertinent figures and dimensions therein, particularly with respect to applicable field measurements. Contractor shall promptly report in writing to Engineer any conflict, error, ambiguity, or discrepancy that Contractor discovers, or has actual knowledge of, and shall not proceed with any Work affected thereby until the conflict,

error, ambiguity, or discrepancy is resolved, by a clarification or interpretation by Engineer, or by an amendment or supplement to the Contract Documents issued pursuant to Paragraph 11.01.

2. *Contractor's Review of Contract Documents:* If, before or during the performance of the Work, Contractor discovers any conflict, error, ambiguity, or discrepancy within the Contract Documents, or between the Contract Documents and (a) any applicable Law or Regulation, (b) actual field conditions, (c) any standard specification, manual, reference standard, or code, or (d) any instruction of any Supplier, then Contractor shall promptly report it to Engineer in writing. Contractor shall not proceed with the Work affected thereby (except in an emergency as required by Paragraph 7.15) until the conflict, error, ambiguity, or discrepancy is resolved, by a clarification or interpretation by Engineer, or by an amendment or supplement to the Contract Documents issued pursuant to Paragraph 11.01.
3. Contractor shall not be liable to Owner or Engineer for failure to report any conflict, error, ambiguity, or discrepancy in the Contract Documents unless Contractor had actual knowledge thereof.

B. *Resolving Discrepancies:*

1. Except as may be otherwise specifically stated in the Contract Documents, the provisions of the part of the Contract Documents prepared by or for Engineer shall take precedence in resolving any conflict, error, ambiguity, or discrepancy between such provisions of the Contract Documents and:
 - a. the provisions of any standard specification, manual, reference standard, or code, or the instruction of any Supplier (whether or not specifically incorporated by reference as a Contract Document); or
 - b. the provisions of any Laws or Regulations applicable to the performance of the Work (unless such an interpretation of the provisions of the Contract Documents would result in violation of such Law or Regulation).

3.04 *Requirements of the Contract Documents*

- A. During the performance of the Work and until final payment, Contractor and Owner shall submit to the Engineer all matters in question concerning the requirements of the Contract Documents (sometimes referred to as requests for information or interpretation—RFIs), or relating to the acceptability of the Work under the Contract Documents, as soon as possible after such matters arise. Engineer will be the initial interpreter of the requirements of the Contract Documents, and judge of the acceptability of the Work thereunder.
- B. Engineer will, with reasonable promptness, render a written clarification, interpretation, or decision on the issue submitted, or initiate an amendment or supplement to the Contract Documents. Engineer's written clarification, interpretation, or decision will be final and binding on Contractor, unless it appeals by submitting a Change Proposal, and on Owner, unless it appeals by filing a Claim.
- C. If a submitted matter in question concerns terms and conditions of the Contract Documents that do not involve (1) the performance or acceptability of the Work under the Contract Documents, (2) the design (as set forth in the Drawings, Specifications, or otherwise), or (3) other engineering or technical matters, then Engineer will promptly give written notice to Owner and Contractor that Engineer is unable to provide a decision or interpretation. If Owner and Contractor are unable to agree on resolution of such a matter in question, either party may pursue resolution as provided in Article 12.

3.05 *Reuse of Documents*

- A. Contractor and its Subcontractors and Suppliers shall not:
 - 1. have or acquire any title to or ownership rights in any of the Drawings, Specifications, or other documents (or copies of any thereof) prepared by or bearing the seal of Engineer or its consultants, including electronic media editions, or reuse any such Drawings, Specifications, other documents, or copies thereof on extensions of the Project or any other project without written consent of Owner and Engineer and specific written verification or adaptation by Engineer; or
 - 2. have or acquire any title or ownership rights in any other Contract Documents, reuse any such Contract Documents for any purpose without Owner's express written consent, or violate any copyrights pertaining to such Contract Documents.
- B. The prohibitions of this Paragraph 3.05 will survive final payment, or termination of the Contract. Nothing herein shall preclude Contractor from retaining copies of the Contract Documents for record purposes.

ARTICLE 4 – COMMENCEMENT AND PROGRESS OF THE WORK

4.01 *Commencement of Contract Times; Notice to Proceed*

- A. The Contract Times will commence to run on the thirtieth day after the Effective Date of the Contract or, if a Notice to Proceed is given, on the day indicated in the Notice to Proceed. A Notice to Proceed may be given at any time within 30 days after the Effective Date of the Contract. In no event will the Contract Times commence to run later than the sixtieth day after the day of Bid opening or the thirtieth day after the Effective Date of the Contract, whichever date is earlier.

4.02 *Starting the Work*

- A. Contractor shall start to perform the Work on the date when the Contract Times commence to run. No Work shall be done at the Site prior to such date.

4.03 *Reference Points*

- A. Owner shall provide engineering surveys to establish reference points for construction which in Engineer's judgment are necessary to enable Contractor to proceed with the Work. Contractor shall be responsible for laying out the Work, shall protect and preserve the established reference points and property monuments, and shall make no changes or relocations without the prior written approval of Owner. Contractor shall report to Engineer whenever any reference point or property monument is lost or destroyed or requires relocation because of necessary changes in grades or locations, and shall be responsible for the accurate replacement or relocation of such reference points or property monuments by professionally qualified personnel.

4.04 *Progress Schedule*

- A. Contractor shall adhere to the Progress Schedule established in accordance with Paragraph 2.05 as it may be adjusted from time to time as provided below.
 - 1. Contractor shall submit to Engineer for acceptance (to the extent indicated in Paragraph 2.05) proposed adjustments in the Progress Schedule that will not result in changing the Contract Times.

2. Proposed adjustments in the Progress Schedule that will change the Contract Times shall be submitted in accordance with the requirements of Article 11.
- B. Contractor shall carry on the Work and adhere to the Progress Schedule during all disputes or disagreements with Owner. No Work shall be delayed or postponed pending resolution of any disputes or disagreements, or during any appeal process, except as permitted by Paragraph 16.04, or as Owner and Contractor may otherwise agree in writing.

4.05 *Delays in Contractor's Progress*

- A. If Owner, Engineer, or anyone for whom Owner is responsible, delays, disrupts, or interferes with the performance or progress of the Work, then Contractor shall be entitled to an equitable adjustment in the Contract Times and Contract Price. Contractor's entitlement to an adjustment of the Contract Times is conditioned on such adjustment being essential to Contractor's ability to complete the Work within the Contract Times.
- B. Contractor shall not be entitled to an adjustment in Contract Price or Contract Times for delay, disruption, or interference caused by or within the control of Contractor. Delay, disruption, and interference attributable to and within the control of a Subcontractor or Supplier shall be deemed to be within the control of Contractor.
- C. If Contractor's performance or progress is delayed, disrupted, or interfered with by unanticipated causes not the fault of and beyond the control of Owner, Contractor, and those for which they are responsible, then Contractor shall be entitled to an equitable adjustment in Contract Times. Contractor's entitlement to an adjustment of the Contract Times is conditioned on such adjustment being essential to Contractor's ability to complete the Work within the Contract Times. Such an adjustment shall be Contractor's sole and exclusive remedy for the delays, disruption, and interference described in this paragraph. Causes of delay, disruption, or interference that may give rise to an adjustment in Contract Times under this paragraph include but are not limited to the following:
1. severe and unavoidable natural catastrophes such as fires, floods, epidemics, and earthquakes;
 2. abnormal weather conditions;
 3. acts or failures to act of utility owners (other than those performing other work at or adjacent to the Site by arrangement with the Owner, as contemplated in Article 8); and
 4. acts of war or terrorism.
- D. Delays, disruption, and interference to the performance or progress of the Work resulting from the existence of a differing subsurface or physical condition, an Underground Facility that was not shown or indicated by the Contract Documents, or not shown or indicated with reasonable accuracy, and those resulting from Hazardous Environmental Conditions, are governed by Article 5.
- E. Paragraph 8.03 governs delays, disruption, and interference to the performance or progress of the Work resulting from the performance of certain other work at or adjacent to the Site.
- F. Contractor shall not be entitled to an adjustment in Contract Price or Contract Times for any delay, disruption, or interference if such delay is concurrent with a delay, disruption, or interference caused by or within the control of Contractor.

- G. Contractor must submit any Change Proposal seeking an adjustment in Contract Price or Contract Times under this paragraph within 30 days of the commencement of the delaying, disrupting, or interfering event.

ARTICLE 5 – AVAILABILITY OF LANDS; SUBSURFACE AND PHYSICAL CONDITIONS; HAZARDOUS ENVIRONMENTAL CONDITIONS

5.01 *Availability of Lands*

- A. Owner shall furnish the Site. Owner shall notify Contractor of any encumbrances or restrictions not of general application but specifically related to use of the Site with which Contractor must comply in performing the Work.
- B. Upon reasonable written request, Owner shall furnish Contractor with a current statement of record legal title and legal description of the lands upon which permanent improvements are to be made and Owner's interest therein as necessary for giving notice of or filing a mechanic's or construction lien against such lands in accordance with applicable Laws and Regulations.
- C. Contractor shall provide for all additional lands and access thereto that may be required for temporary construction facilities or storage of materials and equipment.

5.02 *Use of Site and Other Areas*

A. *Limitation on Use of Site and Other Areas:*

- 1. Contractor shall confine construction equipment, temporary construction facilities, the storage of materials and equipment, and the operations of workers to the Site, adjacent areas that Contractor has arranged to use through construction easements or otherwise, and other adjacent areas permitted by Laws and Regulations, and shall not unreasonably encumber the Site and such other adjacent areas with construction equipment or other materials or equipment. Contractor shall assume full responsibility for (a) damage to the Site; (b) damage to any such other adjacent areas used for Contractor's operations; (c) damage to any other adjacent land or areas; and (d) for injuries and losses sustained by the owners or occupants of any such land or areas; provided that such damage or injuries result from the performance of the Work or from other actions or conduct of the Contractor or those for which Contractor is responsible.
- 2. If a damage or injury claim is made by the owner or occupant of any such land or area because of the performance of the Work, or because of other actions or conduct of the Contractor or those for which Contractor is responsible, Contractor shall (a) take immediate corrective or remedial action as required by Paragraph 7.12, or otherwise; (b) promptly attempt to settle the claim as to all parties through negotiations with such owner or occupant, or otherwise resolve the claim by arbitration or other dispute resolution proceeding, or at law; and (c) to the fullest extent permitted by Laws and Regulations, indemnify and hold harmless Owner and Engineer, and the officers, directors, members, partners, employees, agents, consultants and subcontractors of each and any of them from and against any such claim, and against all costs, losses, and damages (including but not limited to all fees and charges of engineers, architects, attorneys, and other professionals and all court or arbitration or other dispute resolution costs) arising out of or relating to any claim or action, legal or equitable, brought by any such owner or occupant against Owner, Engineer, or any other party indemnified hereunder to the extent caused directly or indirectly, in whole or in part

by, or based upon, Contractor's performance of the Work, or because of other actions or conduct of the Contractor or those for which Contractor is responsible.

- B. *Removal of Debris During Performance of the Work:* During the progress of the Work the Contractor shall keep the Site and other adjacent areas free from accumulations of waste materials, rubbish, and other debris. Removal and disposal of such waste materials, rubbish, and other debris shall conform to applicable Laws and Regulations.
- C. *Cleaning:* Prior to Substantial Completion of the Work Contractor shall clean the Site and the Work and make it ready for utilization by Owner. At the completion of the Work Contractor shall remove from the Site and adjacent areas all tools, appliances, construction equipment and machinery, and surplus materials and shall restore to original condition all property not designated for alteration by the Contract Documents.
- D. *Loading of Structures:* Contractor shall not load nor permit any part of any structure to be loaded in any manner that will endanger the structure, nor shall Contractor subject any part of the Work or adjacent structures or land to stresses or pressures that will endanger them.

5.03 *Subsurface and Physical Conditions*

- A. *Reports and Drawings:* The Supplementary Conditions identify:
 - 1. those reports known to Owner of explorations and tests of subsurface conditions at or adjacent to the Site;
 - 2. those drawings known to Owner of physical conditions relating to existing surface or subsurface structures at the Site (except Underground Facilities); and
 - 3. Technical Data contained in such reports and drawings.
- B. *Reliance by Contractor on Technical Data Authorized:* Contractor may rely upon the accuracy of the Technical Data expressly identified in the Supplementary Conditions with respect to such reports and drawings, but such reports and drawings are not Contract Documents. If no such express identification has been made, then Contractor may rely upon the accuracy of the Technical Data (as defined in Article 1) contained in any geotechnical or environmental report prepared for the Project and made available to Contractor. Except for such reliance on Technical Data, Contractor may not rely upon or make any claim against Owner or Engineer, or any of their officers, directors, members, partners, employees, agents, consultants, or subcontractors, with respect to:
 - 1. the completeness of such reports and drawings for Contractor's purposes, including, but not limited to, any aspects of the means, methods, techniques, sequences, and procedures of construction to be employed by Contractor, and safety precautions and programs incident thereto; or
 - 2. other data, interpretations, opinions, and information contained in such reports or shown or indicated in such drawings; or
 - 3. any Contractor interpretation of or conclusion drawn from any Technical Data or any such other data, interpretations, opinions, or information.

5.04 *Differing Subsurface or Physical Conditions*

- A. *Notice by Contractor:* If Contractor believes that any subsurface or physical condition that is uncovered or revealed at the Site either:
1. is of such a nature as to establish that any Technical Data on which Contractor is entitled to rely as provided in Paragraph 5.03 is materially inaccurate; or
 2. is of such a nature as to require a change in the Drawings or Specifications; or
 3. differs materially from that shown or indicated in the Contract Documents; or
 4. is of an unusual nature, and differs materially from conditions ordinarily encountered and generally recognized as inherent in work of the character provided for in the Contract Documents;

then Contractor shall, promptly after becoming aware thereof and before further disturbing the subsurface or physical conditions or performing any Work in connection therewith (except in an emergency as required by Paragraph 7.15), notify Owner and Engineer in writing about such condition. Contractor shall not further disturb such condition or perform any Work in connection therewith (except with respect to an emergency) until receipt of a written statement permitting Contractor to do so.

- B. *Engineer's Review:* After receipt of written notice as required by the preceding paragraph, Engineer will promptly review the subsurface or physical condition in question; determine the necessity of Owner's obtaining additional exploration or tests with respect to the condition; conclude whether the condition falls within any one or more of the differing site condition categories in Paragraph 5.04.A above; obtain any pertinent cost or schedule information from Contractor; prepare recommendations to Owner regarding the Contractor's resumption of Work in connection with the subsurface or physical condition in question and the need for any change in the Drawings or Specifications; and advise Owner in writing of Engineer's findings, conclusions, and recommendations.
- C. *Owner's Statement to Contractor Regarding Site Condition:* After receipt of Engineer's written findings, conclusions, and recommendations, Owner shall issue a written statement to Contractor (with a copy to Engineer) regarding the subsurface or physical condition in question, addressing the resumption of Work in connection with such condition, indicating whether any change in the Drawings or Specifications will be made, and adopting or rejecting Engineer's written findings, conclusions, and recommendations, in whole or in part.
- D. *Possible Price and Times Adjustments:*
1. Contractor shall be entitled to an equitable adjustment in Contract Price or Contract Times, or both, to the extent that the existence of a differing subsurface or physical condition, or any related delay, disruption, or interference, causes an increase or decrease in Contractor's cost of, or time required for, performance of the Work; subject, however, to the following:
 - a. such condition must fall within any one or more of the categories described in Paragraph 5.04.A;
 - b. with respect to Work that is paid for on a unit price basis, any adjustment in Contract Price will be subject to the provisions of Paragraph 13.03; and,

- c. Contractor's entitlement to an adjustment of the Contract Times is conditioned on such adjustment being essential to Contractor's ability to complete the Work within the Contract Times.
2. Contractor shall not be entitled to any adjustment in the Contract Price or Contract Times with respect to a subsurface or physical condition if:
 - a. Contractor knew of the existence of such condition at the time Contractor made a commitment to Owner with respect to Contract Price and Contract Times by the submission of a Bid or becoming bound under a negotiated contract, or otherwise; or
 - b. the existence of such condition reasonably could have been discovered or revealed as a result of any examination, investigation, exploration, test, or study of the Site and contiguous areas expressly required by the Bidding Requirements or Contract Documents to be conducted by or for Contractor prior to Contractor's making such commitment; or
 - c. Contractor failed to give the written notice as required by Paragraph 5.04.A.
 3. If Owner and Contractor agree regarding Contractor's entitlement to and the amount or extent of any adjustment in the Contract Price or Contract Times, or both, then any such adjustment shall be set forth in a Change Order.
 4. Contractor may submit a Change Proposal regarding its entitlement to or the amount or extent of any adjustment in the Contract Price or Contract Times, or both, no later than 30 days after Owner's issuance of the Owner's written statement to Contractor regarding the subsurface or physical condition in question.

5.05 *Underground Facilities*

- A. *Contractor's Responsibilities:* The information and data shown or indicated in the Contract Documents with respect to existing Underground Facilities at or adjacent to the Site is based on information and data furnished to Owner or Engineer by the owners of such Underground Facilities, including Owner, or by others. Unless it is otherwise expressly provided in the Supplementary Conditions:
 1. Owner and Engineer do not warrant or guarantee the accuracy or completeness of any such information or data provided by others; and
 2. the cost of all of the following will be included in the Contract Price, and Contractor shall have full responsibility for:
 - a. reviewing and checking all information and data regarding existing Underground Facilities at the Site;
 - b. locating all Underground Facilities shown or indicated in the Contract Documents as being at the Site;
 - c. coordination of the Work with the owners (including Owner) of such Underground Facilities, during construction; and
 - d. the safety and protection of all existing Underground Facilities at the Site, and repairing any damage thereto resulting from the Work.
- B. *Notice by Contractor:* If Contractor believes that an Underground Facility that is uncovered or revealed at the Site was not shown or indicated in the Contract Documents, or was not shown or indicated with reasonable accuracy, then Contractor shall, promptly after

becoming aware thereof and before further disturbing conditions affected thereby or performing any Work in connection therewith (except in an emergency as required by Paragraph 7.15), identify the owner of such Underground Facility and give written notice to that owner and to Owner and Engineer.

- C. *Engineer's Review:* Engineer will promptly review the Underground Facility and conclude whether such Underground Facility was not shown or indicated in the Contract Documents, or was not shown or indicated with reasonable accuracy; obtain any pertinent cost or schedule information from Contractor; prepare recommendations to Owner regarding the Contractor's resumption of Work in connection with the Underground Facility in question; determine the extent, if any, to which a change is required in the Drawings or Specifications to reflect and document the consequences of the existence or location of the Underground Facility; and advise Owner in writing of Engineer's findings, conclusions, and recommendations. During such time, Contractor shall be responsible for the safety and protection of such Underground Facility.
- D. *Owner's Statement to Contractor Regarding Underground Facility:* After receipt of Engineer's written findings, conclusions, and recommendations, Owner shall issue a written statement to Contractor (with a copy to Engineer) regarding the Underground Facility in question, addressing the resumption of Work in connection with such Underground Facility, indicating whether any change in the Drawings or Specifications will be made, and adopting or rejecting Engineer's written findings, conclusions, and recommendations in whole or in part.
- E. *Possible Price and Times Adjustments:*
 - 1. Contractor shall be entitled to an equitable adjustment in the Contract Price or Contract Times, or both, to the extent that any existing Underground Facility at the Site that was not shown or indicated in the Contract Documents, or was not shown or indicated with reasonable accuracy, or any related delay, disruption, or interference, causes an increase or decrease in Contractor's cost of, or time required for, performance of the Work; subject, however, to the following:
 - a. Contractor did not know of and could not reasonably have been expected to be aware of or to have anticipated the existence or actual location of the Underground Facility in question;
 - b. With respect to Work that is paid for on a unit price basis, any adjustment in Contract Price will be subject to the provisions of Paragraph 13.03;
 - c. Contractor's entitlement to an adjustment of the Contract Times is conditioned on such adjustment being essential to Contractor's ability to complete the Work within the Contract Times; and
 - d. Contractor gave the notice required in Paragraph 5.05.B.
 - 2. If Owner and Contractor agree regarding Contractor's entitlement to and the amount or extent of any adjustment in the Contract Price or Contract Times, or both, then any such adjustment shall be set forth in a Change Order.
 - 3. Contractor may submit a Change Proposal regarding its entitlement to or the amount or extent of any adjustment in the Contract Price or Contract Times, or both, no later than 30 days after Owner's issuance of the Owner's written statement to Contractor regarding the Underground Facility in question.

5.06 *Hazardous Environmental Conditions at Site*

- A. *Reports and Drawings*: The Supplementary Conditions identify:
1. those reports and drawings known to Owner relating to Hazardous Environmental Conditions that have been identified at or adjacent to the Site; and
 2. Technical Data contained in such reports and drawings.
- B. *Reliance by Contractor on Technical Data Authorized*: Contractor may rely upon the accuracy of the Technical Data expressly identified in the Supplementary Conditions with respect to such reports and drawings, but such reports and drawings are not Contract Documents. If no such express identification has been made, then Contractor may rely on the accuracy of the Technical Data (as defined in Article 1) contained in any geotechnical or environmental report prepared for the Project and made available to Contractor. Except for such reliance on Technical Data, Contractor may not rely upon or make any claim against Owner or Engineer, or any of their officers, directors, members, partners, employees, agents, consultants, or subcontractors with respect to:
1. the completeness of such reports and drawings for Contractor's purposes, including, but not limited to, any aspects of the means, methods, techniques, sequences and procedures of construction to be employed by Contractor and safety precautions and programs incident thereto; or
 2. other data, interpretations, opinions and information contained in such reports or shown or indicated in such drawings; or
 3. any Contractor interpretation of or conclusion drawn from any Technical Data or any such other data, interpretations, opinions or information.
- C. Contractor shall not be responsible for removing or remediating any Hazardous Environmental Condition encountered, uncovered, or revealed at the Site unless such removal or remediation is expressly identified in the Contract Documents to be within the scope of the Work.
- D. Contractor shall be responsible for controlling, containing, and duly removing all Constituents of Concern brought to the Site by Contractor, Subcontractors, Suppliers, or anyone else for whom Contractor is responsible, and for any associated costs; and for the costs of removing and remediating any Hazardous Environmental Condition created by the presence of any such Constituents of Concern.
- E. If Contractor encounters, uncovers, or reveals a Hazardous Environmental Condition whose removal or remediation is not expressly identified in the Contract Documents as being within the scope of the Work, or if Contractor or anyone for whom Contractor is responsible creates a Hazardous Environmental Condition, then Contractor shall immediately: (1) secure or otherwise isolate such condition; (2) stop all Work in connection with such condition and in any area affected thereby (except in an emergency as required by Paragraph 7.15); and (3) notify Owner and Engineer (and promptly thereafter confirm such notice in writing). Owner shall promptly consult with Engineer concerning the necessity for Owner to retain a qualified expert to evaluate such condition or take corrective action, if any. Promptly after consulting with Engineer, Owner shall take such actions as are necessary to permit Owner to timely obtain required permits and provide Contractor the written notice required by Paragraph 5.06.F. If Contractor or anyone for whom Contractor is responsible created the Hazardous Environmental Condition in question, then Owner may remove and remediate the Hazardous Environmental Condition, and impose a set-off against payments to account for the associated costs.

- F. Contractor shall not resume Work in connection with such Hazardous Environmental Condition or in any affected area until after Owner has obtained any required permits related thereto, and delivered written notice to Contractor either (1) specifying that such condition and any affected area is or has been rendered safe for the resumption of Work, or (2) specifying any special conditions under which such Work may be resumed safely.
- G. If Owner and Contractor cannot agree as to entitlement to or on the amount or extent, if any, of any adjustment in Contract Price or Contract Times, or both, as a result of such Work stoppage or such special conditions under which Work is agreed to be resumed by Contractor, then within 30 days of Owner's written notice regarding the resumption of Work, Contractor may submit a Change Proposal, or Owner may impose a set-off.
- H. If after receipt of such written notice Contractor does not agree to resume such Work based on a reasonable belief it is unsafe, or does not agree to resume such Work under such special conditions, then Owner may order the portion of the Work that is in the area affected by such condition to be deleted from the Work, following the contractual change procedures in Article 11. Owner may have such deleted portion of the Work performed by Owner's own forces or others in accordance with Article 8.
- I. To the fullest extent permitted by Laws and Regulations, Owner shall indemnify and hold harmless Contractor, Subcontractors, and Engineer, and the officers, directors, members, partners, employees, agents, consultants, and subcontractors of each and any of them from and against all claims, costs, losses, and damages (including but not limited to all fees and charges of engineers, architects, attorneys, and other professionals and all court or arbitration or other dispute resolution costs) arising out of or relating to a Hazardous Environmental Condition, provided that such Hazardous Environmental Condition (1) was not shown or indicated in the Drawings, Specifications, or other Contract Documents, identified as Technical Data entitled to limited reliance pursuant to Paragraph 5.06.B, or identified in the Contract Documents to be included within the scope of the Work, and (2) was not created by Contractor or by anyone for whom Contractor is responsible. Nothing in this Paragraph 5.06.H shall obligate Owner to indemnify any individual or entity from and against the consequences of that individual's or entity's own negligence.
- J. To the fullest extent permitted by Laws and Regulations, Contractor shall indemnify and hold harmless Owner and Engineer, and the officers, directors, members, partners, employees, agents, consultants, and subcontractors of each and any of them from and against all claims, costs, losses, and damages (including but not limited to all fees and charges of engineers, architects, attorneys, and other professionals and all court or arbitration or other dispute resolution costs) arising out of or relating to the failure to control, contain, or remove a Constituent of Concern brought to the Site by Contractor or by anyone for whom Contractor is responsible, or to a Hazardous Environmental Condition created by Contractor or by anyone for whom Contractor is responsible. Nothing in this Paragraph 5.06.J shall obligate Contractor to indemnify any individual or entity from and against the consequences of that individual's or entity's own negligence.
- K. The provisions of Paragraphs 5.03, 5.04, and 5.05 do not apply to the presence of Constituents of Concern or to a Hazardous Environmental Condition uncovered or revealed at the Site.

ARTICLE 6 – BONDS AND INSURANCE

6.01 *Performance, Payment, and Other Bonds*

- A. Contractor shall furnish a performance bond and a payment bond, each in an amount at least equal to the Contract Price, as security for the faithful performance and payment of all of Contractor's obligations under the Contract. These bonds shall remain in effect until one year after the date when final payment becomes due or until completion of the correction period specified in Paragraph 15.08, whichever is later, except as provided otherwise by Laws or Regulations, the Supplementary Conditions, or other specific provisions of the Contract. Contractor shall also furnish such other bonds as are required by the Supplementary Conditions or other specific provisions of the Contract.
- B. All bonds shall be in the form prescribed by the Contract except as provided otherwise by Laws or Regulations, and shall be executed by such sureties as are named in "Companies Holding Certificates of Authority as Acceptable Sureties on Federal Bonds and as Acceptable Reinsuring Companies" as published in Circular 570 (as amended and supplemented) by the Financial Management Service, Surety Bond Branch, U.S. Department of the Treasury. A bond signed by an agent or attorney-in-fact must be accompanied by a certified copy of that individual's authority to bind the surety. The evidence of authority shall show that it is effective on the date the agent or attorney-in-fact signed the accompanying bond.
- C. Contractor shall obtain the required bonds from surety companies that are duly licensed or authorized in the jurisdiction in which the Project is located to issue bonds in the required amounts.
- D. If the surety on a bond furnished by Contractor is declared bankrupt or becomes insolvent, or its right to do business is terminated in any state or jurisdiction where any part of the Project is located, or the surety ceases to meet the requirements above, then Contractor shall promptly notify Owner and Engineer and shall, within 20 days after the event giving rise to such notification, provide another bond and surety, both of which shall comply with the bond and surety requirements above.
- E. If Contractor has failed to obtain a required bond, Owner may exclude the Contractor from the Site and exercise Owner's termination rights under Article 16.
- F. Upon request, Owner shall provide a copy of the payment bond to any Subcontractor, Supplier, or other person or entity claiming to have furnished labor or materials used in the performance of the Work.

6.02 *Insurance—General Provisions*

- A. Owner and Contractor shall obtain and maintain insurance as required in this Article and in the Supplementary Conditions.
- B. All insurance required by the Contract to be purchased and maintained by Owner or Contractor shall be obtained from insurance companies that are duly licensed or authorized, in the state or jurisdiction in which the Project is located, to issue insurance policies for the required limits and coverages. Unless a different standard is indicated in the Supplementary Conditions, all companies that provide insurance policies required under this Contract shall have an A.M. Best rating of A-VII or better.
- C. Contractor shall deliver to Owner, with copies to each named insured and additional insured (as identified in this Article, in the Supplementary Conditions, or elsewhere in the Contract), certificates of insurance establishing that Contractor has obtained and is

maintaining the policies, coverages, and endorsements required by the Contract. Upon request by Owner or any other insured, Contractor shall also furnish other evidence of such required insurance, including but not limited to copies of policies and endorsements, and documentation of applicable self-insured retentions and deductibles. Contractor may block out (redact) any confidential premium or pricing information contained in any policy or endorsement furnished under this provision.

- D. Owner shall deliver to Contractor, with copies to each named insured and additional insured (as identified in this Article, the Supplementary Conditions, or elsewhere in the Contract), certificates of insurance establishing that Owner has obtained and is maintaining the policies, coverages, and endorsements required of Owner by the Contract (if any). Upon request by Contractor or any other insured, Owner shall also provide other evidence of such required insurance (if any), including but not limited to copies of policies and endorsements, and documentation of applicable self-insured retentions and deductibles. Owner may block out (redact) any confidential premium or pricing information contained in any policy or endorsement furnished under this provision.
- E. Failure of Owner or Contractor to demand such certificates or other evidence of the other party's full compliance with these insurance requirements, or failure of Owner or Contractor to identify a deficiency in compliance from the evidence provided, shall not be construed as a waiver of the other party's obligation to obtain and maintain such insurance.
- F. If either party does not purchase or maintain all of the insurance required of such party by the Contract, such party shall notify the other party in writing of such failure to purchase prior to the start of the Work, or of such failure to maintain prior to any change in the required coverage.
- G. If Contractor has failed to obtain and maintain required insurance, Owner may exclude the Contractor from the Site, impose an appropriate set-off against payment, and exercise Owner's termination rights under Article 16.
- H. Without prejudice to any other right or remedy, if a party has failed to obtain required insurance, the other party may elect to obtain equivalent insurance to protect such other party's interests at the expense of the party who was required to provide such coverage, and the Contract Price shall be adjusted accordingly.
- I. Owner does not represent that insurance coverage and limits established in this Contract necessarily will be adequate to protect Contractor or Contractor's interests.
- J. The insurance and insurance limits required herein shall not be deemed as a limitation on Contractor's liability under the indemnities granted to Owner and other individuals and entities in the Contract.

6.03 *Contractor's Insurance*

- A. *Workers' Compensation:* Contractor shall purchase and maintain workers' compensation and employer's liability insurance for:
 - 1. claims under workers' compensation, disability benefits, and other similar employee benefit acts.
 - 2. United States Longshoreman and Harbor Workers' Compensation Act and Jones Act coverage (if applicable).
 - 3. claims for damages because of bodily injury, occupational sickness or disease, or death of Contractor's employees (by stop-gap endorsement in monopolist worker's compensation states).

4. Foreign voluntary worker compensation (if applicable).
- B. *Commercial General Liability—Claims Covered:* Contractor shall purchase and maintain commercial general liability insurance, covering all operations by or on behalf of Contractor, on an occurrence basis, against:
1. claims for damages because of bodily injury, sickness or disease, or death of any person other than Contractor's employees.
 2. claims for damages insured by reasonably available personal injury liability coverage.
 3. claims for damages, other than to the Work itself, because of injury to or destruction of tangible property wherever located, including loss of use resulting therefrom.
- C. *Commercial General Liability—Form and Content:* Contractor's commercial liability policy shall be written on a 1996 (or later) ISO commercial general liability form (occurrence form) and include the following coverages and endorsements:
1. Products and completed operations coverage:
 - a. Such insurance shall be maintained for three years after final payment.
 - b. Contractor shall furnish Owner and each other additional insured (as identified in the Supplementary Conditions or elsewhere in the Contract) evidence of continuation of such insurance at final payment and three years thereafter.
 2. Blanket contractual liability coverage, to the extent permitted by law, including but not limited to coverage of Contractor's contractual indemnity obligations in Paragraph 7.18.
 3. Broad form property damage coverage.
 4. Severability of interest.
 5. Underground, explosion, and collapse coverage.
 6. Personal injury coverage.
 7. Additional insured endorsements that include both ongoing operations and products and completed operations coverage through ISO Endorsements CG 20 10 10 01 and CG 20 37 10 01 (together); or CG 20 10 07 04 and CG 20 37 07 04 (together); or their equivalent.
 8. For design professional additional insureds, ISO Endorsement CG 20 32 07 04, "Additional Insured—Engineers, Architects or Surveyors Not Engaged by the Named Insured" or its equivalent.
- D. *Automobile liability:* Contractor shall purchase and maintain automobile liability insurance against claims for damages because of bodily injury or death of any person or property damage arising out of the ownership, maintenance, or use of any motor vehicle. The automobile liability policy shall be written on an occurrence basis.
- E. *Umbrella or excess liability:* Contractor shall purchase and maintain umbrella or excess liability insurance written over the underlying employer's liability, commercial general liability, and automobile liability insurance described in the paragraphs above. Subject to industry-standard exclusions, the coverage afforded shall follow form as to each and every one of the underlying policies.
- F. *Contractor's pollution liability insurance:* Contractor shall purchase and maintain a policy covering third-party injury and property damage claims, including clean-up costs, as a result

of pollution conditions arising from Contractor's operations and completed operations. This insurance shall be maintained for no less than three years after final completion.

- G. *Additional insureds*: The Contractor's commercial general liability, automobile liability, umbrella or excess, and pollution liability policies shall include and list as additional insureds Owner and Engineer, and any individuals or entities identified in the Supplementary Conditions; include coverage for the respective officers, directors, members, partners, employees, agents, consultants, and subcontractors of each and any of all such additional insureds; and the insurance afforded to these additional insureds shall provide primary coverage for all claims covered thereby (including as applicable those arising from both ongoing and completed operations) on a non-contributory basis. Contractor shall obtain all necessary endorsements to support these requirements.
- H. *Contractor's professional liability insurance*: If Contractor will provide or furnish professional services under this Contract, through a delegation of professional design services or otherwise, then Contractor shall be responsible for purchasing and maintaining applicable professional liability insurance. This insurance shall provide protection against claims arising out of performance of professional design or related services, and caused by a negligent error, omission, or act for which the insured party is legally liable. It shall be maintained throughout the duration of the Contract and for a minimum of two years after Substantial Completion. If such professional design services are performed by a Subcontractor, and not by Contractor itself, then the requirements of this paragraph may be satisfied through the purchasing and maintenance of such insurance by such Subcontractor.
- I. *General provisions*: The policies of insurance required by this Paragraph 6.03 shall:
 - 1. include at least the specific coverages provided in this Article.
 - 2. be written for not less than the limits of liability provided in this Article and in the Supplementary Conditions, or required by Laws or Regulations, whichever is greater.
 - 3. contain a provision or endorsement that the coverage afforded will not be canceled, materially changed, or renewal refused until at least 10 days prior written notice has been given to Contractor. Within three days of receipt of any such written notice, Contractor shall provide a copy of the notice to Owner, Engineer, and each other insured under the policy.
 - 4. remain in effect at least until final payment (and longer if expressly required in this Article) and at all times thereafter when Contractor may be correcting, removing, or replacing defective Work as a warranty or correction obligation, or otherwise, or returning to the Site to conduct other tasks arising from the Contract Documents.
 - 5. be appropriate for the Work being performed and provide protection from claims that may arise out of or result from Contractor's performance of the Work and Contractor's other obligations under the Contract Documents, whether it is to be performed by Contractor, any Subcontractor or Supplier, or by anyone directly or indirectly employed by any of them to perform any of the Work, or by anyone for whose acts any of them may be liable.
- J. The coverage requirements for specific policies of insurance must be met by such policies, and not by reference to excess or umbrella insurance provided in other policies.

6.04 *Owner's Liability Insurance*

- A. In addition to the insurance required to be provided by Contractor under Paragraph 6.03, Owner, at Owner's option, may purchase and maintain at Owner's expense Owner's own liability insurance as will protect Owner against claims which may arise from operations under the Contract Documents.
- B. Owner's liability policies, if any, operate separately and independently from policies required to be provided by Contractor, and Contractor cannot rely upon Owner's liability policies for any of Contractor's obligations to the Owner, Engineer, or third parties.

6.05 *Property Insurance*

- A. *Builder's Risk*: Unless otherwise provided in the Supplementary Conditions, Contractor shall purchase and maintain builder's risk insurance upon the Work on a completed value basis, in the amount of the full insurable replacement cost thereof (subject to such deductible amounts as may be provided in the Supplementary Conditions or required by Laws and Regulations). This insurance shall:
 - 1. include the Owner and Contractor as named insureds, and all Subcontractors, and any individuals or entities required by the Supplementary Conditions to be insured under such builder's risk policy, as insureds or named insureds. For purposes of the remainder of this Paragraph 6.05, Paragraphs 6.06 and 6.07, and any corresponding Supplementary Conditions, the parties required to be insured shall collectively be referred to as "insureds."
 - 2. be written on a builder's risk "all risk" policy form that shall at least include insurance for physical loss or damage to the Work, temporary buildings, falsework, and materials and equipment in transit, and shall insure against at least the following perils or causes of loss: fire; lightning; windstorm; riot; civil commotion; terrorism; vehicle impact; aircraft; smoke; theft; vandalism and malicious mischief; mechanical breakdown, boiler explosion, and artificially generated electric current; earthquake; volcanic activity, and other earth movement; flood; collapse; explosion; debris removal; demolition occasioned by enforcement of Laws and Regulations; water damage (other than that caused by flood); and such other perils or causes of loss as may be specifically required by the Supplementary Conditions. If insurance against mechanical breakdown, boiler explosion, and artificially generated electric current; earthquake; volcanic activity, and other earth movement; or flood, are not commercially available under builder's risk policies, by endorsement or otherwise, such insurance may be provided through other insurance policies acceptable to Owner and Contractor.
 - 3. cover, as insured property, at least the following: (a) the Work and all materials, supplies, machinery, apparatus, equipment, fixtures, and other property of a similar nature that are to be incorporated into or used in the preparation, fabrication, construction, erection, or completion of the Work, including Owner-furnished or assigned property; (b) spare parts inventory required within the scope of the Contract; and (c) temporary works which are not intended to form part of the permanent constructed Work but which are intended to provide working access to the Site, or to the Work under construction, or which are intended to provide temporary support for the Work under construction, including scaffolding, form work, fences, shoring, falsework, and temporary structures.
 - 4. cover expenses incurred in the repair or replacement of any insured property (including but not limited to fees and charges of engineers and architects).

5. extend to cover damage or loss to insured property while in temporary storage at the Site or in a storage location outside the Site (but not including property stored at the premises of a manufacturer or Supplier).
 6. extend to cover damage or loss to insured property while in transit.
 7. allow for partial occupation or use of the Work by Owner, such that those portions of the Work that are not yet occupied or used by Owner shall remain covered by the builder's risk insurance.
 8. allow for the waiver of the insurer's subrogation rights, as set forth below.
 9. provide primary coverage for all losses and damages caused by the perils or causes of loss covered.
 10. not include a co-insurance clause.
 11. include an exception for ensuing losses from physical damage or loss with respect to any defective workmanship, design, or materials exclusions.
 12. include performance/hot testing and start-up.
 13. be maintained in effect, subject to the provisions herein regarding Substantial Completion and partial occupancy or use of the Work by Owner, until the Work is complete.
- B. *Notice of Cancellation or Change*: All the policies of insurance (and the certificates or other evidence thereof) required to be purchased and maintained in accordance with this Paragraph 6.05 will contain a provision or endorsement that the coverage afforded will not be canceled or materially changed or renewal refused until at least 10 days prior written notice has been given to the purchasing policyholder. Within three days of receipt of any such written notice, the purchasing policyholder shall provide a copy of the notice to each other insured.
- C. *Deductibles*: The purchaser of any required builder's risk or property insurance shall pay for costs not covered because of the application of a policy deductible.
- D. *Partial Occupancy or Use by Owner*: If Owner will occupy or use a portion or portions of the Work prior to Substantial Completion of all the Work as provided in Paragraph 15.04, then Owner (directly, if it is the purchaser of the builder's risk policy, or through Contractor) will provide notice of such occupancy or use to the builder's risk insurer. The builder's risk insurance shall not be canceled or permitted to lapse on account of any such partial use or occupancy; rather, those portions of the Work that are occupied or used by Owner may come off the builder's risk policy, while those portions of the Work not yet occupied or used by Owner shall remain covered by the builder's risk insurance.
- E. *Additional Insurance*: If Contractor elects to obtain other special insurance to be included in or supplement the builder's risk or property insurance policies provided under this Paragraph 6.05, it may do so at Contractor's expense.
- F. *Insurance of Other Property*: If the express insurance provisions of the Contract do not require or address the insurance of a property item or interest, such as tools, construction equipment, or other personal property owned by Contractor, a Subcontractor, or an employee of Contractor or a Subcontractor, then the entity or individual owning such property item will be responsible for deciding whether to insure it, and if so in what amount.

6.06 *Waiver of Rights*

- A. All policies purchased in accordance with Paragraph 6.05, expressly including the builder's risk policy, shall contain provisions to the effect that in the event of payment of any loss or damage the insurers will have no rights of recovery against any insureds thereunder, or against Engineer or its consultants, or their officers, directors, members, partners, employees, agents, consultants, or subcontractors. Owner and Contractor waive all rights against each other and the respective officers, directors, members, partners, employees, agents, consultants, and subcontractors of each and any of them, for all losses and damages caused by, arising out of, or resulting from any of the perils or causes of loss covered by such policies and any other property insurance applicable to the Work; and, in addition, waive all such rights against Engineer, its consultants, all Subcontractors, all individuals or entities identified in the Supplementary Conditions as insureds, and the officers, directors, members, partners, employees, agents, consultants, and subcontractors of each and any of them, under such policies for losses and damages so caused. None of the above waivers shall extend to the rights that any party making such waiver may have to the proceeds of insurance held by Owner or Contractor as trustee or fiduciary, or otherwise payable under any policy so issued.
- B. Owner waives all rights against Contractor, Subcontractors, and Engineer, and the officers, directors, members, partners, employees, agents, consultants and subcontractors of each and any of them, for:
 - 1. loss due to business interruption, loss of use, or other consequential loss extending beyond direct physical loss or damage to Owner's property or the Work caused by, arising out of, or resulting from fire or other perils whether or not insured by Owner; and
 - 2. loss or damage to the completed Project or part thereof caused by, arising out of, or resulting from fire or other insured peril or cause of loss covered by any property insurance maintained on the completed Project or part thereof by Owner during partial occupancy or use pursuant to Paragraph 15.04, after Substantial Completion pursuant to Paragraph 15.03, or after final payment pursuant to Paragraph 15.06.
- C. Any insurance policy maintained by Owner covering any loss, damage or consequential loss referred to in Paragraph 6.06.B shall contain provisions to the effect that in the event of payment of any such loss, damage, or consequential loss, the insurers will have no rights of recovery against Contractor, Subcontractors, or Engineer, or the officers, directors, members, partners, employees, agents, consultants, or subcontractors of each and any of them.
- D. Contractor shall be responsible for assuring that the agreement under which a Subcontractor performs a portion of the Work contains provisions whereby the Subcontractor waives all rights against Owner, Contractor, all individuals or entities identified in the Supplementary Conditions as insureds, the Engineer and its consultants, and the officers, directors, members, partners, employees, agents, consultants, and subcontractors of each and any of them, for all losses and damages caused by, arising out of, relating to, or resulting from any of the perils or causes of loss covered by builder's risk insurance and any other property insurance applicable to the Work.

6.07 *Receipt and Application of Property Insurance Proceeds*

- A. Any insured loss under the builder's risk and other policies of insurance required by Paragraph 6.05 will be adjusted and settled with the named insured that purchased the

policy. Such named insured shall act as fiduciary for the other insureds, and give notice to such other insureds that adjustment and settlement of a claim is in progress. Any other insured may state its position regarding a claim for insured loss in writing within 15 days after notice of such claim.

- B. Proceeds for such insured losses may be made payable by the insurer either jointly to multiple insureds, or to the named insured that purchased the policy in its own right and as fiduciary for other insureds, subject to the requirements of any applicable mortgage clause. A named insured receiving insurance proceeds under the builder's risk and other policies of insurance required by Paragraph 6.05 shall distribute such proceeds in accordance with such agreement as the parties in interest may reach, or as otherwise required under the dispute resolution provisions of this Contract or applicable Laws and Regulations.
- C. If no other special agreement is reached, the damaged Work shall be repaired or replaced, the money so received applied on account thereof, and the Work and the cost thereof covered by Change Order, if needed.

ARTICLE 7 – CONTRACTOR'S RESPONSIBILITIES

7.01 Supervision and Superintendence

- A. Contractor shall supervise, inspect, and direct the Work competently and efficiently, devoting such attention thereto and applying such skills and expertise as may be necessary to perform the Work in accordance with the Contract Documents. Contractor shall be solely responsible for the means, methods, techniques, sequences, and procedures of construction.
- B. At all times during the progress of the Work, Contractor shall assign a competent resident superintendent who shall not be replaced without written notice to Owner and Engineer except under extraordinary circumstances.

7.02 Labor; Working Hours

- A. Contractor shall provide competent, suitably qualified personnel to survey and lay out the Work and perform construction as required by the Contract Documents. Contractor shall at all times maintain good discipline and order at the Site.
- B. Except as otherwise required for the safety or protection of persons or the Work or property at the Site or adjacent thereto, and except as otherwise stated in the Contract Documents, all Work at the Site shall be performed during regular working hours, Monday through Friday. Contractor will not perform Work on a Saturday, Sunday, or any legal holiday. Contractor may perform Work outside regular working hours or on Saturdays, Sundays, or legal holidays only with Owner's written consent, which will not be unreasonably withheld.

7.03 Services, Materials, and Equipment

- A. Unless otherwise specified in the Contract Documents, Contractor shall provide and assume full responsibility for all services, materials, equipment, labor, transportation, construction equipment and machinery, tools, appliances, fuel, power, light, heat, telephone, water, sanitary facilities, temporary facilities, and all other facilities and incidentals necessary for the performance, testing, start up, and completion of the Work, whether or not such items are specifically called for in the Contract Documents.
- B. All materials and equipment incorporated into the Work shall be of good quality and new, except as otherwise provided in the Contract Documents. All special warranties and

guarantees required by the Specifications shall expressly run to the benefit of Owner. If required by Engineer, Contractor shall furnish satisfactory evidence (including reports of required tests) as to the source, kind, and quality of materials and equipment.

- C. All materials and equipment shall be stored, applied, installed, connected, erected, protected, used, cleaned, and conditioned in accordance with instructions of the applicable Supplier, except as otherwise may be provided in the Contract Documents.

7.04 "Or Equals"

- A. Whenever an item of material or equipment is specified or described in the Contract Documents by using the name of a proprietary item or the name of a particular Supplier, the Contract Price has been based upon Contractor furnishing such item as specified. The specification or description of such an item is intended to establish the type, function, appearance, and quality required. Unless the specification or description contains or is followed by words reading that no like, equivalent, or "or equal" item is permitted, Contractor may request that Engineer authorize the use of other items of material or equipment, or items from other proposed suppliers under the circumstances described below.
 - 1. If Engineer in its sole discretion determines that an item of material or equipment proposed by Contractor is functionally equal to that named and sufficiently similar so that no change in related Work will be required, Engineer shall deem it an "or equal" item. For the purposes of this paragraph, a proposed item of material or equipment will be considered functionally equal to an item so named if:
 - a. in the exercise of reasonable judgment Engineer determines that:
 - 1) it is at least equal in materials of construction, quality, durability, appearance, strength, and design characteristics;
 - 2) it will reliably perform at least equally well the function and achieve the results imposed by the design concept of the completed Project as a functioning whole;
 - 3) it has a proven record of performance and availability of responsive service; and
 - 4) it is not objectionable to Owner.
 - b. Contractor certifies that, if approved and incorporated into the Work:
 - 1) there will be no increase in cost to the Owner or increase in Contract Times; and
 - 2) it will conform substantially to the detailed requirements of the item named in the Contract Documents.
- B. *Contractor's Expense:* Contractor shall provide all data in support of any proposed "or equal" item at Contractor's expense.
- C. *Engineer's Evaluation and Determination:* Engineer will be allowed a reasonable time to evaluate each "or-equal" request. Engineer may require Contractor to furnish additional data about the proposed "or-equal" item. Engineer will be the sole judge of acceptability. No "or-equal" item will be ordered, furnished, installed, or utilized until Engineer's review is complete and Engineer determines that the proposed item is an "or-equal", which will be evidenced by an approved Shop Drawing or other written communication. Engineer will advise Contractor in writing of any negative determination.

- D. *Effect of Engineer's Determination:* Neither approval nor denial of an "or-equal" request shall result in any change in Contract Price. The Engineer's denial of an "or-equal" request shall be final and binding, and may not be reversed through an appeal under any provision of the Contract Documents.
- E. *Treatment as a Substitution Request:* If Engineer determines that an item of material or equipment proposed by Contractor does not qualify as an "or-equal" item, Contractor may request that Engineer considered the proposed item as a substitute pursuant to Paragraph 7.05.

7.05 *Substitutes*

- A. Unless the specification or description of an item of material or equipment required to be furnished under the Contract Documents contains or is followed by words reading that no substitution is permitted, Contractor may request that Engineer authorize the use of other items of material or equipment under the circumstances described below. To the extent possible such requests shall be made before commencement of related construction at the Site.
 - 1. Contractor shall submit sufficient information as provided below to allow Engineer to determine if the item of material or equipment proposed is functionally equivalent to that named and an acceptable substitute therefor. Engineer will not accept requests for review of proposed substitute items of material or equipment from anyone other than Contractor.
 - 2. The requirements for review by Engineer will be as set forth in Paragraph 7.05.B, as supplemented by the Specifications, and as Engineer may decide is appropriate under the circumstances.
 - 3. Contractor shall make written application to Engineer for review of a proposed substitute item of material or equipment that Contractor seeks to furnish or use. The application:
 - a. shall certify that the proposed substitute item will:
 - 1) perform adequately the functions and achieve the results called for by the general design,
 - 2) be similar in substance to that specified, and
 - 3) be suited to the same use as that specified.
 - b. will state:
 - 1) the extent, if any, to which the use of the proposed substitute item will necessitate a change in Contract Times,
 - 2) whether use of the proposed substitute item in the Work will require a change in any of the Contract Documents (or in the provisions of any other direct contract with Owner for other work on the Project) to adapt the design to the proposed substitute item, and
 - 3) whether incorporation or use of the proposed substitute item in connection with the Work is subject to payment of any license fee or royalty.
 - c. will identify:
 - 1) all variations of the proposed substitute item from that specified, and

- 2) available engineering, sales, maintenance, repair, and replacement services.
 - d. shall contain an itemized estimate of all costs or credits that will result directly or indirectly from use of such substitute item, including but not limited to changes in Contract Price, shared savings, costs of redesign, and claims of other contractors affected by any resulting change.
- B. *Engineer's Evaluation and Determination:* Engineer will be allowed a reasonable time to evaluate each substitute request, and to obtain comments and direction from Owner. Engineer may require Contractor to furnish additional data about the proposed substitute item. Engineer will be the sole judge of acceptability. No substitute will be ordered, furnished, installed, or utilized until Engineer's review is complete and Engineer determines that the proposed item is an acceptable substitute. Engineer's determination will be evidenced by a Field Order or a proposed Change Order accounting for the substitution itself and all related impacts, including changes in Contract Price or Contract Times. Engineer will advise Contractor in writing of any negative determination.
 - C. *Special Guarantee:* Owner may require Contractor to furnish at Contractor's expense a special performance guarantee or other surety with respect to any substitute.
 - D. *Reimbursement of Engineer's Cost:* Engineer will record Engineer's costs in evaluating a substitute proposed or submitted by Contractor. Whether or not Engineer approves a substitute so proposed or submitted by Contractor, Contractor shall reimburse Owner for the reasonable charges of Engineer for evaluating each such proposed substitute. Contractor shall also reimburse Owner for the reasonable charges of Engineer for making changes in the Contract Documents (or in the provisions of any other direct contract with Owner) resulting from the acceptance of each proposed substitute.
 - E. *Contractor's Expense:* Contractor shall provide all data in support of any proposed substitute at Contractor's expense.
 - F. *Effect of Engineer's Determination:* If Engineer approves the substitution request, Contractor shall execute the proposed Change Order and proceed with the substitution. The Engineer's denial of a substitution request shall be final and binding, and may not be reversed through an appeal under any provision of the Contract Documents. Contractor may challenge the scope of reimbursement costs imposed under Paragraph 7.05.D, by timely submittal of a Change Proposal.

7.06 *Concerning Subcontractors, Suppliers, and Others*

- A. Contractor may retain Subcontractors and Suppliers for the performance of parts of the Work. Such Subcontractors and Suppliers must be acceptable to Owner.
- B. Contractor shall retain specific Subcontractors, Suppliers, or other individuals or entities for the performance of designated parts of the Work if required by the Contract to do so.
- C. Subsequent to the submittal of Contractor's Bid or final negotiation of the terms of the Contract, Owner may not require Contractor to retain any Subcontractor, Supplier, or other individual or entity to furnish or perform any of the Work against which Contractor has reasonable objection.
- D. Prior to entry into any binding subcontract or purchase order, Contractor shall submit to Owner the identity of the proposed Subcontractor or Supplier (unless Owner has already deemed such proposed Subcontractor or Supplier acceptable, during the bidding process or otherwise). Such proposed Subcontractor or Supplier shall be deemed acceptable to Owner unless Owner raises a substantive, reasonable objection within five days.

- E. Owner may require the replacement of any Subcontractor, Supplier, or other individual or entity retained by Contractor to perform any part of the Work. Owner also may require Contractor to retain specific replacements; provided, however, that Owner may not require a replacement to which Contractor has a reasonable objection. If Contractor has submitted the identity of certain Subcontractors, Suppliers, or other individuals or entities for acceptance by Owner, and Owner has accepted it (either in writing or by failing to make written objection thereto), then Owner may subsequently revoke the acceptance of any such Subcontractor, Supplier, or other individual or entity so identified solely on the basis of substantive, reasonable objection after due investigation. Contractor shall submit an acceptable replacement for the rejected Subcontractor, Supplier, or other individual or entity.
- F. If Owner requires the replacement of any Subcontractor, Supplier, or other individual or entity retained by Contractor to perform any part of the Work, then Contractor shall be entitled to an adjustment in Contract Price or Contract Times, or both, with respect to the replacement; and Contractor shall initiate a Change Proposal for such adjustment within 30 days of Owner's requirement of replacement.
- G. No acceptance by Owner of any such Subcontractor, Supplier, or other individual or entity, whether initially or as a replacement, shall constitute a waiver of the right of Owner to the completion of the Work in accordance with the Contract Documents.
- H. On a monthly basis Contractor shall submit to Engineer a complete list of all Subcontractors and Suppliers having a direct contract with Contractor, and of all other Subcontractors and Suppliers known to Contractor at the time of submittal.
- I. Contractor shall be fully responsible to Owner and Engineer for all acts and omissions of the Subcontractors, Suppliers, and other individuals or entities performing or furnishing any of the Work just as Contractor is responsible for Contractor's own acts and omissions.
- J. Contractor shall be solely responsible for scheduling and coordinating the work of Subcontractors, Suppliers, and all other individuals or entities performing or furnishing any of the Work.
- K. Contractor shall restrict all Subcontractors, Suppliers, and such other individuals or entities performing or furnishing any of the Work from communicating with Engineer or Owner, except through Contractor or in case of an emergency, or as otherwise expressly allowed herein.
- L. The divisions and sections of the Specifications and the identifications of any Drawings shall not control Contractor in dividing the Work among Subcontractors or Suppliers or delineating the Work to be performed by any specific trade.
- M. All Work performed for Contractor by a Subcontractor or Supplier shall be pursuant to an appropriate contractual agreement that specifically binds the Subcontractor or Supplier to the applicable terms and conditions of the Contract Documents for the benefit of Owner and Engineer.
- N. Owner may furnish to any Subcontractor or Supplier, to the extent practicable, information about amounts paid to Contractor on account of Work performed for Contractor by the particular Subcontractor or Supplier.

- O. Nothing in the Contract Documents:
1. shall create for the benefit of any such Subcontractor, Supplier, or other individual or entity any contractual relationship between Owner or Engineer and any such Subcontractor, Supplier, or other individual or entity; nor
 2. shall create any obligation on the part of Owner or Engineer to pay or to see to the payment of any money due any such Subcontractor, Supplier, or other individual or entity except as may otherwise be required by Laws and Regulations.

7.07 *Patent Fees and Royalties*

- A. Contractor shall pay all license fees and royalties and assume all costs incident to the use in the performance of the Work or the incorporation in the Work of any invention, design, process, product, or device which is the subject of patent rights or copyrights held by others. If a particular invention, design, process, product, or device is specified in the Contract Documents for use in the performance of the Work and if, to the actual knowledge of Owner or Engineer, its use is subject to patent rights or copyrights calling for the payment of any license fee or royalty to others, the existence of such rights shall be disclosed by Owner in the Contract Documents.
- B. To the fullest extent permitted by Laws and Regulations, Owner shall indemnify and hold harmless Contractor, and its officers, directors, members, partners, employees, agents, consultants, and subcontractors from and against all claims, costs, losses, and damages (including but not limited to all fees and charges of engineers, architects, attorneys, and other professionals, and all court or arbitration or other dispute resolution costs) arising out of or relating to any infringement of patent rights or copyrights incident to the use in the performance of the Work or resulting from the incorporation in the Work of any invention, design, process, product, or device specified in the Contract Documents, but not identified as being subject to payment of any license fee or royalty to others required by patent rights or copyrights.
- C. To the fullest extent permitted by Laws and Regulations, Contractor shall indemnify and hold harmless Owner and Engineer, and the officers, directors, members, partners, employees, agents, consultants and subcontractors of each and any of them from and against all claims, costs, losses, and damages (including but not limited to all fees and charges of engineers, architects, attorneys, and other professionals and all court or arbitration or other dispute resolution costs) arising out of or relating to any infringement of patent rights or copyrights incident to the use in the performance of the Work or resulting from the incorporation in the Work of any invention, design, process, product, or device not specified in the Contract Documents.

7.08 *Permits*

- A. Unless otherwise provided in the Contract Documents, Contractor shall obtain and pay for all construction permits and licenses. Owner shall assist Contractor, when necessary, in obtaining such permits and licenses. Contractor shall pay all governmental charges and inspection fees necessary for the prosecution of the Work which are applicable at the time of the submission of Contractor's Bid (or when Contractor became bound under a negotiated contract). Owner shall pay all charges of utility owners for connections for providing permanent service to the Work

7.09 *Taxes*

- A. Contractor shall pay all sales, consumer, use, and other similar taxes required to be paid by Contractor in accordance with the Laws and Regulations of the place of the Project which are applicable during the performance of the Work.

7.10 *Laws and Regulations*

- A. Contractor shall give all notices required by and shall comply with all Laws and Regulations applicable to the performance of the Work. Except where otherwise expressly required by applicable Laws and Regulations, neither Owner nor Engineer shall be responsible for monitoring Contractor's compliance with any Laws or Regulations.
- B. If Contractor performs any Work or takes any other action knowing or having reason to know that it is contrary to Laws or Regulations, Contractor shall bear all resulting costs and losses, and shall indemnify and hold harmless Owner and Engineer, and the officers, directors, members, partners, employees, agents, consultants, and subcontractors of each and any of them from and against all claims, costs, losses, and damages (including but not limited to all fees and charges of engineers, architects, attorneys, and other professionals and all court or arbitration or other dispute resolution costs) arising out of or relating to such Work or other action. It shall not be Contractor's responsibility to make certain that the Work described in the Contract Documents is in accordance with Laws and Regulations, but this shall not relieve Contractor of Contractor's obligations under Paragraph 3.03.
- C. Owner or Contractor may give notice to the other party of any changes after the submission of Contractor's Bid (or after the date when Contractor became bound under a negotiated contract) in Laws or Regulations having an effect on the cost or time of performance of the Work, including but not limited to changes in Laws or Regulations having an effect on procuring permits and on sales, use, value-added, consumption, and other similar taxes. If Owner and Contractor are unable to agree on entitlement to or on the amount or extent, if any, of any adjustment in Contract Price or Contract Times resulting from such changes, then within 30 days of such notice Contractor may submit a Change Proposal, or Owner may initiate a Claim.

7.11 *Record Documents*

- A. Contractor shall maintain in a safe place at the Site one printed record copy of all Drawings, Specifications, Addenda, Change Orders, Work Change Directives, Field Orders, written interpretations and clarifications, and approved Shop Drawings. Contractor shall keep such record documents in good order and annotate them to show changes made during construction. These record documents, together with all approved Samples, will be available to Engineer for reference. Upon completion of the Work, Contractor shall deliver these record documents to Engineer.

7.12 *Safety and Protection*

- A. Contractor shall be solely responsible for initiating, maintaining, and supervising all safety precautions and programs in connection with the Work. Such responsibility does not relieve Subcontractors of their responsibility for the safety of persons or property in the performance of their work, nor for compliance with applicable safety Laws and Regulations. Contractor shall take all necessary precautions for the safety of, and shall provide the necessary protection to prevent damage, injury, or loss to:
 - 1. all persons on the Site or who may be affected by the Work;

2. all the Work and materials and equipment to be incorporated therein, whether in storage on or off the Site; and
 3. other property at the Site or adjacent thereto, including trees, shrubs, lawns, walks, pavements, roadways, structures, other work in progress, utilities, and Underground Facilities not designated for removal, relocation, or replacement in the course of construction.
- B. Contractor shall comply with all applicable Laws and Regulations relating to the safety of persons or property, or to the protection of persons or property from damage, injury, or loss; and shall erect and maintain all necessary safeguards for such safety and protection. Contractor shall notify Owner; the owners of adjacent property, Underground Facilities, and other utilities; and other contractors and utility owners performing work at or adjacent to the Site, when prosecution of the Work may affect them, and shall cooperate with them in the protection, removal, relocation, and replacement of their property or work in progress.
 - C. Contractor shall comply with the applicable requirements of Owner's safety programs, if any. The Supplementary Conditions identify any Owner's safety programs that are applicable to the Work.
 - D. Contractor shall inform Owner and Engineer of the specific requirements of Contractor's safety program with which Owner's and Engineer's employees and representatives must comply while at the Site.
 - E. All damage, injury, or loss to any property referred to in Paragraph 7.12.A.2 or 7.12.A.3 caused, directly or indirectly, in whole or in part, by Contractor, any Subcontractor, Supplier, or any other individual or entity directly or indirectly employed by any of them to perform any of the Work, or anyone for whose acts any of them may be liable, shall be remedied by Contractor at its expense (except damage or loss attributable to the fault of Drawings or Specifications or to the acts or omissions of Owner or Engineer or anyone employed by any of them, or anyone for whose acts any of them may be liable, and not attributable, directly or indirectly, in whole or in part, to the fault or negligence of Contractor or any Subcontractor, Supplier, or other individual or entity directly or indirectly employed by any of them).
 - F. Contractor's duties and responsibilities for safety and protection shall continue until such time as all the Work is completed and Engineer has issued a notice to Owner and Contractor in accordance with Paragraph 15.06.B that the Work is acceptable (except as otherwise expressly provided in connection with Substantial Completion).
 - G. Contractor's duties and responsibilities for safety and protection shall resume whenever Contractor or any Subcontractor or Supplier returns to the Site to fulfill warranty or correction obligations, or to conduct other tasks arising from the Contract Documents.

7.13 *Safety Representative*

- A. Contractor shall designate a qualified and experienced safety representative at the Site whose duties and responsibilities shall be the prevention of accidents and the maintaining and supervising of safety precautions and programs.

7.14 *Hazard Communication Programs*

- A. Contractor shall be responsible for coordinating any exchange of material safety data sheets or other hazard communication information required to be made available to or

exchanged between or among employers at the Site in accordance with Laws or Regulations.

7.15 *Emergencies*

- A. In emergencies affecting the safety or protection of persons or the Work or property at the Site or adjacent thereto, Contractor is obligated to act to prevent threatened damage, injury, or loss. Contractor shall give Engineer prompt written notice if Contractor believes that any significant changes in the Work or variations from the Contract Documents have been caused thereby or are required as a result thereof. If Engineer determines that a change in the Contract Documents is required because of the action taken by Contractor in response to such an emergency, a Work Change Directive or Change Order will be issued.

7.16 *Shop Drawings, Samples, and Other Submittals*

A. *Shop Drawing and Sample Submittal Requirements:*

1. Before submitting a Shop Drawing or Sample, Contractor shall have:
 - a. reviewed and coordinated the Shop Drawing or Sample with other Shop Drawings and Samples and with the requirements of the Work and the Contract Documents;
 - b. determined and verified all field measurements, quantities, dimensions, specified performance and design criteria, installation requirements, materials, catalog numbers, and similar information with respect thereto;
 - c. determined and verified the suitability of all materials and equipment offered with respect to the indicated application, fabrication, shipping, handling, storage, assembly, and installation pertaining to the performance of the Work; and
 - d. determined and verified all information relative to Contractor's responsibilities for means, methods, techniques, sequences, and procedures of construction, and safety precautions and programs incident thereto.
2. Each submittal shall bear a stamp or specific written certification that Contractor has satisfied Contractor's obligations under the Contract Documents with respect to Contractor's review of that submittal, and that Contractor approves the submittal.
3. With each submittal, Contractor shall give Engineer specific written notice of any variations that the Shop Drawing or Sample may have from the requirements of the Contract Documents. This notice shall be set forth in a written communication separate from the Shop Drawings or Sample submittal; and, in addition, in the case of Shop Drawings by a specific notation made on each Shop Drawing submitted to Engineer for review and approval of each such variation.

- B. *Submittal Procedures for Shop Drawings and Samples:* Contractor shall submit Shop Drawings and Samples to Engineer for review and approval in accordance with the accepted Schedule of Submittals. Each submittal will be identified as Engineer may require.

1. *Shop Drawings:*

- a. Contractor shall submit the number of copies required in the Specifications.
- b. Data shown on the Shop Drawings will be complete with respect to quantities, dimensions, specified performance and design criteria, materials, and similar data to show Engineer the services, materials, and equipment Contractor proposes to

provide and to enable Engineer to review the information for the limited purposes required by Paragraph 7.16.D.

2. *Samples:*
 - a. Contractor shall submit the number of Samples required in the Specifications.
 - b. Contractor shall clearly identify each Sample as to material, Supplier, pertinent data such as catalog numbers, the use for which intended and other data as Engineer may require to enable Engineer to review the submittal for the limited purposes required by Paragraph 7.16.D.
 3. Where a Shop Drawing or Sample is required by the Contract Documents or the Schedule of Submittals, any related Work performed prior to Engineer's review and approval of the pertinent submittal will be at the sole expense and responsibility of Contractor.
- C. *Other Submittals:* Contractor shall submit other submittals to Engineer in accordance with the accepted Schedule of Submittals, and pursuant to the applicable terms of the Specifications.
- D. *Engineer's Review:*
1. Engineer will provide timely review of Shop Drawings and Samples in accordance with the Schedule of Submittals acceptable to Engineer. Engineer's review and approval will be only to determine if the items covered by the submittals will, after installation or incorporation in the Work, conform to the information given in the Contract Documents and be compatible with the design concept of the completed Project as a functioning whole as indicated by the Contract Documents.
 2. Engineer's review and approval will not extend to means, methods, techniques, sequences, or procedures of construction or to safety precautions or programs incident thereto.
 3. Engineer's review and approval of a separate item as such will not indicate approval of the assembly in which the item functions.
 4. Engineer's review and approval of a Shop Drawing or Sample shall not relieve Contractor from responsibility for any variation from the requirements of the Contract Documents unless Contractor has complied with the requirements of Paragraph 7.16.A.3 and Engineer has given written approval of each such variation by specific written notation thereof incorporated in or accompanying the Shop Drawing or Sample. Engineer will document any such approved variation from the requirements of the Contract Documents in a Field Order.
 5. Engineer's review and approval of a Shop Drawing or Sample shall not relieve Contractor from responsibility for complying with the requirements of Paragraph 7.16.A and B.
 6. Engineer's review and approval of a Shop Drawing or Sample, or of a variation from the requirements of the Contract Documents, shall not, under any circumstances, change the Contract Times or Contract Price, unless such changes are included in a Change Order.
 7. Neither Engineer's receipt, review, acceptance or approval of a Shop Drawing, Sample, or other submittal shall result in such item becoming a Contract Document.

8. Contractor shall perform the Work in compliance with the requirements and commitments set forth in approved Shop Drawings and Samples, subject to the provisions of Paragraph 7.16.D.4.

E. *Resubmittal Procedures:*

1. Contractor shall make corrections required by Engineer and shall return the required number of corrected copies of Shop Drawings and submit, as required, new Samples for review and approval. Contractor shall direct specific attention in writing to revisions other than the corrections called for by Engineer on previous submittals.
2. Contractor shall furnish required submittals with sufficient information and accuracy to obtain required approval of an item with no more than three submittals. Engineer will record Engineer's time for reviewing a fourth or subsequent submittal of a Shop Drawings, sample, or other item requiring approval, and Contractor shall be responsible for Engineer's charges to Owner for such time. Owner may impose a set-off against payments due to Contractor to secure reimbursement for such charges.
3. If Contractor requests a change of a previously approved submittal item, Contractor shall be responsible for Engineer's charges to Owner for its review time, and Owner may impose a set-off against payments due to Contractor to secure reimbursement for such charges, unless the need for such change is beyond the control of Contractor.

7.17 *Contractor's General Warranty and Guarantee*

- A. Contractor warrants and guarantees to Owner that all Work will be in accordance with the Contract Documents and will not be defective. Engineer and its officers, directors, members, partners, employees, agents, consultants, and subcontractors shall be entitled to rely on Contractor's warranty and guarantee.
- B. Contractor's warranty and guarantee hereunder excludes defects or damage caused by:
 1. abuse, modification, or improper maintenance or operation by persons other than Contractor, Subcontractors, Suppliers, or any other individual or entity for whom Contractor is responsible; or
 2. normal wear and tear under normal usage.
- C. Contractor's obligation to perform and complete the Work in accordance with the Contract Documents shall be absolute. None of the following will constitute an acceptance of Work that is not in accordance with the Contract Documents or a release of Contractor's obligation to perform the Work in accordance with the Contract Documents:
 1. observations by Engineer;
 2. recommendation by Engineer or payment by Owner of any progress or final payment;
 3. the issuance of a certificate of Substantial Completion by Engineer or any payment related thereto by Owner;
 4. use or occupancy of the Work or any part thereof by Owner;
 5. any review and approval of a Shop Drawing or Sample submittal;
 6. the issuance of a notice of acceptability by Engineer;
 7. any inspection, test, or approval by others; or
 8. any correction of defective Work by Owner.

- D. If the Contract requires the Contractor to accept the assignment of a contract entered into by Owner, then the specific warranties, guarantees, and correction obligations contained in the assigned contract shall govern with respect to Contractor's performance obligations to Owner for the Work described in the assigned contract.

7.18 *Indemnification*

- A. To the fullest extent permitted by Laws and Regulations, and in addition to any other obligations of Contractor under the Contract or otherwise, Contractor shall indemnify and hold harmless Owner and Engineer, and the officers, directors, members, partners, employees, agents, consultants and subcontractors of each and any of them from and against all claims, costs, losses, and damages (including but not limited to all fees and charges of engineers, architects, attorneys, and other professionals and all court or arbitration or other dispute resolution costs) arising out of or relating to the performance of the Work, provided that any such claim, cost, loss, or damage is attributable to bodily injury, sickness, disease, or death, or to injury to or destruction of tangible property (other than the Work itself), including the loss of use resulting therefrom but only to the extent caused by any negligent act or omission of Contractor, any Subcontractor, any Supplier, or any individual or entity directly or indirectly employed by any of them to perform any of the Work or anyone for whose acts any of them may be liable.
- B. In any and all claims against Owner or Engineer or any of their officers, directors, members, partners, employees, agents, consultants, or subcontractors by any employee (or the survivor or personal representative of such employee) of Contractor, any Subcontractor, any Supplier, or any individual or entity directly or indirectly employed by any of them to perform any of the Work, or anyone for whose acts any of them may be liable, the indemnification obligation under Paragraph 7.18.A shall not be limited in any way by any limitation on the amount or type of damages, compensation, or benefits payable by or for Contractor or any such Subcontractor, Supplier, or other individual or entity under workers' compensation acts, disability benefit acts, or other employee benefit acts.
- C. The indemnification obligations of Contractor under Paragraph 7.18.A shall not extend to the liability of Engineer and Engineer's officers, directors, members, partners, employees, agents, consultants and subcontractors arising out of:
 - 1. the preparation or approval of, or the failure to prepare or approve maps, Drawings, opinions, reports, surveys, Change Orders, designs, or Specifications; or
 - 2. giving directions or instructions, or failing to give them, if that is the primary cause of the injury or damage.

7.19 *Delegation of Professional Design Services*

- A. Contractor will not be required to provide professional design services unless such services are specifically required by the Contract Documents for a portion of the Work or unless such services are required to carry out Contractor's responsibilities for construction means, methods, techniques, sequences and procedures. Contractor shall not be required to provide professional services in violation of applicable Laws and Regulations.
- B. If professional design services or certifications by a design professional related to systems, materials, or equipment are specifically required of Contractor by the Contract Documents, Owner and Engineer will specify all performance and design criteria that such services must satisfy. Contractor shall cause such services or certifications to be provided by a properly licensed professional, whose signature and seal shall appear on all drawings, calculations, specifications, certifications, and other submittals prepared by such professional. Shop

Drawings and other submittals related to the Work designed or certified by such professional, if prepared by others, shall bear such professional's written approval when submitted to Engineer.

- C. Owner and Engineer shall be entitled to rely upon the adequacy, accuracy, and completeness of the services, certifications, or approvals performed by such design professionals, provided Owner and Engineer have specified to Contractor all performance and design criteria that such services must satisfy.
- D. Pursuant to this paragraph, Engineer's review and approval of design calculations and design drawings will be only for the limited purpose of checking for conformance with performance and design criteria given and the design concept expressed in the Contract Documents. Engineer's review and approval of Shop Drawings and other submittals (except design calculations and design drawings) will be only for the purpose stated in Paragraph 7.16.D.1.
- E. Contractor shall not be responsible for the adequacy of the performance or design criteria specified by Owner or Engineer.

ARTICLE 8 – OTHER WORK AT THE SITE

8.01 *Other Work*

- A. In addition to and apart from the Work under the Contract Documents, the Owner may perform other work at or adjacent to the Site. Such other work may be performed by Owner's employees, or through contracts between the Owner and third parties. Owner may also arrange to have third-party utility owners perform work on their utilities and facilities at or adjacent to the Site.
- B. If Owner performs other work at or adjacent to the Site with Owner's employees, or through contracts for such other work, then Owner shall give Contractor written notice thereof prior to starting any such other work. If Owner has advance information regarding the start of any utility work at or adjacent to the Site, Owner shall provide such information to Contractor.
- C. Contractor shall afford each other contractor that performs such other work, each utility owner performing other work, and Owner, if Owner is performing other work with Owner's employees, proper and safe access to the Site, and provide a reasonable opportunity for the introduction and storage of materials and equipment and the execution of such other work. Contractor shall do all cutting, fitting, and patching of the Work that may be required to properly connect or otherwise make its several parts come together and properly integrate with such other work. Contractor shall not endanger any work of others by cutting, excavating, or otherwise altering such work; provided, however, that Contractor may cut or alter others' work with the written consent of Engineer and the others whose work will be affected.
- D. If the proper execution or results of any part of Contractor's Work depends upon work performed by others under this Article 8, Contractor shall inspect such other work and promptly report to Engineer in writing any delays, defects, or deficiencies in such other work that render it unavailable or unsuitable for the proper execution and results of Contractor's Work. Contractor's failure to so report will constitute an acceptance of such other work as fit and proper for integration with Contractor's Work except for latent defects and deficiencies in such other work.

8.02 *Coordination*

- A. If Owner intends to contract with others for the performance of other work at or adjacent to the Site, to perform other work at or adjacent to the Site with Owner's employees, or to arrange to have utility owners perform work at or adjacent to the Site, the following will be set forth in the Supplementary Conditions or provided to Contractor prior to the start of any such other work:
 - 1. the identity of the individual or entity that will have authority and responsibility for coordination of the activities among the various contractors;
 - 2. an itemization of the specific matters to be covered by such authority and responsibility; and
 - 3. the extent of such authority and responsibilities.
- B. Unless otherwise provided in the Supplementary Conditions, Owner shall have sole authority and responsibility for such coordination.

8.03 *Legal Relationships*

- A. If, in the course of performing other work at or adjacent to the Site for Owner, the Owner's employees, any other contractor working for Owner, or any utility owner causes damage to the Work or to the property of Contractor or its Subcontractors, or delays, disrupts, interferes with, or increases the scope or cost of the performance of the Work, through actions or inaction, then Contractor shall be entitled to an equitable adjustment in the Contract Price or the Contract Times, or both. Contractor must submit any Change Proposal seeking an equitable adjustment in the Contract Price or the Contract Times under this paragraph within 30 days of the damaging, delaying, disrupting, or interfering event. The entitlement to, and extent of, any such equitable adjustment shall take into account information (if any) regarding such other work that was provided to Contractor in the Contract Documents prior to the submittal of the Bid or the final negotiation of the terms of the Contract. When applicable, any such equitable adjustment in Contract Price shall be conditioned on Contractor assigning to Owner all Contractor's rights against such other contractor or utility owner with respect to the damage, delay, disruption, or interference that is the subject of the adjustment. Contractor's entitlement to an adjustment of the Contract Times is conditioned on such adjustment being essential to Contractor's ability to complete the Work within the Contract Times.
- B. Contractor shall take reasonable and customary measures to avoid damaging, delaying, disrupting, or interfering with the work of Owner, any other contractor, or any utility owner performing other work at or adjacent to the Site. If Contractor fails to take such measures and as a result damages, delays, disrupts, or interferes with the work of any such other contractor or utility owner, then Owner may impose a set-off against payments due to Contractor, and assign to such other contractor or utility owner the Owner's contractual rights against Contractor with respect to the breach of the obligations set forth in this paragraph.
- C. When Owner is performing other work at or adjacent to the Site with Owner's employees, Contractor shall be liable to Owner for damage to such other work, and for the reasonable direct delay, disruption, and interference costs incurred by Owner as a result of Contractor's failure to take reasonable and customary measures with respect to Owner's other work. In response to such damage, delay, disruption, or interference, Owner may impose a set-off against payments due to Contractor.

- D. If Contractor damages, delays, disrupts, or interferes with the work of any other contractor, or any utility owner performing other work at or adjacent to the Site, through Contractor's failure to take reasonable and customary measures to avoid such impacts, or if any claim arising out of Contractor's actions, inactions, or negligence in performance of the Work at or adjacent to the Site is made by any such other contractor or utility owner against Contractor, Owner, or Engineer, then Contractor shall (1) promptly attempt to settle the claim as to all parties through negotiations with such other contractor or utility owner, or otherwise resolve the claim by arbitration or other dispute resolution proceeding or at law, and (2) indemnify and hold harmless Owner and Engineer, and the officers, directors, members, partners, employees, agents, consultants and subcontractors of each and any of them from and against any such claims, and against all costs, losses, and damages (including but not limited to all fees and charges of engineers, architects, attorneys, and other professionals and all court or arbitration or other dispute resolution costs) arising out of or relating to such damage, delay, disruption, or interference.

ARTICLE 9 – OWNER'S RESPONSIBILITIES

9.01 *Communications to Contractor*

- A. Except as otherwise provided in these General Conditions, Owner shall issue all communications to Contractor through Engineer.

9.02 *Replacement of Engineer*

- A. Owner may at its discretion appoint an engineer to replace Engineer, provided Contractor makes no reasonable objection to the replacement engineer. The replacement engineer's status under the Contract Documents shall be that of the former Engineer.

9.03 *Furnish Data*

- A. Owner shall promptly furnish the data required of Owner under the Contract Documents.

9.04 *Pay When Due*

- A. Owner shall make payments to Contractor when they are due as provided in the Agreement.

9.05 *Lands and Easements; Reports, Tests, and Drawings*

- A. Owner's duties with respect to providing lands and easements are set forth in Paragraph 5.01.
- B. Owner's duties with respect to providing engineering surveys to establish reference points are set forth in Paragraph 4.03.
- C. Article 5 refers to Owner's identifying and making available to Contractor copies of reports of explorations and tests of conditions at the Site, and drawings of physical conditions relating to existing surface or subsurface structures at the Site.

9.06 *Insurance*

- A. Owner's responsibilities, if any, with respect to purchasing and maintaining liability and property insurance are set forth in Article 6.

9.07 *Change Orders*

- A. Owner's responsibilities with respect to Change Orders are set forth in Article 11.

9.08 *Inspections, Tests, and Approvals*

- A. Owner's responsibility with respect to certain inspections, tests, and approvals is set forth in Paragraph 14.02.B.

9.09 *Limitations on Owner's Responsibilities*

- A. The Owner shall not supervise, direct, or have control or authority over, nor be responsible for, Contractor's means, methods, techniques, sequences, or procedures of construction, or the safety precautions and programs incident thereto, or for any failure of Contractor to comply with Laws and Regulations applicable to the performance of the Work. Owner will not be responsible for Contractor's failure to perform the Work in accordance with the Contract Documents.

9.10 *Undisclosed Hazardous Environmental Condition*

- A. Owner's responsibility in respect to an undisclosed Hazardous Environmental Condition is set forth in Paragraph 5.06.

9.11 *Evidence of Financial Arrangements*

- A. Upon request of Contractor, Owner shall furnish Contractor reasonable evidence that financial arrangements have been made to satisfy Owner's obligations under the Contract Documents (including obligations under proposed changes in the Work).

9.12 *Safety Programs*

- A. While at the Site, Owner's employees and representatives shall comply with the specific applicable requirements of Contractor's safety programs of which Owner has been informed.
- B. Owner shall furnish copies of any applicable Owner safety programs to Contractor.

ARTICLE 10 – ENGINEER'S STATUS DURING CONSTRUCTION

10.01 *Owner's Representative*

- A. Engineer will be Owner's representative during the construction period. The duties and responsibilities and the limitations of authority of Engineer as Owner's representative during construction are set forth in the Contract.

10.02 *Visits to Site*

- A. Engineer will make visits to the Site at intervals appropriate to the various stages of construction as Engineer deems necessary in order to observe as an experienced and qualified design professional the progress that has been made and the quality of the various aspects of Contractor's executed Work. Based on information obtained during such visits and observations, Engineer, for the benefit of Owner, will determine, in general, if the Work is proceeding in accordance with the Contract Documents. Engineer will not be required to make exhaustive or continuous inspections on the Site to check the quality or quantity of the Work. Engineer's efforts will be directed toward providing for Owner a greater degree of confidence that the completed Work will conform generally to the Contract Documents. On the basis of such visits and observations, Engineer will keep Owner informed of the progress of the Work and will endeavor to guard Owner against defective Work.
- B. Engineer's visits and observations are subject to all the limitations on Engineer's authority and responsibility set forth in Paragraph 10.08. Particularly, but without limitation, during

or as a result of Engineer's visits or observations of Contractor's Work, Engineer will not supervise, direct, control, or have authority over or be responsible for Contractor's means, methods, techniques, sequences, or procedures of construction, or the safety precautions and programs incident thereto, or for any failure of Contractor to comply with Laws and Regulations applicable to the performance of the Work.

10.03 *Project Representative*

- A. If Owner and Engineer have agreed that Engineer will furnish a Resident Project Representative to represent Engineer at the Site and assist Engineer in observing the progress and quality of the Work, then the authority and responsibilities of any such Resident Project Representative will be as provided in the Supplementary Conditions, and limitations on the responsibilities thereof will be as provided in Paragraph 10.08. If Owner designates another representative or agent to represent Owner at the Site who is not Engineer's consultant, agent, or employee, the responsibilities and authority and limitations thereon of such other individual or entity will be as provided in the Supplementary Conditions.

10.04 *Rejecting Defective Work*

- A. Engineer has the authority to reject Work in accordance with Article 14.

10.05 *Shop Drawings, Change Orders and Payments*

- A. Engineer's authority, and limitations thereof, as to Shop Drawings and Samples, are set forth in Paragraph 7.16.
- B. Engineer's authority, and limitations thereof, as to design calculations and design drawings submitted in response to a delegation of professional design services, if any, are set forth in Paragraph 7.19.
- C. Engineer's authority as to Change Orders is set forth in Article 11.
- D. Engineer's authority as to Applications for Payment is set forth in Article 15.

10.06 *Determinations for Unit Price Work*

- A. Engineer will determine the actual quantities and classifications of Unit Price Work performed by Contractor as set forth in Paragraph 13.03.

10.07 *Decisions on Requirements of Contract Documents and Acceptability of Work*

- A. Engineer will render decisions regarding the requirements of the Contract Documents, and judge the acceptability of the Work, pursuant to the specific procedures set forth herein for initial interpretations, Change Proposals, and acceptance of the Work. In rendering such decisions and judgments, Engineer will not show partiality to Owner or Contractor, and will not be liable to Owner, Contractor, or others in connection with any proceedings, interpretations, decisions, or judgments conducted or rendered in good faith.

10.08 *Limitations on Engineer's Authority and Responsibilities*

- A. Neither Engineer's authority or responsibility under this Article 10 or under any other provision of the Contract, nor any decision made by Engineer in good faith either to exercise or not exercise such authority or responsibility or the undertaking, exercise, or performance of any authority or responsibility by Engineer, shall create, impose, or give rise to any duty in contract, tort, or otherwise owed by Engineer to Contractor, any Subcontractor, any Supplier, any other individual or entity, or to any surety for or employee or agent of any of them.

- B. Engineer will not supervise, direct, control, or have authority over or be responsible for Contractor's means, methods, techniques, sequences, or procedures of construction, or the safety precautions and programs incident thereto, or for any failure of Contractor to comply with Laws and Regulations applicable to the performance of the Work. Engineer will not be responsible for Contractor's failure to perform the Work in accordance with the Contract Documents.
- C. Engineer will not be responsible for the acts or omissions of Contractor or of any Subcontractor, any Supplier, or of any other individual or entity performing any of the Work.
- D. Engineer's review of the final Application for Payment and accompanying documentation and all maintenance and operating instructions, schedules, guarantees, bonds, certificates of inspection, tests and approvals, and other documentation required to be delivered by Paragraph 15.06.A will only be to determine generally that their content complies with the requirements of, and in the case of certificates of inspections, tests, and approvals, that the results certified indicate compliance with the Contract Documents.
- E. The limitations upon authority and responsibility set forth in this Paragraph 10.08 shall also apply to the Resident Project Representative, if any.

10.09 *Compliance with Safety Program*

- A. While at the Site, Engineer's employees and representatives will comply with the specific applicable requirements of Owner's and Contractor's safety programs (if any) of which Engineer has been informed.

ARTICLE 11 – AMENDING THE CONTRACT DOCUMENTS; CHANGES IN THE WORK

11.01 *Amending and Supplementing Contract Documents*

- A. The Contract Documents may be amended or supplemented by a Change Order, a Work Change Directive, or a Field Order.
 1. *Change Orders:*
 - a. If an amendment or supplement to the Contract Documents includes a change in the Contract Price or the Contract Times, such amendment or supplement must be set forth in a Change Order. A Change Order also may be used to establish amendments and supplements of the Contract Documents that do not affect the Contract Price or Contract Times.
 - b. Owner and Contractor may amend those terms and conditions of the Contract Documents that do not involve (1) the performance or acceptability of the Work, (2) the design (as set forth in the Drawings, Specifications, or otherwise), or (3) other engineering or technical matters, without the recommendation of the Engineer. Such an amendment shall be set forth in a Change Order.
 2. *Work Change Directives:* A Work Change Directive will not change the Contract Price or the Contract Times but is evidence that the parties expect that the modification ordered or documented by a Work Change Directive will be incorporated in a subsequently issued Change Order, following negotiations by the parties as to the Work Change Directive's effect, if any, on the Contract Price and Contract Times; or, if negotiations are unsuccessful, by a determination under the terms of the Contract Documents governing adjustments, expressly including Paragraph 11.04 regarding change of Contract Price. Contractor must submit any Change Proposal seeking an

adjustment of the Contract Price or the Contract Times, or both, no later than 30 days after the completion of the Work set out in the Work Change Directive. Owner must submit any Claim seeking an adjustment of the Contract Price or the Contract Times, or both, no later than 60 days after issuance of the Work Change Directive.

3. *Field Orders*: Engineer may authorize minor changes in the Work if the changes do not involve an adjustment in the Contract Price or the Contract Times and are compatible with the design concept of the completed Project as a functioning whole as indicated by the Contract Documents. Such changes will be accomplished by a Field Order and will be binding on Owner and also on Contractor, which shall perform the Work involved promptly. If Contractor believes that a Field Order justifies an adjustment in the Contract Price or Contract Times, or both, then before proceeding with the Work at issue, Contractor shall submit a Change Proposal as provided herein.

11.02 *Owner-Authorized Changes in the Work*

- A. Without invalidating the Contract and without notice to any surety, Owner may, at any time or from time to time, order additions, deletions, or revisions in the Work. Such changes shall be supported by Engineer's recommendation, to the extent the change involves the design (as set forth in the Drawings, Specifications, or otherwise), or other engineering or technical matters. Such changes may be accomplished by a Change Order, if Owner and Contractor have agreed as to the effect, if any, of the changes on Contract Times or Contract Price; or by a Work Change Directive. Upon receipt of any such document, Contractor shall promptly proceed with the Work involved; or, in the case of a deletion in the Work, promptly cease construction activities with respect to such deleted Work. Added or revised Work shall be performed under the applicable conditions of the Contract Documents. Nothing in this paragraph shall obligate Contractor to undertake work that Contractor reasonably concludes cannot be performed in a manner consistent with Contractor's safety obligations under the Contract Documents or Laws and Regulations.

11.03 *Unauthorized Changes in the Work*

- A. Contractor shall not be entitled to an increase in the Contract Price or an extension of the Contract Times with respect to any work performed that is not required by the Contract Documents, as amended, modified, or supplemented, except in the case of an emergency as provided in Paragraph 7.15 or in the case of uncovering Work as provided in Paragraph 14.05.

11.04 *Change of Contract Price*

- A. The Contract Price may only be changed by a Change Order. Any Change Proposal for an adjustment in the Contract Price shall comply with the provisions of Paragraph 11.06. Any Claim for an adjustment of Contract Price shall comply with the provisions of Article 12.
- B. An adjustment in the Contract Price will be determined as follows:
 1. where the Work involved is covered by unit prices contained in the Contract Documents, then by application of such unit prices to the quantities of the items involved (subject to the provisions of Paragraph 13.03); or
 2. where the Work involved is not covered by unit prices contained in the Contract Documents, then by a mutually agreed lump sum (which may include an allowance for overhead and profit not necessarily in accordance with Paragraph 11.04.C.2); or
 3. where the Work involved is not covered by unit prices contained in the Contract Documents and the parties do not reach mutual agreement to a lump sum, then on

the basis of the Cost of the Work (determined as provided in Paragraph 13.01) plus a Contractor's fee for overhead and profit (determined as provided in Paragraph 11.04.C).

- C. *Contractor's Fee*: When applicable, the Contractor's fee for overhead and profit shall be determined as follows:
1. a mutually acceptable fixed fee; or
 2. if a fixed fee is not agreed upon, then a fee based on the following percentages of the various portions of the Cost of the Work:
 - a. for costs incurred under Paragraphs 13.01.B.1 and 13.01.B.2, the Contractor's fee shall be 15 percent;
 - b. for costs incurred under Paragraph 13.01.B.3, the Contractor's fee shall be five percent;
 - c. where one or more tiers of subcontracts are on the basis of Cost of the Work plus a fee and no fixed fee is agreed upon, the intent of Paragraphs 11.01.C.2.a and 11.01.C.2.b is that the Contractor's fee shall be based on: (1) a fee of 15 percent of the costs incurred under Paragraphs 13.01.A.1 and 13.01.A.2 by the Subcontractor that actually performs the Work, at whatever tier, and (2) with respect to Contractor itself and to any Subcontractors of a tier higher than that of the Subcontractor that actually performs the Work, a fee of five percent of the amount (fee plus underlying costs incurred) attributable to the next lower tier Subcontractor; provided, however, that for any such subcontracted work the maximum total fee to be paid by Owner shall be no greater than 27 percent of the costs incurred by the Subcontractor that actually performs the work;
 - d. no fee shall be payable on the basis of costs itemized under Paragraphs 13.01.B.4, 13.01.B.5, and 13.01.C;
 - e. the amount of credit to be allowed by Contractor to Owner for any change which results in a net decrease in cost will be the amount of the actual net decrease in cost plus a deduction in Contractor's fee by an amount equal to five percent of such net decrease; and
 - f. when both additions and credits are involved in any one change, the adjustment in Contractor's fee shall be computed on the basis of the net change in accordance with Paragraphs 11.04.C.2.a through 11.04.C.2.e, inclusive.

11.05 *Change of Contract Times*

- A. The Contract Times may only be changed by a Change Order. Any Change Proposal for an adjustment in the Contract Times shall comply with the provisions of Paragraph 11.06. Any Claim for an adjustment in the Contract Times shall comply with the provisions of Article 12.
- B. An adjustment of the Contract Times shall be subject to the limitations set forth in Paragraph 4.05, concerning delays in Contractor's progress.

11.06 *Change Proposals*

- A. Contractor shall submit a Change Proposal to Engineer to request an adjustment in the Contract Times or Contract Price; appeal an initial decision by Engineer concerning the requirements of the Contract Documents or relating to the acceptability of the Work under the Contract Documents; contest a set-off against payment due; or seek other relief under

the Contract. The Change Proposal shall specify any proposed change in Contract Times or Contract Price, or both, or other proposed relief, and explain the reason for the proposed change, with citations to any governing or applicable provisions of the Contract Documents.

1. *Procedures:* Contractor shall submit each Change Proposal to Engineer promptly (but in no event later than 30 days) after the start of the event giving rise thereto, or after such initial decision. The Contractor shall submit supporting data, including the proposed change in Contract Price or Contract Time (if any), to the Engineer and Owner within 15 days after the submittal of the Change Proposal. The supporting data shall be accompanied by a written statement that the supporting data are accurate and complete, and that any requested time or price adjustment is the entire adjustment to which Contractor believes it is entitled as a result of said event. Engineer will advise Owner regarding the Change Proposal, and consider any comments or response from Owner regarding the Change Proposal.
 2. *Engineer's Action:* Engineer will review each Change Proposal and, within 30 days after receipt of the Contractor's supporting data, either deny the Change Proposal in whole, approve it in whole, or deny it in part and approve it in part. Such actions shall be in writing, with a copy provided to Owner and Contractor. If Engineer does not take action on the Change Proposal within 30 days, then either Owner or Contractor may at any time thereafter submit a letter to the other party indicating that as a result of Engineer's inaction the Change Proposal is deemed denied, thereby commencing the time for appeal of the denial under Article 12.
 3. *Binding Decision:* Engineer's decision will be final and binding upon Owner and Contractor, unless Owner or Contractor appeals the decision by filing a Claim under Article 12.
- B. *Resolution of Certain Change Proposals:* If the Change Proposal does not involve the design (as set forth in the Drawings, Specifications, or otherwise), the acceptability of the Work, or other engineering or technical matters, then Engineer will notify the parties that the Engineer is unable to resolve the Change Proposal. For purposes of further resolution of such a Change Proposal, such notice shall be deemed a denial, and Contractor may choose to seek resolution under the terms of Article 12.

11.07 Execution of Change Orders

- A. Owner and Contractor shall execute appropriate Change Orders covering:
1. changes in the Contract Price or Contract Times which are agreed to by the parties, including any undisputed sum or amount of time for Work actually performed in accordance with a Work Change Directive;
 2. changes in Contract Price resulting from an Owner set-off, unless Contractor has duly contested such set-off;
 3. changes in the Work which are: (a) ordered by Owner pursuant to Paragraph 11.02, (b) required because of Owner's acceptance of defective Work under Paragraph 14.04 or Owner's correction of defective Work under Paragraph 14.07, or (c) agreed to by the parties, subject to the need for Engineer's recommendation if the change in the Work involves the design (as set forth in the Drawings, Specifications, or otherwise), or other engineering or technical matters; and
 4. changes in the Contract Price or Contract Times, or other changes, which embody the substance of any final and binding results under Paragraph 11.06, or Article 12.

- B. If Owner or Contractor refuses to execute a Change Order that is required to be executed under the terms of this Paragraph 11.07, it shall be deemed to be of full force and effect, as if fully executed.

11.08 *Notification to Surety*

- A. If the provisions of any bond require notice to be given to a surety of any change affecting the general scope of the Work or the provisions of the Contract Documents (including, but not limited to, Contract Price or Contract Times), the giving of any such notice will be Contractor's responsibility. The amount of each applicable bond will be adjusted to reflect the effect of any such change.

ARTICLE 12 – CLAIMS

12.01 *Claims*

- A. *Claims Process:* The following disputes between Owner and Contractor shall be submitted to the Claims process set forth in this Article:
 - 1. Appeals by Owner or Contractor of Engineer's decisions regarding Change Proposals;
 - 2. Owner demands for adjustments in the Contract Price or Contract Times, or other relief under the Contract Documents; and
 - 3. Disputes that Engineer has been unable to address because they do not involve the design (as set forth in the Drawings, Specifications, or otherwise), the acceptability of the Work, or other engineering or technical matters.
- B. *Submittal of Claim:* The party submitting a Claim shall deliver it directly to the other party to the Contract promptly (but in no event later than 30 days) after the start of the event giving rise thereto; in the case of appeals regarding Change Proposals within 30 days of the decision under appeal. The party submitting the Claim shall also furnish a copy to the Engineer, for its information only. The responsibility to substantiate a Claim shall rest with the party making the Claim. In the case of a Claim by Contractor seeking an increase in the Contract Times or Contract Price, or both, Contractor shall certify that the Claim is made in good faith, that the supporting data are accurate and complete, and that to the best of Contractor's knowledge and belief the amount of time or money requested accurately reflects the full amount to which Contractor is entitled.
- C. *Review and Resolution:* The party receiving a Claim shall review it thoroughly, giving full consideration to its merits. The two parties shall seek to resolve the Claim through the exchange of information and direct negotiations. The parties may extend the time for resolving the Claim by mutual agreement. All actions taken on a Claim shall be stated in writing and submitted to the other party, with a copy to Engineer.
- D. *Mediation:*
 - 1. At any time after initiation of a Claim, Owner and Contractor may mutually agree to mediation of the underlying dispute. The agreement to mediate shall stay the Claim submittal and response process.
 - 2. If Owner and Contractor agree to mediation, then after 60 days from such agreement, either Owner or Contractor may unilaterally terminate the mediation process, and the Claim submittal and decision process shall resume as of the date of the termination. If the mediation proceeds but is unsuccessful in resolving the dispute, the Claim

submittal and decision process shall resume as of the date of the conclusion of the mediation, as determined by the mediator.

3. Owner and Contractor shall each pay one-half of the mediator's fees and costs.
- E. *Partial Approval*: If the party receiving a Claim approves the Claim in part and denies it in part, such action shall be final and binding unless within 30 days of such action the other party invokes the procedure set forth in Article 17 for final resolution of disputes.
- F. *Denial of Claim*: If efforts to resolve a Claim are not successful, the party receiving the Claim may deny it by giving written notice of denial to the other party. If the receiving party does not take action on the Claim within 90 days, then either Owner or Contractor may at any time thereafter submit a letter to the other party indicating that as a result of the inaction, the Claim is deemed denied, thereby commencing the time for appeal of the denial. A denial of the Claim shall be final and binding unless within 30 days of the denial the other party invokes the procedure set forth in Article 17 for the final resolution of disputes.
- G. *Final and Binding Results*: If the parties reach a mutual agreement regarding a Claim, whether through approval of the Claim, direct negotiations, mediation, or otherwise; or if a Claim is approved in part and denied in part, or denied in full, and such actions become final and binding; then the results of the agreement or action on the Claim shall be incorporated in a Change Order to the extent they affect the Contract, including the Work, the Contract Times, or the Contract Price.

ARTICLE 13 – COST OF THE WORK; ALLOWANCES; UNIT PRICE WORK

13.01 *Cost of the Work*

- A. *Purposes for Determination of Cost of the Work*: The term Cost of the Work means the sum of all costs necessary for the proper performance of the Work at issue, as further defined below. The provisions of this Paragraph 13.01 are used for two distinct purposes:
 1. To determine Cost of the Work when Cost of the Work is a component of the Contract Price, under cost-plus-fee, time-and-materials, or other cost-based terms; or
 2. To determine the value of a Change Order, Change Proposal, Claim, set-off, or other adjustment in Contract Price. When the value of any such adjustment is determined on the basis of Cost of the Work, Contractor is entitled only to those additional or incremental costs required because of the change in the Work or because of the event giving rise to the adjustment.
- B. *Costs Included*: Except as otherwise may be agreed to in writing by Owner, costs included in the Cost of the Work shall be in amounts no higher than those prevailing in the locality of the Project, shall not include any of the costs itemized in Paragraph 13.01.C, and shall include only the following items:
 1. Payroll costs for employees in the direct employ of Contractor in the performance of the Work under schedules of job classifications agreed upon by Owner and Contractor. Such employees shall include, without limitation, superintendents, foremen, and other personnel employed full time on the Work. Payroll costs for employees not employed full time on the Work shall be apportioned on the basis of their time spent on the Work. Payroll costs shall include, but not be limited to, salaries and wages plus the cost of fringe benefits, which shall include social security contributions, unemployment, excise, and payroll taxes, workers' compensation, health and retirement benefits, bonuses, sick leave, and vacation and holiday pay applicable

thereto. The expenses of performing Work outside of regular working hours, on Saturday, Sunday, or legal holidays, shall be included in the above to the extent authorized by Owner.

2. Cost of all materials and equipment furnished and incorporated in the Work, including costs of transportation and storage thereof, and Suppliers' field services required in connection therewith. All cash discounts shall accrue to Contractor unless Owner deposits funds with Contractor with which to make payments, in which case the cash discounts shall accrue to Owner. All trade discounts, rebates, and refunds and returns from sale of surplus materials and equipment shall accrue to Owner, and Contractor shall make provisions so that they may be obtained.
3. Payments made by Contractor to Subcontractors for Work performed by Subcontractors. If required by Owner, Contractor shall obtain competitive bids from subcontractors acceptable to Owner and Contractor and shall deliver such bids to Owner, who will then determine, with the advice of Engineer, which bids, if any, will be acceptable. If any subcontract provides that the Subcontractor is to be paid on the basis of Cost of the Work plus a fee, the Subcontractor's Cost of the Work and fee shall be determined in the same manner as Contractor's Cost of the Work and fee as provided in this Paragraph 13.01.
4. Costs of special consultants (including but not limited to engineers, architects, testing laboratories, surveyors, attorneys, and accountants) employed for services specifically related to the Work.
5. Supplemental costs including the following:
 - a. The proportion of necessary transportation, travel, and subsistence expenses of Contractor's employees incurred in discharge of duties connected with the Work.
 - b. Cost, including transportation and maintenance, of all materials, supplies, equipment, machinery, appliances, office, and temporary facilities at the Site, and hand tools not owned by the workers, which are consumed in the performance of the Work, and cost, less market value, of such items used but not consumed which remain the property of Contractor.
 - c. Rentals of all construction equipment and machinery, and the parts thereof, whether rented from Contractor or others in accordance with rental agreements approved by Owner with the advice of Engineer, and the costs of transportation, loading, unloading, assembly, dismantling, and removal thereof. All such costs shall be in accordance with the terms of said rental agreements. The rental of any such equipment, machinery, or parts shall cease when the use thereof is no longer necessary for the Work.
 - d. Sales, consumer, use, and other similar taxes related to the Work, and for which Contractor is liable, as imposed by Laws and Regulations.
 - e. Deposits lost for causes other than negligence of Contractor, any Subcontractor, or anyone directly or indirectly employed by any of them or for whose acts any of them may be liable, and royalty payments and fees for permits and licenses.
 - f. Losses and damages (and related expenses) caused by damage to the Work, not compensated by insurance or otherwise, sustained by Contractor in connection with the performance of the Work (except losses and damages within the deductible amounts of property insurance established in accordance with Paragraph 6.05), provided such losses and damages have resulted from causes

other than the negligence of Contractor, any Subcontractor, or anyone directly or indirectly employed by any of them or for whose acts any of them may be liable. Such losses shall include settlements made with the written consent and approval of Owner. No such losses, damages, and expenses shall be included in the Cost of the Work for the purpose of determining Contractor's fee.

- g. The cost of utilities, fuel, and sanitary facilities at the Site.
- h. Minor expenses such as communication service at the Site, express and courier services, and similar petty cash items in connection with the Work.
- i. The costs of premiums for all bonds and insurance that Contractor is required by the Contract Documents to purchase and maintain.

C. *Costs Excluded:* The term Cost of the Work shall not include any of the following items:

- 1. Payroll costs and other compensation of Contractor's officers, executives, principals (of partnerships and sole proprietorships), general managers, safety managers, engineers, architects, estimators, attorneys, auditors, accountants, purchasing and contracting agents, expeditors, timekeepers, clerks, and other personnel employed by Contractor, whether at the Site or in Contractor's principal or branch office for general administration of the Work and not specifically included in the agreed upon schedule of job classifications referred to in Paragraph 13.01.B.1 or specifically covered by Paragraph 13.01.B.4. The payroll costs and other compensation excluded here are to be considered administrative costs covered by the Contractor's fee.
- 2. Expenses of Contractor's principal and branch offices other than Contractor's office at the Site.
- 3. Any part of Contractor's capital expenses, including interest on Contractor's capital employed for the Work and charges against Contractor for delinquent payments.
- 4. Costs due to the negligence of Contractor, any Subcontractor, or anyone directly or indirectly employed by any of them or for whose acts any of them may be liable, including but not limited to, the correction of defective Work, disposal of materials or equipment wrongly supplied, and making good any damage to property.
- 5. Other overhead or general expense costs of any kind and the costs of any item not specifically and expressly included in Paragraph 13.01.B.

D. *Contractor's Fee:* When the Work as a whole is performed on the basis of cost-plus, Contractor's fee shall be determined as set forth in the Agreement. When the value of any Work covered by a Change Order, Change Proposal, Claim, set-off, or other adjustment in Contract Price is determined on the basis of Cost of the Work, Contractor's fee shall be determined as set forth in Paragraph 11.04.C.

E. *Documentation:* Whenever the Cost of the Work for any purpose is to be determined pursuant to this Article 13, Contractor will establish and maintain records thereof in accordance with generally accepted accounting practices and submit in a form acceptable to Engineer an itemized cost breakdown together with supporting data.

13.02 Allowances

A. It is understood that Contractor has included in the Contract Price all allowances so named in the Contract Documents and shall cause the Work so covered to be performed for such sums and by such persons or entities as may be acceptable to Owner and Engineer.

- B. *Cash Allowances*: Contractor agrees that:
 - 1. the cash allowances include the cost to Contractor (less any applicable trade discounts) of materials and equipment required by the allowances to be delivered at the Site, and all applicable taxes; and
 - 2. Contractor's costs for unloading and handling on the Site, labor, installation, overhead, profit, and other expenses contemplated for the cash allowances have been included in the Contract Price and not in the allowances, and no demand for additional payment on account of any of the foregoing will be valid.
- C. *Contingency Allowance*: Contractor agrees that a contingency allowance, if any, is for the sole use of Owner to cover unanticipated costs.
- D. Prior to final payment, an appropriate Change Order will be issued as recommended by Engineer to reflect actual amounts due Contractor on account of Work covered by allowances, and the Contract Price shall be correspondingly adjusted.

13.03 *Unit Price Work*

- A. Where the Contract Documents provide that all or part of the Work is to be Unit Price Work, initially the Contract Price will be deemed to include for all Unit Price Work an amount equal to the sum of the unit price for each separately identified item of Unit Price Work times the estimated quantity of each item as indicated in the Agreement.
- B. The estimated quantities of items of Unit Price Work are not guaranteed and are solely for the purpose of comparison of Bids and determining an initial Contract Price. Payments to Contractor for Unit Price Work will be based on actual quantities.
- C. Each unit price will be deemed to include an amount considered by Contractor to be adequate to cover Contractor's overhead and profit for each separately identified item.
- D. Engineer will determine the actual quantities and classifications of Unit Price Work performed by Contractor. Engineer will review with Contractor the Engineer's preliminary determinations on such matters before rendering a written decision thereon (by recommendation of an Application for Payment or otherwise). Engineer's written decision thereon will be final and binding (except as modified by Engineer to reflect changed factual conditions or more accurate data) upon Owner and Contractor, subject to the provisions of the following paragraph.
- E. Within 30 days of Engineer's written decision under the preceding paragraph, Contractor may submit a Change Proposal, or Owner may file a Claim, seeking an adjustment in the Contract Price if:
 - 1. the quantity of any item of Unit Price Work performed by Contractor differs materially and significantly from the estimated quantity of such item indicated in the Agreement;
 - 2. there is no corresponding adjustment with respect to any other item of Work; and
 - 3. Contractor believes that it is entitled to an increase in Contract Price as a result of having incurred additional expense or Owner believes that Owner is entitled to a decrease in Contract Price, and the parties are unable to agree as to the amount of any such increase or decrease.

ARTICLE 14 – TESTS AND INSPECTIONS; CORRECTION, REMOVAL OR ACCEPTANCE OF DEFECTIVE WORK

14.01 *Access to Work*

- A. Owner, Engineer, their consultants and other representatives and personnel of Owner, independent testing laboratories, and authorities having jurisdiction will have access to the Site and the Work at reasonable times for their observation, inspection, and testing. Contractor shall provide them proper and safe conditions for such access and advise them of Contractor's safety procedures and programs so that they may comply therewith as applicable.

14.02 *Tests, Inspections, and Approvals*

- A. Contractor shall give Engineer timely notice of readiness of the Work (or specific parts thereof) for all required inspections and tests, and shall cooperate with inspection and testing personnel to facilitate required inspections and tests.
- B. Owner shall retain and pay for the services of an independent inspector, testing laboratory, or other qualified individual or entity to perform all inspections and tests expressly required by the Contract Documents to be furnished and paid for by Owner, except that costs incurred in connection with tests or inspections of covered Work shall be governed by the provisions of Paragraph 14.05.
- C. If Laws or Regulations of any public body having jurisdiction require any Work (or part thereof) specifically to be inspected, tested, or approved by an employee or other representative of such public body, Contractor shall assume full responsibility for arranging and obtaining such inspections, tests, or approvals, pay all costs in connection therewith, and furnish Engineer the required certificates of inspection or approval.
- D. Contractor shall be responsible for arranging, obtaining, and paying for all inspections and tests required:
 - 1. by the Contract Documents, unless the Contract Documents expressly allocate responsibility for a specific inspection or test to Owner;
 - 2. to attain Owner's and Engineer's acceptance of materials or equipment to be incorporated in the Work;
 - 3. by manufacturers of equipment furnished under the Contract Documents;
 - 4. for testing, adjusting, and balancing of mechanical, electrical, and other equipment to be incorporated into the Work; and
 - 5. for acceptance of materials, mix designs, or equipment submitted for approval prior to Contractor's purchase thereof for incorporation in the Work.

Such inspections and tests shall be performed by independent inspectors, testing laboratories, or other qualified individuals or entities acceptable to Owner and Engineer.

- E. If the Contract Documents require the Work (or part thereof) to be approved by Owner, Engineer, or another designated individual or entity, then Contractor shall assume full responsibility for arranging and obtaining such approvals.
- F. If any Work (or the work of others) that is to be inspected, tested, or approved is covered by Contractor without written concurrence of Engineer, Contractor shall, if requested by Engineer, uncover such Work for observation. Such uncovering shall be at Contractor's expense unless Contractor had given Engineer timely notice of Contractor's intention to

cover the same and Engineer had not acted with reasonable promptness in response to such notice.

14.03 *Defective Work*

- A. *Contractor's Obligation:* It is Contractor's obligation to assure that the Work is not defective.
- B. *Engineer's Authority:* Engineer has the authority to determine whether Work is defective, and to reject defective Work.
- C. *Notice of Defects:* Prompt notice of all defective Work of which Owner or Engineer has actual knowledge will be given to Contractor.
- D. *Correction, or Removal and Replacement:* Promptly after receipt of written notice of defective Work, Contractor shall correct all such defective Work, whether or not fabricated, installed, or completed, or, if Engineer has rejected the defective Work, remove it from the Project and replace it with Work that is not defective.
- E. *Preservation of Warranties:* When correcting defective Work, Contractor shall take no action that would void or otherwise impair Owner's special warranty and guarantee, if any, on said Work.
- F. *Costs and Damages:* In addition to its correction, removal, and replacement obligations with respect to defective Work, Contractor shall pay all claims, costs, losses, and damages arising out of or relating to defective Work, including but not limited to the cost of the inspection, testing, correction, removal, replacement, or reconstruction of such defective Work, fines levied against Owner by governmental authorities because the Work is defective, and the costs of repair or replacement of work of others resulting from defective Work. Prior to final payment, if Owner and Contractor are unable to agree as to the measure of such claims, costs, losses, and damages resulting from defective Work, then Owner may impose a reasonable set-off against payments due under Article 15.

14.04 *Acceptance of Defective Work*

- A. If, instead of requiring correction or removal and replacement of defective Work, Owner prefers to accept it, Owner may do so (subject, if such acceptance occurs prior to final payment, to Engineer's confirmation that such acceptance is in general accord with the design intent and applicable engineering principles, and will not endanger public safety). Contractor shall pay all claims, costs, losses, and damages attributable to Owner's evaluation of and determination to accept such defective Work (such costs to be approved by Engineer as to reasonableness), and for the diminished value of the Work to the extent not otherwise paid by Contractor. If any such acceptance occurs prior to final payment, the necessary revisions in the Contract Documents with respect to the Work shall be incorporated in a Change Order. If the parties are unable to agree as to the decrease in the Contract Price, reflecting the diminished value of Work so accepted, then Owner may impose a reasonable set-off against payments due under Article 15. If the acceptance of defective Work occurs after final payment, Contractor shall pay an appropriate amount to Owner.

14.05 *Uncovering Work*

- A. Engineer has the authority to require special inspection or testing of the Work, whether or not the Work is fabricated, installed, or completed.

- B. If any Work is covered contrary to the written request of Engineer, then Contractor shall, if requested by Engineer, uncover such Work for Engineer's observation, and then replace the covering, all at Contractor's expense.
- C. If Engineer considers it necessary or advisable that covered Work be observed by Engineer or inspected or tested by others, then Contractor, at Engineer's request, shall uncover, expose, or otherwise make available for observation, inspection, or testing as Engineer may require, that portion of the Work in question, and provide all necessary labor, material, and equipment.
 - 1. If it is found that the uncovered Work is defective, Contractor shall be responsible for all claims, costs, losses, and damages arising out of or relating to such uncovering, exposure, observation, inspection, and testing, and of satisfactory replacement or reconstruction (including but not limited to all costs of repair or replacement of work of others); and pending Contractor's full discharge of this responsibility the Owner shall be entitled to impose a reasonable set-off against payments due under Article 15.
 - 2. If the uncovered Work is not found to be defective, Contractor shall be allowed an increase in the Contract Price or an extension of the Contract Times, or both, directly attributable to such uncovering, exposure, observation, inspection, testing, replacement, and reconstruction. If the parties are unable to agree as to the amount or extent thereof, then Contractor may submit a Change Proposal within 30 days of the determination that the Work is not defective.

14.06 *Owner May Stop the Work*

- A. If the Work is defective, or Contractor fails to supply sufficient skilled workers or suitable materials or equipment, or fails to perform the Work in such a way that the completed Work will conform to the Contract Documents, then Owner may order Contractor to stop the Work, or any portion thereof, until the cause for such order has been eliminated; however, this right of Owner to stop the Work shall not give rise to any duty on the part of Owner to exercise this right for the benefit of Contractor, any Subcontractor, any Supplier, any other individual or entity, or any surety for, or employee or agent of any of them.

14.07 *Owner May Correct Defective Work*

- A. If Contractor fails within a reasonable time after written notice from Engineer to correct defective Work, or to remove and replace rejected Work as required by Engineer, or if Contractor fails to perform the Work in accordance with the Contract Documents, or if Contractor fails to comply with any other provision of the Contract Documents, then Owner may, after seven days written notice to Contractor, correct or remedy any such deficiency.
- B. In exercising the rights and remedies under this Paragraph 14.07, Owner shall proceed expeditiously. In connection with such corrective or remedial action, Owner may exclude Contractor from all or part of the Site, take possession of all or part of the Work and suspend Contractor's services related thereto, and incorporate in the Work all materials and equipment stored at the Site or for which Owner has paid Contractor but which are stored elsewhere. Contractor shall allow Owner, Owner's representatives, agents and employees, Owner's other contractors, and Engineer and Engineer's consultants access to the Site to enable Owner to exercise the rights and remedies under this paragraph.
- C. All claims, costs, losses, and damages incurred or sustained by Owner in exercising the rights and remedies under this Paragraph 14.07 will be charged against Contractor as set-offs against payments due under Article 15. Such claims, costs, losses and damages will

include but not be limited to all costs of repair, or replacement of work of others destroyed or damaged by correction, removal, or replacement of Contractor's defective Work.

- D. Contractor shall not be allowed an extension of the Contract Times because of any delay in the performance of the Work attributable to the exercise by Owner of Owner's rights and remedies under this Paragraph 14.07.

ARTICLE 15 – PAYMENTS TO CONTRACTOR; SET-OFFS; COMPLETION; CORRECTION PERIOD

15.01 Progress Payments

- A. *Basis for Progress Payments:* The Schedule of Values established as provided in Article 2 will serve as the basis for progress payments and will be incorporated into a form of Application for Payment acceptable to Engineer. Progress payments on account of Unit Price Work will be based on the number of units completed during the pay period, as determined under the provisions of Paragraph 13.03. Progress payments for cost-based Work will be based on Cost of the Work completed by Contractor during the pay period.
- B. *Applications for Payments:*
1. At least 20 days before the date established in the Agreement for each progress payment (but not more often than once a month), Contractor shall submit to Engineer for review an Application for Payment filled out and signed by Contractor covering the Work completed as of the date of the Application and accompanied by such supporting documentation as is required by the Contract Documents. If payment is requested on the basis of materials and equipment not incorporated in the Work but delivered and suitably stored at the Site or at another location agreed to in writing, the Application for Payment shall also be accompanied by a bill of sale, invoice, or other documentation warranting that Owner has received the materials and equipment free and clear of all Liens, and evidence that the materials and equipment are covered by appropriate property insurance, a warehouse bond, or other arrangements to protect Owner's interest therein, all of which must be satisfactory to Owner.
 2. Beginning with the second Application for Payment, each Application shall include an affidavit of Contractor stating that all previous progress payments received on account of the Work have been applied on account to discharge Contractor's legitimate obligations associated with prior Applications for Payment.
 3. The amount of retainage with respect to progress payments will be as stipulated in the Agreement.
- C. *Review of Applications:*
1. Engineer will, within 10 days after receipt of each Application for Payment, including each resubmittal, either indicate in writing a recommendation of payment and present the Application to Owner, or return the Application to Contractor indicating in writing Engineer's reasons for refusing to recommend payment. In the latter case, Contractor may make the necessary corrections and resubmit the Application.
 2. Engineer's recommendation of any payment requested in an Application for Payment will constitute a representation by Engineer to Owner, based on Engineer's observations of the executed Work as an experienced and qualified design professional, and on Engineer's review of the Application for Payment and the accompanying data and schedules, that to the best of Engineer's knowledge, information and belief:

- a. the Work has progressed to the point indicated;
 - b. the quality of the Work is generally in accordance with the Contract Documents (subject to an evaluation of the Work as a functioning whole prior to or upon Substantial Completion, the results of any subsequent tests called for in the Contract Documents, a final determination of quantities and classifications for Unit Price Work under Paragraph 13.03, and any other qualifications stated in the recommendation); and
 - c. the conditions precedent to Contractor's being entitled to such payment appear to have been fulfilled in so far as it is Engineer's responsibility to observe the Work.
3. By recommending any such payment Engineer will not thereby be deemed to have represented that:
- a. inspections made to check the quality or the quantity of the Work as it has been performed have been exhaustive, extended to every aspect of the Work in progress, or involved detailed inspections of the Work beyond the responsibilities specifically assigned to Engineer in the Contract; or
 - b. there may not be other matters or issues between the parties that might entitle Contractor to be paid additionally by Owner or entitle Owner to withhold payment to Contractor.
4. Neither Engineer's review of Contractor's Work for the purposes of recommending payments nor Engineer's recommendation of any payment, including final payment, will impose responsibility on Engineer:
- a. to supervise, direct, or control the Work, or
 - b. for the means, methods, techniques, sequences, or procedures of construction, or the safety precautions and programs incident thereto, or
 - c. for Contractor's failure to comply with Laws and Regulations applicable to Contractor's performance of the Work, or
 - d. to make any examination to ascertain how or for what purposes Contractor has used the money paid on account of the Contract Price, or
 - e. to determine that title to any of the Work, materials, or equipment has passed to Owner free and clear of any Liens.
5. Engineer may refuse to recommend the whole or any part of any payment if, in Engineer's opinion, it would be incorrect to make the representations to Owner stated in Paragraph 15.01.C.2.
6. Engineer will recommend reductions in payment (set-offs) necessary in Engineer's opinion to protect Owner from loss because:
- a. the Work is defective, requiring correction or replacement;
 - b. the Contract Price has been reduced by Change Orders;
 - c. Owner has been required to correct defective Work in accordance with Paragraph 14.07, or has accepted defective Work pursuant to Paragraph 14.04;
 - d. Owner has been required to remove or remediate a Hazardous Environmental Condition for which Contractor is responsible; or

- e. Engineer has actual knowledge of the occurrence of any of the events that would constitute a default by Contractor and therefore justify termination for cause under the Contract Documents.

D. *Payment Becomes Due:*

- 1. Ten days after presentation of the Application for Payment to Owner with Engineer's recommendation, the amount recommended (subject to any Owner set-offs) will become due, and when due will be paid by Owner to Contractor.

E. *Reductions in Payment by Owner:*

- 1. In addition to any reductions in payment (set-offs) recommended by Engineer, Owner is entitled to impose a set-off against payment based on any of the following:
 - a. claims have been made against Owner on account of Contractor's conduct in the performance or furnishing of the Work, or Owner has incurred costs, losses, or damages on account of Contractor's conduct in the performance or furnishing of the Work, including but not limited to claims, costs, losses, or damages from workplace injuries, adjacent property damage, non-compliance with Laws and Regulations, and patent infringement;
 - b. Contractor has failed to take reasonable and customary measures to avoid damage, delay, disruption, and interference with other work at or adjacent to the Site;
 - c. Contractor has failed to provide and maintain required bonds or insurance;
 - d. Owner has been required to remove or remediate a Hazardous Environmental Condition for which Contractor is responsible;
 - e. Owner has incurred extra charges or engineering costs related to submittal reviews, evaluations of proposed substitutes, tests and inspections, or return visits to manufacturing or assembly facilities;
 - f. the Work is defective, requiring correction or replacement;
 - g. Owner has been required to correct defective Work in accordance with Paragraph 14.07, or has accepted defective Work pursuant to Paragraph 14.04;
 - h. the Contract Price has been reduced by Change Orders;
 - i. an event that would constitute a default by Contractor and therefore justify a termination for cause has occurred;
 - j. liquidated damages have accrued as a result of Contractor's failure to achieve Milestones, Substantial Completion, or final completion of the Work;
 - k. Liens have been filed in connection with the Work, except where Contractor has delivered a specific bond satisfactory to Owner to secure the satisfaction and discharge of such Liens;
 - l. there are other items entitling Owner to a set off against the amount recommended.
- 2. If Owner imposes any set-off against payment, whether based on its own knowledge or on the written recommendations of Engineer, Owner will give Contractor immediate written notice (with a copy to Engineer) stating the reasons for such action and the specific amount of the reduction, and promptly pay Contractor any amount

remaining after deduction of the amount so withheld. Owner shall promptly pay Contractor the amount so withheld, or any adjustment thereto agreed to by Owner and Contractor, if Contractor remedies the reasons for such action. The reduction imposed shall be binding on Contractor unless it duly submits a Change Proposal contesting the reduction.

3. Upon a subsequent determination that Owner's refusal of payment was not justified, the amount wrongfully withheld shall be treated as an amount due as determined by Paragraph 15.01.C.1 and subject to interest as provided in the Agreement.

15.02 *Contractor's Warranty of Title*

- A. Contractor warrants and guarantees that title to all Work, materials, and equipment furnished under the Contract will pass to Owner free and clear of (1) all Liens and other title defects, and (2) all patent, licensing, copyright, or royalty obligations, no later than seven days after the time of payment by Owner.

15.03 *Substantial Completion*

- A. When Contractor considers the entire Work ready for its intended use Contractor shall notify Owner and Engineer in writing that the entire Work is substantially complete and request that Engineer issue a certificate of Substantial Completion. Contractor shall at the same time submit to Owner and Engineer an initial draft of punch list items to be completed or corrected before final payment.
- B. Promptly after Contractor's notification, Owner, Contractor, and Engineer shall make an inspection of the Work to determine the status of completion. If Engineer does not consider the Work substantially complete, Engineer will notify Contractor in writing giving the reasons therefor.
- C. If Engineer considers the Work substantially complete, Engineer will deliver to Owner a preliminary certificate of Substantial Completion which shall fix the date of Substantial Completion. Engineer shall attach to the certificate a punch list of items to be completed or corrected before final payment. Owner shall have seven days after receipt of the preliminary certificate during which to make written objection to Engineer as to any provisions of the certificate or attached punch list. If, after considering the objections to the provisions of the preliminary certificate, Engineer concludes that the Work is not substantially complete, Engineer will, within 14 days after submission of the preliminary certificate to Owner, notify Contractor in writing that the Work is not substantially complete, stating the reasons therefor. If Owner does not object to the provisions of the certificate, or if despite consideration of Owner's objections Engineer concludes that the Work is substantially complete, then Engineer will, within said 14 days, execute and deliver to Owner and Contractor a final certificate of Substantial Completion (with a revised punch list of items to be completed or corrected) reflecting such changes from the preliminary certificate as Engineer believes justified after consideration of any objections from Owner.
- D. At the time of receipt of the preliminary certificate of Substantial Completion, Owner and Contractor will confer regarding Owner's use or occupancy of the Work following Substantial Completion, review the builder's risk insurance policy with respect to the end of the builder's risk coverage, and confirm the transition to coverage of the Work under a permanent property insurance policy held by Owner. Unless Owner and Contractor agree otherwise in writing, Owner shall bear responsibility for security, operation, protection of the Work, property insurance, maintenance, heat, and utilities upon Owner's use or occupancy of the Work.

- E. After Substantial Completion the Contractor shall promptly begin work on the punch list of items to be completed or corrected prior to final payment. In appropriate cases Contractor may submit monthly Applications for Payment for completed punch list items, following the progress payment procedures set forth above.
- F. Owner shall have the right to exclude Contractor from the Site after the date of Substantial Completion subject to allowing Contractor reasonable access to remove its property and complete or correct items on the punch list.

15.04 *Partial Use or Occupancy*

- A. Prior to Substantial Completion of all the Work, Owner may use or occupy any substantially completed part of the Work which has specifically been identified in the Contract Documents, or which Owner, Engineer, and Contractor agree constitutes a separately functioning and usable part of the Work that can be used by Owner for its intended purpose without significant interference with Contractor's performance of the remainder of the Work, subject to the following conditions:
 - 1. At any time Owner may request in writing that Contractor permit Owner to use or occupy any such part of the Work that Owner believes to be substantially complete. If and when Contractor agrees that such part of the Work is substantially complete, Contractor, Owner, and Engineer will follow the procedures of Paragraph 15.03.A through E for that part of the Work.
 - 2. At any time Contractor may notify Owner and Engineer in writing that Contractor considers any such part of the Work substantially complete and request Engineer to issue a certificate of Substantial Completion for that part of the Work.
 - 3. Within a reasonable time after either such request, Owner, Contractor, and Engineer shall make an inspection of that part of the Work to determine its status of completion. If Engineer does not consider that part of the Work to be substantially complete, Engineer will notify Owner and Contractor in writing giving the reasons therefor. If Engineer considers that part of the Work to be substantially complete, the provisions of Paragraph 15.03 will apply with respect to certification of Substantial Completion of that part of the Work and the division of responsibility in respect thereof and access thereto.
 - 4. No use or occupancy or separate operation of part of the Work may occur prior to compliance with the requirements of Paragraph 6.05 regarding builder's risk or other property insurance.

15.05 *Final Inspection*

- A. Upon written notice from Contractor that the entire Work or an agreed portion thereof is complete, Engineer will promptly make a final inspection with Owner and Contractor and will notify Contractor in writing of all particulars in which this inspection reveals that the Work, or agreed portion thereof, is incomplete or defective. Contractor shall immediately take such measures as are necessary to complete such Work or remedy such deficiencies.

15.06 *Final Payment*

- A. *Application for Payment:*
 - 1. After Contractor has, in the opinion of Engineer, satisfactorily completed all corrections identified during the final inspection and has delivered, in accordance with the Contract Documents, all maintenance and operating instructions, schedules, guarantees, bonds, certificates or other evidence of insurance, certificates of

inspection, annotated record documents (as provided in Paragraph 7.11), and other documents, Contractor may make application for final payment.

2. The final Application for Payment shall be accompanied (except as previously delivered) by:
 - a. all documentation called for in the Contract Documents;
 - b. consent of the surety, if any, to final payment;
 - c. satisfactory evidence that all title issues have been resolved such that title to all Work, materials, and equipment has passed to Owner free and clear of any Liens or other title defects, or will so pass upon final payment.
 - d. a list of all disputes that Contractor believes are unsettled; and
 - e. complete and legally effective releases or waivers (satisfactory to Owner) of all Lien rights arising out of the Work, and of Liens filed in connection with the Work.
3. In lieu of the releases or waivers of Liens specified in Paragraph 15.06.A.2 and as approved by Owner, Contractor may furnish receipts or releases in full and an affidavit of Contractor that: (a) the releases and receipts include all labor, services, material, and equipment for which a Lien could be filed; and (b) all payrolls, material and equipment bills, and other indebtedness connected with the Work for which Owner might in any way be responsible, or which might in any way result in liens or other burdens on Owner's property, have been paid or otherwise satisfied. If any Subcontractor or Supplier fails to furnish such a release or receipt in full, Contractor may furnish a bond or other collateral satisfactory to Owner to indemnify Owner against any Lien, or Owner at its option may issue joint checks payable to Contractor and specified Subcontractors and Suppliers.

B. *Engineer's Review of Application and Acceptance:*

1. If, on the basis of Engineer's observation of the Work during construction and final inspection, and Engineer's review of the final Application for Payment and accompanying documentation as required by the Contract Documents, Engineer is satisfied that the Work has been completed and Contractor's other obligations under the Contract have been fulfilled, Engineer will, within ten days after receipt of the final Application for Payment, indicate in writing Engineer's recommendation of final payment and present the Application for Payment to Owner for payment. Such recommendation shall account for any set-offs against payment that are necessary in Engineer's opinion to protect Owner from loss for the reasons stated above with respect to progress payments. At the same time Engineer will also give written notice to Owner and Contractor that the Work is acceptable, subject to the provisions of Paragraph 15.07. Otherwise, Engineer will return the Application for Payment to Contractor, indicating in writing the reasons for refusing to recommend final payment, in which case Contractor shall make the necessary corrections and resubmit the Application for Payment.

C. *Completion of Work:* The Work is complete (subject to surviving obligations) when it is ready for final payment as established by the Engineer's written recommendation of final payment.

D. *Payment Becomes Due:* Thirty days after the presentation to Owner of the final Application for Payment and accompanying documentation, the amount recommended by Engineer (less any further sum Owner is entitled to set off against Engineer's recommendation,

including but not limited to set-offs for liquidated damages and set-offs allowed under the provisions above with respect to progress payments) will become due and shall be paid by Owner to Contractor.

15.07 *Waiver of Claims*

- A. The making of final payment will not constitute a waiver by Owner of claims or rights against Contractor. Owner expressly reserves claims and rights arising from unsettled Liens, from defective Work appearing after final inspection pursuant to Paragraph 15.05, from Contractor's failure to comply with the Contract Documents or the terms of any special guarantees specified therein, from outstanding Claims by Owner, or from Contractor's continuing obligations under the Contract Documents.
- B. The acceptance of final payment by Contractor will constitute a waiver by Contractor of all claims and rights against Owner other than those pending matters that have been duly submitted or appealed under the provisions of Article 17.

15.08 *Correction Period*

- A. If within one year after the date of Substantial Completion (or such longer period of time as may be prescribed by the terms of any applicable special guarantee required by the Contract Documents, or by any specific provision of the Contract Documents), any Work is found to be defective, or if the repair of any damages to the Site, adjacent areas that Contractor has arranged to use through construction easements or otherwise, and other adjacent areas used by Contractor as permitted by Laws and Regulations, is found to be defective, then Contractor shall promptly, without cost to Owner and in accordance with Owner's written instructions:
 - 1. correct the defective repairs to the Site or such other adjacent areas;
 - 2. correct such defective Work;
 - 3. if the defective Work has been rejected by Owner, remove it from the Project and replace it with Work that is not defective, and
 - 4. satisfactorily correct or repair or remove and replace any damage to other Work, to the work of others, or to other land or areas resulting therefrom.
- B. If Contractor does not promptly comply with the terms of Owner's written instructions, or in an emergency where delay would cause serious risk of loss or damage, Owner may have the defective Work corrected or repaired or may have the rejected Work removed and replaced. Contractor shall pay all claims, costs, losses, and damages (including but not limited to all fees and charges of engineers, architects, attorneys, and other professionals and all court or arbitration or other dispute resolution costs) arising out of or relating to such correction or repair or such removal and replacement (including but not limited to all costs of repair or replacement of work of others).
- C. In special circumstances where a particular item of equipment is placed in continuous service before Substantial Completion of all the Work, the correction period for that item may start to run from an earlier date if so provided in the Specifications.
- D. Where defective Work (and damage to other Work resulting therefrom) has been corrected or removed and replaced under this paragraph, the correction period hereunder with respect to such Work will be extended for an additional period of one year after such correction or removal and replacement has been satisfactorily completed.

- E. Contractor's obligations under this paragraph are in addition to all other obligations and warranties. The provisions of this paragraph shall not be construed as a substitute for, or a waiver of, the provisions of any applicable statute of limitation or repose.

ARTICLE 16 – SUSPENSION OF WORK AND TERMINATION

16.01 *Owner May Suspend Work*

- A. At any time and without cause, Owner may suspend the Work or any portion thereof for a period of not more than 90 consecutive days by written notice to Contractor and Engineer. Such notice will fix the date on which Work will be resumed. Contractor shall resume the Work on the date so fixed. Contractor shall be entitled to an adjustment in the Contract Price or an extension of the Contract Times, or both, directly attributable to any such suspension. Any Change Proposal seeking such adjustments shall be submitted no later than 30 days after the date fixed for resumption of Work.

16.02 *Owner May Terminate for Cause*

- A. The occurrence of any one or more of the following events will constitute a default by Contractor and justify termination for cause:
 - 1. Contractor's persistent failure to perform the Work in accordance with the Contract Documents (including, but not limited to, failure to supply sufficient skilled workers or suitable materials or equipment or failure to adhere to the Progress Schedule);
 - 2. Failure of Contractor to perform or otherwise to comply with a material term of the Contract Documents;
 - 3. Contractor's disregard of Laws or Regulations of any public body having jurisdiction; or
 - 4. Contractor's repeated disregard of the authority of Owner or Engineer.
- B. If one or more of the events identified in Paragraph 16.02.A occurs, then after giving Contractor (and any surety) ten days written notice that Owner is considering a declaration that Contractor is in default and termination of the contract, Owner may proceed to:
 - 1. declare Contractor to be in default, and give Contractor (and any surety) notice that the Contract is terminated; and
 - 2. enforce the rights available to Owner under any applicable performance bond.
- C. Subject to the terms and operation of any applicable performance bond, if Owner has terminated the Contract for cause, Owner may exclude Contractor from the Site, take possession of the Work, incorporate in the Work all materials and equipment stored at the Site or for which Owner has paid Contractor but which are stored elsewhere, and complete the Work as Owner may deem expedient.
- D. Owner may not proceed with termination of the Contract under Paragraph 16.02.B if Contractor within seven days of receipt of notice of intent to terminate begins to correct its failure to perform and proceeds diligently to cure such failure.
- E. If Owner proceeds as provided in Paragraph 16.02.B, Contractor shall not be entitled to receive any further payment until the Work is completed. If the unpaid balance of the Contract Price exceeds the cost to complete the Work, including all related claims, costs, losses, and damages (including but not limited to all fees and charges of engineers, architects, attorneys, and other professionals) sustained by Owner, such excess will be paid to Contractor. If the cost to complete the Work including such related claims, costs, losses,

and damages exceeds such unpaid balance, Contractor shall pay the difference to Owner. Such claims, costs, losses, and damages incurred by Owner will be reviewed by Engineer as to their reasonableness and, when so approved by Engineer, incorporated in a Change Order. When exercising any rights or remedies under this paragraph, Owner shall not be required to obtain the lowest price for the Work performed.

- F. Where Contractor's services have been so terminated by Owner, the termination will not affect any rights or remedies of Owner against Contractor then existing or which may thereafter accrue, or any rights or remedies of Owner against Contractor or any surety under any payment bond or performance bond. Any retention or payment of money due Contractor by Owner will not release Contractor from liability.
- G. If and to the extent that Contractor has provided a performance bond under the provisions of Paragraph 6.01.A, the provisions of that bond shall govern over any inconsistent provisions of Paragraphs 16.02.B and 16.02.D.

16.03 *Owner May Terminate For Convenience*

- A. Upon seven days written notice to Contractor and Engineer, Owner may, without cause and without prejudice to any other right or remedy of Owner, terminate the Contract. In such case, Contractor shall be paid for (without duplication of any items):
 - 1. completed and acceptable Work executed in accordance with the Contract Documents prior to the effective date of termination, including fair and reasonable sums for overhead and profit on such Work;
 - 2. expenses sustained prior to the effective date of termination in performing services and furnishing labor, materials, or equipment as required by the Contract Documents in connection with uncompleted Work, plus fair and reasonable sums for overhead and profit on such expenses; and
 - 3. other reasonable expenses directly attributable to termination, including costs incurred to prepare a termination for convenience cost proposal.
- B. Contractor shall not be paid on account of loss of anticipated overhead, profits, or revenue, or other economic loss arising out of or resulting from such termination.

16.04 *Contractor May Stop Work or Terminate*

- A. If, through no act or fault of Contractor, (1) the Work is suspended for more than 90 consecutive days by Owner or under an order of court or other public authority, or (2) Engineer fails to act on any Application for Payment within 30 days after it is submitted, or (3) Owner fails for 30 days to pay Contractor any sum finally determined to be due, then Contractor may, upon seven days written notice to Owner and Engineer, and provided Owner or Engineer do not remedy such suspension or failure within that time, terminate the contract and recover from Owner payment on the same terms as provided in Paragraph 16.03.
- B. In lieu of terminating the Contract and without prejudice to any other right or remedy, if Engineer has failed to act on an Application for Payment within 30 days after it is submitted, or Owner has failed for 30 days to pay Contractor any sum finally determined to be due, Contractor may, seven days after written notice to Owner and Engineer, stop the Work until payment is made of all such amounts due Contractor, including interest thereon. The provisions of this paragraph are not intended to preclude Contractor from submitting a Change Proposal for an adjustment in Contract Price or Contract Times or otherwise for

expenses or damage directly attributable to Contractor's stopping the Work as permitted by this paragraph.

ARTICLE 17 – FINAL RESOLUTION OF DISPUTES

17.01 *Methods and Procedures*

- A. *Disputes Subject to Final Resolution:* The following disputed matters are subject to final resolution under the provisions of this Article:
 - 1. A timely appeal of an approval in part and denial in part of a Claim, or of a denial in full; and
 - 2. Disputes between Owner and Contractor concerning the Work or obligations under the Contract Documents, and arising after final payment has been made.
- B. *Final Resolution of Disputes:* For any dispute subject to resolution under this Article, Owner or Contractor may:
 - 1. elect in writing to invoke the dispute resolution process provided for in the Supplementary Conditions; or
 - 2. agree with the other party to submit the dispute to another dispute resolution process; or
 - 3. if no dispute resolution process is provided for in the Supplementary Conditions or mutually agreed to, give written notice to the other party of the intent to submit the dispute to a court of competent jurisdiction.

ARTICLE 18 – MISCELLANEOUS

18.01 *Giving Notice*

- A. Whenever any provision of the Contract Documents requires the giving of written notice, it will be deemed to have been validly given if:
 - 1. delivered in person, by a commercial courier service or otherwise, to the individual or to a member of the firm or to an officer of the corporation for which it is intended; or
 - 2. delivered at or sent by registered or certified mail, postage prepaid, to the last business address known to the sender of the notice.

18.02 *Computation of Times*

- A. When any period of time is referred to in the Contract by days, it will be computed to exclude the first and include the last day of such period. If the last day of any such period falls on a Saturday or Sunday or on a day made a legal holiday by the law of the applicable jurisdiction, such day will be omitted from the computation.

18.03 *Cumulative Remedies*

- A. The duties and obligations imposed by these General Conditions and the rights and remedies available hereunder to the parties hereto are in addition to, and are not to be construed in any way as a limitation of, any rights and remedies available to any or all of them which are otherwise imposed or available by Laws or Regulations, by special warranty or guarantee, or by other provisions of the Contract. The provisions of this paragraph will be as effective as if repeated specifically in the Contract Documents in connection with each particular duty, obligation, right, and remedy to which they apply.

18.04 *Limitation of Damages*

- A. With respect to any and all Change Proposals, Claims, disputes subject to final resolution, and other matters at issue, neither Owner nor Engineer, nor any of their officers, directors, members, partners, employees, agents, consultants, or subcontractors, shall be liable to Contractor for any claims, costs, losses, or damages sustained by Contractor on or in connection with any other project or anticipated project.

18.05 *No Waiver*

- A. A party's non-enforcement of any provision shall not constitute a waiver of that provision, nor shall it affect the enforceability of that provision or of the remainder of this Contract.

18.06 *Survival of Obligations*

- A. All representations, indemnifications, warranties, and guarantees made in, required by, or given in accordance with the Contract, as well as all continuing obligations indicated in the Contract, will survive final payment, completion, and acceptance of the Work or termination or completion of the Contract or termination of the services of Contractor.

18.07 *Controlling Law*

- A. This Contract is to be governed by the law of the state in which the Project is located.

18.08 *Headings*

- A. Article and paragraph headings are inserted for convenience only and do not constitute parts of these General Conditions.

SECTION 00800
SUPPLEMENTARY CONDITIONS
ITB 17-039

These Supplementary Conditions amend or supplement the Standard General Conditions of the Construction Contract, EJCDC C-700 (2013 Edition) and other provisions of the Contract Documents as indicated below. All references in these Supplementary Conditions to the Standard General Conditions are to the Standard General Conditions of the Construction Contract, EJCDC C-700 (2013 Edition). All provisions which are not so amended or supplemented remain in full force and effect.

The terms used in these Supplementary Conditions will have the meanings stated in those Standard General Conditions. Additional terms used in these Supplementary Conditions have the meanings indicated below, which are applicable to both the singular and plural thereof.

The address system used in these Supplementary Conditions is the same as the address system used in the Standard General Conditions of the Construction Contract EJCDC C-700 (2013 Edition), with the prefix “SC” added thereto.

SC-1.01 *Defined Terms*

Delete the definition of the term Liens in Paragraph 1.01.A.24. and insert in its place the following:

24. *Liens* – Charges, security, interests, or encumbrances upon Contract – related funds, real property, or personal property and claims delivered to Owner by laborers, Subcontractors, and Suppliers who have not been paid by Contractor.

SC-2.01 *Delivery of Bonds and Evidence of Insurance*

Delete Paragraph 2.01.A. in its entirety and insert the following in its place:

- A. When Contractor delivers the executed counterparts of the Agreement to Owner, Contractor shall also deliver to Owner unexecuted copies of the bonds and related powers of attorney that Contractor will be required to furnish. Within 10 days after execution of the Agreement by Owner, Contractor shall deliver to Owner fully executed bonds, accompanied by a certified copy of the signing individual’s authority to bind the surety establishing that it is effective on the date the agent or attorney-in-fact signed the accompanying bond, as provided in Paragraph 5.06.B. of the Standard General Conditions.

SC-2.02 *Copies of Documents*

Delete Paragraph 2.02.A. in its entirety and insert the following in its place:

- A. Owner shall furnish Contractor with 1 printed copy of the fully executed Contract Documents. Additional copies will be furnished upon request at the cost of reproduction.

SC-2.04 *Preconstruction Conference; Designation of Authorized Representatives*

Add the following to the end of Paragraph 2.04.A.:

Contractor shall be ready, willing, and able to attend this conference within 10 calendar days after the date of the notice to proceed. The date, time, and place of this conference will be set by Engineer.

SC-4.01 *Commencement of Contract Times; Notice to Proceed*

Delete Paragraph 4.01.A. in its entirety and insert the following in its place:

- A. The Contract Times will commence to run on the day indicated in a Notice to Proceed.

SC-4.02 *Starting the Work*

Add the following new Paragraph to Paragraph 4.02:

- B. Contractor, before beginning the Work or within 2 workdays thereafter, shall post in a conspicuous place on the Site the following notice.

Notice is hereby made to all those concerned and affected that _____ is performing the “
MARTIN LUTHER KING JR. BOULEVARD SIDEWALK EXTENSION; PROJECT NO. 15005”. All parties furnishing labor and/or materials to that project must, within twenty (20) days of first providing such labor and/or materials, deliver notice of such in writing, by certified mail, return receipt requested, to:

HIGHLANDS COUNTY BOARD OF COUNTY COMMISSIONERS
ATTN.: CLINTON HOWERTON, JR., P.E.
6850 GEORGE BLVD., SEBRING, FLORIDA 33875

SC-5.01 *Availability of Lands*

Delete the following from Paragraph 5.01.B.:

as necessary for giving notice of or filing a mechanic’s or construction Lien against such lands in accordance with applicable Laws and Regulations

SC-5.02 *Use of Site and Other Areas*

Add the following new paragraph to Paragraph 5.02:

- E. Contractor shall at all times control dust and keep the Site free from accumulation of waste materials or rubbish caused by Contractor’s employees or subcontractors, and at the completion of the Work, Contractor shall remove all Contractor’s rubbish from

and about the Site and all Contractor's tools and surplus materials and shall leave Contractor's Site and any other Work area clean. Owner may remove the rubbish and charge the cost to Contractor as the Engineer may determine to be just. In the event that Contractor does not keep the Site and any other Work area free of rubbish or accumulations of waste materials and control dust, Owner will withhold an additional 5% from any pay request, above and beyond the standard 10% retainage.

SC-5.03 *Subsurface and Physical Conditions*

Add the following new paragraphs immediately after Paragraph 5.03.B:

- C. *Subsurface Conditions Known to Owner:* The subsurface conditions at or contiguous to the Site known to Owner are shown on the Drawings and Specifications that are Exhibit "A" of the Contract Documents. Contractor is not entitled to rely upon any other information and data known to or identified by Owner or Engineer.
- D. *Unforeseen Physical Conditions:* Contractor shall notify Engineer in writing of any subsurface or latent physical condition at the Site differing materially from those indicated in the Contract Documents. Engineer shall promptly investigate those conditions and advise Owner in writing if additional information shall be required. Owner shall then obtain such information, and if deemed necessary, shall issue written orders to perform necessary revisions.

SC 5.05 *Underground Facilities*

Add the following new Paragraph to Paragraph 5.05:

- F. *Protection of Underground Facilities.*
 - 1. Existing utilities and other facilities such as drainage structures have been indicated on the Drawings and Specifications only to the extent that such information was made available to Owner. There is no guarantee as to the accuracy or completeness of this information, and Owner will not be responsible for such accuracy or completeness.
 - 2. Contractor shall be responsible for protecting all such utilities indicated in the manner determined necessary by the owner of such utilities. Any utilities not indicated on the Drawings and Specifications, which do not require relocation, shall be protected by Contractor. The Work shall be performed at the original Contract Price. All visible surface facilities or underground utilities shown on the Drawings and Specifications, whether or not shown to be relocated, shall be protected or relocated by Contractor at its expense.
 - 3. Utility relocations are not anticipated for this Project. However, existing utilities which are found during construction and determined necessary to be relocated will be considered an unknown condition. Contractor will cooperate with the appropriate authority in identifying and protecting the utility during relocation.

4. Abandoned utilities, when encountered, shall be severed and plugged at Contractor's expense.
5. Contractor shall be responsible for discovery of existing underground installations, in advance of excavating or trenching, by contacting all local utilities and by prospecting and pot holing. Any damage to facilities not shown shall be solely the responsibility of Contractor.

SC-5.06 *Hazardous Environmental Conditions at Site*

Delete Paragraphs 5.06.A. and 5.06B. in their entirety and insert the following:

- A. No reports or drawings related to Hazardous Environmental Conditions at the Site are known to Owner.
- B. Not Used.

Delete Paragraph 5.06.I. in its entirety.

SC-6.01 *Performance, Payment, and Other Bonds*

Delete Paragraph 6.01.A. in its entirety and insert the following in its place:

- A. Contractor shall furnish a payment and performance bond in an amount at least equal to the Contract Price, in complete satisfaction of the provisions of Section 255.05, Florida Statutes, as security for the faithful performance and payment of all of Contractor's obligations under the Contract. The form of the payment and performance bond shall be in the form of the Public Construction Bond provided by Owner in Section 00600 of the ITB issued by Owner for construction of the Work. These bonds shall remain in effect until one year after the date when final payment becomes due or until completion of the correction period specified in Paragraph 15.08, whichever is later, except as provided otherwise by Laws and Regulations, the Supplementary Conditions, or other specific provisions of the Contract. Contractor shall also furnish such other bonds as are required by the Supplementary Conditions or other specific provisions of the Contract. Contractor shall record that bond in the Public Records of Highlands County, Florida, as required by Section 255.05(1), Florida Statutes.

SC-6.03 *Contractor's Insurance*

Delete Paragraph 6.03.I.3. in its entirety and insert the following in its place:

3. contain a provision or endorsement that the coverage afforded will not be canceled, materially changed or renewal refused until at least 10 days, or such longer time period as is required by Laws and Regulations, prior written notice has been given to Contractor.

Add the following new Paragraphs to Paragraph 6.03:

- K. Contractor shall have and maintain in full force and effect the following insurance during the Term of this Contract and shall furnish to County Certificates of Insurance documenting that insurance coverage has been obtained which meets the following requirements:
1. **Workers' Compensation.** Contractor shall have and maintain workers' compensation insurance for all employees for statutory limits in compliance with Laws and Regulations. This insurance policy must include Employer's Liability with a limit of \$100,000 each accident, \$500,000 disease (policy Limit), and \$100,000 disease (each employee).
 2. **Commercial General Liability. Occurrence Form Required:** Contractor shall have and maintain commercial general liability (CGL) insurance with a limit of not less than \$3,000,000 each occurrence. If such CGL insurance contains a general aggregate limit, it shall apply separately to this project in the amount of \$3,000,000. Products and completed operations aggregate shall be \$3,000,000. CGL insurance shall be written on an occurrence form and shall include bodily injury and property damage liability for premises, operations, independent contractors, products and completed operations, contractual liability, broad form property damage and property damage resulting from explosion, collapse or underground (x, c, u) exposures, personal injury, and advertising injury. Fire damage liability shall be included at \$100,000.
 3. **Commercial Auto Liability Insurance.** Contractor shall have and maintain commercial automobile liability insurance with a limit of not less than \$3,000,000 combined single limit per occurrence for bodily injury and property damage liability. That insurance shall cover liability arising out of any auto (including owned, hired, and non-owned autos). The policy shall be endorsed to provide contractual liability coverage.
 4. **Umbrella Excess Liability -** Contractor may satisfy the required minimum liability limits with an Umbrella or Excess Liability policy. Contractor agrees to endorse Owner and its elected officials, agents, employees, and volunteers, in the manner required by Paragraph 6.03.K.7, as Additional Insureds unless the Umbrella provides "follow form" provisions of the underlying policies. This must be confirmed in writing on the Certificate of Insurance.
 5. **Deductibles/Retentions -** Contractor is responsible for any expenses or costs below deductibles applicable to any policies.
 6. **Formal Certificates of Insurance** shall be delivered by Contractor to Owner upon execution of the Agreement. Certificates of Insurance shall be signed by a person authorized by that insurer to bind coverage on its behalf. All

Certificates of Insurance must be on file with and approved by Owner before commencement of any Work activities.

7. The formal insurance certificates shall name "Highlands County, a political subdivision of the State of Florida and its elected officials, agents, employees and volunteers" as "Additional Insureds" on all policies except Workers' Compensation. Additional Insureds status for Completed Operations must be provided without time limitation or for a minimum of 5 years following completion of the Project.
 8. These are minimum requirements which are subject to modification in response to high hazard operations. Owner reserves the right to require Contractor to provide and pay for any other insurance coverage Owner deems necessary, depending upon the possible exposure to liability.
 9. The policies of insurance shall be written on forms acceptable to Owner and placed with insurance carriers authorized by the Insurance Department in the State of Florida and meet a minimum financial AM Best company rating of no less than "A- Excellent: FSC VII.
 10. All policies must include Waiver of Subrogation and any liability aggregate limits shall apply "Per Jobsite"/Per Job Aggregate. All liability insurance shall be Primary and Non-Contributory. Each Certificate of Insurance shall confirm in writing that these provisions apply.
- L. Contractor shall require each Subcontractor to have and maintain the insurance required by Paragraph 6.03.K. This requirement may be modified by Owner by written instrument on a case by case basis, in its sole discretion. It is the responsibility of the Contractor to ensure that all Subcontractors comply with all insurance requirements.
- M. Contractor shall provide notification to Owner and Engineer by overnight delivery return receipt requested, hand delivery or confirmed facsimile 30 days prior to giving and within 3 days after receiving notice of cancellation, modification, non-renewal, or any other lapse in coverage of any required insurance policies.

SC-6.05 *Property Insurance*

Delete Paragraph 6.05.B. in its entirety and insert the following Paragraph in its place:

- B *Notice of Cancellation or Change:* All the policies of insurance (and the certificates or other evidence thereof) required to be purchased and maintained in accordance with this Paragraph 6.05 will contain a provision or endorsement that the coverage afforded will not be canceled or materially changed or renewal refused until at least 10 days, or such longer time period as is required by Laws and Regulations, prior written notice has been given to the purchasing policyholder. Contractor shall provide notification to Owner and Engineer by overnight delivery return receipt requested,

hand delivery or confirmed facsimile 30 days prior to giving and within 3 days after receiving notice of cancellation, modification, non-renewal, or any other lapse in coverage of any required insurance policies.

SC-6.06 *Waiver of Rights*

Delete Paragraphs 6.06.B. and C. in their entirety.

SC-7.01 *Supervision and Superintendence*

Add the following to the end of Paragraph 7.01.B.:

The superintendent will be Contractor's representative at the Site and shall have authority to act on behalf of Contractor. All communications given to or received from the superintendent shall be binding on Contractor.

SC-7.02 *Labor; Working Hours*

Add the following new Paragraphs immediately after Paragraph 7.02.B.:

- C. In all cases, local labor shall be given preference when available.
- D. Whenever Owner shall notify Contractor that any man on the Work is, in his opinion, incompetent, unfaithful, or disorderly, or who uses threatening or abusive language to any person representing Owner when on the Work, such man shall be immediately discharged from the Work and shall not be re-employed thereon except with the consent of Owner.

SC-7.03 *Services, Materials, and Equipment*

Add the following new Paragraph immediately after Paragraph 7.03.C.:

D. The responsibility for the protection and safekeeping of equipment and materials on or near the Site will be entirely that of Contractor and that no Claim shall be made against Owner by reason of any act of an employee or trespasser. Should an occasion arise necessitating access to the sites occupied by the stored materials and equipment, Contractor shall immediately move same. No materials or equipment may be placed upon the property of Owner until Owner has approved the location contemplated by Contractor to be used for storage.

SC-7.04 *"Or Equals"*

Delete the word "considered" from Paragraph 7.04.E. and insert the word "consider" in its place.

SC-7.06 *Concerning Subcontractors, Suppliers, and Others*

Delete Paragraph 7.06.H. in its entirety and insert the following in its place:

- H. Prior to submitting the first Application for Payment and within 3 workdays after any change, Contractor shall submit to Engineer a complete list of all Subcontractors and Suppliers having a direct contract with Contractor, and of all other Subcontractors and Suppliers known to Contractor at the time of submittal.

SC-7.07 *Patent Fees and Royalties*

Delete Paragraph 7.07.B. in its entirety.

SC-7.08 *Permits*

Delete Paragraph 7.08.A. in its entirety and insert the following in its place:

- A. Unless otherwise provided in the Contract Documents or Section 218.80, Florida Statutes, Contractor shall obtain and pay for all construction permits and licenses. Owner shall assist Contractor, when necessary, in obtaining such permits and licenses. Contractor shall pay all governmental charges and inspection fees necessary for the prosecution of the Work which are applicable at the time of the submission of Contractor's Bid (or when Contractor became bound under a negotiated contract). Owner shall pay all charges of utility owners for connections for providing permanent service to the Work.

SC-7.09 *Taxes and Direct Material Purchase Procedure*

Add the following new Paragraphs immediately after Paragraph 7.09.A.:

- B. Owner is exempt from payment of sales and compensating use taxes of the State of Florida and of cities and counties thereof on all materials to be incorporated into the Work.
- C. Contractor shall provide assistance to Owner for Direct Purchases to enable Owner to purchase tangible personal property needed for this Project which Owner intends to purchase in order to realize savings of sales tax on all tangible personal property needed for this Project. Contractor will recommend direct purchases for items where those direct purchases will result in significant tax savings to Owner. Owner will either accept or reject Contractor's recommendations, and purchases will be made according to Owner's decision. Owner retains the absolute right, with or without Contractor's recommendation, to purchase any or all tangible personal property needed for this Project.
- D. Contractor will provide detailed scoping and pricing for purchase orders with a minimum value of Five Thousand Dollars (\$5,000.00), in harmony with the Subcontractors to Owner for the incorporation in Owner's purchase orders.
- E. Owner will issue purchase orders within three (3) workdays from the date of receipt of requisition, directly to the vendors and provide a copy of each purchase order to Contractor.

- F. Contractor will be responsible for the materials until they are incorporated into the Project and will purchase and/or have ample Builder's Risk insurance for the direct purchased materials.
- G. Contractor will issue a deductive subcontract adjustment to the Subcontractor which will account for the value of the material and the sales tax as it pertains to that Subcontractor's contract. All subcontracts shall include a clause incorporating, by reference, the provisions of this Paragraph 7.09.
- H. As the material is delivered to the jobsite, the Subcontractor will sign off on the delivery receipt/invoice for the material delivered, store and secure the material adequately at the Site, and forward the invoice to Contractor who will review, approve and forward the invoice to Owner's Representative for approval and processing.
- I. Owner will draft a check for the approved invoice amount and mail that check directly to the vendor. A list of the check numbers with related dates of issue, names of vendors, amounts paid, and paid invoice numbers will be forwarded to Contractor in order that Contractor can accurately track payment.
- J. Contractor and Owner are encouraged to take advantage of all discounts available.
- K. Owner will issue to Contractor a deductive Change Order in the amount of the direct purchased materials. The amount equal to the sales tax which would have been paid if those materials had been purchased by Contractor will be credited to Owner through a Contingency line item on the pay application's schedule of values, and the Contract Price specified in Article 4 of the Agreement shall be reduced by an amount equal to the amounts paid directly by Owner for direct purchases made pursuant to this Article, plus an amount equal to the sales tax that would have been paid if those materials had been purchased by Contractor.

SC-7.10 *Laws and Regulations*

Delete Paragraph 7.10.B. in its entirety and insert the following in its place:

- B. It shall be Contractor's responsibility to make certain that the Work described in the Contract Documents is in accordance with Laws and Regulations. Contractor shall bear all costs and losses, and shall indemnify and hold harmless Owner and Owner's officers and employees from and against all liabilities, damages, losses, and costs, including, but not limited to, reasonable attorney's fees arising out of or relating to Work or other action that is contrary to Laws or Regulations.

SC-7.11 *Record Documents*

Delete the word "Engineer" at the end of Paragraph 7.11.A. and insert the word "Owner" in its place.

SC-7.12 *Safety and Protection*

Add the following new Paragraph to Paragraph 7.12:

- H. Contractor shall pay for all damages to private property, public property, and any public utilities.

SC-7.17 *Contractor's General Warranty and Guarantee*

Add the following new Paragraph to paragraph 7.17:

- E. All materials incorporated in the Work shall comply with the requirements of the Construction Documents. Any Defective Work which develop within 1 year after the date of final acceptance shall be promptly repaired by or replaced to "as new" condition by Contractor without any additional expense to Owner.

SC-7.18 *Indemnification*

Delete Paragraph 7.18 in its entirety and insert the following in its place.

- A. To the fullest extent permitted by Laws and Regulations, and in addition to any other obligations of Contractor under the Contract or otherwise, Contractor shall indemnify and hold harmless Owner and Owner's officers and employees from and against all liabilities, damages, losses, and costs, including, but not limited to, reasonable attorney's fees to the extent caused by the negligence, recklessness, or intentional wrongful misconduct of Contractor and persons employed or utilized by Contractor in the performance of any of the Work.
- B. In any and all claims against Owner or any of its officers or employees by any employee (or the survivor or personal representative of such employee) of Contractor, any Subcontractor, any Supplier, or any individual or entity directly or indirectly utilized by any of them to perform any of the Work, or anyone for whose acts any of them may be liable, the indemnification obligation under Paragraph 7.18.A shall not be limited in any way by any limitation on the amount or type of damages, compensation, or benefits payable by or for Contractor or any such Subcontractor, Supplier, or other individual or entity under workers' compensation acts, disability benefit acts, or other employee benefit acts.
- C. The indemnification obligations of Contractor under Paragraph 7.18.A shall be limited to \$1,000,000 per occurrence.

SC-7.19 *Delegation of Professional Design Services*

Add the following new Paragraph immediately after Paragraph 7.19.E.:

- F. If Contractor provides professional design services as a design professional, as that term is defined in Section 725.08(4), Florida Statutes, Contractor shall indemnify and hold harmless Owner and Owner's officers and employees, from liabilities, damages, losses, and costs, including, but not limited to reasonable attorneys' fees, to the extent caused by the negligence, recklessness, or intentionally wrongful conduct of Contractor providing professional design services as a design professional and other persons employed or utilized by Contractor in the performance of the professional design services.

SC-7.20-7.29

Add the following new Paragraphs immediately after new Paragraph 7.19.F.:

SC-7.20 *Storage of Materials*

- A. The responsibility for the protection and safekeeping of equipment and materials on or near the Site will be entirely that of Contractor, and no claim shall be made against Owner by reason of any act of an employee or trespasser. Should an occasion arise necessitating access to the Sites occupied by these stored materials and equipment, Contractor shall immediately move same. No materials or equipment may be placed upon the property of Owner until Owner has approved the location contemplated by Contractor to be used for storage.

SC-7.21 *Erosion and Drainage Control*

- A. Contractor shall implement Best Management Practices (BMP's) to provide for drainage of storm water and such water as may be applied or discharged on the Site in performance of the Work. Drainage facilities shall be adequate to prevent damage to the Work, the Site and adjacent property.
- B. Contractor shall prevent the pollution of drains and watercourses by sanitary wastes, sediment, debris or other substances resulting from this work. Contractor shall clean up and isolate such materials on a continuing basis to prevent risk of washing into such drainage ways.
- C. Contractor shall determine if a Stormwater Discharge Permit or a Construction Dewatering Discharge Permit applies to the Work. Contractor shall obtain required permit(s) if necessary for completion of the Work.

SC-7.22 *Protection of Trees and Natural Conditions*

- A. No trees or shrubs shall be damaged or removed beyond delineated limits of disturbance except those flagged by Owner. No areas shall be disturbed beyond the designated limits indicated by Owner. Contractor shall install orange safety fence to delineate limits of disturbance, and Contractor shall be responsible for damage mitigation beyond these limits.

SC-7.23 *Dewatering*

- A. If dewatering is required at the Site, Contractor shall comply with all dewatering requirements of governmental agencies.

SC-7.24 *Protection of Public and Private Property*

- A. Contractor shall protect, shore, brace, support and maintain all underground pipes, conduits, drains, and other underground or above ground structures uncovered or otherwise affected by the construction of the Work performed by Contractor. All pavement, surfacing, driveways, curbs, walks, buildings, utility poles, guy wires, fences, guard posts, and other surface structures affected by construction operations, together with all trees, sod and shrubs in yards and parking lots removed or damaged, shall be restored to their original condition or replaced as determined and approved by Owner, whether within or outside Owner's right-of-way. All replacements shall be made with new materials.
- B. Contractor shall be responsible for all damages to streets, roads, highways, shoulders, ditches, embankments, culverts, facilities and utilities, bridges, property corners and monuments and other public or private property, regardless of location or character, which may be caused by construction of the Work or by transporting equipment, materials or men to or from the Work or any part or site thereof, whether by Contractor or Contractor's Subcontractors. Contractor shall make satisfactory and acceptable arrangements with the owner of, or the agency or authority having jurisdiction over, the damaged property concerning its repair or replacement or payment of costs incurred in connection with the damage.
- C. All fire hydrants and water control valves shall be kept free from obstruction and for use at all times.
- D. Contractor shall be responsible for any damage to existing structures during the course of the Work.

SC-7.25 *Maintenance of Traffic*

- A. Contractor shall provide traffic control plans as required by the controlling highway, street or road authority. Contractor shall perform the Work so as to interfere as little as possible with public travel, whether vehicular or pedestrian. Whenever necessary to cross, use, obstruct or close roads, driveways and walks, whether public or private, Contractor shall, at its own expense, provide and maintain suitable and safe bridges, detours or other temporary expedients, for the accommodation of public and private travel, and shall give reasonable notice to owners of private drives before interfering with them. Such maintenance of traffic will not be required when Contractor has obtained permission from the owner and tenant of private property, or from the

authority having jurisdiction over the public property involved, to obstruct traffic at the designated point. Obstructions, such as material piles and equipment, shall be provided with appropriate warning signs and lights.

- B. After completion, the roadway shall be restored to original condition, and disturbed areas shall be restored to original condition.

SC-7.26 *Testing*

- A. Contractor shall be responsible for all testing required for sampling and testing of materials to prove compliance with the Contract Documents. This shall include, but not be limited to mix design approvals for concrete and asphalt, pipe bedding gradations and Proctor tests and gradations for imported granular fill materials. Specific requirements shall be included in the applicable specification sections.
- B. Tests required to monitor control performance of the Work in accordance with the Contract Documents such as concrete cylinder tests and compaction tests shall be ordered and paid for by Contractor. Any retesting required as a result of the first test failure will be at Contractor's expense. Contractor will assist in providing locations and allowing the tests to be conducted without obstructions and in accordance with all Laws and Regulations. Contractor shall correct or modify its operations where indicated necessary by the test results.

SC-7.27 *Unfavorable Construction Conditions*

- A. During unfavorable weather, wet ground or other unsuitable construction conditions, Contractor shall confine its operations to work which will not be affected adversely by such conditions. No portion of the Work shall be constructed under conditions which affect adversely the quality or efficiency thereof, unless special means or precautions are taken by Contractor to perform the Work in a proper and satisfactory manner.

SC-7.28 *Notices to Owners and Authorities*

- A. Contractor shall notify owners of adjacent property and utilities when prosecution of Work may affect them.
- B. Utilities and other concerned agencies shall be contracted at least 48 hours prior to cutting or closing streets or other traffic areas or excavating near Underground Facilities or pole lines.

SC-7.29 *Storage of Fuel or Hazardous Materials*

- A. No fuel or other hazardous materials shall be stored on the Site. Extreme care and compliance with all regulations shall be required when handling all such materials.

SC-11.01 *Amending and Supplementing Contract Documents*

Delete the first sentence of Paragraph 11.01.A. and insert the following in its place:

The Contract Documents may be amended or supplemented by a Change Order, a Work Change Directive, or a Field Order if approved, in writing, by Owner.

SC-14.02 *Tests, Inspections, and Approvals*

Delete Paragraph 14.02.B. in its entirety and insert the following in its place:

- B. Owner shall retain and Contractor shall pay for the services of an independent inspector, testing laboratory, or other qualified individual or entity to perform all inspections and tests expressly required by the Contract Documents to be furnished by Owner, except that costs incurred in connection with tests or inspections of covered Work shall be governed by the provisions of Paragraph 14.05.

SC-15 **ARTICLE 15 – PAYMENTS TO CONTRACTOR; SET-OFFS; COMPLETION; CORRECTION PERIOD.**

Add the following to the end of 15.01.B.1.:

If the payment and performance of the Work is not secured by a payment and performance bond, all applications for payment shall include a written statement that indicates how the payment will be distributed. Contractor shall disburse the payment as provided in that written statement.

Add the following new Paragraph to Paragraph 15.01.B.:

4. *If Requested by Owner:*
- a. Contractor shall deliver a certified list of all Subcontractors, laborers, and material suppliers to Owner within 30 days of receiving the request. This list shall be updated by Contractor thereafter each month with a certified statement by Contractor that the list and its updates include the names and address of all of Subcontractors, laborers, and Suppliers furnishing labor and/or material for the Project.
- b. Contractor shall provide a written statement with each pay request to the Owner which indicates how each payment will be distributed. This pay request breakdown shall define the disbursement of all the funds requested.

- c. When Contractor receives any payment pursuant to this Contract, Contractor shall pay laborers and each Subcontractor and Supplier the amounts stated in Contractor's written statement delivered to Owner for that pay request.
- d. Contractor shall provide a written statement with all but the first payment request from each of the Subcontractors, laborers, and Suppliers identified in Paragraph 15.01.B.4.b., that they have in fact received payment as provided in Paragraph 15.01.B.4.c. In the event a payment will not be made as stated on a prior written statement delivered pursuant to Paragraph 15.01.B.4.b., Contractor shall furnish an explanation as to the reasons for such deviation and shall request approval from the Engineer.

Add the following new Paragraphs immediately after Paragraph 15.08.E.:

SC-15.09 *Local Government Prompt Payment Act*

- A. If the total cost of the construction services purchased by Owner pursuant to this Contract exceeds \$200,000, the provisions of this Article are subject to the provisions of the Local Government Prompt Payment Act, Sections 218.70 through 218.79, inclusive, Florida Statutes, except to the extent provided therein and in that event provisions of this Article are modified and amended to the extent required to be consistent with the Local Government Prompt Payment Act.

SC-15.10 *Interest*

- A. All moneys not paid when due as provided in Paragraph 15 shall bear interest at the maximum rate of 6 percent per annum, simple.

SC-16.02 *Owner May Terminate for Cause*

Delete Paragraph 16.02 in its entirety and insert the following in its place:

16.02 Owner May Terminate for Cause

- A. The occurrence of any one or more of the following events will constitute a default by Contractor and justify termination for cause:
 - 1. Contractor's persistent failure to perform the Work in accordance with the Contract Documents (including, but not limited to, failure to supply sufficient skilled workers or suitable materials or equipment or failure to adhere to the Progress Schedule);
 - 2. Failure of Contractor to perform or otherwise to comply with a material term of the Contract Documents;
 - 3. Contractor's disregard of Laws or Regulations of any public body having jurisdiction;

4. Contractor's repeated disregard of the authority of Owner or Engineer; or
 5. Contractor becomes involved as a debtor in a bankruptcy proceeding, or becomes involved in a reorganization, dissolution, or liquidation proceeding, or if a trustee or receiver is appointed over all or a substantial portion of the property of Contractor under federal bankruptcy law or any state insolvency law.
- B. If one or more of the events identified in Paragraph 16.02.A occurs, then after giving Contractor (and any surety) ten (10) days written notice that Owner is considering a declaration that Contractor is in default and termination of the Contract, Owner may proceed to:
1. declare Contractor to be in default, give Contractor (and any surety) notice that the Contract is terminated, and enforce the rights available to Owner under any applicable payment and performance bond; or
 2. notify Contractor of the deficiency with a requirement that the deficiency be corrected within a specified time, otherwise the Contract will be terminated at the end of such time; or
 3. take whatever action is deemed appropriate by Owner.
- C. Subject to the terms and operation of any applicable performance bond, if Owner has terminated the Contract for cause, Owner may exclude Contractor from the Site, take possession of the Work, incorporate in the Work all materials and equipment stored at the Site or for which Owner has paid Contractor but which are stored elsewhere, and complete the Work as Owner may deem expedient.
- D. If Owner proceeds as provided in Paragraph 16.02.B, Contractor shall not be entitled to receive any further payment until the Work is completed. If the unpaid balance of the Contract Price exceeds the cost to complete the Work, including all related claims, costs, losses, and damages (including but not limited to all fees and charges of engineers, architects, attorneys, and other professionals) sustained by Owner, such excess will be paid to Contractor. If the cost to complete the Work including such related claims, costs, losses, and damages exceeds such unpaid balance, Contractor shall pay the difference to Owner. Such claims, costs, losses, and damages incurred by Owner will be reviewed by Engineer as to their reasonableness and, when so approved by Engineer, incorporated in a Change Order. When exercising any rights or remedies under this paragraph, Owner shall not be required to obtain the lowest price for the Work performed.
- E. Where Contractor's services have been so terminated by Owner, the termination will not affect any rights or remedies of Owner against Contractor then existing or which may thereafter accrue, or any rights or remedies of Owner against Contractor or any surety under

any payment bond or performance bond. Any retention or payment of money due Contractor by Owner will not release Contractor from liability.

- F. If and to the extent that Contractor has provided a performance bond under the provisions of Paragraph 6.01.A, the provisions of that bond shall govern over any inconsistent provisions of Paragraph 16.02.B.

- END OF SECTION -

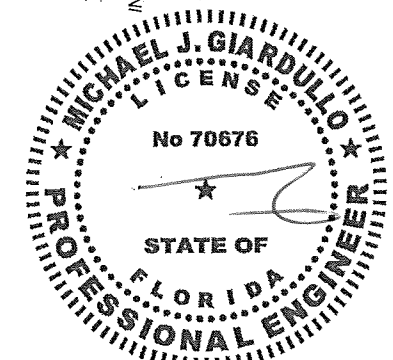
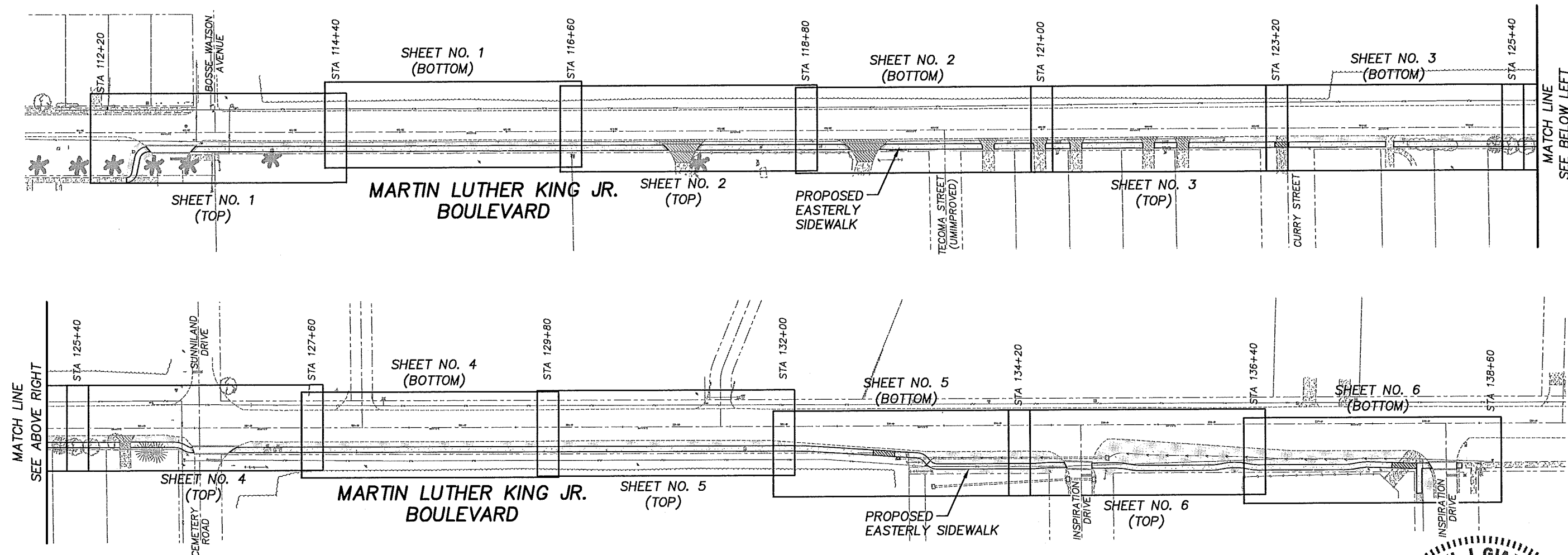
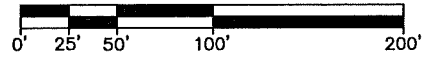
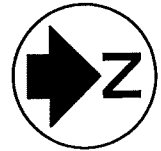

Michael J. Giardullo
 Professional Engineer
 State of Florida
 Registration No. 70676
 ENGINEER OF RECORD
 DATE OF SIGNATURE:
 JUNE 2, 2017

REVISIONS	
DATE	DESCRIPTION
2-27-17	DELETED COMMERCIAL ASPHALT DRIVEWAYS AT STA. 117+62 (R) & 119+34 (R) AND REPLACE WITH CONCRETE DRIVEWAYS
6-2-17	DELETED MAINTAINED RIGHT-OF-WAY (WEST SIDE)

WEC *excellence in engineering*
 WEILER ENGINEERING CORPORATION
 201 WEST MARION AVENUE, SUITE 1306
 PUNTA GORDA, FLORIDA 33950
 OFFICE: (941) 505-1700
 FAX: (941) 505-1702
 EB # 6656

**MARTIN L. KING JR. BOULEVARD
 SIDEWALK EXTENSION**

PLAN VIEW - KEY

SHEET NO.
G-4

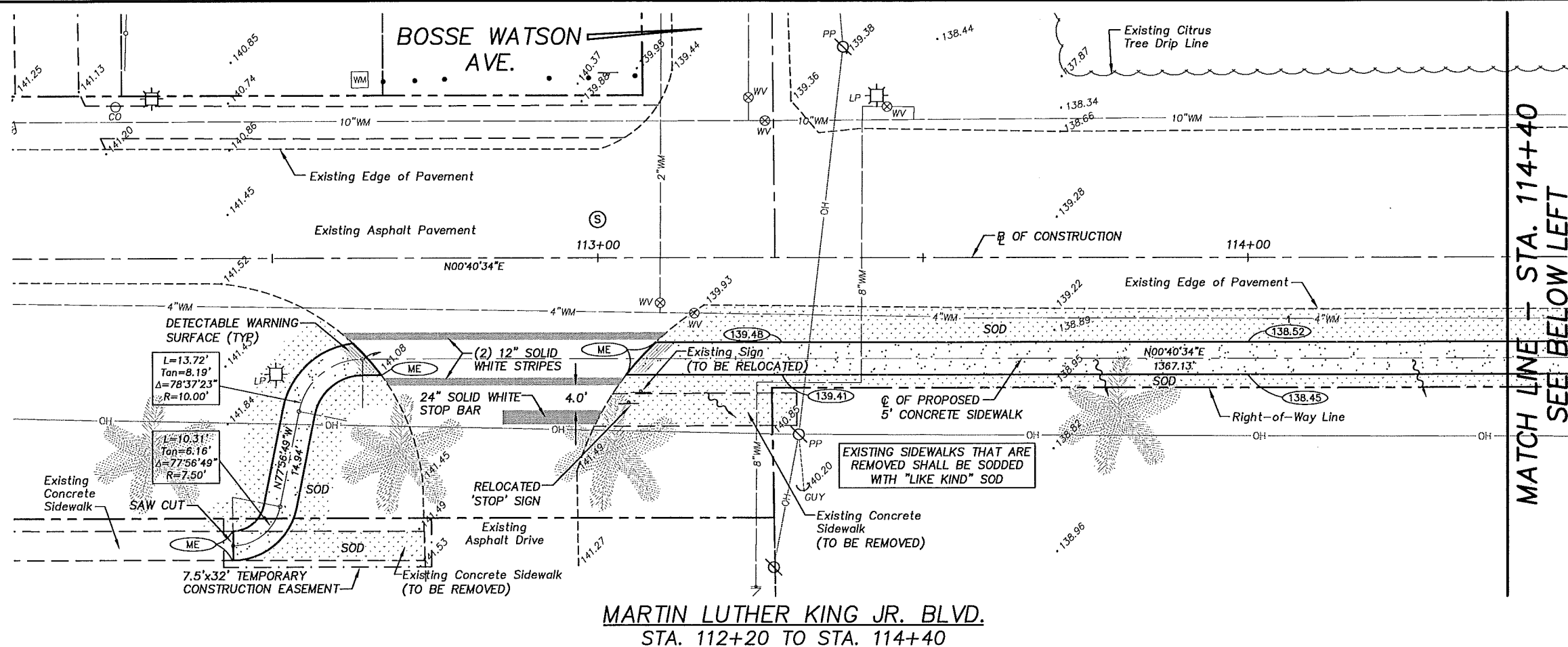

MARTIN LUTHER KING JR. BLVD.
STA. 112+20 TO STA. 114+40

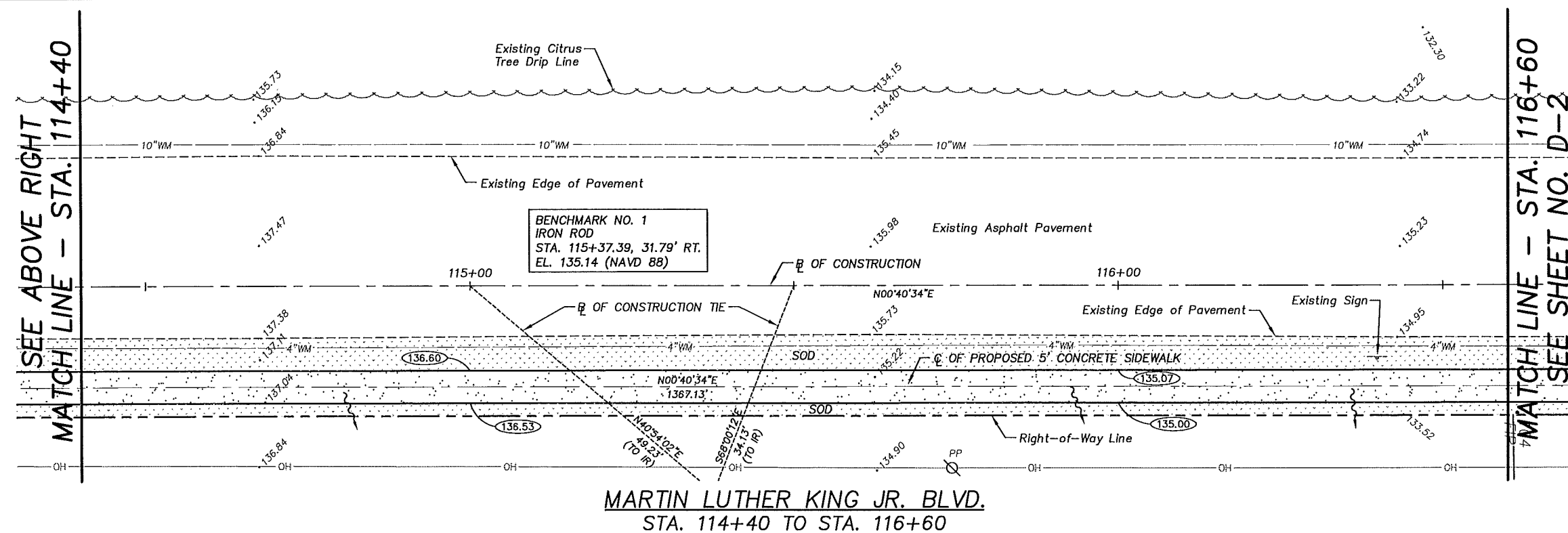

MARTIN LUTHER KING JR. BLVD.
STA. 114+40 TO STA. 116+60

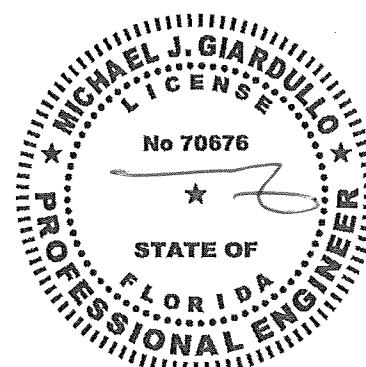
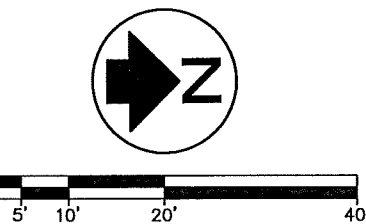

Michael J. Giardullo
Professional Engineer
State of Florida
Registration No. 70676
ENGINEER OF RECORD
DATE OF SIGNATURE:
JUNE 2, 2017

REVISIONS			
DATE	DESCRIPTION	DATE	DESCRIPTION
6-2-17	DELETED MAINTAINED RIGHT-OF-WAY (WEST SIDE)		

WEC *excellence in engineering*
WEILER ENGINEERING CORPORATION
201 WEST MARION AVENUE, SUITE 1306
PUNTA GORDA, FLORIDA 33950
OFFICE: (941) 505-1700
FAX: (941) 505-1702 EB # 6656

**MARTIN L. KING JR. BOULEVARD
SIDEWALK EXTENSION**

**SIDEWALK DESIGN
STA. 112+20 TO STA. 116+60**

SHEET NO.
D-1

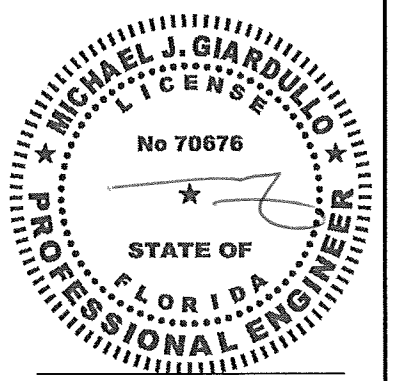
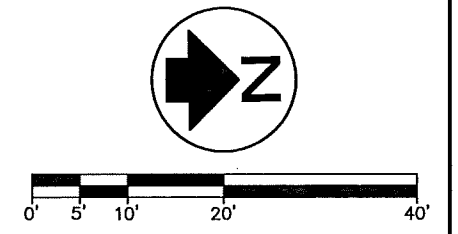
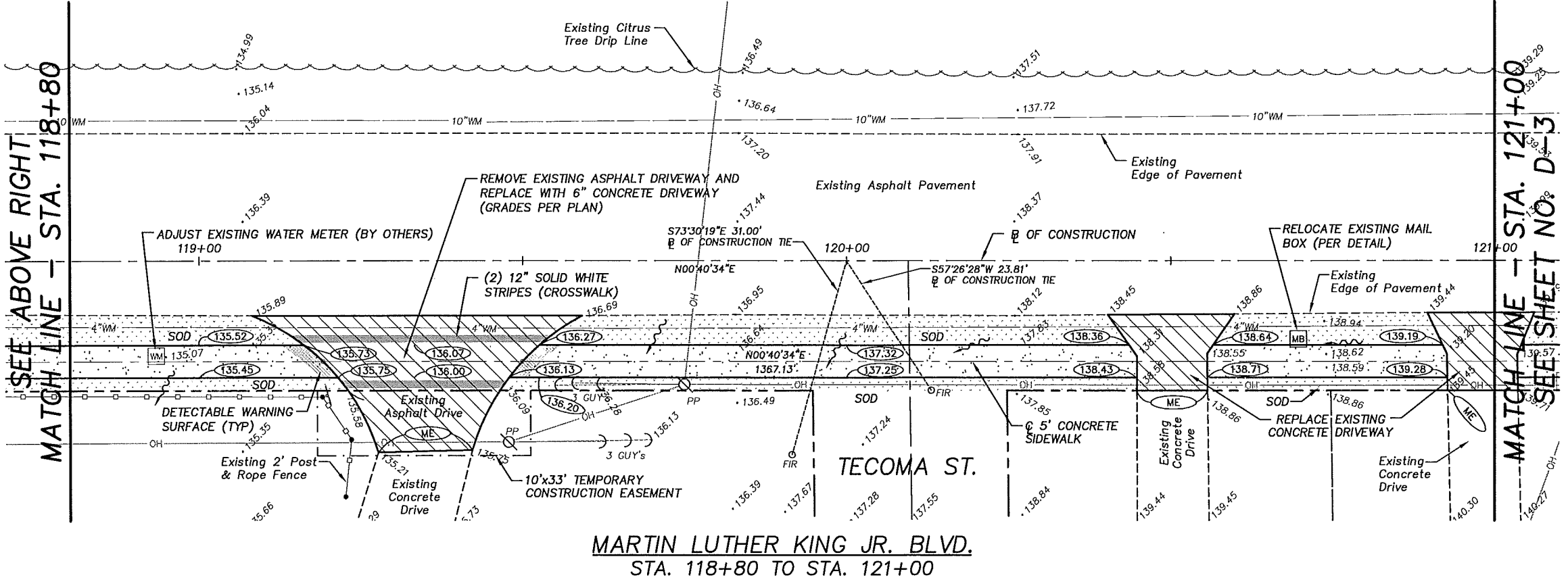
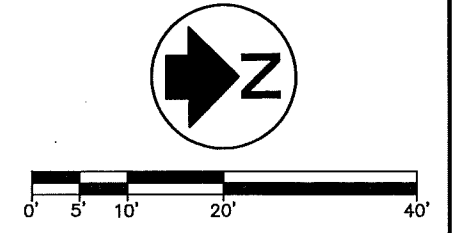
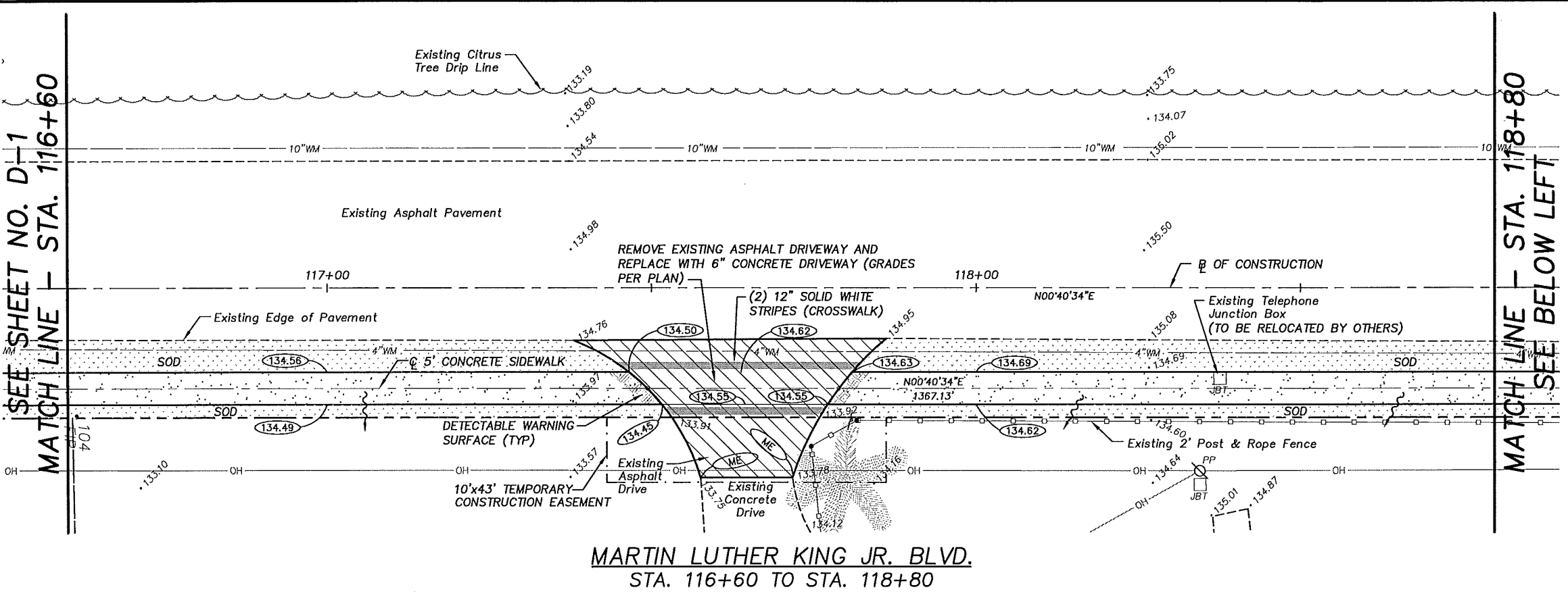

Michael J. Giardullo
 Professional Engineer
 State of Florida
 Registration No. 70676
 ENGINEER OF RECORD
 DATE OF SIGNATURE:
 JUNE 2, 2017

REVISIONS	
DATE	DESCRIPTION
2-27-17	DELETED COMMERCIAL ASPHALT DRIVEWAYS AT STA. 117+62 (R) & 119+34 (R) AND REPLACE WITH CONCRETE DRIVEWAYS
6-2-17	DELETED MAINTAINED RIGHT-OF-WAY (WEST SIDE)

WEC *excellence in engineering*
 WEILER ENGINEERING CORPORATION
 201 WEST MARION AVENUE, SUITE 1306
 PUNTA GORDA, FLORIDA 33950
 OFFICE: (941) 505-1700
 FAX: (941) 505-1702 EB # 6656

**MARTIN L. KING JR. BOULEVARD
 SIDEWALK EXTENSION**

**SIDEWALK DESIGN
 STA. 116+60 TO STA. 121+00**

SHEET NO.
 D-2

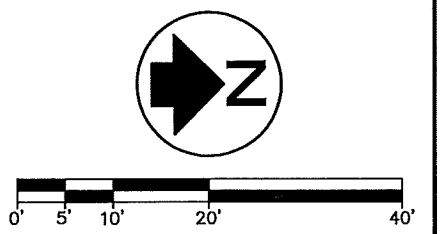
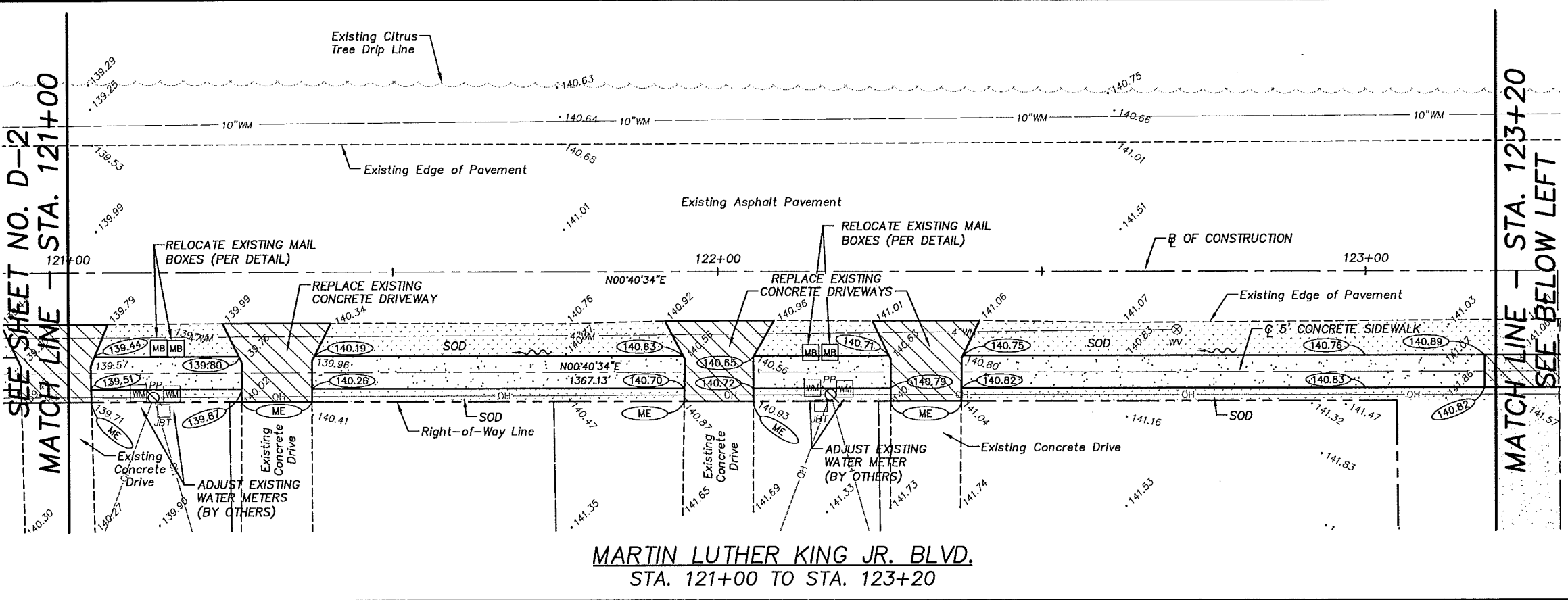

MARTIN LUTHER KING JR. BLVD.
STA. 121+00 TO STA. 123+20

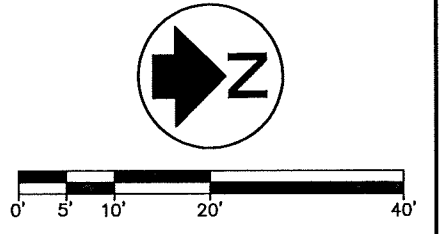
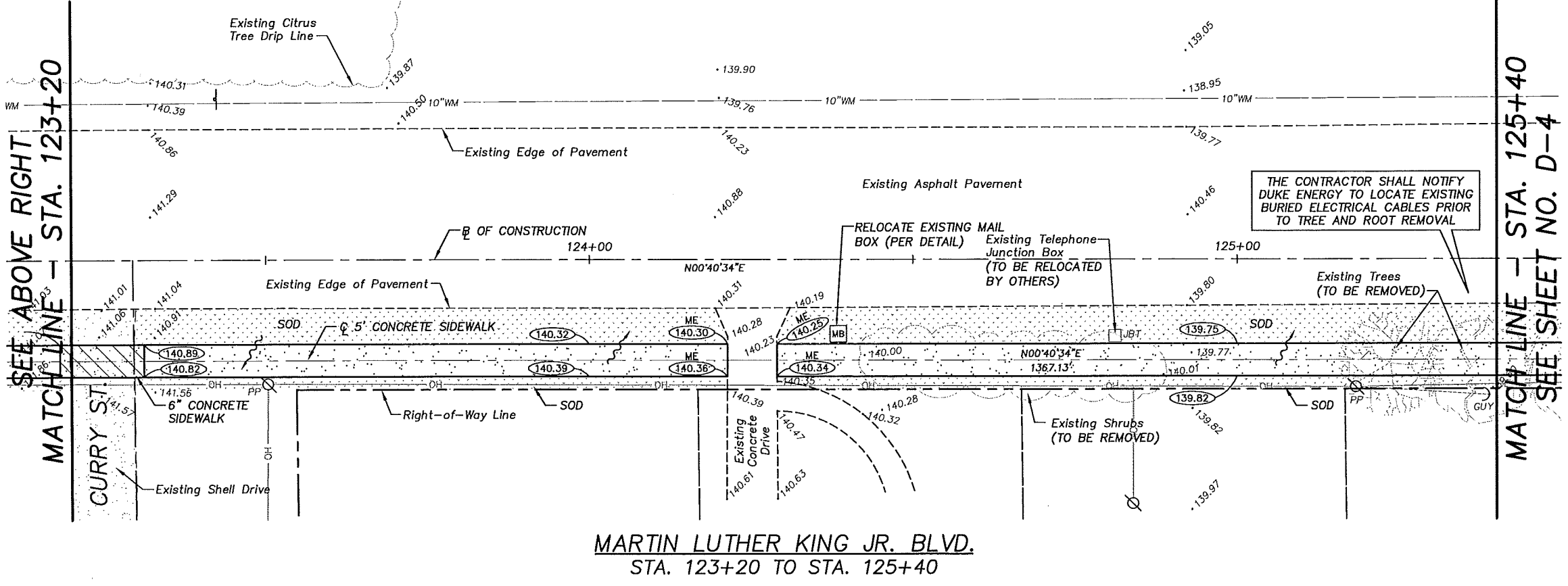

MARTIN LUTHER KING JR. BLVD.
STA. 123+20 TO STA. 125+40

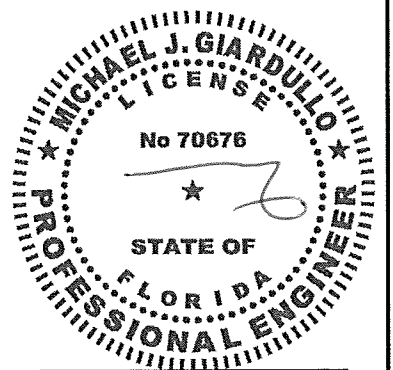

Michael J. Giardullo
Professional Engineer
State of Florida
Registration No. 70676
ENGINEER OF RECORD
DATE OF SIGNATURE:
JUNE 2, 2017

REVISIONS			
DATE	DESCRIPTION	DATE	DESCRIPTION
6-2-17	DELETED MAINTAINED RIGHT-OF-WAY (WEST SIDE)		

WEC *excellence in engineering*
WEILER ENGINEERING CORPORATION
201 WEST MARION AVENUE, SUITE 1306
PUNTA GORDA, FLORIDA 33950
OFFICE: (941) 505-1700
FAX: (941) 505-1702 EB # 6656

**MARTIN L. KING JR. BOULEVARD
SIDEWALK EXTENSION**

**SIDEWALK DESIGN
STA. 121+00 TO STA. 125+40**

SHEET NO.
D-3

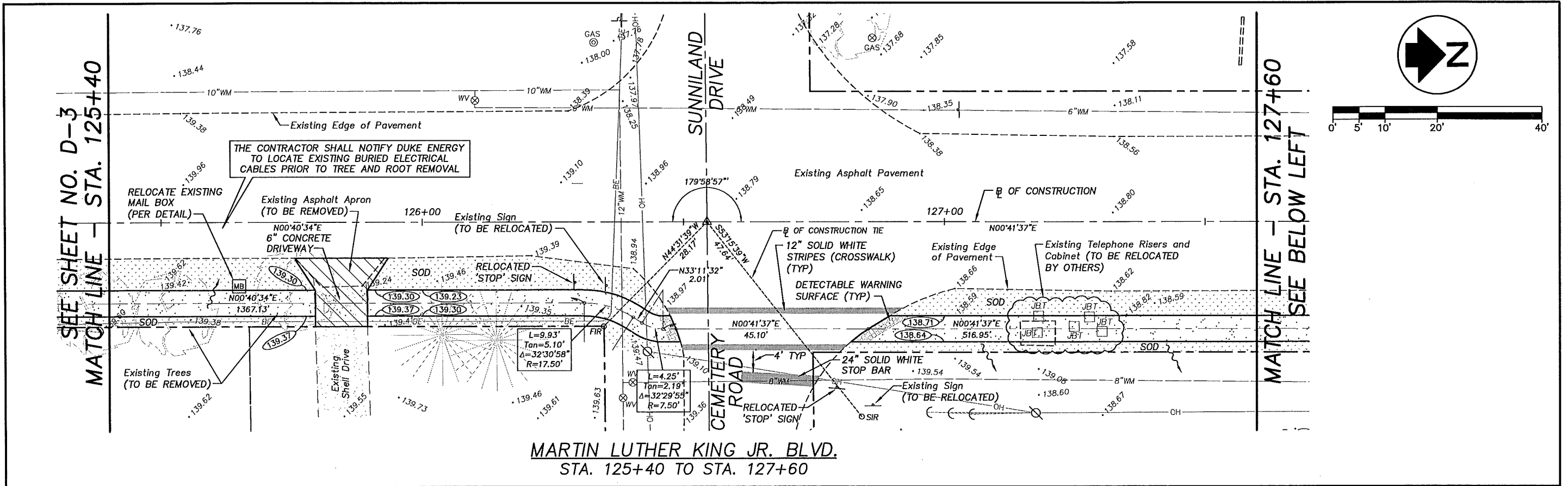

MARTIN LUTHER KING JR. BLVD.
STA. 125+40 TO STA. 127+60

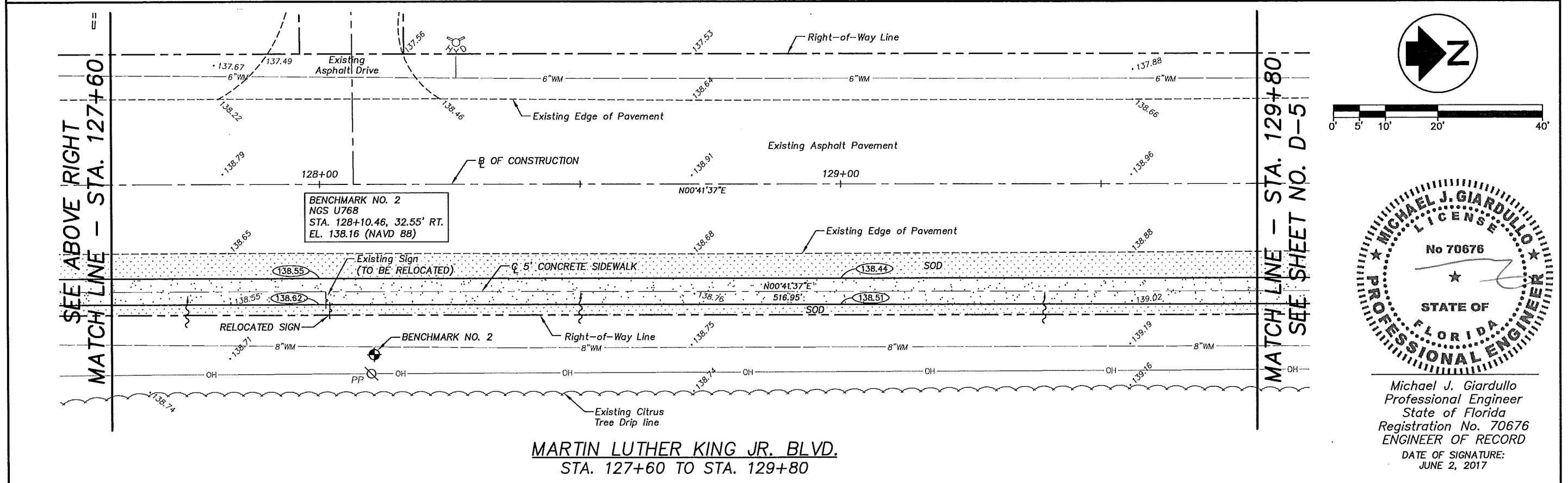

MARTIN LUTHER KING JR. BLVD.
STA. 127+60 TO STA. 129+80

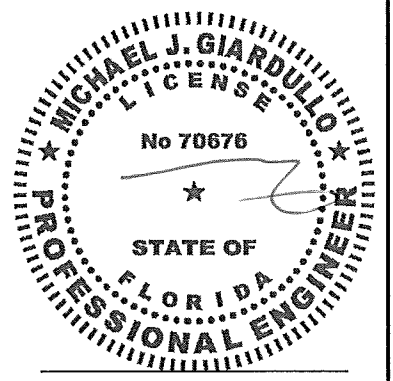

Michael J. Giardullo
Professional Engineer
State of Florida
Registration No. 70676
ENGINEER OF RECORD
DATE OF SIGNATURE:
JUNE 2, 2017

REVISIONS			
DATE	DESCRIPTION	DATE	DESCRIPTION
6-2-17	DELETED MAINTAINED RIGHT-OF-WAY (WEST SIDE)		

WEC *excellence in engineering*
WEILER ENGINEERING CORPORATION
201 WEST MARION AVENUE, SUITE 1306
PUNTA GORDA, FLORIDA 33950
OFFICE: (941) 505-1700
FAX: (941) 505-1702 EB # 6656

**MARTIN L. KING JR. BOULEVARD
SIDEWALK EXTENSION**

**SIDEWALK DESIGN
STA. 125+40 TO STA. 129+80**

SHEET NO.
D-4

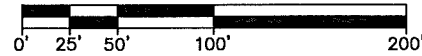
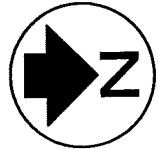

EROSION AND SEDIMENT CONTROL NOTES

1. STAKED SILT FENCE SHALL BE INSPECTED AND MAINTAINED ON A DAILY BASIS DURING CONSTRUCTION.
2. ALL STAKED SILT FENCE SHALL CONFORM TO THE LATEST EDITION OF THE F.D.O.T. MANUAL FOR EROSION AND SEDIMENT CONTROL MANUAL.

EROSION CONTROL MAINTENANCE SCHEDULE

THE CONTRACTOR SHALL INSTALL SILT FENCE, STAKED HAY BALES, AND OTHER EROSION CONTROL DEVICES AS SHOWN ON THE DRAWINGS PRIOR TO BEGINNING CONSTRUCTION. THESE INSTALLATIONS AS SHOWN ON THE DRAWINGS SHALL BE CONSIDERED THE MINIMUM EROSION/SILTATION PROTECTION REQUIRED FOR THE SITE. IN ADDITION THE ENGINEER, OWNER, OR OWNER'S REPRESENTATIVE MAY DEEM IT NECESSARY TO INSTALL PROTECTIVE FACILITIES ELSEWHERE ON THE SITE.

THE CONTRACTOR SHALL BE RESPONSIBLE FOR MAINTAINING THE EROSION PROTECTION FACILITIES THROUGH COMPLETION OF CONSTRUCTION. THE CONTRACTOR SHALL PERFORM DAILY INSPECTIONS OF THE FACILITIES TO ENSURE THAT THE EROSION PROTECTION FACILITIES ARE MAINTAINING THEIR PROTECTION FUNCTIONS AND INTEGRITY.

ALL EROSION PROTECTION FACILITIES SHALL BE REMOVED AFTER CONSTRUCTION COMPLETION, AND WHEN A VEGETATIVE COVER HAS BEEN WELL ESTABLISHED OVER THE CONSTRUCTED AREAS, PER THE PLANS: THE CONTRACTOR SHALL REMOVE PROTECTION FACILITIES ONLY UPON APPROVAL BY THE ENGINEER, OWNER, OR OWNER'S REPRESENTATIVE.

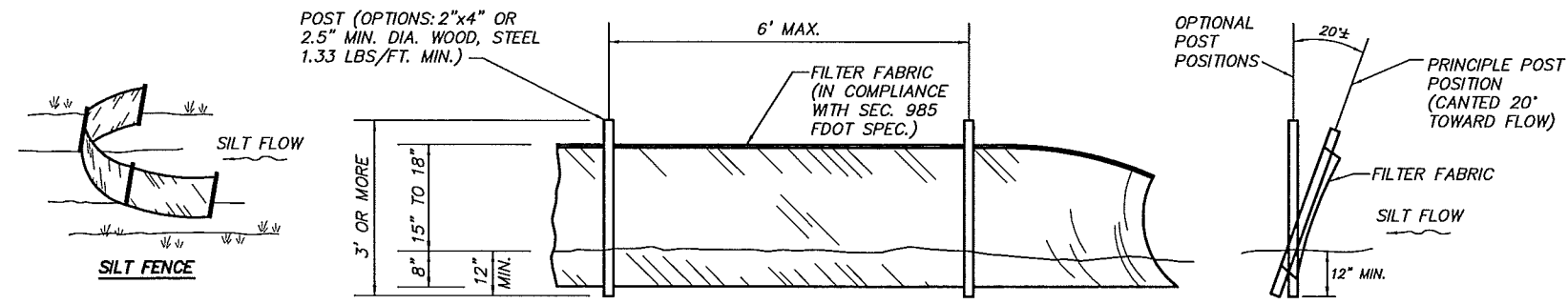
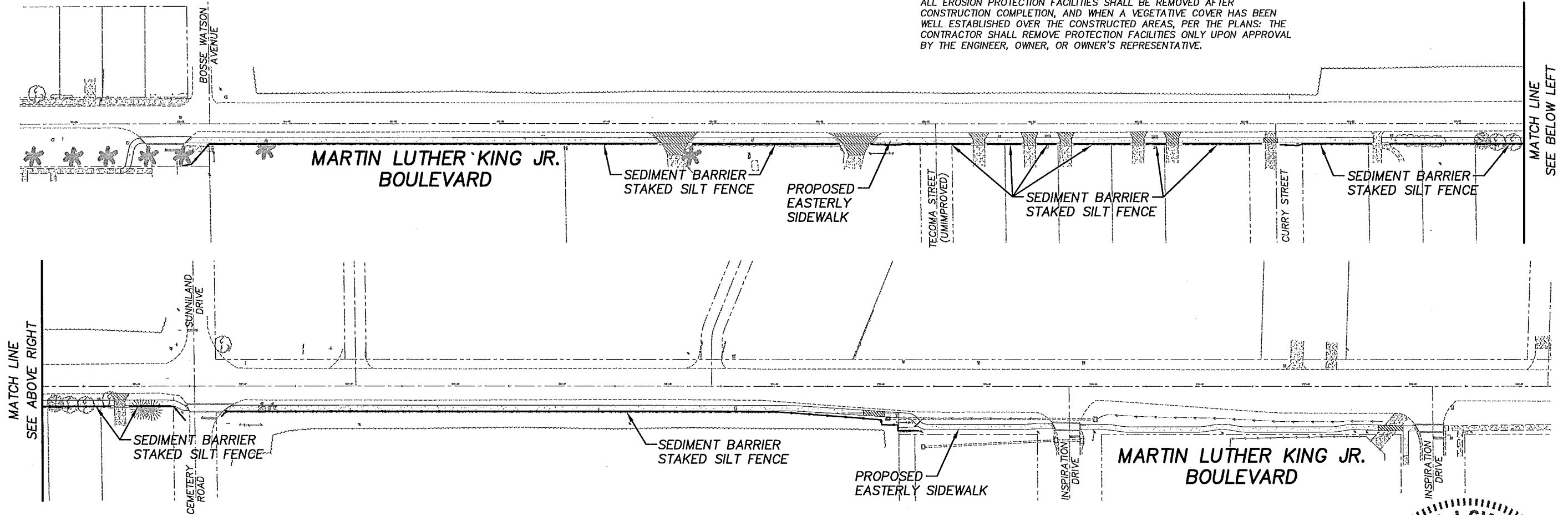

NOTE:
CONTRACTOR TO INSPECT SILT FENCE DAILY AND REPAIR IMMEDIATELY IF DAMAGED.

ELEVATION

SECTION

TYPICAL SILT FENCE

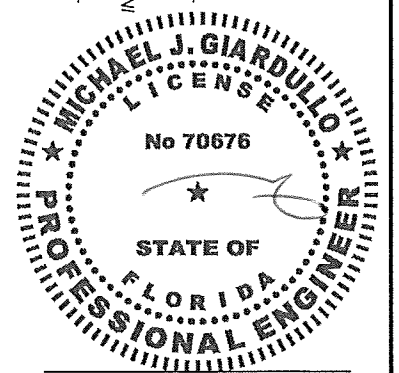

Michael J. Giardullo
Professional Engineer
State of Florida
Registration No. 70676
ENGINEER OF RECORD
DATE OF SIGNATURE:
MARCH 3, 2017

REVISIONS	
DATE	DESCRIPTION
2-27-17	DELETED COMMERCIAL ASPHALT DRIVEWAYS AT STA. 117+62 (R) & 119+34 (R) AND REPLACE WITH CONCRETE DRIVEWAYS
6-2-17	DELETED MAINTAINED RIGHT-OF-WAY (WEST SIDE)

WEC *excellence in engineering*
WEILER ENGINEERING CORPORATION
201 WEST MARION AVENUE, SUITE 1306
PUNTA GORDA, FLORIDA 33950
OFFICE: (941) 505-1700
FAX: (941) 505-1702
EB # 6656

**MARTIN L. KING JR. BOULEVARD
SIDEWALK EXTENSION**

**BEST MANAGEMENT PRACTICES
PLAN AND DETAILS**

SHEET NO.
BMP-1