



The City of Canton

Invitation to Bid

City of Canton, Ohio
Purchasing Department
218 Cleveland Ave. SW, 4th floor
Canton, Ohio 44702

12th St. NW Water Main Replacement (TAG 617)

Item/Project

Water Department

Responsible Department

2:00:00 PM, 3/17/2021

Bids Due

Bid Proposal Submitted By:

Company Name

Street Address

City

State

Zip

Contact Person

Phone No.

Email Address



Table of Contents and Bidder's Checklist - 12th St. NW Water Main Replacement (TAG 617)

[Legal Notice](#)

[INSTRUCTIONS TO BIDDERS](#)

[OWNER-CONTRACTOR AGREEMENT](#)

[BID GUARANTY AND CONTRACT BOND](#)

[BID FORM](#)

[CONTRACTOR'S QUALIFICATION STATEMENT](#)

[Modified General Conditions \(EJCDC\)](#)

[City of Canton Codified Ordinances](#)

[STATEMENT OF CLAIM FORM](#)

[CONTRACTOR'S PERSONAL PROPERTY TAX AFFIDAVIT](#)

[CONTRACTOR'S FINAL WAIVER & RELEASE AFFIDAVIT](#)

[PRE-BID SUBSTITUTION FORM](#)

[ODOT MANUAL SUPPLEMENT](#)

- Appendix A: Project Labor Agreement
- Appendix B: Prevailing Wage Rates and Information
- Appendix C: Specifications and Drawings
- Appendix D: Title VI Requirements

Bidder's Checklist: The completed Bid Form shall be accompanied by the following completed documents:

- _____ [Pre-Bid Substitution](#), if any proposed substitutes have been pre-approved.
- _____ [Bid Guaranty and, if applicable Contract Bond](#)
- _____ [Contractor's Qualification Statement](#)
- _____ [Contractor's List of Subcontracted Work Categories](#)
- _____ [A list identifying its DBE subcontractors and participation rates as a percentage of the Contract Price](#), and if the DBE participation goal has not been met, certification of good faith efforts to meet the DBE participation goal.
- _____ The Project Labor Agreement (PLA) Letter of Assent (See Appendix A).
- _____ If this project is funded in whole or part by the [Ohio Public Works Commission](#), then certification of agreement and compliance with certain statements and covenants regarding Bidder's subscription to the State's Equal Employment Opportunity Requirements for State-assisted Construction Contracts.



The City of Canton

Legal Notice

Sealed bids will be received by the City of Canton (the "City"), as provided in this notice for the 12th St. NW Water Main Replacement (TAG 617) Project (the "Project"), Ordinance 220/2020. Contract documents, which include additional details of the Project, are on file and available from the City of Canton's web site (<https://cantonohio.gov/448/Purchasing-Procurement>).

Bids shall be enclosed in a sealed envelope addressed to the City of Canton, 218 Cleveland Ave. SW, Purchasing Dept/Fourth Floor, Canton, Ohio 44702 and plainly marked on the outside "12th St. NW Water Main Replacement (TAG 617) PROJECT BID." Bids will be received on or before 2:00:00 PM, local time, 3/17/2021 and will be opened shortly thereafter.

Questions regarding plans and specifications should be addressed in writing to Purchasing Department, at purchasing@cantonohio.gov.

All bids must include a Bid Guaranty, as described in the Instructions to Bidders. Prevailing wage rates apply. All bidders will be required to comply with the City Contract Compliance Program regarding equal employment opportunity. After submission and opening, no bidder may withdraw its bid within 60 days after the opening; the City reserves the right to waive irregularities, reject any or all bids, and conduct necessary investigations to determine bidder responsibility.

Published in The Repository on March 2, 2021 and March 9, 2021



INSTRUCTIONS TO BIDDERS

TABLE OF CONTENTS

A. BIDDER’S PLEDGE AND AGREEMENT 2

B. EXAMINATION OF CONTRACT DOCUMENTS AND SITE CONDITIONS AND RELIANCE UPON TECHNICAL DATA 2

C. OWNER & ENGINEER 3

D. PROJECT 3

E. WORK 3

F. ESTIMATE OF COST 4

G. CONTRACT DOCUMENTS 4

H. PREPARATION OF BIDS 4

I. METHOD OF AWARD 7

J. EXECUTION OF CONTRACT 12

K. SUBSTITUTIONS/NON-SPECIFIED PRODUCTS..... 12

L. ALTERNATES..... 13

M. UNIT PRICES 13

N. ADDENDA 14

O. INTERPRETATION 14

P. STATE SALES AND USE TAXES 15

Q. DATE FOR SUBSTANTIAL COMPLETION/DATE FOR FINAL COMPLETION/LIQUIDATED DAMAGES 15

R. OWNER’S RIGHT TO WAIVE DEFECTS AND IRREGULARITIES..... 16

S. MODIFICATION/WITHDRAWAL OF BIDS 16

T. COMPLIANCE WITH APPLICABLE LAWS 17

U. FINDINGS FOR RECOVERY 17

V. PREVAILING WAGES..... 17

W. DBE PARTICIPATION GOALS 17

X. OTHER LOCAL ORDINANCE REQUIREMENTS 18

Y. OHIO PUBLIC WORKS COMMISSION FUNDING..... 21



A. BIDDER'S PLEDGE AND AGREEMENT

1. Each Bidder acknowledges that this is a public project involving public funds and that the Owner expects and requires that each successful Bidder adhere to the highest ethical and performance standards. Each Bidder by submitting a bid pledges and agrees that (a) it will act at all times with absolute integrity and truthfulness in its dealings with the Owner and the Engineer, (b) it will use its best efforts to cooperate with the Owner and the Engineer and all other Contractors on the Project and at all times will act with professionalism and dignity in its dealings with the Owner, Engineer, and other Contractors, (c) it will assign only competent supervisors and workers to the Project, each of whom is fully qualified to perform the tasks that are assigned to him/her, and (d) it has read, understands and will comply with the terms of the Contract Documents.

B. EXAMINATION OF CONTRACT DOCUMENTS AND SITE CONDITIONS AND RELIANCE UPON TECHNICAL DATA

1. Each Bidder shall have a competent person carefully and diligently review each part of the Contract Documents, including the Divisions of the Specifications and parts of the Drawings that are not directly applicable to the Work on which the Bidder is submitting its bid. By submitting its bid, each Bidder represents and agrees, based upon its careful and diligent review of the Contract Documents, that it is not aware of any conflicts, inconsistencies, errors, or omissions in the Contract Documents for which it has not notified the Owner in writing at least ten (10) days prior to the bid opening. If there are any such conflicts, inconsistencies, errors, or omissions in the Contract Documents, the Bidder (i) will provide the labor, equipment, or materials of the better quality or greater quantity of Work and/or (ii) will comply with the more stringent requirements. The Bidder will not be entitled to any Change Order, additional compensation, or additional time on account of such conditions for any conflicts, inconsistencies, errors, or omissions that would have been discovered by such careful and diligent review, unless it has given prior written notice to the Owner.
2. Each Bidder shall have a competent person carefully and diligently inspect and examine the entire site and the surrounding area, including all parts of the site applicable to the Work for which it is submitting its bid, including location, condition, and layout of the site and the location of utilities, and carefully correlate the results of the inspection with the requirements of the Contract Documents. The Bidder's bid shall include all costs attributable to site and surrounding area conditions that would have been discovered by such careful and diligent inspection and examination of the site and the surrounding area, and the Bidder shall not be entitled to any Change Order, additional compensation, or additional time on account of such conditions.
3. The Bidder may rely upon the general accuracy of any technical data identified in the Owner-Contractor Agreement (e.g., any soils exploration reports, soil boring logs, site survey, or abatement reports) in preparing its bid, but such technical data are not part of the Contract Documents. Except for the limited reliance described in the preceding sentence, Bidder may not, if awarded a contract for the Work, rely upon or make any Claim against the Owner or Engineer, or any of their agents or employees, with respect to any of the following:
 - a. the completeness of such reports and drawings for Bidder's purposes, including, but not limited to, any aspects of the means, methods, techniques, sequences, and procedures of construction to be employed by the successful Bidder and safety precautions and programs incident thereto; or



The City of Canton

- b. any interpretation by the successful Bidder of or conclusion drawn from any technical data or any such other data, interpretations, opinions, or information. For example, all interpolations and extrapolations of data performed by the Bidder to estimate locations or quantities of subsurface strata are independent factual assumptions, which Owner does not warrant.
4. Each Bidder will be deemed to have actual knowledge of all information provided or discussed at the pre-bid meeting.

C. OWNER & ENGINEER

1. The Owner is:

The City of Canton
218 Cleveland Avenue SW
Canton, OH 44702
Telephone: 330.489.3245
Fax: 330.489.3499

The Owner's Representative is:

Dylan Peoples

2. The Design Engineer for the Project is:

NA
NA
NA, NA NA

D. PROJECT

1. The Project and Work for the Project consists of all labor, materials, equipment, and services necessary for construction of the project identified as **12th St. NW Water Main Replacement (TAG 617) Project** ("the Project"), all in accordance with the Drawings and Specifications prepared by the Engineer and/or Owner. The Project must be substantially complete by the Date for Substantial Completion set forth in Section Q below.
2. The Mayor **has** determined that a Project Labor Agreement ("PLA") will advance the City's procurement interest in cost, efficiency, and quality while promoting labor-management stability as well as compliance with applicable legal requirements governing safety and health, equal employment opportunity, labor and employment standards, and other related matters. Any such PLA shall be negotiated by the Mayor of the Owner with the East Central Ohio Building and Construction Trades Council and its affiliated local unions, or said Council's successor. The successful Bidder shall comply with and adhere to all of the provisions of any PLA for the Project.
3. A pre-bid conference will be held at **NA on NA** at **NA**.

E. WORK

1. This Project includes **Roadwork, asphalt, concrete, waterwork**, and the like as set forth in the Contract Documents.
2. Alternate No. 1 for this Project is **NA**.
3. Alternate No. 2 for this Project is **NA**.



The City of Canton

4. Only one contract will be issued by the Owner for constructing the Project, the General Contract, which will cover all scopes of work necessary to construct the Project.
5. The Contractor awarded the General Contract (General Contractor) will be responsible for the performance and coordination of any and all subcontractors and suppliers either directly or indirectly contracted with the General Contractor.
6. Owner will provide Bidders access to the Project site to conduct such examinations, investigations, explorations, tests, and studies as Bidder deems necessary for submission of a Bid. Bidder shall fill all holes, clean up, and restore the Site to its former condition upon completion of such explorations, investigations, tests, and studies. Bidder shall comply with all applicable laws, regulations and Owner's policies relative to excavation and utility locates. Bidders may contact **Dylan Peoples**, The City of Canton, at dylan.peoples@cantonohio.gov or **330-438-6564** if they have any interest in accessing the Project site, independent of any pre-bid meeting.

F. ESTIMATE OF COST

1. The total estimated construction cost for the Base Bid Work for the Project for which bids are being solicited at this time is **\$287,700.00**.

The estimated cost for Alternate 1 - **NA** is: **\$-**.

The estimated cost for Alternate 2 - **NA** is: **\$-**.

G. CONTRACT DOCUMENTS

The Contract Documents consist of the documents listed in Section 1 of the Owner-Contractor Agreement.

Bidders may view and download copies of the Contract Documents from The City of Canton Purchasing web site at <https://cantonohio.gov/448/Purchasing-Procurement>, which is the only authorized source of the Contract Documents. The City of Canton's sourcing tool, Vendor Registry, will maintain the Bidder's list and will provide notice and copies of Addenda as issued. It is the responsibility of any person or organization interested in a hard copy of the Contract Documents to pay all costs associated with printing.

Bidders shall use complete sets of Contract Documents in preparing bids. Neither the Owner nor the Design Engineer assumes any responsibility for errors or misinterpretations resulting from the use of incomplete sets of Contract Documents.

The Owner, in making the Contract Documents available on the above terms, does so only for the purpose of obtaining bids on the Work and does not confer a license or grant for any other use.

H. PREPARATION OF BIDS

1. All bids must be submitted on the "Bid Form" furnished with the Contract Documents.
2. All blank spaces shall be filled in, in ink or typewritten, in words and figures, and in figures only where no space is provided for words, and signed by the Bidder. The wording on the Bid Form shall be used without change, alteration, or addition. Any change in the wording or omission of specified accompanying documents may cause the bid to be rejected. If there is an inconsistency or conflict in the Bid, the lowest amount shall control, whether expressed in numbers or words.
3. Bidders shall note receipt of Addenda on the Bid Form. If the Bidder fails to acknowledge receipt of each Addendum, the Bid shall be deemed non-responsive, unless the Bid



The City of Canton

amount clearly and unambiguously reflects receipt of the Addendum or the Addendum involves only a matter of form and does not materially affect the price, quantity or quality of the Work to be performed.

4. Each Bidder shall submit **an original** of its bid to the Owner. The Bid Form shall be signed with the name typed or printed below the signature. A Bid shall not be submitted by facsimile transmission or any other electronic means. A Bidder that is a corporation shall sign its bid with the legal name of the corporation followed by the name of the state of incorporation and the legal signature of an officer authorized to bind the corporation to a contract.
5. Each Bid shall be enclosed in a sealed opaque envelope with the Bidder's name and the title of the Project printed in the upper left hand corner and addressed as follows:

The City of Canton
ATTN: **Purchasing/Bids**
218 Cleveland Avenue SW
Canton, OH 44702

Bids must be received at the designated location for the bid opening before 2:00:00 PM, local time, on 3/17/2021.

6. **The completed Bid Form shall be accompanied by the following completed documents:**
 - a. **Pre-Bid Substitution, if any proposed substitutes have been pre-approved. (See Section K, below.)**
 - b. **Bid Guaranty and, if applicable Contract Bond (See Paragraph H.8, below.)**
 - c. **Contractor's Qualification Statement (See Paragraph I.4, below.)**
 - d. **Contractor's List of Subcontracted Work Categories (See Paragraph I.5, below.)**
 - e. **A list identifying its DBE subcontractors and participation rates as a percentage of the Contract Price, and if the DBE participation goal has not been met, certification of good faith efforts to meet the DBE participation goal. (See Section W, below.)**
 - f. **The Project Labor Agreement (PLA) Letter of Assent (See Appendix A).**
 - g. **If this project is funded in whole or part by the Ohio Public Works Commission, then certification of agreement and compliance with certain statements and covenants regarding Bidder's subscription to the State's Equal Employment Opportunity Requirements for State-assisted Construction Contracts (See Section Y, below.)**
7. The Bidder shall take the following precautions in preparing its bid:
 - a. Sign the bid and check to ensure all blank spaces have been filled in with requested information and that the specified accompanying documents (listed in Paragraph H.6 above) have been included in a sealed opaque envelope addressed as described in Paragraph H.5 above.



The City of Canton

- b. When the Bid Form provides for quoting either an addition or deduction for an Alternate item, indicate whether the sum named is an addition or deduction. If it is not indicated, it will be conclusively presumed that the amount is a deduction.
 - c. When the Bid Form provides for quoting a unit price, the Bidder should quote the unit price as set forth in the Contract Documents as described in Paragraph M.1 below.
 - d. When applicable, make sure that the Bid Guaranty is properly executed and signed by:
 - 1) The Bidder
 - 2) The Surety or Sureties
 - e. Make sure that the amount of the Bid Guaranty (if the Bid Guaranty is in the form of a certified check, letter of credit, or cashier's check) is for a specific sum in an amount as instructed in Paragraph H.8.a below. If the Bid Guaranty is in the form of the Bid Guaranty and Contract Bond, the amount may be left blank; if an amount is inserted, it must equal the total of the base bid and all add alternates included. If inserted, then the failure to state an amount equal to the total of the base bid and all add alternates shall make the bid non-responsive if the Owner selects alternates not included in the amount.
 - f. Make sure that the appropriate bid package and scope of work is inserted in the correct space on the Bid Guaranty and Contract Bond Form. Failure to include work covered by the bid submitted may make the bid non-responsive.
8. Bonds and Guarantees

- a. Bid Guaranty: Bidder shall furnish a Bid Guaranty, as prescribed in Sections 153.54, 153.57, and 153.571 of the Ohio Revised Code, in the form of either: (1) a bond for the full amount of the bid in the form of the Bid Guaranty and Contract Bond included in the Contract Documents; or (2) a certified check, cashier's check, or irrevocable letter of credit in a form satisfactory to the Owner in an amount equal to 10% of the bid. Bid amount shall be the total of all sums bid, including all add alternatives, but excluding all deduct alternatives. **NOTE: AIA or EJCDC Bid Bond forms are not acceptable.**
- b. Contract Bond: The successful Bidder, who, as a Bid Guaranty, submits a certified check, cashier's check, or irrevocable letter of credit in an amount equal to 10% of the bid, shall furnish a Contract Bond in the form included in the Contract Documents in an amount equal to 100% of the Contract Sum. **NOTE: AIA or EJCDC Bond forms are not acceptable.**
- c. The bond must be issued by a surety company authorized by the Ohio Department of Insurance to transact business in the State of Ohio and acceptable to the Owner. The bond must be issued by a surety capable of demonstrating a record of competent underwriting, efficient management, adequate reserves, and sound investments. These criteria will be deemed to be met if the surety currently has an A.M. Best Company Policyholders Rating of "A-" or better and has or exceeds the



The City of Canton

Best Financial Size Category of Class VI. Other sureties may be acceptable to the Owner, in its sole discretion.

- d. All bonds shall be signed by an authorized agent of an acceptable surety and by the Bidder.
- e. Surety bonds shall be supported by credentials showing the Power of Attorney of the agent, a certificate showing the legal right of the Surety Company to do business in the State of Ohio, and a financial statement of the Surety.
- f. The Bid Guaranty, as applicable, shall be in the name of or payable to the order of the Owner.
- g. The name and address of the Surety and the name and address of the Surety's Agent must be typed or printed on each bond.

9. Permits

- a. Owner has obtained, or will obtain the following permits for the Project, as applicable:

Stark Co. Road Opening Permit

- b. Contractor shall secure and pay for all other permits necessary to complete the Project. Owner shall pay all charges of utility owners for connections for providing permanent service to the Work.

I. METHOD OF AWARD

1. All bids shall remain open for acceptance for sixty (60) days following the day of the bid opening, but the Owner may, in its sole discretion, release any bid and return the Bid Guaranty prior to that date. The Bid Guaranty shall be subject to forfeiture, as provided in the Ohio Revised Code, if a bid is withdrawn during the period when bids are being held.
2. The Owner reserves the right to reject any, part of any, or all bids and to waive any informalities and irregularities. The Bidder expressly acknowledges this right of the Owner to reject any or all bids or to reject any incomplete or irregular bid. Bidders must furnish all information requested on the Bid Form. Failure to do so may result in disqualification of the bid.
3. Determination of the Lowest and Best Bid. Subject to the right of the Owner to reject any or all bids, pursuant to the Codified Ordinances of Canton Chapters 105, 182, and 507, the Owner will award the Contract for the Work to the bidder submitting the lowest and best bid, taking into consideration accepted alternates. In evaluating bids, the Owner will consider the qualifications of the Bidders, whether or not the bids comply with the prescribed requirements, and alternates and unit prices, if requested, on the Bid Form. The Owner may also consider the qualifications and experience of subcontractors and suppliers. The Owner may conduct such investigations as are deemed necessary to establish the qualifications and financial ability of the Bidder and its subcontractors and suppliers. The factors the Owner may consider in determining which bid is the lowest and best include the factors set forth below, including the Additional Criteria. Depending upon the type of work, the Owner, in its discretion, may also consider other essential factors, as the Owner may determine and as are included in the Specifications. The Owner, in its discretion, may consider and give such weight to these criteria as it deems appropriate. The Owner, in its discretion, reserves the right to request additional



The City of Canton

information and documentation relating to these criteria from Bidders after the bid opening.

- a. Work to be subcontracted. The Bidder must identify all work to be subcontracted. See paragraph I.5 below. All subcontractors are subject to the approval of the Owner based on the criteria set forth in this Section I.
- b. The Bidder's work history. The Bidder should have a record of consistent customer satisfaction and of consistent completion of projects, including projects that are comparable to or larger and more complex than the Owner's Project, on time and in accordance with the applicable Contract Documents, and based upon the Bidder's claims history. If the Bidder's management operates or has operated another construction company, the Owner may consider the work history of that company in determining whether the Bidder submitted the lowest and best bid.

The Owner will consider the Bidder's prior experience on other projects of similar scope and/or complexity including prior projects with the Owner and/or Design Professional, including the Bidder's demonstrated ability to complete its work on these projects in accordance with the Contract Documents and on time, and will also consider its ability and capacity to perform a substantial portion of the project with its own forces and its ability to work with the Owner and Engineer as a willing, cooperative, and successful team member. Bringing overstated claims, an excessive number of claims, acting uncooperatively, and filing lawsuits against project owners and/or their design professionals on prior projects of similar scope and/or complexity will be deemed evidence of a Bidder's inability to work with the Owner and Engineer as a willing, cooperative, and successful team member.

The Bidder authorizes the Owner and its representatives to contact the owners and design professionals (and construction managers, if applicable) on projects on which the Bidder has worked and authorizes and requests such owners and design professionals (and construction managers) to provide the Owner with a candid evaluation of the Bidder's performance. By submitting its bid, the Bidder agrees that if it or any person, directly or indirectly, on its behalf or for its benefit brings an action against any of such owners or design professionals (or construction managers) or the employees of any of them as a result of or related to such candid evaluation, the Bidder will indemnify and hold harmless such owners, design professionals (and construction managers) and the employees of any of them from any claims, whether or not proven, that are part of or are related to such action and from all legal fees and expenses incurred by any of them arising out of or related to such legal action. This obligation is expressly intended for the benefit of such owners, design professionals (and construction managers), and the employees of each of them.

- c. The Bidder's prior history regarding timeliness of performance, quality of work, the Bidder's history of filing claims and having claims filed against it, extension requests, fines and penalties imposed and payments thereof, and contract defaults, with explanations.
- d. The Bidder's compliance with federal, state, and local laws, rules, and regulations, including but not limited to the Occupational Safety and Health Act, Ohio Prevailing Wage laws, Davis Bacon, and Ohio ethics laws.
- e. The Bidder's prior experience with similar work on comparable or more complex projects.



The City of Canton

- f. The number of years the Bidder has been actively engaged as a contractor in the construction industry.
 - g. The Bidder's recent experience record in the construction industry, including the original contract price for each construction job undertaken by the bidder, the amount of any change orders or cost overruns on each job, the reasons for the change orders or cost overruns, and the bidder's record for complying with and meeting completion deadlines on construction projects.
 - h. A public entities' determination, within the previous five years, that the Bidder was not a responsible bidder, the reasons given by the public entity, and the Bidder's explanation thereof.
 - i. The Bidder's financial ability to complete the Contract successfully and on time without resort to its Surety.
 - j. Financial responsibility demonstrated by the Bidder and whether Bidder possesses adequate resources and availability of credit, the means and ability to procure insurance and acceptable performance bonds required for the Project and whether any claims have been made against performance bonds secured by the bidder on other construction projects.
 - k. Any suspension or revocations of any professional license of any director, officer, owner, or managerial employees of the Bidder, to the extent that any work to be performed on this Project is within the field of such licensed profession.
 - l. The Bidder's equipment and facilities.
 - m. The size and experience of the Bidder's work force and the Bidder's ability to complete the Contract successfully and on time.
 - n. The experience and the continuity of the Bidder's work force including the project manager and project superintendent's tenure with the Bidder.
 - o. The Bidder's participation in a drug-free workplace program acceptable to the Owner, and the Bidder's record for both resolved and unresolved findings of the Auditor of State for recovery as defined in Section 9.24 of the Ohio Revised Code.
 - p. The Owner's prior experience with the Bidder's surety.
 - q. The Bidder's interest in the Project as evidenced by its attendance at any pre-bid meetings or conferences for bidders.
 - r. The adequacy, in numbers and experience, of the Bidders' work force to complete the Contract successfully and on time.
 - s. The foregoing information with respect to each of the Subcontractors and Suppliers that the Bidder intends to use on the Project.
4. Qualifications Statement. Each Bidder will submit with its bid a completed Contractor Qualifications Statement, which is included with the Contract Documents, and thereafter provide the Owner promptly with such additional information as the Owner may request regarding the Bidder's qualifications. A Bidder shall submit any requested additional information within three (3) business days of the date on the request.



The City of Canton

5. List of Subcontracted Work Categories. Each Bidder will submit with its bid a completed list of Subcontracted Work Categories, which is included with the Contract Documents, and thereafter provide the Owner promptly with such additional information as the Owner may request regarding the Bidder's qualifications. A Bidder shall submit any requested information within three (3) business days of the date on the request.

6. Additional Criteria for Determining Lowest and Best Bid. Pursuant to the Codified Ordinances of the City of Canton, Chapter 105, the Owner, in its discretion, may consider any or all of the Additional Criteria below in determining which bid is lowest and best.
 - a. Any OSHA violations within the previous three years, as well as all notices of OSHA citations filed against the Bidder in the same three year period, together with a description and explanation of remediation or other steps taken regarding such violations and notices of violation.
 - b. Any violations within the previous five years pertaining to unlawful intimidation or discrimination against any employee by reason of race, creed, color, disability, gender, or national origin, and/or violation of any employee's civil or labor rights or equal employment opportunities.
 - c. Any litigation in which the Bidder has been named as a defendant or third party defendant in an action involving a claim for personal injury or wrongful death arising from performance of work related to any project in which it has been engaged within the previous five years. Bidders shall provide copies of pleadings.
 - d. Allegations of violations of the prevailing wage law and any other state or federal labor law, including, but not limited to, child labor violations, failure to pay wages, or unemployment insurance tax delinquencies or unfair labor practices within the past five years.
 - e. Violations of the workers compensation law.
 - f. Any criminal convictions or criminal indictments, involving the Bidder, its officers, directors, owners, and/or managers within the past five years.
 - g. Any violation within the past five years or pending charges concerning federal, state, or municipal environmental and/or health laws, codes, rules, and/or regulations.
 - h. Documentation that the Bidder provides health insurance and pension benefits to its employees.
 - i. Whether the Bidder participates in a bona fide apprenticeship program that is approved by the Ohio State Apprenticeship Council and the United States Department of Labor.
 - j. Whether the Bidder has adopted and implemented a comprehensive drug and alcohol testing program for its employees.
 - k. Whether the Bidder's employees are OSHA-10 and/or OSHA-30 certified.
 - l. The Bidder's commitment to comply with the Owner's Contract Compliance Program regarding equal employment opportunity. Each Bidder shall file contract employment reports with the Owner's contracting agency or as may be directed by the Owner or its representative. Such contract employment reports shall include such information as to the employment practices, policies, programs, and statistics of the Bidder and shall be in such form as the Owner may prescribe.



The City of Canton

- m. The foregoing information with respect to each of the Subcontractors and Suppliers that the Bidder intends to use on the Project.
7. The failure to submit information that Owner has the right to receive under these Instructions to Bidders on a timely basis may result in the determination that the Bidder has not submitted the lowest and best bid.
8. By submitting its bid, the Bidder agrees that the Owner's determination of which bidder is the lowest and best bidder shall be final and conclusive, and that if the Bidder or any person on its behalf challenges such determination in any legal proceeding, the Bidder will indemnify and hold the Owner and its employees and agents harmless from any claims included or related to such legal proceeding, and from legal fees and expenses incurred by the Owner, its employees, or agents that arise out of or are related to such challenge.
9. After bid opening, within three (3) business days of a request made by the Owner, the apparent low Bidder and any other Bidder so requested by the Owner must submit the following:

For all subcontracts with an estimated value of at least \$50,000, a list of all Subcontractors that the Bidder will use to construct the Project, as well as an indication of whether or not the Bidder has ever worked with a proposed Subcontractor before, including the following information for the three most recent projects on which the Bidder and each Subcontractor have worked together:

- i. Project Owner
- ii. Project Name
- iii. Subcontract Scope
- iv. Subcontract Value
- v. Owner's contact name and phone number.

If Bidder and a proposed Subcontractor have not worked together on at least three projects in the past five years, Bidder must submit the information set forth above for the three most recent similar projects to the Project that a proposed Subcontractor has worked on.

The above Subcontractor information, as well as the criteria set forth in Paragraph I.3 herein, as it pertains to each Subcontractor may be used in the Owner's determination of the lowest and best bid.

Once a Bidder identifies its proposed Subcontractors as set forth in this Paragraph I.9, the list shall not be changed unless written approval or direction for the change is made by Owner.

10. Additional Post-Bid Submittals
 - a) Affidavit as to Personal Property Taxes. The successful Bidder shall submit, prior to the time of the entry into the Contract, an affidavit in the form required by Section 5719.042, Ohio Revised Code, regarding the status of the Bidder's personal property taxes. A copy of the affidavit form is included with the Contract Documents.



The City of Canton

11. The Owner reserves the right to disqualify bids, before or after opening, upon evidence of collusion with intent to defraud or other illegal practices on the part of the Bidder.
12. Award of Contract. The award of the Contract will only be made pursuant to approval of the City's Board of Control.

J. EXECUTION OF CONTRACT

1. Within the time designated by the Owner after award of the Contract, the successful Bidder shall execute and deliver to the Owner the required number of copies of the Owner-Contractor Agreement, in the form included in the Contract Documents, and all accompanying documents requested, including, but not limited to, a Contract Bond (if applicable), insurance certificates, and a valid Workers' Compensation Certificate. The successful Bidder shall have no property interest or rights under the Owner-Contractor Agreement until the Agreement is executed by the Owner.

K. SUBSTITUTIONS/NON-SPECIFIED PRODUCTS

1. Certain brands of material or apparatus may be specified. Should this be the case, each bid will be based on these brands, which may be referred to in the Contract Documents as Standards. The use of another brand (referred to as a substitution or proposed equal in the Contract Documents, when a bidder or the contractor seeks to have a different brand of material or apparatus than that specified approved by the Owner of use in the Project) may be requested as provided herein. Substitutions, however, will not be considered in determining the lowest and best bid.
2. The products specified in the Contract Documents establish a standard of required function, dimension, appearance, and quality.
3. Bidders wishing to obtain approval to bid non-specified products shall submit written requests to the Owner a minimum of seven (7) working days before the bid date and hour. To facilitate the submission of requests, a Substitution Form is included in the Contract Documents. The Bidder shall include the name of the material or equipment for which it is to be substituted and a complete description of the proposed substitution, including the name of the proposed manufacturer and/or product and a complete description of the product including the manufacturer's name and model number or system proposed, drawings, product literature, performance and test data, color selections or limitations, and any other information necessary for evaluation. Include a statement including any changes in other materials, equipment, or other work that would be required if the proposed product is incorporated in the work. The burden of proof of the merit of the proposed product is on the proposer. The Owner's decision on approval of a proposed product will be final.

The following will be cause for rejection of a proposed substitution:

- a. Requests submitted by subcontractors, material suppliers, and individuals other than Bidders;
- b. Requests submitted without adequate documentation;
- c. Requests received after the specified cut-off date;
- d. Requests, which in the sole discretion of the Owner, do not offer a sufficient benefit to the Project.



The City of Canton

4. When the Owner approves a product submission before receipt of bids, the approval will be included in an Addendum, and Bidders may include the pricing of this product in their bid. Bidders shall not rely on approvals made in any other manner.
5. In proposing a non-specified product or a substitution, the Bidder represents and warrants that each proposed product will not result in any changes to the Project, including changes to the Work or other contractors, or any decrease in the performance of any equipment or systems to be installed in the Project and agrees to pay any additional costs incurred by the Owner and the Owner's consultants as a result of a non-specified or substitute product that is accepted.
6. If an addendum is issued approving a substitution for a specified Standard, any Bidder proposed to use said substitution must indicate so with its Bid, using the form provided.
7. Following the award of the Contract, there shall be no substitution for specified products, except pursuant to a Change Order. The Owner in its sole discretion may decline to consider a substitution for a Change Order.
8. The Owner reserves the right to value engineer any item within the specifications if it is deemed to be in the best interest of the Owner.

L. ALTERNATES

1. The Owner may request bids on alternates. At the time of awarding the Contract, the Owner will select or reject alternates as it determines is in its best interest. A Bidder's failure to include on its Bid Form the cost of an alternate selected by the Owner and applicable to the Bidder's work shall render the bid non-responsive and be grounds for the rejection of the bid. Otherwise, the failure to include the cost of an alternate will not be deemed material.
2. The Bidder acknowledges that although there is an estimate for the cost of the Project, the market conditions may and frequently do result in the estimate being different from the sum of the bids received, either higher or lower. The Bidder understands that the Owner may include alternates, which may include deduct alternates as well as add alternates, to give it flexibility to build the Project with the funds available. The Bidder further understands and acknowledges that use of add and deduct alternates is a long held customary practice in the construction industry in the State of Ohio. The Bidder also acknowledges that the Owner will not make a decision about the alternates on which to base the award of contracts until the bids are received, and the Owner can compare its available funds with the base bids and the cost or savings from selecting different alternates. The Bidder understands that the award to the Bidder submitting the lowest and best bid will be based on the base bid plus selected alternates, and may result in an award to a Bidder other than the Bidder that submitted the lowest base bid.

M. UNIT PRICES

1. Where unit prices are requested in the Bid Form the Bidder should quote a unit price. Unless otherwise expressly provided in the Contract Documents, such unit prices shall include all labor, materials, and services necessary for the timely and proper installation of the item for which the unit prices are requested. The unit prices quoted in the bid shall be the basis for any Change Orders entered into under the Owner-Contractor Agreement, unless the Owner determines that the use of such unit prices will cause substantial inequity to either the Contractor or the Owner.



The City of Canton

N. ADDENDA

1. All questions should be submitted in writing at least five (5) business days prior to the bid opening. **This is 3/10/2021, 2:00:00 PM.** The Owner reserves the right to issue Addenda changing, altering, or supplementing the Contract Documents prior to the time set for receiving bids. The Owner will issue the Addenda to clarify bidders' questions and/or to change, alter, or supplement the Contract Documents..
2. Any explanation, interpretation, correction, or modification of the Contract Documents will be issued in writing in the form of an Addendum, which shall be the only means considered binding; explanations, interpretations, etc., made by any other means shall **NOT** be legally binding. All Addenda shall become a part of the Contract Documents.
3. All Addenda will be issued, except as hereafter provided, via the current City bid tool at least seventy-two (72) hours prior to the published time for the opening of bids, excluding Saturdays, Sundays, and legal holidays. If any Addendum is issued within such seventy-two (72) hour period, then the time for opening of bids shall be extended one (1) week with no further advertising of bids required.
4. Copies of each Addendum will be posted via the Owner's current bid tool and it is the responsibility of the bidder or any other interested party to check the bid tool for any updates or addenda. Receipt of Addenda shall be indicated by Bidders in the space provided on the Bid Form. Bidders are responsible for acquiring issued Addenda in time to incorporate them into their bid. Bidders should check the Owner's bid tool prior to the bid opening to verify the number of Addenda issued.
5. Each Bidder shall carefully read and review the Contract Documents and immediately bring to the attention of the Owner any error, omission, inconsistency, or ambiguity therein.
6. If a Bidder fails to indicate receipt of all Addenda through the last Addendum issued by the Owner on its Bid Form, the bid of such Bidder will be deemed to be responsive only if:
 - a. The bid received clearly indicates that the Bidder received the Addendum, such as where the Addendum added another item to be bid upon and the Bidder submitted a bid on that item; or
 - b. The Addendum involves only a matter of form or is one which has either no effect or has merely a trivial or negligible effect on price, quantity, quality, or delivery of the item bid upon.

O. INTERPRETATION

1. If a Bidder contemplating submitting a bid for the proposed Project is in doubt as to the true meaning of any part of the Contract Documents, it may submit a written request for an interpretation thereof to the Owner at purchasing@cantonohio.gov. Requests received fewer than 5 days prior to bid opening may not be answered. Any interpretation of the proposed documents will be made by Addendum only and will be made available by the City's web tool. The Owner will not be responsible for any other explanation or interpretation of the proposed documents.
2. In interpreting the Contract Documents, words describing materials that have a well-known technical or trade meaning, unless otherwise specifically defined in the Contract Documents, shall be construed in accordance with the well-known meaning recognized by the trade.



The City of Canton

3. Bidders are responsible for notifying the Owner in a timely manner of any ambiguities, inconsistencies, errors, or omissions in the Contract Documents. The Bidder shall not, at any time after the execution of the Contract, be compensated for a claim alleging insufficient data, incomplete Contract Documents, or incorrectly assumed conditions regarding the nature or character of the Work, if no request was made by the Bidder prior to the bid opening.

P. STATE SALES AND USE TAXES

1. The Owner is a political subdivision of the State of Ohio and is exempt from taxation under the Ohio Sales Tax and Use Tax Laws. Building materials that the successful Bidder purchases for incorporation into the Project will be exempt from state sales and use taxes if the successful Bidder provides a properly completed Ohio Department of Taxation Construction Contract Exemption Certificate to the vendors or suppliers when the materials are acquired. The Owner will execute properly completed certificates on request.

Q. DATE FOR SUBSTANTIAL COMPLETION/DATE FOR FINAL COMPLETION/LIQUIDATED DAMAGES

1. Dates for Substantial Completion. The Contract Time shall run from the date of the Notice to Proceed or if there is no Notice to Proceed from the Effective Date of the Owner-Contractor Agreement. The Date for Substantial Completion and the Contract Time may be extended only by Change Order. **By submitting its Bid, each Bidder agrees that the period for performing its Work is reasonable.**
 - a. Date for Overall Project Substantial Completion. The successful Bidder shall have all of its Work on the Project Substantially Complete (as Substantial Completion is defined in the Contract Documents) by the following date as applicable to the Bidder's scope of work.

Date for Substantial Completion (aka Contract Time) expressed as calendar days from Notice to Proceed:

48 calendar days

****Please note that the contractor cannot begin construction prior to 5/3/2021.**

2. Liquidated Damages.
 - a. Overall Project Substantial Completion. If the successful Bidder does not have its Work Substantially Complete by its Date for Substantial Completion or Finally Complete within thirty (30) calendar days of achieving Substantial Completion, whichever may be applicable, the successful Bidder shall pay the Owner and the Owner may set off from amounts otherwise due the successful Bidder Liquidated Damages. The daily amounts of Liquidated Damages for Overall Project Substantial Completion are set forth in the tables included in the Owner-Contractor Agreement. The total amount of Liquidated Damages will be calculated based on the total number of calendar days beyond the Date for Substantial Completion that the Bidder's Work is not Substantially Complete or to the extent that its Work is not Finally Complete more than thirty (30) calendar days after the Substantial Completion of its Work, i.e., number of late days times the per diem rate(s) for Liquidated Damages in the tables.
3. The Bidder acknowledges and agrees, by submitting its bid for the Work and entering into a Contract with the Owner, that such amounts of Liquidated Damages represent a



The City of Canton

reasonable estimate of the actual damages for loss of or interference with the intended use of the Project that the Owner would incur if the Bidder's Work is not Substantially Complete by its Date for Substantial Completion and/or not Finally Complete by thirty (30) days of the Date of Substantial Completion. The Bidder further acknowledges, agrees and understands that it may seek an extension of the Contract Time (and its Date for Substantial Completion) to avoid or reduce Liquidated Damages by properly following the Claim procedures in the Contract Documents.

R. OWNER'S RIGHT TO WAIVE DEFECTS AND IRREGULARITIES

1. The Owner reserves the right to waive any and all irregularities provided that the defects and irregularities do not affect the amount of the bid in any material respect or otherwise give the Bidder a competitive advantage.

S. MODIFICATION/WITHDRAWAL OF BIDS

1. Modification. A Bidder may modify its bid by written communication to the Owner at any time prior to the scheduled closing time for receipt of bids, provided such written communication is received by Owner prior to the bid deadline. The written communication shall not reveal the bid price, but should provide the addition or subtraction or other modification so that the final prices or terms will not be known until the sealed bid is opened. If the Bidder's written instructions with the change in bid reveal the bid amount in any way prior to the bid opening, the bid may be rejected as non-responsive.
2. Withdrawal Prior to Bid Deadline. A Bidder may withdraw its bid at any time for any reason prior to the bid deadline for the opening of bids established in the Legal Notice. The request to withdraw shall be made in writing to and received by the Owner prior to the time of the bid opening.
3. Withdrawal after Bid Deadline.
 - a. All bids shall remain valid and open for acceptance for a period of at least 60 days after the bid opening; provided, however, that a Bidder may withdraw its bid from consideration after the bid deadline when all of the following apply:
 - (1) the price bid was substantially lower than the other bids;
 - (2) the reason for the bid being substantially lower was a clerical mistake, rather than a mistake in judgment, and was due to an unintentional and substantial error in arithmetic or an unintentional omission of a substantial quantity of work, labor, or material;
 - (3) the bid was submitted in good faith; and
 - (4) the Bidder provides written notice to the Owner within two (2) business days after the bid opening for which the right to withdraw is claimed.
 - b. No bid may be withdrawn under this provision if the result would be the awarding of the contract on another bid for the bid package from which the Bidder is withdrawing its bid to the same Bidder.
 - c. If a bid is withdrawn under this provision, the Owner may award the Contract to another Bidder determined by the Owner to be the lowest and best bidder or the Owner may reject all bids and advertise for other bids. In the event the Owner advertises for other bids, the withdrawing Bidder shall pay the costs incurred in connection with the rebidding by the Owner, including the cost of printing new



The City of Canton

Contract Documents, required advertising, and printing and mailing notices to prospective bidders, if the Owner finds that such costs would not have been incurred but for such withdrawal.

T. COMPLIANCE WITH APPLICABLE LAWS

1. By submitting a bid for Work on the Project, the Bidder acknowledges that it is in compliance with applicable federal, state, and local laws and regulations, including, but not limited to, the following:
 - a. Equal Employment Opportunity/Nondiscrimination. The Bidder agrees that if it is awarded a contract that in the hiring of employees for performance of work under the contract or any subcontract, neither it nor any subcontractor, or any person acting on its behalf or its subcontractor's behalf, by reason of race, creed, sex, disability as defined in Section 4112.01 of the Ohio Revised Code, or color, shall discriminate against any citizen of the state in the employment of labor or workers who are qualified and available to perform work to which the employment relates. The Bidder further agrees that neither it nor any subcontractor or any person on its behalf or on behalf of any subcontractor, in any manner, shall discriminate against or intimidate any employees hired for the performance of the work under the contract on account of race, creed, sex, disability as defined in Section 4112.01 of the Ohio Revised Code, or color.
 - b. Ethics Laws. The Bidder represents that it is familiar with all applicable ethics law requirements, including without limitation Sections 102.04 and 3517.13 of the Ohio Revised Code, and certifies that it is in compliance with such requirements.

U. FINDINGS FOR RECOVERY

1. By submitting its bid, each Bidder certifies for reliance of the Owner that it has no unresolved finding for recovery against it issued by the Auditor of the State of Ohio on or after January 1, 2001, except as permitted by Section 9.24 (F) of the Ohio Revised Code.

V. PREVAILING WAGES

1. The Project is a "Construction" project as defined in Section 4115.03 of the Ohio Revised Code. If the Project is defined as such as "Construction" project, the successful Bidder and all of its subcontractors, regardless of tier, will strictly comply with its obligation to pay a rate of wages on the Project not less than the rate of wages fixed for this Project under Section 4115.04 of the Ohio Revised Code. Additionally, the successful Bidder will comply with all other provisions of Chapter 4115 of the Ohio Revised Code.

W. DBE PARTICIPATION GOALS

1. Owner has established the following Disadvantaged Business Enterprise ("DBE") participation goal for the Project as a percentage of the Contract Price:

10%

2. Any Minority Business Enterprise ("MBE") or Woman-Owned Business Enterprise ("WBE") proposed to count towards the DBE participation goal must first be certified at bid time as an MBE or WBE under the Ohio Department of Administrative Services MBE Cross Certification Program (which includes MBEs and WBEs certified by the City of Canton), or certified as a DBE under Ohio's Unified Certification Program administered by the Ohio Department of Transportation.



The City of Canton

3. Documentation of DBE Participation. Each Bidder must submit with its bid a list identifying its DBE subcontractors and participation rates as a percentage of the Contract Price.
4. Certification of Good Faith Efforts. If a Bidder has not met the DBE participation goal, it must attach to its bid, a narrative (which may include exhibits) demonstrating the good faith efforts made by the Bidder to secure DBE participation in the Project. Good faith efforts include:
 - Conducting outreach and recruiting activities;
 - Informing DBEs of the opportunity to participate in the Project at least 30 calendar days before the bid closes;
 - Considering subcontracting with a consortium of DBEs; and
 - Using the services and assistance of the Small Business Administration and Minority Development Agency of the U.S. Department of Commerce.

Owner, in its sole discretion, will be the sole evaluator of whether any particular Bidders' efforts sufficiently demonstrate good faith efforts for securing DBE participation.
5. Challenges to Owner's Discretion. If any Bidder directly challenges, or indirectly challenges through contribution of money or other resources to a third party, Owner's discretion in determining any Bidder's compliance with the DBE goal stated in these Instructions to Bidders, or good faith efforts pertaining to same, that Bidder agrees to indemnify Owner for all claims, costs, losses and damages, including attorney and consultant fees, arising out of such challenge, should there be an adjudication by a court of competent jurisdiction that the Owner did not abuse its discretion in making its determination.
6. Failure to Comply. If a Bidder is awarded a contract for the Project, and later fails to fulfill its stated DBE participation goals, that Bidder agrees to indemnify Owner for all claims, costs, losses and damages, including attorney and consultant fees, arising out of such failure. That Bidder also agrees to cooperate with all reasonable requests to determine actual DBE participation, including but not limited to certifying actual participation and providing documentation in support of same.

X. OTHER LOCAL ORDINANCE REQUIREMENTS

1. Each Bidder, by the act of submitting its bid agrees to withhold all City income taxes due or payable under Chapter 182 of the Codified Ordinances of the City of Canton for wages, salaries, fees, and commissions paid to its employees and further agrees that any of its subcontractors shall be required to agree to withhold any such City income taxes due for services performed under this Agreement. Bidder agrees with the Owner regarding the manner of withholding of City income taxes as provided in Section 718.011(F) of the Ohio Revised Code. Municipal income tax withholding provisions of Section 718.011(B)(1) and 718.011(D) of the Ohio Revised Code shall not apply to qualifying wages paid to employees for work done or services performed or rendered inside the City or on City property. Each Bidder agrees to withhold income tax for the City from employees' qualifying wages earned inside the City or on City property, beginning with the first day of work done or services performed or rendered inside the City.
2. Each Bidder, by the act of submitting its bid agrees that all steel necessary in the construction of the Work performed under the Agreement shall be steel that is produced in the United States unless a specific product which is required is not produced by manufacturers in the United States in which event this prohibition does not apply.



The City of Canton

3. Each Bidder, by the act of submitting its bid agrees that all materials used in the construction covered by the Agreement shall be purchased in the Canton area except such materials which are unavailable in the Canton area.
4. Chapter 105.12 – Local Bidder Preference.
 - a. The Board of Control, in determining the lowest and best bidder in the award of contracts to which this section is applicable, is authorized to award contracts to local bidders as hereinafter defined, whose bid is not more than five percent (5%) higher, subject to a maximum amount of twenty thousand dollars (\$20,000.00), than the lowest dollar bid submitted by non-local bidders. The Board of Control's decision in making such an award shall be final.
 - b. For purposes of this section, "local bidder" means an individual or business entity which at the time of the award of the contract has a headquarters, division, sales office, sales outlet, manufacturing facility, or similar significant business-related location in Stark County, Ohio.
 - c. All contract specifications and/or bid documents that are distributed by Canton for the purpose of soliciting bids for goods and/or services shall contain the following notice:

Prospective bidders will take notice that the City of Canton, in determining the lowest and best bidder in the award of this contract, may award a local bidder preference to any qualified bidder pursuant to Section 105.12 of the Codified Ordinances of the City of Canton. The determination of whether a bidder qualifies for the local preference shall be made by Board of Control. The Board's decision shall be final. A copy of Section 105.12 is attached.
 - d. This section shall be applicable to all contracts for equipment, goods, machinery, materials, supplies, vehicles and/or services, which are purchased, leased and/or constructed at a cost in excess of fifty thousand dollars (\$50,000.00) and which require bidding pursuant to Ohio R.C. 735.05 through 735.09 and Ohio R.C. 737.03. (Ord. 115-2018. Passed 5-14-18.)
5. Each Bidder, by the act of submitting its bid agrees as follows during the performance of the Agreement:
 - a. The Contractor shall not discriminate against any employee or applicant for employment because of race, age, handicap, religion, color, sex, national origin, sexual orientation, or gender identity. The Contractor shall take affirmative action to insure that applicants are employed and that employees are treated during employment without regard to race, religion, color, sex, national origin, military status, sexual orientation, or gender identity. As used herein, the word "treated" shall mean and include without limitation the following: recruited, whether by advertising or other means; compensation, whether in the form of rates or pay or other forms of compensation; selected for training, including apprenticeship; promoted; demoted; upgraded; downgraded; transferred; laid off; and terminated. The Contractor agrees to and shall post in conspicuous places available to employees and applicants for employment notices to be provided by the contracting officers setting forth the provisions of this nondiscrimination clause.
 - b. The Contractor shall, in all solicitations or advertisements for employees placed by or on behalf of the Contractor, state that all qualified applicants will receive consideration for employment without regard to race, age, handicap, religion, color, sex, national origin, military status, sexual orientation, or gender identity.



The City of Canton

- c. The Contractor shall send to each labor union or representative of workers, with which he has a collective bargaining agreement or other contract or understanding, a notice advising the labor union or workers' representative of the Contractor's commitments under the equal opportunity clause of the Owner; and it shall post copies of the notice in conspicuous places available to employees and applicants for employment.
- d. The Contractor shall submit in writing to the Owner its affirmative action plan, and each subcontractor and supplier of equipment or supplies shall submit to the Contractor its affirmative action plan. The responsibility for securing these affirmative action plans falls upon the Contractor and shall be on file at the office of the Contractor. The Contractor shall furnish all information and reports required by the Owner or its representative pursuant to the Contract Documents, and shall permit access to its books, records, and accounts by the contracting agency of the Owner and by the Executive Secretary of the Owner for purposes of investigation to ascertain compliance with the program.
- e. The Contractor shall take such action with respect to any subcontractor as the Owner may direct as a means of enforcing the provisions of this equal opportunity clause, including penalties and sanctions for noncompliance; provided, however, that in the event the Contractor becomes involved in or is threatened with litigation as is necessary to protect the interests of the Owner and to effectuate the Owner's equal opportunity program and, in the case of contracts receiving Federal assistance, the Contractor or the Owner may request the United States to enter into such litigation to protect the interests of the United States.
- f. The Contractor shall file and shall cause its subcontractors, if any, to file compliance reports with the Owner in the form and to the extent prescribed by the Owner or its representative. Compliance reports filed at such times as directed shall contain information as to the employment practices, policies, programs, and statistics of the Contractor and its subcontractors.
- g. The Contractor shall include the provisions of this equal employment opportunity clause in every subcontract or purchase order, so that such provisions will be binding upon each subcontractor or vendor.
- h. Refusal by the Contractor or subcontractor to comply with any portion of this program as herein stated and described will subject the offending party to any or all of the following penalties:
 - (1) Withholding of all future payments under the involved public contract to the Contractor in violation, until it is determined that the Contractor or subcontractor is in compliance with the provisions of the Agreement.
 - (2) Refusal of all future bids for any public contract with the Owner or any of its departments or divisions, until such time as the Contractor or subcontractor demonstrates that it has established and shall carry out the policies of the program as herein outlined.
 - (3) Cancellation of the public contract and declaration of forfeiture of the performance bond.
 - (4) In cases in which there is substantial or material violation or the threat of substantial or material violation of the compliance procedure or as may be provided by contract, appropriate proceedings may be brought to



The City of Canton

enforce these provisions, including enjoining within applicable laws of contractors, subcontractors, or other organizations, individuals, or groups who prevent, directly or indirectly, or seek to prevent, directly or indirectly, compliance with the policy as herein outlined.

2. A Project Labor Agreement (PLA) is not required for this project. Prevailing Wages are required for this Project (See Appendix B).

Y. OHIO PUBLIC WORKS COMMISSION FUNDING

1. No When this line is checked by the Owner, e.g. with an "X" or other mark, the Project is being funded in whole or part by the Ohio Public Works Commission ("OPWC"), and the requirements of the OPWC, attached to these Instructions to Bidders, apply.
2. The OPWC requirements include that the Bidder include with its bid certification of agreement and compliance with certain statements and covenants regarding its subscription to the State's Equal Employment Opportunity Requirements for State-assisted Construction Contracts.

END OF INSTRUCTIONS TO BIDDERS



The City of Canton

OWNER-CONTRACTOR AGREEMENT

[Where Owner Performs Construction Administration Duties]

Owner:

The City of Canton
218 Cleveland Avenue SW
Canton, OH 44702
Telephone: 330.489.3283

Contract: _____

Ordinance: 220/2020

Alternates: _____

Contractor:

_____, _____ 0

Telephone: _____

Fax: _____

Project:

12th St. NW Water Main Replacement (TAG 617)

This document is an agreement between the Owner and the Contractor for the Work described in the Contract Documents related to the Contract identified above for the Project defined above and is effective as of the date the Agreement is signed by the Owner (the "Effective Date").

The Owner and the Contractor agree as set forth in the following sections:

1. CONTRACT DOCUMENTS. The Contract Documents consist of the following documents:

- A. Legal Notice;
- B. Instructions to Bidders;
- C. Bid Form;
- D. Owner-Contractor Agreement;
- E. General Conditions of the Contract for Construction (EJCDC C-700), as modified;
- F. Supplementary Conditions (when applicable);
- G. Drawings;
- H. Specifications;
- I. Addenda issued;
- J. Contractor's Personal Property Tax Affidavit (O.R.C. 5719.042);
- K. Statement of Claim Form; and
- L. Modifications issued after the execution of the contract, including:
 - i. A Change Order;
 - ii. A Work Change Directive; or,
 - iii. A written order for a minor change of the Work issued by the Owner or Engineer in accordance with the General Conditions.
- M. When this line is checked by the Owner, e.g. with an "X" or other mark, the State of Ohio Department of Transportation, Construction and Material Specifications, effective as of January 1, 2019, will be a Contract Document, but only as modified by the document titled *ODOT Manual Supplement*, prepared by Owner.

1.1 Notwithstanding anything in the Contract Documents to the contrary, in the event of any inconsistency, the provisions of this Agreement shall control over any other Contract Document, proposal, document, or other attachment. In the event inconsistencies, conflicts, or ambiguities between or among the Contract Documents are discovered after execution of the Agreement, Contractor shall provide the better quality or greater quantity of Work or comply with the more stringent requirements.



Note: Non-Contract Documents. The following are the reports and tests of subsurface conditions at or contiguous to the Site, if any, that the Engineer has used in preparing the Contract Documents. These are not Contract Documents. Geotechnical data is not a warranty of subsurface conditions and is not to be relied upon as a complete representation of all possible soil conditions. It is possible that there may be other reports, and/or tests of subsurface conditions at or contiguous to the Site not prepared by or on behalf of Owner. The Owner makes no representation about such reports and/or tests, assuming they exist. Additional information, if needed by Contractor for geotechnical data or site survey, shall be obtained by the Contractor at no additional cost to Owner. The General Conditions, as modified, contain additional terms related to these reports and tests.

Contractor may rely upon the general accuracy of the "technical data" contained in such reports and drawings listed below, and except for such reliance on "technical data," Contractor shall not rely upon or make any claim against Owner or Engineer with respect to: (1) the completeness of such reports and drawings for Contractor's purposes, including, but not limited to, any aspects of the means, methods, techniques, sequences, and procedures of construction to be employed by Contractor, and safety precautions and programs incident thereto; or (2) other data, interpretations, opinions, and information contained in such reports or shown or indicated in such drawings; or (3) any Contractor interpretation of or conclusion drawn from any "technical data" or any such other data, interpretations, opinions, or information. For example, all interpolations and extrapolations of data performed by Contractor to estimate locations or quantities of subsurface strata are independent factual assumptions which Owner does not warrant. (Not applicable, if none are listed).

Note: Non-Contract Documents. The following are those reports and drawings related to any Hazardous Conditions at the Site, if any. These are not Contract Documents. The General Conditions, as modified, contain additional terms related to these reports and drawings. (None if none are listed).

2. ENGINEER RELATIONSHIP. The Contract Documents shall not be construed to create a contractual relationship of any kind between the Engineer and the Contractor or any Subcontractor or Material Supplier to the Project. The Engineer, however, shall be entitled to performance of the obligations of the Contractor intended for its benefit and to enforcement of such obligations, but nothing contained herein shall be deemed to give the Contractor or any third party any claim or right of action against the Engineer that does not otherwise exist without regard to this Contract. The Contractor and its Subcontractors shall not be deemed to be beneficiaries of any of the acts or services of the Engineer that are performed for the sole benefit of the Owner.

Owner will be performing construction administration duties as identified in the General Conditions, including, but not limited to: reviewing Applications for Payment, Change Proposals, Claims, and Shop Drawings; measuring Work quantities; and issuing Work Change Directives.

2.1 The Engineer is:
Dylan Peoples
dylan.peoples@cantonohio.gov
330-438-6564



3. TIME FOR COMPLETION AND PROJECT COORDINATION.

3.1 DATE OF COMMENCEMENT. The date of commencement of the Work shall be the date identified in the Notice to Proceed issued by the Owner, or by the Owner through the Engineer, to the Contractor, or if there is no Notice to Proceed, the Effective Date of this Agreement.

3.2 DATE OF SUBSTANTIAL COMPLETION. The Project and Work for the Project consists of all labor, materials, equipment, and services necessary for construction of the Project, all in accordance with the Drawings and Specifications prepared by the Owner or Engineer. The Contractor shall achieve Substantial Completion of its Work on the Project, as defined in the General Conditions, within **48 calendar days** of the Date of Commencement (“Date of Substantial Completion”). Substantial Completion is the time at which the Work has progressed to the point where the Work is sufficiently complete, in accordance with the Contract Documents, so that the Work can be utilized for the purposes for which it is intended.

3.2.1 DATE OF FINAL COMPLETION. The Contractor shall achieve Final Completion of its Work on the Project, as defined in the General Conditions, within **30 calendar days** of the Date of Substantial Completion (“Date of Final Completion”). Final Completion shall mean that the Work is complete in accordance with the Contract Documents and the Contractor has submitted to the Owner or Engineer all documents required to be submitted to the Owner or Engineer for final payment.

3.2.2 UTILITIES AND OPERATIONS. Contractor shall not interrupt utilities to facilities or existing operations without prior written notice and approval by Owner.

3.2.3 SHUTDOWN DATES. Due to events scheduled by the Owner and/or other Owner considerations, Contractor will not be able to perform Work on the Project on the following dates (there are no shutdown dates if none are listed):

Contractor’s Construction Schedule for performing the Work shall account for Contractor not being able to perform Work on these dates and the contractual dates for Substantial Completion and Final Completion will not be changed due to Contractor not being able to perform Work on these dates.

3.3 CONSTRUCTION SCHEDULE. The Construction Schedule shall be developed by the Contractor as provided in the Contract Documents.

3.4 LIQUIDATED DAMAGES. If the Contractor does not have its Work on the Project Substantially Complete by the specified Date for Substantial Completion or Finally Complete by the Date of Final Completion, the Contractor shall pay the Owner (and the Owner may set off from sums coming due the Contractor) Liquidated Damages in the per diem amounts as set forth in the following tables, whichever may be applicable. “Contract Amount” of the Work will be determined by totaling the cost of all line items of Work.

LIQUIDATED DAMAGES – DATE FOR SUBSTANTIAL COMPLETION OF OVERALL PROJECT

<u>Original Contract Amount</u>	<u>Dollars Per Day</u>
\$1.00 to \$500,000.00	\$ 750.00
\$500,000.01 to \$2,000,000.00	\$ 1,000.00
\$2,000,000.01 to \$10,000,000.00	\$ 1,300.00
\$10,000,000.01 to \$50,000,000.00	\$ 2,000.00
\$50,000,000.01 and greater	\$ 2,500.00



LIQUIDATED DAMAGES – FINAL COMPLETION

<u>Original Contract Amount</u>	<u>Dollars Per Day</u>
\$1.00 to \$500,000.00	\$ 200.00
\$500,000.01 to \$2,000,000.00	\$ 250.00
\$2,000,000.01 to \$10,000,000.00	\$ 325.00
\$10,000,000.01 to \$50,000,000.00	\$ 500.00
\$50,000,000.01 and greater	\$ 625.00

LIQUIDATED DAMAGES FOR SUBSTANTIAL COMPLETION FOR ANY INTERIM MILESTONE SCOPE WILL BE \$1,000 PER DAY FOR EACH DAY OF UNEXCUSED DELAY BEYOND THE MILESTONE.

The Contractor acknowledges that such amounts of Liquidated Damages represent a reasonable estimate of the actual damages for loss of or interference with the intended use of the Project that the Owner would incur if the Contractor’s Work is not Substantially Complete by its Date for Substantial Completion or Finally Complete by the required date for Final Completion.

4. CONTRACT SUM (also called Contract Price). The Contract Sum to be paid by the Owner to the Contractor, as provided herein, for the satisfactory performance and completion of the Work and all of the duties, obligations, and responsibilities of the Contractor under this Agreement and the other Contract Documents is **\$0.00**, subject to adjustment as set forth in the Contract Documents. The Contract Sum includes Allowances, Accepted Alternates, and all federal, state, county, municipal, and other taxes imposed by law, including but not limited to any sales, use, commercial activity, and personal property taxes payable by or levied against the Contractor on account of the Work or the materials incorporated into the Work. The Contractor will pay any such taxes. The Contract Sum includes the following:

4.1 Base Bid Amount: **\$0.00** (Lump Sum Bid); and

4.2 Accepted Alternates, included in the Contract Sum:

Alternate No.	Description	Amount
1	NA	\$ _____
2	NA	\$ _____

4.3 Allowances included in the Contract Sum:

Allowance Description	Amount
Allowance #1: NA	\$ _____
Allowance #2: NA	\$ _____

4.4 If after Substantial Completion of its Work, the Contractor fails to submit its final payment application with all the documents required to be submitted with such application within ninety (90) days after written notice to do so from the Owner and without prejudice to any other rights and remedies the Owner may have available to it, the balance of the Contract Sum shall become the Owner’s sole and exclusive property, and the Contractor shall have no further interest in or right to such balance.

5. RETAINAGE. Retainage applicable to the Contract by Ohio Revised Code Sections 153.12, .13, and .14 will be withheld as defined in the Modified General Conditions. The Contractor agrees that the financial institution selected by the Owner for deposit of retained funds is acceptable to the Contractor and will sign any documents requested related to said account.



The City of Canton

6. GENERAL.

6.1 MODIFICATION. No modification or waiver of any of the terms of this Agreement or of any other Contract Documents will be effective against a party unless set forth in writing and signed by or on behalf of a party. In the case of the Owner, the person executing the modification or waiver must have express authority to execute the Modification on behalf of the Owner pursuant to a resolution that is duly adopted by the Owner. Under no circumstances will forbearance, including the failure or repeated failure to insist upon compliance with the terms of the Contract Documents, constitute the waiver or modification of any such terms. The parties acknowledge that no person has authority to modify this Agreement or the other Contract Documents or to waive any of its or their terms, except as expressly provided in this section.

6.2 ASSIGNMENT. The Contractor may not assign this Agreement without the written consent of the Owner, which the Owner may withhold in its sole discretion.

6.3 LAW AND JURISDICTION. All questions regarding the validity, intention, or meaning of this Agreement or any modifications of it relating to the rights and obligation of the parties will be construed and resolved under the laws of the State of Ohio. Any suit, which may be brought to enforce any provision of this Agreement or any remedy with respect hereto, shall be brought in the Common Pleas Court of the county in which the Project is located and each party hereby expressly consents to the exclusive jurisdiction of such court to the exclusion of any other court, including any U.S. District Court or any other federal court.

6.4 CONSTRUCTION. The parties acknowledge that each party has reviewed this Agreement and the other Contract Documents and entered into this Agreement as a free and voluntary act. Accordingly, the normal rule of construction to the effect that any ambiguities are to be resolved against the drafting party will not be employed in the interpretation of this Agreement, the other Contract Documents, or any amendments or exhibits to it or them.

6.5 APPROVALS. Except as expressly provided herein, the approvals and determinations of the Owner and Engineer will be subject to the sole discretion of the respective party and be valid and binding on the Contractor, provided only that they be made in good faith, i.e., honestly. If the Contractor challenges any such approval or determination, the Contractor has the burden of proving that it was not made in good faith by clear and convincing evidence.

6.6 PARTIAL INVALIDITY. If any term or provision of this Agreement is found to be illegal, unenforceable, or in violation of any laws, statutes, ordinances, or regulations of any public authority having jurisdiction, then, notwithstanding such term or provision, this Agreement will remain in full force and effect and such term will be deemed stricken; provided this Agreement will be interpreted, when possible, so as to reflect the intentions of the parties as indicated by any such stricken term or provision.

6.7 COMPLIANCE WITH LAWS AND REGULATIONS. The Contractor, at its expense, will comply with all applicable federal, state, and local laws, rules, and regulations applicable to the Work, including but not limited to Chapter 4115 of the Ohio Revised Code and Sections 153.59 and 153.60 of the Ohio Revised Code, which prohibit discrimination in the hiring and treatment of employees, with respect to which the Contractor agrees to comply and to require its subcontractors to comply.

6.7.1 NON-DISCRIMINATION. Contractor agrees:

- .1 That in the hiring of employees for the performance of Work under this Agreement or in any subcontract, neither the Contractor, subcontractor, or any person acting on behalf of either of them, shall by reason of race, creed, sex, disability as defined in Section 4112.01 of the Ohio Revised Code, or color discriminate against any citizen of the state in the employment of labor or workers who are qualified and available to perform the Work to which the employment relates.
- .2 That neither the Contractor, subcontractor, nor any person acting on behalf of either of them shall, in any manner, discriminate against or intimidate any employee hired for the performance of Work under this Agreement on account of race, creed, sex, disability as defined in Section 4112.01 of the Ohio Revised Code, or color.



The City of Canton

- .3 That there shall be deducted from the amount payable to the Contractor by the Owner under this Agreement a forfeiture of twenty-five dollars (\$25.00) as required by Ohio Revised Code Section 153.60 for each person who is discriminated against or intimidated in violation of this Agreement.
- .4 That this Agreement may be canceled or terminated by the Owner and all money to become due hereunder may be forfeited for a second or subsequent violation of the terms of this section of this Agreement.

6.7.2 PREVAILING WAGE RATES. The Contractor and its subcontractors, regardless of tier, shall strictly comply with their obligation, if any, to pay their employees working on the Project site at the applicable prevailing wage rates for the type of work, including any changes thereto, pursuant to Ohio Revised Code Chapter 4115.

6.7.3 ETHICS. By signing and entering into this agreement with the Owner, the Contractor represents that it is familiar with all applicable ethics law requirements, including without limitation Sections 102.04 and 3517.13 of the Ohio Revised Code, and certifies that it is in compliance with such requirements. The Contractor understands that failure to comply with the ethics laws is, in itself, grounds for termination of this contract and may result in the loss of other contracts with the Owner.

6.8 JOB MEETINGS. The Contractor or one of its representatives with authority to bind the Contractor will attend all job meetings. The Owner anticipates that job meetings will be scheduled on a weekly basis during construction or as needed. The Contractor will ensure that its Subcontractors also hold regular job meetings at which safety issues and job matters are discussed as these relate to the Work being performed. Job meetings include, but are not limited to, pre-construction meetings, weekly job meetings, weekly safety tool box meetings, and monthly safety meetings.

6.9 PROPERTY TAX AFFIDAVIT. The Contractor's affidavit given under Section 5719.024, Ohio Revised Code, is incorporated herein.

6.10 WARRANTIES. Notwithstanding anything to the contrary in the Contract Documents, including the Project Manual and Specifications, no warranties by Contractor shall be limited to any time shorter than the statute of limitations for written contracts in Ohio.

6.11 CONTRACTOR ATTESTATIONS.

- .1 Contractor attests that it has not scaled these contract documents to determine quantities for bids, as Contractor has field verified and taken its own dimensions to determine the quantities for its bid.
- .2 Contractor agrees that all the scales noted on the drawings are correct; so as to give it an "intent" of what is to be bid. Contractor has not relied on any other dimensions than what are noted in text and dimension lines.
- .3 Contractor has thoroughly read the Contract Documents and has asked any and all questions it has on the intent of the scope of work, or supposed errors and omissions contained in these drawings, during the bid process and prior to signing this Agreement.
- .4 Contractor will not be asserting a claim for additional time or money associated with the three issues listed above.
- .5 Contractor believes it has accurately interpreted the Contract Documents and has asked for clarification and received satisfactory response for all items not thoroughly addressed or appeared to be conflicting in the Contract Documents and has found all stipulations and requirements contained in this Agreement are as stated in the bid specifications and are enforceable according to Ohio Law, including but not limited to the Owner's right of offset, and the Owner's right to assess liquidated damages for work not completed according to the milestones listed on the project schedule contained in the Contract Documents.



The City of Canton

6.12 ENTIRE AGREEMENT. This Agreement and the other Contract Documents constitute the entire agreement among the parties with respect to their subject matter and will supersede all prior and contemporaneous, oral or written, agreements, negotiations, communications, representations, and understandings with respect to such subject matter, and no person is justified in relying on such agreements, negotiations, communications, representations, or understandings.

IN WITNESS WHEREOF, the parties have caused this Agreement to be executed by their properly authorized representatives and agree that this Agreement is effective as of the date first set forth above.

Owner:
The City of Canton

By: _____

Name: _____

Title: _____

Date: _____

Contractor:

By: _____

Name: _____

Title: _____

Date: _____



The City of Canton

CERTIFICATE
(Section 5705.41, R.C.)

The undersigned, fiscal officer of the Owner, certifies that the moneys required to pay that part of the Contract Sum coming due during the current fiscal year, under the Agreement to which this Certificate is attached have been lawfully appropriated for such purpose and are in the appropriate account of the Owner, or in the process of collection to the credit of the appropriate account or fund, free from any previous encumbrances. Moneys due in excess of the Contract Sum shall require an additional and separate Fiscal Officer's Certificate.

DATED: _____

Fiscal Officer



The City of Canton

BID GUARANTY AND CONTRACT BOND

(O.R.C. § 153.571)

KNOW ALL PERSONS BY THESE PRESENTS, that we, the undersigned _____ ("Contractor") as principal and _____ as surety are hereby held and firmly bound unto the **City of Canton** as obligee in the penal sum of the dollar amount of the bid submitted by the principal to the obligee on _____, 20__, to undertake the construction of the **12th St. NW Water Main Replacement (TAG 617) Project** ("Project"). The penal sum referred to herein shall be the dollar amount of the principal's bid to the obligee, incorporating any additive or deductive Alternates made by the principal on the date referred to above to the obligee, which are accepted by the obligee. In no case shall the penal sum exceed the amount of _____ Dollars (\$_____). (If the foregoing blank is not filled in, the penal sum will be the full amount of the principal's bid, including add Alternates. Alternatively, if the blank is filled in the amount stated must not be less than the full amount of the bid including add Alternates, in dollars and cents. A percentage is not acceptable.) For the payment of the penal sum well and truly to be made, we hereby jointly and severally bind ourselves, our heirs, executors, administrators, successors, and assigns.

Signed this ____ day of _____, 20__.

THE CONDITION OF THE ABOVE OBLIGATION IS SUCH that whereas the above named principal has submitted a bid for work on the Project.

Now, therefore, if the obligee accepts the bid of the principal and the principal fails to enter into a proper contract in accordance with the bid, plans, details, specifications, and bills of material; and in the event the principal pays to the obligee the difference not to exceed ten percent (10%) of the penalty hereof between the amount specified in the bid and such larger amount for which the obligee may in good faith contract with the next lowest bidder to perform the work covered by the bid; or in the event the obligee does not award the contract to the next lowest bidder and resubmits the project for bidding, the principal pays to the obligee the difference not-to-exceed ten percent (10%) of the penalty hereof between the amount specified in the bid, or the costs, in connection with the resubmission, of printing new contract documents, required advertising, and printing and mailing notices to prospective bidders, whichever is less, then this obligation shall be null and void, otherwise to remain in full force and effect; if the obligee accepts the bid of the principal and the principal within ten (10) days after the awarding of the contract enters into a proper contract in accordance with the bid, plans, details, specifications, and bills of material, which said contract is made a part of this bond the same as though set forth herein.

Now also, if the said principal shall well and faithfully do and perform the things agreed by said principal to be done and performed according to the terms of said contract; and shall pay all lawful claims of subcontractors, materialmen, and laborers, for labor performed and materials furnished in the carrying forward, performing, or completing of said contract; we agreeing and assenting that this undertaking shall be for the benefit of any materialman or laborer having a just claim, as well as for the obligee herein; then this obligation shall be void; otherwise the same shall remain in full force and effect; and surety shall indemnify the obligee against all damage suffered by failure of the principal to perform the contract according to its provisions and in accordance with the plans, details, specifications, and bills of material therefor and to pay all lawful claims of subcontractors, materialmen, and laborers for labor performed or material furnished in carrying forward, performing, or completing the contract and surety further agrees and assents that this undertaking is for the benefit of any subcontractor, materialman, or laborer having a just claim, as well as for the obligee; it being expressly understood and agreed that the liability of the surety for any and all claims hereunder shall in no event exceed the penal amount of this obligation as herein stated.

The said surety hereby stipulates and agrees that no modifications, omissions, or additions in or to the terms of the said contract or in or to the plans or specifications therefore shall in any wise affect the



The City of Canton

obligations of said surety on its bond, and does hereby waive notice of any such modifications, omissions or additions to the terms of the contract or to the work or to the specifications.

Signed and sealed this _____ day of _____, 20__.

PRINCIPAL

By: _____

Printed Name & Title: _____

SURETY

By: _____

Printed Name & Title: _____

Surety's Address: _____

Surety's Telephone Number: _____

Surety's Fax Number: _____

SURETY'S AGENT

Surety's Agent's Address: _____

Surety's Agent's Telephone Number: _____

Surety's Agent's Fax Number: _____



The City of Canton

NOTE: The Contract Bond form that follows is to be used **ONLY** by a bidder that is awarded a contract **and** submits a form of bid guaranty other than the combined Bid Guaranty and Contract Bond with its bid. If a bidder submits a combined Bid Guaranty and Contract Bond, then the bid guaranty becomes the contract bond when the contract is awarded.

AIA and EJCDC Bid Bond or Payment and Performance Bond forms are not acceptable for this Project.



The City of Canton

CONTRACT BOND

(O.R.C. § 153.57)

KNOW ALL PERSONS BY THESE PRESENTS, that we, the undersigned ("Contractor"), as principal, and _____, as surety, are hereby held and firmly bound unto the **City of Canton** ("Owner") as obligee, in the penal sum of _____ Dollars (\$ _____), for the payment of which well and truly to be made, we hereby jointly and severally bind ourselves, our heirs, executors, administrators, successors, and assigns.

THE CONDITION OF THE ABOVE OBLIGATION IS SUCH that whereas, the above-named principal did on the _____ day of _____, 20____, enter into a contract with the Owner for construction of the **12th St. NW Water Main Replacement (TAG 617) Project** ("Project"), which said contract is made a part of this bond the same as though set forth herein:

Now, if the said Contractor shall well and faithfully do and perform the things agreed by the Contractor to be done and performed according to the terms of said contract; and shall pay all lawful claims of subcontractors, materialmen, and laborers, for labor performed and materials furnished in the carrying forward, performing, or completing of said contract; we agreeing and assenting that this undertaking shall be for the benefit of any materialman or laborer having a just claim, as well as for the obligee herein; then this obligation shall be void; otherwise the same shall remain in full force and effect; it being expressly understood and agreed that the liability of the surety for any and all claims hereunder shall in no event exceed the penal amount of this obligation as herein stated.

The said surety hereby stipulates and agrees that no modifications, omissions, or additions in or to the terms of the said contract or in or to the plans or specifications therefore shall in any wise affect the obligations of said surety on its bond, and does hereby waive notice of any such modifications, omissions or additions to the terms of the contract or to the work or to the specifications.

Signed and sealed this _____ day of _____, 20____.

(PRINCIPAL)

(SURETY)

By: _____

By: _____

Printed Name & Title: _____

Printed Name & Title: _____

Surety's Address: _____

Surety's Telephone Number: _____

Surety's Fax Number: _____

NAME OF SURETY'S AGENT

Surety's Agent's Address: _____

Surety's Agent's Telephone Number: _____

Surety's Agent's Fax Number: _____



BID FORM

1.01 BID SUBMITTED BY:

_____ (Contractor)

Date bid submitted: _____

1.02 DELIVER TO:

The City of Canton
ATTN: **Purchasing/Bids**
218 Cleveland Avenue SW
Canton, OH 44702

1.03 Having carefully reviewed the Instructions to Bidders, Drawings, Specifications and other Contract Documents for the Project titled **12th St. NW Water Main Replacement (TAG 617) Project** including having also received, read, and taken into account the following Addenda:

Addendum No.	Dated
_____	_____
_____	_____
_____	_____
_____	_____
_____	_____

and likewise having inspected the site and the conditions affecting and governing the Project, the undersigned hereby proposes to furnish all materials and to perform all labor, as specified and described in the said Specifications and/or as shown on the said Drawings for all Work necessary to complete the Project on a timely basis and in accordance with the Contract Documents regardless of whether expressly provided for in such Specifications and Drawings.

1.04 Before completing the Bid Form, the undersigned represents that it has carefully reviewed the Legal Notice to Bidders, Instructions to Bidders, this Bid Form, Form of Bid Guaranty and Contract Bond, Contractor's Affidavit (O.R.C. 5719.042), Owner-Contractor Agreement, General Conditions of the Contract (EJCDC C-700) (as modified for the Project), Drawings, Project Specifications, and other Contract Documents. Failure to comply with provisions of the Contract Documents may be cause for disqualification of the bid.

1.05 BONDS AND CONTRACT: If the undersigned is notified of bid acceptance, it agrees to furnish required bonds as indicated in the Instructions to Bidders.

1.06 COMPLETION OF WORK: In submitting a bid, the undersigned agrees to execute the Owner-Contractor Agreement in the form included in the Contract Documents and to complete its Work as required by the Contract Documents.

NOTE A: The wording of the Bid Form shall be used throughout, without change, alteration, or addition. Any change may cause it to be rejected.

NOTE B: Bidder is cautioned to bid only on the Brands or Standards specified.

NOTE C: If there is an inconsistency or conflict in the Bid amount, the lowest amount shall control, whether expressed in numbers or words.



2.01 BID:

Include the cost of all labor and material for the contract listed below. Bidder is to fill in all blanks related to the Bid Package for which a bid is being submitted. If no bid is submitted for an item, leave the item blank or insert "NO BID" in the blank. For alternate items, indicate whether the amount stated is in addition to or a deduction from the base bid amount (if there is no indication whether the amount for an alternate is an addition or a deduction, the amount shall be a deduction).

2.02 Bidder will complete the Work in accordance with the Contract Documents for the prices set forth in the attached Bid Schedule.

3.01 INSTRUCTIONS FOR SIGNING

- A. The person signing for a sole proprietorship must be the sole proprietor or his authorized representative. The name of the sole proprietor must be shown below.
- B. The person signing for a partnership must be a partner or his authorized representative.
- C. The person signing for a corporation must be the president, vice president or other authorized representative; or he must show authority, by affidavit, to bind the corporation.
- D. The person signing for some other legal entity must show his authority, by affidavit, to bind the legal entity.

4.01 BIDDER CERTIFICATIONS. The Bidder hereby acknowledges that the following representations in this bid are material and not mere recitals:

1. The Bidder acknowledges that this is a public project involving public funds, and that the Owner expects and requires that each successful Bidder adhere to the highest ethical and performance standards. The Bidder by submitting its bid pledges and agrees that (a) it will act at all times with absolute integrity and truthfulness in its dealings with the Owner and the Design Professional, (b) it will use its best efforts to cooperate with the Owner and the Design Professional and all other Contractors on the Project and at all times will act with professionalism and dignity in its dealings with the Owner, Design Professional and other Contractors, (c) it will assign only competent supervisors and workers to the Project, each of whom is fully qualified to perform the tasks that are assigned to him/her, and (d) it has read, understands and will comply with the terms of the Contract Documents.
2. The Bidder represents that it has had a competent person carefully and diligently review each part of the Contract Documents, including any Divisions of the Specifications and parts of the Drawings that are not directly applicable to the Work on which the Bidder is submitting its bid. By submitting its bid, each Bidder represents and agrees, based upon its careful and diligent review of the Contract Documents, that it is not aware of any conflicts, inconsistencies, errors or omissions in the Contract Documents for which it has not notified the Owner in writing at least ten (10) days prior to the bid opening. If there are any such conflicts, inconsistencies, errors or omissions in the Contract Documents, the Bidder (i) will provide the labor, equipment or materials of the better quality or greater quantity of Work; and/or (ii) will comply with the more stringent requirements. The Bidder will not be entitled to any additional compensation for any conflicts, inconsistencies, errors or omissions that would have been discovered by such careful and diligent review, unless it has given such prior written notice to Owner.
3. The Bidder represents that it has had a competent person carefully and diligently inspect and examine the entire site for the Project and the surrounding area, including all parts of the site applicable to the Work for which it is submitting its bid, and carefully correlate the results of the inspection with the requirements of the Contract Documents. The Bidder agrees that its bid shall include all costs attributable to site and surrounding area conditions that would have been discovered by such careful and diligent inspection and examination of the site and the



The City of Canton

surrounding area, and the Bidder shall not be entitled to any Change Order, additional compensation, or additional time on account of conditions that could have been discovered by such an investigation.

4. The Bidder represents, understands and agrees that a) the Claim procedures in the General Conditions as modified for the Project are material terms of the Contract Documents, b) if it has a Claim, it will have its personnel provide complete and accurate information to complete and submit the Statement of Claim form on a timely basis, c) the proper completion and timely submission of a Statement of Claim form is a condition precedent to any change in the Contract Sum or the Contract Time(s), and d) the proper and timely submission of the Statement of Claim form provides the Owner with necessary information so that the Owner may investigate the Claim and mitigate its damages.
5. The Bidder represents that the bid contains the name of every person interested therein and is based upon the Standards specified by the Contract Documents.
6. The Bidder and each person signing on behalf of the Bidder certifies, and in the case of a bid by joint venture, each member thereof certifies as to such member's entity, under penalty of perjury, that to the best of the undersigned's knowledge and belief: (a) the Base Bid, any Unit Prices and any Alternate bid in the bid have been arrived at independently without collusion, consultation, communication or agreement, or for the purpose of restricting competition as to any matter relating to such Base Bid, Unit Prices or Alternate bid with any other Bidder; (b) unless otherwise required by law, the Base Bid, any Unit Prices and any Alternate bid in the bid have not been knowingly disclosed by the Bidder and will not knowingly be disclosed by the Bidder prior to the bid opening, directly or indirectly, to any other Bidder who would have any interest in the Base Bid, Unit Prices or Alternate bid; (c) no attempt has been made or will be made by the Bidder to induce any other Person to submit or not to submit a bid for the purpose of restricting competition; and (d) the statements made in this Bid Form are true and correct.
7. The Bidder will execute the form of Owner/Contractor Agreement in the form included with the Contract Documents, if a Contract is awarded on the basis of this bid, and if the Bidder does not execute the Contract Form for any reason, other than as authorized by law, the Bidder and the Bidder's Surety are liable to the Owner.
8. The Bidder certifies that the upon the award of a Contract, the Contractor will ensure that all of the Contractor's employees, while working on the Project site, will not purchase, transfer, use or possess illegal drugs or alcohol or abuse prescription drugs in any way.
9. The Bidder agrees to furnish any information requested by the Owner's authorized representative to evaluate that the Bidder has submitted the lowest and best bid and that the bid is responsive to the specifications.
10. The Bidder certifies that it has no unresolved findings for recovery issued by the Auditor of State.
11. The Bidder certifies that it is aware of and in compliance with the requirements of Ohio Revised Code Section 3517.13 regarding campaign contributions.

LEGAL NAME OF BIDDER: _____

BIDDER IS (check one): sole proprietor partnership corporation other legal entity



The City of Canton

NAME & TITLE OF PERSON LEGALLY AUTHORIZED TO BIND BIDDER TO A CONTRACT:

Name	Title
DATE SIGNED: _____	SIGNATURE: _____
	ADDRESS: _____

	TELEPHONE: _____
	FAX: _____
	FEDERAL TAX I.D. # _____

When the Bidder is a partnership or a joint venture, state name and address of each partner in the partnership or participant in the joint venture below:

Name	Address
Name	Address
Name	Address
Name	Address
Name	Address

END OF SECTION



The City of Canton

CONTRACTOR'S QUALIFICATION STATEMENT
12th St. NW Water Main Replacement (TAG 617) Project

SUBMITTED TO: The City of Canton
ATTN: **Purchasing/Bids**
218 Cleveland Avenue SW
Canton, OH 44702

SUBMITTED BY: _____

NAME: _____

ADDRESS: _____

PRINCIPAL OFFICE: _____

- Corporation
- Partnership
- Individual
- Joint Venture
- Other

NAME OF PROJECT: **12th St. NW Water Main Replacement (TAG 617) Project**

1. ORGANIZATION

- 1.1 How many years has your organization been in business as a Contractor in the construction industry?
- 1.2 How many years has your organization been in business under its present business name?
 - 1.2.1 Under what other or former names has your organization operated?
- 1.3 If your organization is a corporation, answer the following:
 - 1.3.1 Date of incorporation:
 - 1.3.2 State of incorporation:
 - 1.3.3 President's name:
 - 1.3.4 Vice President's name(s):
 - 1.3.5 Secretary's name:
 - 1.3.6 Treasurer's name:
- 1.4 If your organization is a partnership, answer the following:



The City of Canton

- 1.4.1 Date of organization:
- 1.4.2 Type of partnership (if applicable):
- 1.4.3 Name(s) of general partner(s):
- 1.5 If your organization is individually owned, answer the following:
 - 1.5.1 Date of organization:
 - 1.5.2 Name of owner:
- 1.6 If the form of your organization is other than those listed above, describe it and name the principals:

2. LICENSING

- 2.1. List jurisdictions and trade categories in which your organization is legally qualified to do business, and indicate registration or license numbers, if applicable.
- 2.2. List jurisdictions in which your organization's partnership or trade name is filed.
- 2.3. List any suspension or revocations of any professional license of any director, officer, owner, or managerial employees of the Contractor, to the extent that any work to be performed on this Project is within the field of such licensed profession.

3. EXPERIENCE

- 3.1. List the categories of work that your organization normally performs with its own forces.
- 3.2. Claims and Lawsuits (If the answer to any of the questions below is yes, please attach details.)
 - 3.2.1. Has your organization ever failed to complete any work?
 - 3.2.2. Has your organization ever failed to complete any work by the substantial completion date, final completion date, or in a timely manner?
 - 3.2.3. Within the last five (5) years has your organization or any of its officers prosecuted any Claims, had any Claims prosecuted against it or them, or been involved in or is currently involved in any mediation or arbitration proceedings or lawsuits related to any construction project, or has any judgments or awards outstanding against it or them? Has your organization had any extension requests, fines and penalties imposed, or contract defaults? If the answer is yes, please attach the details for each Claim, including the names and telephone numbers of the persons who are parties, the amount of the Claim, the type of Claim and the basis for the Claim, and the outcome.

Note: As used in this document "Claim" means a Claim initiated under the Contract Documents for a project or relating to the Work for a project, including Claims made against performance bonds secured by the Contractor on other construction projects.

- 3.3. Has your organization ever failed to comply with federal, state, and local laws, rules, and regulations, including but not limited to the Occupational Safety and Health Act, the Ohio Prevailing Wage laws, and Ohio ethics laws? If the answer is yes, please attach details and reason(s) for each instance and the outcome including any fines or penalties imposed.
- 3.4. Within the last five years, has any officer or principal of your organization ever been an officer or principal of another organization when it failed to complete a construction contract? If the answer is yes, please attach details for each instance, including the names and telephone numbers of the persons who are parties to the contract, and the reason(s) the contract was not completed.
- 3.5. On a separate sheet, list construction projects your organization has in progress with an original Contract Sum of more than \$10,000,000, giving the name of project, owner and its telephone



The City of Canton

number, design professional and its telephone number, contract amount, percent complete and scheduled completion date.

3.5.1. State total amount of work in progress and under contract:

3.6. Provide the following information for each contract your organization has had during the last five (5) years, including current contracts, where the Contract Sum is fifty percent (50%) or more of the bid amount for this Project, including add alternates. Include details regarding timeliness of performance and quality of work. List the original contract price for each project, the amount of any change orders or cost overruns on each, the reasons for the change orders or cost overruns, and your organization's record for complying with and meeting completion deadlines on construction projects. If there are more than ten (10) of these contracts, only provide information on the most recent ten (10) contracts, including current contracts.

Project And Work	Contract Sum	Owner's Representative & Telephone Number	Engineer's Or Architect's Representative Name & Telephone Number	Additional Comments



The City of Canton

- 3.7. Provide the following information for each project your organization has had during the last five (5) years, which your organization believes is of comparable or greater size and complexity than the Owner's project. Include details regarding how such projects demonstrate your organization's ability and capacity to perform a substantial portion of the Project with its own work force. If there are more than five (5) of these projects, only provide information on the most recent five (5) projects, including current projects.

Project And Work	Contract Sum	Owner's Representative & Telephone Number	Engineer's Or Architect's Representative Name & Telephone Number	Additional Comments

- 3.7.1. State average annual amount of construction work your organization has performed during the last five years.
- 3.7.2. If any of the following members of your organization's management -- president, chairman of the board, or any director -- operates or has operated another construction company during the last five (5) years, identify the member of management and the name of the construction company.
- 3.7.3. If your organization is operating under a trade name registration with the Secretary of State for the State of Ohio, identify the entity for which the trade name is registered. If none, state "none."
- 3.7.4. If your organization is a division or wholly-owned subsidiary of another entity or has another relationship with another entity, identify the entity of which it is a division or wholly-owned subsidiary or with which it has another relationship and also identify the nature of the relationship. If none, state "not applicable."
- 3.8. On a separate sheet, list the construction education, training, construction experience, and tenure with your organization for each person who will fill a management role on the Project, including without limitation the Project Executive, Project Engineer, Project Manager, and Project Superintendent. For each person listed, include with the other information the last three projects on which the person worked and the name and telephone number of the Design Professional and the Owner.
- 3.9. Describe the size and experience of your organization's work force and your equipment and facilities, in relation to your organization's ability to complete the Project successfully and on time.

4. REFERENCES

- 4.1. Trade References:
- 4.2. Bank References:
- 4.3. Surety:



The City of Canton

4.3.1. Name of bonding company:

4.3.2. Name and address of agent:

5. FINANCING

5.1 Financial Statement (May be required, but only post-bid. Not a requirement to provide with bid.)

5.1.1 Attach a financial statement, preferably audited, including your organization's latest balance sheet and income statement showing the following items:

Current Assets (e.g., cash, joint venture accounts, accounts receivable, notes receivable, accrued income, deposits, materials inventory and prepaid expenses);

Net Fixed Assets;

Other Assets;

Current Liabilities (e.g., accounts payable, notes payable, accrued expenses, provision for income taxes, advances, accrued salaries and accrued payroll taxes); and

Other Liabilities (e.g., capital, capital stock, authorized and outstanding shares par values, earned surplus and retained earnings).

5.1.2 Name and address of firm preparing attached financial statement, and date thereof.

5.1.3 Is the attached financial statement for the identical organization named on page one?

5.1.4 If not, explain the relationship and financial responsibility of the organization whose financial statement is provided (e.g., parent-subsidiary).

5.2 Will the organization whose financial statement is attached act as guarantor of the contract for construction?

5.3 Attach additional documentation or explanations demonstrating your organization's financial responsibility, adequate resources and availability of credit, its means and ability to procure insurance and acceptable performance bonds required for the Project.

6. Does your organization participate in a drug-free workplace program? Provide your organization's record for both resolved and unresolved findings of the Auditor of the State of Ohio for recovery as defined in Section 9.24 of the Ohio Revised Code.

7. List any projects within the previous five years where a public entity determined that your organization was not a responsible bidder, including the name of the public entity, the reasons given by the public entity, and an explanation thereof.

8. Additional Criteria. Pursuant to the Codified Ordinance of the City of Canton, Chapter 105, the Owner, in its discretion, reserves the right to request additional information and documentation relating to the foregoing and related to any of the criteria listed in Paragraph I.6 of the Instructions to Bidders from Bidders after the bid opening. The Owner may consider such information and documentation in determining which bid is lowest and best. The Owner, in its discretion, may consider and give such weight to any and all criteria as it deems appropriate.

[left intentionally blank]



The City of Canton

Certification. The undersigned certifies for the reliance of the Owner that after diligent investigation, to the best of the undersigned's belief, the information provided with this Contractor's Qualification Statement is true, accurate and not misleading.

SIGNATURE:

Dated this ____ day of _____ 20__.

Name of
Organization: _____

By: _____
[print name]

Signature: _____

Title: _____

State of _____

County of _____

_____, being duly sworn, deposes and says that the information provided herein is true and sufficiently complete so as not to be misleading.

Subscribed and sworn before me this ____ day of _____ 20__.

Notary Public

My Commission Expires: _____

SEAL



The City of Canton

Modified General Conditions (EJCDC)

Please go to this [link](#) for the document or enter the following link into a web browser:

<https://cantonohio.gov/DocumentCenter/View/594/Modified-Standard-General-Conditions-of-the-Construction-Contract--Where-Owner-Performs-Administrative-Duties-PDF>



City of Canton Codified Ordinances

Bidders shall take notice that they are to comply with the Codified Ordinances of the City of Canton, including but not limited to, the following:

1. **Chapter 105.02 – Public Paving Time Restrictions.**
All City public paving contracts shall include a provision for liquidated damages in order to provide the City reasonable compensation for actual damages due to a failure to ensure that asphalt paving take place on the City's road surfaces from May 1st to October 1st; and/or during optimal climatic conditions that are conducive to the best mix compacting and long term durability of the pavement, according to the highest and best practices of the asphalt paving industry.
(Ord. 270-2014. Passed 12-29-14.)
2. **Chapter 105.03 – U.S. Steel Usage Required; Exception.**
All City contracts shall stipulate or provide that all steel necessary in the construction of any work performed under such contracts shall be steel that is produced in the United States unless a specific product which is required is not produced by manufacturers in the United States in which event this prohibition does not apply. This section shall apply to only contracts awarded by the Board of Control of the City.
(Ord. 224-77. Passed 6-27-77.)
3. **Chapter 105.05 – Materials to be Purchased Locally.**
In all future contracts for the construction of buildings, structures, or other improvements under the Capital Improvement Budget, the following clause shall be printed or typewritten on each contract:
It is the desire of the City of Canton that all materials used in the construction covered by this contract shall be purchased in the Canton area except such materials which are unavailable in the Canton area.
(Res. 49-77. Passed 2-7-77.)
4. **Chapter 105.06 – Minority Contract Provision.**
 - a. All contracts with the City shall include the following clause:
The bidder agrees to expend at least \$_____ of the Contract in the event the contract is awarded to such bidder for minority/women's business enterprises. For purposes of this pledge, the term "minority/women's business enterprise" means a bona fide business established as a sole proprietorship, partnership or corporation owned, operated and controlled by one or more minority persons or women who have at least fifty-one percent (51%) ownership. "Minority" includes African Americans, Asian/Pacific Islanders, Hispanic/Latino Americans and Native American Indians. The minority or woman must have operational and managerial control, interest in capital, and earnings commensurate with the percentage of ownership. Minority/women's business enterprises may be employed as construction contractors, subcontractors, vendors or suppliers.
(Ord.185-2011. Passed 10-31-11.)
5. **Chapter 105.12 – Local Bidder Preference.**
 - a. The Board of Control, in determining the lowest and best bidder in the award of contracts to which this section is applicable, is authorized to award contracts to local bidders as hereinafter defined, whose bid is not more than five percent (5%) higher, subject to a maximum amount of twenty thousand dollars (\$20,000.00), than the lowest dollar bid submitted by non-local bidders. The Board of Control's decision in making such an award shall be final.
 - b. For purposes of this section, "local bidder" means an individual or business entity which at the time of the award of the contract has a headquarters, division, sales office,



sales outlet, manufacturing facility, or similar significant business-related location in Stark County, Ohio.

- c. All contract specifications and/or bid documents that are distributed by Canton for the purpose of soliciting bids for goods and/or services shall contain the following notice: Prospective bidders will take notice that the City of Canton, in determining the lowest and best bidder in the award of this contract, may award a local bidder preference to any qualified bidder pursuant to Section 105.12 of the Codified Ordinances of the City of Canton. The determination of whether a bidder qualifies for the local preference shall be made by Board of Control. The Board's decision shall be final. A copy of Section 105.12 is attached.
- d. This section shall be applicable to all contracts for equipment, goods, machinery, materials, supplies, vehicles and/or services, which are purchased, leased and/or constructed at a cost in excess of fifty thousand dollars (\$50,000.00) and which require bidding pursuant to Ohio R.C. 735.05 through 735.09 and Ohio R.C. 737.03. *(Ord. 115-2018. Passed 5-14-18.)*

6. Chapter 105.15 – City Income Tax

- a. No person, partnership, corporation or unincorporated association may be awarded a contract with the City under Sections 105.09 or 105.10, unless the bidder is paid in full or is current and not otherwise delinquent in the payment of City income taxes, including any obligation to pay taxes withheld from employees under Section 182.05 and any payment on net profits under Section 182.06.
- b. Falsification of any information related to or any post-contractual violation of the requirement to pay City income taxes set forth in subsection (a) shall constitute cause for the rescission of the balance of the contract at the City's discretion.
- c. No partnership, corporation or unincorporated association which has as one of its partners, shareholders or owners a person who is a twenty percent (20%) or greater equity owner in such partnership, corporation or unincorporated association and who is delinquent in the payment of City income taxes as set forth in subsection (a), may be awarded a contract with the City under Sections 105.09 or 105.10.
- d. A person who is a twenty percent (20%) or greater equity owner in any partnership, corporation or unincorporated association which is delinquent in the payment of City income taxes as set forth in subsection (a) may not be awarded a contract with the City under Sections 105.09 or 105.10.
- e. A contract awarded under Sections 105.09 or 105.10 for a public improvement project, services other than personal or professional services, and personal or professional services shall not be binding or valid unless such contract contains the following provisions:

Said _____ hereby further agrees to withhold all City income taxes due or payable under Chapter 182 of the Codified Ordinances for wages, salaries, fees and commissions paid to its employees and further agrees that any of its subcontractors shall be required to agree to withhold any such City income taxes due for services performed under this contract. Furthermore, any person, firm or agency that has a contract or agreement with the City shall be subject to City income tax whether a resident or nonresident in the City, and whether the work being done is in the City or out



of the City. In addition to the tax withheld for employees, the net profits on the contract shall be subject to City income tax.
(Ord. 238-2015. Passed 11-30-15.)

7. Chapter 182.30 – Contract Provisions

- a. No contract on behalf of the City under Sections 105.09 or 105.10 of the Codified Ordinances of Canton for a public improvement project, services other than personal or professional services, and personal or professional services shall be binding or valid unless such contract contains the following provisions:

Said _____ hereby further agrees to withhold all City income taxes due or payable under Chapter 182 of the Codified Ordinances for wages, salaries, fees and commissions paid to its employees and further agrees that any of its subcontractors shall be required to agree to withhold any such City income taxes due for services performed under this contract. Furthermore, any person, firm or agency that has a contract or agreement with the City shall be subject to City income tax whether a resident or nonresident in the City, and whether the work being done is in the City or out of the City. In addition to the tax withheld for employees, the net profits on the contract shall be subject to City income tax.

- b. By entering into contract with the City of Canton _____ agrees with the City regarding the manner of withholding of City income taxes as provided in Section 718.011(F) of the Ohio Revised Code.
- i. Municipal income tax withholding provisions of Sections 718.011(B)(1) and 718.011(D) ORC shall not apply to qualifying wages paid to employees for work done or services performed or rendered inside the City or on City property.
- ii. _____ agrees to withhold income tax for the City from employees' qualifying wages earned inside the City or on City property, beginning with the first day of work done or services performed or rendered inside the City.

(Ord. 238-2015. Passed 11-30-15.)

8. Chapter 507.03 – Equal Employment Opportunity Clause.

- b. During the performance of this contract, the contractor agrees as follows:
1. The contractor shall not discriminate against any employee or applicant for employment because of race, age, handicap, religion, color, sex, national origin, sexual orientation or gender identity. The contractor shall take affirmative action to insure that applicants are employed and that employees are treated during employment without regard to race, religion, color, sex, national origin, military status, sexual orientation or gender identity. As used herein, the word "treated" shall mean and include without limitation the following: recruited, whether by advertising or other means; compensation, whether in the form of rates or pay or other forms of compensation; selected for training, including apprenticeship; promoted; demoted; upgraded; downgraded; transferred; laid off; and terminated. The contractor agrees to and shall post in conspicuous places available to employees and applicants for employment notices to be provided by the contracting officers setting forth the provisions of this nondiscrimination clause.
2. The contractor shall, in all solicitations or advertisements for employees placed by or on behalf of the contractor, state that all qualified applicants will receive consideration for employment without regard to race, age, handicap, religion, color, sex, national origin, military status, sexual orientation or gender identity.

(Ord. 153-2012. Passed 9-24-12.)

3. The contractor shall send to each labor union or representative of workers, with which he has a collective bargaining agreement or other contract or



- understanding, a notice advising the labor union or workers' representative of the contractor's commitments under the equal opportunity clause of the City; and he shall post copies of the notice in conspicuous places available to employees and applicants for employment.
4. The contractor shall submit in writing to the City his affirmative action plan, and each subcontractor and supplier of equipment or supplies shall submit to the general contractor his affirmative action plan. The responsibility for securing these affirmative action plans falls upon the general contractor and shall be on file at the office of the general contractor. The contractor shall furnish all information and reports required by the City or its representative pursuant to this chapter, and shall permit access to his books, records, and accounts by the contracting agency and by the Executive Secretary for purposes of investigation to ascertain compliance with the program.
 5. The contractor shall take such action with respect to any subcontractor as the City may direct as a means of enforcing the provisions of this equal opportunity clause, including penalties and sanctions for noncompliance; provided, however, that in the event the contractor becomes involved in or is threatened with litigation as the result of such direction by the City, the City will enter into such litigation as is necessary to protect the interests of the City and to effectuate the City's equal opportunity program and, in the case of contracts receiving Federal assistance, the contractor or the City may request the United States to enter into such litigation to protect the interests of the United States.
 6. The contractor shall file and shall cause his subcontractors, if any, to file compliance reports with the City in the form and to the extent prescribed by the City or its representative. Compliance reports filed at such times as directed shall contain information as to the employment practices, policies, programs and statistics of the contractor and his subcontractors.
 7. The contractor shall include the provisions of this equal employment opportunity clause in every subcontract or purchase order, so that such provisions will be binding upon each subcontractor or vendor.
 8. Refusal by the contractor or subcontractor to comply with any portion of this program as herein stated and described will subject the offending party to any or all of the following penalties:
 - A. Withholding of all future payments under the involved public contract to the contractor in violation, until it is determined that the contractor or subcontractor is in compliance with the provisions of this contract.
 - B. Refusal of all future bids for any public contract with the City or any of its departments or divisions, until such time as the contractor or subcontractor demonstrates that he has established and shall carry out the policies of the program as herein outlined.
 - C. Cancellation of the public contract and declaration of forfeiture of the performance bond.
 - D. In cases in which there is substantial or material violation or the threat of substantial or material violation of the compliance procedure or as may be provided by contract, appropriate proceedings may be brought to enforce these provisions, including the enjoining within applicable laws of contractors, subcontractors or other organizations, individuals or groups who prevent, directly or indirectly, or seek to prevent, directly or indirectly, compliance with the policy as herein outlined.

(Ord. 179-74. Passed 6-17-74.)



STATEMENT OF CLAIM FORM

Claim No. ___ for Contractor

1. Name of Contractor: _____

2. Date written claim given: _____.

3. Contractor's representative to contact regarding the claim:

Name: _____ Title: _____

Telephone No. _____ (office) FAX No. _____

E-mail: _____

4. General description of claim:

5. Contract Documents. If the claim is based upon any part or provision in the Contract Documents, including but not limited to pages in the Drawings and/or paragraphs in the Specifications, Owner-Contractor Agreement, General Conditions or Supplementary General Conditions, state upon which parts or provisions the claim is based:

6. Delay claims:

6.1 Date delay commenced: _____

6.2 Duration of the delay: _____

6.3 Apparent cause of the delay and part of critical path affected:

6.4 Impact of the delay and recommendations for minimizing such impact:

7. Additional compensation. Set forth in detail all additional compensation to which the Contractor believes it is entitled with respect to this claim:

8. Instructions for Completing the Statement of Claim Form ("Instructions"). The Instructions are incorporated in this Form.

9. Truth of Claim. By submitting this claim, the Contractor and its representative certify that after conscientious and thorough review and to the best of his or her knowledge and belief a) the Contractor has complied fully with the Instructions, b) the information in this State of Claim is accurate, c) the Contractor is entitled to recover the compensation in paragraph 7, and d) the Contractor has not knowingly presented a false or fraudulent claim. The Contractor by its authorized representative must acknowledge this Statement of Claim before a notary public.

CONTRACTOR: _____

By: _____

Name and Title: _____

Date: _____



The City of Canton

CONTRACTOR'S ACKNOWLEDGMENT

State of _____,

County of _____, ss:

_____ first being sworn, states that after conscientious and thorough review, the statements made in attached Statement of Claim Form are complete and true to the best of his or her knowledge and belief.

Sworn to before me a notary public by _____ on _____, 20__.

Notary Public

WHEN COMPLETED, FORWARD A COPY OF THIS NOTICE AND STATEMENT OF CLAIM FORM TO THE OWNER AND ENGINEER.



The City of Canton

1. Completing the Statement of Claim Form ("Claim Form") is a material term of the Contract. The Claim Form tells the Owner and Design Professional that the Contractor is making a Claim and that they need to act promptly to mitigate the effects of the occurrence giving rise to the Claim. The Claim Form also provides them with information so that they can mitigate such effects. The Contractor acknowledges that constructive knowledge of the conditions giving rise to the Claim through job meetings, correspondence, site observations, etc. is inadequate notice, because knowledge of these conditions does not tell the Owner and Engineer that the Contractor will be making a Claim and most often is incomplete.
2. If the space provided in the Claim Form is insufficient, the Contractor, as necessary to provide complete and detailed information, must attach pages to the Claim Form with the required information.
3. Paragraph 4. The Contractor must state what it wants, *i.e.*, time and/or compensation, and the reason why it is entitled to time and/or compensation.
4. Paragraph 5. The Contractor must identify the exact provisions of the Contract Documents it is relying on in making its Claim. For example, if the Claim is for a change in the scope of the Contractor's Work, the Contractor must identify the specific provisions of the Specifications, and the Plan sheets and details that provide the basis for the scope change.
5. Paragraph 6. This paragraph applies to delay claims, including delays that the Contractor believes result in constructive acceleration. The Contractor must identify the cause of the delay, party or parties responsible, and what the party did or did not do that caused the delay, *i.e.*, specific work activities. The Contractor acknowledges that general statements are not sufficient, and do not provide the Owner with sufficient information to exercise the remedies available to the Owner or to mitigate the effects of the delay.

For example, if the Contractor claims a slow response time on submittals caused a delay, the Contractor must identify the specific submittals, all relevant dates, and then show on the applicable schedule, by circling or highlighting, the activities immediately affected by the delays. Also for example, if the Contractor claims it was delayed by another Contractor, the Contractor must identify the delaying Contractor, specifically what the delaying Contractor did or did not do that caused the delay, and then show the applicable schedule, by circling or highlighting, the activities immediately affected by the delays. Further by example, if the Contractor seeks an extension of time for unusually severe weather, the Contractor must submit comparative weather data along with a record of the actual weather at the job site and job site conditions.

6. Paragraph 6.4. Time is of the essence under the Contract Documents. If there is a delay, it is important to know what can be done to minimize the impact of the delay. It therefore is important that the Contractor provide specific recommendations on how to do so.
7. Paragraph 7. The Contractor must provide a specific and detailed breakdown of the additional compensation it seeks to recover. For future compensation, the Contractor shall provide its best estimate of such compensation.
8. Paragraph 8 and Acknowledgment. By submitting this Claim, the Contractor and its representative certify that after conscientious and thorough review and to the best of his or her knowledge and belief a) the Contractor has complied fully with the Instructions, b) the information in this Claim Form is accurate, c) the Contractor is entitled to recover the compensation in paragraph 7, and d) the Contractor has not knowingly presented a false or fraudulent claim. The Contractor by its authorized representative must acknowledge this Statement of Claim before a notary public.

End of Instructions



The City of Canton

CONTRACTOR'S PERSONAL PROPERTY TAX AFFIDAVIT
(O.R.C. § 5719.042)

State of Ohio
County of _____, ss:

_____, being first duly sworn, deposes and says that he is the
(Name)

_____ of _____ with offices located at
(Title) (Contractor)

_____, and as its duly
(Address of Contractor)

authorized representative, states that effective this ____ day of _____, 20__,

(Name of Contractor)

() is charged with delinquent personal property taxes on the general list of personal property as set forth below:

<u>County</u>	<u>Amount</u> (includes total amount due, plus penalties and interest thereon)
Stark	\$ _____

() is not charged with delinquent personal property taxes on the general list of personal property in Stark County.

(Affiant)

Sworn to and subscribed before me by the above-named affiant this ____ day of _____, 20__.

(Notary Public)

My commission expires
_____, 20__



The City of Canton

**CONTRACTOR’S FINAL WAIVER & RELEASE AFFIDAVIT
("AFFIDAVIT")**

Project: **12th St. NW Water Main Replacement (TAG 617)**

In consideration for payment received from the City of Canton (the "City") in the amount requested in Contractor’s Final Application for Payment to the City, the receipt of which is hereby acknowledged, the undersigned Contractor hereby waives and releases any rights it has or may have to any and all types of claims relating to the Project, including without limitation claims of payment, Mechanic’s Lien, stop notice, equitable lien, labor and material bond, breach of contract or unjust enrichment, or any other claim against the City, for any labor, materials, or equipment the undersigned may have delivered or provided to the Project, except for any Claims the undersigned has made by properly and timely submitting a Statement of Claim form. The undersigned further certifies that this Affidavit covers claims by all contractors, subcontractors, and suppliers who may have provided any labor, material, or equipment to the Project through the undersigned or at the undersigned’s request. The undersigned acknowledges that all such contractors, subcontractors, sub-subcontractors and suppliers have signed an affidavit in the form of this Affidavit releasing any and all claims against the City, except for any Claims the undersigned has made by properly and timely submitting a written statement of its Claim. The undersigned hereby represents and warrants that it has paid any and all welfare, pension, vacation or other contributions required to be paid on account of the employment by the undersigned of any laborers on the Project.

This Affidavit is for the benefit of, and may be relied upon by the City. The undersigned hereby agrees to indemnify, defend and hold harmless each of the foregoing, the Project, work of improvement, and real property from any and all claims, or liens that are or should have been released in accordance with this Affidavit.

Company Name

State of: _____ County of _____

Authorized Signature (Company Officer)

Subscribed and sworn to before me this _____

Title

day of _____

Notary Public: _____

Date

My Commission Expires: _____



The City of Canton

CITY OF CANTON

12th St. NW Water Main Replacement (TAG 617) Project

PRE-BID SUBSTITUTION FORM

1. Note. Certain brands of material or apparatus are specified. Each bid will be based on these brands, which may be referred to in the Contract Documents as Standards. The use of another brand (referred to as a substitution or proposed equal in the Contract Documents, when a bidder or the contractor seeks to have a different brand of material or apparatus than that specified approved by the Owner for use in the Project) may be requested as provided in the Instructions to Bidders. Substitutions, however, unless approved and issued in an Addendum, will not be considered in determining which bidder to award the contract to.

2. The detailed procedures for submitting substitutions are set forth in Paragraph K of the Instructions to Bidders.

Specification Section	Brand or Name Specified	Proposed Substitution



ODOT MANUAL SUPPLEMENT

This Supplement shall apply where and to the extent that the State of Ohio Department of Transportation Construction and Material Specifications, in the current version as of January 1, 2019, is expressly incorporated into the Contract Documents via the Owner-Contractor Agreement, or when designated as a Contract Document in the list of Contract Documents in the Owner-Contractor Agreement, or is referenced anywhere else in the Contract Documents as one of the Contract Documents.

1. Regardless of any terms to the contrary in Division 100 or elsewhere, any directions or orders of the Engineer that will result in an adjustment of the Contract Price or the Contract Time shall require the prior written approval of the Owner. It is expressly understood and agreed that the Engineer does not have authority to authorize changes or modifications in the Contract Price or Contract Time.
2. The Contractor's obligations under this ODOT Supplement are in addition to and not in limitation of its other obligations under the Contract Documents.
3. Delays. Regardless of the terms in this ODOT Supplement, including Item 109.05, all time adjustments shall be subject to a) filing a Change Proposal and / or Claim in accordance with Articles 11 and 12 of the Modified Standard General Conditions of the Contract for Construction (EJCDC C-700, 2013 edition) ("Modified Standard General Conditions"), b) substantiating the Contractor's entitlement to a time adjustment in accordance with the Modified Standard General Conditions and c) Item 109.05. The Contractor will be entitled to additional compensation for delays but only for those delays described in the Modified Standard General Conditions. As part of the Claims process and as a condition precedent to receiving any additional compensation, the Contractor shall prepare a cost analysis as allowed by Item 109.05.D substantiating its entitlement to additional compensation.
4. Division 100, General Provisions. The following Division 100 General Provisions of the State of Ohio Department of Transportation, Construction Specifications Manual in the current version as of January 31, 2019, are incorporated in this ODOT Supplement, subject to any changes or limitations herein.
 - a. Item 101.01, General.
 - b. Item 101.02, Abbreviations, provided that references to DCA, DDD, DET, DGE shall mean the Owner.
 - c. Item 101.03, Definitions, provided where terms that are defined in the other Contract Documents, the definition in the other Contract Documents shall control, and further provided that the following definitions are deleted, modified and/or added:
 - i. Claims is deleted
 - ii. Contract Bond is deleted.
 - iii. Contract Documents is deleted.



The City of Canton

- iv. Contract Price is deleted.
- v. Contract Time is deleted.
- vi. Contractor is deleted.
- vii. Department shall mean the Owner.
- viii. Director shall mean the Owner's representative.
- ix. Disputes is deleted.
- x. Engineer is deleted.
- xi. Extra Work Contract is deleted.
- xii. Final Acceptance shall mean Final Completion as defined in the Owner Contractor Agreement.
- xiii. Final Inspector shall mean the Owner.
- xiv. Laboratory is deleted.
- xv. Prebid Question is deleted.
- xvi. Proposal Guaranty is deleted.
- xvii. Questionnaire is deleted.
- xviii. Shop Drawings is deleted.
- xix. Signatures on Contract Documents is deleted.
- xx. State or state shall mean the Owner.
- xxi. Subcontractor is deleted.
- xxii. Work is deleted.
- d. Item 101.04, Interpretations.
- e. Item 103.03, Cancellation of Award.
- f. Item 104.02.D.2, Significant Changes in the Character of the Work (including Tables 104.02-1 and 104.02-2 following this Item), provided that all references to Item 108 and 109.12 are deleted and that all time adjustments shall be subject to filing a Change Proposal and / or Claim in accordance with the Modified Standard General Conditions and substantiating the entitlement to an extension of time as provided in the Modified Standard General Conditions (EJCDC Document C-700, 2013 edition) ("Modified Standard General Conditions").
- g. Item 104.03, Rights in and Use of Materials Found on the Work.
- h. Item 104.04, Cleaning Up.
- i. Item 105.02, Plans and Working Drawings, provided that the review of submittals may be by the Owner or the Engineer in the Owner's discretion.
- j. Item 105.06, Superintendent.
- k. Item 105.10, Inspection of Work.



The City of Canton

- l. Item 105.11, Removal of Defective and Unauthorized Work.
- m. Item 105.12, Load Restrictions.
- n. Item 105.13, Haul Roads, provided that the second paragraph in this Item is deleted. The Contractor shall be responsible for any damage to the roads referred to in the second paragraph.
- o. Item 105.14, Maintenance During Construction, except substitute “Final Completion” for “Final Inspector accepts the work under 109.12” and delete the remainder of the first sentence. Additionally, delete the second to last sentence in this Item.
- p. Item 105.15, Failure to Maintain Roadway or Structure.
- q. Item 105.16, Borrow and Waste Areas.
- r. Item 105.17, Construction and Demolition Debris.
- s. Item 106.01, Source of Supply and Quality Requirements.
- t. Item 106.02, Samples, Tests and Cited Specifications, provided that this Item will be optional at the discretion of the Owner. If the Owner elects to proceed under this Item, a) the Contractor without additional cost will provide material samples as required by the Owner, and b) the Owner may conduct such tests as it determines proper.
- u. Item 106.03, Small Quantities and Materials for Temporary Application.
- v. Item 106.04, Plant Sampling and Testing Plan.
- w. Item 106.05, Storage of Materials.
- x. Item 106.06, Handling Materials.
- y. Item 106.07, Unacceptable Materials, except substitute the word “unacceptance” in the third sentence with the word “unacceptable.”
- z. Item 106.08, Department-Furnished Material.
- aa. Item 106.09, Steel and Iron Products Made in the United States.
- bb. Item 107.01, Laws to be Observed.
- cc. Item 107.02, Permits, Licenses, and Taxes.
- dd. Item 107.03, Patented Devices, Materials, and Processes.
- ee. Item 107.05, Federal-Aid Provisions.
- ff. Item 107.06, Sanitary Provisions.
- gg. Item 107.07, Public Convenience and Safety.
- hh. Item 107.08, Bridges Over Navigable Waters.
- ii. Item 107.09, Use of Explosives, provided that both bringing explosives onto the site and any use of explosives shall require the prior written approval of the Owner.
- jj. Item 107.10, Protection and Restoration of Property, provided that the Contractor shall remain responsible for all damage and injury to property until the Project is Finally Complete, and all references to Items 109.11 and 109.12 are deleted.



The City of Canton

- kk. Item 107.11, Contractor's Use of the Project Right-of-Way or Other Department-Owned Property, provided the reference to Item 109.12 is deleted.
- ll. Item 107.12, Responsibility for Damage Claims and Liability Insurance, provided that all notices and certificates shall be delivered to the Owner's representative and, if there is no Owner's representative, to the Engineer. Reference to the "State of Ohio, Department of Transportation" shall mean the Owner.
- mm. Item 107.13, Reporting, Investigating, and Resolving Motorist Damage Claims, provided that this item is modified to read, "When a motorist reports damage to its vehicle either verbally or in writing to the Contractor, the Contractor shall within 3 days make and file a written report to the Owner and the Engineer and also file a report with its insurance carrier".
- nn. Item 107.14 Opening Sections of Project to Traffic, provided that the reference to Item 108.06 is deleted.
- oo. Item 107.15, Contractor's Responsibility for Work, provided that reference to "Final Inspection according to 109.12.A" shall mean "Final Completion." and all references to Item 108 are deleted.
- pp. Item 107.17, Furnishing Right-of-Way.
- qq. Item 107.19, Environmental Protection, provided that the Owner makes no representation as to having acquired any permits unless expressly provided in the Contract Documents. The Contractor will comply with any permits obtained by the Owner.
- rr. Item 107.20, Civil Rights.
- ss. Item 107.21, Prompt Payment.
- tt. Item 108.01, Subletting of the Contract, provided that the Contractor need not provide the Owner with information or reports on DBE participation unless the Contract Documents otherwise require such reports or information. Additionally, unless otherwise provided in the Contract Documents, the 50% self-contracting requirement in the first sentence is waived.
- uu. Item 108.04, Limitation of Operations.
- vv. Item 108.05, Character of Workers, Methods, and Equipment.
- ww. Item 108.10, Payroll Records.
- xx. Item 109.01, Measurement of Quantities, provided that this item will apply only where payment is to be based on the measurement of quantities.
- yy. Item 109.02, Measurement Units.
- zz. Item 109.03, Scope of Payment.
- aaa. (Reserved.)
- bbb. Item 109.05, Extra Work as modified in this Supplement, provided that a) the references to Items 105.07, 105.10 and 108 are deleted, b) all negotiated prices shall require the Owner's written approval, c) the Owner must approve in writing any directions or orders by the Engineer to proceed with force account work, d) in Item 109.05.B.2 the reference to Department



The City of Canton

shall mean the Ohio Department of Transportation, e) the compensation provided in 109.05.B through 109.05.D constitutes payment in full for all the items referred to in Items 109.05.C.1-10, except for any additional compensation for delays, f) the mark-ups provided in Items 109.05.D.2.b and 109.05.D.2.d are deleted, and g) Item 109.05.D.2.f regarding home office overhead is deleted. The Contractor's entitlement to home office overhead, if any, shall be subject to current Ohio law.

- ccc. 109.06, Directed Acceleration.
- ddd. (Reserved.)
- eee. 109.08, Unrecoverable Costs.

5. Divisions 200 through 700. Divisions 200 through 700 of the State of Ohio Department of Transportation, Construction Specifications Manual in the current version as of January 31, 2019 are incorporated in this ODOT Supplement.

- a. All references to Division 100 Items in Divisions 200 through 700 shall be to the Division 100 Items as modified in this Supplement.
- b. Where Division 100 Items are referred to in Divisions 200 through 700 but are not included in this Supplement, the deleted references will be governed by this Paragraph 5.
- c. In Item 203.04, the reference to Item 108.06 shall be governed by Paragraph 3, Delays, in this Supplement.
- d. In Item 514.24, the reference to Item 109.10 shall be governed by the payment provisions in the Modified Standard General Conditions.
- e. In Item 624.04, the reference to item 109.09 shall be governed by the payment provisions in the Modified Standard General Conditions, i.e., the Owner will process and make payments in accordance with the provisions in the Modified Standard General Conditions. In this regard, the basis for payment of mobilization costs will be as provided in Item 624.04.
- f. General to Divisions 200 through 700. The basis for payment provided in the Basis for Payment items in these Divisions shall be the basis for payment to the Contractor when applicable.

END OF ODOT SUPPLEMENT

**PROJECT LABOR AGREEMENT
FOR THE
12TH STREET NW / WHIPPLE AVENUE NW WATER MAIN
REPLACEMENT PROJECT
ENTERED INTO BETWEEN
CITY OF CANTON
AND
EAST CENTRAL OHIO BUILDING AND CONSTRUCTION
TRADES COUNCIL AFL-CIO
AND
SIGNATORY LOCAL UNIONS**

Effective _____

CONTENTS

ARTICLE I	Intent and Duration	3
ARTICLE II	Purpose	4
ARTICLE III	Benefits of this Agreement.....	5
ARTICLE IV	Scope of Agreement.....	6
ARTICLE V	Labor/Management Cooperation Joint Administrative Committee	9
ARTICLE VI	Union Recognition and Employment.....	9
ARTICLE VII	Grievance Arbitration Procedure.....	11
ARTICLE VIII	Jurisdictional Disputes	13
ARTICLE IX	Management's Rights	14
ARTICLE X	Work Stoppages	14
ARTICLE XI	Wages and Benefits.....	15
ARTICLE XII	Local Union Negotiations During the Pendency Of the Agreement	16
ARTICLE XIII	Hours of Work, Overtime, Shifts and Holiday.....	17
ARTICLE XIV	Apprentices	20
ARTICLE XV	Drug and Alcohol Policy	21
ARTICLE XVI	Non-Discrimination	21
ARTICLE XVII	Sole and Complete Agreement	21
ARTICLE XVIII	Separability and Savings Clause	21

ARTICLE I

INTENT AND DURATION

Section 1. Intent And Duration. This Project Stabilization Agreement (the "Agreement") is entered into between the City of Canton (collectively the "Owner"); the East Central Ohio Building and Construction Trades Council, AFL-CIO ("ECOB & CTC" or "Council"); and the Signatory Unions (the "Unions"), and applies exclusively to the construction work within the scope of this Agreement to be performed on the 12th Street NW / Whipple Avenue NW Water Main Replacement Project (the "Project"). The purpose of this Agreement is to promote efficiency and cost-savings in the construction and refurbishment that is a part of the Project and to provide for the peaceful settlement of any and all labor disputes and grievances without strikes or lockouts, thereby promoting the public interest in assuring the timely and economical completion of the Project. This Agreement shall expire and be of no further force or effect upon the completion of the Project.

Upon execution of this Agreement by all parties, all construction, remodeling and renovation work covered by this Agreement on the Project shall be contracted exclusively to Contractors, of whatever tier, who agree to execute and be bound by the terms of this Agreement. The Unions agree that Contractors may execute the Agreement, or the Letter of Assent attached as Appendix I, for purposes of performing such work. The Owner (or its permitted designee) shall monitor compliance with this Agreement by all contractors and subcontractors. For purposes of the Agreement, the term "Contractor" shall be deemed to include all construction contractors and subcontractors of whatever tier engaged in on-site construction and renovation work on the Project. The Owner, the Unions and all signatory Contractors agree to abide by the terms and conditions contained in the Agreement. This Agreement represents the complete understanding of all parties, and no Contractor is or will be required to sign any other agreement with a signatory union as a condition of performing work coming within the scope of this Agreement. No practice, understanding or agreement between a Contractor and a Union, which conflicts with any provisions in this Agreement, will be binding on any other party unless endorsed in writing by the Owner.

Section 2. Limitation Of Agreement To Project. The Unions agree that this Agreement will be made available to, and will fully apply to, any successful bidder for

work on the Project, without regard to whether that successful bidder performs work at other sites on either a union or a non-union basis, and without regard to whether employees of such bidder are or are not members of any union. The Unions further agree that this Agreement applies only to this Project. Nothing in this agreement is intended to, or shall, interfere with, or negate, any existing contractual relationship or collective bargaining agreement between the Union and any contractor or subcontractor that may execute this Agreement.

ARTICLE II

PURPOSE

Section 1. Purpose. The Project Cost is fairly estimated to be \$350,000.00. The Project will require the replacement of approximately 1090 linear feet of waterline, on 12th Street NW from Whipple Avenue NW to Terrace Avenue NW / West Park Ave NW. In addition, the Project will involve the installation of related valves, hydrants and the reconnection of this waterline system to the existing water distribution network presently servicing the 12th Street Area. This is a major construction project that must be commenced in the Winter Season of 2020. This Agreement is necessary to secure and preserve the health and safety of Canton residents and to protect the integrity of the City's water distribution system. The parties to this Agreement understand and acknowledge the Project is critical to the economic development of the City of Canton and to advancing the goals appearing in the City's Comprehensive Plan.

Section 2. Time Is Of The Essence. The parties to this Agreement understand and agree that time is of the essence for this Project. The parties understand and agree that timely completion of the Project will require the use of substantial numbers of employees from construction and supporting crafts possessing skills and qualifications that are essential to the Project. The Unions pledge that they have members who are competent, skilled, and qualified to perform the required construction work. The parties also understand that on-budget completion of the Project is most critical; it is therefore essential that construction work on the Project be done in an efficient, economical manner with optimum productivity and with no delays. In recognition of those special needs of the Project, the Unions signatory hereto and their members agree not to initiate, authorize, sanction, participate in or condone, or permit their members to engage in any strike, sympathy strike,

jurisdictional strike, recognitional strike, slowdown, sabotage, work to rule, sickout, sit down, picketing of any type (including informational picketing), handbilling, boycott, interruption of work or any disruptive activity that interferes with or interrupts in any way work on the Project or other operations of the City of Canton or its Water Department. Contractors agree not to engage in any lockouts.

ARTICLE III

BENEFITS OF THE AGREEMENT

Section 1. Benefits Of The Agreement. This Agreement is intended to foster the achievement of a timely and on-budget completion of the Project by, among other things:

- (a) reducing and/or eliminating the tension and potential disagreements that might otherwise exist between Union and non-union workers on the Project;
- (b) avoiding the costly delays of strikes, sympathy strikes, jurisdictional strikes, slowdowns, walkouts, picketing, handbilling and any other disruptions or interference with work, and promoting labor harmony and peace for the duration of the Project;
- (c) standardizing terms and conditions governing the employment of labor on the Project;
- (d) permitting flexibility in work scheduling and shift hours and times;
- (e) achieving negotiated adjustments as to work rules and staffing requirements from those which otherwise might obtain;
- (f) providing comprehensive and standardized mechanisms for the settlement of work disputes;
- (g) ensuring a reliable source of skilled and experienced labor; and
- (h) furthering public policy objectives, to the extent lawful, as to improved employment opportunities for minorities, women and the economically disadvantaged in the construction industry. Mindful of the economic condition and unemployment rate in Stark County, the Owner anticipates and expects that all construction workers and employees on this Project will be residents of Stark County. In view of the very technical and specialized work that is inherent in the construction industry, all parties acknowledge that this expectation by the Owner is a goal, not a mandate. To this end, all

Contractors working under this Agreement pledge that they will make a good-faith effort to reach this goal expressed by the Owner.

ARTICLE IV

SCOPE OF AGREEMENT

Section 1. The Work. This Agreement is specifically defined and limited to onsite construction and renovation work required to construct the Project.

Section 2. Exclusions From Scope. Items specifically excluded from the scope of this Agreement, even if performed in connection with the Project, include the following:

- (a) Work of non-manual employees, including but not limited to, superintendents, supervisors, staff engineers, inspectors, quality control and quality assurance personnel, timekeepers, mail carriers, clerks, office workers, including messengers, guards, safety personnel, emergency medical and first aid technicians, and other professional, engineering, administrative, supervisory and management employees.
- (b) Equipment and machinery owned or controlled and operated by the Owner.
- (c) All off-site manufacture, fabrication or handling of materials, equipment or machinery (except at dedicated lay-down or storage areas and except as provided in Article IV, Section 10), and all deliveries of any type to and from the Project site (except on-site pouring of concrete).
- (d) All employees of the Owner, the Construction Supervisor, design team or any environmental, engineering or other consultant when such employees do not perform labor coming within the scope of this Agreement.
- (e) Any work performed on or near or leading to or onto the site of work on the Project and undertaken by state, county, city or other governmental bodies, or their contractors; or by public utilities or their contractors.
- (f) Off-site maintenance of leased equipment and on-site supervision of all such maintenance work.
- (g) Work by employees of a manufacturer or vendor necessary to maintain such manufacturer's or vendor's warranty or guarantee, or work

performed by supervisors or technicians employed by the manufacturer or vendor to oversee the testing of equipment once installed to insure that the equipment is fully operational.

- (h) Laboratory work for specialty testing or inspections not ordinarily done by the signatory local unions.
- (i) All work done by employees of any State agency, authority or entity or employees of any municipality or other public employer.

The Unions agree that there shall be no interference with or disruption of work, of those contractors, employers, and employees exempted from coverage of this Agreement by subparagraph (a) through (i) above.

Section 3. Contract Award and Consent to Agreement.

- (a) The Owner, and/or Contractors, as appropriate, have the absolute right to award contracts or subcontracts on the Project notwithstanding the existence or nonexistence of any agreements between such Contractor and any Union party provided only that such Contractor is willing, ready and able to execute and comply with this Agreement or a Letter of Assent thereto, should such Contractor be awarded work covered by this Agreement.
- (b) All subcontractors of a Contractor, of whatever tier, who have been awarded contracts of work covered by this Agreement, on or after the effective date of this Agreement, shall also be required to accept and to be bound by the terms and conditions of this Agreement, and shall evidence their acceptance by the execution of this Agreement or a Letter of Assent thereto, prior to the commencement of work. A copy of this Agreement or Letter of Assent executed by each Contractor shall be immediately provided to the Union upon execution.

Section 4. Stand-Alone Agreement. This Agreement is a stand-alone Agreement. While this Agreement expressly does not incorporate any local area collective bargaining agreements, such local area collective bargaining agreements may be referenced for the limited purposes as hereinafter set forth in this Agreement. However, to the extent, if any, that any provisions of this Agreement conflict with any provision of a local area collective bargaining agreement, the provisions of this

Agreement shall control, except for all work performed under the NTL Articles of Agreement, the National Stack/Chimney Agreement, the National Cooling Tower Agreement, all instrument calibration work and loop checking shall be performed under the terms of the UA/IBEW Joint National Agreement for Instrument and Control Systems Technicians, and the National Agreement of the International Union of Elevator Constructors, with the exception of Articles VII, VIII and X of this Agreement, which shall apply to such work.

Section 5. Craft Jurisdiction. This Agreement shall recognize the traditional craft jurisdictions of the signatory unions. Any and all jurisdictional disputes shall be settled in accordance with Article VIII below. While this Agreement is a stand-alone Agreement, the Agreement will utilize the local area collective bargaining agreements of signatory locals, not state-wide agreements or other special project agreements, as a reference to define the signatory local unions' craft jurisdiction.

Section 6. Subcontracting. The Owner agrees that neither it nor any of its contractors or subcontractors will subcontract any work covered by this Agreement to be done on the Project except to a person, firm or corporation who is or agrees to become party to this Agreement. Any contractor or subcontractor working on the Project shall, as a condition to working on said Project, become signatory to and perform all work under the terms of this Agreement. Contractors who are signatory to local are collective bargaining agreements shall be bound by the terms of their respective local collective bargaining agreements on subcontracting to the extent such terms are consistent with Article IV, Section 2 of this Agreement. Disputes concerning compliance with such local subcontracting provisions for this Project shall be subject to all of the dispute resolution provisions of this Agreement.

Section 7. Liability. It is understood that the liability of the Contractor and the liability of the separate Unions under this Agreement shall be several and not joint. The Unions agree that this Agreement does not have the effect of creating any joint employer status between or among the Owner, Construction Supervisor and/or any Contractor, and neither the Owner nor Construction Supervisor shall assume any liabilities of the Contractors.

Section 8. Abatement of Agreement. As areas of covered work on the Project are accepted by the Owner, this Agreement shall have no further force or effect on

such areas except where the Contractor is directed by the Owner to engage in repairs or punch list modifications.

Section 9. Miscellaneous. Notwithstanding any other provision of this Agreement, this Agreement applies and is limited to the recognized and accepted historical definition of demolition and new construction work under the direction of and performed by the contractor(s), of whatever tier, who have contracts awarded for such work on the project. Such work shall include site preparation work and dedicated off-site work except for the contractors and subcontractors specifically excluded in this Article II. Any off-site prefabrication of any building materials, systems and/or components traditionally performed on site shall be performed by the appropriate craft signatory to this Agreement and approved by the owner.

ARTICLE V

LABOR/MANAGEMENT COOPERATION

JOINT ADMINISTRATIVE COMMITTEE

Section 1. The parties to this Agreement shall establish a Project Joint Administrative Committee ("Committee"). This Committee will be a two-person committee comprised of one member each appointed by the Owner (or its designee) and the Unions, with an alternate appointee Union member available to replace the regular appointee when a problem or grievance concerns the regular appointee's Union. Each member of the Committee shall designate an alternate who shall serve in the absence of the member for any purpose contemplated by this Agreement.

Section 2. The Committee shall meet at least quarterly, or more often if special circumstances warrant, to discuss the administration of the Agreement, the progress of the Project, labor/management problems that may arise, and any other relevant matters. Any need for interpretation which might arise from the application of the terms and conditions of the Agreement shall be referred directly to the Committee for resolution.

ARTICLE VI

UNION RECOGNITION AND EMPLOYMENT

Section 1. Pre-Hire Recognition. Each Contractor and subcontractor recognizes the Unions as the sole and exclusive bargaining representatives of all craft and trade employees within their respective jurisdictions working on the Project under

the Agreement.

Section 2. Contractor's Right of Selection. Each Contractor shall have the right to determine the competency of all employees, the number of employees required and shall have the sole responsibility for selecting employees to be laid off. To the extent any training or vendor education is required to fill any position, said training shall be undertaken at no cost or expense to Owner.

Section 3. Union Referral. For local Unions having a job referral system, each Contractor agrees to comply with such system, and the referral system shall be used exclusively by such Contractor, except as modified by this Article. Such job referral system will be operated in a non-discriminatory manner and in full compliance with Federal, state, and local laws and regulations requiring equal employment opportunities and nondiscrimination, and referrals shall not be affected in any way by the rules, regulations, bylaws, constitutional provisions or any other aspects or obligations of union membership, policies or requirements. The Union shall indemnify and hold each Contractor harmless with respect to any claim arising out of how the Union operates and administers its referral system. All hiring procedures, including related practices affecting apprenticeship and training, will be operated so as to facilitate the ability of the contractors to meet any and all equal employment opportunity/affirmative action obligations. The Contractor may reject any referral and request another, different referral; provided, however, the Contractor shall furnish, upon request from the Union, a written explanation for the rejection.

Section 4. Lack of Job Referral System. In the event that a signatory Local Union does not have a job referral system as set forth in Section 3 above, the Contractor shall give the Union a forty-eight (48) hour opportunity to refer applicants. The Contractor shall notify the Union of employees hired from any source other than referral by the Union.

Section 5. Unavailability of Union Referrals. In the event that local Unions are unable to fill any requisitions for qualified employees within forty-eight hours (48) after such requisition is made by the Contractor (Saturdays, Sundays, and Holidays excepted), the Contractor may employ applicants from any other available source. The Contractor shall inform the Union of the name, address and telephone number of any applicants hired from other sources and refer the applicant for the Local Union for

dispatch to the Project.

Section 6. Union Best Efforts. The Local Unions will exert their utmost efforts to recruit sufficient numbers of skilled craft workers to fulfill the manpower requirements of each Contractor, including calls to local unions in other geographic areas when its referral lists have been exhausted. The parties to this Agreement support the development of increased numbers of skilled construction workers from the residents of the area of the Project. Toward that end, the Unions agree to encourage the referral and utilization, to the extent permitted by law and the hiring hall procedures, of qualified residents as journeymen, apprentices and trainees on the Project.

ARTICLE VII

GRIEVANCE ARBITRATION PROCEDURE

Section 1. This Agreement is intended to provide close cooperation between management and labor. Each of the Unions will assign a representative to this Project for the purpose of completing the construction of the Project economically, efficiently, continuously, and without interruptions, delays, or work stoppages.

Section 2. The Contractors, Unions, and the employees, collectively and individually, realize the importance to all parties to maintain continuous and uninterrupted performance of the work of the Project, and agree to resolve disputes in accordance with the grievance-arbitration provisions set forth in this Article.

Section 3. Any question or dispute arising out of and during the term of this Agreement (other than trade jurisdictional disputes) shall be considered a grievance and subject to resolution under the following procedures:

Step 1. (a) When any employee subject to the provisions of this Agreement feels he or she is aggrieved by a violation of this Agreement, he or she, through his or her local union business representative or job steward, shall, within five (5) working days after the occurrence of the violation, give notice to the work-site representative of the involved Contractor stating the provision(s) alleged to have been violated. The business representative of the local union or the job steward and the work-site representative of the involved Contractor shall meet and endeavor to adjust the matter within three (3)

working days after timely notice has been given. The representative of the Contractor shall keep the meeting minutes and shall respond to the Union representative in writing at the conclusion of the meeting but not later than twenty-four (24) hours thereafter. If they fail to resolve the matter within the prescribed period, the Local Union may, within forty-eight (48) hours thereafter, pursue Step 2 of the Grievance Procedure, provided the grievance is reduced to writing, setting forth the relevant information concerning the alleged grievance, including a short description hereof, the date on which the grievance occurred, and the provisions of the Agreement alleged to have been violated.

- (a) Should the Local Union(s) or the Project Contractor or any Contractor have a dispute with the other party and if, after conferring, a settlement is not reached within three (3) working days, the dispute may be reduced to writing and proceed to Step 2 in the same manner as outlined herein for the adjustment of an employee complaint.

Step 2. The International Union Representative and the involved Contractor shall meet within seven (7) working days of the referral of a dispute to this second step to arrive at a satisfactory settlement thereof. Meeting minutes shall be kept by the Contractor. If the parties fail to reach an agreement, the dispute may be appealed by the Union, in writing, in accordance with the provisions of Step 3.

Step 3. (a) If the grievance has been submitted but not adjusted under Step 2, either party may request in writing, within seven (7) calendar days thereafter, that the grievance be submitted to an Arbitrator mutually agreed upon by them. The Contractor and the involved Union shall attempt mutually to select an arbitrator, but if they are unable to do so, they shall request the Federal Mediation and Conciliation Services (FMCS) to provide them with a list of arbitrators from which

the Arbitrator shall be selected. The rules of FMCS shall govern the conduct of the arbitration hearing. The decision of the Arbitrator shall be final and binding on all parties. The fee and expenses of such Arbitration shall be borne equally by the Contractor and the involved Local Union(s).

Section 4. Failure of the grieving party to adhere to the time limits established herein shall render the grievance null and void. Failure of the Contractor to adhere to the time limits established herein shall result in the grievance being sustained. The time limits established herein may be extended only by written consent of the parties involved at the particular step where the extension is agreed upon. The Arbitrator shall have the authority to make decisions only on issues presented to him or her, and he or she shall not have authority to change, amend, add to or detract from any of the provisions of this Agreement.

Section 5. The Owner shall be notified of all actions at Steps 2 and 3 and shall, upon their request, be permitted to participate in all proceedings at these steps.

ARTICLE VIII

JURISDICTIONAL DISPUTES

Section 1. The assignment of work will be the responsibility of the Contractor performing the work involved and such work assignments will be in accordance with decisions issued under the Plan for the Settlement of Jurisdictional Disputes in the Construction Industry (the "Plan"), or any successor Plan, adopted by the National Building and Construction Trades Department.

Section 2. All jurisdictional disputes on this Project, between or among Building and Construction Trades Unions and employers, parties to this Agreement, shall be settled and adjusted according to the present Plan established by the Building and Construction Trades Department or any other plan or method of procedure that may be adopted in the future by the Building and Construction Trades Department. Decisions rendered shall be final, binding and conclusive on the Contractors and Unions parties to this Agreement.

Section 3. All jurisdictional disputes shall be resolved without the occurrence of any strike, work stoppage, or slow-down of any nature, and the Contractor's assignment shall be adhered to until the dispute is resolved. Individuals violating this section shall be

subject to immediate discharge.

Section 4. Each Contractor will conduct a pre-job conference with the appropriate Council prior to commencing work. The Owner will be advised in advance of all such conferences and may participate if they wish.

ARTICLE IX

MANAGEMENT'S RIGHTS

Section 1. Exclusive Owner - Workforce. Except as otherwise provided in this Agreement, the Owner (or its designee) and the Contractors retain the authority to manage their operations and workforces.

Section 2. Materials, Design, Machinery, Equipment. There shall be no limitation or restriction by a signatory Union upon a Contractor's choice of materials or design, nor, regardless of source or location, upon the full use and utilization of equipment, machinery packaging, pre-cast, pre-fabricated, pre-finish, or pre-assembled materials, tools or other labor saving devices. The on-site installation or application of all items shall be performed by the craft having jurisdiction of such work; provided, however, that installation of specialty items may be performed by employees employed under this Agreement who may be directed by other personnel in a supervisory role, in circumstances requiring special knowledge of the particular items.

Section 3. New Technology, Equipment. The use of new technology, equipment, machinery, tools and/or labor saving devices and methods of performing work may be initiated by any Contractor from time to time during the Project. The Union agrees that it will not in any way restrict the implementation of such new devices or work methods.

Section 4. Disputes. If there is any disagreement between any Contractor and the Union concerning the manner or implementation of such device or method of work, the implementation shall proceed as directed by the Contractor, and the Union shall have the right to grieve and/or arbitrate the dispute as set forth in Article VII of this Agreement.

ARTICLE X

WORK STOPPAGES

Section 1. No Strikes or Work Disruptions. There shall be no strike, sympathy strike, jurisdictional strike, recognitional strike, slowdown, sabotage, work to

rule, sickout, sit down, picketing of any type (including informational picketing), handbilling, boycott, interruption of work or any disruptive activity that interferes with or interrupts in any way work on the Project. The applicable local union shall not sanction, aid or abet, encourage or continue any work stoppage, strike, picketing or other disruptive activity which violates this Article and shall undertake all reasonable means to prevent or to terminate any such activity. No employee shall engage in activity which violates this Article. Any employee who participates in or encourages any activity which violates this Article shall be subject to disciplinary action, including discharge, and if justifiably discharged for the above reasons, shall not be eligible for rehire on the same project for a period of not less than ninety (90) days. Further, if the Local Union is unable to provide qualified replacements for those employees who are in violation of this Article by the beginning of the next shift, the Employer is free to hire from any source.

Section 2. Union Responsibilities. The Local Union shall not be liable for acts of employees for which it has no responsibility. The principal officers of the Local Union will immediately instruct, order and use their best efforts to cause the members of the Local Union they represent to cease any violations of this Article. If it complies with this obligation, the Local Union shall not be responsible for unauthorized acts of employees it represents.

ARTICLE XI

WAGES AND BENEFITS

Section 1. Wages. All employees covered by this Agreement shall be classified in accordance with work performed and paid 100% of the wages and 100% of the fringe benefits as established in the respective Union's Local Area Collective Bargaining Agreement and any subsequent modifications thereto. The Contractor, upon request, shall provide the Unions and Owner with substantiation that wages and benefits are being paid on the Project. The Unions shall provide the Owner, and any Contractor or subcontractor that is party to this Agreement, with wage, fringe benefit and dues reporting forms.

Section 2. Payment of Benefits/Contributions. Each Contractor will also pay all required contributions in the amounts required by Section 1 of this Article to the established employee benefit funds that accrue to the direct benefit of the employees

(such as pension and annuity, health and welfare, vacation, apprenticeship, training funds). With respect to contributions required in this Section to Employer-Union jointly trusted funds, the Contractor adopts and agrees to be bound by the written terms of the legally established trust agreement specifying the detailed basis on which payments are to be made into, and benefits paid out of, such Trust Funds. The Contractor authorizes the parties to such Trust Funds to appoint Trustees and successor Trustees to administer the Trust Funds and hereby ratifies and accepts the Trustees so appointed as if made by Contractor.

Section 3. Non-Affiliated Labor Organizations. The Contractor shall deduct from each employee's wages all uniform dues and working assessments the employee has voluntarily authorized in writing as set forth in the Employee's Local Collective Bargaining Agreement. If a labor organization is not affiliated with the Council, and supplies its members or referrals for work on the Project, such labor organization shall pay to the Council the dues and assessments it would owe the Council if affiliated, for all periods during which the labor organization has members or referrals working on the Project. Any disputes under this paragraph shall be resolved exclusively between the labor organization and the Council by using the grievance procedure appearing in Article VII, as provided herein. All grievances shall be reduced to writing within thirty (30) days of the date on which the aggrieved party discovered the dispute. The grievance shall be initiated at Article VII, Section 3, Step 3.

ARTICLE XII
LOCAL UNION NEGOTIATIONS DURING
THE PENDENCY OF THE AGREEMENT

Section 1. All parties to this Agreement understand and acknowledge that some crafts who will be working on the Project are covered by local collective bargaining agreements that will expire prior to the projected completion of the Project. All parties understand and agree that irrespective of whether such local collective bargaining agreement negotiations are successful or unsuccessful, there shall be no strike, sympathy strike, jurisdictional strike, recognitional strike, slowdown, sabotage, work to rule, sickout, sit down, picketing of any type (including informational picketing), handbilling, boycott, interruption of work or any disruptive activity that interferes with or

interrupts in any way work on the Project by any Union involved in such local negotiations, or by any of its members, nor shall there be any lockout by a Contractor on the Project affecting such union or its members during the course of such negotiations. Irrespective of the status of any such local collective bargaining agreement negotiations, the affected Union and all of its members will observe and fully comply with the provisions of this Agreement. Should any Local Union fail or refuse to provide and/or refer qualified employees for work on the Project during an economic strike, any affected Contractor shall be permitted to utilize the procedures appearing in Article VI, Section 5 of this Agreement.

Section 2. Wage/Benefit Increases. Should a craft covered by this Agreement negotiate an increase in wages or an increase in benefits with any Contractor to become effective during the term of the Project, those wage and/or benefit increases shall be paid by the affected Contractor, as of the effective date of those increases, to those employees in that craft performing work covered by this Agreement.

ARTICLE XIII

HOURS OF WORK, OVERTIME, SHIFTS AND HOLIDAY

Section 1. Work Day and Work Week. Except as provided in Section 4, the first shift shall consist of eight (8) or ten (10) hours per day between the hours of 6:00 a.m. and 5:30 p.m., plus one-half (1/2) hour unpaid for lunch, approximately mid-way through the shift. Forty (40) hours per week shall constitute a regular week's work, whether consisting of five (5) eight (8) hour days, or four (4) ten (10) hour days. The work week will start on Monday and conclude on Sunday. A uniform starting time will be established for all crafts on each project or segment of the work. Nothing herein shall be construed as guaranteeing any employee eight (8) or ten (10) hours per day or forty (40) hours per week. The Union(s) shall be informed of the work starting time set by the contractor at the pre job conference which may be changed thereafter upon three (3) days' notice to the Union(s) and the employees. A second shift, if used, shall consist of eight hours between 3:00 p.m. and 1:00 a.m.; a third shift, if used, shall begin between 10:00 p.m. and 1:00 a.m. For purposes of Section 3, the third shift shall be considered as part of the prior day's work.

Section 2. Starting Times. Employees shall be at their place of work at the starting time and shall remain at their place of work (as designated by the Contractor)

performing their assigned functions until quitting time, which is defined as the scheduled end of the shift. The parties reaffirm their policy of a fair day's work for a fair day's wage. There shall be no pay for time not worked unless the employee is otherwise engaged at the direction of the Contractor.

Section 3. Overtime. Overtime shall be defined as all hours worked in excess of forty (40) hours in a work week or, for 8 hour shifts, in excess of eight (8) hours per day; or for 10 (ten) hour shifts for work in excess of 10 hours per day; such work and work performed on Saturdays shall be paid at one and one-half times the straight time rate of pay. However, in scheduled four (4) day/ten hour shift work weeks, Friday may be scheduled as a "makeup" day at straight time to make up for a day lost (Monday through Thursday) due to inclement weather. In addition, if a "make-up" day is scheduled, all employees directed to work on such day will be guaranteed a minimum of four (4) hours work or pay. In any week in which employees on the Project are scheduled on four/ten hour shifts, an employee whose first day of work on the Project begins on Wednesday or later day of the schedule shall be paid, during the first week of his employment only, time-and-one-half for all hours worked in excess of eight in a day or each day he works during said week. Work on Sundays and holidays shall be at double time. There shall be no restriction on any contractor's scheduling of overtime or the non-discriminatory designation of employees who will work. The contractor shall have the right to schedule work so as to minimize overtime. There shall be no pyramiding of overtime pay under any circumstances.

Section 4. Shifts.

- (a) Shift work may be performed at the option of the Contractor(s) upon three (3) days' prior notice to the Union and shall continue for a period of not less than five (5) working days. Saturdays and Sundays, if worked, may be used for establishing the five (5) day minimum work shift. If two shifts are worked, each shall consist of eight (8) hours of continuous work exclusive of a one-half (½) hour non-paid lunch period. Any third shift shall consist of seven (7) hours of continuous work exclusive of one-half (½) hour non-paid lunch period for eight (8) hours pay. A premium of \$.25 per hour shall be paid for work on the second shift and \$.50 per hour for work on the third shift.
- (b) The Contractor may establish a work week of four (4) consecutive ten (10)

hour work days (exclusive of one-half (½) hour unpaid lunch, approximately midway through the shift) between Monday through Thursday.

Section 5. Minimum Pay. An employee who reports for work at the regular starting time and for whom no work is provided shall receive pay equivalent to two (2) hours at the applicable hourly rate, provided the employee at the employer's discretion remains available for work. Any employee who reports for work and for whom work is provided shall be paid for actual time worked but not less than two (2) hours. It will not be a violation of this agreement when the employer considers it necessary to shut down to avoid the possible loss of human life, because of an emergency situation that could endanger the life and safety of an employee. In such cases, employees will be compensated only for the actual time worked. In the case of a situation described above where the employer requests employees to remain available for work, the employees will be compensation for such time. If a project is shut down because of weather, employees, who report for work, shall be paid actual time worked but not less than two (2) hours. Procedures for prior notification of work cancellation shall be determined at the pre-job conference. The provisions of this section are not applicable where the employee voluntarily quits or lays off.

Section 6. Holidays. Holidays shall be New Year's Day, Good Friday, Memorial Day, Independence Day, Labor Day, Veteran's Day, Thanksgiving Day, the Day after Thanksgiving Day, and Christmas Day. A holiday falling on Saturday shall be observed on the preceding Friday. A holiday falling on Sunday shall be observed on the following Monday.

Section 7. Meal Period. The Contractor will schedule a meal period of not more than one-half hour duration at the work location at approximately the mid-point of the scheduled work shift (4 hours in a five day work week, 5 hours in a four-day work week), consistent with Section 1; provided, however, that the Contractor may, for efficiency of the operation, establish a schedule which coordinates the meal periods of two or more crafts. If an employee is required to work through his meal period, he shall be compensated for the time worked at the applicable overtime rate and the employee shall, when work permits, eat his lunch "on the fly".

Section 8. No Organized Work Breaks. There will be one (1) break during the first four (4) hours of a shift which shall be taken at the employee's work station.

Individual nonalcoholic beverage containers will be permitted at the employee's work station.

Section 9. Helmets to Hardhats.

- (a) The Employers and the Unions recognize a desire to facilitate the entry into the building and construction trades of veterans who are interested in careers in the building and construction industry. The Employers and Unions agree to utilize the services of the Center for Military Recruitment, Assessment and Veterans Employment (hereinafter "Center") and the Center's "Helmets to Hardhats" program to serve as a resource for preliminary orientation, assessment of construction aptitude, referral to apprenticeship programs or hiring halls, counseling and mentoring, support network, employment opportunities and other needs as identified by the parties.
- (b) The Unions and Employers agree to coordinate with the Center to create and maintain an integrated database of veterans interested in working on this Project and of apprenticeship and employment opportunities for this Project. To the extent permitted by law, the Unions will give credit to such veterans for bona fide, provable past experience.

ARTICLE XIV

APPRENTICES

Section 1. Need For. The parties recognize the need to maintain continuing support of programs designed to develop adequate numbers of competent workers in the construction industry. The Contractor(s) will, accordingly, employ apprentices in their respective crafts to perform work on the Project in accordance with Section 2 below.

Section 2. Ratios. The Union agrees to cooperate with the Contractor in furnishing qualified apprentices as requested and if available. Apprentices shall perform the work of their craft in accordance with the ratios and terms in their local area collective bargaining agreements. To the extent requested by Owner, the Contractor(s) may use the maximum number of apprentices permitted by local collective bargaining agreements.

ARTICLE XV

DRUG AND ALCOHOL POLICY

Section 1. Drug and Alcohol Policy. All parties understand and agree that a drug and alcohol policy, approved by the Council, will be in force for all work performed under the Agreement. The drug and alcohol policy will prohibit the use, sale, transfer, purchase and/or possession of a controlled substance, alcohol and/or firearms while on the Project's premises and will require testing of employees. The drug and alcohol policy, attached hereto as Appendix 2, is incorporated into and made part of this Agreement and is implemented for all Contractors and employees working on the Project.

ARTICLE XVI

NON-DISCRIMINATION

Section 1. Policy. It is the continuing policy of the Owner, the Contractors and the Unions that the provisions of this Agreement shall be applied without discrimination because of age, race, sex, color, religion, creed, national origin, sexual orientation or any other basis prohibited by applicable law.

ARTICLE XVII

SOLE AND COMPLETE AGREEMENT

Section 1. The parties agree that this Agreement constitutes the sole and complete agreement between them governing the rates of pay and working conditions of the construction employees working on the Project. This Agreement settles all demands and issues on the matters subject to collective bargaining and shall not be modified or supplemented in any way except by written agreement executed by the Owner and all parties.

ARTICLE XVIII

SEPARABILITY AND SAVINGS CLAUSE

Section 1. Intent of Parties. If any article or section of this Agreement shall be held invalid by law or by a tribunal of competent jurisdiction, or if compliance with or enforcement of any article should be restrained pending a final determination as to its validity, the remainder of this Agreement shall not be affected and shall remain in full force and effect. In the event that any article or section is held invalid, the parties hereto shall, upon the request of the Unions, enter into collective bargaining negotiations for

the purpose of arriving at a mutually satisfactory replacement for such article during the period of invalidity or restraint. If the Owner and the Council cannot agree on a mutually satisfactory replacement, either party shall be permitted to submit its demand to formal interest arbitration under the Rules of Federal Mediation and Conciliation Service.

Section 2. Force of Agreement. The parties recognize the right of the Owner to withdraw, at its absolute discretion, the utilization of this Agreement as part of any bid specification should a court of competent jurisdiction issue any order which could result, temporarily or permanently, in a delay of the bidding, awarding, and/or construction work on the Project. Notwithstanding such an action by the Owner, or such court order, the parties agree that the Agreement shall remain in full force and effect on the Project, to the maximum extent legally possible. It is hereby agreed that this Agreement covers all of the signatory local unions listed below.

Section 3. Delegation. The Owner, in its sole and absolute discretion has the right to delegate its duties hereunder to a representative and/or designee who may be either an employee of Owner or a third party with whom Owner has contracted for contractor services.

OWNER
CITY OF CANTON

EAST CENTRAL OHIO BUILDING &
CONSTRUCTION TRADES COUNCIL,
AFL-CIO

[Signature]

[Signature]

Director of Public Service

PRESIDENT

APPROVED AS TO FORM ^{PKS}

BOILERMAKERS LOCAL NO. 744

[Signature]

By: [Signature]

CITY OF CANTON
DIRECTOR OF LAW

Name: MARTIN D. MAHON

Title: BUSINESS MEMBER

Date: 12.7.2020

BRICKLAYERS LOCAL 6

By: [Signature]

Name: Justin M. Gortrell

Title: Field Representative

Date: 12-18-20

ELECTRICIANS LOCAL NO. 540

By: [Signature]

Name: AARON M. BROWN

Title: BUSINESS MANAGER / F.S.

Date: 12/8/2020

**GENERAL TRUCK DRIVERS &
HELPERS UNION LOCAL NO. 92**

By: Warren Brustoski

Name: Warren Brustoski

Title: B.A.

Date: 12-8-2020

GLAZIERS LOCAL NO. 1162

By: Scott Harter

Name: Scott Harter

Title: B.A.

Date: 12-17-20

**HEAT & FROST INSULATORS AND
ALLIED WORKERS LOCAL
NO. 84**

By: _____

Name: _____

Title: _____

Date: _____

**INDIANA/KENTUCKY/OHIO
REGIONAL COUNCIL OF
CARPENTERS**

By: Kevin M. Ennis II

Name: Kevin M. Ennis II

Title: Senior Business Representative

Date: 12/8/2020

IRONWORKERS LOCAL NO. 550

By: _____

Name: _____

Title: _____

Date: _____

LABORERS LOCAL NO. 1015

By: Jake Croston Jr

Name: Jake Croston Jr

Title: Business Manager

Date: 12/18/2020

**INDIANA/KENTUCKY/OHIO
REGIONAL COUNCIL OF
CARPENTERS**

By: _____

Name: _____

Title: _____

Date: _____

IRONWORKERS LOCAL NO. 550

By: William U. Sherer II

Name: William U. Sherer II

Title: Business Manager

Date: 11-7-20

LABORERS LOCAL NO. 1015

By: _____

Name: _____

Title: _____

Date: _____

**MILLWRIGHT PILEDRIVER LOCAL
NO. 1090**

By: Kevin M. Ennis II
Name: Kevin M. Ennis II
Title: Senior Business Representative
Date: 12/8/2020

**OPERATIVE PLASTERERS' AND
CEMENT MASONS LOCAL NO. 109**

By: _____
Name: _____
Title: _____
Date: _____

PAINTERS LOCAL NO. 603

By: Scott Heater
Name: Scott Heater
Title: B.A.
Date: 12-17-20

**MILLWRIGHT PILEDRIVER LOCAL
NO. 1090**

By: _____

Name: _____

Title: _____

Date: _____

**OPERATIVE PLASTERERS' AND
CEMENT MASONS LOCAL NO. 109**

By: Greg Daniels

Name: Greg Daniels

Title: BM / FS

Date: 12-7-2020

PAINTERS LOCAL NO. 603

By: _____

Name: _____

Title: _____

Date: _____

**PLUMBERS, PIPEFITTERS AND
REFRIGERATION LOCAL NO. 94**

By: DAVE KIKUEN
Name: DAVE KIKUEN
Title: BUSINESS MANAGER
Date: 12/18/2020

ROOFERS, LOCAL UNION NO. 88

By: Barbara A Dixon
Name: BARBARA A. DIXON
Title: BUSINESS MANAGER
Date: 12-7-2020

**SHEET METAL WORKERS LOCAL
NO. 33**

By: Jerry Durieux
Name: JERRY DURIEX
Title: BUSINESS AGENT
Date: 12/17/2020

Name:

Title:

Date:

**SHEET METAL WORKERS LOCAL
NO. 33**

By:

Name:

Title:

Date:

**SPRINKLER FITTERS LOCAL
NO. 669**

By:

S M MURPHY

Name:

SEAN M. MURPHY

Title:

Union Rep.

12-7-20

APPENDIX 1
LETTER OF ASSENT TO THE PROJECT LABOR AGREEMENT

FOR THE 12TH STREET NW / WHIPPLE AVENUE NW WATER MAIN
REPLACEMENT PROJECT

Pursuant to Article I, Section 1 of the Project Labor Agreement (the "Agreement") for the 12th Street NW / Whipple Avenue NW Water Main Replacement Project, the undersigned party hereby agrees that it will comply with and be bound by all of the terms and conditions of the Agreement and agrees to all approved amendments or revisions thereto.

This Letter of Assent shall ONLY apply to the above-referenced Project and shall remain in effect for the duration of the above-referenced Project, after which this understanding will automatically terminate without further notice.

For the Contractor (or Subcontractor of whatever tier):

Name of Contractor/Subcontractor: _____

Name and Signature of Authorized Person:

(Print Name) _____

(Title) _____

(Signature) _____

(Phone #) _____

(Date) _____

APPENDIX 2
EMPLOYEE DRUG AND ALCOHOL TESTING POLICY
SPECIFICATIONS

The Owner is committed to providing a safe workplace for the workers assigned the Project, promoting high standards of employment health, and fostering productivity that satisfies its quality expectations. Consistent with the intent and spirit of this commitment, the Owner and ECOB & CTC have established a substance abuse testing specification for the Project with the goal of maintaining a work environment that is free from the effects of the use of illegal drugs and alcohol. The Owner will implement the terms of this policy.

This specification is not intended as a substitute for the Contractors' complete written substance abuse policy. Normally, such policies include other important features, including, but not limited to, an employee education and awareness Program, a supervisor training program and an employee assistance program.

The policy for this Project requires that any construction employee entering the project site will comply with the substance abuse testing requirements as outlined in this section. The Owner reserves the right to amend this specification upon written notice to the Contractor and the Unions on the Project. The parties to this agreement shall recognize the Drug Free Work Site Program as implemented through participating Unions and/or Contractors as administered by the contractor, or for contractors who are not signatory to agreements with signatory unions belonging to ECOB & CTC, and their core employees, an equivalent program that meets the specifications, contractual requirements, and testing requirements as set forth in this Appendix 1.

CONTRACTUAL REQUIREMENTS

All Contractors must have and enforce a written Substance Abuse Program incorporating the testing requirements, term, and conditions set forth in this specification. This specification is applicable to all employees, current and prospective, in order to be eligible to perform work at the Project. The Contractors must comply with the specification. Supplies, vendors, and visitors are subject to confirmation of their abstinence from the possession or use of substances indicated in this specification. A copy of each contractor's substance abuse program must be

submitted to the Owner for approval prior to commencement of any work on the Project site.

The substance abuse program must apply to all employees working on the Project and subcontractors' of any of tier working on the Project site. This includes workers, new hires, replacement workers, and supervisory personnel. No employee or prospective employee of a Contractor shall be permitted to work on the Project site unless such employee has submitted to testing by this specification and unless the results of such testing are negative as hereinafter defined. The Contractor must provide the Owner with a Monthly Summary Report of the Substance Abuse Program compliance.

All Contractors must train their respective employees in methods that will allow them to recognize substance abusers. Supervisory Employees of the Owner or its subcontractor shall be trained to take action, and to confront a substance abuser in a manner consistent with generally accepted safety-training procedures.

The cost of implementing the Substance Abuse program shall be borne by each respective Contractor affected by this specification.

Suppliers, vendors, and visitors must become signatory to the terms of this specification and their abstinence from substance abuse, and their continued avoidance of violations of the specification at the project site. Furthermore, in the event of an incident and/or accident occurrences involving suppliers, vendors, and/or visitors, the same agrees to submit to the substance abuse testing when requested. Refusal to comply would be grounds to have the supplier, vendor, or visitor permanently barred from the Project site by regulators.

TESTING REQUIREMENTS

The Project requires:

- Post-offer/Pre-engagement drug and alcohol testing.
- Testing for reasonable suspicion of illegal drug use or alcohol use.
- Post accident and post incident drug and alcohol testing upon reasonable suspicion.
- Drug testing following discovery of illegal or unauthorized drugs or paraphernalia as creating reasonable suspicion.

All Prime Contractors must perform post-offer/pre-engagement, and post

accident/incident testing upon reasonable suspicion, as follows:

- a. All drug testing must be conducted by a National Institute of Drug Abuse (NIDA) certified laboratory with test results interpreted by a licensed medical review officer (MRO).
- b. The initial screen tests for alcohol shall be performed by using either a saliva test or breathalyzer test comparable to the type used by state or local law enforcement officials. Furthermore, alcohol confirmatory tests shall be performed by using either blood alcohol test or a Breathalyzer test comparable to the type used by state or local law enforcement officials.
- c. Evidence of the negative test results of individual employees required by this specification shall be furnished to the Owner prior to the commencement of work by the individual employee and promptly after performance of any subsequent testing required by this specification. Acceptable negative test result format.
 - A certificate signed by the testing laboratory, setting forth the nature and results of performed; or
 - An identification card signed by the respective Prime Contractor and issued to the individual employee, setting forth as reported on a certificate issued by the testing laboratory. The name of the testing laboratory shall also appear on the identification card; provided the affected employee authorizes the issuance of such identification card.

COMPLIANCE PROCEDURE

The Owner reserves the right to audit any substance abuse program required by this specification to verify compliance results within twenty-four (24) hours of notification of the intent to audit. The Owner shall have free right of access to all relevant records of the Prime Contractor and their subcontractors and supplies for this purpose, provided such record disclosures are within the scope of the States guidelines pertaining to confidentiality of employee records.

The Contractor's pre-engagement employees who receive a positive test result shall immediately leave the Project Site. Transportation of employees receiving the positive test result is the direct responsibility of the employing Prime Contractor, including employees of its subcontractors. Furthermore, pre-engagement employees

receiving a positive test shall not be permitted to return to the Project Site earlier than 90 days from the date of the positive test. At this time the employee may begin the process outlined by this specification again.

DEFINITIONS/ CONFIDENTIALITY/RULES- DISCIPLINARY ACTIONS- GRIEVANCE PROCEDURES

1. DEFINITIONS:

- (a) Company Premises - the term "Company Premises" as used in this policy includes all property, facilities, land, building, structures, automobiles, trucks and other vehicles owned, leased or used by the Contractor on the Project. Construction job sites for which the Contractor has responsibility are included.
- (b) Prohibited Items & Substances - Prohibited substances include illegal drugs (including controlled substances, look alike drugs and designer drugs, alcoholic beverages, and drug paraphernalia in the possession of or being used by an employee on the job.
- (c) Employee - Individuals, who perform work for the Contractor, including, but not limited to management, supervision, engineering, craft workers and clerical personnel.
- (d) Accident - Any event resulting in injury to a person or property to which an employee, or contractor/contractor's employee, contributed as a direct or indirect cause.
- (e) Incident - An event which has all the attributes of an accident, except that no harm was caused to person or property.
- (f) Reasonable Cause - Reasonable cause shall be defined as tardiness, excessive absenteeism, and erratic behavior such as noticeable imbalance, incoherence, and disorientation.

2. CONFIDENTIALITY

- (a) All parties to this policy and program have only the interests of employees in mind; therefore, encourage any employee with a substance abuse problem to come forward and voluntarily accept our assistance in dealing with the illness. An employee assistance program will provide guidance and direction for you during your recovery period. If you volunteer for help, the Contractor

will make every reasonable effort to return you to work upon your recovery. The Contractor will also take action to assure that your illness is handled in a confidential manner.

- (b) All actions taken under this policy and program will be confidential and disclosed only to those with a "need to know."
- (c) When a test is required, the specimen will be identified with a code number, not by name, to insure confidentiality of the donor. Each specimen container will be properly label and made tamper proof. The donor must witness this procedure.
- (d) Unless an initial positive result is confirmed as positive, it shall be deemed negative and reported by the laboratory as such.
- (e) The handling and transportation of each specimen will be properly documented through the strict chain of custody procedures.

3. **RULES** - all employees must report to work in a physical condition that will enable them to perform their jobs in a safe and efficient manner. Employees shall not:

- (a) Use, possess, dispense or receive prohibited substances on or at the Project job site; or
- (b) Report to work at or on the Project with any measurable amount of prohibited substances in their system.

4. **DISCIPLINE** - When the Contractor has reasonable cause to believe an employee is under the influence of a prohibited substance, for reasons of safety, the employee may be suspended until test results are available. If no test results are received after three (3) working days, the employee, if available, shall return to work with back pay. If the test results prove negative, the employee shall be reinstated with back pay. In all other cases:

- (a) Applicants testing positive for drug use will not be hired.
- (b) Employees who have not voluntarily come forward, and who test positive for a drug use, will be terminated.
- (c) Employees who refuse to cooperate with testing procedures will be terminated.
- (d) Employees found in possession of drugs or drug paraphernalia will be terminated.

(e) Employees found under the influence of alcohol while on duty, or while operating a company vehicle, will be subject to termination.

5. PRESCRIPTION DRUGS - Employees using a prescribed medication which, in their physician's opinion, may impair the performance of their duties, either mental or motor functions, must immediately inform the supervisor of such prescription drug use if instructed by their physician to do so. For the safety of all employees, the Contractor will consult with you and your physician to determine if a reassignment of duties is necessary. The Contractor will attempt to accommodate your needs by making an appropriate reassignment. However, if a reassignment is not possible, you will be placed on temporary medical leave until released as fit for duty by the prescribing physician.

Appendix B

PREVAILING WAGE COORDINATOR

The City of Canton has designated Cheryl Southwell as Prevailing Wage Coordinator, in accordance with Section 4115.071 of the Ohio Revised Code.

Her office is located at City of Canton, 218 Cleveland Ave SW, Canton, Ohio 47702
Cheryl Southwell: 330-438-4183

CONTRACTORS SUBMISSIONS TO THE WAGE COORDINATOR:

- 1) Contractors are required to supply to the Wage Coordinator, **a schedule of the dates during the life of the contract with City of Canton on which they are required to pay wages to the employees.** See Section 4115.03 (A) (2)
- 2) Contractors shall also deliver to the Wage Coordinator **a certified copy of the payroll within two weeks after the initial pay date and supplemental reports for each month thereafter, which shall exhibit for each employee, their name, current address, social security number, job classification, number of hours worked for project, rate of pay, project gross pay, fringe payments, total hours all jobs, total gross all jobs, and deductions from their wages.** See Section 4115.03 (A) (3)
- 3) If the life of the contract is expected to be no more than four months from the beginning of performance by the contractor or subcontractor, such supplemental reports shall be filed each week after the initial report. See Section 4115.03 (A) (6) (C)
- 4) The certification of each payroll shall be executed by the contractor, subcontractor, or duly appointed agent thereof and **include a State of Compliance** stating that the payroll is correct and complete and that during the payroll period, all persons employed on said project have been paid the full weekly wages earned, that no rebates have or will be made either directly or indirectly to, or on behalf of said contractor or subcontractor for the full weekly wages earned by any person and that no deductions have been made either directly or indirectly from the full wages earned by any person, other than permissible deductions. See Section 4115.03 (A) (6) (C)
- 5) Contractors will also provide **each month a copy of any Labor Union Fringe Benefit Fund reports that they submitted to the unions.** See Section 4115.03

PREVAILING WAGE COORDINATOR MONITORING PROCEDURES

The wage Coordinator's duties are those specified in Section 4115.071 and shall include:

- 1 Attend Pre-Construction Meetings to advise contractor of Prevailing Wage responsibilities
- 2 Wage Coordinator has the authority to spot check employees pay checks in the field on the scheduled pay days for full compliance, with regard to the prevailing wage rates, including benefits.

- 3 Wage Coordinator shall visit the project site to get names of employees performing work on the project site, to cross check with payroll reports submitted.
- 4 Wage Coordinator shall verify the subcontractors performing work on the project site with regard to whether they have been approved by the contracting authority.
- 5 Wage Coordinator shall check to see that the prevailing wages are posted on the project site in a place accessible to employees.
- 6 Ascertain that the statement of compliance accompanying the certified payroll is the correct one for the project
- 7 Wage Coordinator has the right to request any addition information they feel is required for proper wage verification.
- 8 Contact Contractors of delinquent payrolls
- 9 Notify contractors when necessary to request payroll corrections
- 10 Investigate wage complaints ,by self or with Ohio Department of Commerce Division of Labor & Worker Safety

PAYROLL DATES PREVAILING WAGE LAW

Instructions to the Contractor: Please read the following and provide the required information noted on this form. This document must be submitted to the Prevailing Wage Coordinator for the public authority on or before your company begins any work under a contract for a public improvement. This requirement is also applicable to your subcontractors. Please make a copy of this document available to them. The prevailing wage laws state that contractors are responsible for their subcontractors.

.....

_____ will begin performance under contract on the
(Name of Contractor)

_____ project on _____
(Name and Location of Project) (Start Date)

and will conclude work on said project on _____
(End Date, if known)

In accordance with Section 4115.071 (C) of the Ohio Revised Code, listing of payroll dates, I hereby submit the following schedule of dates that my company is required to pay wages to its workers while on this project.

NOTE: If the life of the project is expected to be over three (3) months in length, provide only the days of the week your pay period starts and ends, plus the day you pay your workers.

_____	_____	_____
_____	_____	_____
_____	_____	_____
_____	_____	_____

Day Pay Period Starts: _____ Day Pay Period Ends: _____

Pay Day: _____

I acknowledge that I am required by section 4115.071 (C) of the Ohio Revised Code that I must submit a copy of my company's certified payroll records for this project to the Prevailing Wage Coordinator of the public authority within two weeks of the initial pay date listed above. I further acknowledge that I am responsible to collect and submit my subcontractor's prevailing wage documents, including their certified payroll records in accordance with the law.

(Contractor's Signature and Title)

(Company Name)

(Date)

LETTER OF AUTHORIZATION FOR PAYROLL SIGNATURE:

DATE: _____

COMPANY NAME: _____

ADDRESS: _____

FEDERAL I.D.# _____

RE: _____

(Project Name)

(Project Number)

(Address)

_____ hereby authorizes

(Company Officer/Owner-Title)

_____ as the person to

complete and sign all certified payroll forms for the above project.

BY: _____

(Print Name)

(Signature)

(Title)

Sworn and subscribed in my presence this _____ day of _____ 20__

Notary Public

FRINGE BENEFITS

PLEASE COMPLETE THIS FORM AND RETURN IT TO THE ADDRESS BELOW.

_____ FRINGE BENEFITS ARE ALL PAID IN CASH TO THE EMPLOYEE.

_____ FRINGE BENEFITS ARE PAID IN CASH AND TO THE BENEFIT PROGRAMS LISTED BELOW.

_____ FRINGE BENEFITS ARE ALL PAID TO THE FOLLOWING BENEFIT PROGRAMS:

HEALTH & WELFARE PLAN: _____

ADDRESS: _____

PENSION PLAN: _____

ADDRESS: _____

APPRENTICESHIP PROGRAM: _____

YOUR COMPANY IS: _____ UNION _____ NON-UNION

YOUR COMPANY PAYS ALL EMPLOYEES: _____ WEEKLY _____ BI-WEEKLY

FORWARD A BLANK FORM TO EACH SUBCONTRACTOR ON THE PROJECT FOR COMPLETION.
RETURN ALL FORMS TO:

CITY OF CANTON
218 CLEVELAND AVE SW
CANTON, OHIO 44702
ATTN: PREVAILING WAGE COORDINATOR

CONTRACTOR'S NAME: _____

ADDRESS: _____

PROJECT NAME: _____

PREVAILING WAGE NOTIFICATION to EMPLOYEE

4115.05the contractor or subcontractor shall furnish each employee not covered by a collective bargaining agreement written notification of the job classification to which the employee is assigned, the prevailing wage determined to be applicable to that classification, separated into the hourly rate of pay and the fringe payments, and the identity of the prevailing wage coordinator appointed by the public authority. The contractor or subcontractor shall furnish the same notification to each affected employee every time the job classification of the employee is changed.

Project Name:	Job Number.
Contractor:	
Project Location:	
Jobsite posting of prevailing wage rates located:	

Prevailing Wage Coordinator	Employee
Name: City of Canton Attn: Cheryl Southwell	Name:
Street: 218 Cleveland Ave SW 6th Floor	Street:
City: Canton	City:
State/Zip: Ohio 44702	State/Zip:
Phone: 330-438-4183	Phone:

You will be performing work on this project that falls under these classifications. You will be paid the appropriate rate for the type of work you are performing.

Classification:	Prevailing Wage Rate Total Package:	Minus your fringe benefits:	Your hourly base rate:

Hourly fringe benefits paid on your behalf by this company:

Fringe	Amount	Fringe	Amount
Health Insurance		Vacation	
Life Insurance		Holiday	
Pension		Sick Pay	
Bonus		Training	
Other		Total Hourly Fringes	

Contractor's Signature:	Date:
Employee's Signature:	Date:

INSTRUCTIONS FOR PREPARING CERTIFIED PAYROLL REPORTS

General:

Contractors and subcontractors are required by law to submit certified payroll reports for work on projects covered by Ohio's Prevailing Wage Law. This form meets the reporting requirements established by Ohio Revised Code Chapter 4115. The use of this form is not mandatory; employers may submit their own forms provided that all of the required information is included. This form may be reproduced, or additional copies obtained from:

Ohio Department of Commerce
Division of Industrial Compliance
Bureau of Wage and Hour Administration
6606 Tusling Road, P.O. Box 4009
Reynoldsburg, Ohio 43068-9009
614-644-2239
www.com.ohio.gov

Certified Payroll Heading:

Employer name and address: Company's full name and address... Indicate if the company is a subcontractor.

Subcontractor: Check and list the name of the General Contractor or Prime.

Project: Name and location of the project, including county.

Contracting Public Authority: Name and address of the contracting public authority... (Owner of the project).

Week Ending: Month, day, and year for last day of reporting period.

Payroll #: Indicates first, second, third, etc. payroll filed by the company for the project.

Page indicator: number of pages included in the report.

Project Number: Determined by the public authority... If there is no number leave blank.

Payroll Information by column:

1. **Employee Name, Address and Social Security number:** This information must be provided for all employees that perform physical labor on the project. The Social Security number is required; the last four digits may be permitted by the public authority. Corporate officers, partners, and salaried employees are considered employees and must be paid the prevailing rate. Individual sole proprietors do not have to pay themselves prevailing rate but must report their hours on the project.
2. **Work Class:** List classification of work actually performed by employee. If unsure of work classification, consult the Ohio Department of Commerce-Division of Industrial Compliance & Labor-Bureau of Wage and Hour Administration. Employees working more than one classification should have separate line entries for each classification. Indicate what year/level for Apprentices. Be specific when using laborer and operator classifications; for example, Backhoe Operator or Asphalt Laborer or by "Group".
3. **Hours Worked, Day & Date:** In the first row of column 3, enter days of the company's pay period for example; M T W TH F S S. The second row is for the date that corresponds with each day for the pay period. In the employee information section, enter the number of hours worked on the prevailing wage project and which day the hours were worked. Separate rows are labeled for (ST) straight time hours and (OT) overtime hours. All hours worked after 40, must be paid at the appropriate overtime rate.
4. **Project Total Hours:** Total the hours entered for pay period.
5. **Base Rate:** Enter actual rate per hour paid to the employee. The overtime hourly rate is time and one-half the base rate listed in the prevailing wage schedule plus fringe benefits at straight time rate. The prevailing wage schedule lists the base rate plus fringe benefit amounts. These amounts added together equal the total prevailing wage rate. Employers must pay this total amount in one of three ways.
 - 1) Total rate may be paid in entirety in the base rate to the employee; in which case, the cash designation will be checked for fringe benefits.
 - 2) Total rate may be paid as listed in prevailing wage rate schedule with total fringe amounts paid approved plans.
 - 3) Total rate may be paid with a combination of base rate and fringe payments to approved plans in amounts other than those listed in schedule.
6. **Project Gross:** Enter total gross wages earned on the project for straight time and overtime. Project hours "X" base rate should equal project gross.
7. **Fringes:** If fringe benefits are paid in the hourly base rate, indicate this by marking the Cash space. If fringe benefits are paid to approved plans as listed in the prevailing wage rate schedule, mark the space Approved Plans. If fringe benefits are paid partially in the base rate and partially to approved plans, mark the space Cash & Approved Plans. List the hourly amount paid to approved plans for each fringe. If payments are not made on a per hour basis, calculate the hourly fringe credit by dividing the yearly employer contribution by the lesser of: hours actually worked in the year (these must be documented) or 2080. Fringe benefits include: Employer's share of health insurance, life insurance, retirement plan, bonus/profit sharing, sick pay, holiday pay, personal leave, vacation, and education/training programs. If unsure of a possible fringe benefit, contact the Ohio Department of Commerce-Division of Industrial Compliance & Labor-Bureau of Wage and Hour Administration.
8. **Total Hours All Jobs:** Total all hours worked during the pay period including non-prevailing wage jobs.
9. **Total Gross All Jobs:** Gross amount earned in the pay period for all hours worked.
10. Self explanatory.
11. Self explanatory.

- (a) The number of hours worked in each day and the total number of hours worked each week.
 4. Hourly rate for each employee.
 - (a) The minimum rate paid must be the wage rate for the appropriate classification. The Department's Wage Rate Schedule sets this rate.
 - (b) All overtime worked is to be paid at time and one-half for all hours worked more than forty (40) per week.
 5. Where fringes are paid into a bona fide plan instead of cash, list each benefit and amount per hour paid to program for each employee.
 - (a) When the amount contributed to the fringe benefit plan and the total number of hours worked by the employee on all projects for the year are documented, the hourly amount is calculated by dividing the total contribution of the employer by the total number of hours worked by the employee.
 - (b) When the amount contributed to the fringe benefit is documented but not the total hours worked, the hourly amount is calculated by **dividing the total yearly contribution by 2080.**
 6. Gross amount earned on all projects during the pay period.
 7. Total deductions from employee's wages.
 8. Net amount paid.
- J. The reports shall be certified by the contractor, subcontractor, or duly appointed agent stating that the payroll is correct and complete; and that the wage rates shown are not less than those required by the O.R.C. 4115.
- K. Provide a Final Affidavit to the Prevailing Wage Coordinator upon the completion of the project.

AFFIDAVIT OF CONTRACTOR OR SUBCONTRACTOR

PREVAILING WAGES

I, _____,
(Name of person signing the affidavit) (Title)

of the _____,
(Company Name), do hereby certify that the

wages paid to all employees for the full number of hours worked in connection with the Contract to the
Improvement, Repair and Construction of:

(Project name and location of the project)

during the following period from _____ to _____

in accordance with the prevailing wage prescribed by the contract document.

I further certify that no rebates or deductions for any wages due any person have been directly
or indirectly made other than those provided by law.

(Signature of officer or agent)

Sworn to and subscribed in my presence this _____ day of _____

20____.

(Notary Public)

The above affidavit must be executed and sworn to by the officer or agent of the Contractor or
Subcontractor who supervises the payment of employees, before the owner will release the surety and/or
make a final payment due under the terms of the Contract.

Prevailing Wage Determination Cover Letter

County: STARK

Determination Date: 02/23/2021

Expiration Date: 05/23/2021

THE FOLLOWING PAGES ARE PREVAILING RATES OF WAGES ON PUBLIC IMPROVEMENTS FAIRLY ESTIMATED TO BE MORE THAN THE AMOUNT IN O.R.C. SEC. 4115.03 (b) (1) or (2), AS APPLICABLE.

Section 4115.05 provides, in part: "Where contracts are not awarded or construction undertaken within ninety days from the date of the establishment of the prevailing wages, there shall be a redetermination of the prevailing rate of wages before the contract is awarded." The expiration date of this wage schedule is listed above for your convenience only. This wage determination is not intended as a blanket determination to be used for all projects during this period without prior approval of this Department.

Section 4115.04, Ohio Revised Code provides, in part: "Such schedule of wages shall be attached to and made a part of the specifications for the work, and shall be printed on the bidding blanks where the work is done by contract..."

The contract between the letting authority and the successful bidder shall contain a statement requiring that mechanics and laborers be paid a prevailing rate of wage as required in Section 4115.06, Ohio Revised Code.

The contractor or subcontractor is required to file with the contracting public authority upon completion of the project and prior to final payment therefore an affidavit stating that he has fully complied with Chapter 4115 of the Ohio Revised Code.

The wage rates contained in this schedule are the "Prevailing Wages" as defined by Section 4115.03, Ohio Revised Code (the basic hourly rates plus certain fringe benefits). These rates and fringes shall be a minimum to be paid under a contract regulated by Chapter 4115 of the Ohio Revised Code by contractors and subcontractors. The prevailing wage rates contained in this schedule include the effective dates and wage rates currently on file. In cases where future effective dates are not included in this schedule, modifications to the wage schedule will be furnished to the Prevailing Wage Coordinator appointed by the public authority as soon as prevailing wage rates increases are received by this office.

"There shall be posted in a prominent and accessible place on the site of work a legible statement of the Schedule of Wage Rates specified in the contract to the various classifications of laborers, workmen, and mechanics employed, said statement to remain posted during the life of such contract." Section 4115.07, Ohio Revised Code.

Apprentices will be permitted to work only under a bona fide apprenticeship program if such program exists and if such program is registered with the Ohio Apprenticeship Council.

Section 4115.071 provides that no later than ten days before the first payment of wages is due to any employee of any contractor or subcontractor working on a contract regulated by Chapter 4115, Ohio Revised Code, the contracting public authority shall appoint one of his own employees to act as the prevailing wage coordinator for said contract. The duties of the prevailing wage coordinator are outlined in Section 4115.071 of the Ohio Revised Code.

Section 4115.05 provides for an escalator in the prevailing wage rate. Each time a new rate is established, that rate is required to be paid on all ongoing public improvement projects.

A further requirement of Section 4115.05 of the Ohio Revised Code is: "On the occasion of the first pay date under a contract, the contractor shall furnish each employee not covered by a collective bargaining agreement or understanding between employers and bona fide organizations of Labor with individual written notification of the job classification to which the employee is assigned, the prevailing wage determined to be applicable to that classification, separated into the hourly rate of pay and the fringe payments, and the identity of the prevailing wage Coordinator appointed by the public authority. The contractor or subcontractor shall furnish the same notification to each affected employee every time the job classification of the employee is changed."

Work performed in connection with the installation of modular furniture may be subject to prevailing wage.

**THIS PACKET IS NOT TO BE SEPARATED BUT IS TO REMAIN COMPLETE AS IT IS SUBMITTED TO YOU.
(Reference guidelines and forms are included in this packet to be helpful in the compliance of the Prevailing**

Wage law.)
wh1500

of Ashtabula, Austinburg, Geneva, Harperfield, Jefferson, Plymouth & Saybrook) (townships of Andover, Cherry Valley, Colbrook, Canneaut, Denmark, Dorset, East Orwell, Hartsgrove, Kingville, Lenox, Monroe, Morgan, New Lyme, North Kingsville, Orwell, Pierpoint, Richmond Rock Creek, Rome, Sheffield, Trumbull, Wayne, Williamsfield & Windsor) Erie County: (post offices & townships of Berlin, Berlin Heights, Birmingham, Florence, Huron, Milan, Shinrock & Vermilion)

Details :

Asbestos & lead paint abatement including, but not limited to the removal or encapsulation of asbestos & lead paint, all work in conjunction with the preparation of the removal of same & all work in conjunction with the clean up after said removal. The removal of all insulation materials, whether they contain asbestos or not, from mechanical systems (pipes, boilers, ducts, flues, breaching, etc.) is recognized as being the exclusive work of the Asbestos Abatement Workers.

On all mechanical systems (pipes, boilers, ducts, flues, breaching, etc.) that are going to be demolished, the removal of all insulating materials whether they contain asbestos or not shall be the exclusive work of the Laborers.

An Abatement Journeyman is anyone who has more than 300 hours in the Asbestos Abatement field.

Prevailing Wage Rate Skilled Crafts

Name of Union: Asbestos Local 84 Heat & Frost Insulators

Change # : LCN01-2018fbLoc84

Craft : Asbestos Worker Effective Date : 06/06/2018 Last Posted : 06/06/2018

	BHR		Fringe Benefit Payments					Irrevocable Fund		Total PWR	Overtime Rate	
			H&W	Pension	App Tr.	Vac.	Annuity	Other	LECET (*)	MISC (*)		
Classification												
Asbestos Insulation Worker	\$31.47		\$9.49	\$8.36	\$0.36	\$0.00	\$3.39	\$0.24	\$0.00	\$0.00	\$53.31	\$69.04
Apprentice	Percent											
1st Year	50.00	\$15.74	\$9.49	\$8.36	\$0.36	\$0.00	\$3.39	\$0.24	\$0.00	\$0.00	\$37.58	\$45.44
2nd Year	60.00	\$18.88	\$9.49	\$8.36	\$0.36	\$0.00	\$3.39	\$0.24	\$0.00	\$0.00	\$40.72	\$50.16
3rd Year	70.00	\$22.03	\$9.49	\$8.36	\$0.36	\$0.00	\$3.39	\$0.24	\$0.00	\$0.00	\$43.87	\$54.88
4th Year	80.00	\$25.18	\$9.49	\$8.36	\$0.36	\$0.00	\$3.39	\$0.24	\$0.00	\$0.00	\$47.02	\$59.60

Special Calculation Note : Other is Industry and Labor Management Fund

Ratio :

3 Journeymen to 1 Apprentice per shop

Jurisdiction (* denotes special jurisdictional note) :

ASHLAND, ASHTABULA*, CARROLL, COLUMBIANA, COSHOCTON, ERIE*, HARRISON, HOLMES, MAHONING, MEDINA, PORTAGE, RICHLAND, STARK, SUMMIT, TRUMBULL, TUSCARAWAS, WAYNE

Special Jurisdictional Note : Ashtabula County: except for the townships of Ashtabula, Austinburg, Geneva, Harpersfield, Jefferson, Plymouth and Saybrook. Erie except Sandusky city limits.

Details :

The removal of all insulation materials, whether they contain asbestos or not, from mechanical systems (pipes, boilers, ducts, flues, breaching, etc.) is recognized as being the exclusive work of the Asbestos Workers. On all mechanical systems (pipes, boilers, ducts, flues, breaching, etc.) that are going to be demolished, the removal of all insulating materials whether they contain asbestos or not shall be the exclusive work of the Laborers.

Prevailing Wage Rate Skilled Crafts

Name of Union: **Boilermaker Local 744**

Change # : LCNO1-2019fbLoc744

Craft : Boilermaker Effective Date : 04/03/2019 Last Posted : 04/03/2019

	BHR		Fringe Benefit Payments					Irrevocable Fund		Total PWR	Overtime Rate	
			H&W	Pension	App Tr.	Vac.	Annuity	Other	LECET (*)			MISC (*)
Classification												
Boilermaker	\$38.05		\$7.07	\$16.07	\$0.74	\$0.00	\$5.08	\$0.75	\$0.00	\$0.00	\$67.76	\$86.78
Apprentice	Percent											
1st 6 months	70.02	\$26.64	\$7.07	\$16.07	\$0.74	\$0.00	\$5.08	\$0.75	\$0.00	\$0.00	\$56.35	\$69.67
2nd 6 months	72.52	\$27.59	\$7.07	\$16.07	\$0.74	\$0.00	\$5.08	\$0.75	\$0.00	\$0.00	\$57.30	\$71.10
3rd 6 months	75.00	\$28.54	\$7.07	\$16.07	\$0.74	\$0.00	\$5.08	\$0.75	\$0.00	\$0.00	\$58.25	\$72.52
4th 6 months	77.51	\$29.49	\$7.07	\$16.07	\$0.74	\$0.00	\$5.08	\$0.75	\$0.00	\$0.00	\$59.20	\$73.95
5th 6 months	80.00	\$30.44	\$7.07	\$16.07	\$0.74	\$0.00	\$5.08	\$0.75	\$0.00	\$0.00	\$60.15	\$75.37
6th 6 months	85.03	\$32.35	\$7.07	\$16.07	\$0.74	\$0.00	\$5.08	\$0.75	\$0.00	\$0.00	\$62.06	\$78.24
7th 6 months	90.00	\$34.25	\$7.07	\$16.07	\$0.74	\$0.00	\$5.08	\$0.75	\$0.00	\$0.00	\$63.96	\$81.08
8th 6 months	95.00	\$36.15	\$7.07	\$16.07	\$0.74	\$0.00	\$5.08	\$0.75	\$0.00	\$0.00	\$65.86	\$83.93
Helper	60.00	\$22.83	\$7.07	\$16.07	\$0.74	\$0.00	\$5.08	\$0.75	\$0.00	\$0.00	\$52.54	\$63.96

Special Calculation Note : Other is Supplemental Health

Ratio :

5 Journeymen to 1 Apprentice to 1 Helper

Jurisdiction (* denotes special jurisdictional note) :

ASHTABULA, CARROLL, COSHOCTON, CUYAHOGA, GEAUGA, HARRISON, HOLMES, LAKE, LORAIN, MAHONING, MEDINA, PORTAGE, STARK, SUMMIT, TRUMBULL, TUSCARAWAS, WAYNE

Special Jurisdictional Note :

Details :

Prevailing Wage Rate Skilled Crafts

Name of Union: Bricklayer Local 6

Change # : LCN01-2020fbLoc6

Craft : Bricklayer Effective Date : 05/01/2020 Last Posted : 04/23/2020

	BHR		Fringe Benefit Payments					Irrevocable Fund		Total PWR	Overtime Rate	
			H&W	Pension	App Tr.	Vac.	Annuity	Other	LECET (*)			MISC (*)
Classification												
Bricklayer	\$29.16		\$9.92	\$7.24	\$1.18	\$0.00	\$0.00	\$0.05	\$0.00	\$0.00	\$47.55	\$62.13
Pointer Caulker Cleaner	\$29.16		\$9.92	\$7.24	\$1.18	\$0.00	\$0.00	\$0.05	\$0.00	\$0.00	\$47.55	\$62.13
Stone Mason	\$29.16		\$9.92	\$7.24	\$1.18	\$0.00	\$0.00	\$0.05	\$0.00	\$0.00	\$47.55	\$62.13
Cement Mason	\$29.16		\$9.92	\$7.24	\$1.18	\$0.00	\$0.00	\$0.05	\$0.00	\$0.00	\$47.55	\$62.13
Plaster	\$29.16		\$9.92	\$7.24	\$1.18	\$0.00	\$0.00	\$0.05	\$0.00	\$0.00	\$47.55	\$62.13
Apprentice	Percent											
1st 6 months	55.00	\$16.04	\$9.92	\$7.24	\$1.18	\$0.00	\$0.00	\$0.05	\$0.00	\$0.00	\$34.43	\$42.45
2nd 6 months	60.00	\$17.50	\$9.92	\$7.24	\$1.18	\$0.00	\$0.00	\$0.05	\$0.00	\$0.00	\$35.89	\$44.63
3rd 6 months	65.00	\$18.95	\$9.92	\$7.24	\$1.18	\$0.00	\$0.00	\$0.05	\$0.00	\$0.00	\$37.34	\$46.82
4th 6 months	70.00	\$20.41	\$9.92	\$7.24	\$1.18	\$0.00	\$0.00	\$0.05	\$0.00	\$0.00	\$38.80	\$49.01
5th 6 months	75.00	\$21.87	\$9.92	\$7.24	\$1.18	\$0.00	\$0.00	\$0.05	\$0.00	\$0.00	\$40.26	\$51.20
6th 6 months	80.00	\$23.33	\$9.92	\$7.24	\$1.18	\$0.00	\$0.00	\$0.05	\$0.00	\$0.00	\$41.72	\$53.38
7th 6 months	90.00	\$26.24	\$9.92	\$7.24	\$1.18	\$0.00	\$0.00	\$0.05	\$0.00	\$0.00	\$44.63	\$57.76
8th 6 months	95.00	\$27.70	\$9.92	\$7.24	\$1.18	\$0.00	\$0.00	\$0.05	\$0.00	\$0.00	\$46.09	\$59.94

Special Calculation Note : OTHER IS DRUG TESTING

Ratio :

- 1 Journeymen to 1 Apprentice
- 5 Journeymen to 2 Apprentice
- 9 Journeymen to 3 Apprentice
- 13 Journeymen to 4 Apprentice

Jurisdiction (* denotes special jurisdictional note) :

CARROLL, STARK, TUSCARAWAS

Special Jurisdictional Note :

Details :

Prevailing Wage Rate Skilled Crafts

Name of Union: Bricklayer Local 8 Tile Finisher

Change # : LCN01-2014fbLoc8

Craft : Bricklayer Effective Date : 06/11/2014 Last Posted : 06/11/2014

	BHR		Fringe Benefit Payments					Irrevocable Fund		Total PWR	Overtime Rate	
			H&W	Pension	App Tr.	Vac.	Annuity	Other	LECET (*)			MISC (*)
Classification												
Bricklayer Tile Marble Terrazzo Finisher	\$23.17		\$5.00	\$7.85	\$0.20	\$0.00	\$0.37	\$0.37	\$0.00	\$0.00	\$36.96	\$48.55
Resilient flooring Wood Laminate Carpet Carpet Tile Finisher	\$13.34		\$5.00	\$7.23	\$0.00	\$0.00	\$0.00	\$0.26	\$0.00	\$0.00	\$25.83	\$32.50
New Employees	Percent											
1st 30 days	59.89	\$13.88	\$0.00	\$0.00	\$0.00	\$0.00	\$0.00	\$0.00	\$0.00	\$0.00	\$13.88	\$20.81
2nd 30 days thru 6 months	59.89	\$13.88	\$5.00	\$0.00	\$0.00	\$0.00	\$0.00	\$0.00	\$0.00	\$0.00	\$18.88	\$25.81
2nd 6 months	69.90	\$16.20	\$5.00	\$7.85	\$0.20	\$0.00	\$0.37	\$0.37	\$0.00	\$0.00	\$29.99	\$38.08
3rd 6 months	74.93	\$17.36	\$5.00	\$7.85	\$0.20	\$0.00	\$0.37	\$0.37	\$0.00	\$0.00	\$31.15	\$39.83
4th 6 months	79.88	\$18.51	\$5.00	\$7.85	\$0.20	\$0.00	\$0.37	\$0.37	\$0.00	\$0.00	\$32.30	\$41.55
5th 6 months	84.88	\$19.67	\$5.00	\$7.85	\$0.20	\$0.00	\$0.37	\$0.37	\$0.00	\$0.00	\$33.46	\$43.29
6th 6 months	89.88	\$20.83	\$5.00	\$7.85	\$0.20	\$0.00	\$0.37	\$0.37	\$0.00	\$0.00	\$34.62	\$45.03

7th 6 months	94.88	\$21.98	\$5.00	\$7.85	\$0.20	\$0.00	\$0.37	\$0.37	\$0.00	\$0.00	\$35.77	\$46.77
8th 6 months	94.88	\$21.98	\$5.00	\$7.85	\$0.20	\$0.00	\$0.37	\$0.37	\$0.00	\$0.00	\$35.77	\$46.77

Special Calculation Note : Other \$.40 is for International Masonry Training. Classification title contains "Bricklayer" because contract originates within the Bricklayer Local. Note that the classification description is clarified after the local union number at the top of the page.

Ratio :

Journeyman 4 to 1 Apprentice

Journeyman 6 to 1 Apprentice thereafter

Jurisdiction (* denotes special jurisdictional note) :

ASHTABULA, CARROLL, COLUMBIANA, COSHOCTON, HARRISON, HOLMES, JEFFERSON, MAHONING, PORTAGE, STARK, TRUMBULL, TUSCARAWAS, WAYNE

Special Jurisdictional Note : Townships in Columbiana County are as follows: Salem, Perry, Fairfield, Center Elkrun, Middletown and Unity

Details :

Mechanic's assistants shall do all the handling, of sand, cement, lime, tile, marble, terrazzo and other materials used by the mechanics upon being delivered to the building or at the job. Hand rubbing, rolling, mixing, formulating, grinding, grouting, and cleaning of all marble, tile, mosaic, and terrazzo floors, and wainscoting, and such other work as is required in helping a mechanic as is the established custom of the trade. No limit to the tools, equipment or machinery used.

Prevailing Wage Rate Skilled Crafts

Name of Union: Bricklayer Local 8 Zone 2 Tile Setters & Finishers

Change # : LCN1-2020fbLoc6

Craft : Bricklayer Effective Date : 06/04/2020 Last Posted : 06/04/2020

	BHR		Fringe Benefit Payments					Irrevocable Fund		Total PWR	Overtime Rate	
			H&W	Pension	App Tr.	Vac.	Annuity	Other	LECET (*)			MISC (*)
Classification												
Bricklayer Tile Setter	\$25.50		\$8.05	\$6.11	\$0.60	\$0.00	\$0.00	\$0.00	\$0.00	\$0.00	\$40.26	\$53.01
Marble Mason	\$25.50		\$8.05	\$6.11	\$0.60	\$0.00	\$0.00	\$0.00	\$0.00	\$0.00	\$40.26	\$53.01
Terrazzo worker	\$25.50		\$8.05	\$6.11	\$0.60	\$0.00	\$0.00	\$0.00	\$0.00	\$0.00	\$40.26	\$53.01
Finisher Support	\$22.91		\$8.05	\$6.11	\$0.58	\$0.00	\$0.00	\$0.00	\$0.00	\$0.00	\$37.65	\$49.11
Apprentice Finisher Support Only												
1st 30 days	\$13.75		\$0.00	\$0.00	\$0.00	\$0.00	\$0.00	\$0.00	\$0.00	\$0.00	\$13.75	\$20.62
30 days-6 months	\$13.75		\$8.05	\$0.00	\$0.00	\$0.00	\$0.00	\$0.00	\$0.00	\$0.00	\$21.80	\$28.67
2ND 6 months	\$16.04		\$8.05	\$6.11	\$0.58	\$0.00	\$0.00	\$0.00	\$0.00	\$0.00	\$30.78	\$38.80
3RD 6 months	\$17.18		\$8.05	\$6.11	\$0.58	\$0.00	\$0.00	\$0.00	\$0.00	\$0.00	\$31.92	\$40.51
4TH 6 months	\$18.33		\$8.05	\$6.11	\$0.58	\$0.00	\$0.00	\$0.00	\$0.00	\$0.00	\$33.07	\$42.24
5TH 6 months	\$19.47		\$8.05	\$6.11	\$0.58	\$0.00	\$0.00	\$0.00	\$0.00	\$0.00	\$34.21	\$43.94
6TH 6 months	\$20.62		\$8.05	\$6.11	\$0.58	\$0.00	\$0.00	\$0.00	\$0.00	\$0.00	\$35.36	\$45.67
Apprentice	Percent											
1st 30 Days	60.00	\$15.30	\$0.00	\$0.00	\$0.00	\$0.00	\$0.00	\$0.00	\$0.00	\$0.00	\$15.30	\$22.95
30 days- 6 months	60.00	\$15.30	\$8.05	\$0.00	\$0.00	\$0.00	\$0.00	\$0.00	\$0.00	\$0.00	\$23.35	\$31.00
2nd 6 months	70.00	\$17.85	\$8.05	\$6.11	\$0.60	\$0.00	\$0.00	\$0.00	\$0.00	\$0.00	\$32.61	\$41.54
3rd 6 months	75.00	\$19.12	\$8.05	\$6.11	\$0.60	\$0.00	\$0.00	\$0.00	\$0.00	\$0.00	\$33.89	\$43.45

4th 6 months	80.00	\$20.40	\$8.05	\$6.11	\$0.60	\$0.00	\$0.00	\$0.00	\$0.00	\$0.00	\$35.16	\$45.36
5th 6 months	85.00	\$21.67	\$8.05	\$6.11	\$0.60	\$0.00	\$0.00	\$0.00	\$0.00	\$0.00	\$36.44	\$47.27
6th 6 months	90.00	\$22.95	\$8.05	\$6.11	\$0.60	\$0.00	\$0.00	\$0.00	\$0.00	\$0.00	\$37.71	\$49.18
7th 6 months	95.00	\$24.22	\$8.05	\$6.11	\$0.60	\$0.00	\$0.00	\$0.00	\$0.00	\$0.00	\$38.99	\$51.10
8th 6 months	95.00	\$24.22	\$8.05	\$6.11	\$0.60	\$0.00	\$0.00	\$0.00	\$0.00	\$0.00	\$38.99	\$51.10

Special Calculation Note : Classification title contains "Bricklayer" because contract originates within the Bricklayer Local.

Note that the classification description is clarified after the local union number at the top of the page.

Ratio :

4 Journeymen to 1 Apprentice
 6 Journeymen to 1 Apprentice (Thereafter)

Jurisdiction (* denotes special jurisdictional note) :

BELMONT, CARROLL, HARRISON,
 JEFFERSON, MONROE, STARK,
 TUSCARAWAS

Special Jurisdictional Note :

Details :

Prevailing Wage Rate Skilled Crafts

Name of Union: Bricklayer Local 8 Zone 2 Tile Setters & Finishers

Change # : LCN1-2019fbLoc6

Craft : Bricklayer Effective Date : 06/01/2019 Last Posted : 05/29/2019

	BHR		Fringe Benefit Payments					Irrevocable Fund		Total PWR	Overtime Rate	
			H&W	Pension	App Tr.	Vac.	Annuity	Other	LECET (*)			MISC (*)
Classification												
Bricklayer Tile Setter	\$25.27		\$7.55	\$5.85	\$0.59	\$0.00	\$0.00	\$0.00	\$0.00	\$0.00	\$39.26	\$51.90
Marble Mason	\$25.27		\$7.55	\$5.85	\$0.59	\$0.00	\$0.00	\$0.00	\$0.00	\$0.00	\$39.26	\$51.90
Terrazzo worker	\$25.27		\$7.55	\$5.85	\$0.59	\$0.00	\$0.00	\$0.00	\$0.00	\$0.00	\$39.26	\$51.90
Finisher Support	\$22.68		\$7.55	\$5.85	\$0.57	\$0.00	\$0.00	\$0.00	\$0.00	\$0.00	\$36.65	\$47.99
APPRENTICE Finisher Support Only												
1st 30 days	\$13.61		\$0.00	\$0.00	\$0.00	\$0.00	\$0.00	\$0.00	\$0.00	\$0.00	\$13.61	\$20.41
30 days-6 months	\$13.61		\$7.55	\$0.00	\$0.00	\$0.00	\$0.00	\$0.00	\$0.00	\$0.00	\$21.16	\$27.96
2ND 6 months	\$15.88		\$7.55	\$5.85	\$0.57	\$0.00	\$0.00	\$0.00	\$0.00	\$0.00	\$29.85	\$37.79
3RD 6 months	\$17.01		\$7.55	\$5.85	\$0.57	\$0.00	\$0.00	\$0.00	\$0.00	\$0.00	\$30.98	\$39.49
4TH 6 months	\$18.14		\$7.55	\$5.85	\$0.57	\$0.00	\$0.00	\$0.00	\$0.00	\$0.00	\$32.11	\$41.18
5TH 6 months	\$19.28		\$7.55	\$5.85	\$0.57	\$0.00	\$0.00	\$0.00	\$0.00	\$0.00	\$33.25	\$42.89
6TH 6 months	\$20.41		\$7.55	\$5.85	\$0.57	\$0.00	\$0.00	\$0.00	\$0.00	\$0.00	\$34.38	\$44.59
Apprentice	Percent											
1st 30 Days	60.00	\$15.16	\$0.00	\$0.00	\$0.00	\$0.00	\$0.00	\$0.00	\$0.00	\$0.00	\$15.16	\$22.74
30 days- 6 months	60.00	\$15.16	\$7.55	\$0.00	\$0.00	\$0.00	\$0.00	\$0.00	\$0.00	\$0.00	\$22.71	\$30.29
2nd 6 months	70.00	\$17.69	\$7.55	\$5.85	\$0.59	\$0.00	\$0.00	\$0.00	\$0.00	\$0.00	\$31.68	\$40.52
3rd 6 months	75.00	\$18.95	\$7.55	\$5.85	\$0.59	\$0.00	\$0.00	\$0.00	\$0.00	\$0.00	\$32.94	\$42.42
4th 6 months	80.00	\$20.22	\$7.55	\$5.85	\$0.59	\$0.00	\$0.00	\$0.00	\$0.00	\$0.00	\$34.21	\$44.31
5th 6 months	85.00	\$21.48	\$7.55	\$5.85	\$0.59	\$0.00	\$0.00	\$0.00	\$0.00	\$0.00	\$35.47	\$46.21
6th 6 months	90.00	\$22.74	\$7.55	\$5.85	\$0.59	\$0.00	\$0.00	\$0.00	\$0.00	\$0.00	\$36.73	\$48.10
7th 6 months	95.00	\$24.01	\$7.55	\$5.85	\$0.59	\$0.00	\$0.00	\$0.00	\$0.00	\$0.00	\$38.00	\$50.00
8th 6 months	95.00	\$24.01	\$7.55	\$5.85	\$0.59	\$0.00	\$0.00	\$0.00	\$0.00	\$0.00	\$38.00	\$50.00

Special Calculation Note : Classification title contains "Bricklayer" because contract originates within the Bricklayer Local.

Note that the classification description is clarified after the local union number at the top of the

page.

Ratio :

4 Journeymen to 1 Apprentice
6 Journeymen to 1 Apprentice (Thereafter)

Jurisdiction (* denotes special jurisdictional note) :
BELMONT, CARROLL, HARRISON,
JEFFERSON, MONROE, STARK,
TUSCARAWAS

Special Jurisdictional Note :

Details :

Prevailing Wage Rate Skilled Crafts

Name of Union: Carpenter Commercial NE Zone 2B

Change # : LCN01-2020fbLocNEZone2B

Craft : Carpenter Effective Date : 05/28/2020 Last Posted : 05/28/2020

	BHR		Fringe Benefit Payments					Irrevocable Fund		Total PWR	Overtime Rate	
			H&W	Pension	App Tr.	Vac.	Annuity	Other	LECET (*)			MISC (*)
Classification												
Carpenter	\$27.35		\$7.75	\$10.57	\$0.50	\$0.00	\$0.82	\$0.00	\$0.00	\$0.00	\$46.99	\$60.67
Apprentice	Percent											
1st 3 Months	60.00	\$16.41	\$0.00	\$0.00	\$0.00	\$0.00	\$0.00	\$0.00	\$0.00	\$0.00	\$16.41	\$24.62
2nd 3 Months	60.00	\$16.41	\$7.75	\$0.00	\$0.50	\$0.00	\$0.00	\$0.00	\$0.00	\$0.00	\$24.66	\$32.87
2nd 6 Months is 1st year	60.00	\$16.41	\$7.75	\$0.00	\$0.50	\$0.00	\$0.00	\$0.00	\$0.00	\$0.00	\$24.66	\$32.87
3rd 6 Months	60.00	\$16.41	\$7.75	\$0.00	\$0.50	\$0.00	\$0.00	\$0.00	\$0.00	\$0.00	\$24.66	\$32.87
4th 6 Months is 2nd year	60.00	\$16.41	\$7.75	\$0.00	\$0.50	\$0.00	\$0.00	\$0.00	\$0.00	\$0.00	\$24.66	\$32.87
5th 6 Months	70.00	\$19.14	\$7.75	\$7.40	\$0.50	\$0.00	\$0.57	\$0.00	\$0.00	\$0.00	\$35.37	\$44.94
6th 6 Months is 3rd year	75.00	\$20.51	\$7.75	\$7.93	\$0.50	\$0.00	\$0.62	\$0.00	\$0.00	\$0.00	\$37.31	\$47.57
7th 6 Months	80.00	\$21.88	\$7.75	\$8.46	\$0.50	\$0.00	\$0.66	\$0.00	\$0.00	\$0.00	\$39.25	\$50.19
8th 6 Months is 4th year	85.00	\$23.25	\$7.75	\$8.98	\$0.50	\$0.00	\$0.70	\$0.00	\$0.00	\$0.00	\$41.18	\$52.80

Special Calculation Note :

Ratio :

2 Journeymen to 1 Apprentice

Jurisdiction (* denotes special jurisdictional note) :

CARROLL, STARK, TUSCARAWAS, WAYNE

Special Jurisdictional Note :

Details :

Prevailing Wage Rate Skilled Crafts

Name of Union: Carpenter Local 509 NE District Interior Systems

Change # : LCN01-2010mmLoc509Int Systems

Craft : Carpenter Effective Date : 06/17/2010 Last Posted : 06/17/2010

	BHR	Fringe Benefit Payments						Irrevocable Fund		Total PWR	Overtime Rate
		H&W	Pension	App Tr.	Vac.	Annuity	Other	LECET (*)	MISC (*)		
Classification											
Carpenter Window Shade Venetian Blinds Draper y Installer	\$15.50	\$0.00	\$0.00	\$0.00	\$0.00	\$0.00	\$0.00			\$15.50	\$23.25

Special Calculation Note : No special calculations for this skilled craft wage rate are required at this time.

Ratio :

Jurisdiction (* denotes special jurisdictional note) :
 ADAMS, ALLEN, ASHLAND, ASHTABULA,
 ATHENS, AUGLAIZE, BELMONT, BROWN,
 BUTLER, CARROLL, CHAMPAIGN, CLARK,
 CLERMONT, CLINTON, COLUMBIANA,
 COSHOCTON, CRAWFORD, CUYAHOGA,
 DARKE, DEFIANCE, DELAWARE, ERIE,
 FAIRFIELD, FRANKLIN, FULTON, GALLIA,
 GEAUGA, GREENE, GUERNSEY, HAMILTON,
 HANCOCK, HARDIN, HARRISON, HENRY,
 HIGHLAND, HOCKING, HOLMES, HURON,
 JACKSON, JEFFERSON, KNOX, LAKE,

LAWRENCE, LICKING, LOGAN, LORAIN,
LUCAS, MADISON, MAHONING, MARION,
MEDINA, MEIGS, MERCER, MIAMI, MONROE,
MONTGOMERY, MORGAN, MORROW,
MUSKINGUM, NOBLE, OTTAWA, PAULDING,
PERRY, PICKAWAY, PIKE, PORTAGE, PREBLE,
PUTNAM, RICHLAND, ROSS, SANDUSKY,
SCIOTO, SENECA, SHELBY, STARK, SUMMIT,
TRUMBULL, TUSCARAWAS, UNION, VAN
WERT, VINTON, WARREN, WASHINGTON,
WAYNE

Special Jurisdictional Note :

Details :

Prevailing Wage Rate Skilled Crafts

Name of Union: Carpenter Millwright NE Zone M3

Change # : LCN01-2020fbLocNEZoneM3

Craft : Carpenter Effective Date : 05/28/2020 Last Posted : 05/28/2020

	BHR		Fringe Benefit Payments					Irrevocable Fund		Total PWR	Overtime Rate	
			H&W	Pension	App Tr.	Vac.	Annuity	Other	LECET (*)			MISC (*)
Classification												
Carpenter Millwright	\$29.81		\$7.75	\$10.30	\$0.50	\$0.00	\$1.87	\$0.05	\$0.00	\$0.00	\$50.28	\$65.18
Certified Welder	\$30.81		\$7.75	\$10.30	\$0.50	\$0.00	\$1.87	\$0.05	\$0.00	\$0.00	\$51.28	\$66.68
Lay-Out Man on Monorail	\$31.31		\$7.75	\$10.30	\$0.50	\$0.00	\$1.87	\$0.05	\$0.00	\$0.00	\$51.78	\$67.43
Apprentice	Percent											
1st 6 months	60.00	\$17.89	\$7.75	\$10.30	\$0.50	\$0.00	\$1.87	\$0.05	\$0.00	\$0.00	\$38.36	\$47.30
2nd 6 months	60.00	\$17.89	\$7.75	\$10.30	\$0.50	\$0.00	\$1.87	\$0.05	\$0.00	\$0.00	\$38.36	\$47.30
3rd 6 months	62.00	\$18.48	\$7.75	\$10.30	\$0.50	\$0.00	\$1.87	\$0.05	\$0.00	\$0.00	\$38.95	\$48.19
4th 6 months	65.50	\$19.53	\$7.75	\$10.30	\$0.50	\$0.00	\$1.87	\$0.05	\$0.00	\$0.00	\$40.00	\$49.76
5th 6 months	69.00	\$20.57	\$7.75	\$10.30	\$0.50	\$0.00	\$1.87	\$0.05	\$0.00	\$0.00	\$41.04	\$51.32
6th 6 months	72.50	\$21.61	\$7.75	\$10.30	\$0.50	\$0.00	\$1.87	\$0.05	\$0.00	\$0.00	\$42.08	\$52.89
7th 6 months	76.00	\$22.66	\$7.75	\$10.30	\$0.50	\$0.00	\$1.87	\$0.05	\$0.00	\$0.00	\$43.13	\$54.45
8th 6 months	80.00	\$23.85	\$7.75	\$10.30	\$0.50	\$0.00	\$1.87	\$0.05	\$0.00	\$0.00	\$44.32	\$56.24

Special Calculation Note : Other \$0.05 is UBC Millwright Promotional Fund

Ratio :

2 Journeymen to 1 Apprentice

Jurisdiction (* denotes special jurisdictional note) :

CARROLL, STARK, TUSCARAWAS, WAYNE

Special Jurisdictional Note :

Details :

The term "Millwright and Machine Erectors" jurisdiction shall mean the unloading, hoisting, rigging,

skidding, moving, dismantling, aligning, erecting, assembling, repairing, maintenance and adjusting of all structures, processing areas either under cover, under ground or elsewhere, required to process material, handle, manufacture or service, be it powered or receiving power manually, by steam, gas, electricity, gasoline, diesel, nuclear, solar, water, air or chemically, and in industries such as and including, which are identified for the purpose of description, but not limited to, the following: woodworking plants; canning industries; steel mills; coffee roasting plants; paper and pulp; cellophane; stone crushing; gravel and sand washing and handling; refineries; grain storage and handling; asphalt plants; sewage disposal; water plants; laundries; bakeries; mixing plants; can, bottle and bag packing plants; textile mills; paint mills; breweries; milk processing plants; power plants; aluminum processing or manufacturing plants; and amusement and entertainment fields. The installation of mechanical equipment in atomic energy plants; installation of reactors in power plants; installation of control rods and equipment in reactors; and installation of mechanical equipment in rocket missile bases, launchers, launching gantry, floating bases, hydraulic escape doors and any and all component parts thereto, either assembled, semi-assembled or disassembled. The installation of, but not limited to, the following: setting-up of all engines, motors, generators, air compressors, fans, pumps, scales, hoppers, conveyors of all types, sizes and their supports; escalators; man lifts; moving sidewalks; hoists; dumb waiters; all types of feeding machinery; amusement devices; mechanical pin setters and spotters in bowling alleys; refrigeration equipment; and the installation of all types of equipment necessary and required to process material either in the manufacturing or servicing. The handling and installation of pulleys, gears, sheaves, fly wheels, air and vacuum drives, worm drives and gear drives directly or indirectly coupled to motors, belts, chains, screws, legs, boots, guards, booth tanks, all bin valves, turn heads and indicators, shafting, bearings, cable sprockets, cutting all key seats in new and old work, troughs, chippers, filters, calendars, rolls, winders, rewinders, slitters, cutters, wrapping machines, blowers, forging machines, rams, hydraulic or otherwise, planing, extruder, ball, dust collectors, equipment in meat packing plants, splicing of ropes and cables. The laying-out, fabrication and installation of protection equipment including machinery guards, making and setting of templates for machinery, fabrication of bolts, nuts, pans, drilling of holes for any equipment which the Millwrights install regardless of materials; all welding and burning regardless of type, fabrication of all lines, hose or tubing used in lubricating machinery installed by Millwrights; grinding, cleaning, servicing and any machine work necessary for any part of any equipment installed by the Millwrights; and the break-in and trial run of any equipment or machinery installed by the Millwrights. It is agreed the Millwrights shall use the layout tools and optic equipment necessary to perform their work.

Prevailing Wage Rate Skilled Crafts

Name of Union: Carpenter NE District Industrial Dock & Door

Change # : LCN01-2014fbCarpNEStatewide

Craft : Carpenter Effective Date : 03/05/2014 Last Posted : 03/05/2014 *fringe 6.20*

	BHR	Fringe Benefit Payments						Irrevocable Fund		Total PWR	Overtime Rate
		H&W	Pension	App Tr.	Vac.	Annuity	Other	LECET (*)	MISC (*)		
Classification											
Carpenter	\$19.70	\$5.05	\$1.00	\$0.15	\$0.00	\$0.00	\$0.00	\$0.00	\$0.00	\$25.90	\$35.75
Trainee	Percent										
1st Year	60.00	\$11.82	\$5.05	\$1.00	\$0.15	\$0.00	\$0.00	\$0.00	\$0.00	\$18.02	\$23.93
2nd Year	80.20	\$15.80	\$5.05	\$1.00	\$0.15	\$0.00	\$0.00	\$0.00	\$0.00	\$22.00	\$29.90

Special Calculation Note : No special calculations for this skilled craft wage rate are required at this time.

Ratio :

1 Journeymen to 1 Trainee

Jurisdiction (* denotes special jurisdictional note) :

- ADAMS, ALLEN, ASHLAND, ASHTABULA,
- ATHENS, AUGLAIZE, BELMONT, BROWN,
- BUTLER, CARROLL, CHAMPAIGN, CLARK,
- CLERMONT, CLINTON, COLUMBIANA,
- COSHOCTON, CRAWFORD, CUYAHOGA,
- DARKE, DEFIANCE, DELAWARE, ERIE,
- FAIRFIELD, FAYETTE, FRANKLIN, FULTON,
- GALLIA, GEAUGA, GREENE, GUERNSEY,
- HAMILTON, HANCOCK, HARDIN, HARRISON,
- HENRY, HIGHLAND, HOCKING, HOLMES,
- HURON, JACKSON, JEFFERSON, KNOX,
- LAKE, LAWRENCE, LICKING, LOGAN,
- LORAIN, LUCAS, MADISON, MAHONING,

MARION, MEDINA, MEIGS, MERCER, MIAMI,
MONROE, MONTGOMERY, MORGAN,
MORROW, MUSKINGUM, NOBLE, OTTAWA,
PAULDING, PERRY, PICKAWAY, PIKE,
PORTAGE, PREBLE, PUTNAM, RICHLAND,
ROSS, SANDUSKY, SCIOTO, SENECA,
SHELBY, STARK, SUMMIT, TRUMBULL,
TUSCARAWAS, UNION, VAN WERT, VINTON,
WARREN, WASHINGTON, WAYNE,
WILLIAMS, WOOD, WYANDOT

Special Jurisdictional Note : Industrial Dock and Door is the installation of overhead doors, roll up doors and dock leveling equipment

Details :

10/27/10 New Contract jc

Prevailing Wage Rate Skilled Crafts

Name of Union: Carpenter Insulation NE Zone 2B

Change # : LCN01-2020fbLocNEZone2B

Craft : Carpenter Effective Date : 05/28/2020 Last Posted : 05/28/2020

	BHR		Fringe Benefit Payments					Irrevocable Fund		Total PWR	Overtime Rate	
			H&W	Pension	App Tr.	Vac.	Annuity	Other	LECET (*)			MISC (*)
Classification												
Carpenter Insulation	\$21.88		\$7.75	\$10.57	\$0.50	\$0.00	\$0.82	\$0.00	\$0.00	\$0.00	\$41.52	\$52.46
Apprentice	Percent											
1st 3 months	50.00	\$10.94	\$0.00	\$0.00	\$0.00	\$0.00	\$0.00	\$0.00	\$0.00	\$0.00	\$10.94	\$16.41
2nd 3 months	50.00	\$10.94	\$7.75	\$0.00	\$0.50	\$0.00	\$0.00	\$0.00	\$0.00	\$0.00	\$19.19	\$24.66
2nd 6 months	50.00	\$10.94	\$7.75	\$0.00	\$0.50	\$0.00	\$0.00	\$0.00	\$0.00	\$0.00	\$19.19	\$24.66
3rd 6 months	55.00	\$12.03	\$7.75	\$0.00	\$0.50	\$0.00	\$0.00	\$0.00	\$0.00	\$0.00	\$20.28	\$26.30
4th 6 months	60.00	\$13.13	\$7.75	\$0.00	\$0.50	\$0.00	\$0.00	\$0.00	\$0.00	\$0.00	\$21.38	\$27.94
5th 6 months	70.00	\$15.32	\$7.75	\$7.40	\$0.50	\$0.00	\$0.57	\$0.00	\$0.00	\$0.00	\$31.54	\$39.19
6th 6 months	75.00	\$16.41	\$7.75	\$7.93	\$0.50	\$0.00	\$0.62	\$0.00	\$0.00	\$0.00	\$33.21	\$41.42
7th 6 months	80.00	\$17.50	\$7.75	\$8.46	\$0.50	\$0.00	\$0.66	\$0.00	\$0.00	\$0.00	\$34.87	\$43.63
8th 6 months	85.00	\$18.60	\$7.75	\$8.98	\$0.50	\$0.00	\$0.70	\$0.00	\$0.00	\$0.00	\$36.53	\$45.83

Special Calculation Note : No special calculations for this skilled craft wage rate are required at this time.

Ratio :

2 Journeymen to 1 Apprentice

Jurisdiction (* denotes special jurisdictional note) :

CARROLL, STARK, TUSCARAWAS, WAYNE

Special Jurisdictional Note :

Details :

Prevailing Wage Rate Skilled Crafts

Name of Union: Carpenter Pile Driver NE Zone P3

Change # : LCN01-2020fbLocNEZoneP3

Craft : Carpenter Effective Date : 05/28/2020 Last Posted : 05/28/2020

	BHR		Fringe Benefit Payments					Irrevocable Fund		Total PWR	Overtime Rate	
			H&W	Pension	App Tr.	Vac.	Annuity	Other	LECET (*)			MISC (*)
Classification												
Carpenter Pile Driver	\$27.16		\$7.75	\$10.30	\$0.50	\$0.00	\$1.83	\$0.00	\$0.00	\$0.00	\$47.54	\$61.12
Diver	\$40.74		\$7.75	\$10.30	\$0.50	\$0.00	\$1.83	\$0.00	\$0.00	\$0.00	\$61.12	\$81.49
Certified Welder	\$28.21		\$7.75	\$10.30	\$0.50	\$0.00	\$1.83	\$0.00	\$0.00	\$0.00	\$48.59	\$62.69
Apprentice	Percent											
1st 6 months	60.00	\$16.30	\$7.75	\$10.30	\$0.50	\$0.00	\$1.83	\$0.00	\$0.00	\$0.00	\$36.68	\$44.82
2nd 6 months	60.00	\$16.30	\$7.75	\$10.30	\$0.50	\$0.00	\$1.83	\$0.00	\$0.00	\$0.00	\$36.68	\$44.82
3rd 6 months	62.00	\$16.84	\$7.75	\$10.30	\$0.50	\$0.00	\$1.83	\$0.00	\$0.00	\$0.00	\$37.22	\$45.64
4th 6 months	65.50	\$17.79	\$7.75	\$10.30	\$0.50	\$0.00	\$1.83	\$0.00	\$0.00	\$0.00	\$38.17	\$47.06
5th 6 months	69.00	\$18.74	\$7.75	\$10.30	\$0.50	\$0.00	\$1.83	\$0.00	\$0.00	\$0.00	\$39.12	\$48.49
6th 6 months	72.50	\$19.69	\$7.75	\$10.30	\$0.50	\$0.00	\$1.83	\$0.00	\$0.00	\$0.00	\$40.07	\$49.92
7th 6 months	76.00	\$20.64	\$7.75	\$10.30	\$0.50	\$0.00	\$1.83	\$0.00	\$0.00	\$0.00	\$41.02	\$51.34
8th 6 months	80.00	\$21.73	\$7.75	\$10.30	\$0.50	\$0.00	\$1.83	\$0.00	\$0.00	\$0.00	\$42.11	\$52.97

Special Calculation Note : No special calculations for this skilled craft wage rate are required at this time.

Ratio :

2 Journeymen to 1 Apprentice

Jurisdiction (* denotes special jurisdictional note) :

STARK, WAYNE, CARROLL, TUSCARAWAS

Special Jurisdictional Note :

Details :

Pile Drivers duties shall include but not limited to: Pile driving, milling, fashioning, joining assembling,

erecting, fastening, or dismantling of all material of wood, plastic, metal, fiber, cork and composition and all other substitute materials: pile driving, cutting, fitting and placing of lagging, and the handling, cleaning, erecting, installing and dismantling of machinery, equipment and erecting pre-engineered metal buildings. Pile Drivers work but not limited to: unloading, assembling, erection, repairs, operation, signaling, dismantling and reloading all equipment that is used for pile driving including pile butts is defined as sheeting or scrap piling. Underwater work that may be required in connection with the installation of piling. The driver and his tender work as a team and shall arrive at their own financial arrangements with the contractor. Any configuration of wood, steel, concrete or composite that is jetted, driven or vibrated onto the ground by conventional pile driving equipment for the purpose of supporting a future load that may be permanent or temporary. The construction of all wharves and docks, including the fabrication and installation of floating docks. Driving bracing, plumbing, cutting off and capping of all piling whether wood, metal, pipe piling or composite, loading, unloading, erecting, framing, dismantling, moving and handling of pile driving equipment piling used in the construction and repair of all wharves, docks, piers, trestles, caissons, cofferdams and erection of all sea walls and breakwaters. All underwater and marine work on bulkheads, wharves, docks, shipyards, caissons, piers, bridges, pipeline, work, viaducts, marine cable and trestles, as well as salvage and reclamation work where divers are employed. Rate shall include carpenters, acoustic and ceiling installers, drywall installers, pile drivers and floorlayers.

Prevailing Wage Rate Skilled Crafts

Name of Union: Carpenter Floorlayer NE Zone 2B

Change # : LCN01-2020fbLocNEZone2B

Craft : Carpenter Effective Date : 05/28/2020 Last Posted : 05/28/2020

	BHR		Fringe Benefit Payments						Irrevocable Fund		Total PWR	Overtime Rate
			H&W	Pension	App Tr.	Vac.	Annuity	Other	LECET (*)	MISC (*)		
Classification												
Carpenter Floorlayer	\$27.35		\$7.75	\$10.57	\$0.52	\$0.00	\$0.82	\$0.00	\$0.00	\$0.00	\$47.01	\$60.69
Apprentice	Percent											
1st 3 Months	60.00	\$16.41	\$0.00	\$0.00	\$0.00	\$0.00	\$0.00	\$0.00	\$0.00	\$0.00	\$16.41	\$24.62
2nd 3 Months	60.00	\$16.41	\$7.75	\$0.00	\$0.52	\$0.00	\$0.00	\$0.00	\$0.00	\$0.00	\$24.68	\$32.89
2nd 6 Months is 1st year	60.00	\$16.41	\$7.75	\$0.00	\$0.52	\$0.00	\$0.00	\$0.00	\$0.00	\$0.00	\$24.68	\$32.89
3rd 6 Months	60.00	\$16.41	\$7.75	\$0.00	\$0.52	\$0.00	\$0.00	\$0.00	\$0.00	\$0.00	\$24.68	\$32.89
4th 6 Months is 2nd year	60.00	\$16.41	\$7.75	\$0.00	\$0.52	\$0.00	\$0.00	\$0.00	\$0.00	\$0.00	\$24.68	\$32.89
5th 6 Months	70.00	\$19.14	\$7.75	\$7.40	\$0.52	\$0.00	\$0.57	\$0.00	\$0.00	\$0.00	\$35.39	\$44.96
6th 6 Months is 3rd year	75.00	\$20.51	\$7.75	\$7.93	\$0.52	\$0.00	\$0.62	\$0.00	\$0.00	\$0.00	\$37.33	\$47.59
7th 6 Months	80.00	\$21.88	\$7.75	\$8.46	\$0.52	\$0.00	\$0.66	\$0.00	\$0.00	\$0.00	\$39.27	\$50.21
8th 6 Months is 4th year	85.00	\$23.25	\$7.75	\$8.98	\$0.52	\$0.00	\$0.70	\$0.00	\$0.00	\$0.00	\$41.20	\$52.82

Special Calculation Note :

Ratio :

2 Journeymen to 1 Apprentice

Jurisdiction (* denotes special jurisdictional note) :

CARROLL, STARK, TUSCARAWAS, WAYNE

Special Jurisdictional Note :

Details :

Prevailing Wage Rate Skilled Crafts

Name of Union: Cement Mason Bricklayer Local 97 HevHwy A

Change # : LCN01-2020fbHvyHwy

Craft : Bricklayer Effective Date : 06/01/2020 Last Posted : 05/21/2020

	BHR		Fringe Benefit Payments					Irrevocable Fund		Total PWR	Overtime Rate	
			H&W	Pension	App Tr.	Vac.	Annuity	Other	LECET (*)			MISC (*)
Classification												
Cement Mason Bricklayer Sewer Water Works A	\$29.96	\$9.50	\$6.77	\$0.47	\$0.00	\$0.00	\$0.00	\$0.00	\$0.00	\$0.00	\$46.70	\$61.68
Apprentice	Percent											
1st year	50.00	\$14.98	\$9.50	\$6.77	\$0.47	\$0.00	\$0.00	\$0.00	\$0.00	\$0.00	\$31.72	\$39.21
2nd year	70.00	\$20.97	\$9.50	\$6.77	\$0.47	\$0.00	\$0.00	\$0.00	\$0.00	\$0.00	\$37.71	\$48.20
3rd year	90.00	\$26.96	\$9.50	\$6.77	\$0.47	\$0.00	\$0.00	\$0.00	\$0.00	\$0.00	\$43.70	\$57.19

Special Calculation Note : NOT FOR BUILDING CONSTRUCTION.

Ratio :

- 3 Journeymen to 1 Apprentice
- 6 Journeymen to 2 Apprentice
- 9 Journeymen to 3 Apprentice
- 12 Journeymen to 4 Apprentice
- 15 Journeymen to 5 Apprentice

Jurisdiction (* denotes special jurisdictional note) :

- ADAMS, ALLEN, ASHLAND, ASHTABULA, ATHENS, AUGLAIZE, BELMONT, BROWN, BUTLER, CARROLL, CHAMPAIGN, CLARK, CLERMONT, CLINTON, COLUMBIANA, COSHOCTON, CRAWFORD, CUYAHOGA, DARKE, DEFIANCE, DELAWARE, ERIE, FAIRFIELD, FAYETTE, FRANKLIN, FULTON, GALLIA, GEauga, GREENE, GUERNSEY, HAMILTON, HANCOCK, HARDIN, HARRISON, HENRY, HIGHLAND, HOCKING, HOLMES, HURON, JACKSON, JEFFERSON, KNOX, LAKE, LAWRENCE, LICKING, LOGAN, LORAIN, LUCAS, MADISON, MAHONING, MARION, MEDINA, MEIGS, MERCER, MIAMI, MONROE, MONTGOMERY, MORGAN, MORROW, MUSKINGUM, NOBLE, OTTAWA, PAULDING, PERRY, PICKAWAY, PIKE, PORTAGE, PREBLE, PUTNAM, RICHLAND, ROSS, SANDUSKY, SCIOTO, SENECA,

SHELBY, STARK, SUMMIT, TRUMBULL,
TUSCARAWAS, UNION, VAN WERT, VINTON,
WARREN, WASHINGTON, WAYNE

Special Jurisdictional Note :

Details :

(A) Highway Construction, Sewer, Waterworks And Utility Construction, Industrial & Building Site Heavy Construction, Airport Construction Or Railroad Construction Work.

(B) Power Plant, Tunnels, Amusement Park, Athletic Stadium Site Work ,Pollution Control,Sewer Plant, Waste Plant, & Water Treatment Facilities, Construction.

Prevailing Wage Rate Skilled Crafts

Name of Union: Cement Mason Bricklayer Local 97 HevHwy B

Change # : LCN01-2020fbHvyHwy

Craft : Bricklayer Effective Date : 06/01/2020 Last Posted : 05/21/2020

	BHR		Fringe Benefit Payments					Irrevocable Fund		Total PWR	Overtime Rate	
			H&W	Pension	App Tr.	Vac.	Annuity	Other	LECET (*)			MISC (*)
Classification												
Cement Mason Bricklayer Power Plants Tunnels Amusement Parks B	\$30.95		\$9.50	\$6.77	\$0.48	\$0.00	\$0.00	\$0.00	\$0.00	\$0.00	\$47.70	\$63.17
Apprentice	Percent											
1st year	50.00	\$15.48	\$9.50	\$6.77	\$0.48	\$0.00	\$0.00	\$0.00	\$0.00	\$0.00	\$32.23	\$39.96
2nd year	70.00	\$21.66	\$9.50	\$6.77	\$0.48	\$0.00	\$0.00	\$0.00	\$0.00	\$0.00	\$38.42	\$49.25
3rd year	90.00	\$27.85	\$9.50	\$6.77	\$0.48	\$0.00	\$0.00	\$0.00	\$0.00	\$0.00	\$44.60	\$58.53

Special Calculation Note : NOT FOR BUILDING CONSTRUCTION.

Ratio :

- 3 Journeymen to 1 Apprentice
- 6 Journeymen to 2 Apprentice
- 9 Journeymen to 2 Apprentice
- 12 Journeymen to 4 Apprentice
- 15 Journeymen to 5 Apprentice

Jurisdiction (* denotes special jurisdictional note) :

- ADAMS, ALLEN, ASHLAND, ASHTABULA, ATHENS, AUGLAIZE, BELMONT, BROWN, BUTLER, CARROLL, CHAMPAIGN, CLARK, CLERMONT, CLINTON, COLUMBIANA, COSHOCTON, CRAWFORD, CUYAHOGA, DARKE, DEFIANCE, DELAWARE, ERIE, FAIRFIELD, FAYETTE, FRANKLIN, FULTON, GALLIA, GEAUGA, GREENE, GUERNSEY, HAMILTON, HANCOCK, HARDIN, HARRISON, HENRY, HIGHLAND, HOCKING, HOLMES, HURON, JACKSON, JEFFERSON, KNOX, LAKE, LAWRENCE, LICKING, LOGAN, LORAIN, LUCAS, MADISON, MAHONING, MARION, MEDINA, MEIGS, MERCER, MIAMI, MONROE, MONTGOMERY, MORGAN, MORROW, MUSKINGUM, NOBLE, OTTAWA, PAULDING, PERRY, PICKAWAY, PIKE,

PORTAGE, PREBLE, PUTNAM, RICHLAND,
ROSS, SANDUSKY, SCIOTO, SENECA,
SHELBY, STARK, SUMMIT, TRUMBULL,
TUSCARAWAS, UNION, VAN WERT, VINTON,
WARREN, WASHINGTON, WAYNE

Special Jurisdictional Note :

Details :

(A) Highway Construction, Sewer, Waterworks And Utility Construction, Industrial & Building Site Heavy Construction, Airport Construction Or Railroad Construction Work.

(B) Power Plant, Tunnels, Amusement Park, Athletic Stadium Site Work ,Pollution Control,Sewer Plant, Waste Plant, & Water Treatment Facilities, Construction.

Prevailing Wage Rate Skilled Crafts

Name of Union: Cement Mason Statewide HevHwy Exhibit A District II

Change # : LCN01-2020fbCementHevHwy

Craft : Cement Mason Effective Date : 05/01/2020 Last Posted : 04/30/2020

	BHR		Fringe Benefit Payments					Irrevocable Fund		Total PWR	Overtime Rate	
			H&W	Pension	App Tr.	Vac.	Annuity	Other	LECET (*)			MISC (*)
Classification												
Cement Mason	\$30.11		\$8.25	\$7.15	\$0.65	\$0.00	\$2.25	\$0.00	\$0.00	\$0.00	\$48.41	\$63.46
Apprentice	Percent											
1st Year	70.00	\$21.08	\$8.25	\$7.15	\$0.65	\$0.00	\$2.25	\$0.00	\$0.00	\$0.00	\$39.38	\$49.92
2nd Year	80.00	\$24.09	\$8.25	\$7.15	\$0.65	\$0.00	\$2.25	\$0.00	\$0.00	\$0.00	\$42.39	\$54.43
3rd Year	90.00	\$27.10	\$8.25	\$7.15	\$0.65	\$0.00	\$2.25	\$0.00	\$0.00	\$0.00	\$45.40	\$58.95

Special Calculation Note : No special calculations for this skilled craft wage rate are required at this time.

Ratio :

1 Journeymen to 1 Apprentice
2 to 1 thereafter

Jurisdiction (* denotes special jurisdictional note) :

BROWN, BUTLER, CLERMONT,
COLUMBIANA, DEFIANCE, ERIE, HAMILTON,
HIGHLAND, HURON, LORAIN, MAHONING,
MEDINA, OTTAWA, PAULDING, PORTAGE,
SANDUSKY, SENECA, STARK, SUMMIT,
TRUMBULL, WARREN, WILLIAMS

Special Jurisdictional Note : (A) Highway Construction, Sewer, Waterworks And Utility Construction, Industrial & Building Site, Heavy Construction, Airport Construction Or Railroad Construction Work.

Details :

Prevailing Wage Rate Skilled Crafts

Name of Union: Cement Mason Statewide Hwy Exhibit B District II

Change # : LCN01-2019fbCementHwy

Craft : Cement Mason Effective Date : 05/01/2020 Last Posted : 04/30/2020

	BHR		Fringe Benefit Payments					Irrevocable Fund		Total PWR	Overtime Rate	
			H&W	Pension	App Tr.	Vac.	Annuity	Other	LECET (*)			MISC (*)
Classification												
Cement Mason	\$30.98		\$8.25	\$7.15	\$0.65	\$0.00	\$2.25	\$0.00	\$0.00	\$0.00	\$49.28	\$64.77
Apprentice	Percent											
1st Year	70.00	\$21.69	\$8.25	\$7.15	\$0.65	\$0.00	\$2.25	\$0.00	\$0.00	\$0.00	\$39.99	\$50.83
2nd Year	80.00	\$24.78	\$8.25	\$7.15	\$0.65	\$0.00	\$2.25	\$0.00	\$0.00	\$0.00	\$43.08	\$55.48
3rd Year	90.00	\$27.88	\$8.25	\$7.15	\$0.65	\$0.00	\$2.25	\$0.00	\$0.00	\$0.00	\$46.18	\$60.12

Special Calculation Note : No special calculations for this skilled craft wage rate are required at this time.

Ratio :

1 Journeymen to 1 Apprentice
2 to 1 thereafter

Jurisdiction (* denotes special jurisdictional note) :

BROWN, BUTLER, CLERMONT, COLUMBIANA, DEFIANCE, ERIE, HAMILTON, HIGHLAND, HURON, LORAIN, MAHONING, MEDINA, OTTAWA, PAULDING, PORTAGE, SANDUSKY, SENECA, STARK, SUMMIT, TRUMBULL, WARREN, WILLIAMS

Special Jurisdictional Note : (B) Power Plant, Tunnels, Amusement Park, Athletic Stadium Site Work ,Pollution Control,Sewer Plant, Waste Plant, & Water Treatment Facilities, Construction.

Details :

Prevailing Wage Rate Skilled Crafts

Name of Union: Cement Mason & Plasterer Local 109

Change # : LCN01-2020fbLoc109

Craft : Cement Effective Date : 07/09/2020 Last Posted : 07/09/2020

	BHR		Fringe Benefit Payments						Irrevocable Fund		Total PWR	Overtime Rate
			H&W	Pension	App Tr.	Vac.	Annuity	Other	LECET (*)	MISC (*)		
Classification												
Cement Mason	\$30.04		\$8.89	\$7.15	\$0.40	\$0.00	\$4.25	\$0.06	\$0.00	\$0.00	\$50.79	\$65.81
Plasterer	\$29.33		\$8.39	\$7.15	\$0.40	\$0.00	\$4.00	\$0.06	\$0.00	\$0.00	\$49.33	\$64.00
Apprentice Cement Mason	Percent											
1st year	70.52	\$21.18	\$8.89	\$7.15	\$0.40	\$0.00	\$4.25	\$0.06	\$0.00	\$0.00	\$41.93	\$52.53
2nd year	80.36	\$24.14	\$8.89	\$7.15	\$0.40	\$0.00	\$4.25	\$0.06	\$0.00	\$0.00	\$44.89	\$56.96
3rd year	90.18	\$27.09	\$8.89	\$7.15	\$0.40	\$0.00	\$4.25	\$0.06	\$0.00	\$0.00	\$47.84	\$61.39
Plasterer Apprentice												
1st year	68.89	\$20.69	\$8.39	\$7.15	\$0.40	\$0.00	\$4.00	\$0.06	\$0.00	\$0.00	\$40.69	\$51.04
2nd year	78.45	\$23.57	\$8.39	\$7.15	\$0.40	\$0.00	\$4.00	\$0.06	\$0.00	\$0.00	\$43.57	\$55.35
3rd year	88.05	\$26.45	\$8.39	\$7.15	\$0.40	\$0.00	\$4.00	\$0.06	\$0.00	\$0.00	\$46.45	\$59.68

Special Calculation Note : Other is for International Training.

Ratio :

1 Journeymen to 1 Apprentice
5 Journeymen to 2 Apprentice

Jurisdiction (* denotes special jurisdictional note) :

CARROLL, HOLMES, MEDINA, PORTAGE,
STARK, SUMMIT, TUSCARAWAS, WAYNE

Special Jurisdictional Note :

Details :

Finishers when applying colorshake shall be paid an additional \$2.00 per DAY.
Swing Scaffolds up to 50 feet shall be paid \$0.25 above the Journeymen rate.
Swing Scaffolds over 50 feet shall be paid \$0.35 above the Journeymen rate.

Prevailing Wage Rate Skilled Crafts

Name of Union: Electrical Local 540 Inside

Change # : LCN01-2020fbLoc540in

Craft : Electrical Effective Date : 01/05/2021 Last Posted : 01/05/2021

	BHR		Fringe Benefit Payments						Irrevocable Fund		Total PWR	Overtime Rate
			H&W	Pension	App Tr.	Vac.	Annuity	Other	LECET (*)	MISC (*)		
Classification												
Electrician	\$34.00		\$6.40	\$9.70	\$1.05	\$3.40	\$3.83	\$1.12	\$0.00	\$0.00	\$59.50	\$76.50
Apprentice	Percent											
1st 1000 hrs	40.00	\$13.60	\$6.40	\$0.00	\$0.38	\$0.00	\$0.00	\$0.41	\$0.00	\$0.00	\$20.79	\$27.59
2nd 1000 hrs	45.00	\$15.30	\$6.40	\$0.00	\$0.43	\$0.00	\$0.00	\$0.46	\$0.00	\$0.00	\$22.59	\$30.24
3rd 1500 hrs	50.00	\$17.00	\$6.40	\$1.94	\$0.51	\$1.36	\$0.77	\$0.55	\$0.00	\$0.00	\$28.53	\$37.03
4th 1500 hrs	60.00	\$20.40	\$6.40	\$3.88	\$0.62	\$1.63	\$1.53	\$0.66	\$0.00	\$0.00	\$35.12	\$45.32
5th 1500 hrs	70.00	\$23.80	\$6.40	\$5.82	\$0.72	\$1.90	\$2.30	\$0.77	\$0.00	\$0.00	\$41.71	\$53.61
6th 1500 hrs	80.00	\$27.20	\$6.40	\$7.76	\$0.82	\$2.18	\$3.06	\$0.88	\$0.00	\$0.00	\$48.30	\$61.90

Special Calculation Note : OTHER = (NEBF) National Electrical Benefit Fund. Vacation contribution is equal to 8% of the gross weekly wages.

Ratio :

The first person assigned to any job site shall be a Journeyman Wireman. Ratio thereafter:

- 1-3 Journeymen to 2 Apprentices
- 4 to 6 Journeymen up to 4 Apprentices
- 7 to 9 Journeymen up to 6 Apprentices

Jurisdiction (* denotes special jurisdictional note) :

CARROLL*, COLUMBIANA*, HOLMES, MAHONING*, STARK, TUSCARAWAS*, WAYNE*

Special Jurisdictional Note : Carroll County: North half including; Fox, Harrison, Rose and Washington Townships.

Columbiana County: Knox Township only.

Mahoning County: Smith Township only.

Tuscarawas County: That portion North of Auburn, Clay, Rush and York Townships.

Wayne County: That portion south of Baughman, Chester, Green, Wayne and Wooster Townships.

Details :

Prevailing Wage Rate Skilled Crafts

Name of Union: Electrical Local 540 Inside Lt Commercial Northern

Change # : LCN01-2021fbLoc540in

Craft : Electrical Effective Date : 01/05/2021 Last Posted : 01/05/2021

	BHR		Fringe Benefit Payments					Irrevocable Fund		Total PWR	Overtime Rate	
			H&W	Pension	App Tr.	Vac.	Annuity	Other	LECET (*)			MISC (*)
Classification												
Electrician	\$34.00		\$6.40	\$9.70	\$1.05	\$3.40	\$3.83	\$1.12	\$0.00	\$0.00	\$59.50	\$76.50
CE-3 12,001-14,000 Hrs	\$25.63		\$6.15	\$0.00	\$0.83	\$0.00	\$0.77	\$0.77	\$0.00	\$0.00	\$34.15	\$46.97
CE-2 10,001-12,000 Hrs	\$20.14		\$6.15	\$0.00	\$0.83	\$0.00	\$0.60	\$0.60	\$0.00	\$0.00	\$28.32	\$38.39
CE-1 8,001-10,000 Hrs	\$18.31		\$6.15	\$0.00	\$0.83	\$0.00	\$0.55	\$0.55	\$0.00	\$0.00	\$26.39	\$35.54
CW-4 6,001-8,000 Hrs	\$16.48		\$6.15	\$0.00	\$0.83	\$0.00	\$0.49	\$0.49	\$0.00	\$0.00	\$24.44	\$32.68
CW-3 4,001-6,000 Hrs	\$14.65		\$6.15	\$0.00	\$0.83	\$0.00	\$0.44	\$0.44	\$0.00	\$0.00	\$22.51	\$29.83
CW-2 2,001-4,000 Hrs	\$13.73		\$6.15	\$0.00	\$0.83	\$0.00	\$0.41	\$0.41	\$0.00	\$0.00	\$21.53	\$28.39
CW-1 0-2,000 Hrs	\$12.82		\$6.15	\$0.00	\$0.83	\$0.00	\$0.38	\$0.38	\$0.00	\$0.00	\$20.56	\$26.97
Apprentice	Percent											
1st 1000 hrs	40.00	\$13.60	\$6.40	\$0.00	\$0.38	\$0.00	\$0.00	\$0.41	\$0.00	\$0.00	\$20.79	\$27.59
2nd 1000 hrs	45.00	\$15.30	\$6.40	\$0.00	\$0.43	\$0.00	\$0.00	\$0.46	\$0.00	\$0.00	\$22.59	\$30.24
3rd 1500 hrs	50.00	\$17.00	\$6.40	\$1.94	\$0.51	\$1.36	\$0.77	\$0.55	\$0.00	\$0.00	\$28.53	\$37.03
4th 1500 hrs	60.00	\$20.40	\$6.40	\$3.88	\$0.62	\$1.63	\$1.53	\$0.66	\$0.00	\$0.00	\$35.12	\$45.32
5th 1500 hrs	70.00	\$23.80	\$6.40	\$5.82	\$0.72	\$1.90	\$2.30	\$0.77	\$0.00	\$0.00	\$41.71	\$53.61
6th 1500 hrs	80.00	\$27.20	\$6.40	\$7.76	\$0.82	\$2.18	\$3.06	\$0.88	\$0.00	\$0.00	\$48.30	\$61.90

Special Calculation Note : OTHER = (NEBF) National Electrical Benefit Fund

Ratio :

1 to 3 Journeymen to 2 Apprentices
 4 to 6 Journeymen up to 4 Apprentices
 7 to 9 Journeymen up to 6 Apprentices

Jurisdiction (* denotes special jurisdictional note) :

CARROLL*, COLUMBIANA*, HOLMES,
 MAHONING*, STARK, TUSCARAWAS*, WAYNE*

Construction Electrician and Construction Wireman Ratio

There shall be a minimum ratio of one inside Journeyman Wireman to every (4) employees of different classifications per jobsite. An Inside Journeyman Wireman is required on the project as the fifth (5th) worker or when apprentices are used.

Special Jurisdictional Note : Carroll County: North half including; Fox, Harrison, Rose and Washington Townships.

Columbiana County: Knox Township only.

Mahoning County: Smith Township only.

Tuscarawas County: That portion North of Auburn, Clay, Rush and York Townships.

Wayne County: That portion south of Baughman, Chester, Green, Wayne and Wooster Townships.

The scope of work for the light commercial agreement shall apply to the following small medical clinics, stand-alone doctor and dentist offices with up to 600 amp service (not attached to a hospital), gas stations/convenience stores, fast food restaurants and franchised chain restaurants including independent bars and taverns, places of worship, funeral homes, nursing homes, assisted living facilities and day-care facilities under 15,000 sq ft, small office, retail/wholesale facilities under 15,000 sq ft with less than 10 units attached, storage units, car washes, express hotels and motels (4 stories or less) without conference or restaurants facilities, residential units (subject to Davis Bacon Rates) small stand-alone manufacturing facilities when free standing and not part of a larger facility (less than 15,000 sq ft) solar projects (500 panels or less) unless other wise covered under this agreement, lighting retrofits (when not associated with remodels involving branch re-circuiting) Lighting retrofits shall be defined as the changing of lamps and ballasts in existing light fixtures and shall also include the one for one replacement of existing fixtures.

Details :

Prevailing Wage Rate Skilled Crafts

Name of Union: Electrical Local 540 Voice Data Video

Change # : LCN01-2020fbLoc540VDV

Craft : Voice Data Video Effective Date : 10/15/2020 Last Posted : 10/15/2020

	BHR		Fringe Benefit Payments					Irrevocable Fund		Total PWR	Overtime Rate	
			H&W	Pension	App Tr.	Vac.	Annuity	Other	LECET (*)			MISC (*)
Classification												
Electrical Installer Technician	\$22.85		\$6.30	\$4.79	\$0.57	\$2.29	\$1.83	\$0.75	\$0.00	\$0.00	\$39.38	\$50.81
Cable Puller	\$13.02		\$6.30	\$0.00	\$0.29	\$0.00	\$0.39	\$0.39	\$0.00	\$0.00	\$20.39	\$26.90
Apprentice Starting Prior to 08/01/2020												
2nd Step 65%	\$14.85		\$6.30	\$0.00	\$0.36	\$1.19	\$0.00	\$0.48	\$0.00	\$0.00	\$23.18	\$30.60
3rd Step 75%	\$17.14		\$6.30	\$4.79	\$0.42	\$1.37	\$1.83	\$0.56	\$0.00	\$0.00	\$32.41	\$40.98
4th Step 80%	\$18.28		\$6.30	\$4.79	\$0.44	\$1.46	\$1.83	\$0.59	\$0.00	\$0.00	\$33.69	\$42.83
5th Step 85%	\$19.42		\$6.30	\$4.79	\$0.47	\$1.55	\$1.83	\$0.63	\$0.00	\$0.00	\$34.99	\$44.70
6th Step 90%	\$20.57		\$6.30	\$4.79	\$0.50	\$1.65	\$1.83	\$0.67	\$0.00	\$0.00	\$36.31	\$46.60
Apprentice Starting After 08/01/2020	Percent											
1st Step	60.00	\$13.71	\$6.30	\$0.00	\$0.31	\$0.00	\$1.10	\$0.41	\$0.00	\$0.00	\$21.83	\$28.69
2nd Step	65.00	\$14.85	\$6.30	\$3.11	\$0.36	\$1.19	\$1.19	\$0.48	\$0.00	\$0.00	\$27.48	\$34.91
3rd Step	75.00	\$17.14	\$6.30	\$3.59	\$0.42	\$1.37	\$1.37	\$0.56	\$0.00	\$0.00	\$30.75	\$39.32
4th Step	85.00	\$19.42	\$6.30	\$4.07	\$0.47	\$1.55	\$1.56	\$0.63	\$0.00	\$0.00	\$34.00	\$43.71

Special Calculation Note : OTHER = (NEBF) National Electrical Benefit Fund.

VACATION PAY - For Journeymen is 10% of wages and 8% for Apprentices.

Ratio :

Jurisdiction (* denotes special jurisdictional note) :

1-3 Journeyman to 2 Apprentice
4-6 Journeyman to 4 Apprentice

CARROLL*, COLUMBIANA*, HOLMES,
MAHONING*, STARK, TUSCARAWAS*,
WAYNE*

** Exception - When fire alarm falls within the scope of this addendum, Cable Pullers can be used to aid in test and be the 2nd Teledata employee on the job

Special Jurisdictional Note : Carroll County includes the following townships: North half including Fox, Harrison, Rose and Washington. Tuscarawas County includes the following townships: The portion North of Auburn, Clay, Rush and York. Wayne County includes the following townships: The portion South of Baughman, Chester, Green, and Wayne. Columbiana County includes Knox township. Mahoning County includes Smith township.

Details :

CABLE PULLERS - are for the installation of cable from one termination point to another.

The following work is EXCLUDED from the Teledata Technician work scope:

- * - Installation of computer systems in industrial applications such as assembly lines, robotics, computer controller manufacturing systems.
- * - Installation of conduit and/ or raceways shall be installed by Inside Wireman . On sites where there is no Inside Wireman employed, the Teledata Technician may install raceway, or conduit not greater than 10 feet.
- * - Fire Alarm work on all new construction sites or wherever the fire alarm system is installed in conduit.
- * - All HVAC control work.

Prevailing Wage Rate Skilled Crafts

Name of Union: Electrical Local 71 High Tension Pipe Type Cable

Change # : LCN01-2019fbLoc7

Craft : Lineman Effective Date : 04/24/2019 Last Posted : 04/24/2019

	BHR	Fringe Benefit Payments						Irrevocable Fund		Total PWR	Overtime Rate
		H&W	Pension	App Tr.	Vac.	Annuity	Other	LECET (*)	MISC (*)		
Classification											
Electrical Lineman	\$43.48	\$6.00	\$1.30	\$0.43	\$0.00	\$10.00	\$0.35	\$0.00	\$0.00	\$61.56	\$83.30
Certified Lineman Welder	\$43.48	\$6.00	\$1.30	\$0.43	\$0.00	\$10.00	\$0.35	\$0.00	\$0.00	\$61.56	\$83.30
Certified Cable Splicer	\$43.48	\$6.00	\$1.30	\$0.43	\$0.00	\$10.00	\$0.35	\$0.00	\$0.00	\$61.56	\$83.30
Operator A	\$39.02	\$6.00	\$1.17	\$0.39	\$0.00	\$8.97	\$0.35	\$0.00	\$0.00	\$55.90	\$75.41
Operator B	\$34.60	\$6.00	\$1.04	\$0.35	\$0.00	\$7.96	\$0.35	\$0.00	\$0.00	\$50.30	\$67.60
Operator C	\$27.93	\$6.00	\$0.84	\$0.28	\$0.00	\$6.42	\$0.35	\$0.00	\$0.00	\$41.82	\$55.79
Groundman 0-12 months Exp	\$21.74	\$6.00	\$0.65	\$0.22	\$0.00	\$5.00	\$0.35	\$0.00	\$0.00	\$33.96	\$44.83
Groundman 0-12 months Exp w/CDL	\$23.91	\$6.00	\$0.72	\$0.24	\$0.00	\$5.50	\$0.35	\$0.00	\$0.00	\$36.72	\$48.68
Groundman 1 yr or more	\$23.91	\$6.00	\$0.72	\$0.24	\$0.00	\$5.50	\$0.35	\$0.00	\$0.00	\$36.72	\$48.68
Groundman 1 yr or more w/CDL	\$28.26	\$6.00	\$0.85	\$0.28	\$0.00	\$6.50	\$0.35	\$0.00	\$0.00	\$42.24	\$56.37
Equipment Mechanic A	\$34.60	\$6.00	\$1.04	\$0.35	\$0.00	\$7.96	\$0.35	\$0.00	\$0.00	\$50.30	\$67.60
Equipment Mechanic B	\$31.26	\$6.00	\$0.94	\$0.31	\$0.00	\$7.19	\$0.35	\$0.00	\$0.00	\$46.05	\$61.68
Equipment Mechanic C	\$27.93	\$6.00	\$0.84	\$0.28	\$0.00	\$6.42	\$0.35	\$0.00	\$0.00	\$41.82	\$55.79

X-Ray Technician	\$43.48	\$6.00	\$1.30	\$0.43	\$0.00	\$10.00	\$0.35	\$0.00	\$0.00	\$61.56	\$83.30	
Apprentice	Percent											
1st 1000 hrs	60.00	\$26.09	\$6.00	\$0.78	\$0.26	\$0.00	\$6.00	\$0.35	\$0.00	\$0.00	\$39.48	\$52.52
2nd 1000 hrs	65.00	\$28.26	\$6.00	\$0.85	\$0.28	\$0.00	\$6.50	\$0.35	\$0.00	\$0.00	\$42.24	\$56.37
3rd 1000 hrs	70.00	\$30.44	\$6.00	\$0.91	\$0.30	\$0.00	\$7.00	\$0.35	\$0.00	\$0.00	\$45.00	\$60.21
4th 1000 hrs	75.00	\$32.61	\$6.00	\$0.98	\$0.33	\$0.00	\$7.50	\$0.35	\$0.00	\$0.00	\$47.77	\$64.07
5th 1000 hrs	80.00	\$34.78	\$6.00	\$1.04	\$0.35	\$0.00	\$8.00	\$0.35	\$0.00	\$0.00	\$50.52	\$67.92
6th 1000 hrs	85.00	\$36.96	\$6.00	\$1.11	\$0.37	\$0.00	\$8.50	\$0.35	\$0.00	\$0.00	\$53.29	\$71.77
7th 1000 hrs	90.00	\$39.13	\$6.00	\$1.17	\$0.39	\$0.00	\$9.00	\$0.35	\$0.00	\$0.00	\$56.04	\$75.61

Special Calculation Note : Other is Health Retirement Account

Operator "A"

John Henry Rock Drill, D-6 (or equivalent) and above, Trackhoe Digger, (320 Track excavator), Cranes (greater then 25 tons and less than 45 tons).

Operator "B"

Cranes (greater than 6 tons and up to 25 tons), Backhoes, Road Tractor, Dozer up to D-5, Pressure Digger- wheeled or tracked, all Tension wire Stringing equipment.

Operator "C"

Trench, Backhoe, Riding type vibratory Compactor, Ground Rod Driver, Boom Truck (6 ton & below), Skid Steer Loaders, Material Handler.

*All Operators of cranes 45 ton or larger shall be paid the journeyman rate of pay. \$0.30 is for Health Retirement Account.

Ratio :

1 Journeyman to 1 Apprentice

Jurisdiction (* denotes special jurisdictional note) :

ADAMS, ASHLAND, ASHTABULA, ATHENS, AUGLAIZE, BELMONT, BROWN, BUTLER, CARROLL, CHAMPAIGN, CLARK, CLERMONT, CLINTON, COLUMBIANA, COSHOCTON, CRAWFORD, CUYAHOGA, DARKE, DELAWARE, FAIRFIELD, FAYETTE, FRANKLIN, GALLIA, GEAUGA, GREENE, GUERNSEY, HAMILTON, HARRISON, HIGHLAND, HOCKING, HOLMES, JACKSON, JEFFERSON, KNOX, LAKE, LAWRENCE, LICKING, LOGAN, LORAIN, MADISON, MAHONING, MARION, MEDINA, MEIGS, MERCER, MIAMI, MONROE, MONTGOMERY,

MORGAN, MORROW, MUSKINGUM, NOBLE,
PERRY, PICKAWAY, PIKE, PORTAGE, PREBLE,
RICHLAND, ROSS, SCIOTO, SHELBY, STARK,
SUMMIT, TRUMBULL, TUSCARAWAS,
UNION, VINTON, WARREN, WASHINGTON,
WAYNE

Special Jurisdictional Note :

Details :

Heli - Arc Welding will be paid \$.30 above Journeyman rate. Additional compensation of 10% over the Journeyman Lineman and Journeyman Technician for performing work on structures outside of buildings such as water towers, smoke stacks, radio and television towers, more than 75' above the ground.

Prevailing Wage Rate Skilled Crafts

Name of Union: Electrical Local 71 Outside Utility Power

Change # : LCN01-2019fbLoc7

Craft : Lineman Effective Date : 04/24/2019 Last Posted : 04/24/2019

	BHR	Fringe Benefit Payments						Irrevocable Fund		Total PWR	Overtime Rate
		H&W	Pension	App Tr.	Vac.	Annuity	Other	LECET (*)	MISC (*)		
Classification											
Electrical Lineman	\$41.22	\$6.00	\$1.24	\$0.41	\$0.00	\$9.48	\$0.35	\$0.00	\$0.00	\$58.70	\$79.31
Substation Technician	\$41.22	\$6.00	\$1.24	\$0.41	\$0.00	\$9.48	\$0.35	\$0.00	\$0.00	\$58.70	\$79.31
Cable Splicer	\$43.14	\$6.00	\$1.29	\$0.43	\$0.00	\$9.92	\$0.35	\$0.00	\$0.00	\$61.13	\$82.70
Operator A	\$37.00	\$6.00	\$1.11	\$0.37	\$0.00	\$8.51	\$0.35	\$0.00	\$0.00	\$53.34	\$71.84
Operator B	\$32.78	\$6.00	\$0.98	\$0.33	\$0.00	\$7.54	\$0.35	\$0.00	\$0.00	\$47.98	\$64.37
Operator C	\$26.44	\$6.00	\$0.79	\$0.26	\$0.00	\$6.08	\$0.35	\$0.00	\$0.00	\$39.92	\$53.14
Groundman 0-12 months Exp	\$20.61	\$6.00	\$0.62	\$0.21	\$0.00	\$4.74	\$0.35	\$0.00	\$0.00	\$32.53	\$42.84
Groundman 0-12 months Exp w/CDL	\$22.67	\$6.00	\$0.68	\$0.23	\$0.00	\$5.21	\$0.35	\$0.00	\$0.00	\$35.14	\$46.48
Groundman 1 yr or more	\$22.67	\$6.00	\$0.68	\$0.23	\$0.00	\$5.21	\$0.35	\$0.00	\$0.00	\$35.14	\$46.48
Groundman 1 yr or more w/CDL	\$26.80	\$6.00	\$0.80	\$0.27	\$0.00	\$6.16	\$0.35	\$0.00	\$0.00	\$40.38	\$53.78
Equipment Mechanic A	\$32.78	\$6.00	\$0.98	\$0.33	\$0.00	\$7.54	\$0.35	\$0.00	\$0.00	\$47.98	\$64.37
Equipment Mechanic B	\$29.62	\$6.00	\$0.89	\$0.30	\$0.00	\$6.81	\$0.35	\$0.00	\$0.00	\$43.97	\$58.78
Equipment Mechanic C	\$26.44	\$6.00	\$0.79	\$0.26	\$0.00	\$6.08	\$0.35	\$0.00	\$0.00	\$39.92	\$53.14
Line Truck w/uuger	\$29.17	\$6.00	\$0.88	\$0.29	\$0.00	\$6.71	\$0.35	\$0.00	\$0.00	\$43.40	\$57.99

Apprentice	Percent												
1st 1000 hrs	60.00	\$24.73	\$6.00	\$0.74	\$0.25	\$0.00	\$5.69	\$0.35	\$0.00	\$0.00	\$37.76	\$50.13	
2nd 1000 hrs	65.00	\$26.79	\$6.00	\$0.80	\$0.27	\$0.00	\$6.16	\$0.35	\$0.00	\$0.00	\$40.37	\$53.77	
3rd 1000 hrs	70.00	\$28.85	\$6.00	\$0.87	\$0.29	\$0.00	\$6.64	\$0.35	\$0.00	\$0.00	\$43.00	\$57.43	
4th 1000 hrs	75.00	\$30.91	\$6.00	\$0.93	\$0.31	\$0.00	\$7.11	\$0.35	\$0.00	\$0.00	\$45.62	\$61.07	
5th 1000 hrs	80.00	\$32.98	\$6.00	\$0.99	\$0.33	\$0.00	\$7.59	\$0.35	\$0.00	\$0.00	\$48.24	\$64.72	
6th 1000 hrs	85.00	\$35.04	\$6.00	\$1.05	\$0.35	\$0.00	\$8.06	\$0.35	\$0.00	\$0.00	\$50.85	\$68.37	
7th 1000 hrs	90.00	\$37.10	\$6.00	\$1.11	\$0.37	\$0.00	\$8.53	\$0.35	\$0.00	\$0.00	\$53.46	\$72.01	

Special Calculation Note : Other is Health Retirement Account

Operator "A"

John Henry Rock Drill, D-6 (or equivalent) and above, Trackhoe Digger, (320 Track excavator), Cranes (greater then 25 tons and less than 45 tons).

Operator "B"

Cranes (greater than 6 tons and up to 25 tons), Backhoes, Road Tractor, Dozer up to D-5, Pressure Digger- wheeled or tracked, all Tension wire Stringing equipment.

Operator "C"

Trench, Backhoe, Riding type vibratory Compactor, Ground Rod Driver, Boom Truck (6 ton & below), Skid Steer Loaders, Material Handler.

Ratio :

(1) Journeyman Lineman to (1) Apprentice

Jurisdiction (* denotes special jurisdictional note) :

ADAMS, ASHLAND, ASHTABULA, ATHENS, AUGLAIZE, BELMONT, BROWN, BUTLER, CARROLL, CHAMPAIGN, CLARK, CLERMONT, CLINTON, COLUMBIANA, COSHOCTON, CRAWFORD, CUYAHOGA, DARKE, DELAWARE, FAIRFIELD, FAYETTE, FRANKLIN, GALLIA, GEAUGA, GREENE, GUERNSEY, HAMILTON, HARRISON, HIGHLAND, HOCKING, HOLMES, JACKSON, JEFFERSON, KNOX, LAKE, LAWRENCE, LICKING, LOGAN, LORAIN, MADISON, MAHONING, MARION, MEDINA, MEIGS, MERCER, MIAMI, MONROE, MONTGOMERY, MORGAN, MORROW, MUSKINGUM, NOBLE, PERRY, PICKAWAY, PIKE, PORTAGE, PREBLE, RICHLAND, ROSS, SCIOTO, SHELBY, STARK, SUMMIT, TRUMBULL, TUSCARAWAS, UNION, VINTON, WARREN, WASHINGTON, WAYNE

Special Jurisdictional Note : 0.30 is for Health Retirement Account.

Details :

Heli - Arc Welding will be paid \$.30 above Journeyman rate. Additional compensation of 10% over the Journeyman Lineman and Journeyman Technician for performing work on structures outside of buildings such as water towers, smoke stacks, radio and television towers, more than 75' above the ground.

Prevailing Wage Rate Skilled Crafts

Name of Union: Electrical Local 71 Outside (North Central Ohio)

Change # : LCN01-2020fbLoc71CentralOhio

Craft : Lineman Effective Date : 11/04/2020 Last Posted : 11/04/2020

	BHR	Fringe Benefit Payments						Irrevocable Fund		Total PWR	Overtime Rate
		H&W	Pension	App Tr.	Vac.	Annuity	Other	LECET (*)	MISC (*)		
Classification											
Electrical Lineman	\$39.23	\$6.50	\$1.18	\$0.39	\$0.00	\$7.06	\$0.06	\$0.00	\$0.00	\$54.42	\$74.04
Traffic Signal & Lighting Journeyman	\$37.73	\$6.50	\$1.13	\$0.38	\$0.00	\$6.79	\$0.06	\$0.00	\$0.00	\$52.59	\$71.45
Equipment Operator	\$34.46	\$6.50	\$1.03	\$0.34	\$0.00	\$6.20	\$0.06	\$0.00	\$0.00	\$48.59	\$65.82
Groundman 0-12 months (W/O CDL)	\$20.90	\$6.50	\$0.63	\$0.21	\$0.00	\$3.76	\$0.06	\$0.00	\$0.00	\$32.06	\$42.51
Groundman 0-12 months (W/CDL) plus	\$22.83	\$6.50	\$0.68	\$0.23	\$0.00	\$4.11	\$0.06	\$0.00	\$0.00	\$34.41	\$45.82
Groundsman greater than 1 Year (W/CDL)	\$24.77	\$6.50	\$0.74	\$0.25	\$0.00	\$4.46	\$0.06	\$0.00	\$0.00	\$36.78	\$49.17
Traffic Signal Apprentices											
1st 1,000 hours	\$22.64	\$6.50	\$0.68	\$0.23	\$0.00	\$4.08	\$0.06	\$0.00	\$0.00	\$34.19	\$45.51
2nd 1,000 hours	\$24.52	\$6.50	\$0.74	\$0.25	\$0.00	\$4.41	\$0.06	\$0.00	\$0.00	\$36.48	\$48.74
3rd 1,000 hours	\$26.41	\$6.50	\$0.79	\$0.26	\$0.00	\$4.75	\$0.06	\$0.00	\$0.00	\$38.77	\$51.98
4th 1,000 hours	\$28.30	\$6.50	\$0.85	\$0.28	\$0.00	\$5.09	\$0.06	\$0.00	\$0.00	\$41.08	\$55.23
5th 1,000 hours	\$30.18	\$6.50	\$0.91	\$0.30	\$0.00	\$5.43	\$0.06	\$0.00	\$0.00	\$43.38	\$58.47
6th 1,000 hours	\$33.96	\$6.50	\$1.02	\$0.34	\$0.00	\$6.11	\$0.06	\$0.00	\$0.00	\$47.99	\$64.97
Apprentice Lineman	Percent										

1st 1,000 Hours	60.00	\$23.54	\$6.50	\$0.71	\$0.24	\$0.00	\$4.24	\$0.06	\$0.00	\$0.00	\$35.29	\$47.06
2nd 1,000 Hours	65.00	\$25.50	\$6.50	\$0.77	\$0.26	\$0.00	\$4.59	\$0.06	\$0.00	\$0.00	\$37.68	\$50.43
3rd 1,000 Hours	70.00	\$27.46	\$6.50	\$0.82	\$0.27	\$0.00	\$4.94	\$0.06	\$0.00	\$0.00	\$40.05	\$53.78
4th 1,000 Hours	75.00	\$29.42	\$6.50	\$0.88	\$0.29	\$0.00	\$5.30	\$0.06	\$0.00	\$0.00	\$42.45	\$57.16
5th 1,000 Hours	80.00	\$31.38	\$6.50	\$0.94	\$0.31	\$0.00	\$5.65	\$0.06	\$0.00	\$0.00	\$44.84	\$60.54
6th 1,000 Hours	85.00	\$33.35	\$6.50	\$1.00	\$0.33	\$0.00	\$6.00	\$0.06	\$0.00	\$0.00	\$47.24	\$63.91
7th 1,000 Hours	90.00	\$35.31	\$6.50	\$1.06	\$0.35	\$0.00	\$6.36	\$0.06	\$0.00	\$0.00	\$49.64	\$67.29

Special Calculation Note : Other is Safety & Education Fund.

Ratio :

1 Journeymen to 1 Apprentice

Jurisdiction (* denotes special jurisdictional note) :

BELMONT, CARROLL, HARRISON, HOLMES, JEFFERSON, MEDINA, PORTAGE, STARK, SUMMIT, WAYNE

Special Jurisdictional Note :

Details :

A groundman when directed shall assist a Journeyman in the performance of his/her work on the ground, including the use of hand tools. A Groundman under no circumstances shall climb poles, towers, ladders, or work from an elevated platform or bucket truck.

No more than three (3) Groundmen shall work alone. Jobs with more than three Groundmen shall be supervised by a Groundcrew Foreman, Journeyman Lineman, Journeyman Traffic Signal Technician or an Equipment Operator.

Scope of Work: installation and maintenance of highway and street lighting, highway and street sign lighting, electronic message boards and traffic control systems, camera systems, traffic signal work, substation and line construction including overhead and underground projects for private and industrial work as in accordance with the IBEW Constitution. This Agreement includes the operation of all tools and equipment necessary for the installation of the above projects.

fiber.

Journeyman Technician I: Must know all aspects of telephone and cable work. This is to include aerial, underground, and manhole work. Must know how to climb and run bucket. Must have all the tools required to perform these tasks. Must be able to be responsible for the safety of the crew at all times. Must also have CDL license and have at least 5 years experience.

Installer/Repairman: Perform tasks of repairing, installing, and testing phone and CATV services.

Technician II: Have at least three years of telephone and CATV experience. Must have the knowledge of underground, aerial, and manhole work. Must be able to climb and operate bucket. Must have CDL. Must have all tools needed to perform these tasks.

Equipment Operator I: Able to operate a digger derrick or bucket truck. Have at least 5 years of experience and must have a valid CDL license.

Equipment Operator II: Able to operate a digger derrick or bucket truck. Have at least 3 years of experience and must have a valid CDL license.

Groundman W/CDL: Must have a valid CDL license and be able to perform tasks such as: climbing poles, pulling downguys, making up material, and getting appropriate tools for the job. Must have at least 5 year's experience.

Groundman: Perform tasks such as: climbing poles, pulling downguys, making up material, and getting appropriate tools for the job. Experience 0-5 years.

Prevailing Wage Rate Skilled Crafts

Name of Union: Elevator Local 45

Change # : LCN01-2012kpLoc45

Craft : Elevator Effective Date : 04/04/2012 Last Posted : 04/04/2012

	BHR		Fringe Benefit Payments					Irrevocable Fund		Total PWR	Overtime Rate	
			H&W	Pension	App Tr.	Vac.	Annuity	Other	LECET (*)			MISC (*)
Classification												
Elevator Mechanic	\$41.92		\$11.03	\$6.96	\$0.55	\$3.35	\$5.00	\$0.00	\$0.00	\$0.00	\$68.81	\$89.77
Helper	\$29.34		\$11.03	\$6.96	\$0.55	\$1.76	\$5.00	\$0.00	\$0.00	\$0.00	\$54.64	\$69.31
0-6 months Probation	50.00	\$20.96	\$11.03	\$6.96	\$0.55	\$1.26	\$5.00	\$0.00	\$0.00	\$0.00	\$45.76	\$56.24
1st year	55.00	\$23.06	\$11.03	\$6.96	\$0.55	\$1.38	\$5.00	\$0.00	\$0.00	\$0.00	\$47.98	\$59.50
2nd year	65.00	\$27.25	\$11.03	\$6.96	\$0.55	\$1.64	\$5.00	\$0.00	\$0.00	\$0.00	\$52.43	\$66.05
3rd year	70.00	\$29.34	\$11.03	\$6.96	\$0.55	\$1.76	\$5.00	\$0.00	\$0.00	\$0.00	\$54.64	\$69.32
4th year	80.00	\$33.54	\$11.03	\$6.96	\$0.55	\$2.01	\$5.00	\$0.00	\$0.00	\$0.00	\$59.09	\$75.85

Special Calculation Note : Vacation moves to 8% of BHR after 5 years

Ratio :
The total number of Helpers & Apprentices employed shall not exceed the number of Mechanics on any one job, except on jobs where (2) teams or more are working, (1) extra Helper or Apprentice may be employed for the first (2) teams and an extra Helper or Apprentice for each additional (3) teams.

Jurisdiction (* denotes special jurisdictional note) :
ASHLAND, CARROLL, COLUMBIANA, COSHOCTON, HARRISON, HOLMES, MAHONING, MEDINA, PORTAGE, RICHLAND, STARK, SUMMIT, TRUMBULL, TUSCARAWAS, WAYNE

Special Jurisdictional Note :

Details :

Vacation 6%/under 5 years based on regular hourly rate for all hours worked. 8%/over 5 years based on regular hourly rate for all hours worked.

Prevailing Wage Rate Skilled Crafts

Name of Union: Glazier Local 1162

Change # : LCN02-2020fbLoc1162

Craft : Glazier Effective Date : 05/14/2020 Last Posted : 05/14/2020

	BHR		Fringe Benefit Payments					Irrevocable Fund		Total PWR	Overtime Rate	
			H&W	Pension	App Tr.	Vac.	Annuity	Other	LECET (*)			MISC (*)
Classification												
Glazier	\$27.02		\$6.78	\$6.64	\$0.35	\$0.00	\$0.00	\$0.00	\$0.00	\$0.00	\$40.79	\$54.30
Apprentice	Percent											
1st 6 months	50.00	\$13.51	\$6.78	\$6.64	\$0.35	\$0.00	\$0.00	\$0.00	\$0.00	\$0.00	\$27.28	\$34.04
2nd 6 months	55.00	\$14.86	\$6.78	\$6.64	\$0.35	\$0.00	\$0.00	\$0.00	\$0.00	\$0.00	\$28.63	\$36.06
3rd 6 months	60.00	\$16.21	\$6.78	\$6.64	\$0.35	\$0.00	\$0.00	\$0.00	\$0.00	\$0.00	\$29.98	\$38.09
4th 6 months	65.00	\$17.56	\$6.78	\$6.64	\$0.35	\$0.00	\$0.00	\$0.00	\$0.00	\$0.00	\$31.33	\$40.11
5th 6 months	70.00	\$18.91	\$6.78	\$6.64	\$0.35	\$0.00	\$0.00	\$0.00	\$0.00	\$0.00	\$32.68	\$42.14
6th 6 months	75.00	\$20.26	\$6.78	\$6.64	\$0.35	\$0.00	\$0.00	\$0.00	\$0.00	\$0.00	\$34.04	\$44.17
7th 6 months	80.00	\$21.62	\$6.78	\$6.64	\$0.35	\$0.00	\$0.00	\$0.00	\$0.00	\$0.00	\$35.39	\$46.19
8th 6 months	90.00	\$24.32	\$6.78	\$6.64	\$0.35	\$0.00	\$0.00	\$0.00	\$0.00	\$0.00	\$38.09	\$50.25

Special Calculation Note :

Ratio :

1 Journeyman to 1 Apprentice
2 Journeyman to 1 Apprentice

Jurisdiction (* denotes special jurisdictional note) :

ASHLAND, CARROLL, COSHOCTON,
HOLMES, MEDINA, PORTAGE, RICHLAND,
STARK, SUMMIT, TUSCARAWAS, WAYNE

Special Jurisdictional Note :

Details :

Add \$1.25 per hour for High Pay which is all work that requires the employee be supported by equipment which hangs or suspends from the roof of a building or structure including all repelling .

Prevailing Wage Rate Skilled Crafts

Name of Union: Ironworker Local 550

Change # : LCR01-2020fbLoc550

Craft : Ironworker Effective Date : 05/01/2020 Last Posted : 03/17/2020

	BHR		Fringe Benefit Payments						Irrevocable Fund		Total PWR	Overtime Rate
			H&W	Pension	App Tr.	Vac.	Annuity	Other	LECET (*)	MISC (*)		
Classification												
Ironworker	\$29.27		\$8.18	\$9.02	\$0.74	\$0.00	\$2.73	\$0.41	\$0.00	\$0.00	\$50.35	\$64.98
Apprentice	Percent											
1st 6 months	60.00	\$17.56	\$8.18	\$9.02	\$0.74	\$0.00	\$2.73	\$0.41	\$0.00	\$0.00	\$38.64	\$47.42
2nd 6 months	65.00	\$19.03	\$8.18	\$9.02	\$0.74	\$0.00	\$2.73	\$0.41	\$0.00	\$0.00	\$40.11	\$49.62
3rd 6 months	70.00	\$20.49	\$8.18	\$9.02	\$0.74	\$0.00	\$2.73	\$0.41	\$0.00	\$0.00	\$41.57	\$51.81
4th 6 months	75.00	\$21.95	\$8.18	\$9.02	\$0.74	\$0.00	\$2.73	\$0.41	\$0.00	\$0.00	\$43.03	\$54.01
5th 6 months	80.00	\$23.42	\$8.18	\$9.02	\$0.74	\$0.00	\$2.73	\$0.41	\$0.00	\$0.00	\$44.50	\$56.20
6th 6 months	85.00	\$24.88	\$8.18	\$9.02	\$0.74	\$0.00	\$2.73	\$0.41	\$0.00	\$0.00	\$45.96	\$58.40
7th 6 months	90.00	\$26.34	\$8.18	\$9.02	\$0.74	\$0.00	\$2.73	\$0.41	\$0.00	\$0.00	\$47.42	\$60.59
8th 6 months	95.00	\$27.81	\$8.18	\$9.02	\$0.74	\$0.00	\$2.73	\$0.41	\$0.00	\$0.00	\$48.89	\$62.79

Special Calculation Note : OTHER IS: JOURNEYMAN UPGRADE AND WELLNESS FUND.

Ratio :

- 4 Journeymen to 1 Apprentice
- 1 Journeymen to 1 Apprentice, spinning of cable for suspension bridge
- 1 Journeymen to 1 Apprentice, ornamental work
- 2 Journeymen to 1 Apprentice, reinforcing work
- 1 Journeymen to 2 Apprentice, roadway

Jurisdiction (* denotes special jurisdictional note) :

- ASHLAND, CARROLL, COLUMBIANA*,
- COSHOCTON, HOLMES*, HURON,
- MAHONING*, MEDINA*, PORTAGE*,
- RICHLAND, STARK, SUMMIT*,
- TUSCARAWAS, WAYNE

Special Jurisdictional Note : The jurisdictional line between Local 17 and Local 550 is determined as follows: All territory North of Old Route 224 line to be within the jurisdiction of Local 17. All territory South of Old Route 224 line is to be the jurisdiction of Local 550, except for everything within the City limits of Barberton which shall be under the jurisdiction of Local

17.

Details :

Prevailing Wage Rate Skilled Crafts

Name of Union: Ironworker Local 550 Glass & Curtain Wall

Change # : LCN01-2017fbLoc550

Craft : Ironworker Effective Date : 07/01/2017 Last Posted : 06/28/2017

	BHR		Fringe Benefit Payments					Irrevocable Fund		Total PWR	Overtime Rate	
			H&W	Pension	App Tr.	Vac.	Annuity	Other	LECET (*)			MISC (*)
Classification												
Ironworker Glass & Curtain Wall	\$22.00		\$7.00	\$7.47	\$0.09	\$0.00	\$0.33	\$0.00	\$0.00	\$0.00	\$36.89	\$47.89
Apprentice	Percent											
1st 6 months	60.00	\$13.20	\$7.00	\$7.47	\$0.09	\$0.00	\$0.33	\$0.00	\$0.00	\$0.00	\$28.09	\$34.69
2nd 6 months	65.00	\$14.30	\$7.00	\$7.47	\$0.09	\$0.00	\$0.33	\$0.00	\$0.00	\$0.00	\$29.19	\$36.34
3rd 6 months	70.00	\$15.40	\$7.00	\$7.47	\$0.09	\$0.00	\$0.33	\$0.00	\$0.00	\$0.00	\$30.29	\$37.99
4th 6 months	75.00	\$16.50	\$7.00	\$7.47	\$0.09	\$0.00	\$0.33	\$0.00	\$0.00	\$0.00	\$31.39	\$39.64
5th 6 months	80.00	\$17.60	\$7.00	\$7.47	\$0.09	\$0.00	\$0.33	\$0.00	\$0.00	\$0.00	\$32.49	\$41.29
6th 6 months	85.00	\$18.70	\$7.00	\$7.47	\$0.09	\$0.00	\$0.33	\$0.00	\$0.00	\$0.00	\$33.59	\$42.94
7th 6 months	90.00	\$19.80	\$7.00	\$7.47	\$0.09	\$0.00	\$0.33	\$0.00	\$0.00	\$0.00	\$34.69	\$44.59
8th 6 months	95.00	\$20.90	\$7.00	\$7.47	\$0.09	\$0.00	\$0.33	\$0.00	\$0.00	\$0.00	\$35.79	\$46.24

Special Calculation Note :

Ratio :

Apprentice to 1 Journeymen

Jurisdiction (* denotes special jurisdictional note) :

ASHLAND, CARROLL, COLUMBIANA*,
 COSHOCTON, HOLMES, HURON*, MAHONING*,
 MEDINA*, PORTAGE*, RICHLAND, STARK,
 SUMMIT*, TUSCARAWAS, WAYNE

Special Jurisdictional Note : The jurisdictional line between Locals 17 and 550 is determined as follows: All territory North of Old Route 224 line is to be within the jurisdiction of Local 17.
All territory South of Old Route 224 line is to be the jurisdiction of Local 550, except for everything within the City limits of Barberton which shall be under the jurisdiction of Local 17.

Details :

Prevailing Wage Rate Skilled Crafts

Name of Union: Labor HewHwy 2

Change # : LCN01-2020fbLaborHewHwy2

Craft : Laborer Group 1 Effective Date : 05/14/2020 Last Posted : 05/14/2020

	BHR		Fringe Benefit Payments					Irrevocable Fund		Total PWR	Overtime Rate	
			H&W	Pension	App Tr.	Vac.	Annuity	Other	LECET (*)			MISC (*)
Classification												
Laborer Group 1	\$33.05		\$7.00	\$3.80	\$0.45	\$0.00	\$0.00	\$0.00	\$0.10	\$0.00	\$44.40	\$60.92
Group 2	\$33.22		\$7.00	\$3.80	\$0.45	\$0.00	\$0.00	\$0.00	\$0.10	\$0.00	\$44.57	\$61.18
Group 3	\$33.55		\$7.00	\$3.80	\$0.45	\$0.00	\$0.00	\$0.00	\$0.10	\$0.00	\$44.90	\$61.67
Group 4	\$34.00		\$7.00	\$3.80	\$0.45	\$0.00	\$0.00	\$0.00	\$0.10	\$0.00	\$45.35	\$62.35
Watch Person	\$25.35		\$7.00	\$3.80	\$0.45	\$0.00	\$0.00	\$0.00	\$0.10	\$0.00	\$36.70	\$49.38
Apprentice	Percent											
0-1000 hrs	60.00	\$19.83	\$7.00	\$3.80	\$0.45	\$0.00	\$0.00	\$0.00	\$0.10	\$0.00	\$31.18	\$41.10
1001-2000 hrs	70.02	\$23.14	\$7.00	\$3.80	\$0.45	\$0.00	\$0.00	\$0.00	\$0.10	\$0.00	\$34.49	\$46.06
2001-3000 hrs	80.00	\$26.44	\$7.00	\$3.80	\$0.45	\$0.00	\$0.00	\$0.00	\$0.10	\$0.00	\$37.79	\$51.01
3001-4000 hrs	90.00	\$29.74	\$7.00	\$3.80	\$0.45	\$0.00	\$0.00	\$0.00	\$0.10	\$0.00	\$41.10	\$55.97
More Than 4000 hrs	100.00	\$33.05	\$7.00	\$3.80	\$0.45	\$0.00	\$0.00	\$0.00	\$0.10	\$0.00	\$44.40	\$60.92

Special Calculation Note : Watchman has no Apprentices. Tunnel Laborer rate with air-pressurized add \$1.00 to the above wage rate.

Ratio :

- 1 Journeymen to 1 Apprentice
- 3 Journeymen to 1 Apprentice thereafter

Jurisdiction (* denotes special jurisdictional note) :

- ASHTABULA, ERIE, HURON, LORAIN,
- LUCAS, MAHONING, MEDINA, OTTAWA,
- PORTAGE, SANDUSKY, STARK, SUMMIT,
- TRUMBULL, WOOD

Special Jurisdictional Note : Hod Carriers and Common Laborers - Heavy, Highway, Sewer, Waterworks, Utility, Airport, Railroad, Industrial and Building Site, Sewer Plant, Waste Water Treatment Facilities Construction

Details :

Group 1

Laborer (Construction); Plant Laborer or Yardman, Right-of-way Laborer, Landscape Laborer, Highway Lighting Worker, Signalization Worker, (Swimming) Pool Construction Laborer, Utility Man, *Bridge Man, Handyman, Joint Setter, Flagperson, Carpenter Helper, Waterproofing Laborer, Slurry Seal, Seal Coating, Surface Treatment or Road Mix Laborer, Riprap Laborer & Grouter, Asphalt Laborer, Dump Man (batch trucks), Guardrail & Fence Installer, Mesh Handler & Placer, Concrete Curing Applicator, Scaffold Erector, Sign Installer, Hazardous Waste (level D), Diver Helper, Zone Person and Traffic Control.

*Bridge Man will perform work as per the October 31, 1949, memorandum on concrete forms, by and between the United Brotherhood of Carpenters and Joiners of America and the Laborers' International Union of North America, which states in; "the moving, cleaning, oiling and carrying to the next point of erection, and the stripping of forms which are not to be re-used, and forms on all flat arch work shall be done by members of the Laborers' International Union of North America."

Group 2

Asphalt Raker, Screwman or Paver, Concrete Puddler, Kettle Man (pipeline), All Machine-Driven Tools (Gas, Electric, Air), Mason Tender, Brick Paver, Mortar Mixer, Skid Steer, Sheeting & Shoring Person, Surface Grinder Person, Screedperson, Water Blast, Hand Held Wand, Power Buggy or Power Wheelbarrow, Paint Striper, Plastic fusing Machine Operator, Rodding Machine Operator, Pug Mill Operator, Operator of All Vacuum Devices Wet or Dry, Handling of all Pumps 4 inches and under (gas, air or electric), Diver, Form Setter, Bottom Person, Welder Helper (pipeline), Concrete Saw Person, Cutting with Burning Torch, Pipe Layer, Hand Spiker (railroad), Underground Person (working in sewer and waterline, cleaning, repairing and reconditioning). Tunnel Laborer (without air), Caisson, Cofferdam (below 25 feet deep), Air Track and Wagon Drill, Sandblaster Nozzle Person, Hazardous Waste (level B), ***Lead Abatement, Hazardous Waste (level C)

***Includes the erecting of structures for the removal, including the encapsulation and containment of Lead abatement process.

Group 3

Blast and Powder Person, Muckers will be defined as shovel men working directly with the miners, Wrencher (mechanical joints & utility pipeline), Yarnier, Top Lander, Hazardous Waste (level A), Concrete Specialist, Curb Setter and Cutter, Grade Checker, Concrete Crew in Tunnels. Utility pipeline Tappers, Waterline, Caulker, Signal Person will receive the rate equal to the rate paid the Laborer classification for which the Laborer is signaling.

Group 4

Miner, Welder, Guniting Nozzle Person

A.) The Watchperson shall be responsible to patrol and maintain a safe traffic zone including but not limited to barrels, cones, signs, arrow boards, message boards etc.
The responsibility of a watchperson is to see that the equipment, job and office trailer etc. are secure.

Prevailing Wage Rate Skilled Crafts

Name of Union: Labor Local 1015 Building

Change # : LCN01-2020fbLoc1015

Craft : Laborer Effective Date : 08/20/2020 Last Posted : 08/20/2020

	BHR		Fringe Benefit Payments					Irrevocable Fund		Total PWR	Overtime Rate
			H&W	Pension	App Tr.	Vac.	Annuity	Other	LECET (*)		
Classification											
Laborer Group 1	\$29.02	\$7.00	\$3.80	\$0.40	\$0.00	\$0.00	\$0.00	\$0.10	\$0.00	\$40.32	\$54.83
Group 2	\$29.42	\$7.00	\$3.80	\$0.40	\$0.00	\$0.00	\$0.00	\$0.10	\$0.00	\$40.72	\$55.43
Group 3	\$29.77	\$7.00	\$3.80	\$0.40	\$0.00	\$0.00	\$0.00	\$0.10	\$0.00	\$41.07	\$55.96
Group 4	\$29.72	\$7.00	\$3.80	\$0.40	\$0.00	\$0.00	\$0.00	\$0.10	\$0.00	\$41.02	\$55.88
Group 5	\$22.06	\$7.00	\$3.80	\$0.40	\$0.00	\$0.00	\$0.00	\$0.10	\$0.00	\$33.36	\$44.39
Apprentice	Percent										
0-1000 hrs	60.00	\$17.41	\$7.00	\$3.80	\$0.40	\$0.00	\$0.00	\$0.10	\$0.00	\$28.71	\$37.42
1001-2000 hrs	70.00	\$20.31	\$7.00	\$3.80	\$0.40	\$0.00	\$0.00	\$0.10	\$0.00	\$31.61	\$41.77
2001-3000 hrs	80.00	\$23.22	\$7.00	\$3.80	\$0.40	\$0.00	\$0.00	\$0.10	\$0.00	\$34.52	\$46.12
3001-4000 hrs	90.00	\$26.12	\$7.00	\$3.80	\$0.40	\$0.00	\$0.00	\$0.10	\$0.00	\$37.42	\$50.48
More than 4000 hrs	100.00	\$29.02	\$7.00	\$3.80	\$0.40	\$0.00	\$0.00	\$0.10	\$0.00	\$40.32	\$54.83

Special Calculation Note : No special calculations for this skilled craft wage rate are required at this time.

Ratio :

1 Journeyman to 1 Apprentice
4 Journeyman to 1 Apprentice

Jurisdiction (* denotes special jurisdictional note) :

CARROLL, STARK, WAYNE

Special Jurisdictional Note :

Details :

Group 1

Building & Construction Laborer, Signalman, Flagman, Tool Cribman, Carpenter Tender, Finisher Tender, Concrete Handler, Utility Construction Laborer, Guard Rail Erectors, Hazardous Waste (Level D)

Group 2

Bottom Man, Scaffold Builder, Tunnel laborer, Pipe Layer, Air and Power Driven Tools, Burner on Demolition Work, Swinging Scaffold, Mucker, Caisson Worker, Cofferdam Worker, Powder Men and Dynamite Blaster, Creosote Worker, Form Setter, Plasterer Tender, Hod Carrier Laser Beam Set-up Man, All confined space work, furnaces, pickel tubs, acid-pits, and Hazardous Waste Level (C)

Group 3

Mason Tender, Mortar Mixer, Stonemason Tender, skid-loader, Hazardous Waste Level (B)

Group 4

Gunnite Operator, Hazardous Waste Level (A)

Group 5

Watchman

Prevailing Wage Rate Skilled Crafts

Name of Union: Operating Engineers - Building Local 18 - Zone III

Change # : LCN01-2020fbLoc18zone3

Craft : Operating Engineer Effective Date : 05/14/2020 Last Posted : 05/14/2020

	BHR		Fringe Benefit Payments					Irrevocable Fund		Total PWR	Overtime Rate	
			H&W	Pension	App Tr.	Vac.	Annuity	Other	LECET (*)			MISC (*)
Classification												
Operator Class 1	\$38.24		\$8.51	\$6.00	\$0.85	\$0.00	\$0.00	\$0.09	\$0.00	\$0.00	\$53.69	\$72.81
Class 2	\$38.12		\$8.51	\$6.00	\$0.85	\$0.00	\$0.00	\$0.09	\$0.00	\$0.00	\$53.57	\$72.63
Class 3	\$37.08		\$8.51	\$6.00	\$0.85	\$0.00	\$0.00	\$0.09	\$0.00	\$0.00	\$52.53	\$71.07
Class 4	\$35.90		\$8.51	\$6.00	\$0.85	\$0.00	\$0.00	\$0.09	\$0.00	\$0.00	\$51.35	\$69.30
Class 5	\$30.44		\$8.51	\$6.00	\$0.85	\$0.00	\$0.00	\$0.09	\$0.00	\$0.00	\$45.89	\$61.11
Class 6	\$38.49		\$8.51	\$6.00	\$0.85	\$0.00	\$0.00	\$0.09	\$0.00	\$0.00	\$53.94	\$73.18
Class 7	\$38.74		\$8.51	\$6.00	\$0.85	\$0.00	\$0.00	\$0.09	\$0.00	\$0.00	\$54.19	\$73.56
Class 8	\$39.24		\$8.51	\$6.00	\$0.85	\$0.00	\$0.00	\$0.09	\$0.00	\$0.00	\$54.69	\$74.31
Class 9	\$39.49		\$8.51	\$6.00	\$0.85	\$0.00	\$0.00	\$0.09	\$0.00	\$0.00	\$54.94	\$74.68
Apprentice	Percent											
1st Year	50.00	\$19.12	\$8.51	\$6.00	\$0.85	\$0.00	\$0.00	\$0.09	\$0.00	\$0.00	\$34.57	\$44.13
2nd Year	60.00	\$22.94	\$8.51	\$6.00	\$0.85	\$0.00	\$0.00	\$0.09	\$0.00	\$0.00	\$38.39	\$49.87
3rd Year	70.00	\$26.77	\$8.51	\$6.00	\$0.85	\$0.00	\$0.00	\$0.09	\$0.00	\$0.00	\$42.22	\$55.60
4th Year	80.00	\$30.59	\$8.51	\$6.00	\$0.85	\$0.00	\$0.00	\$0.09	\$0.00	\$0.00	\$46.04	\$61.34
Field Mechanic Trainee												
1st Year	50.00	\$19.12	\$8.51	\$6.00	\$0.85	\$0.00	\$0.00	\$0.09	\$0.00	\$0.00	\$34.57	\$44.13
2nd Year	60.00	\$22.94	\$8.51	\$6.00	\$0.85	\$0.00	\$0.00	\$0.09	\$0.00	\$0.00	\$38.39	\$49.87
3rd Year	70.00	\$26.77	\$8.51	\$6.00	\$0.85	\$0.00	\$0.00	\$0.09	\$0.00	\$0.00	\$42.22	\$55.60
4th Year	80.00	\$30.59	\$8.51	\$6.00	\$0.85	\$0.00	\$0.00	\$0.09	\$0.00	\$0.00	\$46.04	\$61.34

Special Calculation Note : Other: Education & Safety \$0.09

Ratio :

For every (3) Operating Engineer Journeymen employed by the company there may be employed (1) Registered Apprentice or trainee Engineer through the referral when they are available. An apprentice, while employed as part of a crew per

Jurisdiction (* denotes special jurisdictional note) :

ADAMS, ALLEN, ASHLAND, ATHENS, AUGLAIZE, BELMONT, BROWN, BUTLER, CARROLL, CHAMPAIGN, CLARK, CLERMONT, CLINTON, COSHOCTON, CRAWFORD, DARKE, DEFIANCE,

Article VIII, paragraph 77, will not be subject to the apprenticeship ratios in this collective bargaining agreement

DELAWARE, FAIRFIELD, FAYETTE, FRANKLIN, FULTON, GALLIA, GREENE, GUERNSEY, HAMILTON, HANCOCK, HARDIN, HARRISON, HENRY, HIGHLAND, HOCKING, HOLMES, JACKSON, JEFFERSON, KNOX, LAWRENCE, LICKING, LOGAN, MADISON, MARION, MEIGS, MERCER, MIAMI, MONROE, MONTGOMERY, MORGAN, MORROW, MUSKINGUM, NOBLE, OTTAWA, PAULDING, PERRY, PICKAWAY, PIKE, PREBLE, PUTNAM, RICHLAND, ROSS, SANDUSKY, SCIOTO, SENECA, SHELBY, STARK, TUSCARAWAS, UNION, VAN WERT, VINTON, WARREN, WASHINGTON, WAYNE, WILLIAMS, WYANDOT

Special Jurisdictional Note :

Details :

**Apprentices will receive a 10% increase on top of the percentages listed above provided they are operating mobile equipment. Mechanic Trainees will receive 10% increase if required to have CDL

Class 1 - Barrier Moving Machine; Boiler Operators or Compressor Operators, when compressor or boiler is mounted on crane (Piggyback Operation); Boom Trucks (all types); Cableways Cherry Pickers; Combination - Concrete Mixers & Towers; All Concrete Pumps with Booms; Cranes (all types) Derricks (all types); Draglines Dredges (dipper, clam or suction) 3-man crew; Elevating Graders or Euclid Loaders; Floating Equipment; Gradalls; Helicopter Operators; hoisting building materials; Helicopter Winch Operators, Hoisting building materials; Hoes (All types); Hoists (with two or more drums in use); Hydraulic Gantry (lift system); Laser Finishing Machines; Lift Slab or Panel Jack Operators; Locomotives (all types); Maintenance Engineers (Mechanic and/or Welder); Mixers, paving (multiple drum); Mobile Concrete Pumps, with booms, Panelboards, (all types on site); Pile Drivers; Power Shovels; Prentice Loader; Rail Tamper (with automatic lifting and aligning device); Rotary Drills (all used on caissons for foundations and sub-structure work; Side Booms; Slip Form Pavers; Straddle Carriers (Building Construction on site); Tug Boats. Horizontal Directional Drill, Rough Terrain Fork-lift with Winch/Hoist, Laser Screed, and Like equipment; Compact Cranes, track or rubber over 4,000 pound capacity, self-erecting cranes: stationary, track or truck (all configurations) bucket trench machines (over 24 " wide).

Class 2 - Asphalt Pavers; Bobcat-type and/or skid steer loader with hoe attachment greater than 7000 lbs. Bulldozers; CMI type Equipment; Endloaders; Hydro Milling Machine; Kolman-type Loaders (Dirt Loading); Lead Greasemen; Mucking Machines; Pettibone-Rail Equipment; Power Graders; Power Scoops; Power Scrapers; Push Cats; Vermeer Type Concrete Saw; All rotomills, grinders & planers of all types. Articulating/end dumps (minus \$4.00/hour from Class 2 rate)

Class 3 - A Frames; Air Compressors, Pressurizing Shafts or Tunnels; All Asphalt Rollers; Bobcat-type and/or skid steer loader with or without attachments; Boilers (15 lbs pressure and over); All concrete Pumps (without booms with 5 inch system); Fork Lifts (except masonry); Highway Drillers - all types (with integral power); Hoists (with one drum); House Elevators (except those automatic call button controlled); Man lifts; Mud Jacks; Pressure Grouting; Pump Operators (installing or operating Well

Points or other types of Dewatering Systems); Pumps (4 inches and over discharge); Railroad Tie Inserter/Remover; Rotator (Lime-Soil Stabilizer); Submersible Pumps (4 inches and over discharge); Switch & Tie Tampers (without lifting and aligning device); Trench Machines (24 inches and under); Utility Operators; Material hoist/elevators.

Class 4 - Ballast Re-locator; Backfillers and Tampers; Batch Plant Operators; Bar and Joint Installing Machines; Bull Floats; Burlap and Curing Machines; Clefplanes; Compressors, on building construction; Concrete Spreader; Conveyors, used for handling building materials; Concrete Mixers, one bag capacity (side loader); Concrete Mixers, capacity more than one bag; Crushers; Deck Hands; Drum Fireman (in Asphalt Plant); Farm type tractors pulling attachments; Finishing Machines; Form Trenchers; Generators; Guniting Machines; Hydro-Seeders; Pavement Breakers (hydraulic or cable); Post Drivers; Post Hole Diggers; Pressure Pumps (over 1/2 inch discharge); Road Widening Trenchers; Rollers (except asphalt); All Concrete pumps (without Boom with 4 inch or smaller systems); Self-Propelled Power Spreaders; Concrete Spreaders; Self-Propelled Sub-graders; Shotcrete Machines; Tire Repairmen; Tractors, pulling sheepfoot rollers or graders; VAC/ALLS; Vibratory Compactors, with integral power; Welder Operators.

Class 5 - Boilers (less than 15 lbs. pressure); Inboard/outboard Motor Boat Launches; Light Plant Operators; Masonry Fork Lifts; Oilers/Helpers; Power Driven Heaters (oil fired); Power Scrubbers; Power Sweepers; Pumps (under 4 inch discharge); Signalmen, Submersible Pumps (under 4 inch discharge). Directional Drill Locator and Allen Screed Concrete Paver. Fueling and greasing (Primary Operator with Specialized CDL Endorsement Add \$3.00/ hour), compact cranes; track or rubber under 4,000 pounds.

Class 6 - Master Mechanic

Class 7 - Boom & Jib 150 - 180 feet

Class 8 - Boom & Jib 180 - 249 feet

Class 9 - Boom & Jib 250 - or over

Prevailing Wage Rate Skilled Crafts

Name of Union: Operating Engineers - HevHwy Zone II

Change # : LCN01-2020fbLoc18hevhwyl

Craft : Operating Engineer Effective Date : 05/14/2020 Last Posted : 05/14/2020

	BHR		Fringe Benefit Payments					Irrevocable Fund		Total PWR	Overtime Rate	
			H&W	Pension	App Tr.	Vac.	Annuity	Other	LECET (*)			MISC (*)
Classification												
Operator Class 1	\$38.24	\$8.51	\$6.00	\$0.85	\$0.00	\$0.00	\$0.09	\$0.00	\$0.00	\$53.69	\$72.81	
Class 2	\$38.12	\$8.51	\$6.00	\$0.85	\$0.00	\$0.00	\$0.09	\$0.00	\$0.00	\$53.57	\$72.63	
Class 3	\$37.08	\$8.51	\$6.00	\$0.85	\$0.00	\$0.00	\$0.09	\$0.00	\$0.00	\$52.53	\$71.07	
Class 4	\$35.90	\$8.51	\$6.00	\$0.85	\$0.00	\$0.00	\$0.09	\$0.00	\$0.00	\$51.35	\$69.30	
Class 5	\$30.44	\$8.51	\$6.00	\$0.85	\$0.00	\$0.00	\$0.09	\$0.00	\$0.00	\$45.89	\$61.11	
Class 6	\$38.49	\$8.51	\$6.00	\$0.85	\$0.00	\$0.00	\$0.09	\$0.00	\$0.00	\$53.94	\$73.18	
Apprentice	Percent											
1st Year	50.00	\$19.12	\$8.51	\$6.00	\$0.85	\$0.00	\$0.00	\$0.09	\$0.00	\$0.00	\$34.57	\$44.13
2nd Year	60.00	\$22.94	\$8.51	\$6.00	\$0.85	\$0.00	\$0.00	\$0.09	\$0.00	\$0.00	\$38.39	\$49.87
3rd Year	70.00	\$26.77	\$8.51	\$6.00	\$0.85	\$0.00	\$0.00	\$0.09	\$0.00	\$0.00	\$42.22	\$55.60
4th Year	80.00	\$30.59	\$8.51	\$6.00	\$0.85	\$0.00	\$0.00	\$0.09	\$0.00	\$0.00	\$46.04	\$61.34
Field Mech Trainee Class 2												
1st year	49.85	\$19.06	\$8.51	\$6.00	\$0.85	\$0.00	\$0.00	\$0.09	\$0.00	\$0.00	\$34.51	\$44.04
2nd year	59.80	\$22.87	\$8.51	\$6.00	\$0.85	\$0.00	\$0.00	\$0.09	\$0.00	\$0.00	\$38.32	\$49.75
3rd year	69.77	\$26.68	\$8.51	\$6.00	\$0.85	\$0.00	\$0.00	\$0.09	\$0.00	\$0.00	\$42.13	\$55.47
4th year	79.75	\$30.50	\$8.51	\$6.00	\$0.85	\$0.00	\$0.00	\$0.09	\$0.00	\$0.00	\$45.95	\$61.19

Special Calculation Note : Other: Education & Safety Fund is \$0.09 per hour.

Ratio :

For every (3) Operating Engineer Journeymen employed by the company , there may be employed (1) Registered Apprentice or Trainee Engineer through the referral when they are available. An apprentice, while employed as part of a crew per Article VIII paragraph 65, will not be subject the apprenticeship ratios in this collective bargaining agreement.

Jurisdiction (* denotes special jurisdictional note) :

ADAMS, ALLEN, ASHLAND, ATHENS, AUGLAIZE, BELMONT, BROWN, BUTLER, CARROLL, CHAMPAIGN, CLARK, CLERMONT, CLINTON, COSHOCTON, CRAWFORD, DARKE, DEFIANCE, DELAWARE, FAIRFIELD, FAYETTE, FRANKLIN, FULTON, GALLIA, GREENE, GUERNSEY, HAMILTON, HANCOCK, HARDIN, HARRISON, HENRY, HIGHLAND, HOCKING,

HOLMES, HURON, JACKSON, JEFFERSON,
 KNOX, LAWRENCE, LICKING, LOGAN,
 LUCAS, MADISON, MARION, MEIGS,
 MERCER, MIAMI, MONROE, MONTGOMERY,
 MORGAN, MORROW, MUSKINGUM, NOBLE,
 OTTAWA, PAULDING, PERRY, PICKAWAY,
 PIKE, PREBLE, PUTNAM, RICHLAND, ROSS,
 SANDUSKY, SCIOTO, SENECA, SHELBY,
 STARK, TUSCARAWAS, UNION, VAN WERT,
 VINTON, WARREN, WASHINGTON, WAYNE,
 WILLIAMS, WOOD, WYANDOT

Special Jurisdictional Note :

Details :

**Apprentices will receive a 10% increase on top of the percentages listed above provided they are operating mobile equipment. Mechanic Trainees will receive 10% increase if they are required to have CDL.

Class 1 - Air Compressors on Steel Erection; Barrier Moving Machine; Boiler Operators, on Compressors or Generators, when mounted on a rig: Cableways, Combination Concrete mixers & Towers; Concrete Pumps; Concrete Plants (over 4 yd capacity); Cranes (all types, including Boom Trucks, Cherry Pickers); Derricks; Draglines, Dredgers (dipper, clam or suction); Elevating Graders or Euclid Loaders; Floating Equipment (all types); Gradalls, Helicopter Crew (Operator- hoist or winch); Hoes (all types); Hoisting Engines, on shaft or tunnel work; Hydraulic Gantry (lifting system); Industrial - Type Tractors; Jet Engine Dryers (D8 or D9), Diesel Tractors; Locomotives (standard gage); Maintenance Operators (class A); Mixers, paving (single or double drum); Mucking Machines; Multiple Scrapers; Piledriving Machines (all types); Power Shovels, Prentice Loader; Quad 9 (double pusher); Rail Tamper (with automatic lifting and aligning device); Refrigerating Machines (freezer operation); Side Booms; Slip Form Pavers; Tower Dericks; Tree Shredders; Truck Mounted Concrete Pumps; Tug Boats; Tunnel Machines and /or Mining Machines; Wheel Excavators. Rough Terrain Fork-lift with Winch/Hoist; Compact Cranes, track rubber over 4,000 pound capacity, self-erecting cranes; stationary, track or truck (all configurations) Bucket trench machines (over 24 inches wide).

Class 2 - Asphalt Pavers; Automatic Subgrade Machines, self-propelled (CMI-type); Bobcat-type and /or skid steer loader with hoe attachment greater than 7000 lbs.; Boring Machine Operators (more than 48 inches); Bulldozers; Endloaders; Hydro Milling Machine; Kolman-type Loaders (production type-dirt); Lead Greasemen; Maintenance Operators, Class B (Portage and Summit Counties only); Pettibone-Rail Equipment; Power Graders; Power Scrapers; Push Cats; Lighting and Traffic Signal Installation Equipment includes all groups or classifications; Trench Machines (24inch wide and under); Vermeer Type Concrete saw. Material Transfer Equipment (Shuttle buggy) Asphalt; All rotomills,grinders and planers of all types. Horizontal Directional Drill (Over 50,000 ft.lbs.thrust and over)

Class 3 - A-Frames; Air Compressors, on tunnel work (low Pressure); Asphalt Plant Engineers; Bobcat-type and/or skid steer loader with or without attachments; Power Boilers (15 lbs pressure and over); Highway Drills (all types); Rollers, asphalt; Pump Operators (installing or operating well Points); Pumps (4 inch and over discharge); Railroad Tie Inserter/Remover; Rotator (lime-soil Stabilizer), Switch & Tie Tampers (without lifting and aligning device); Locomotives (narrow gage); Mixers, concrete (more than one bag capacity); Mixers, one bag capacity (side loader); Utilities Operators, (small equipment);

Welding Machines; Material hoist/elevators. Articulating/straight bed end dumps if assigned (minus \$4.00 per hour).

Class 4 -Ballast Re-locator; Backfillers, Batch Plants; Bar and Joint Installing Machines; Boring Machine Operators (48 inch or less); Bull Floats; Burlap and Curing Machines; Concrete Plants (capacity 4 yd and under); Conveyors (highway); Concrete Saws (multiple); Crushers; Deckhands; Farm type tractors, with attachments (highway), except masonry; Finishing Machines; Firemen, Floating Equipment (all types); Fork Lifts (highway); Form Trenchers; Hydro Hammers; Hydro Seeders; Pavement Breakers; Plant Mixers; Post Drivers; Post Hole Diggers (power auger); Power Brush Burners; Power Form Handling Equipment; Road Widening Trenchers; Rollers (brick, grade, macadam); Self-Propelled Power Spreaders; Self-Propelled Sub-Graders; Tractors, pulling sheepsfoot rollers or graders; Steam Firemen; Vibratory Compactors, with integral power.

Class 5 - Compressors (portable, Sewer, Heavy and Highway); Generators; Inboard-Outboard Motor Boat Launches; Masonry Fork Lifts; Oilers/Helpers; Power Driven Heaters; Power Scrubbers; Power Sweepers; Pumps (under 4 inch discharge); Signalmen; Drum Fireman (in Asphalt Plant); Oil Heaters (Asphalt Plant); Tire Repairmen; VAC/ALLS; Fueling and greasing (Primary Operator with Specialized CDL Endorsement Add \$3.00/ hour), compact cranes: track or rubber under 4,000 pounds.

Class 6 - Master Mechanic

Prevailing Wage Rate Skilled Crafts

Name of Union: Painter Local 841 Zone II

Change # : LCN01-2019fbLoc603Com.

Craft : Painter Effective Date : 10/09/2019 Last Posted : 10/09/2019

	BHR		Fringe Benefit Payments					Irrevocable Fund		Total PWR	Overtime Rate	
			H&W	Pension	App Tr.	Vac.	Annuity	Other	LECET (*)			MISC (*)
Classification												
Painter Brush Roll	\$24.70		\$6.66	\$7.17	\$0.35	\$0.00	\$0.00	\$0.00	\$0.00	\$0.00	\$38.88	\$51.23
Paperhanger	\$24.70		\$6.66	\$7.17	\$0.35	\$0.00	\$0.00	\$0.00	\$0.00	\$0.00	\$38.88	\$51.23
Spray Gun Operator of Any & All Coatings	\$25.55		\$6.66	\$7.17	\$0.35	\$0.00	\$0.00	\$0.00	\$0.00	\$0.00	\$39.73	\$52.51
Swing Scaffold, Bosum Chair & Window Jack	\$25.45		\$6.66	\$7.17	\$0.35	\$0.00	\$0.00	\$0.00	\$0.00	\$0.00	\$39.63	\$52.35
Sandblast, Painting of Standpipes, Etc. from Scaffolds, Open Structural Steel, Standpipes & Water Towers	\$25.95		\$6.66	\$7.17	\$0.35	\$0.00	\$0.00	\$0.00	\$0.00	\$0.00	\$40.13	\$53.10
Epoxy Applications	\$25.35		\$6.66	\$7.17	\$0.35	\$0.00	\$0.00	\$0.00	\$0.00	\$0.00	\$39.53	\$52.21
Synthetic Applications	\$25.95		\$6.66	\$7.17	\$0.35	\$0.00	\$0.00	\$0.00	\$0.00	\$0.00	\$40.13	\$53.10
Lead Abatement	\$25.95		\$6.66	\$7.17	\$0.35	\$0.00	\$0.00	\$0.00	\$0.00	\$0.00	\$40.13	\$53.10
Asbestos Removal	\$25.95		\$6.66	\$7.17	\$0.35	\$0.00	\$0.00	\$0.00	\$0.00	\$0.00	\$40.13	\$53.10
Apprentice	Percent											
1st 6 months	50.00	\$12.35	\$6.66	\$7.17	\$0.35	\$0.00	\$0.00	\$0.00	\$0.00	\$0.00	\$26.53	\$32.71

2nd 6 months	55.00	\$13.59	\$6.66	\$7.17	\$0.35	\$0.00	\$0.00	\$0.00	\$0.00	\$0.00	\$27.76	\$34.56
3rd 6 months	60.00	\$14.82	\$6.66	\$7.17	\$0.35	\$0.00	\$0.00	\$0.00	\$0.00	\$0.00	\$29.00	\$36.41
4th 6 months	65.00	\$16.05	\$6.66	\$7.17	\$0.35	\$0.00	\$0.00	\$0.00	\$0.00	\$0.00	\$30.23	\$38.26
5th 6 months	70.00	\$17.29	\$6.66	\$7.17	\$0.35	\$0.00	\$0.00	\$0.00	\$0.00	\$0.00	\$31.47	\$40.12
6th 6 months	75.00	\$18.52	\$6.66	\$7.17	\$0.35	\$0.00	\$0.00	\$0.00	\$0.00	\$0.00	\$32.71	\$41.97
7th 6 months	80.00	\$19.76	\$6.66	\$7.17	\$0.35	\$0.00	\$0.00	\$0.00	\$0.00	\$0.00	\$33.94	\$43.82
8th 6 months	90.00	\$22.23	\$6.66	\$7.17	\$0.35	\$0.00	\$0.00	\$0.00	\$0.00	\$0.00	\$36.41	\$47.53

Special Calculation Note : Apprentice pay based on percentage of above appropriate classification.

Ratio :

3 Journeymen to 1 Apprentice

Jurisdiction (* denotes special jurisdictional note) :

CARROLL, COSHOCTON, HOLMES, STARK, TUSCARAWAS, WAYNE

Special Jurisdictional Note :

Details :

Commercial and industrial work, performed outside the regular work day, the rate of pay shall be \$2.00 per hour above the applicable wage scale. This rate of pay is only applicable for eight – (8) hours. Additional hours shall be paid at the rate of time and one – half.

Prevailing Wage Rate Skilled Crafts

Name of Union: Painter Local 841 Zone II

Change # : LCN01-2019fbLoc603Com.

Craft : Drywall Finisher Effective Date : 10/09/2019 Last Posted : 10/09/2019

	BHR		Fringe Benefit Payments					Irrevocable Fund		Total PWR	Overtime Rate	
			H&W	Pension	App Tr.	Vac.	Annuity	Other	LECET (*)			MISC (*)
Classification												
Painter Drywall Finisher	\$25.95		\$6.66	\$7.17	\$0.35	\$0.00	\$0.00	\$0.00	\$0.00	\$0.00	\$40.13	\$53.10
Drywall Taping	\$25.95		\$6.66	\$7.17	\$0.35	\$0.00	\$0.00	\$0.00	\$0.00	\$0.00	\$40.13	\$53.10
Drywall Finisher W/Machines	\$25.95		\$6.66	\$7.17	\$0.35	\$0.00	\$0.00	\$0.00	\$0.00	\$0.00	\$40.13	\$53.10
Apprentice	Percent											
1st 6 months	50.00	\$12.98	\$6.66	\$7.17	\$0.35	\$0.00	\$0.00	\$0.00	\$0.00	\$0.00	\$27.16	\$33.64
2nd 6 months	55.00	\$14.27	\$6.66	\$7.17	\$0.35	\$0.00	\$0.00	\$0.00	\$0.00	\$0.00	\$28.45	\$35.59
3rd 6 months	60.00	\$15.57	\$6.66	\$7.17	\$0.35	\$0.00	\$0.00	\$0.00	\$0.00	\$0.00	\$29.75	\$37.53
4rd 6 months	70.00	\$18.16	\$6.66	\$7.17	\$0.35	\$0.00	\$0.00	\$0.00	\$0.00	\$0.00	\$32.35	\$41.43
5th 6 months	80.00	\$20.76	\$6.66	\$7.17	\$0.35	\$0.00	\$0.00	\$0.00	\$0.00	\$0.00	\$34.94	\$45.32
6th 6 months	90.00	\$23.35	\$6.66	\$7.17	\$0.35	\$0.00	\$0.00	\$0.00	\$0.00	\$0.00	\$37.54	\$49.21

Special Calculation Note : Apprentice pay based on percentage of above appropriate classification.

Ratio :

3 Journeymen to 1 Apprentice

Jurisdiction (* denotes special jurisdictional note) :

CARROLL, COSHOCTON, HOLMES, STARK, TUSCARAWAS, WAYNE

Special Jurisdictional Note :

Details :

Commercial and industrial work, performed outside the regular work day, the rate of pay shall be \$2.00

per hour above the applicable wage scale. This rate of pay is only applicable for eight – (8) hours. Additional hours shall be paid at the rate of time and one – half.

Prevailing Wage Rate Skilled Crafts

Name of Union: Painter Local 841 Zone II Industrial

Change # : LCN01-2017fbLoc841

Craft : Painter Effective Date : 11/08/2017 Last Posted : 11/08/2017

Classification	BHR		Fringe Benefit Payments					Irrevocable Fund		Total PWR	Overtime Rate	
			H&W	Pension	App Tr.	Vac.	Annuity	Other	LECET (*)			MISC (*)
Painter Brush and Roll	\$22.07		\$6.16	\$6.37	\$0.35	\$0.00	\$0.00	\$0.00	\$0.00	\$0.00	\$34.95	\$45.99
Painter Spray Painter	\$22.60		\$6.16	\$6.37	\$0.35	\$0.00	\$0.00	\$0.00	\$0.00	\$0.00	\$35.48	\$46.78
Tank Interior & Exterior	\$22.60		\$6.16	\$6.37	\$0.35	\$0.00	\$0.00	\$0.00	\$0.00	\$0.00	\$35.48	\$46.78
Sandblasting Steel, Structural Steel & Metallizing	\$22.78		\$6.16	\$6.37	\$0.35	\$0.00	\$0.00	\$0.00	\$0.00	\$0.00	\$35.66	\$47.05
Epoxy Application Class 3	\$22.57		\$6.16	\$6.37	\$0.35	\$0.00	\$0.00	\$0.00	\$0.00	\$0.00	\$35.45	\$46.74
Epoxy Application Class 4	\$23.07		\$6.16	\$6.37	\$0.35	\$0.00	\$0.00	\$0.00	\$0.00	\$0.00	\$35.95	\$47.49
Bridges, Towers, Poles & Stacks	\$22.78		\$6.16	\$6.37	\$0.35	\$0.00	\$0.00	\$0.00	\$0.00	\$0.00	\$35.66	\$47.05
Apprentice	Percent											
1st 6 Months	50.00	\$11.04	\$6.16	\$6.37	\$0.35	\$0.00	\$0.00	\$0.00	\$0.00	\$0.00	\$23.92	\$29.43
2nd 6 Months	55.00	\$12.14	\$6.16	\$6.37	\$0.35	\$0.00	\$0.00	\$0.00	\$0.00	\$0.00	\$25.02	\$31.09
3rd 6 Months	60.00	\$13.24	\$6.16	\$6.37	\$0.35	\$0.00	\$0.00	\$0.00	\$0.00	\$0.00	\$26.12	\$32.74
4th 6 Months	65.00	\$14.35	\$6.16	\$6.37	\$0.35	\$0.00	\$0.00	\$0.00	\$0.00	\$0.00	\$27.23	\$34.40
5th 6 Months	70.00	\$15.45	\$6.16	\$6.37	\$0.35	\$0.00	\$0.00	\$0.00	\$0.00	\$0.00	\$28.33	\$36.05
6th 6 Months	75.00	\$16.55	\$6.16	\$6.37	\$0.35	\$0.00	\$0.00	\$0.00	\$0.00	\$0.00	\$29.43	\$37.71
7th 6 Months	80.00	\$17.66	\$6.16	\$6.37	\$0.35	\$0.00	\$0.00	\$0.00	\$0.00	\$0.00	\$30.54	\$39.36

8th 6 Months	90.00	\$19.86	\$6.16	\$6.37	\$0.35	\$0.00	\$0.00	\$0.00	\$0.00	\$0.00	\$32.74	\$42.67

Special Calculation Note : Apprentice pay based on percentage of above classification.

Ratio :
3 Journeymen to 1 Apprentice

Jurisdiction (* denotes special jurisdictional note) :
CARROLL, COSHOCTON, HOLMES, STARK,
TUSCARAWAS, WAYNE

Special Jurisdictional Note :

Details :

Commercial and industrial work, performed outside the regular work day, the rate of pay shall be \$2.00 per hour above the applicable wage scale. This rate of pay is only applicable for eight - (8) hours. Additional hours shall be paid at the rate of time and one - half.

Prevailing Wage Rate Skilled Crafts

Name of Union: Painter Local 639

Change # : LCNO1-2015fbLoc639

Craft : Painter Effective Date : 06/10/2015 Last Posted : 06/10/2015

	BHR	Fringe Benefit Payments						Irrevocable Fund		Total PWR	Overtime Rate
		H&W	Pension	App Tr.	Vac.	Annuity	Other	LECET (*)	MISC (*)		
Classification											
Painter Metal Polisher											
Top Helper Class A	\$19.09	\$3.65	\$0.00	\$0.00	\$0.66	\$0.00	\$0.00	\$0.00	\$0.00	\$23.40	\$32.94
Top Helper Class B	\$19.09	\$3.65	\$0.65	\$0.00	\$1.03	\$0.00	\$0.37	\$0.00	\$0.00	\$24.79	\$34.33
Top Helper Class C	\$19.09	\$3.65	\$1.00	\$0.00	\$1.76	\$0.00	\$0.37	\$0.00	\$0.00	\$25.87	\$35.41
Helper Class A	\$14.69	\$3.65	\$0.00	\$0.00	\$0.51	\$0.00	\$0.00	\$0.00	\$0.00	\$18.85	\$26.19
Helper Class B	\$14.69	\$3.65	\$0.65	\$0.00	\$0.79	\$0.00	\$0.28	\$0.00	\$0.00	\$20.06	\$27.40
Helper Class C	\$14.69	\$3.65	\$1.00	\$0.00	\$1.64	\$0.00	\$0.28	\$0.00	\$0.00	\$21.26	\$28.60
New Hire 90 Days	\$11.00	\$3.65	\$0.00	\$0.00	\$0.00	\$0.00	\$0.00	\$0.00	\$0.00	\$14.65	\$20.15

Special Calculation Note : Other is Sick and Personal Time

Ratio :

Jurisdiction (* denotes special jurisdictional note) :
 ADAMS, ALLEN, ASHLAND, ASHTABULA, ATHENS, AUGLAIZE, BELMONT, BROWN, BUTLER, CARROLL, CHAMPAIGN, CLARK, CLERMONT, CLINTON, COLUMBIANA, COSHOCTON, CRAWFORD, CUYAHOGA, DARKE, DEFIANCE, DELAWARE, ERIE, FAIRFIELD, FAYETTE, FRANKLIN, FULTON, GALLIA, GEAUGA, GREENE, GUERNSEY, HAMILTON, HANCOCK, HARDIN, HARRISON, HENRY, HIGHLAND, HOCKING, HOLMES, HURON, JACKSON, JEFFERSON, KNOX, LAKE, LAWRENCE, LICKING, LOGAN, LORAIN, LUCAS, MADISON, MAHONING, MARION, MEDINA, MEIGS, MERCER, MIAMI, MONROE, MONTGOMERY, MORGAN, MORROW, MUSKINGUM, NOBLE, OTTAWA, PAULDING, PERRY, PICKAWAY, PIKE, PORTAGE, PREBLE, PUTNAM, RICHLAND, ROSS, SANDUSKY, SCIOTO, SENECA, SHELBY, STARK, SUMMIT, TRUMBULL, TUSCARAWAS, UNION,

VAN WERT, VINTON, WARREN, WASHINGTON,
WAYNE, WILLIAMS, WOOD, WYANDOT

Special Jurisdictional Note :

Details :

Top Helper: Shall perform the responsibilities of a Helper and be responsible for the setup, break down, safety and quality of the company's product.

Helper : Shall be responsible for performing tasks in refinishing, compliance with safety procedures, setting up and breaking down job sites, scaffolding and swing stages and preparing surfaces for refinishing including but not limited to, masking and stripping and cleaning, oxidizing, polishing and scratch removal on various surfaces

Class A Workers: Less than 1 Year of Service.

Class B Workers: More than 1 and less than 8 Years of Service.

Class C Workers: More than 8 Years of Service.

Metal Polisher Scope of Work: Polishing, buffing, stripping, coloring, lacquering, spraying, cleaning and maintenance of ornamental and architectural metals, iron, bronze, nickel, aluminum and stainless steel and in mental specialty work, various stone finishes, stone specialty work and any other work pertaining to the finishing of metal, stones, woods, and any window washing/cleaning done in conjunction with this work, using chemicals, solvents, coatings and hand applied lacquer thinner, removing scratches from mirror finished metals, burnishing of bronze, statuary finishes on exterior and interior surfaces and the use of all tools required to perform such work, including but not limited to polishes, spray equipment and scaffolding.

Swing State Rate: All work on scaffold 4 sections or higher, including any boom lifts and swing stage scaffolds including the rigging and derigging of hanging/suspended swing stage systems and rappelling/bolson chair work, ADD \$1.50 per hour.

Prevailing Wage Rate Skilled Crafts

Name of Union: Painter Local 639 (A) Sign

Change # : CN01-2009Loc639A

Craft : Painter Effective Date : 03/06/2009 Last Posted : 03/06/2009

	BHR		Fringe Benefit Payments					Irrevocable Fund		Total PWR	Overtime Rate	
			H&W	Pension	App Tr.	Vac.	Annuity	Other	LECET (*)			MISC (*)
Classification												
Painter Sign Erector	\$19.98		\$4.46	\$1.00	\$0.25	\$1.68	\$0.00	\$0.00			\$27.37	\$37.36
Serviceman	\$19.98		\$4.46	\$1.00	\$0.25	\$1.68	\$0.00	\$0.00			\$27.37	\$37.36
Metal Sign Fabricator	\$19.98		\$4.46	\$1.00	\$0.25	\$1.68	\$0.00	\$0.00			\$27.37	\$37.36
Neon Bender Pattern Maker	\$19.98		\$4.46	\$1.00	\$0.25	\$1.68	\$0.00	\$0.00			\$27.37	\$37.36
Computer Operator	\$18.98		\$4.46	\$1.00	\$0.25	\$1.61	\$0.00	\$0.00			\$26.30	\$35.79
Router	\$18.98		\$4.46	\$1.00	\$0.25	\$1.61	\$0.00	\$0.00			\$26.30	\$35.79
Plastic Wood Fabricator	\$18.98		\$4.46	\$1.00	\$0.25	\$1.61	\$0.00	\$0.00			\$26.30	\$35.79
Vinyl Applicator	\$18.98		\$4.46	\$1.00	\$0.25	\$1.61	\$0.00	\$0.00			\$26.30	\$35.79
Apprentice For Sign Service, Metal, Neon, Pattern	Percent											
1000 hrs	50.00	\$9.99	\$4.46	\$1.00	\$0.25	\$1.03	\$0.00	\$0.00			\$16.73	\$21.73
2000 hrs	55.00	\$10.99	\$4.46	\$1.00	\$0.25	\$0.37	\$0.00	\$0.00			\$17.07	\$22.56
3000 hrs	60.00	\$11.99	\$4.46	\$1.00	\$0.25	\$0.37	\$0.00	\$0.00			\$18.07	\$24.06
4000 hrs	65.00	\$12.99	\$4.46	\$1.00	\$0.25	\$0.37	\$0.00	\$0.00			\$19.07	\$25.56
5000 hrs	70.00	\$13.99	\$4.46	\$1.00	\$0.25	\$0.37	\$0.00	\$0.00			\$20.07	\$27.06
6000 hrs	85.00	\$16.98	\$4.46	\$1.00	\$0.25	\$0.37	\$0.00	\$0.00			\$23.06	\$31.55
7000 hrs	90.00	\$17.98	\$4.46	\$1.00	\$0.25	\$0.37	\$0.00	\$0.00			\$24.06	\$33.05

Special Calculation Note : Apprentices Rates For: Computer Operator, Router, Plastic-Wood Fabricator Vinyl Application

- 1000 hrs 50% plus (\$4.46 h&w)+(\$1.00 pension)+(\$0.25 apprentice training) + vacation \$0.99
- 2000 hrs 55% plus (\$4.46 h&w)+(\$1.00 pension)+(\$0.25 apprentice training) + vacation \$0.37
- 3000 hrs 65% plus (\$4.46 h&w)+(\$1.00 pension)+(\$0.25 apprentice training) + vacation \$0.37

4000 hrs 50% plus (\$4.46 h&w)+(\$1.00 pension)+(\$0.25 apprentice training) + vacation \$0.37
5000 hrs 70% plus (\$4.46 h&w)+(\$1.00 pension)+(\$0.25 apprentice training) + vacation \$0.37
6000 hrs 85% plus (\$4.46 h&w)+(\$1.00 pension)+(\$0.25 apprentice training) + vacation \$0.37
7000 hrs 90% plus (\$4.46 h&w)+(\$1.00 pension)+(\$0.25 apprentice training) + vacation \$0.37

Ratio :

Jurisdiction (* denotes special jurisdictional note) :

ASHLAND, ASHTABULA, CUYAHOGA, ERIE, GEAUGA, LAKE, LORAIN, MEDINA, PORTAGE, RICHLAND, STARK, SUMMIT

Special Jurisdictional Note :

Details :

Sign and display work shall include but not limited: to the making and installation of all signs and servicing of the same, lettering and pictorial work of any kind, including vinyl signs and vinyl substrates and the preparing for the finishing of same, be it by hand, brush, roller, spray, mechanical or computer aided and by any other method or process pertaining to same: they shall have control of all branches, methods and processes of screen process work: tube bending and display work such as creating, building and finishing of all display matter and its related operations used for advertising purposes, including all lettering whether it be done by hand, mechanical or computer aided or by any other method or process pertaining to same: the construction, erection and maintenance of all billboards and all communication advertising.

Prevailing Wage Rate Skilled Crafts

Name of Union: Painter Local 639 Zone 2 Sign

Change # : LCN01-2016fbLoc639

Craft : Painter Effective Date : 08/03/2016 Last Posted : 08/03/2016

Classification	BHR	Fringe Benefit Payments						Irrevocable Fund		Total PWR	Overtime Rate
		H&W	Pension	App Tr.	Vac.	Annuity	Other	LECET (*)	MISC (*)		
Painter Sign Journeyman Tech/Team Leader Class A	\$21.25	\$1.33	\$0.14	\$0.00	\$0.00	\$0.00	\$0.57	\$0.00	\$0.00	\$23.29	\$33.92
Painter Sign Journeyman Tech/Team Leader Class B	\$21.25	\$1.33	\$0.14	\$0.00	\$0.41	\$0.00	\$0.57	\$0.00	\$0.00	\$23.70	\$34.32
Painter Sign Journeyman Tech/Team Leader Class C	\$21.25	\$1.33	\$0.14	\$0.00	\$0.82	\$0.00	\$0.57	\$0.00	\$0.00	\$24.11	\$34.74
Painter Sign Journeyman Tech/Team Leader Class D	\$21.25	\$1.33	\$0.14	\$0.00	\$1.23	\$0.00	\$0.57	\$0.00	\$0.00	\$24.52	\$35.14
Sign Journeyman Class A	\$20.98	\$1.33	\$0.14	\$0.00	\$0.00	\$0.00	\$0.56	\$0.00	\$0.00	\$23.01	\$33.50
Sign Journeyman Class B	\$20.98	\$1.33	\$0.14	\$0.00	\$0.40	\$0.00	\$0.56	\$0.00	\$0.00	\$23.41	\$33.90
Sign Journeyman Class C	\$20.98	\$1.33	\$0.14	\$0.00	\$0.81	\$0.00	\$0.56	\$0.00	\$0.00	\$23.82	\$34.31
Sign Journeyman Class D	\$20.98	\$1.33	\$0.14	\$0.00	\$1.21	\$0.00	\$0.56	\$0.00	\$0.00	\$24.22	\$34.71
Tech Sign Fabrication/Erector Class A	\$15.90	\$1.33	\$0.14	\$0.00	\$0.00	\$0.00	\$0.43	\$0.00	\$0.00	\$17.80	\$25.75
Tech Sign Fabrication/Erector Class B	\$15.90	\$1.33	\$0.14	\$0.00	\$0.31	\$0.00	\$0.43	\$0.00	\$0.00	\$18.11	\$26.06
Tech Sign Fabrication/Erector Class C	\$15.90	\$1.33	\$0.14	\$0.00	\$0.61	\$0.00	\$0.43	\$0.00	\$0.00	\$18.41	\$26.36
Tech Sign Fabrication/Erector	\$15.90	\$1.33	\$0.14	\$0.00	\$0.92	\$0.00	\$0.43	\$0.00	\$0.00	\$18.72	\$26.67

MERCER, MONROE, MORROW, NOBLE,
OTTAWA, PAULDING, PIKE, PORTAGE,
PUTNAM, RICHLAND, SANDUSKY, SENECA,
SHELBY, STARK, SUMMIT, TRUMBULL,
TUSCARAWAS, VAN WERT, WASHINGTON,
WAYNE, WILLIAMS, WOOD, WYANDOT

Special Jurisdictional Note :

Details :

3 Journeymen to 1 Apprentice

CARROLL, COSHOCTON, HOLMES, KNOX,
STARK, TUSCARAWAS, WAYNE

Special Jurisdictional Note :

Details :

Prevailing Wage Rate Skilled Crafts

Name of Union: Plumber Pipefitter Local 94

Change # : LCN01-2020fbLoc94

Craft : Plumber/Pipefitter Effective Date : 06/04/2020 Last Posted : 06/04/2020

	BHR		Fringe Benefit Payments					Irrevocable Fund		Total PWR	Overtime Rate	
			H&W	Pension	App Tr.	Vac.	Annuity	Other	LECET (*)			MISC (*)
Classification												
Plumber Pipefitter	\$35.78		\$8.58	\$5.94	\$0.77	\$0.00	\$6.05	\$0.19	\$0.00	\$0.00	\$57.31	\$75.20
Apprentice Hired After 05-01-2017												
1st Year	\$14.31		\$8.58	\$0.00	\$0.77	\$0.00	\$3.03	\$0.19	\$0.00	\$0.00	\$26.88	\$34.03
2nd Year	\$17.89		\$8.58	\$0.50	\$0.77	\$0.00	\$3.03	\$0.19	\$0.00	\$0.00	\$30.96	\$39.91
3rd Year	\$21.47		\$8.58	\$0.50	\$0.77	\$0.00	\$2.69	\$0.19	\$0.00	\$0.00	\$34.20	\$44.93
4th Year	\$25.05		\$8.58	\$0.74	\$0.77	\$0.00	\$4.23	\$0.19	\$0.00	\$0.00	\$39.56	\$52.09
5th Year	\$28.62		\$8.58	\$0.75	\$0.77	\$0.00	\$4.23	\$0.19	\$0.00	\$0.00	\$43.14	\$57.45
Apprentice If Hired Before 5-01-2017	Percent											
5th 6 months	60.00	\$21.47	\$8.58	\$0.50	\$0.77	\$0.00	\$1.79	\$0.19	\$0.00	\$0.00	\$33.30	\$44.03
6th 6 months	65.00	\$23.26	\$8.58	\$0.50	\$0.77	\$0.00	\$1.79	\$0.19	\$0.00	\$0.00	\$35.09	\$46.72
7th 6 months	75.00	\$26.83	\$8.58	\$0.50	\$0.77	\$0.00	\$1.79	\$0.19	\$0.00	\$0.00	\$38.67	\$52.08
8th 6 months	80.00	\$28.62	\$8.58	\$0.50	\$0.77	\$0.00	\$1.79	\$0.19	\$0.00	\$0.00	\$40.45	\$54.77
9th 6 months	85.00	\$30.41	\$8.58	\$0.50	\$0.77	\$0.00	\$1.79	\$0.19	\$0.00	\$0.00	\$42.24	\$57.45
10th 6 months	90.00	\$32.20	\$8.58	\$0.50	\$0.77	\$0.00	\$1.79	\$0.19	\$0.00	\$0.00	\$44.03	\$60.13

Special Calculation Note : Other is Industry and International Training Fund.

Ratio :

- 1 Journeymen to 2 Apprentice
- 4 Journeymen to 3 Apprentice
- 6 Journeymen to 4 Apprentice
- 9 Journeymen to 5 Apprentice

Jurisdiction (* denotes special jurisdictional note) :

CARROLL*, STARK, WAYNE

3 Journeyman to 1 Apprentice Thereafter

Special Jurisdictional Note : In Carroll County the following townships are included: Ross, Monroe, Union, Lee, Orange, Perry and London.

Details :

Prevailing Wage Rate Skilled Crafts

Name of Union: Plumber Pipefitter Local 94

Change # : LCN01-2019fbLoc94

Craft : Plumber/Pipefitter Effective Date : 11/26/2019 Last Posted : 11/26/2019

	BHR		Fringe Benefit Payments					Irrevocable Fund		Total PWR	Overtime Rate	
			H&W	Pension	App Tr.	Vac.	Annuity	Other	LECET (*)			MISC (*)
Classification												
Plumber Pipefitter	\$35.78		\$8.08	\$5.59	\$0.72	\$0.00	\$5.65	\$0.19	\$0.00	\$0.00	\$56.01	\$73.90
Apprentice Hired Before 05-01-2017												
3 rd 6 months	\$17.89		\$8.08	\$0.50	\$0.72	\$0.00	\$1.79	\$0.19	\$0.00	\$0.00	\$29.17	\$38.11
4th 6 Months	\$19.68		\$8.08	\$0.50	\$0.72	\$0.00	\$1.79	\$0.19	\$0.00	\$0.00	\$30.96	\$40.80
5th 6 Months	\$21.47		\$8.08	\$0.50	\$0.72	\$0.00	\$1.79	\$0.19	\$0.00	\$0.00	\$32.75	\$43.48
6th 6 months	\$23.26		\$8.08	\$0.50	\$0.72	\$0.00	\$1.79	\$0.19	\$0.00	\$0.00	\$34.54	\$46.17
7th 6 Months	\$26.84		\$8.08	\$0.50	\$0.72	\$0.00	\$1.79	\$0.19	\$0.00	\$0.00	\$38.12	\$51.54
8th 6 Months	\$28.62		\$8.08	\$0.50	\$0.72	\$0.00	\$1.79	\$0.19	\$0.00	\$0.00	\$39.90	\$54.21
9th 6 Months	\$30.41		\$8.08	\$0.50	\$0.72	\$0.00	\$1.79	\$0.19	\$0.00	\$0.00	\$41.69	\$56.89
10th 6 Months	\$32.20		\$8.08	\$0.50	\$0.72	\$0.00	\$1.79	\$0.19	\$0.00	\$0.00	\$43.48	\$59.58
Apprentice If Hired After 5-01-2017												
	Percent											
1st Year	40.00	\$14.31	\$8.08	\$0.00	\$0.72	\$0.00	\$2.83	\$0.19	\$0.00	\$0.00	\$26.13	\$33.29
2nd Yeat	50.00	\$17.89	\$8.08	\$0.50	\$0.72	\$0.00	\$2.69	\$0.19	\$0.00	\$0.00	\$30.07	\$39.01
3rd Year	60.00	\$21.47	\$8.08	\$0.50	\$0.72	\$0.00	\$2.69	\$0.19	\$0.00	\$0.00	\$33.65	\$44.38
4th Year	70.00	\$25.05	\$8.08	\$0.73	\$0.72	\$0.00	\$4.24	\$0.19	\$0.00	\$0.00	\$39.01	\$51.53
5th Year	80.00	\$28.62	\$8.08	\$0.74	\$0.72	\$0.00	\$4.24	\$0.19	\$0.00	\$0.00	\$42.59	\$56.91

Special Calculation Note : Other is Industry and International Training Fund.

Ratio : Jurisdiction (* denotes special

1 Journeymen to 2 Apprentice
4 Journeymen to 3 Apprentice
6 Journeymen to 4 Apprentice
9 Journeymen to 5 Apprentice

jurisdictional note) :
CARROLL*, STARK, WAYNE

3 Journeyman to 1 Apprentice Thereafter

Special Jurisdictional Note : In Carroll County the following townships are included: Ross, Monroe, Union, Lee, Orange, Perry and London.

Details :

Prevailing Wage Rate Skilled Crafts

Name of Union: Roofer Local 88

Change # : LCN01-2020fbLoc88

Craft : Roofer Effective Date : 06/04/2020 Last Posted : 06/04/2020

	BHR		Fringe Benefit Payments					Irrevocable Fund		Total PWR	Overtime Rate	
			H&W	Pension	App Tr.	Vac.	Annuity	Other	LECET (*)			MISC (*)
Classification												
Roofer	\$27.00		\$8.90	\$8.95	\$0.40	\$0.00	\$1.25	\$0.15	\$0.00	\$0.00	\$46.65	\$60.15
HELPERS												
Helper -500 Hrs. 1st 6 months	\$15.12		\$2.25	\$0.00	\$0.40	\$0.00	\$1.25	\$0.15	\$0.00	\$0.00	\$19.17	\$26.73
Helper - 500 Hrs. 2nd 6 months	\$16.74		\$8.90	\$8.95	\$0.40	\$0.00	\$1.25	\$0.15	\$0.00	\$0.00	\$36.39	\$44.76
2nd year Helper	\$18.36		\$8.90	\$8.95	\$0.40	\$0.00	\$1.25	\$0.15	\$0.00	\$0.00	\$38.01	\$47.19
3rd year Helper	\$19.98		\$8.90	\$8.95	\$0.40	\$0.00	\$1.25	\$0.15	\$0.00	\$0.00	\$39.63	\$49.62
4th year Helper	\$21.60		\$8.90	\$8.95	\$0.40	\$0.00	\$1.25	\$0.15	\$0.00	\$0.00	\$41.25	\$52.05
5th year Helper	\$23.22		\$8.90	\$8.95	\$0.40	\$0.00	\$1.25	\$0.15	\$0.00	\$0.00	\$42.87	\$54.48
6th year Helper	\$24.84		\$8.90	\$8.95	\$0.40	\$0.00	\$1.25	\$0.15	\$0.00	\$0.00	\$44.49	\$56.91
Apprentice	Percent											
1st 6 months w/500 hrs	56.00	\$15.12	\$8.90	\$8.95	\$0.40	\$0.00	\$1.25	\$0.15	\$0.00	\$0.00	\$34.77	\$42.33
2nd 6 months w/500 hrs	62.00	\$16.74	\$8.90	\$8.95	\$0.40	\$0.00	\$1.25	\$0.15	\$0.00	\$0.00	\$36.39	\$44.76
3rd 6 months w/500 hrs	68.00	\$18.36	\$8.90	\$8.95	\$0.40	\$0.00	\$1.25	\$0.15	\$0.00	\$0.00	\$38.01	\$47.19
4th 6 months w/500 hrs	74.00	\$19.98	\$8.90	\$8.95	\$0.40	\$0.00	\$1.25	\$0.15	\$0.00	\$0.00	\$39.63	\$49.62

5th 6 months w/500 hrs	80.00	\$21.60	\$8.90	\$8.95	\$0.40	\$0.00	\$1.25	\$0.15	\$0.00	\$0.00	\$41.25	\$52.05
6th 6 months w/500 hrs	86.00	\$23.22	\$8.90	\$8.95	\$0.40	\$0.00	\$1.25	\$0.15	\$0.00	\$0.00	\$42.87	\$54.48
7th 6 months w/500 hrs	92.00	\$24.84	\$8.90	\$8.95	\$0.40	\$0.00	\$1.25	\$0.15	\$0.00	\$0.00	\$44.49	\$56.91
8th 6 months w/500 hrs	100.00	\$27.00	\$8.90	\$8.95	\$0.40	\$0.00	\$1.25	\$0.15	\$0.00	\$0.00	\$46.65	\$60.15

Special Calculation Note : Roofers working in any form of coal tar pitch, whether hot or cold, installing and/or removing will be paid \$.25 more per hour. Other \$.15 is for C.I.D.B.

Ratio :

No helper shall be used on any one job unless 1 Journeymen, and 1 Apprentices are working on said job .One (1) Journeymen to One (1) Apprentice to One (1) Helper

Jurisdiction (* denotes special jurisdictional note) :

ASHLAND, CARROLL, COSHOCTON, CRAWFORD, HOLMES, HURON, LORAIN*, MEDINA, PORTAGE, RICHLAND, STARK, SUMMIT, TUSCARAWAS, WAYNE

Special Jurisdictional Note : In Lorain County (South of the Turnpike)

Details :

Prevailing Wage Rate Skilled Crafts

Name of Union: Sheet Metal Local 33 (Akron)

Change # : LCN03-2020fbLoc33Akron

Craft : Sheet Metal Worker Effective Date : 09/23/2020 Last Posted : 09/23/2020

	BHR		Fringe Benefit Payments					Irrevocable Fund		Total PWR	Overtime Rate	
			H&W	Pension	App Tr.	Vac.	Annuity	Other	LECET (*)			MISC (*)
Classification												
Sheet Metal Worker	\$32.12		\$8.50	\$12.89	\$1.21	\$0.00	\$6.60	\$0.00	\$0.00	\$0.00	\$61.32	\$77.38
Industrial Door	\$23.08		\$7.38	\$5.33	\$0.17	\$0.00	\$1.87	\$0.00	\$0.00	\$0.00	\$37.83	\$49.37
Apprentice Helper Trainee												
1st 60 Days Probationary Period	\$11.63		\$0.00	\$0.00	\$0.00	\$0.00	\$0.00	\$0.00	\$0.00	\$0.00	\$11.63	\$17.44
61 days-12 Months	\$12.97		\$7.38	\$1.84	\$0.17	\$0.00	\$1.25	\$0.00	\$0.00	\$0.00	\$23.61	\$30.10
2nd Year	\$15.20		\$7.38	\$1.84	\$0.17	\$0.00	\$1.40	\$0.00	\$0.00	\$0.00	\$25.99	\$33.59
3rd Year	\$16.32		\$7.38	\$1.84	\$0.17	\$0.00	\$1.48	\$0.00	\$0.00	\$0.00	\$27.19	\$35.35
4th Year	\$17.89		\$7.38	\$1.84	\$0.17	\$0.00	\$1.58	\$0.00	\$0.00	\$0.00	\$28.86	\$37.81
5th Year	\$19.23		\$7.38	\$1.84	\$0.17	\$0.00	\$1.67	\$0.00	\$0.00	\$0.00	\$30.29	\$39.91
Apprentice	Percent											
Apprentice												
1st year	45.00	\$14.45	\$8.50	\$3.47	\$0.17	\$0.00	\$0.00	\$0.00	\$0.00	\$0.00	\$26.59	\$33.82
2nd year	50.00	\$16.06	\$8.50	\$4.62	\$1.21	\$0.00	\$3.30	\$0.00	\$0.00	\$0.00	\$33.69	\$41.72
3rd year	55.00	\$17.67	\$8.50	\$5.00	\$1.21	\$0.00	\$3.30	\$0.00	\$0.00	\$0.00	\$35.68	\$44.51
4th year	65.00	\$20.88	\$8.50	\$5.77	\$1.21	\$0.00	\$3.30	\$0.00	\$0.00	\$0.00	\$39.66	\$50.10
5th year	80.00	\$25.70	\$8.50	\$6.93	\$1.21	\$0.00	\$3.30	\$0.00	\$0.00	\$0.00	\$45.64	\$58.48

Special Calculation Note : No special calculations for this skilled craft wage rate are required at this time.

Ratio :

- 1 Journeymen to 1 Apprentice
- 2 Journeymen to 1 Apprentice
- 3 Journeymen to 2 Apprentice
- 4 Journeymen to 2 Apprentice

Jurisdiction (* denotes special jurisdictional note) :

- ASHLAND, CARROLL, COSHOCTON,
- CRAWFORD, HOLMES, MEDINA, PORTAGE,
- RICHLAND, STARK, SUMMIT, TUSCARAWAS,
- WAYNE

5-7 Journeymen to 3 Apprentice
8-10 Journeymen to 4 Apprentice
11-13 Journeymen to 5 Apprentice
14, 15 Journeymen to 6 Apprentice
and maintaining a three to one apprentice ratio
thereafter.

Special Jurisdictional Note :

Details :

Scope of Work: This Agreement covers the rates of pay and conditions of employment of all employees of the Employer engaged in, but not limited to, the a) manufacture, fabrication, assembling, handling, erection, installation, dismantling, conditioning, adjustment, alteration, repairing and servicing of all ferrous or non-ferrous metal work and all other materials used in lieu thereof and of all HVAC systems, air-veyor systems, exhaust systems, and air handling systems regardless of material used, including the setting of all equipment and all reinforcements in connection therewith; (b) all lagging over insulation and all duct-lining; (c) testing, servicing, and balancing of all air-handling equipment and duct work; (d) the preparation of all shop and field sketches, whether manually drawn or computer assisted, used in fabrication and erection, including those taken from original architectural and engineering drawings or sketches, and (e) metal roofing; and (f) all other work included in the jurisdictional claims of Sheet Metal Worker's International Association.

Industrial Door-Installation and service of overhead doors roll up doors, docks and dock leveling.

Prevailing Wage Rate Skilled Crafts

Name of Union: Sheet Metal Local 33 (Akron) Decking

Change # : CN01-2009Loc33(Akron)Deck

Craft : Sheet Metal Worker Effective Date : 09/24/2009 Last Posted : 09/24/2009

	BHR		Fringe Benefit Payments						Irrevocable Fund		Total PWR	Overtime Rate
			H&W	Pension	App Tr.	Vac.	Annuity	Other	LECET (*)	MISC (*)		
Classification												
Sheet Metal Worker Decking & Siding	\$20.06		\$6.31	\$6.35	\$0.38	\$0.00	\$0.00	\$0.98			\$34.08	\$44.11
Decking & Siding Specialty Trainees	Percent											
1st 30 days	64.25	\$12.89	\$0.00	\$0.00	\$0.00	\$0.00	\$0.00	\$0.00			\$12.89	\$19.33
2nd thru 6th months	64.25	\$12.89	\$6.31	\$6.35	\$0.00	\$0.00	\$0.00	\$0.00			\$25.55	\$31.99
7th thru 12th months	64.28	\$12.89	\$6.31	\$6.35	\$0.38	\$0.00	\$0.00	\$0.98			\$26.91	\$33.36
2nd year	78.56	\$15.76	\$6.31	\$6.35	\$0.38	\$0.00	\$0.00	\$0.98			\$29.78	\$37.66

Special Calculation Note : No special calculations for this skilled craft wage rate are required at this time.

Ratio : **Jurisdiction (* denotes special jurisdictional note) :**

3 Journeymen To 1 Apprentice

ASHLAND, CARROLL, COSHOCTON,
CRAWFORD, HOLMES, MEDINA, PORTAGE,
RICHLAND, STARK, SUMMIT, TUSCARAWAS,
WAYNE

Special Jurisdictional Note :

Details :

Work but not limited to:Exterior application of manufactured and/or job site fabricated metal decking, siding and exterior appurtenances thereto. The erection of pre-engineered metal buildings, pre-manufactured gas stations and appurtenances thereto. The installation of metal roofs and appurtenances. The erection and/or job site fabrication of draft or fire curtains and appurtenances thereto.

Prevailing Wage Rate Skilled Crafts

Name of Union: Sprinkler Fitter Local 669

Change # : LCN02-2020fbLoc669

Craft : Sprinkler Fitter Effective Date : 01/01/2021 Last Posted : 12/22/2020

	BHR		Fringe Benefit Payments						Irrevocable Fund		Total PWR	Overtime Rate
			H&W	Pension	App Tr.	Vac.	Annuity	Other	LECET (*)	MISC (*)		
Classification												
Sprinkler Fitter	\$40.40		\$10.55	\$7.00	\$0.52	\$0.00	\$5.12	\$0.10	\$0.00	\$0.00	\$63.69	\$83.89
Apprentice Indentured after April 1, 2013	Percent											
CILASS 1	45.00	\$18.18	\$7.75	\$0.00	\$0.52	\$0.00	\$0.00	\$0.10	\$0.00	\$0.00	\$26.55	\$35.64
CLASS 2	50.00	\$20.20	\$7.75	\$0.00	\$0.52	\$0.00	\$0.00	\$0.10	\$0.00	\$0.00	\$28.57	\$38.67
CLASS 3	54.38	\$21.97	\$10.55	\$7.00	\$0.52	\$0.00	\$1.15	\$0.10	\$0.00	\$0.00	\$41.29	\$52.27
CLASS 4	59.38	\$23.99	\$10.55	\$7.00	\$0.52	\$0.00	\$1.15	\$0.10	\$0.00	\$0.00	\$43.31	\$55.30
CLASS 5	64.38	\$26.01	\$10.55	\$7.00	\$0.52	\$0.00	\$1.40	\$0.10	\$0.00	\$0.00	\$45.58	\$58.58
CLASS 6	69.38	\$28.03	\$10.55	\$7.00	\$0.52	\$0.00	\$1.40	\$0.10	\$0.00	\$0.00	\$47.60	\$61.61
CLASS 7	74.38	\$30.05	\$10.55	\$7.00	\$0.52	\$0.00	\$1.40	\$0.10	\$0.00	\$0.00	\$49.62	\$64.64
CLASS 8	79.38	\$32.07	\$10.55	\$7.00	\$0.52	\$0.00	\$1.40	\$0.10	\$0.00	\$0.00	\$51.64	\$67.67
CLASS 9	84.38	\$34.09	\$10.55	\$7.00	\$0.52	\$0.00	\$1.40	\$0.10	\$0.00	\$0.00	\$53.66	\$70.70
CLASS 10	89.38	\$36.11	\$10.55	\$7.00	\$0.52	\$0.00	\$1.40	\$0.10	\$0.00	\$0.00	\$55.68	\$73.73

Special Calculation Note : \$0.10 for Other is National Fire Sprinkler Association

Ratio :

1 Journeyman to 1 Apprentice

Jurisdiction (* denotes special jurisdictional note) :

ADAMS, ALLEN, ASHLAND, ASHTABULA, ATHENS, AUGLAIZE, BELMONT, BROWN, BUTLER, CARROLL, CHAMPAIGN, CLARK, CLERMONT, CLINTON, COLUMBIANA, COSHOCTON, CRAWFORD, DARKE, DEFIANCE, DELAWARE, ERIE, FAIRFIELD, FAYETTE, FRANKLIN, FULTON, GALLIA, GREENE, GUERNSEY, HAMILTON, HANCOCK, HARDIN, HARRISON, HENRY, HIGHLAND, HOCKING, HOLMES, HURON, JACKSON, JEFFERSON, KNOX, LAWRENCE, LICKING, LOGAN, LUCAS, MADISON, MAHONING, MARION, MEDINA, MEIGS, MERCER, MIAMI, MONROE, MONTGOMERY, MORGAN, MORROW,

MUSKINGUM, NOBLE, OTTAWA, PAULDING,
PERRY, PICKAWAY, PIKE, PORTAGE, PREBLE,
PUTNAM, RICHLAND, ROSS, SANDUSKY,
SCIOTO, SENECA, SHELBY, STARK, SUMMIT,
TRUMBULL, TUSCARAWAS, UNION, VAN
WERT, VINTON, WARREN, WASHINGTON,
WAYNE, WILLIAMS, WOOD, WYANDOT

Special Jurisdictional Note :

Details :

Sprinkler Fitter work shall consist of the installation, dismantling, maintenance, repairs, adjustments, and corrections of all fire protection and fire control systems including the unloading, handling by hand, power equipment and installation of all piping or tubing, appurtenances and equipment pertaining thereto, including both overhead and underground water mains, fire hydrants and hydrant mains, standpipes and hose connections to sprinkler systems used in connection with sprinkler and alarm systems. Also all tanks and pumps connected thereto, also included shall be CO-2 and Cardox Systems, Dry Chemical Systems, Foam Systems and all other fire protection systems.

Prevailing Wage Rate Skilled Crafts

**Name of Union: Truck Driver Bldg & HevHwy Class 1
Locals 20,40,92,92b,100,175,284,438,377,637,908,957**

Change # : LCON1-2019fbBldgHevHwy

Craft : Truck Driver Effective Date : 09/11/2019 Last Posted : 09/11/2019

	BHR		Fringe Benefit Payments					Irrevocable Fund		Total PWR	Overtime Rate	
			H&W	Pension	App Tr.	Vac.	Annuity	Other	LECET (*)			MISC (*)
Classification												
Truck Driver CLASS 1 4 wheel service, dump, and batch trucks, Oil Distributor - Asphalt Distributor-Tandems	\$28.04		\$7.00	\$7.90	\$0.20	\$0.00	\$0.00	\$0.00	\$0.00	\$0.00	\$43.14	\$57.16
Apprentice	Percent											
First 6 months	80.00	\$22.43	\$7.00	\$7.90	\$0.20	\$0.00	\$0.00	\$0.00	\$0.00	\$0.00	\$37.53	\$48.75
7-12 months	85.00	\$23.83	\$7.00	\$7.90	\$0.20	\$0.00	\$0.00	\$0.00	\$0.00	\$0.00	\$38.93	\$50.85
13-18 months	90.00	\$25.24	\$7.00	\$7.90	\$0.20	\$0.00	\$0.00	\$0.00	\$0.00	\$0.00	\$40.34	\$52.95
19-24 months	95.00	\$26.64	\$7.00	\$7.90	\$0.20	\$0.00	\$0.00	\$0.00	\$0.00	\$0.00	\$41.74	\$55.06
25-30 months	100.00	\$28.04	\$7.00	\$7.90	\$0.20	\$0.00	\$0.00	\$0.00	\$0.00	\$0.00	\$43.14	\$57.16

Special Calculation Note : No special calculations for this skilled craft wage rate are required at this time.

Ratio :

3 Journeymen to 1 Apprentice per company/project

Jurisdiction (* denotes special jurisdictional note) :

ADAMS, ALLEN, ASHLAND, ASHTABULA, ATHENS, AUGLAIZE, BELMONT, BROWN, BUTLER, CARROLL, CHAMPAIGN, CLARK, CLERMONT, CLINTON, COLUMBIANA, COSHOCTON, CRAWFORD, DARKE, DEFIANCE, DELAWARE, ERIE, FAIRFIELD,

FAYETTE, FRANKLIN, FULTON, GALLIA,
GREENE, GUERNSEY, HAMILTON,
HANCOCK, HARDIN, HARRISON, HENRY,
HIGHLAND, HOCKING, HOLMES, HURON,
JACKSON, JEFFERSON, KNOX, LAWRENCE,
LICKING, LOGAN, LORAIN, LUCAS,
MADISON, MAHONING, MARION, MEDINA,
MEIGS, MERCER, MIAMI, MONROE,
MONTGOMERY, MORGAN, MORROW,
MUSKINGUM, NOBLE, OTTAWA, PAULDING,
PERRY, PICKAWAY, PIKE, PORTAGE, PREBLE,
PUTNAM, RICHLAND, ROSS, SANDUSKY,
SCIOTO, SENECA, SHELBY, STARK, SUMMIT,
TRUMBULL, TUSCARAWAS, UNION, VAN
WERT, VINTON, WARREN, WASHINGTON,
WAYNE, WILLIAMS, WOOD, WYANDOT

Special Jurisdictional Note :

Details :

** Asphalt - Oil spray bar man when operating from cab shall receive \$0.20 cents per hour above their Basic Hourly Rate.

Prevailing Wage Rate Skilled Crafts

**Name of Union: Truck Driver Bldg & HevHwy Class 2
Locals 20,40,92,92b,100,175,284,438,377,637,908,957**

Change # : LCRO1-2019-fbBldgHevHwy

Craft : Truck Driver Effective Date : 10/16/2019 Last Posted : 10/16/2019

	BHR	Fringe Benefit Payments						Irrevocable Fund		Total PWR	Overtime Rate
		H&W	Pension	App Tr.	Vac.	Annuity	Other	LECET (*)	MISC (*)		
Classification											
Truck Driver CLASS 2 Tractor Trailer-Semi Tractor Trucks-Pole Trailers-Ready Mix Trucks-Fuel Trucks- Asphalt-Oil Spray bar men- 5 Axle & Over -Belly Dumps-End Dumps-Articulated Dump Trucks- Low boys-Heavy duty Equipment(irrespective of load carried) when used exclusively for transportation-Truck Mechanics (when needed)	\$28.46	\$7.00	\$7.90	\$0.20	\$0.00	\$0.00	\$0.00	\$0.00	\$0.00	\$43.56	\$57.79
Apprentice	Percent										
First 6 months	80.00	\$22.77	\$7.00	\$7.90	\$0.20	\$0.00	\$0.00	\$0.00	\$0.00	\$37.87	\$49.25
7-12 months	85.00	\$24.19	\$7.00	\$7.90	\$0.20	\$0.00	\$0.00	\$0.00	\$0.00	\$39.29	\$51.39
13-18 months	90.00	\$25.61	\$7.00	\$7.90	\$0.20	\$0.00	\$0.00	\$0.00	\$0.00	\$40.71	\$53.52
19-24 months	95.00	\$27.04	\$7.00	\$7.90	\$0.20	\$0.00	\$0.00	\$0.00	\$0.00	\$42.14	\$55.66
25-30 months	100.00	\$28.46	\$7.00	\$7.90	\$0.20	\$0.00	\$0.00	\$0.00	\$0.00	\$43.56	\$57.79

Special Calculation Note : No special calculations for this skilled craft wage rate are required at this time.

Ratio :

3 Journeymen to 1 Apprentice

Jurisdiction (* denotes special jurisdictional note) :

ADAMS, ALLEN, ASHLAND, ASHTABULA, ATHENS, AUGLAIZE, BELMONT, BROWN, BUTLER, CARROLL, CHAMPAIGN, CLARK, CLERMONT, CLINTON, COLUMBIANA, COSHOCTON, CRAWFORD, DARKE, DEFIANCE, DELAWARE, ERIE, FAIRFIELD,

FAYETTE, FRANKLIN, FULTON, GALLIA,
GREENE, GUERNSEY, HAMILTON,
HANCOCK, HARDIN, HARRISON, HENRY,
HIGHLAND, HOCKING, HOLMES, HURON,
JACKSON, JEFFERSON, KNOX, LAWRENCE,
LICKING, LOGAN, LORAIN, LUCAS,
MADISON, MAHONING, MARION, MEDINA,
MEIGS, MERCER, MIAMI, MONROE,
MONTGOMERY, MORGAN, MORROW,
MUSKINGUM, NOBLE, OTTAWA, PAULDING,
PERRY, PICKAWAY, PIKE, PORTAGE, PREBLE,
PUTNAM, RICHLAND, ROSS, SANDUSKY,
SCIOTO, SENECA, SHELBY, STARK, SUMMIT,
TRUMBULL, TUSCARAWAS, UNION, VAN
WERT, VINTON, WARREN, WASHINGTON,
WAYNE, WILLIAMS, WOOD, WYANDOT

Special Jurisdictional Note :

Details :

** Asphalt - Oil spray bar man when operating from cab shall receive \$0.20 cents per hour above their Basic Hourly Rate.

Appendix C

Supplemental Specification 01-00

**PROJECT DOCUMENTATION AND SUBMITTAL REQUIREMENTS
FOR
ALL PUBLIC WORK PROJECTS AND SUBDIVISION DEVELOPMENTS**

September, 2000

* Revised August, 2009

Project Submittals: The following listed items are the full responsibility of the Contractor. These items become part of the administrative duties imposed upon this Contract. The Contractor shall be responsible for submitting all detail items prior to the contract Notice of Commencement, or as directed by the City's Project Manager. A typewritten letter shall accompany all items, on Company letterhead; clearly describe each item submitted. If Contractor elects to fax any documentation due to expediency, the Contractor will be responsible for submitting hard copy for project documentation. The City will reject any information not clearly legible. **Submit four copies of the project submittals.**

Contractor will clearly affix a label or stamp identifying the submittal and its status for project review. All actions other than "no exception taken" will require supporting notation or information for project review.

Allow at least 10 business days for City's review and execution. The City Project Manager shall assist the Contractor with any questions or clarification during this process to ensure timely response to the Contractor.

The City will not pay directly for the performance of the work listed. This work is a subsidiary obligation of the Contractor.

1. Shop Drawings
2. Preconstruction Video
3. Progress Schedule
4. Release Statement for Disposal of Excavated Material
5. Traffic Control Plan
6. Contractor and Subcontractor Emergency Contact List
7. Statements of Final Compliance

1. Shop Drawings

- a) Upon written request from the Engineer, the Contractor shall submit detailed drawings, acceptable catalog data, specification and material certifications for all materials and/or equipment specialized or required for the proper completion of the work.
- b) Contractor shall submit shop drawings in not less than four (4) copies to the Engineer.
- c) Contractor shall submit shop drawings in proper sequence of construction to cause no delay in the work. The Engineer will have ten (10) business days to review submittals. The Contractor's failure to transmit appropriate submittals to the Engineer sufficiently in advance of work shall not be grounds for time extension. No work shall be performed

12th St. NW Water Main Replacement (TAG 617)

- requiring shop drawings until same the Engineer has approved these shop drawings.
- d) Label each shop drawing with the following:
 - 1. Project Name
 - 2. Name of Contractor
 - 3. Name of Subcontractor (if applicable)
 - 4. Name and Address of Supplier and/or Manufacturer
 - 5. Log Reference Number
 - e) The Contractor is responsible for reviewing and approving all shop drawings prior to submittal. The Engineer's review does not make him responsible for the accuracy of said drawings.
2. **Preconstruction Video:** Prior to actual construction, the Contractor shall take video recording of the entire length and width of the work site.
- a) The Contractor shall notify the Engineering Department prior to scheduling the video recording of the site. A representative of the Engineering Department shall be present when the recording this video.
 - b) The video and audio recordings shall be on DVD or pre-approved alternative for replay. Contractor must submit alternative medium to the Engineer and approval received prior to scheduling.
 - c) The video portion shall have continuous time and date incorporated into it, locations and person(s) doing the work.
 - d) Audio comments during the recording must address each item in the field of view as it may pertain to the project construction. The recording technician will need to become familiar with the project plans to know what subject matter is pertinent. Further, contractor must incorporate a post recording review and audio comments into the recording.
 - e) Submitted copies of all recordings are the property of the Engineer. Contractor must submit the recording and be accepted in full by the Engineering Department prior to the start of construction.
3. **Progress Schedule:** The Contractor shall provide to the City, as mutually agreed upon at the Contract's Preconstruction meeting, a graphic progress schedule, which shall include the following:
- a) Progress schedule as a minimum to be prepared in **CRITICAL PATH METHOD FORMAT (CPM)**. The schedule shall be submitted, as a minimum, on 11" x 17" format for clarity and any necessary notations. Progress schedule shall include all work activities relative to the project, as further described in the Contract. Activities and rate of expected progress to secure completion as set forth in the Contract shall be shown on the schedule. Contractor to annotate any milestones that may be indicated in the Contract. Project completion date shall be clearly defined on the original schedule and all ensuing schedules provided.
 - b) Schedules shall be updated, as a minimum, every 30 days, or as agreed to by the City's

12th St. NW Water Main Replacement (TAG 617)

Project Manager.

4. **Release Statement for Disposal of Excavated Materials**

- (a) The Contractor shall provide to the City a written consent statement from all property owners whose property is a landfill depository for all surplus or unsuitable excavated material from the project site.
- (b) The Contractor shall follow ODOT 105.16 for specific guidelines and name the “City of Canton” in lieu of “the Department” on all forwarded documents. The City requires a contract or permit that contains the language stating that the City is not party to the contract or permit, the material is not the City’s, and that the contractor and the property owner will hold the City harmless from claims that may arise from this contract or permit.
- (c) See attached sample copy for referencing purposes.

5. **Traffic Control Plan:** Contractor shall submit a graphical presentation or written document detailing the signage to be used and its location for maintenance of traffic. If traffic control will be performed in stages, submit a plan for each stage. Any proposed detours should be approved by the Engineer prior to plan submission.

6. **Contractor and Subcontractor Emergency Contact List:** Contractor shall submit to the Engineer, prior to commencing construction, a complete list of the Contractor’s personnel associated with the project. List should include name, title, and emergency contact phone numbers for each individual.

7. **Statements of Final Compliance:** The Contractor shall submit to the City the following documentation, in addition to the Project’s General Conditions. All submittals shall be completed and approved prior to the release of the final retainer.

- a) Certificates of Substantial and Final Completion. Contractor shall submit in writing, the date on which work is substantially completed and upon Final Completion. Any deviation from the stated contract completion date to what is being submitted shall be explained further by the Contractor. The City, at their discretion, will further review this subject, as needed.
- b) Final Waiver of Lien
Contractor shall furnish a written report indicating the resolution of any and all property damage claims filed with Contractor by any party during the contract period. The information shall include the name of claimant; date filed with Contractor; name of Insurance Company and/or Adjustor handling the claim; how the claim was resolved; if claim was not resolved for the full amount, a statement indicating the reason for such action. If there were no damage claims filed with the Contractor, then this shall be so stated in the report.

12th St. NW Water Main Replacement (TAG 617)

(SAMPLE COPY)

Waste Disposal Agreement for Projects in the City of Canton

Items 1, 3 - 9 are optional and discretionary to the undersigned

THIS WASTE AGREEMENT, made this _____ day of _____ 20____, by and between _____ (called "Contractor"), and _____ (called "Land Owner"), concerning a certain construction contract between the Contractor and _____ in the City of Canton, OH for the _____ (project), as follows:

- 1. MANNER OF WASTING: Land Owner grants to Contractor the exclusive right to place dirt, earth, rock, topsoil, subsurface, unsuitable and/or other excess material (called "waste material") upon the area described in the following paragraph without requirement, limit, or restriction as to depth, amount, manner, or time.
2. WASTE AREA: The property upon which Contractor is permitted to place material is commonly known as _____ (address).
3. TITLE TO WASTE AREA: The Land Owner warrants that it has title to and the right to contract for placement of waste material in said area and agrees to defend and indemnify Contractor against any claim, suit, or damage arising out of such title or right to contract.
4. ACCESS AND USE: Land Owner hereby grants Contractor the right of ingress and egress to the waste area in locations to be selected by Contractor for all purposes necessary to the complete fulfillment of this agreement, and the right of quiet enjoyment in the intended use of such area.
5. PAYMENT: Contractor agrees to pay and Land Owner agrees to accept as full and final compensation for all rights granted and covenants contained herein and all claims of every nature the sum of _____ payable _____.
6. BASIS OF MEASUREMENTS: It is mutually agreed that measurement of the amount of materials wasted, where required, shall be made on the following basis: _____ and said measurement shall be binding upon the parties hereto for all purposes.
7. DAMAGES: Land Owner hereby waives any and all claims for damage to the waste area and to the area of ingress and egress except as specifically noted herein.
8. RELEASE: Upon receipt of final payment hereunder, and provided all terms of this agreement have been fulfilled, Land Owner hereby releases Contractor from further liability of any kind or nature hereunder.

WITNESSES:

CONTRACTOR:

Authorized Signature & Title

LANDOWNER:

Signature

- 9. ENTIRE AGREEMENT: It is agreed that the terms and conditions of this agreement are fully covered in the foregoing, and that any oral or written statements made by either party, or agents claiming to represent either party, not set forth herein, are not binding on the parties and are not considered as part of this Agreement.
10. DISCLAIMER: The City of Canton is not a party to the here above agreement. The Contractor and Landowner shall indemnify and save harmless the City of Canton from any claim that may arise from the here above agreement. The waste material is the property of the Contractor, not the City of Canton.

Appendix C

12TH ST. NW WATER MAIN REPLACEMENT TAG 617

LOCATED IN CANTON TOWNSHIP
STARK COUNTY, OHIO

FEBRUARY 2021

INDEX OF SHEETS:

TITLE SHEET	1
SCHEMATIC PLAN	2
GENERAL NOTES	3-5
GENERAL SUMMARY	6
PLAN AND PROFILE SHEETS	7-9
WATERLINE DETAILS	10
MISCELLANEOUS DETAILS	11

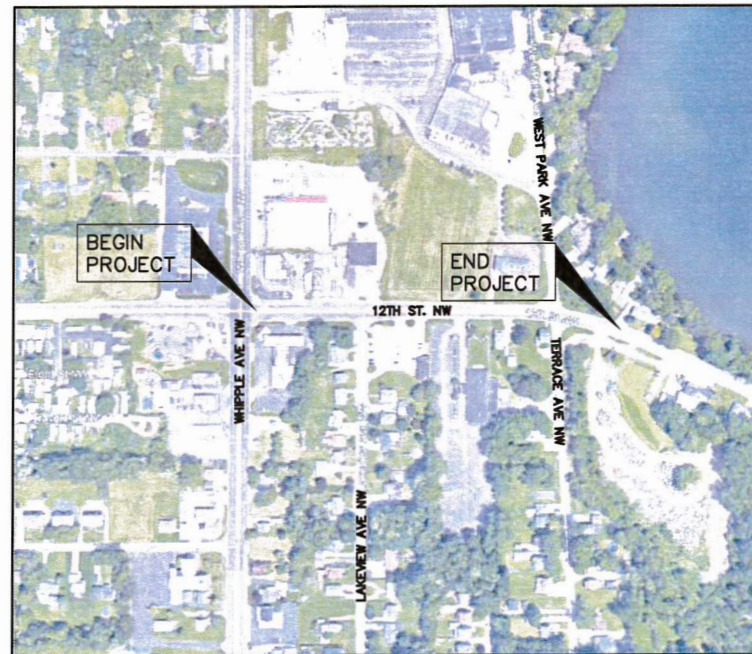

 **LOCATION MAP**
(NOT TO SCALE)

LATITUDE: 40°48'39" LONGITUDE: 81°25'26"

CANTON CITY OFFICIALS:

MAYOR	THOMAS M. BERNABEI
DIRECTOR OF PUBLIC SERVICE	JOHN M. HIGHMAN
CANTON WATER DEPT. SUPERINTENDENT	TYLER S. CONVERSE

MEMBERS OF CANTON CITY COUNCIL:

COUNCIL PRESIDENT	WILLIAM SHERER II
WARD 1	GREG HAWK
WARD 2	BRENDA KIMBROUGH
WARD 3	JASON SCAGLIONE
WARD 4	CHRIS SMITH
WARD 5	ROBERT FISHER
WARD 6	KEVIN HALL
WARD 7	JOHN MARIOL II
WARD 8	PETER FERGUSON
WARD 9	FRANK MORRIS
AT LARGE	JAMES BABCOCK
AT LARGE	CHRISTINE SCHULMAN
AT LARGE	BILL SMUCKLER

PLAN APPROVALS:

WATERLINE IS APPROVED BY THE CITY OF CANTON WATER DEPARTMENT THIS 8 DAY OF February 2021

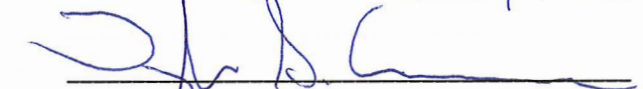
TYLER S. CONVERSE - SUPERINTENDENT

N:\Water_d1\EngrDwgs\Waterline Projects\Active\TAG 617_12th Street NW WL Rplc\DWGs\12th St_BM.dwg 2/3/2021

UNDERGROUND UTILITIES	
CONTACT BOTH SERVICES CALL TWO WORKING DAYS BEFORE YOU DIG	
	CALL 1-800-362-2764 (TOLL FREE)
	OHIO UTILITIES PROTECTION SERVICE NON-MEMBERS MUST BE CALLED DIRECTLY
OIL & GAS PRODUCERS PROTECTIVE SERVICE CALL: 1-800-925-0988	

CALCULATED
DGP
CHECKED
BDB

TITLE SHEET

12TH ST. NW WATER MAIN REPLACEMENT

Plans Prepared By
**The City of Canton
Water Department**
2684 Harrisburg Rd. N.E. • Canton, Ohio 44705
(330) 499-3310



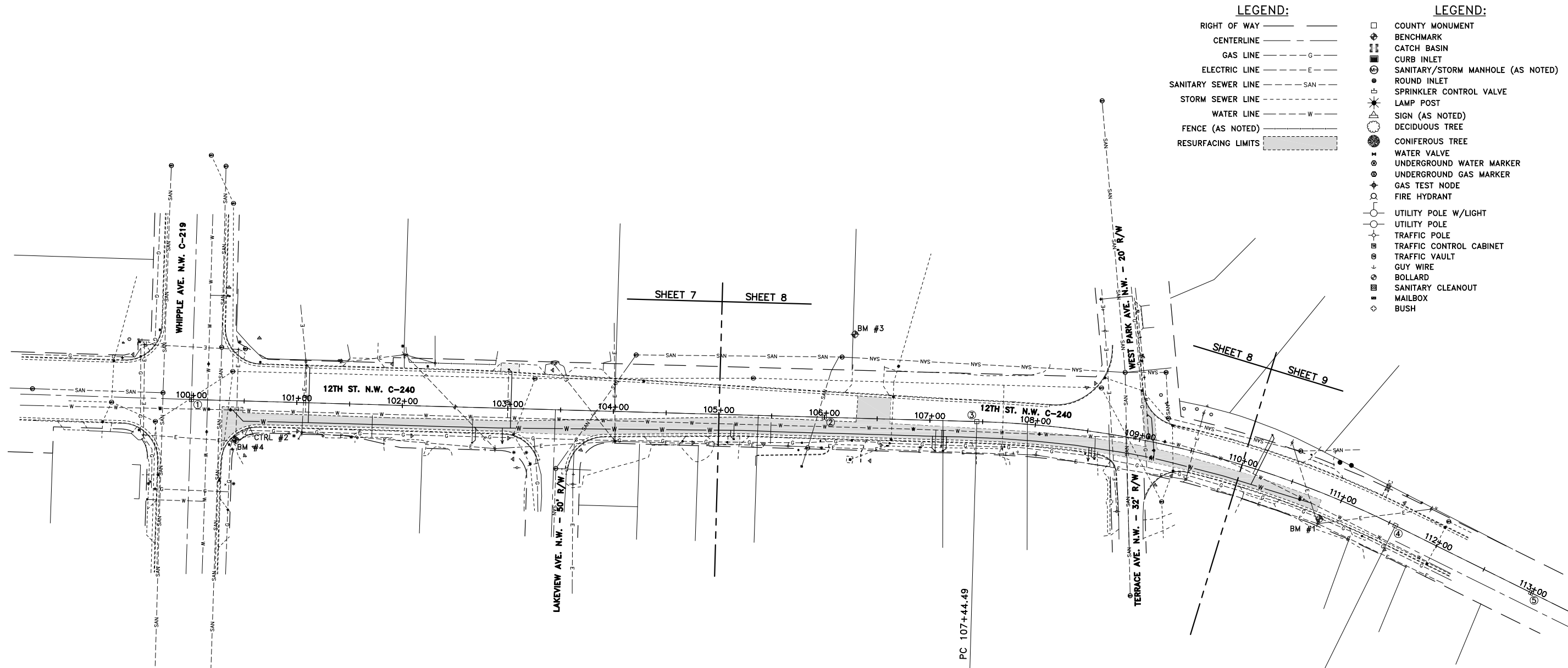

- LEGEND:**
- RIGHT OF WAY
 - CENTERLINE
 - GAS LINE
 - ELECTRIC LINE
 - SANITARY SEWER LINE
 - STORM SEWER LINE
 - WATER LINE
 - FENCE (AS NOTED)
 - RESURFACING LIMITS
- LEGEND:**
- COUNTY MONUMENT
 - BENCHMARK
 - CATCH BASIN
 - CURB INLET
 - SANITARY/STORM MANHOLE (AS NOTED)
 - ROUND INLET
 - SPRINKLER CONTROL VALVE
 - LAMP POST
 - SIGN (AS NOTED)
 - DECIDUOUS TREE
 - CONIFEROUS TREE
 - WATER VALVE
 - UNDERGROUND WATER MARKER
 - UNDERGROUND GAS MARKER
 - GAS TEST NODE
 - FIRE HYDRANT
 - UTILITY POLE W/LIGHT
 - UTILITY POLE
 - TRAFFIC POLE
 - TRAFFIC CONTROL CABINET
 - TRAFFIC VAULT
 - GUY WIRE
 - BOLLARD
 - SANITARY CLEANOUT
 - MAILBOX
 - BUSH

CURVE DATA:
 $\Delta = 24^{\circ}43'0''$
 $R = 954.930'$
 $T = 209.228'$
 $L = 411.947'$
 $CHB = S76^{\circ}02'26.61''E$
 $CHD = 408.760'$

CENTERLINE CONTROL					
POINT NO.	NORTHING	EASTING	DESCRIPTION	STA.	OFFSET
1	418677.0130	2265929.4120	CENTERLINE INTERSECTION	100+00	0.000'
2	418660.3620	2266529.1410	1" ROD IN MON. BOX	105+99.96	0.207' LT.
3	418656.0940	2266673.6110	3/4" ROD IN MON. BOX (PC POINT)	107+44.49	0.000'
4	418557.4880	2267070.2990	PT POINT	111+56.44	0.000'
5	418493.8189	2267198.9686	POINT ON CENTERLINE	113+00.00	0.000'

BENCH MARKS & CONTROL POINTS						
POINT NO.	NORTHING	EASTING	STA.	OFFSET	ELEV.	DESCRIPTION
BM #1	418563.7430	2266998.3470	110+87.39	23.860' RT.	1111.04	ROD WITH DSI TRAVERSE CAP SET NORTH OF UTILITY POLE
BM #3	418738.8510	2266558.1590	106+26.76	79.480' LT.	1105.25	COTTON GIN SPIKE SET IN ASPHALT OF PRO SHINE CAR WASH
BM #4	418638.4370	2265971.4080	100+43.06	37.381' RT.	1117.53	X IN THE BOLT OF TRAFFIC POLE AT INTERSECTION OF 12TH & WHIPPLE
CTRL #2	418646.4280	2265984.0010	100+55.43	29.039' RT.	1115.67	ROD WITH DSI CAP SET IN R/W ALONG 12TH ST.

N:\Water_d1\EngrDwgs\Waterline Projects\Active\TAG 617_12th_Street_NW_Rplc\DWGs\12th St_BM.dwg 2/3/2021

I. PRECONSTRUCTION INCIDENTALS

(A) PROJECT SPECIFICATIONS/REQUIREMENTS:

ALL WORK REQUIRED TO COMPLETE THIS IMPROVEMENT SHALL BE PERFORMED IN ACCORDANCE WITH SPECIFICATIONS/REQUIREMENTS OF THE CITY OF CANTON AND THE LATEST EDITION OF THE STATE OF OHIO DEPARTMENT OF TRANSPORTATION CONSTRUCTION AND MATERIAL SPECIFICATIONS, EXCEPT AS HEREIN AMENDED. IN THE CASE OF A CONFLICT BETWEEN THE CITY OF CANTON AND THE OHIO DEPARTMENT OF TRANSPORTATION SPECIFICATIONS/REQUIREMENTS, THE CITY OF CANTON REQUIREMENTS WILL TAKE PRECEDENCE, UNLESS OTHERWISE DIRECTED BY THE CITY ENGINEER.

THE DEVELOPER/CONTRACTOR SHALL COMPLY WITH THE CITY OF CANTON SUPPLEMENTAL SPECIFICATION 01-00 PROJECT DOCUMENTATION AND SUBMITTAL REQUIREMENTS.

(B) ADMINISTRATIVE REQUIREMENTS:

THE DEVELOPER/CONTRACTOR SHALL BE RESPONSIBLE FOR FULLY COMPLYING WITH ALL THE ADMINISTRATIVE DUTIES HEREIN CONTAINED.

THE DEVELOPER/CONTRACTOR SHALL DESIGNATE TO THE CITY AN EMPLOYEE RESPONSIBLE FOR CORRESPONDENCE, NOTIFICATIONS, AND SUBMITTALS PERTINENT TO THE PROJECT.

(C) PRECONSTRUCTION MEETING:

A PRECONSTRUCTION MEETING WITH THE DEVELOPER, CONTRACTOR, REPRESENTATIVES OF ALL UTILITY COMPANIES, THE CITY OF CANTON ENGINEERING DEPARTMENT AND THE CITY OF CANTON WATER DEPARTMENT IS REQUIRED FOR THIS PROJECT PRIOR TO THE START OF ANY CONSTRUCTION ACTIVITY.

~~2. FOR SUBDIVISION DEVELOPMENTS, THE DEVELOPER SHALL CONTACT THE CITY ENGINEER'S OFFICE TO ARRANGE A MEETING DATE. THE DEVELOPER WILL CONTACT THE ABOVE AGENCIES TO CONFIRM THE MEETING DATE.~~

FOR CITY GENERAL PROJECTS, THE CITY ENGINEER WILL CONTACT THE CONTRACTOR TO ARRANGE A MEETING DATE. THE CITY ENGINEER WILL CONTACT THE ABOVE AGENCIES TO CONFIRM THE MEETING DATE.

IF THE PROPOSED PROJECT LAND-DISTURBANCE AREA IS ONE (1) OR MORE ACRES, A SEPARATE PRE-CONSTRUCTION MEETING IS ALSO REQUIRED. THIS MEETING SHALL OCCUR ON-SITE BETWEEN THE CONTRACTOR AND THE STARK SOIL & WATER CONSERVATION DISTRICT (SWCD). THE CONTRACTOR IS RESPONSIBLE FOR ARRANGING THIS MEETING. NO LAND-DISTURBANCE ACTIVITIES SHALL START UNTIL SAID MEETING HAS OCCURRED AND APPROVAL HAS BEEN GRANTED BY STARK SWCD.

(D) PROJECT SAFETY:

THE CONTRACTOR SHALL MAINTAIN A SAFE WORKING ENVIRONMENT AT THE PROJECT SITE AT ALL TIMES. THE CONTRACTOR SHALL PROPERLY SUPPORT AND/OR MAINTAIN ALL EXCAVATIONS PER APPLICABLE SAFETY REQUIREMENTS AND COMPLY WITH ALL O.S.H.A. REGULATIONS. APPROPRIATE BARRICADES, WARNING LIGHTS, SIGNS, FENCING, ETC. SHALL BE ERECTED AROUND THE CONSTRUCTION AREA DURING ALL NON-WORKING HOURS TO ALERT PERSONS OF THE POTENTIAL DANGER ASSOCIATED WITH THE AREA UNDER CONSTRUCTION AS WELL AS TO PREVENT ACCESS BY UNAUTHORIZED PERSONNEL TO THE CONSTRUCTION SITE/AREA. THE CONTRACTOR IS RESPONSIBLE FOR ENSURING THE SAFETY OF THE GENERAL PUBLIC AS WELL AS ALL CONSTRUCTION PERSONNEL. PUBLIC STREETS SHALL BE KEPT CLEAN AND FREE OF DEBRIS (MUD, STONE, ETC.) AT ALL TIMES. THE CONTRACTOR SHALL ALERT ALL LOCAL EMERGENCY AGENCIES (FIRE, POLICE, AMBULANCE, ETC.) OF THE NATURE OF THE PROPOSED PROJECT PRIOR TO BEGINNING AND CONSTRUCTION ACTIVITY. ACCESS FOR EMERGENCY VEHICLES SHALL BE MAINTAINED AT ALL TIMES.

(E) UNDERGROUND UTILITIES:

THE LOCATIONS OF EXISTING UNDERGROUND UTILITIES SHOWN ON THE PLANS WERE OBTAINED BY FIELD OBSERVATIONS, FROM EXISTING RECORDS, AND/OR FROM THE OWNERS OF THE RESPECTIVE UTILITIES. THE INFORMATION AS SHOWN IS BELIEVED TO BE CORRECT; HOWEVER, THE COMPLETENESS AND ACCURACY OF THIS INFORMATION CANNOT BE GUARANTEED. THE CONTRACTOR SHALL BE RESPONSIBLE TO CONTACT ALL THE VARIOUS UTILITY COMPANIES (PUBLIC AND PRIVATE) TO VERIFY THE EXISTENCE, LIMITS AND/OR LOCATION OF ANY UTILITIES WHICH MAY BE ALONG THE ROUTE OR WITHIN THE VICINITY OF THIS IMPROVEMENT.

(F) UTILITY NOTIFICATION:

AT LEAST TWO WORKING DAYS PRIOR TO COMMENCING OPERATIONS ON THIS PROJECT, THE CONTRACTOR SHALL NOTIFY THE CITY ENGINEER, THE REGISTERED UTILITY PROTECTION AGENCY/SERVICE, AND THE OWNERS OF ANY OTHER UTILITIES (PUBLIC AND/OR PRIVATE) THAT MAY HAVE UTILITY LINES OR FACILITIES WITHIN THE VICINITY OF THIS PROJECT BUT WHO ARE NOT MEMBERS OF THE REGISTERED UTILITY PROTECTION SERVICE. THE OWNERS OF ANY UNDERGROUND UTILITY FACILITY SHALL, WITHIN 48 HOURS AFTER NOTICE IS RECEIVED, EXCLUDING SATURDAYS, SUNDAYS AND OTHER LEGAL HOLIDAYS; STAKE, MARK OR OTHERWISE DESIGNATE THE EXISTENCE AND/OR LOCATION OF THE UNDERGROUND UTILITY FACILITIES IN THE CONSTRUCTION AREA IN SUCH A MANNER AS TO INDICATE THEIR COURSE TOGETHER WITH THE APPROXIMATE DEPTH AT WHICH THEY WERE INSTALLED. THE MARKING AND/OR LOCATING SHALL BE COORDINATED TO STAY APPROXIMATELY TWO WORKING DAYS AHEAD OF THE PLANNED CONSTRUCTION.

OHIO UTILITIES PROTECTION SERVICE: 1-800-362-2764 (CONTACT NON-MEMBERS DIRECTLY).

THE PRIMARY UTILITIES WITHIN THE CITY OF CANTON AREA:

NATURAL GAS DIST./TRANS.
DOMINION EAST OHIO GAS
320 SPRINGSIDE DR., SUITE 320
AKRON, OHIO 44333
330-664-2409
ATTN: BRYAN DAYTON
RELOCATION@DOM.COM
EMERGENCY NO.
1-800-521-4400

TELEPHONE
AT&T
50 WEST BOWER STREET
AKRON, OHIO 44308
ATTN: RICH WILSON
330-384-2245
CINDY ZUCHEGNO
330-384-3561
EMERGENCY NO. - 24 HRS.
1-800-572-4545 OPTION#4

COMMUNICATIONS CABLE
TIME WARNER CABLE
5520 WHIPPLE AVE N.W.
NORTH CANTON, OHIO 44720
330-494-9200
ATTN: JUSTIN FREUDMAN
330-555-3192
330-472-4449 (CELL)

ELECTRIC
AMERICAN ELECTRIC POWER
301 CLEVELAND AVE. S.W.
P.O. BOX 24400
CANTON, OHIO 44701-4400
330-438-7718
ATTN: RAY ZITNEY
EMERGENCY No.
1-800-672-2017

SANITARY AND STORM SEWER
CITY ENGINEER'S OFFICE
2436-30TH ST. N.E.
CANTON, OHIO 44705
330-489-3381
ATTN: DAN MOEGLIN

WATER
WATER DEPARTMENT
2664 HARRISBURG RD. N.E.
CANTON, OHIO 44708
330-489-3310
ATTN: LEWI MILLER

TRAFFIC INTERCONNECT
CITY ENGINEER'S OFFICE
2436-30TH ST. N.E.
CANTON, OHIO 44705
330-489-3381
ATTN: NICK LOUKAS

THE CITY ENGINEER'S OFFICE IS TO BE CONTACTED DIRECTLY FOR SANITARY AND STORM SEWER AND TRAFFIC INTERCONNECT FACILITIES LOCATION: 330-489-3381.

(G) PROPOSED PUBLIC UTILITY LOCATION IN PROPOSED SUBDIVISIONS:

~~2.~~

(H) EXPLORATORY BORINGS:

EXPLORATORY SOIL BORING INFORMATION IS NOT THE RESPONSIBILITY OF THE CITY OF CANTON. IT IS THE DEVELOPER/CONTRACTOR RESPONSIBILITY TO REVIEW ANY AND ALL INFORMATION AVAILABLE. IF DEVELOPER/CONTRACTOR REQUESTS TO DRILL AND OR EXCAVATE WITHIN THE CITY'S R/W, THE DEVELOPER/CONTRACTOR SHALL NOTIFY THE CITY ENGINEER AT LEAST 3 WORKING DAYS PRIOR TO THIS WORK. THE DEVELOPER/CONTRACTOR SHALL BE RESPONSIBLE FOR ALL UTILITY NOTIFICATION, AS SPECIFIED, ALL TRAFFIC CONTROL, PREMIUM BACKFILL, AND COMPACTION AND RESTORATION, AS NECESSARY.

(I) CONTINGENCY QUANTITIES:

WHEN SPECIFIED ON PLANS OR SPECIFICATIONS, CONTINGENCY QUANTITIES ARE TO BE PERFORMED ONLY UNDER DIRECTION OF THE CITY ENGINEER. THE DEVELOPER/CONTRACTOR SHALL NOT ORDER ANY CONTINGENCY MATERIAL OR PERFORM ANY WORK UNTIL DIRECTED BY THE ENGINEER. THE ACTUAL WORK LOCATION AND QUANTITIES FOR SUCH ITEMS SHALL BE DOCUMENTED BY THE DEVELOPER/CONTRACTOR AND THE ENGINEER.

THE FOLLOWING ESTIMATED QUANTITIES HAVE BEEN INCLUDED IN THE GENERAL SUMMARY FOR USE AS DIRECTED BY THE ENGINEER:

ITEM 202 - CURB AND GUTTER REMOVED	250 FT
ITEM 609 - COMBINATION CURB AND GUTTER, TYPE 2	250 FT

II. CONSTRUCTION INCIDENTALS

(A) PLAN DISCREPANCIES:

ANY DISCREPANCIES FROM THE PLAN INFORMATION SHALL BE BROUGHT TO THE ATTENTION OF THE ENGINEER SO THAT THE APPROPRIATE ADJUSTMENTS IN ALIGNMENT AND/OR GRADE MAY BE MADE PRIOR TO THE START OF CONSTRUCTION OR THE CONTINUATION OF THE SAME.

FAILURE BY THE DEVELOPER/CONTRACTOR TO VERIFY AND/OR DETERMINE EXISTING INFORMATION AS INDICATED WILL RESULT IN THE CONTRACTOR BEING RESPONSIBLE FOR ANY CHANGES NECESSARY TO COMPLETE THE WORK SPECIFIED WITHOUT ADDITIONAL COMPENSATION.

(B) VERIFICATION OF UNDERGROUND UTILITIES:

THE DEVELOPER/CONTRACTOR SHALL BE RESPONSIBLE TO VERIFY THE EXISTENCE AS WELL AS THE ACTUAL LOCATION, ALIGNMENT, AND ELEVATIONS OF ALL EXISTING UTILITIES/FACILITIES WITHIN AND/OR ADJACENT TO THE GENERAL LIMITS OF THESE IMPROVEMENTS INCLUDING WATERLINES, SANITARY AND STORM SEWERS, GAS LINES, COMMUNICATION LINES/BANKS, ELECTRIC LINES, ETC. THIS MAY REQUIRE EXPLORATORY EXCAVATIONS TO BE PERFORMED BY THE CONTRACTOR FOR WHICH HE WILL NOT BE REIMBURSED. THE CONTRACTOR SHALL NOT ASSUME THAT EXISTING UTILITIES/CONDUITS WERE INSTALLED AT TYPICAL/STANDARD DEPTHS OR AT UNIFORM SLOPES/GRADES/DEPTHS BETWEEN ACCESS POINTS (CATCH BASINS, MANHOLES, JUNCTION CHAMBERS, ETC.)

WHERE PLANS PROVIDE FOR A PROPOSED CONDUIT TO BE CONNECTED TO, OR CROSS OVER OR UNDER AN EXISTING SEWER OR UNDERGROUND UTILITY, THE CONTRACTOR SHALL LOCATE THE EXISTING PIPES OR UTILITIES BOTH AS TO LINE AND GRADE BEFORE STARTING TO INSTALL THE PROPOSED CONDUIT.

(C) PROTECTION OF UTILITIES:

THE DEVELOPER/CONTRACTOR SHALL TAKE ALL PRECAUTIONS NECESSARY TO PROTECT AND SUPPORT EXISTING UTILITIES ENCOUNTERED DURING THE CONSTRUCTION OF THE PROPOSED IMPROVEMENTS AS APPROVED BY THE OWNERS OF THE UTILITY AND THE CITY ENGINEER.

THE DEVELOPER/CONTRACTOR SHALL BE RESPONSIBLE TO CLOSELY COORDINATE THEIR WORK WITH ALL UTILITY COMPANIES; ANY POTENTIAL DELAYS WILL NOT BE THE RESPONSIBILITY OF THE CITY.

THE CONTRACTOR SHOULD EXPECT AT A MINIMUM ONE SANITARY SEWER LATERAL, ONE ROOF DRAIN, ONE WATER SERVICE, AND ONE GAS SERVICE FOR EACH LOT. ANY OF THE ABOVE UTILITIES DAMAGED DUE TO THE CONTRACTOR'S WORK SHALL BE RESTORED TO THE UTILITY OWNER'S SATISFACTION AT THE CONTRACTOR'S EXPENSE, UNLESS OTHERWISE NOTED IN THE PLANS OR SPECIFICATIONS.

(D) MAINTENANCE OF UTILITY SERVICES:

THE CONTRACTOR SHALL BE RESPONSIBLE TO MAINTAIN UTILITY SERVICES AT ALL TIMES.

WATER SERVICE MAY BE INTERRUPTED FOR LIMITED PERIODS (4 HOURS MAXIMUM) DURING CONNECTION BETWEEN EXISTING WATER LINES AND RELOCATED/NEW WATER MAINS WHICH CANNOT BE COMPLETED OTHERWISE. NO SHUT DOWN SHALL OCCUR WITHOUT WRITTEN PERMISSION OF THE CITY OF CANTON WATER DEPARTMENT. PROPERTY OWNERS AFFECTED BY APPROVED INTERRUPTED SERVICE SHALL BE NOTIFIED 48 HOURS IN ADVANCE BY THE CONTRACTOR.

STORM SEWER AND SANITARY SEWER SERVICES SHALL BE MAINTAINED WITHOUT INTERRUPTION, UNLESS APPROVED BY THE CITY ENGINEER.

IN THE EVENT THAT CONSTRUCTION DISRUPTS THE FLOW OF A SANITARY SEWER, THE CONTRACTOR SHALL IMMEDIATELY RECTIFY THE DISRUPTED SEWER BY EITHER TEMPORARILY FLUMING WITH MATERIALS ACCEPTABLE TO THE ENGINEER OR BYPASSING WITH PUMPS. COST OF MAINTAINING AND REPAIR OF SANITARY SEWERS DISTURBED BY CONSTRUCTION SHALL BE AT THE CONTRACTOR'S EXPENSE, UNLESS OTHERWISE NOTED IN THE PLANS OR SPECIFICATIONS.

(E) CONSTRUCTION NOISE:

CONSTRUCTION NOISE ASSOCIATED WITH ANY IMPROVEMENT PROJECT SHALL BE LIMITED TO LEVELS COMMENSURABLE WITH ADJOINING LAND AND THEIR ASSOCIATED USAGE AS DETERMINED BY THE CITY ENGINEER. IN ORDER TO MINIMIZE ANY ADVERSE CONSTRUCTION NOISE IMPACTS, ANY POWER-OPERATED CONSTRUCTION-TYPE DEVICES SHALL NOT BE OPERATED BETWEEN THE HOURS OF 7:00 P.M. AND 7:00 A.M. UNLESS AUTHORIZED BY THE CITY ENGINEER.

(F) OPEN TRENCH CONSTRUCTION:

THE DEVELOPER/CONTRACTOR SHALL BE RESPONSIBLE FOR ALL EXCAVATION/TRENCHING PRACTICES FOR THE PROPOSED IMPROVEMENT, OR AS FURTHER SHOWN ON THE PLANS AND SPECIFICATIONS.

THE DEVELOPER/CONTRACTOR SHALL FOLLOW ALL APPLICABLE LOCAL AND STATE SAFETY REGULATIONS, INCLUDING CODE OF FEDERAL REGULATIONS, PART 1926 (SAFETY AND HEALTH REGULATIONS FOR CONSTRUCTION), SUBPART P (EXCAVATIONS), FOR ALL APPLICABLE REQUIREMENTS AND RESPONSIBILITIES.

PRIOR TO COMMENCING CONSTRUCTION, THE DEVELOPER/CONTRACTOR SHALL NOTIFY THE CITY ENGINEER OF THE PROJECT'S ASSIGNED "COMPETENT PERSON" IN OSHA EXCAVATION STANDARDS.

(G) TRENCH CLOSING AND TEMPORARY TOPPING:

THE DEVELOPER/CONTRACTOR SHALL BE RESPONSIBLE TO DETERMINE THE NECESSARY LEVELS OF PROTECTION AND SAFEGUARDING OF ALL OPEN TRENCHES, WHEN WORK IS EITHER COMPLETED AT THE END OF THE DAY OR SUSPENDED FOR ANY OTHER REASON.

~~2. FOR TRENCH SURFACE REQUIREMENTS, REFER TO NOTE 4 ON CITY STANDARD DRAWING NO. 19.~~

FOR TRENCH SURFACE REQUIREMENTS, REFER TO THE MISCELLANEOUS DETAILS.

(H) DUST CONTROL:

THE DEVELOPER/CONTRACTOR SHALL FURNISH AND APPLY WATER AND CALCIUM CHLORIDE FOR DUST CONTROL AS DIRECTED BY THE ENGINEER. SUFFICIENT QUANTITIES OF CALCIUM CHLORIDE SHALL BE STORED ON THE JOB SITE AT ALL TIMES TO BE USED FOR DUST CONTROL.

(I) TESTING OF UTILITIES: 3

(J) PRESERVATION AND RESTORATION OF DISTURBED FEATURES:

EXISTING DRIVES, BERMS, LAWNS, PAVEMENTS, CURBS, SIDEWALKS, SIGNS, MAILBOXES, FENCES, RETAINING WALLS, LANDSCAPING ITEMS, OR OTHER APPURTENANCES DISTURBED DURING CONSTRUCTION BUT NOT SPECIFICALLY DESIGNATED FOR REMOVAL/REPLACEMENT SHALL BE RESTORED BY THE DEVELOPER/CONTRACTOR AT HIS EXPENSE TO A CONDITION EQUAL TO OR BETTER THAN THAT WHICH EXISTED PRIOR TO DISTURBANCE AND TO THE COMPLETE SATISFACTION OF THE CITY ENGINEER.

RESTORATION OF EXISTING ROADWAYS SHALL BE IN ACCORDANCE WITH THE REQUIREMENTS OF THE CITY, TOWNSHIP, COUNTY, AND/OR OTHER AGENCIES HAVING AUTHORITY. COST FOR THE RESTORATION OF THESE ITEMS SHALL BE THE RESPONSIBILITY OF THE DEVELOPER/CONTRACTOR, UNLESS OTHERWISE SPECIFIED IN THE PLANS OR SPECIFICATIONS. NO PUBLIC ROADWAY SHALL BE DISTURBED WITHOUT PRIOR WRITTEN APPROVAL FROM THE GOVERNING AGENCY AND ACQUISITION OF NECESSARY PERMITS.

(K) SALVAGED CASTINGS:

WHEN DIRECTED BY THE CITY ENGINEER, ALL METAL CASTINGS SHALL BE CAREFULLY REMOVED AND STORED ON SITE OR DELIVERED TO A LOCATION DESIGNATED BY THE CITY ENGINEER.

(L) PLUG EXISTING CONDUIT: 3

THIS ITEM SHALL CONSIST OF THE CONSTRUCTION OF BULKHEADS IN AN EXISTING CONDUIT TO BE ABANDONED.

BULKHEADS SHALL CONSIST OF BRICK AND/OR CONCRETE MASONRY WITH A MINIMUM THICKNESS OF 12 INCHES.

PAYMENT FOR PLUGGING OF EXISTING CONDUIT FOR ABANDONMENT SHALL BE INCLUDED IN THE UNIT BID OF THE VARIOUS ITEMS OF THE PROJECT.

REVISIONS/COMMENTS:

- 1 ANY REFERENCE TO "THE CITY ENGINEER" WITHIN THE GENERAL NOTES SHALL MEAN THE CANTON WATER DEPARTMENT SUPERINTENDENT.
- 2 NOT APPLICABLE TO THIS PROJECT
- 3 REFER TO SECTION VIII. WATER MAIN/SERVICES

GENERAL NOTES

PROJECT NAME

Plans Prepared By
**The City of Canton
Water Department**
2664 Harrisburg Rd. N.E. • Canton, Ohio 44705
(330) 489-3310

N:\Water_d1\EngrDwg\Waterline Projects\Active\TAG 617_12th_Street_NW_WL_Rplc\DWGs\12th_St_BM.dwg 2/3/2021

II. CONSTRUCTION INCIDENTALS (continued)

(M) CONSTRUCTION LAYOUT:

THE DEVELOPER/CONTRACTOR SHALL BE RESPONSIBLE FOR ALL CONSTRUCTION LAYOUT UTILIZING PERTINENT PLAN DATA. THE CITY ENGINEER WILL NOT BE RESPONSIBLE FOR STAKING HORIZONTAL OR VERTICAL CONTROL. CONSTRUCTION LAYOUT SHALL BE IN ACCORDANCE WITH ODOT 623 CONSTRUCTION LAYOUT STAKES.

AT THE CITY ENGINEER'S REQUEST, THE CONTRACTOR SHALL MAKE AVAILABLE ALL SURVEY FIELD NOTES FOR REVIEW.

(N) EXISTING MONUMENTATION:

THE CONTRACTOR SHALL PRESERVE ALL CORNERSTONES, IRON PINS, CONCRETE MONUMENTS AND/OR ANY TYPE OF LAND MONUMENT. THE CONTRACTOR SHALL HAVE ALL MONUMENTS IN THE PROXIMITY OF THE WORK REFERENCED. THE CONTRACTOR SHALL REPLACE/RESET ANY DISTURBED OR DAMAGED MONUMENTS AND SHALL FURNISH A CERTIFICATION BY A REGISTERED SURVEYOR THAT THE MONUMENTS HAVE BEEN RESTORED.

(O) ELEVATION DATUM:

ALL ELEVATIONS ARE BASED ON THE **NAVD 1988 DATUM.**

(P) DEWATERING OPERATIONS:

WHEN DEEMED NECESSARY, THE DEVELOPER/CONTRACTOR MAY INSTALL DEWATERING EQUIPMENT PRIOR TO THE COMMENCEMENT OF CONSTRUCTION.

THE PROPOSED LOCATION OF WELL POINTS, HEADER PIPE, ELECTRICAL DISTRIBUTION, GENERATORS AND DISCHARGE PIPES, ETC. SHALL BE THE RESPONSIBILITY OF THE DEVELOPER/CONTRACTOR.

THE DEVELOPER/CONTRACTOR SHALL BE RESPONSIBLE FOR ALL PERMITS FOR THE INSTALLATION AND SUBSEQUENT REMOVAL OF DEWATERING EQUIPMENT AS WELL AS PROPER WATER DISCHARGE PROCEDURES AS MAY BE REQUIRED PER STATE AND LOCAL GOVERNING AGENCIES.

INSTALLATION OF ALL ELECTRICAL EQUIPMENT, INCLUDING GROUNDING AND PROTECTION SHALL BE THE RESPONSIBILITY OF THE DEVELOPER/CONTRACTOR.

DEVELOPER/CONTRACTOR SHALL PROVIDE ALL COMBUSTIBLE ENGINE DRIVEN GENERATORS WITH "HOSPITAL GRADE" MUFFLERS. MUFFLERS SHALL BE RATED, AT A MAXIMUM OF 67 dB AT 23 FEET AWAY RUNNING FULL LOAD.

(Q) INSPECTION:

FOLLOWING THE PRE-CONSTRUCTION MEETING(S) AND ESTABLISHMENT OF AN APPROVED SCHEDULE, THE CONTRACTOR SHALL GIVE A MINIMUM 48 HOUR NOTICE BEFORE STARTING ANY WORK ON THIS PROJECT AND SHALL KEEP THE CITY INFORMED OF HIS/HER CONSTRUCTION SCHEDULE. ALL WORK REQUIRED FOR THIS IMPROVEMENT SHALL BE SUBJECT TO INSPECTION BY THE CITY OF CANTON OR THEIR DESIGNATED REPRESENTATIVE. NO WORK SHALL BE PERFORMED WITHOUT AN AUTHORIZED INSPECTOR PRESENT, UNLESS OTHERWISE APPROVED.

(R) FIELD OFFICE:

IF A PAY ITEM IS PROVIDED, THE DEVELOPER/CONTRACTOR SHALL PROVIDE A FIELD OFFICE IN ACCORDANCE WITH ODOT 619. THE FIELD OFFICE SHALL BE TYPE 'A', UNLESS OTHERWISE SPECIFIED.

III. EARTHWORK / SITE WORK

(A) EASEMENTS AND RIGHT-OF-WAY:

THE DEVELOPER/CONTRACTOR SHALL STAY WITHIN THE DESIGNATED PROPERTIES, EASEMENTS, AND/OR RIGHT-OF-WAY PROVIDED FOR THE PROJECT AT ALL TIMES. NO MATERIAL SHALL BE STORED NOR ANY WORK PERFORMED ON PRIVATE PROPERTY UNLESS OTHERWISE APPROVED. DISTURBANCE OF EXISTING FEATURES AND/OR IMPROVEMENTS SHALL BE KEPT TO AN ABSOLUTE MINIMUM AND AS APPROVED BY THE CITY ENGINEER/PROPERTY OWNER.

(B) SUITABILITY OF SITE:

THE CITY OF CANTON SHALL NOT BE RESPONSIBLE FOR THE TYPE AND/OR SUITABILITY OF THE MATERIAL UNDERLYING THE PROJECT SITE. THE DEVELOPER/CONTRACTOR MUST APPRAISE THEMSELVES FOR ANY EXISTING SITE CONDITIONS WHICH MAY AFFECT THEIR BID OR THE PERFORMANCE OF THE REQUIRED WORK. THE DEVELOPER/CONTRACTOR SHALL PERFORM ANY INVESTIGATIONS AND/OR TESTING NECESSARY TO ADEQUATELY DETERMINE/ESTIMATE TO THEIR SATISFACTION ALL SITE CONDITIONS WHICH COULD AFFECT THE PERFORMANCE OF THE PROPOSED IMPROVEMENTS. THIS COULD INCLUDE, BUT NOT BE LIMITED TO, UNSUITABLE AND/OR UNSTABLE SOIL/SUBSURFACE CONDITIONS, ROCK, WATER (PERCHED OR FREE), SPRINGS, ETC.

(C) REMOVAL/REPLACEMENT OF UNSUITABLE MATERIAL:

THE DEVELOPER/CONTRACTOR SHALL UNDERCUT AND REPLACE UNSUITABLE MATERIAL ENCOUNTERED DURING INSTALLATION OF THE PROPOSED UTILITIES AND ROADWAY UNTIL SUCH CONDITIONS ARE CORRECTED AND APPROVED BY THE PROJECT ENGINEER.

THIS WORK SHALL BE INCLUDED IN THE BID PRICE FOR THE UTILITY UNLESS THE PLANS ALLOW FOR A CONTINGENCY ITEM FOR REMOVAL/REPLACEMENT OF UNSUITABLE MATERIAL. IF SO, THE CITY WILL DOCUMENT THE LOCATION OF SUCH AREAS FOR FINAL QUANTITY TABULATION.

IV. ROADWAY / DRIVE APPROACHES / WALK / CURB

(A) PAVEMENT STANDARDS:

SEE MISCELLANEOUS DETAILS

ANY PAVEMENT PLANING AS PART OF THE WATER MAIN TRENCH IS CONSIDERED INCIDENTAL TO THE WATER MAIN WORK. COMPENSATION FOR PAVEMENT PLANING IS FOR THE LIMITS OUTSIDE THE TRENCH PAY LIMITS ONLY.

(B) RESTRICTED WORK SCHEDULE:

NO CONCRETE FINISH WORK OR PERMANENT ASPHALT SHALL BE PLACED FROM NOVEMBER 15TH TO APRIL 15TH UNLESS WRITTEN APPROVAL IS GRANTED BY THE CITY ENGINEER.

(C) ASPHALT/CONCRETE:

IT SHALL BE THE RESPONSIBILITY OF THE DEVELOPER/CONTRACTOR TO NOTIFY THE ENGINEER 48 HOURS IN ADVANCE OF BEGINNING WORK WHICH REQUIRES COMPACTION TESTING AND/OR PRE-POUR INSPECTION PRIOR TO PLACEMENT OF ASPHALT OR CONCRETE. WORK SHALL NOT PROCEED UNTIL TESTING AND/OR INSPECTION HAS BEEN COMPLETED AND APPROVED BY THE CITY ENGINEER.

V. SANITARY SEWERS / STORM SEWERS

(A) SEWER STANDARDS:

ALL SANITARY/STORM SEWER CONDUITS AND APPURTENANCES SHALL BE CONSTRUCTED ACCORDING TO APPLICABLE CITY STANDARD DRAWINGS AND SPECIFICATIONS (LISTED BELOW) AND ODOT SPECIFICATIONS EFFECTIVE AT THE TIME OF CONSTRUCTION, UNLESS SPECIFIED OTHERWISE ON THE PLANS.

CITY STANDARD DRAWING NO.:

- CATCH BASINS**
- 1 "CURB INLET CATCH BASIN"**
- 2 "CURB INLET WATER QUALITY CATCH BASIN"**
- 3 "HILLSIDE CURB INLET CATCH BASIN"**
- 4 "SQUARE-TOP CATCH BASIN"**
- 5 "SQUARE-TOP WATER QUALITY CATCH BASIN"**

MANHOLES

- 10 "PRECAST STORM OR SANITARY MANHOLE"**
- 11 "OUTSIDE DROP CONNECTION FOR SANITARY MANHOLE"**
- 12 "MANHOLE COVER"**

CONDUITS AND TRENCHES

- 18 "HOUSE CONNECTION STACK"**
- 19 "UTILITY TRENCH REQUIREMENTS"**
- 20 "SANITARY SEWERS AND LATERALS"**
- 21 "CONCRETE ENCASEMENT DETAIL"**
- 22 "DOWNSPOUT OUTLET (NON-CURBED STREET)"**
- 23 "DOWNSPOUT OUTLET (CURBED STREET)"**
- 24 "GROUNDWATER DRAIN LINE CONNECTION"**

DRIVEWAYS, CURBS, AND PAVEMENT

- 32 "TYPICAL SECTION - LOCAL STREET"**

VI. STORM WATER POLLUTION PREVENTION:

(A) FOR PROJECTS ONE (1) ACRE OR MORE OF TOTAL LAND-DISTURBANCE:

THE OWNER/DEVELOPER SHALL APPLY FOR AND OBTAIN AN OHIO EPA NPDES PERMIT FOR STORM WATER DISCHARGES ASSOCIATED WITH CONSTRUCTION ACTIVITY. SAID PERMIT REQUIRES THE PREPARATION AND IMPLEMENTATION OF A STORM WATER POLLUTION PREVENTION PLAN (SWP3) TO ADDRESS CONSTRUCTION SITE STORM WATER RUNOFF AS WELL AS POST-CONSTRUCTION STORM WATER MANAGEMENT. THE SWP3 MUST BE REVIEWED AND APPROVED BY THE STARK COUNTY SOIL & WATER CONSERVATION DISTRICT (SWCD).

THE OWNER/DEVELOPER AND HIS REPRESENTATIVES SHALL COMPLY WITH ALL APPLICABLE REQUIREMENTS OF THE PERMIT AS WELL AS THE SWP3. ALL ACTIVITIES AND PRACTICES SHALL ALSO COMPLY WITH THE CURRENT EDITIONS OF THE CITY OF CANTON STORM WATER MANAGEMENT MANUAL AND THE OHIO DEPARTMENT OF NATURAL RESOURCES' RAINWATER AND LAND DEVELOPMENT MANUAL, AS APPLICABLE. SUCH PROJECTS ARE ALSO SUBJECT TO INSPECTION BY THE CITY OF CANTON AND/OR ITS AUTHORIZED REPRESENTATIVES (I.E. STARK SWCD) TO ENSURE COMPLIANCE WITH PERMIT AND SWP3 REQUIREMENTS AND LOCAL STORM WATER QUALITY REGULATIONS.

A PRE-CONSTRUCTION MEETING INITIATED BY THE DEVELOPER/CONTRACTOR IS REQUIRED ON-SITE WITH THE STARK SWCD PRIOR TO ANY LAND-DISTURBING ACTIVITIES. THE DEVELOPER/CONTRACTOR SHALL ABIDE BY ALL ORDERS ISSUED BY THE CITY AND/OR STARK SWCD PURSUANT TO INSPECTION OF THE PROJECT SITE.

IT IS THE CONTRACTOR'S RESPONSIBILITY TO SUBMIT CO-PERMITTEE APPLICATION TO OHIO EPA PRIOR TO BEGINNING WORK ON THE PROJECT. AS APPLICABLE, THE CONTRACTOR SHALL OBTAIN A COPY OF THE SWP3 AND FAMILIARIZE HIMSELF WITH IT, IMPLEMENTING ALL ITEMS AND ABIDING BY ALL PERMIT REQUIREMENTS AND REGULATIONS.

(B) FOR PROJECTS LESS THAN ONE (1) ACRE OF TOTAL LAND-DISTURBANCE:

AN EPA NPDES CONSTRUCTION STORM WATER PERMIT AND SWP3 IS NOT REQUIRED. HOWEVER, THE DEVELOPER/ CONTRACTOR SHALL STILL ENSURE THAT APPROPRIATE PRACTICES ARE IN PLACE TO PROVIDE CONSTRUCTION RUNOFF AND EROSION AND SEDIMENT CONTROLS WITHIN THE PROJECT LIMITS. SUCH PRACTICES MAY INCLUDE THE USE OF SILT FENCE, STORM DRAIN INLET PROTECTION, JUTE MATTING, TEMPORARY SEEDING, MULCHING, CHECK DAMS, CONSTRUCTION ENTRANCES, CONCRETE WASHOUT AREAS, ETC. ALL PRACTICES SHALL BE INSTALLED AND MAINTAINED IN ACCORDANCE WITH THE CURRENT EDITION OF THE OHIO DEPARTMENT OF NATURAL RESOURCES' RAINWATER AND LAND DEVELOPMENT MANUAL, AS APPLICABLE.

EROSION AND SEDIMENT CONTROL PRACTICES MUST BE INSTALLED PRIOR TO BEGINNING CONSTRUCTION ACTIVITY. THE CONTRACTOR SHALL BE RESPONSIBLE FOR CONTINUED INSPECTION AND MAINTENANCE OF ALL PRACTICES AND WILL BE HELD RESPONSIBLE FOR ADDRESSING ANY ON- OR OFF-SITE EROSION/SEDIMENT ISSUES RELATED TO THE PROJECT. THE OWNER/DEVELOPER/CONTRACTOR SHALL ABIDE BY ALL ORDERS ISSUED BY THE CITY PURSUANT TO INSPECTION OF THE PROJECT SITE.

VII. TRAFFIC:

(A) MAINTAINING TRAFFIC:

THE CONTRACTOR SHALL MAINTAIN TRAFFIC ADJACENT TO AND THROUGH THE PROJECT AS DESCRIBED BELOW AND IN ACCORDANCE WITH THE REQUIREMENTS OF THE OHIO DEPARTMENT OF TRANSPORTATION MANUAL OF CONSTRUCTION AND MATERIALS SPECIFICATIONS ITEM 614 MAINTAINING TRAFFIC. THE CONTRACTOR SHALL FURNISH, MAINTAIN, AND REMOVE ALL SIGNS, FLAGS, FLAGMEN, WATCHMEN, BARRICADES, SIGN SUPPORTS, CONES, BARRELS, AND INCIDENTALS IN CONFORMANCE WITH THE MOST RECENT REVISIONS OF THE CURRENT EDITION OF THE OHIO MANUAL OF UNIFORM TRAFFIC CONTROL DEVICES FOR STREETS AND HIGHWAYS. INTERFERENCE WITH VEHICULAR TRAFFIC SHALL BE KEPT TO A MINIMUM AT ALL TIMES. ALL OPEN TRENCHES AND EXCAVATIONS SHALL BE PROTECTED WITH DRUMS, BARRICADES, OR BARRIERS. ACCESS SHALL BE MAINTAINED AT ALL TIMES FOR EMERGENCY AND FIRE DEPARTMENT VEHICLES.

ANY TEMPORARY ROADWAY CLOSING MUST BE APPROVED IN WRITING BY THE CITY TRAFFIC ENGINEER AND ANY OTHER PUBLIC AGENCY HAVING JURISDICTION. THE CONTRACTOR SHALL NOTIFY THE TRAFFIC ENGINEER AT LEAST 72 HOURS IN ADVANCE OF ANY SUCH CLOSINGS FOR PUBLICATION AND EMERGENCY AGENCY NOTIFICATION.

ANY WORK WITHIN 100 FEET OF THE WHIPPLE AVE./12TH ST. NW INTERSECTION WILL REQUIRE A LAW ENFORCEMENT OFFICER FOR THE DURATION OF THE WORK.

(B) RESIDENTIAL AND BUSINESS AREAS:

THE CONTRACTOR SHALL MAINTAIN ACCESS TO LOCAL RESIDENCES AND BUSINESSES DURING CONSTRUCTION. IN THE EVENT A DRIVE ACCESS NEEDS TO BE CLOSED, THE CONTRACTOR SHALL GIVE NOTICE OF CLOSURE AND DURATION TO THE PROPERTY OWNER 24 HOURS IN ADVANCE. CONTRACTOR SHALL ARRANGE FOR ALTERNATE PARKING AND REASONABLE ACCESS FOR THOSE PROPERTY OWNERS AFFECTED BY DRIVE CLOSURES.

(C) EXISTING STREET NAME AND TRAFFIC CONTROL SIGNS:

WHERE WORK REQUIRES THE MOVEMENT OF EXISTING SIGNS (STOP SIGNS, SPEED LIMIT SIGNS, NO PARKING SIGNS, ETC.). THE CONTRACTOR IS REQUIRED TO MAINTAIN THE FUNCTION OF ALL TRAFFIC CONTROL SIGNS. ALL SIGNS REMOVED BY THE CONTRACTOR SHALL BE STORED ON SITE AND REINSTALLED BY THE CONTRACTOR.

(D) NEW STREET NAME & TRAFFIC CONTROL SIGNS:

~~ALL STREET NAME AND TRAFFIC CONTROL SIGNS SHALL COME COMPLETE AND BE MADE IN ACCORDANCE WITH THE CITY OF CANTON SIGN AND PAINT DEPARTMENT SPECIFICATIONS. GENERALLY, ALL SIGNS SHALL HAVE HI INTENSITY SHEETING AND BE MADE WITH .080 50/52 ALUMINUM. STREET NAME SIGNS SHALL BE MADE WITH WHITE UPPER AND LOWER CASE LETTERING ON GREEN BACKGROUND USING 9" BLANKS, BE DOUBLED SIDED W/RADIUS CORNERS AND HAVE 6" NAME AND 3" SUFFIXES. ALL SIGN RELATED HARDWARE IS TO BE INCLUDED, SUCH AS 6" HEAVY DUTY U-CHANNEL CAPS AND STREET NAME CROSSES.~~

~~FOR SUBDIVISION DEVELOPMENTS, ALL PERMANENT STREET NAME SIGNS AND TRAFFIC CONTROL SIGNS SHALL BE FURNISHED AND INSTALLED BY THE DEVELOPER/CONTRACTOR.~~

(E) EXISTING TRAFFIC SIGNALS:

WHERE WORK REQUIRES INTERFERENCE WITH EXISTING SIGNALIZATION IN THE INTERSECTIONS, ALL WORK SHALL BE COORDINATED THROUGH THE CITY ENGINEER. THE CONTRACTOR SHALL NOT ALTER ANY SIGNALIZATION WITHOUT THE CITY ENGINEER'S AUTHORIZATION.

(F) NEW TRAFFIC SIGNALIZATION:

~~ALL NEW OR MODIFIED TRAFFIC SIGNALIZATION AT INTERSECTIONS SHALL BE IN ACCORDANCE WITH CITY TRAFFIC ENGINEERING TRAFFIC CONTROL GENERAL NOTES AND ODOT SPECIFICATIONS; WITH SPECIAL EMPHASIS ON ODOT ITEMS 625, 632, 633, 732, AND 733 WHICH DEALS WITH TRAFFIC CONTROL.~~

(G) TRAFFIC CONTROL PLAN:

THE DEVELOPER/CONTRACTOR SHALL SUBMIT TO THE CITY ENGINEER A TRAFFIC CONTROL PLAN IN ACCORDANCE WITH CITY SUPPLEMENTAL SPECIFICATION 01-00. DETOURS, IF NECESSARY, SHALL BE APPROVED BY THE CITY ENGINEER PRIOR TO PLAN SUBMISSION.

REVISIONS/COMMENTS:

- 1** ANY REFERENCE TO "THE CITY ENGINEER" WITHIN THE GENERAL NOTES SHALL MEAN THE CANTON WATER DEPARTMENT SUPERINTENDENT.
- 2** NOT APPLICABLE TO THIS PROJECT
- 3** REFER TO SECTION VIII. WATER MAIN/SERVICES

GENERAL NOTES

12TH ST. NW WATER MAIN REPLACEMENT

Plans Prepared By
**The City of Canton
Water Department**
2664 Harrisburg Rd., N.E. • Canton, Ohio 44705
(330) 485-3310

VIII. WATER MAIN / SERVICES:

1. ALL WATER MAINS, SERVICES AND APPURTENANCES SHALL BE DESIGNED AND CONSTRUCTED ACCORDING TO THE CITY OF CANTON WATER DEPARTMENT REQUIREMENTS AND SPECIFICATIONS IN EFFECT AT THE TIME OF CONSTRUCTION. THE CONTRACTOR SHALL PROVIDE ALL LABOR, MATERIAL, EXCAVATION, BEDDING, BACKFILL, AND OTHER ITEMS NECESSARY FOR THE RELOCATION AND INSTALLATION OF THE WATER MAINS, SERVICES, AND APPURTENANCES. THESE COSTS SHALL BE INCLUDED IN THE UNIT PRICES BID FOR ALL THE ITEMS IN THE PROPOSAL.
2. MAINS – WATER MAINS SHALL BE CLASS 52 (8" AND UNDER), CLASS 53 (12") OR CLASS 54 (OVER 12") DUCTILE IRON, MEETING AWWA C151 WITH PUSH JOINTS. THE OUTSIDE SURFACE OF ALL DUCTILE IRON PIPE, FITTINGS AND APPURTENANCES SHALL BE SHOP COATED WITH EITHER ASPHALTIC MATERIAL. IF THE COATING MATERIAL IS FOUND TO BE DAMAGED PRIOR TO THE PIPE TRENCH BEING BACKFILLED, THE CONTRACTOR SHALL PROVIDE AN ADDITIONAL APPROVED MATERIAL AS REQUIRED TO REPAIR AS DIRECTED. THE CONTRACTOR SHALL HAVE SUFFICIENT COATING MATERIALS AVAILABLE AT THE JOB SITE PRIOR TO LAYING THE PIPE. THE INTERIOR OF ALL PIPES AND FITTINGS SHALL BE LINED WITH CEMENT MORTAR AND SEAL COATED IN COMPLETE CONFORMANCE WITH AWWA C104, OR THE LATEST REVISION.
3. ALL DUCTILE IRON PIPE, INCLUDING FITTINGS, BENDS, TEES, VALVES AND APPURTENANCES BURIED UNDERGROUND, SHALL BE ENCASED WITH 8 MIL. POLYETHYLENE FILM CONFORMING TO AWWA C105.
4. PLASTIC PIPE LARGER THAN 2" SHALL BE JM EAGLE, ULTRA BLUE PVCO AWWA C909 PRESSURE PIPE, PRESSURE CLASS 235, OR APPROVED EQUAL AND INSTALLED PER MANUFACTURER RECOMMENDATION.
5. WHEN PLASTIC PIPE IS USED, A TRACER WIRE SHALL BE INSTALLED ON TOP OF THE PIPE.
 - A. THE TRACER WIRE SHALL BE #14 AWG COPPER CLAD STEEL WIRE WITH 30 MILS OF HIGH-DENSITY POLYETHYLENE (HDPE) INSULATION.
 - B. THE TRACER WIRE SHALL BE INSTALLED IN A CONTINUOUS FASHION WITH THE WIRE ON TOP OF THE WATER MAIN AND SECURE TO THE MAIN EVERY FIVE (5) FEET WITH TAPE.
 - C. THE TRACER WIRE SHALL BE BROUGHT TO THE SURFACE AT EVERY VALVE BOX AND/OR AS CALLED OUT IN THE DRAWINGS. TRACER WIRE SHALL BE BROUGHT TO THE SURFACE AT LEAST EVERY ONE THOUSAND (1,000) FEET.
 - D. IF THE WIRE COATING GETS DAMAGED, REPAIR DAMAGED COATING WITH ELECTRICAL TAPE.
 - E. THE TRACER WIRE SHALL PASS A CONTINUITY TEST BEFORE THE WATERLINE INSTALLATION IS ACCEPTED.
6. THE MINIMUM COVER OVER WATER MAINS SHALL BE 4'-6" FROM GROUND SURFACE TO THE BARREL OF THE PIPE.
7. PIPE LENGTHS MAY BE DEFLECTED AT THE JOINT, IF REQUIRED, AT ONE-HALF THE DEGREE RECOMMENDED BY THE MANUFACTURER.
8. FITTINGS SHALL BE DUCTILE IRON AND BE RATED FOR 250 PSI WORKING PRESSURE IN ACCORDANCE WITH AWWA C110 OR AWWA C153. FITTINGS SHALL INCLUDE, BUT NOT LIMITED TO BENDS, TEES, SLEEVES, COUPLINGS, CROSSES, REDUCERS AND CAPS.
9. ANY FITTINGS OR VALVES ADJACENT TO A TEE OR CROSS SHALL BE ANCHORED TO THE TEE OR CROSS WITH EITHER THE USE OF AN ANCHOR TEE OR ANCHOR CROSS AND/OR ANCHOR COUPLINGS.
10. VALVES – THE ITEMS COVERED BY THIS SPECIFICATION SHALL MEET ALL APPLICABLE AWWA C509 OR C515 STANDARDS AND THE FOLLOWING: ALL VALVES SHALL BE NON-RISING STEM, IRON BODY, RESILIENT WEDGE DISC. THE DESIGN OF THE THRUST COLLAR SHALL BE SUCH THAT THE THRUST COLLAR IS SEALED FROM LINE PRESSURE BY MEANS OF AN "O" RING SEAL. ALL VALVES SHALL BE FURNISHED WITH A TWO (2) INCH SQUARE OPERATING NUT, OPEN RIGHT. ALL VALVES SHALL BE FURNISHED WITH MECHANICAL JOINT END CONNECTIONS. THE STEM SHALL BE PROTECTED FROM EXTERNAL GRIT BY A WEATHER SHIELD AND AN UPPER "O" RING. STEM SHALL BE LUBRICATED. GATE COATING SHALL HAVE A MINIMUM THICKNESS OF 10 MILS. VALVE SHALL BE TESTED AT THE RATED WORKING PRESSURE OF 250 PSI WITH NO LEAKAGE. SHELL TEST OF 500 PSI SHALL BE APPLIED TO BODY WITH VALVE IN THE OPEN POSITION WITH NO LEAKAGE THROUGH THE METAL, STEM SEALS OR JOINTS. VALVE MUST HAVE TRADITIONAL STUFFING BOX. ALL BOLTING MATERIAL IN THE THRUST COLLAR AND BONNET SHALL BE #316 SS BOLTS. ALL VALVES WITH ACCESSORIES PACK (FLANGES, RUBBERS, NUTS, BOLTS)
11. ALL VALVE BOXES SHALL BE HEAVY DUTY, THREE (3) PIECE SCREW TYPE, WITH "WATER" LIDS.
12. FLUSHING AND DISINFECTION OF WATER MAINS SHALL BE IN ACCORDANCE WITH AWWA C651.
13. ALL WATER LINE PRESSURE TESTING SHALL CONFORM TO AWWA C600.
14. WATER MAINS SHALL BE INSTALLED AND BACKFILLED PER O.D.O.T. ITEM 638.
15. WATER LINES LOCATED WITHIN THE LIMITS OF OR WITHIN A 1/2 TO 1 SLOPE OF EXISTING AND/OR PROPOSED ROADWAYS, PARKING AREAS, BUILDINGS, SIDEWALKS, AND/OR DRIVES SHALL BE INSTALLED AS TYPE B CONDUITS. ALL OTHER WATER MAINS SHALL BE INSTALLED AS TYPE C CONDUITS. BEDDING SHALL BE AS SPECIFIED, EXCEPT THAT SLAG WILL NOT BE PERMITTED.
16. ALL FITTINGS (BENDS, TEES, VALVES, DEAD ENDS, ETC.) SHALL BE RESTRAINED UTILIZING MEGALUGS, FIELD LOK GASKETS OR APPROVED EQUAL. POURED-IN-PLACE CONCRETE THRUST BLOCKS MAY ALSO BE REQUIRED AT/FOR EACH FITTING. THIS BLOCKING SHALL BE CAREFULLY PLACED TO ENSURE IT IS POSITIONED PROPERLY TO WITHSTAND THE RESULTANT FORCES AT EACH FITTING AND SHALL BEAR ON STABLE UNDISTURBED GROUND CAPABLE OF WITHSTANDING THE POTENTIAL LOADING. WHEN DIRECTED BY THE CITY, TIE RODS ARE TO BE 3/4 INCH DIAMETER. TWO TIE RODS ARE REQUIRED FOR AN 8 INCH PIPE, AND FOUR TIE RODS ARE REQUIRED FOR 12 INCH AND GREATER PIPE. THIS COST SHALL BE INCLUDED IN THE UNIT PRICE BID FOR THE FITTINGS.
17. IN ADDITION TO THE RESTRAINT OF ALL BENDS, FITTINGS, TEES, VALVES, DEAD ENDS, ETC. THE CONTRACTOR SHALL ALSO SECURE/RESTRAIN ALL JOINTS FOR AT LEAST THREE (3) PIPE JOINTS (50 LF MIN.) BEYOND EACH DEAD END, BEND, FITTING, VALVE, TEE, ETC. UTILIZING MEGALUGS, FIELD LOK GASKETS, OR APPROVED EQUALS. THIS COST SHALL BE INCLUDED IN THE UNIT PRICES BID FOR THE PIPE.
18. THE CONTRACTOR SHALL PROVIDE 18" VERTICAL CLEARANCE BETWEEN PROPOSED WATERLINES AND ANY SANITARY OR STORM SEWERS. WHEN 18" CLEARANCE CANNOT BE OBTAINED:
 - FOR STORM SEWERS, CONCRETE ENCASE THE STORM SEWER PIPE, 6 FT. ON EACH SIDE OF WATER MAIN.
 - FOR SANITARY SEWERS, REPLACE THE SANITARY SEWER PIPE WITH PVC C900 PIPE, 10 FT. ON EACH SIDE OF THE WATER MAIN. APPROVED COUPLINGS SHALL BE USED TO TIE ONTO THE EXISTING SEWER.
 THE CONTRACTOR SHALL MAINTAIN TEN (10) FOOT HORIZONTAL CLEARANCE BETWEEN WATERLINES/SERVICES AND SANITARY OR STORM SEWERS.
19. HYDRANTS – THE FIRE HYDRANT SETTING SHALL INCLUDE THE HYDRANT, ANCHOR TEE, VALVE, VALVE BOX, 6 INCH DUCTILE IRON (CLASS 52) PIPING AND ALL FITTINGS NEEDED FOR PROPER INSTALLATION TO FINAL GRADE. FIRE HYDRANTS SHALL BE MUELLER A423 MEETING THE CITY OF CANTON WATER DEPARTMENT STANDARDS AND REQUIREMENTS. ALL COSTS FOR THE 6" PIPING ASSOCIATED WITH THE INSTALLATION OF FIRE HYDRANTS SHALL BE INCLUDED WITH THE FIRE HYDRANT PAY ITEM. ALL HYDRANTS SHALL BE INSTALLED WITH THE PUMPER NOZZLE FACING THE STREET. ALL FIRE HYDRANT THREADS SHALL BE LUBRICATED WITH A FOOD GRADE LUBRICANT AND OPERATED UPON INSTALLATION.
20. CUT-IN SLEEVES FOR TIE-IN TO EXISTING WATER MAINS SHALL BE SMITH BLAIR 441 SLEEVES WITH #316 SS BOLTS.
21. ALL WATER TAPS AND SERVICES MUST BE INSTALLED BEFORE ANY PAVEMENT FOR THE PROPOSED ROADWAY HAS BEEN PLACED. THE CONTRACTOR SHALL MAKE ALL SERVICE TAPS ON THE WATER MAIN.
22. PRIOR TO MAKING THE TAP, THE CONTRACTOR SHALL EXPOSE THE EXISTING CURB BOX AND VERIFY THE SIZE OF THE WATER SERVICE LINE ON THE OWNER'S SIDE. THE PROPOSED TAP AND SERVICE SHALL MATCH THE SIZE OF THE OWNER'S SERVICE LINE, WITH 1" BEING A MINIMUM. AN EXISTING 1 1/4" SERVICE SHALL BE REPLACED WITH A 1 1/2" SERVICE AND TAP.
23. THE PROPOSED WATER SERVICES AND TAPS SHALL BE 1" UNLESS NOTED OTHERWISE ON THE PLANS OR DETERMINED OTHERWISE PER PREVIOUS NOTE.
24. ANY SERVICE TO THE FAR SIDE OF THE STREET SHALL BE PUSHED OR BORED UNDER THE PAVEMENT. TRENCHING ACROSS THE ROAD IS NOT PERMITTED.
25. THE CONTRACTOR SHALL TAKE ANY AND ALL NECESSARY PRECAUTIONS TO PROTECT AND MAINTAIN IN SERVICE, ANY EXISTING WATER MAINS AND/OR SERVICES EXPOSED DURING CONSTRUCTION. IF THE CONTRACTOR BREAKS A WATER MAIN AND/OR SERVICE, HE SHALL BE RESPONSIBLE TO REPAIR THE BREAK, AT HIS OWN EXPENSE, AND WILL NOT BE COMPENSATED FOR ANY DOWNTIME.
26. ANY WATER SERVICE LINE THAT IS BROKEN, CUT OR OTHERWISE DAMAGED, SHALL BE REPLACED FROM THE CORPORATION STOP TO THE CURB STOP WITH A SINGLE PIECE OF HDPE TUBING, CTS, PE4710. NO SPLICING OF THE SERVICE LINE WILL BE PERMITTED.
27. SERVICE BRANCHES WILL BE INSTALLED AS PER O.D.O.T ITEM 638.16, WITH THE FOLLOWING EXCEPTIONS:
 1. WHEN A SERVICE BRANCH IS DISTURBED FOR LOWERING, RAISING, EXTENDING OR SHORTENING ON THE PROPERTY SIDE ON THE SERVICE STOP, IT SHALL BE REPLACED WITH NEW MATERIALS FROM THE CORPORATION STOP TO THE SERVICE STOP.
28. POLYETHYLENE WATER MAIN AND SERVICE TUBING 2" AND UNDER SHALL BE COPPER TUBE SIZE, SDR 9, WITH A MINIMUM PRESSURE CLASS OF 200 PSI AND MEET STANDARDS ASTM-D2737 PE4710 AND AWWA C901. THE ACCEPTABLE TUBING IS CP CHEM PERFORMANCE PIPE DRISCOPLEX 5100-ULTRA-LINE, CHARTER PLASTICS INC. BLUE ICE, ENDOT ENDOPURE AND ADS POLYFLEX.
29. THE PROPOSED FACILITIES SHALL MAINTAIN A MINIMUM 35 PSI PRESSURE DELIVERED TO THE CURB STOP DURING NORMAL OPERATING CONDITIONS.
30. A MINIMUM PRESSURE OF 20 PSI AT GROUND LEVEL SHALL BE MAINTAINED AT ALL POINTS IN THE DISTRIBUTION SYSTEM UNDER ALL CONDITIONS OF FLOW.

31. BOOSTER PUMPS ARE NOT PERMITTED ON SERVICE CONNECTIONS.
32. WHEN AN EXISTING WATER MAIN MUST BE SHUT DOWN TO PERFORM REQUIRED WORK, THE CONTRACTOR SHALL NOTIFY THE PROPERTIES TO BE AFFECTED A MINIMUM OF 24 HOURS IN ADVANCE OF SAID SHUT DOWN. THE WORK WILL BE SCHEDULED AND COORDINATED TO MINIMIZE THE TIME THE MAIN IS OUT OF SERVICE.
33. THE CONTRACTOR SHALL NOTIFY THE CITY 48 HOURS IN ADVANCE OF ANY SHUT DOWN OF AN EXISTING MAIN. THE CONTRACTOR WILL NOT OPERATE ANY VALVES. VALVES WILL BE OPERATED BY CANTON WATER DEPARTMENT PERSONNEL ONLY. VALVES DAMAGED BY THE CONTRACTOR'S OPERATION WILL BE REPLACED AT THE CONTRACTOR'S EXPENSE.
34. ALL VALVE BOXES WILL BE ADJUSTED TO FINAL GRADE OF SURROUNDING PAVEMENT OR FINISHED SURFACE TREATMENTS WHEN THE PROJECT IS COMPLETED.
35. ANY DIGGING WITHIN THE RIGHT-OF-WAY OF ANY STREET REQUIRES A ROAD OPENING PERMIT. PLEASE CONTACT THE APPROPRIATE GOVERNMENTAL ENTITY FOR INFORMATION REGARDING THE PERMITTING PROCESS AND/OR FEES DUE.
36. THE CONTRACTOR SHALL REPLACE ANY TRAFFIC SIGNAL LOOP DETECTOR WIRE DAMAGED DURING THE WATERLINE INSTALLATION. THIS COST SHALL BE INCLUDED IN THE UNIT PRICES BID FOR ALL ITEMS IN THE PROPOSAL.
37. THE CONTRACTOR SHALL REPLACE ANY ROADWAY PAVEMENT MARKINGS DAMAGED OR REMOVED DURING THIS PROJECT. THE PAVEMENT MARKINGS SHALL BE PER THE GOVERNING AUTHORITY'S SPECIFICATIONS. THIS COST SHALL BE INCLUDED IN THE UNIT PRICES BID FOR ALL ITEMS IN THE PROPOSAL.
38. THE CONTRACTOR SHALL REPLACE ANY PRIVATE IRRIGATION SYSTEMS AND/OR UNDERGROUND ELECTRIC FENCES THAT ARE DAMAGED OR REMOVED DURING THE WATERLINE CONSTRUCTION. THIS COST SHALL BE INCLUDED IN THE UNIT PRICES BID FOR ALL ITEMS IN THE PROPOSAL.
39. VALVES THAT ARE CALLED OUT TO BE ABANDONED SHALL INCLUDE ALL LABOR, MATERIAL, AND EQUIPMENT NECESSARY TO ABANDON EXISTING WATER VALVES. THIS ITEM SHALL ALSO INCLUDE ANY NECESSARY EXCAVATION AND BACKFILL REQUIRED. VALVES SHALL BE CLOSED AND HAVE THE TOP 6" OF THE CASTING REMOVED. VALVES IN PAVEMENT SHALL BE FILLED WITH CONCRETE WITH THE TOP 6" MATCHING THE EXISTING PAVEMENT COMPOSITION. VALVES IN YARD AREA SHALL BE FILLED WITH SAND.
40. FIRE HYDRANTS THAT ARE CALLED OUT TO BE REMOVED SHALL INCLUDE ALL LABOR, MATERIAL AND EQUIPMENT NECESSARY TO REMOVE THE FIRE HYDRANT, HYDRANT VALVE AND PLUG THE HYDRANT TEE.
41. FOR WATERLINES CALLED OUT TO BE ABANDONED, THE CONTRACTOR SHALL PLUG AND ABANDON THE EXISTING WATERLINE WITH A DUCTILE IRON PLUG OR AS DIRECTED BY THE CANTON WATER DEPARTMENT.
42. REMOVAL OF ANY EXISTING THRUST BLOCKS WILL BE CONSIDERED INCIDENTAL TO THE OVERALL PROJECT COST.

IX. POST CONSTRUCTION INCIDENTALS

(A) AS-BUILT DRAWINGS: 

~~AS-BUILT REPRODUCIBLE MYLARS SHALL BE PROVIDED TO THE CITY OF CANTON BY THE DESIGN ENGINEER AT THE COMPLETION OF THE PROJECT. AS-BUILT INFORMATION CONSISTS OF POST CONSTRUCTION FIELD SURVEY DATA OF THE LOCATION, FLOWLINE ELEVATIONS, AND TOP OF GRATE/RIM ELEVATIONS FOR ALL STORM AND SANITARY STRUCTURES CONSTRUCTED AND/OR IMPACTED BY THE PROJECT.~~

~~FOR PRIVATE PROJECTS, THE CONSTRUCTION BOND WILL NOT BE RELEASED UNTIL THE AS-BUILT DRAWINGS HAVE BEEN ACCEPTED.~~



(B) PROPOSED MONUMENTATION:

THE DEVELOPER'S/CONTRACTOR'S SURVEYOR SHALL NOTIFY THE CITY ENGINEER IN WRITING UPON THE COMPLETION OF MONUMENTS BEING SET AS PER PLAN OR RECORD PLAT.

(C) RELEASE OF RETAINER/BONDS:

PRIOR TO THE RELEASE OF RETAINER/CONSTRUCTION BOND BY THE CITY OF CANTON, THE CONTRACTOR SHALL HAVE COMPLETED THE ENGINEER'S PROJECT PUNCHLIST AND SUBMIT FINAL WAIVER OF LIEN, IN ACCORDANCE WITH CITY SS 01-00.

REVISIONS/COMMENTS:

-  ANY REFERENCE TO "THE CITY ENGINEER" WITHIN THE GENERAL NOTES SHALL MEAN THE CANTON WATER DEPARTMENT SUPERINTENDENT.
-  NOT APPLICABLE TO THIS PROJECT
-  REFER TO SECTION VIII. WATER MAIN/SERVICES

GENERAL NOTES

12TH ST. NW WATER MAIN REPLACEMENT

Plans Prepared By
**The City of Canton
Water Department**
2664 Harrisburg Rd., N.E. • Canton, Ohio 44705
(330) 486-3310

N:\Water_d1\EngrDwgs\Waterline Projects\Active\TAG 617_12th_Street_NW_WL_Rplc\DWGs\12th St_BM.dwg 2/3/2021

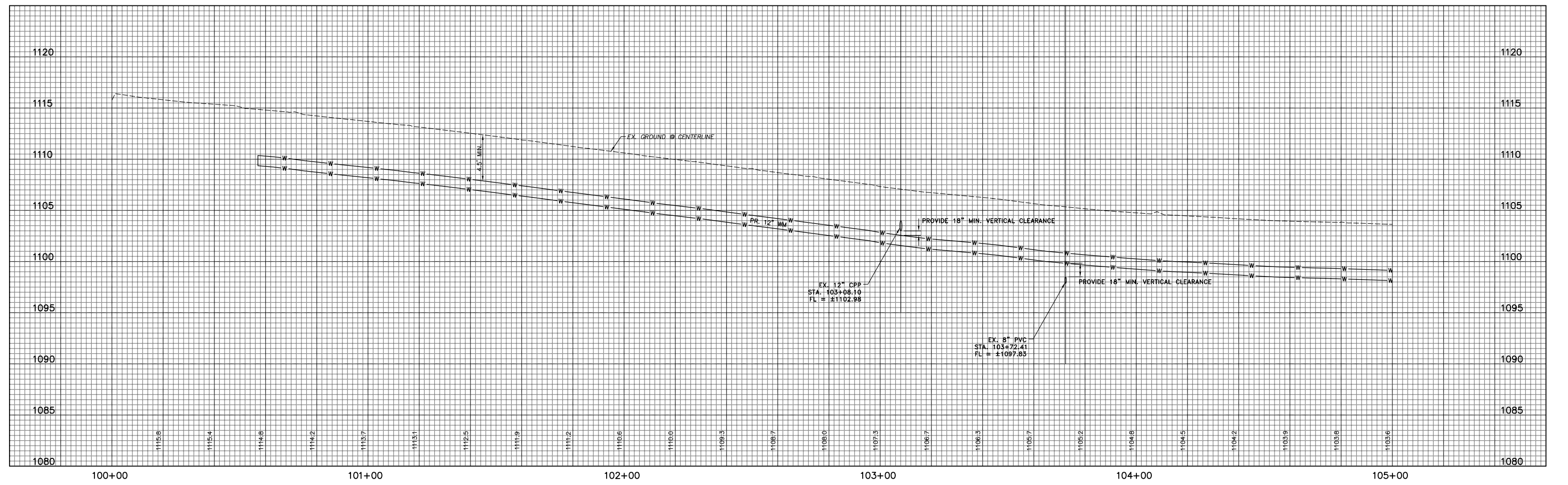
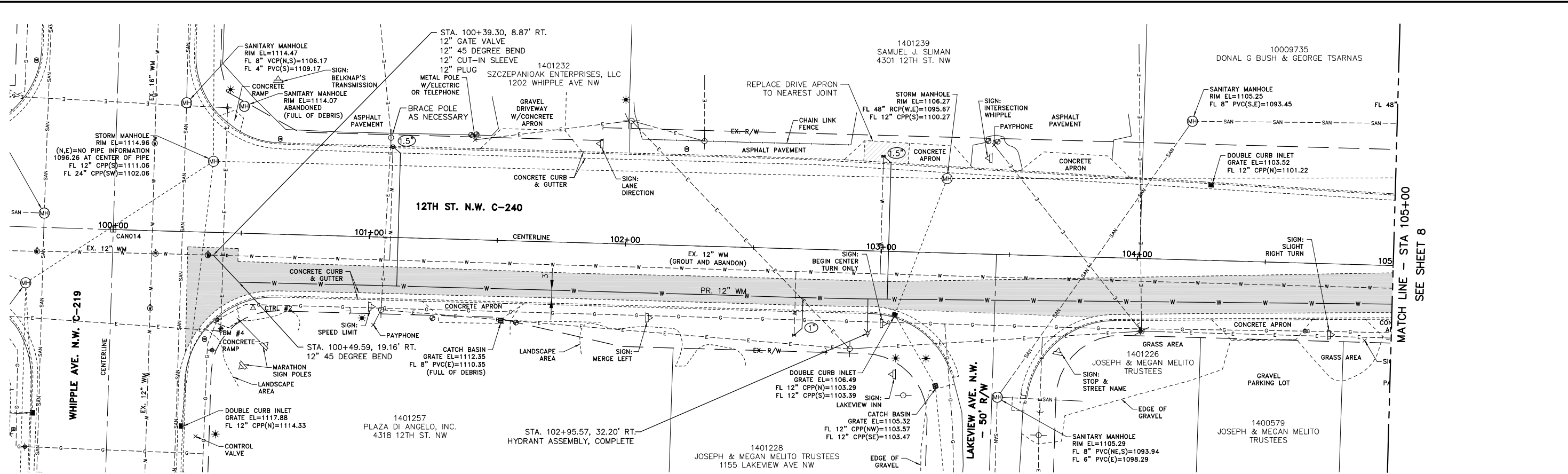

PLAN AND PROFILE - 12TH ST. NW
STA. 100+00 TO STA. 105+00

12TH ST. NW WATER MAIN
REPLACEMENT

Plans Prepared By
The City of Canton
Water Department
2664 Harrisburg Rd., N.E. • Canton, Ohio 44705
(330) 485-3310

7
11

CALCULATED: DGP
CHECKED: BDB

0 10 20 40
HORIZONTAL SCALE
IN FEET

N:\Water_d1\EngrDwg\Waterline Projects\Active\TAG 617_12th_Street_NW_WL_Rplc\DWGs\12th St_BM.dwg 2/3/2021

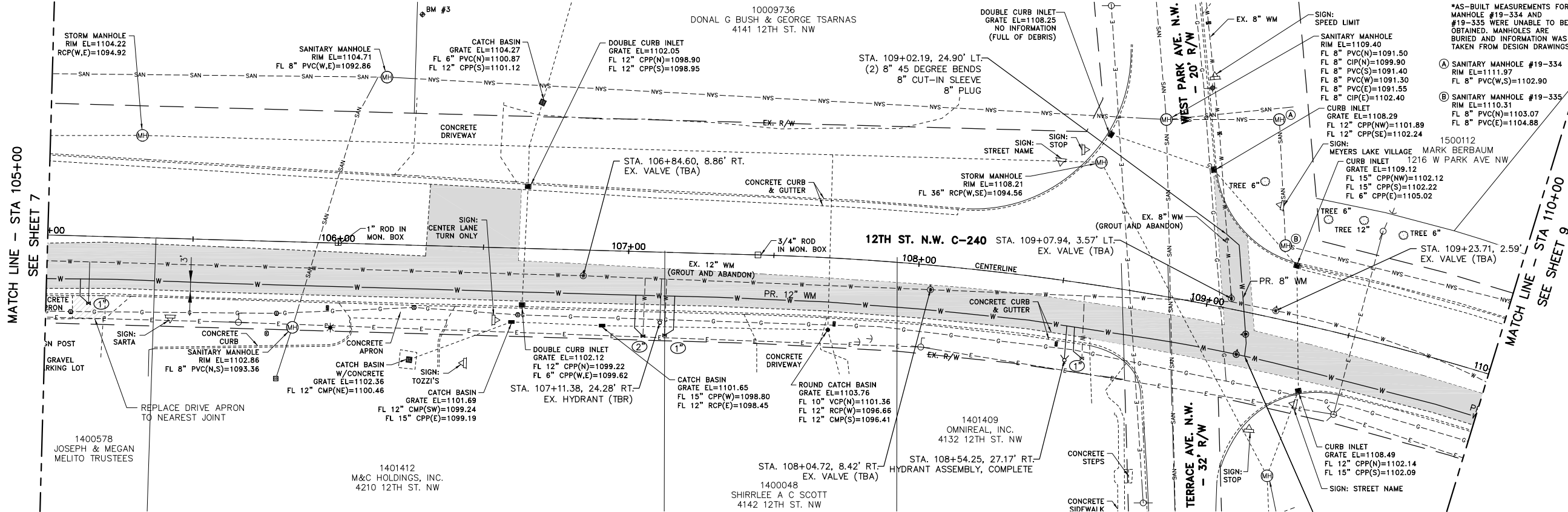

MATCH LINE - STA 105+00
SEE SHEET 7

MATCH LINE - STA 110+00
SEE SHEET 9

*AS-BUILT MEASUREMENTS FOR MANHOLE #19-334 AND #19-335 WERE UNABLE TO BE OBTAINED. MANHOLES ARE BURIED AND INFORMATION WAS TAKEN FROM DESIGN DRAWINGS.

① SANITARY MANHOLE #19-334
RIM EL=1111.97
FL 8" PVC(W,S)=1102.90

② SANITARY MANHOLE #19-335
RIM EL=1103.07
FL 8" PVC(N)=1103.07
FL 8" PVC(E)=1104.88

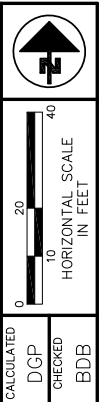

PLAN AND PROFILE - 12TH ST. NW
STA. 105+00 TO STA. 110+00

12TH ST. NW WATER MAIN
REPLACEMENT

Plans Prepared By
The City of Canton
Water Department
2664 Harrisburg Rd., N.E. • Canton, Ohio 44705
(330) 485-3310

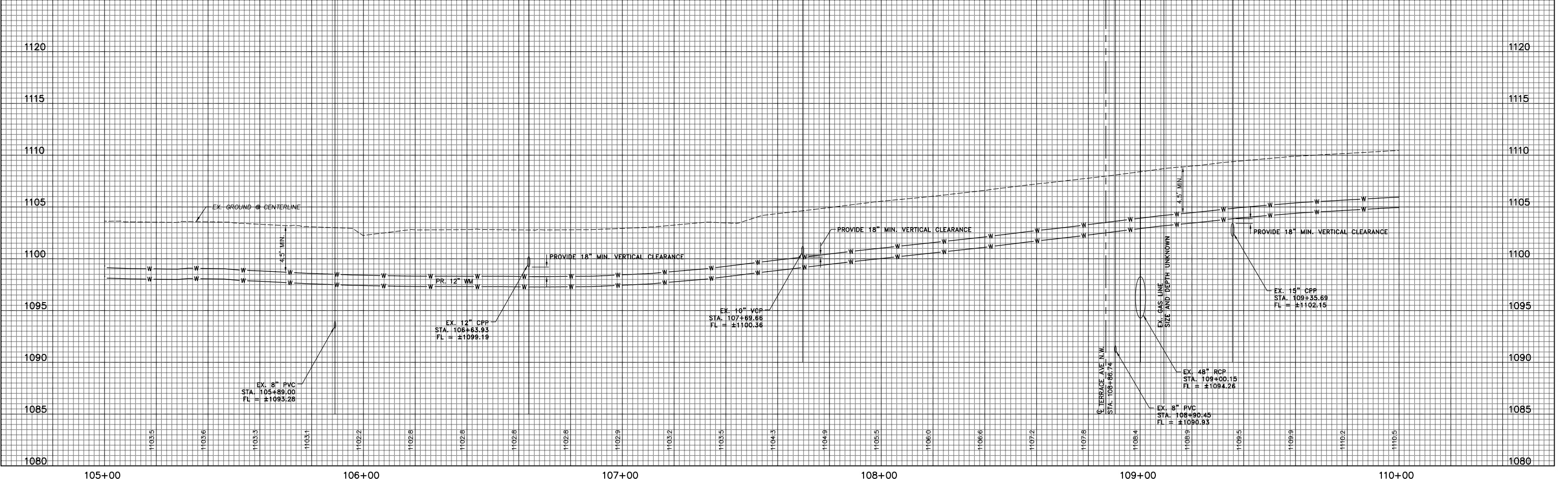

N:\Water_d1\EngrDwgs\Waterline Projects\Active\TAG 617_12th Street NW WL Rplc\DWGs\12th St_BM.dwg 2/3/2021

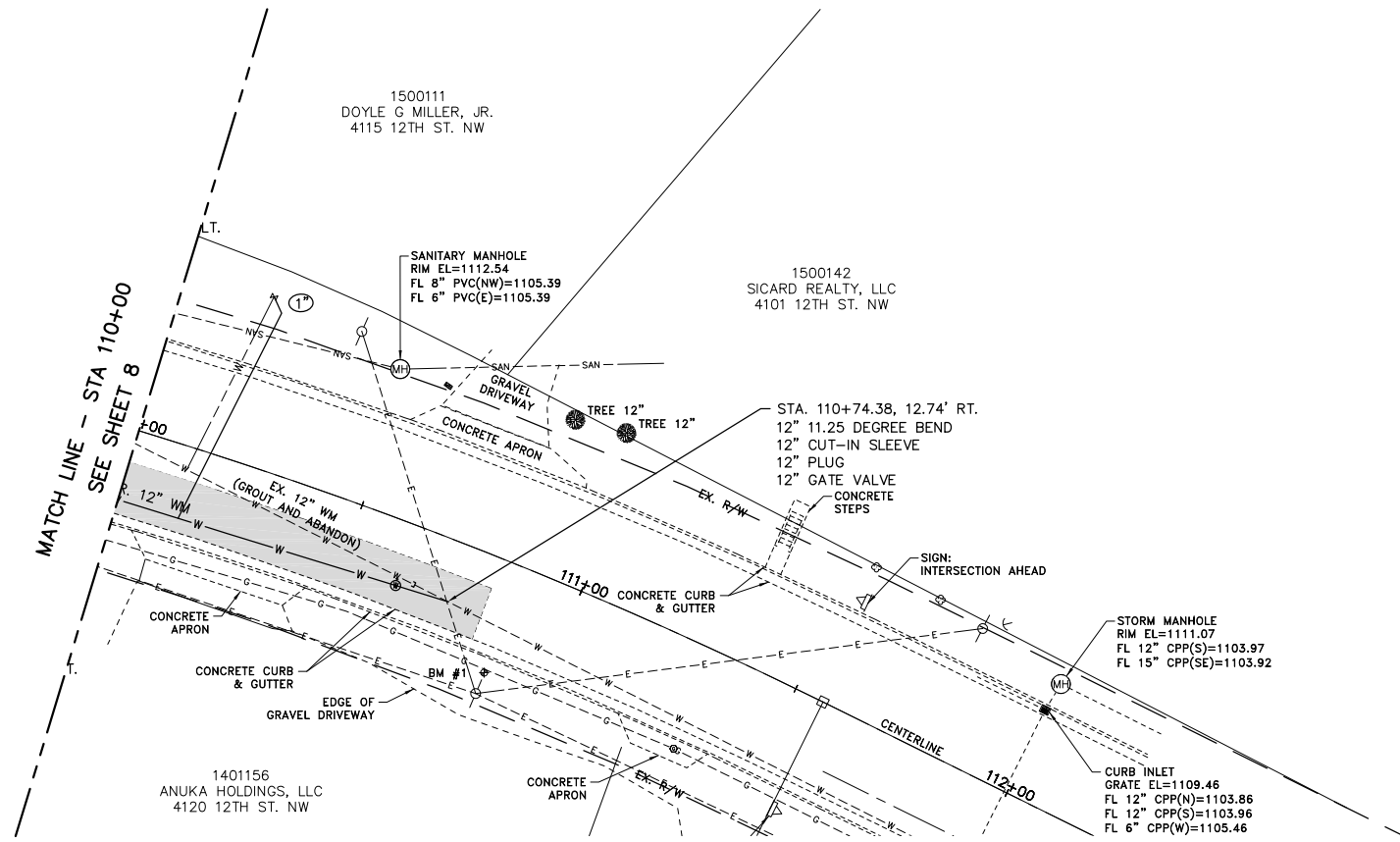

HORIZONTAL SCALE
 IN FEET

CALCULATED: DGP
 CHECKED: BDB
 PLAN AND PROFILE - 12TH ST. NW
 STA. 110+00 TO STA. 112+00

12TH ST. NW WATER MAIN
 REPLACEMENT

Plans Prepared By
The City of Canton
Water Department
 2664 Harrisburg Rd., N.E. • Canton, OH 44705
 (330) 485-3310

ALL FITTINGS ON THE HYDRANT SETTING SHALL BE RESTRAINED UTILIZING MAGALUGS, FIELD LOK GASKETS, OR APPROVED EQUALS.

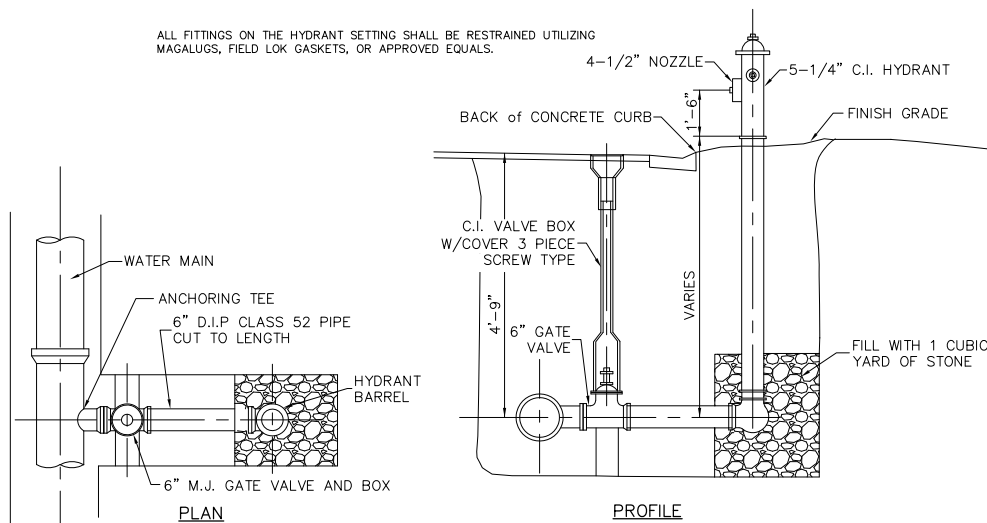

HYDRANT SETTING

(C71)

REV 4/6/1989

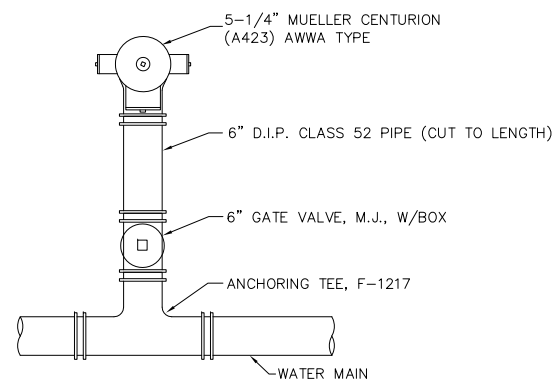

HYDRANT SETTINGS CONSIST OF HYDRANT, VALVE, VALVE BOX, FITTINGS AND MATERIALS SHOWN OR SPECIFIED WHICH ARE NEEDED FOR PROPER INSTALLATION.

SEE SPECIFICATIONS FOR MORE INFORMATION ABOUT MATERIALS, SETTING HYDRANTS AND DRAINAGE REQUIREMENTS.

IF RESTRAINED JOINT FITTINGS CANNOT BE USED, (2) TIE RODS AND (4) EYE BOLTS WITH NUTS AND WASHERS MUST BE USED.

FIGURES SUCH AS F-1217 INDICATE CLOW CORPORATION STYLES. USE THIS BRAND OR APPROVED EQUAL.

ALL HYDRANTS ARE TO BE INSTALLED WITH THE PUMPER NOZZLE FACING THE STREET.

HYDRANT CONNECTION

(C70)

REV 4/5/1989

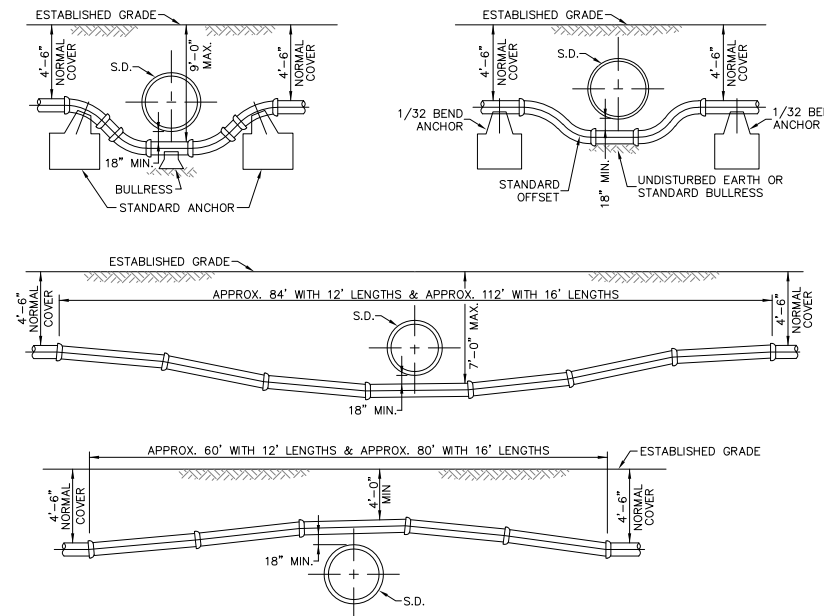

WATER MAIN CROSSING STORM DRAIN

(C187)

REV 10/22/2013

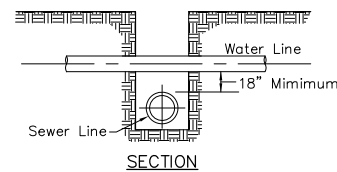

VERTICAL WATER MAIN CLEARANCE

(C186)

REV 5/26/1994

- NOTES:
- If joint on water main is within limits of sewer trench, install mechanical bell joint clamp
 - If clearance is less than 18":
 - For Storm sewers, concrete encase the storm sewer pipe, 6 ft. on each side of water main.
 - For Sanitary sewers, replace the sanitary sewer pipe with PVC C900 pipe, 10 ft. on each side of water main. Approved couplings shall be used to tie onto the existing sewer. Cost for the above shall be included in the unit prices bid for all items in the proposal.
 - In no case shall the sewer pipe contact any water main, service line or appurtenance.

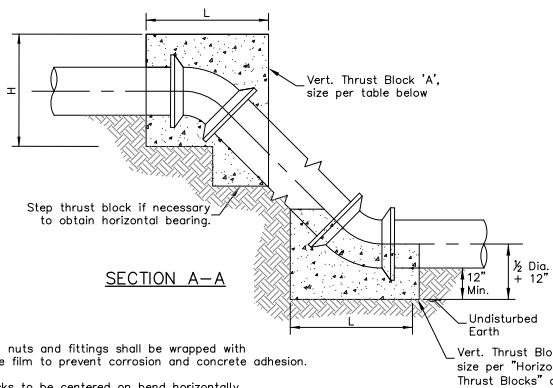
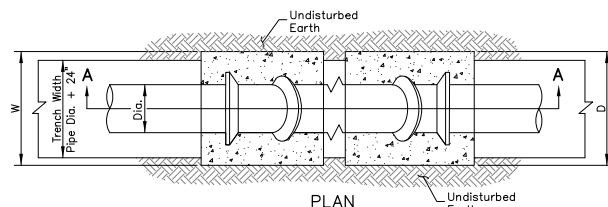

NOTES:

Pipe, bolts, nuts and fittings shall be wrapped with polyethylene film to prevent corrosion and concrete adhesion.

Thrust blocks to be centered on bend horizontally.

Thrust block 'A' shall be off centered on bend vertically to shift the majority of the block above the fitting.

All joints to be Megalugged.

Concrete thrust blocks to be placed on all vertical bends.

SIZE OF PIPE	DEGREE OF BEND											
	11 1/4°				22 1/2°				45°			
	L	W	H	V (cy)	L	W	H	V (cy)	L	W	H	V (cy)
6"	12	48	18	0.2	15	43	36	0.5	28	55	24	0.8
8"	12	63	24	0.4	18	57	34	0.7	36	57	33	1.4
12"	20	54	36	0.8	37	62	37	1.7	48	62	51	3.1
16"	31	65	38	1.6	55	65	39	3.0	65	65	65	5.6
20"	40	56	50	2.4	57	66	59	4.8	82	74	68	8.8
24"	48	60	60	3.5	67	72	66	6.9	91	91	72	12.7

CONCRETE THRUST BLOCKS FOR VERTICAL BENDS ON WATER MAINS

(POURED IN PLACE, CLASS C)

(C147)

REV 4/22/2015

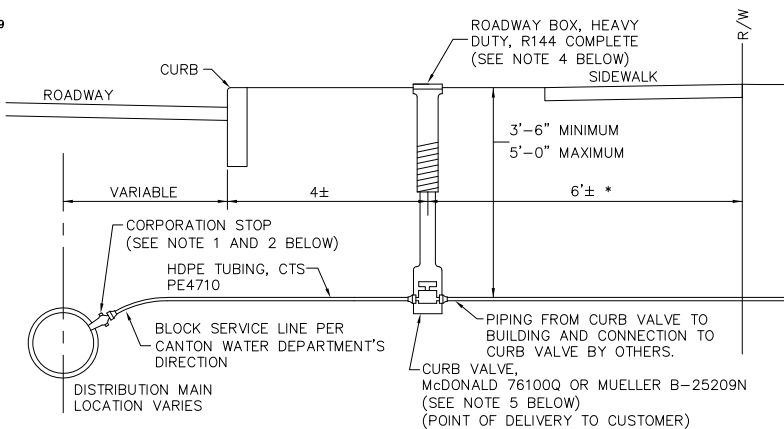

NOTES:

- A 1" SERVICE ON A 6" OR 8" MAIN SHALL CONSIST OF A 3/4" TAP WITH A 3/4" X 1" CORP.
- CORPORATION STOP AND ASSEMBLY SHALL BE AS FOLLOWS:
 - 3/4" X 1" CORP. STOP ON DIP (6" AND 8" MAINS): INSTALL AT THE 2:00 POSITION, A MUELLER B-25008 CORPORATION STOP WITH A COMPRESSION CONNECTION.
 - 3/4" X 1" CORP. STOP ON PVC C909 (6" AND 8" MAINS): INSTALL AT THE 2:00 POSITION, A MUELLER B-25008 CORPORATION STOP WITH A COMPRESSION CONNECTION AND A FORD, STAINLESS STEEL, EPOXY COATED TAPPING SADDLE (FC202 STYLE).
 - 1" CORP. STOP ON DIP (MAINS 12" AND UP): INSTALL AT THE 2:00 POSITION, A MUELLER B-25008 CORPORATION STOP WITH A COMPRESSION CONNECTION.
 - 1" CORP. STOP ON PVC C909 (MAINS 12" AND UP): INSTALL AT THE 2:00 POSITION, A MUELLER B-25008 CORPORATION STOP WITH A COMPRESSION CONNECTION AND A FORD, STAINLESS STEEL, EPOXY COATED TAPPING SADDLE (FC202 STYLE).
 - 1 1/2" CORP. STOP (ALL MAIN SIZES): INSTALL AT THE 2:00 POSITION, A MUELLER B-25008 CORPORATION STOP WITH A COMPRESSION CONNECTION AND A FORD, STAINLESS STEEL, EPOXY COATED TAPPING SADDLE (FC202 STYLE).
 - 2" CORP. STOP (ALL MAIN SIZES): INSTALL AT A 45° ANGLE, A MUELLER H-10003 CORPORATION STOP WITH 2" IRON TOP, A STANDARD NO LEAD BRASS 45° ELBOW AND A MUELLER H-15428 COMPRESSION MALE WITH INSERT COUPLING. ASSEMBLY SHALL ALSO CONSIST OF A FORD, STAINLESS STEEL, EPOXY COATED TAPPING SADDLE (FC202 STYLE).
- A SERVICE CLAMP MUST BE USED WHEN THE MAIN SIZE IS 2 INCH OR SMALLER.
- HEAVY DUTY VALVE BOXES, COMPLETE, MUST BE USED IN PLACE OF ROADWAY BOXES WHEN THE CURB VALVE IS LOCATED IN ROADWAYS OR ASPHALT DRIVES.
- WHEN CONNECTING A NEW 1" SERVICE TO AN EXISTING 3/4" SERVICE, THE CURB VALVE SIZE SHALL BE A 1" X 3/4" REDUCING CURB VALVE.
- BRASS REDUCING BUSHINGS OR SWIVEL ELLS WILL NOT BE ALLOWED.
- APPROVED EQUALS MAY BE USED IN PLACE OF SPECIFIED ITEMS.

TYPICAL WATER SERVICE

(C94)

REV 10/16/2020

HORIZONTAL THRUST BLOCKS

(C130)

REV 3/7/2016

SIZE OF PIPE	DEGREE OF BEND							
	11 1/4°		22 1/2°		45°		90°	
	L	H	L	H	L	H	L	H
6"	16	8	16	10	24	14	32	18
8"	16	10	21	14	31	18	44	24
12"	21	16	32	20	48	26	66	36
16"	29	20	42	28	66	34	90	46
20"	37	24	50	36	73	48	107	60
24"	46	28	64	40	93	54	128	72

CALCULATED
DGP
CHECKED
BDB

WATERLINE DETAILS

12TH ST. NW WATER MAIN REPLACEMENT

Plans Prepared By
The City of Canton
Water Department
2664 Harrisburg Rd., N.E. • Canton, Ohio 44705
(330) 485-3310

10
11

N:\Water_d1\EngrDwgs\Waterline Projects\Active\TAG 617_12th Street NW WL Rplc\DWGs\12th St_BM.dwg 2/3/2021

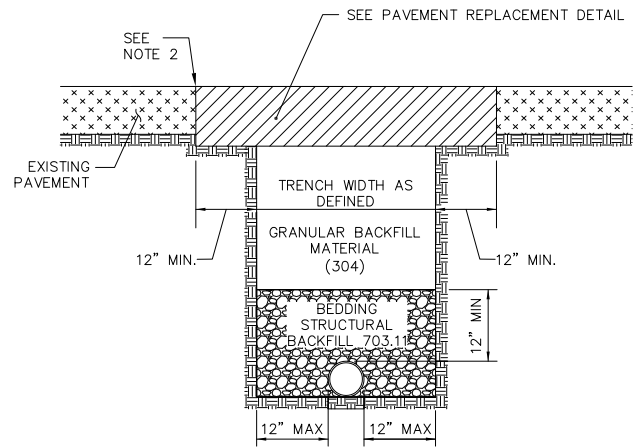

- NOTES:
1. NO FOUNDRY SAND OR SLAG IS PERMITTED. ALTERNATE BACKFILL MATERIAL PERMITTED ONLY IF APPROVED BY CITY ENGINEER.
 2. SAW CUT EXISTING PAVEMENT, SEAL JOINT PER ODOT ITEM 423 - CRACK SEALING, TYPE IV. INCLUDE COST IN BID PRICE FOR THE PROPOSED PAVEMENT.
 3. IF ADJACENT PAVEMENT IS DAMAGED OR UNDERMINED DURING CONSTRUCTION, ADDITIONAL PAVEMENT SHALL BE SAW CUT AND REMOVED IN ORDER TO PROVIDE A SOUND PAVEMENT EDGE.
 4. IN THE EVENT THAT THE SAW CUT WOULD LIE WITHIN 3 FEET OF THE EDGE OF PAVEMENT OR FACE OF CURB, THE PAVEMENT REPLACEMENT SHALL EXTEND TO THE EDGE OF PAVEMENT OR FACE OF CURB.

TRENCH DETAIL FOR D.I.P.

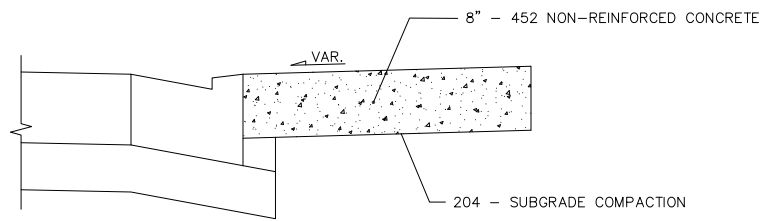

DRIVE APRON REPAIR DETAIL - CONCRETE

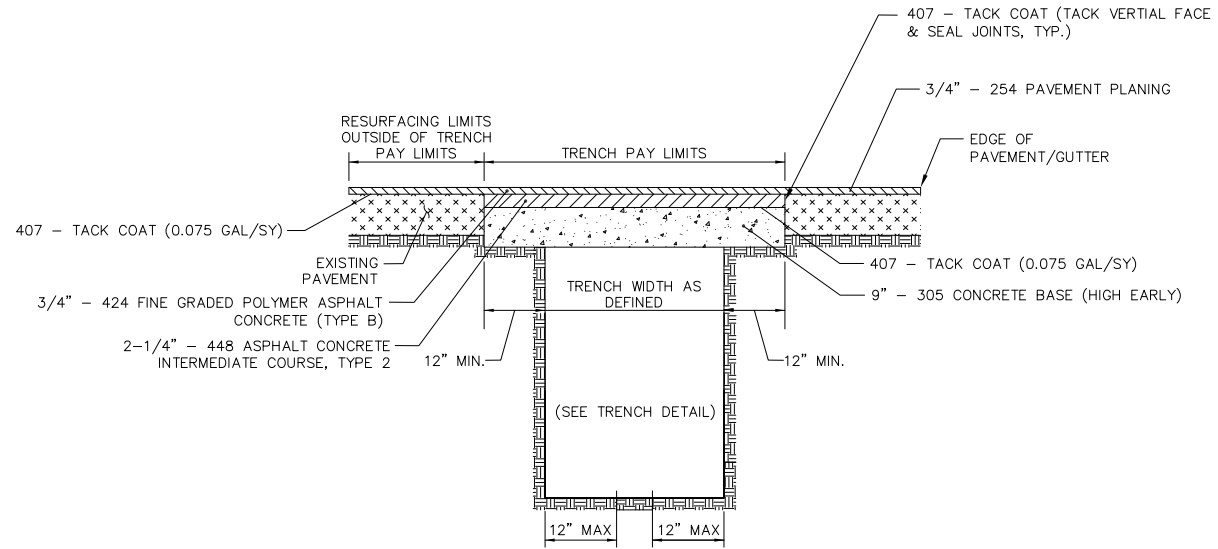

PAVEMENT REPLACEMENT DETAIL

Appendix D

Title VI Requirements

The City of Canton, in accordance with the provisions of Title VI of the Civil Rights Act of 1964 (78 Stat.252, 42 U.S.C. §§ 2000d to 2000d-4) and the Regulations, hereby notifies all bidders that it will affirmatively ensure that any contract entered into pursuant to this advertisement, disadvantaged business enterprises will be afforded full and fair opportunity to submit bids in response to this invitation and will not be discriminated against on the grounds of race, color, or national origin in consideration for an award.

No person in the United States shall, on the grounds of race, color, or national origin, be excluded from participation in, be denied the benefits of, or be otherwise subjected to discrimination under any program or activity, for which the Recipient receives Federal financial assistance from DOT, including the City of Canton.

Please also review Appendix A, Appendix C, Appendix D and Appendix E of the Standard Assurances which are included in the following pages.

APPENDIX A

During the performance of this contract, the contractor, for itself, its assignees, and successors in interest (hereinafter referred to as the "contractor") agrees as follows:

1. **Compliance with Regulations:** The contractor (hereinafter includes consultants) will comply with the Acts and the Regulations relative to Non-discrimination in Federally-assisted programs of the U.S. Department of Transportation, *The City of Canton*, as they may be amended from time to time, which are herein incorporated by reference and made a part of this contract.
2. **Non-discrimination:** The contractor, with regard to the work performed by it during the contract, will not discriminate on the grounds of race, color, or national origin in the selection and retention of subcontractors, including procurements of materials and leases of equipment. The contractor will not participate directly or indirectly in the discrimination prohibited by the Acts and the Regulations, including employment practices when the contract covers any activity, project, or program set forth in Appendix B of 49 CFR Part 21. *{Include City of Canton specific program requirements.}*
3. **Solicitations for Subcontracts, Including Procurements of Materials and Equipment:** In all solicitations, either by competitive bidding, or negotiation made by the contractor for work to be performed under a subcontract, including procurements of materials, or leases of equipment, each potential subcontractor or supplier will be notified by the contractor of the contractor's obligations under this contract and the Acts and the Regulations relative to Non-discrimination on the grounds of race, color, or national origin. *{Include City of Canton specific program requirements.}*
4. **Information and Reports:** The contractor will provide all information and reports required by the Acts, the Regulations, and directives issued pursuant thereto and will permit access to its books, records, accounts, other sources of information, and its facilities as may be determined by the Recipient or *The City of Canton* to be pertinent to ascertain compliance with such Acts, Regulations, and instructions. Where any information required of a contractor is in the exclusive possession of another who fails or refuses to furnish the information, the contractor will so certify to the Recipient or *The City of Canton*, as appropriate, and will set forth what efforts it has made to obtain the information.
5. **Sanctions for Noncompliance:** In the event of a contractor's noncompliance with the Non-discrimination provisions of this contract, the Recipient will impose such contract sanctions as it or *The City of Canton* may determine to be appropriate, including, but not limited to:
 - a. withholding payments to the contractor under the contract until the contractor complies; and/or
 - b. cancelling, terminating, or suspending a contract, in whole or in part.
6. **Incorporation of Provisions:** The contractor will include the provisions of paragraphs one through six in every subcontract, including procurements of materials and leases of equipment, unless exempt by the Acts, the Regulations and directives issued pursuant thereto. The contractor will take action with respect to any subcontract or procurement as the Recipient or *The City of Canton* may direct as a means of enforcing such provisions including sanctions for noncompliance. Provided, that if the contractor becomes involved in, or is threatened with litigation by a subcontractor, or supplier because of such direction, the contractor may request the Recipient to enter into any litigation to protect the interests of the Recipient. In addition, the contractor may request the United States to enter into the litigation to protect the interests of the United States.

APPENDIX C

CLAUSES FOR TRANSFER OF REAL PROPERTY ACQUIRED OR IMPROVED UNDER THE ACTIVITY, FACILITY, OR PROGRAM

The following clauses will be included in deeds, licenses, leases, permits, or similar instruments entered into by the (Title of Recipient) pursuant to the provisions of Assurance 7(a):

- A. The (grantee, lessee, permittee, etc. as appropriate) for himself/herself, his/her heirs, personal representatives, successors in interest, and assigns, as a part of the consideration hereof, does hereby covenant and agree [in the case of deeds and leases add "as a covenant running with the land"] that:
 1. In the event facilities are constructed, maintained, or otherwise operated on the property described in this (deed, license, lease, permit, etc.) for a purpose for which a U.S. Department of Transportation activity, facility, or program is extended or for another purpose involving the provision of similar services or benefits, the (grantee, licensee, lessee, permittee, etc.) will maintain and operate such facilities and services in compliance with all requirements imposed by the Acts and Regulations (as may be amended) such that no person on the grounds of race, color, or national origin, will be excluded from participation in, denied the benefits of, or be otherwise subjected to discrimination in the use of said facilities.
- B. With respect to licenses, leases, permits, etc., in the event of breach of any of the above Non-discrimination covenants, (Title of Recipient) will have the right to terminate the (lease, license, permit, etc.) and to enter, re-enter, and repossess said lands and facilities thereon, and hold the same as if the (lease, license, permit, etc.) had never been made or issued.*
- C. With respect to a deed, in the event of breach of any of the above Non-discrimination covenants, the (Title of Recipient) will have the right to enter or re-enter the lands and facilities thereon, and the above described lands and facilities will there upon revert to and vest in and become the absolute property of the (Title of Recipient) and its assigns.*

(*Reverter clause and related language to be used only when it is determined that such a clause is necessary to make clear the purpose of Title VI.)

APPENDIX D

CLAUSES FOR CONSTRUCTION/USE/ACCESS TO REAL PROPERTY ACQUIRED UNDER THE ACTIVITY, FACILITY OR PROGRAM

The following clauses will be included in deeds, licenses, permits, or similar instruments/agreements entered into by (Title of Recipient) pursuant to the provisions of Assurance 7(b):

- A. The (grantee, licensee, permittee, etc., as appropriate) for himself/herself, his/her heirs, personal representatives, successors in interest, and assigns, as a part of the consideration hereof, does hereby covenant and agree (in the case of deeds and leases add, "as a covenant running with the land") that (1) no person on the ground of race, color, or national origin, will be excluded from participation in, denied the benefits of, or be otherwise subjected to discrimination in the use of said facilities, (2) that in the construction of any improvements on, over, or under such land, and the furnishing of services thereon, no person on the ground of race, color, or national origin, will be excluded from participation in, denied the benefits of, or otherwise be subjected to discrimination, (3) that the (grantee, licensee, lessee, permittee, etc.) will use the premises in compliance with all other requirements imposed by or pursuant to the Acts and Regulations, as amended, set forth in this Assurance.
- B. With respect to (licenses, leases, permits, etc.), in the event of breach of any of the above Non-discrimination covenants, (Title of Recipient) will have the right to terminate the (license, permit, etc., as appropriate) and to enter or re-enter and repossess said land and the facilities thereon, and hold the same as if said (license, permit, etc., as appropriate) had never been made or issued.*
- C. With respect to deeds, in the event of breach of any of the above Non-discrimination covenants, (Title of Recipient) will there upon revert to and vest in and become the absolute property of (Title of Recipient) and its assigns.*

(*Reverter clause and related language to be used only when it is determined that such a clause is necessary to make clear the purpose of Title VI.)

APPENDIX E

During the performance of this contract, the contractor, for itself, its assignees, and successors in interest (hereinafter referred to as the "contractor") agrees to comply with the following non-discrimination statutes and authorities; including but not limited to:

Pertinent Non-Discrimination Authorities:

- Title VI of the Civil Rights Act of 1964 (42 U.S.C. § 2000d *et seq.*, 78 stat. 252), (prohibits discrimination on the basis of race, color, national origin); and 49 CFR Part 21.
- The Uniform Relocation Assistance and Real Property Acquisition Policies Act of 1970, (42 U.S.C. § 4601), (prohibits unfair treatment of persons displaced or whose property has been acquired because of Federal or Federal-aid programs and projects);
- Federal-Aid Highway Act of 1973, (23 U.S.C. § 324 *et seq.*), (prohibits discrimination on the basis of sex);
- Section 504 of the Rehabilitation Act of 1973, (29 U.S.C. §794 *et seq.*), as amended, (prohibits discrimination on the basis of disability); and 49 CFR Part 27;
- The Age Discrimination Act of 1975, as amended, (42 U.S.C. § 6101 *et seq.*), (prohibits discrimination on the basis of age);
- Airport and Airway Improvement Act of 1982, (49 USC § 471, Section 47123), as amended, (prohibits discrimination based on race, creed, color, national origin, or sex);
- The Civil Rights Restoration Act of 1987, (PL 100-209), (Broadened the scope, coverage and applicability of Title VI of the Civil Rights Act of 1964, The Age Discrimination Act of 1975 and Section 504 of the Rehabilitation Act of 1973, by expanding the definition of the terms "programs or activities" to include all of the programs or activities of the Federal-aid recipients, sub-recipients and contractors, whether such programs or activities are Federally funded or not);
- Titles II and III of the Americans with Disabilities Act, which prohibit discrimination on the basis of disability in the operation of public entities, public and private transportation systems, places of public accommodation, and certain testing entities (42 U.S.C. §§ 12131 - 12189) as implemented by Department of Transportation regulations at 49 C.F.R. parts 37 and 38;
- The Federal Aviation Administration's Non-discrimination statute (49 U.S.C. § 47123) (prohibits discrimination on the basis of race, color, national origin, and sex);
- Executive Order 12898, Federal Actions to Address Environmental Justice in Minority Populations and Low-Income Populations, which ensures discrimination against minority populations by discouraging programs, policies, and activities with disproportionately high and adverse human health or environmental effects on minority and low-income populations;
- Executive Order 13166, Improving Access to Services for Persons with Limited English Proficiency, and resulting agency guidance, national origin discrimination includes discrimination because of limited English proficiency (LEP). To ensure compliance with Title VI, you must take reasonable steps to ensure that LEP persons have meaningful access to your programs (70 Fed. Reg. at 74087 to 74100);
- Title IX of the Education Amendments of 1972, as amended, which prohibits you from discriminating because of sex in education programs or activities (20 U.S.C. 1681 *et seq.*).

CANTON TITLE VI COMPLAINT PROCEDURE

I. FILING A COMPLAINT

Complaint Procedure - Any person who believes that he or she as a member of a protected class, has been discriminated against based on race, color, national origin, gender, age, disability, religion, low income status, or Limited English Proficiency (LEP) in violation of Title VI of the Civil Rights Act of 1964, as amended and its related statutes, regulations and directives, Section 504 of the Vocational Rehabilitation Act of 1973, Americans with Disabilities Act of 1990, as amended, the Civil Rights Restoration Act of 1987, as amended, and any other Federal nondiscrimination statute may submit a complaint. A complaint may also be submitted by a representative on behalf of such a person.

It is the policy of the City to conduct a prompt and impartial investigation of all allegations of discrimination and to take prompt effective corrective action when a claim of discrimination is substantiated.

No one may intimidate, threaten, coerce or engage in other discriminatory conduct against anyone because they have taken action or participated in an action to secure rights protected by the civil rights laws. Any individual alleging such harassment or intimidation may submit a complaint by following the procedure printed below.

Any individual who feels that he or she has been discriminated against may submit a written or verbal complaint to the designated Title VI Coordinator. A complaint must include the name, address and telephone number of the individual making the complaint (complainant) and a brief description of the alleged discriminatory conduct including the date of harm. An individual submitting a complaint alleging discrimination may include any relevant evidence, including the names of witnesses and supporting documentation.

Complaints should be directed to the Title VI Coordinator:

Fonda Williams
Deputy Mayor
218 Cleveland Ave S.W., 8th floor
Canton, Ohio 44702
Phone - 330-438-4302
Email – fonda.williams@cantonohio.gov

Within 60 days of the receipt of the complaint the City will conduct an investigation of the allegation based on the information provided and issue a written report of its findings to the complainant. The City will try to obtain an informal voluntary resolution to all complaints at the lowest level possible.

A complainant's identity shall be kept confidential except to the extent necessary to conduct an investigation. All complaints shall be kept confidential.

These procedures do not deny the right of any individual to file a formal complaint with any government agency or affect an individual's right to seek private counsel for any complaint alleging discrimination.

Complaints may also be filed with the following government agencies:

Ohio Department of Transportation
Office of Equal Opportunity
1980 West Broad Street
MS: 3270
Columbus, OH 43223

The U.S. Department of Transportation
1200 New Jersey Avenue, SE
Washington, DC 20590

Ohio Civil Rights Commission
Central Office
Rhodes State Office Tower
30 East Broad Street, 5th floor
Columbus, OH 43215
614-466-2785

Ohio Civil Rights Commission
Akron Regional Office
Bradley S. S. Dunn, Regional Director
Akron Government Bldg.
161 S. High Street, Suite 205
Akron, OH 44308
(330) 643-3100

Link to filing a complaint online with the Ohio Civil Rights Commission:

<https://crc.ohio.gov/FilingaCharge/ChargeFilingProcedure.aspx>

II COMPLAINT PROCESSING

The Title VI Coordinator will review the complaint upon receipt to ensure that all required information is provided, the complaint meets the filing deadline date which is 180 days from the date the alleged discriminatory act occurred, and falls within the jurisdiction of the City.

The Title VI Coordinator will then investigate the complaint. If the complaint is against the City then the Mayor's office or their designee will investigate the complaint. Additionally, a copy of the complaint will be forwarded to the City Law Director.

If the complaint warrants a full investigation, the Complainant will be notified in writing by certified mail. This notice will name the investigator and/or investigating agency.

The party alleged to have acted in a discriminatory manner will also be notified by certified mail as of the complaint. This letter will also include the investigator's name and will request that this party be available for an interview.

Any comments or recommendations from legal counsel will be reviewed by the Title VI Coordinator, Director of Public Service and Mayor's office.

Once the City has investigated the report findings, the City will adopt a final resolution. All parties associated with the complaint will be properly notified of the outcome of the City's investigative report.

If the complainant is not satisfied with the results of the investigation of the alleged discriminatory practice(s), she/he shall be advised of their right to appeal the City's decision.

Appeals must be filed within 180 days after the City's final resolution. Unless new facts not previously considered come to light, reconsideration of the City's determination will not be available.

The foregoing complaint resolution procedure will be implemented in accordance with the Department of Justice guidance manual entitled "Investigation Procedures Manual for the Investigation and Resolution of Complaints Alleging Violations of Title VI and Other Nondiscrimination Statutes," available online at:

<http://www.justice.gov/crt/about/cor/Pubs/manuals/complain.pdf>

Title VI Complaint Filing

Complaints filed with the City of Canton, Ohio based on violations of Title VI of the Civil Rights Act of 1964, must include the following information:

- Name of Complainant
- Date of Complaint
- Address of Complainant
- Telephone Number of Complainant
- Name of Agency / Department Accused of Discriminatory Practices
- Name of Individual Accused of Discriminatory Practices
- Address of Agency
- Date of Alleged Discrimination
- Description of Alleged Discrimination (see below)

11. Alleged Discrimination - If your complaint is in regard to discrimination in the delivery of services or discrimination that involved the treatment of you by others by the agency or department indicated above, please indicate below the basis on which you believe these discriminatory actions were taken.

- Race / Color / Religion
- National Origin
- Age · Sex, Gender
- Disability · Income Status
- Explanation of Alleged Discrimination - Please explain as clearly as possible what happened.

Provide the name(s) of witness(s) and others involved in the alleged discrimination. (Attach additional sheets if necessary and provide a copy of written material pertaining to your case.)

- Signature of Complainant · Date of Complaint

III ENVIRONMENTAL JUSTICE

In accordance with Title VI of the Civil Rights Act of 1964, each Federal agency shall ensure that all programs or activities receiving Federal financial assistance that affect human health or the environment do not directly, or through other arrangements, use criteria, methods, or practices that discriminate on the basis of race, color, or national origin. Part of Title VI reads, "No person in the United States shall, on the ground of race, color, or national origin be excluded

from participation in, be denied the benefits of, or be subject to discrimination under any program or activity receiving Federal financial assistance.”

The three fundamental environmental justice (EJ) principles are:

- To avoid, minimize, or mitigate disproportionately high and adverse human health and environmental effects, including social and economic effects, on minority populations and low-income populations;
- To ensure the full and fair participation by all potentially affected communities in the transportation decision-making process; and
- To prevent the denial of, reduction in, or significant delay in the receipt of benefits by minority populations and low-income populations.

The City of Canton is committed to these three environmental justice principles in all work that the City performs.

IV. ADMINISTRATION – WORK PLAN

Pursuant to 23 CFR 200, the City of Canton has designated a Title VI Coordinator who is responsible for initiating, monitoring, and ensuring the City’s compliance with Title VI requirements for the following work plan:

- Administer, coordinate and Implement the Title VI Program plan and distribute internally and externally via website and update annually as required.
- Ensure that Assurances are being used in contracts for federal projects.
- Attend Title VI training.
- Collect public involvement data.
- Review written Title VI complaints and ensure every effort is made to resolve complaints informally at the local or regional level and review and update the City’s Title VI plan and procedures as required.
- Implement a plan that provides training to City Staff on the basic requirements of the Title VI implementation plan.

Title VI Coordinator:

Fonda Williams
Deputy Mayor
218 Cleveland Avenue, S.W., 8th floor
Canton, Ohio 44702
Phone – 330-438-4302
Email - fonda.williams@cantonohio.gov

V. LIMITED ENGLISH PROFICIENCY (LEP) POLICY

On August 11, 2000, the President signed an executive order, *Executive Order 13166: Improving Access to Service for Persons with Limited English Proficiency (LEP)*, to clarify Title VI of the Civil Rights Act of 1964. It has as its purpose, to ensure meaningful access to programs and services to otherwise eligible persons who are not proficient in the English language. In addition, The US Department of Transportation published *Policy Guidance Concerning Recipients' responsibilities to Limited English Proficient Person* in the December 14, 2005 Federal Register.

This guidance outlines the following four factors that the City uses to access the LEP populations in Canton.

1. The number and proportion of LEP persons eligible to be served or likely to be encountered by the City.
2. The frequency with which LEP individuals come into contact with the program, activity or service.
3. The nature and importance of the program, activity, or service provided by the program.
4. The resources available to the City and costs.

Summary of the four factor analysis

Factor 1- The number and proportion of LEP persons eligible to be served or likely to be encountered by the City can only be estimated until the actual number of persons who can speak English less than “very well” are documented as needing assistance by City Staff . With this Title VI Plan being in early development stages and considered a document that may need regular updates, US Census Bureau information is being used at this time. The total population is provided below to shown general distribution of race and ethnicity in the community. The estimated number of persons that may not speak English “very well” is following in the US Census Bureau 2006-2010 American Community Survey.

The U.S. Census Bureau provides statistics from 2010 for the City of Canton as follows:

Total population = 74,451

Population by Ethnicity:

Hispanic or Latino = 1,805 Non Hispanic or Latino = 72,646

Population by Race:

White = 53,150 African American = 16,854, Asian = 193, American Indiana or Alaska Native = 372,

Native Hawaiian and Pacific Islander = 0, Other = 431, Identified by two or more = 3,451.

The US Census Bureau 2006-2010 American Community Survey 5-Year Estimates under SELECTED SOCIAL CHARACTERISTICS estimates the number of people in Canton who speak a language other than English to be 2,945 with those speaking English less than “very well” estimated at 1.0% or approximately 983 individuals who may be considered limited in English proficiency.

Factor 1(continued)-

According to the census numbers above there may be up to 983 individuals who live in the City of Canton that *may* be considered as LEP. Based on actual contact between City Staff and the community there have been very few requests from anyone in the service area asking the City to provide language translation services. Therefore, the LEP population is probably even less than the estimate shown above.

Factor 2- The frequency with which LEP individuals come into contact with the program, activity or service:

Due to the infrequent requests for translation services, there appears to be a minimal need for translation services from the City. This may be attributed to the high percentage of younger people (87.6% for ages up to 17) who are available as family members for translation services.

Factor 3. The nature and importance of the program, activity, or service provided by the program:

If at any time a LEP individual requests translation services that are considered important such that denial or delay of access or services or information could have serious or even life-threatening implications, the City will provide, upon request, services to assist the LEP population including translation of vital City documents and interpretation services.

Factor 4. The resources available to the City and costs:

The City of Canton currently has several staff members who are bilingual in English and Spanish and are available to translate requests from the Hispanic population on a day to day basis. The City also provides many of their outreach services in the predominate languages of the community, English and Spanish. In addition, certified translation services are available through LanguageLine Solutions, a telephone translation service that is accessible for phone line translations services 24 hours a day. These are services the City provides upon request as discussed in factor 3 above. Page | 12

Summary of LEP Accommodation Plan

- The City of Canton strives to serve its population to the best of its ability and will provide upon request, services to assist the LEP population including translation of vital documents and interpretation services deemed necessary to provide meaningful access to City services.
- A U.S. Census Bureau ISpeak card is available as part of this document and on the City's webpage and is also available at City Hall located at 414 Main Street. This card allows LEP individuals to communicate their preferred language to City Staff whereas City Staff may then access a translation service called LanguageLine, phone number 1-800-752-6096 is available to City Staff or other translation services may be used as determined by the City.
- For language translation requests from the Hispanic or Latino community the City has several staff member who are bilingual and are available to provide translation services on a day to day basis.
- The City of Canton utilizes a voluntary public involvement survey to collect information regarding persons affected by proposed projects. The survey permits respondents to remain

anonymous, while voluntarily answering questions regarding their gender, ethnicity, race, age, sex, disability status, and household income. This voluntary public involvement survey is available at all public hearings and meetings. Once the survey data has been collected, it will be reviewed and then the survey will be placed in a file for future reference. In the case enough surveys are collected over time to show a significant increase in LEP populations, the City may consider changes to their LEP policy. Completed surveys shall be retained for a period of three years from the date of the meeting and/or completion of the related project, if applicable. See Appendix G for a sample of this Survey.

- The City reviews written Title VI complaints and ensures every effort is made to resolve complaints informally at the local or regional level and review and update the City's Title VI plan and procedures as required.
- Staff for the City will be provided training on the requirements for providing meaningful access to services for LEP persons. Considering the relatively small size of the City of Canton and limited financial resources, current training may be limited to web access to this document and its attachments by all City Staff, a log showing the names of all Staff that have been made aware of this document (sign off that they have read the document) and require that all new employees receive the same training.

Signature and Proposal Pages

Signature Page 12th St. NW Water Main Replacement (TAG 617)

To the Director of Public Service of the City of Canton:

The undersigned, having carefully examined the complete invitation to bid, herewith proposes to furnish all the labor and materials required to complete the **12th St. NW Water Main Replacement (TAG 617)** in accordance with the specifications on file, including any and all work and materials that may be necessary to complete the project in a proper and workmanlike manner, and in accordance with the instructions in the bid packet and under the direction of and to the satisfaction of the Director of Public Service of said City.

The bidder hereby agrees that the Director of Public Service has the right to reject any and all bids and to accept the bid(s) deemed most beneficial to the City of Canton.

The bidder hereby certifies that the undersigned _____ is the only person interested in the bid and the bidder herewith certifies that no officer or employee of the City of Canton is in any manner interested therein.

The bidder herewith encloses a _____ **(BID BOND, CERTIFIED/CASHIER'S CHECK)** in the sum of \$ _____ dollars made payable to the CITY OF CANTON as a guaranty that if awarded the contract for the work included in the proposal, will enter into contract therefore, with sureties satisfactory to the Director of Public Service, within the prescribed time of ten (10) days from the date of service of notice of award, otherwise such bond or checks shall become the property of said City, as liquidated damages of the failure on the bidder's part to do said contract within the specified time.

The bidder acknowledges receipt of Addenda Numbers: _____.

SIGNATURE OF BIDDER: _____.

NOTE: If bidder is a corporation, set forth the legal name of the corporation, together with the signature of the officer or officers authorized to sign contracts on behalf of the corporation. If bidder is a partnership, set forth the name of the firm, together with the signature of the partner or partners authorized to sign contracts on behalf of the partnership.

Proposal Page

We (I), the above signed hereby propose to furnish the following article(s) and/or service(s) at the price(s) and terms stated subject to all instructions, conditions, specifications, and all attachments hereto. We (I) have read all attachments including the specifications and fully understand what is required.

BASE BID

Bid Item	ODOT Item	Description	Qty	Unit	Labor	Material	Total Unit Cost	Total Cost
Roadway								
1	202	CURB AND GUTTER REMOVED (CONTINGENCY)	250	FT				
2	204	SUBGRADE COMPACTION (APRONS)	33	SY				
3	254	PAVEMENT PLANING, ASPHALT CONCRETE	1016	SY				
4	305	9" CONCRETE BASE	606	SY				
5	407	TACK COAT (0.075 GAL/SY)	170	GAL				
6	424	3/4" FINE GRADED POLYMER ASPHALT CONCRETE, TYPE B	34	CY				
7	441	2-1/4" ASPHALT CONCRETE INTERMEDIATE COURSE, TYPE 2, (448)	38	CY				
8	452	8" NON-REINFORCED CONCRETE PAVEMENT, CLASS QC1	33	SY				
9	609	COMBINATION CURB AND GUTTER, TYPE 2 (CONTINGENCY)	250	FT				
10	644	CROSSWALK LINE	80	FT				
11	644	DOTTED LINE, 4"	365	FT				
12	644	LANE LINE, 4"	0.04	MILE				
13	653	4" TOPSOIL FURNISHED AND PLACED	1	LUMP				
14	659	SEEDING AND MULCHING	1	LUMP				
Water Work								
15	202	ABANDON VALVE	4	EACH				
16	202	ABANDON MISC.: GROUT AND ABANDON EXISTING WATER MAIN	1090	FT				
17	638	FIRE HYDRANT AND GATE VALVE REMOVED, HYDRANT TEE PLUGGED	1	EACH				
18	638	1" WATER SERVICE, COMPLETE - LONG SIDE	1	EACH				
19	638	1" WATER SERVICE, COMPLETE - SHORT SIDE	4	EACH				
20	638	1-1/2" WATER SERVICE, COMPLETE - LONG SIDE	2	EACH				
21	638	2" WATER SERVICE, COMPLETE - SHORT SIDE	1	EACH				

Bid Item	ODOT Item	Description	Qty	Unit	Labor	Material	Total Unit Cost	Total Cost
22	638	8" WATER MAIN DUCTILE IRON PIPE, CLASS 52	50	FT				
23	638	12" WATER MAIN DUCTILE IRON PIPE, CLASS 53	1040	FT				
24	638	HYDRANT ASSEMBLY, COMPLETE	2	EACH				
25	638	8 INCH GATE VALVE AND VALVE BOX, COMPLETE	1	EACH				
26	638	8 INCH 11.25 DEGREE BEND	1	EACH				
27	638	8 INCH 45 DEGREE BEND	2	EACH				
28	638	8 INCH CUT IN SLEEVE	1	EACH				
29	638	8 INCH PLUG	1	EACH				
30	638	12 INCH GATE VALVE AND VALVE BOX, COMPLETE	3	EACH				
31	638	12 INCH 11.25 DEGREE BEND	1	EACH				
32	638	12 INCH 45 DEGREE BEND	2	EACH				
33	638	12 INCH CUT IN SLEEVE	2	EACH				
34	638	12 INCH PLUG	2	EACH				
35	638	12 INCH x 12 INCH x 8 INCH TEE	1	EACH				
Incidentals								
36	614	MAINTAINING TRAFFIC	1	LUMP				
37	614	LAW ENFORCEMENT OFFICER WITH PATROL CAR	24	HOUR				
38	623	CONSTRUCTION LAYOUT STAKES AND SURVEYING	1	LUMP				
39	624	MOBILIZATION	1	LUMP				
40	832	EROSION CONTROL, COMPLETE	1	LUMP				
							TOTAL =	

Base Bid Price in Figures

Base Bid Price in Words

**Base Bid Prices are for Informational Purposes Only.
Total Unit Prices will govern.**