

PROJECT DOCUMENTS
FOR
FY2023 STREET PAVING

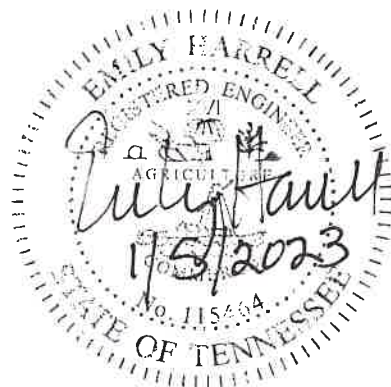

City of Lakeland
January 2023

TABLE OF CONTENTS

SECTION I: **BID DOCUMENTS, CONTRACTS, FORMS, AND CONDITIONS OF THE CONTRACT**

Advertisement for Bid	AB-1 -- AB-2
Instruction to Bidders	IB-1 -- IB-9
Bid Form	BF-1 -- BF-4
Bid Schedule	BS-1 -- BS-2
Standard Bid Bond	BB-1 -- BB-2
Standard Agreement Between Owner and Contractor	SFA-1 -- SFA-6
Drug-Free Workplace Affidavit	DA 1
Standard Performance Bond	C-610-1 --C-610-3
Standard Payment Bond	C-615A-1 --C-615A-3
Standard General Conditions	C700-1 -- C700-65
Standard Supplementary Conditions	SSC-1 -- SSC-13

SECTION II: **BIDDING AND TECHNICAL SPECIFICATIONS**

GENERAL REQUIREMENTS

Summary of Work	01010
General Construction Requirements	01100
Project Coordination	01200
Submittals	01340
Temporary Facilities	01505
Measurement and Payment Procedures	01650
Contract Closeout	01750

SPECIAL PROVISIONS

Special Provisions	01810
--------------------	-------

TECHNICAL SPECIFICATIONS

Temporary Traffic Control	01551
Geotextiles	02340
Bound Aggregate Base Courses	02710
Asphaltic Concrete Pavement	02741
Portland Cement Concrete	03050
Standard Details	Appendix A

STANDARD
ADVERTISEMENT FOR BIDS
FOR
FY23 STREET PAVING PROJECT
FOR
CITY OF LAKELAND
LAKELAND, TENNESSEE

Notice is hereby given, pursuant to Tennessee Statute Section 16-19-104, the City of Lakeland, Tennessee, will receive sealed bids until 2:00 p.m., local Time, January 26, 2023, for the following:

FY23 STREET PAVING PROJECT

Bids must be in one sealed envelope with statement thereon "BID ENCLOSED, FY23 STREET PAVING PROJECT" and be submitted to the receptionist at the City of Lakeland, Tennessee 10001 U.S. Highway 70, at or before the above stated time. Bids will be opened publicly, read aloud, and tabulated by the City Manager, or his or her Designee, at the above stated time and place, unless an alternative site is designated in writing prior to the time of Bid Opening. No bid may be withdrawn for a period of thirty (30) days after the date set for opening thereof. The City of Lakeland, Tennessee reserves the right to reject any or all bids and to waive any informalities or technicalities in the bidding; provided, however, that any bid received after the time specified or without accompanying Bid Guaranty, as stated below, will not be considered.

Bidding Documents, including specifications, are currently available from the City of Lakeland Tennessee, 10001 U.S. Highway No. 70, Lakeland Tennessee or at www.lakelandtn.gov.

A Bid Guaranty in the form of a properly executed Bid Bond payable to the City in the amount of not less than 5% of the total base bid amount must accompany each bid. Pursuant to T.S. 12-4-201, in lieu of a Bid Bond, the following securities or cash may be substituted at the percentage rate required for such bond: United States treasury bond or general obligation bond or certificates of deposit irrevocably pledged from a state or national bank having its principle office in Tennessee or a state or federal saving and loan association having its principal office in Tennessee, or any state or national banks or state or federal savings and loans associations that has its principal office located outside of Tennessee and that maintains a branch in this state, or a letter of credit or cash. The successful Bidder will be required to execute an Agreement with the City, in the form supplied in the bidding documents, within thirty (30) days after Notice of Award is issued. The Notice of Award shall serve as notice that the Agreement is ready for execution. The Bid Guaranty shall be forfeited as liquidated damages if the Bidder fails to execute the Agreement within thirty (30) days after such Notice is issued or fails to provide proper Bond or other form of Guaranty, as approved. The Bid Guaranty, if a Bid Bond, shall be executed by a surety or guarantee company authorized to do business in Tennessee. The Attorney-in-Fact who executes the Bond on behalf of the surety

shall affix a certified and current copy of its Power of Attorney from the surety. No other type of Bid Guaranty will be accepted. The City may proceed against a Bid Guaranty unless either: a) the Agreement has been executed by Contractor and Performance, and Labor and Material Payment Bonds have been furnished, as required; or, b) the specified time has elapsed so that Bids may be withdrawn; or, c) the Bid has been rejected.

Notice is hereby given that preference will be granted to Tennessee contractors, subcontractors, laborers, and materials, supplies, equipment, machinery, and provisions produced, manufactured, supplied, or grown in Tennessee, as required by Tennessee Statute Section 12-4-121 et seq.

A Pre-Bid Conference will be held at 2:00 p.m., Local Time, January 18, 2023, at Lakeland City Hall. A site tour may be held to review the Project following this conference. Contact for this Project is Luis Camarillo Hernandez, Staff Engineer, at (901) 317-6025 or lhernandez@lakelandtn.org.

Attendance in the Pre-Bid Conference is not mandatory for Contractors who wish to be considered qualified and/or responsible.

Michael Walker
City Manager

Publish: January 10, 2023
 January 17, 2023

STANDARD
INSTRUCTIONS TO BIDDERS

1. DEFINED TERMS.

1.1 Terms used in these Instructions to Bidders have the meanings assigned to them in the Standard General Conditions, as modified by the Supplementary Conditions unless otherwise stated herein.

1.2 Certain additional terms used in these Instructions to Bidders have the meanings indicated below which are applicable to both the singular and plural thereof.

A. Bidder: One who submits a bid directly to the City.

B. Successful Bidder and/or Contractor: This term means the qualified, responsible, and responsive Bidder, as determined by the City, who has submitted the lowest bid, and to whom the City has awarded the Contract.

C. Bid Documents: Prior to award of the contract, all documents in the Bid Package are considered "Bid Documents." This includes the Advertisement for Bid, Instructions to Bidders, Bid Forms, Bond Forms, Sample Agreement, Standard General Conditions, Supplementary Conditions, Technical Specifications, drawings, etc. Bid Documents also include any addenda issued prior to the opening of the bids.

D. Contract Documents: Following the award of the contract, contract documents shall include those documents listed above in "C." -- with the exception of the Advertisement for Bid, Bid Bond and the Instructions to Bidders; the executed performance and payment bonds; change orders; and, all written agreements and/or written documents executed between the City and Contractor.

2. COPIES OF BIDDING DOCUMENTS.

2.1 Complete sets of Bidding Documents, which include the Advertisement for Bids, these Instructions to Bidders, Bid Form, Bid Bond, Contract Documents, and Addenda, may be obtained from the City of Lakeland, Engineering Office, 10001, U.S. Highway 70, Lakeland, Tennessee 38002.

2.2 Complete sets of Bidding Documents must be used in preparing Bids; the City assumes no responsibility to Bidders for errors or misinterpretations, including those resulting from the use of incomplete sets of Bidding Documents.

2.3 The City, and/or its agent, in making copies of Bidding Documents available on the above terms, does so only for the purpose of obtaining Bids on the Work and does not confer a license or grant for any other use.

3. QUALIFICATIONS OF BIDDERS.

3.1 Pre-qualification Requirements: Attendance at the Pre-Bid Conference may be considered by the City in determining a Bidder's qualifications. Consult Section 5 below.

3.2 Post Bid Qualifications: To demonstrate qualifications to perform the Work, each Bidder must be prepared to submit within five (5) days of Owner's request written evidence demonstrating Bidder's responsibility, including, but not limited to, matters such as financial data and previous experience. Each Bid will be considered a warrant of Bidder's qualification to do business in this state. Proof of such qualifications may be required upon five (5) days notice.

3.3 Bidding Preferences: Pursuant to T.S. 12-4-802 whenever the lowest responsible and responsive bidder on a public construction project in this state is a resident of another state which is contiguous to Tennessee and which allows a preference to a resident contractor of that state, a like reciprocal preference is allowed to the lowest responsible and responsive bidder on such project who is either a resident of this state or is a resident of another state which does not allow for a preference to a resident contractor of that state.

3.4 Responsible and Responsive Bidders: Pursuant to TS 12-4-801, a responsible bidder means a person who has the capacity in all respects to perform fully the contract requirements, and the integrity and reliability which will assure good faith performance and; and Responsive Bidder means a person who has submitted a bid which confirms in all material respects to all document, whether attached or incorporate by reference, utilized for soliciting bids.

4. PRE-BID CONFERENCE.

A Pre-bid Conference will be held at the time and place stated in the "Advertisement for Bid." Attendance at the Pre-bid Conference is not mandatory.

The purpose of the Conference is to review project requirements and provide bidders an opportunity to visit the project site to make their own determination of existing conditions.

Minutes will be taken of the Pre-bid Conference, and thereafter consulted as a bidding document.

5. EXAMINATION OF CONTRACT DOCUMENTS AND SITE.

5.1 Before submitting a Bid, each Bidder must do at least the following:

- A. Examine the Bidding Documents thoroughly;
- B. Visit the site to become familiar with local conditions that may in any manner affect cost progress, or performance of the Work;

- C. Become familiar with federal, state, and local laws, ordinances, rules, and regulations that may in any manner affect cost, progress, or performance of the work; and
- D. Study and carefully correlate Bidder's observations with the Bidding Documents.

5.2 Reference is made to the Supplementary Conditions, for the identification of those reports of investigations and tests of subsurface and latent physical conditions at the site or otherwise affecting cost, progress, or performance of the work which has/have been relied upon by Engineer in preparing the Drawings and Specifications. The City will provide copies of such reports for review to any Bidder requesting them (if applicable). These reports are not guaranteed as to accuracy or completeness. Before submitting a Bid each Bidder will, at its own expense, make such additional investigations and tests as the Bidder may deem necessary to determine the time, price, and other terms and conditions of the Contract Documents.

5.3 On request the City will provide each Bidder access to the site to conduct such investigations and tests as each Bidder deems necessary for submission of his Bid. The City may require any Bidder desiring access to execute an appropriate release form.

5.4 The lands upon which the work is to be performed, right-of-way for access thereto and other lands designated for use by Contractor in performing the work are identified in the Supplementary Conditions, Special Provisions, and/or Drawings.

5.5 The submission of a Bid will constitute an incontrovertible representation by the Bidder that: Bidder has read and understands the Bidding Documents and the Bid is made in accordance therewith; Bidder has visited the site and become familiar with the local conditions under which the work is to be performed; Bidder assumes responsibility for estimating properly the difficulties and costs of successfully performing the work; Bidder has complied with every requirement of these instructions; and that the Bidding Documents are sufficient in scope and detail to indicate and convey an understanding of all terms and conditions for performance of the Work.

6. AVAILABILITY OF LANDS.

6.1 Access to private property required by Contractor for staging areas, temporary facilities or other uses in addition to those identified in the Bidding or Contract Documents shall be obtained and paid for by Contractor. Such costs are to be considered incidental to the Contract and merged with Bid Items described and are to be provided without additional compensation to Contractor.

7. INTERPRETATIONS.

All questions about the meaning or intent of the Bidding Documents shall be submitted to Engineer in writing. Replies will be issued by Addenda mailed or delivered to all parties recorded by Engineer as having received the Bidding Documents. Questions received less than ten (10) days

prior to the date for opening the Bids will not be answered. Only questions answered by formal written Addenda will be binding. Oral interpretations, clarifications, or comments are not binding upon the City, and do not serve to amend, modify, or in any way change the basic Bidding Documents, and shall be relied upon by Bidder at his own risk.

8. BID GUARANTY.

8.1 A Bid Guaranty in the form of a properly executed Bid Bond payable to the City in the amount of not less than 5% of the total base bid amount must accompany each bid. Pursuant to T.S. 12-4-201, in lieu of a Bid Bond, the following securities or cash may be substituted at the percentage rate required for such bond: United States treasury bond or general obligation bond or certificates of deposit irrevocably pledged from a state or national bank having its principle office in Tennessee or a state or federal saving and loan association having its principal office in Tennessee, or any state or national banks or state or federal savings and loans associations that has its principal office located outside of Tennessee and that maintains a branch in this state, or a letter of credit or cash. The successful Bidder will be required to execute an Agreement with the City, in the form supplied in the bidding documents, within thirty (30) days after Notice of Award is issued. The Notice of Award shall serve as notice that the Agreement is ready for execution. The Bid Guaranty shall be forfeited as liquidated damages if the Bidder fails to execute the Agreement within thirty (30) days after such Notice is issued, or fails to provide proper Bond or other form of Guaranty, as approved. The Bid Guaranty, if a Bid Bond, shall be executed by a surety or guarantee company authorized to do business in Tennessee. The Attorney-in-Fact who executes the Bond on behalf of the surety shall affix a certified and current copy of its Power of Attorney from the surety. No other type of Bid Guaranty will be accepted. The City may proceed against a Bid Guaranty unless either: a) the Agreement has been executed by Contractor and Performance, and Labor and Material Payment Bonds have been furnished, as required; or, b) the specified time has elapsed so that Bids may be withdrawn; or, c) the Bid has been rejected. .

8.2 The Bid Guaranty of the Successful Bidder will not be released unless and until such Bidder has executed the Agreement and furnished the required contract Bond(s). If the successful Bidder fails to execute and deliver the Agreement and furnish the required Contract Bonds within thirty (30) days of the Notice of Award, or fails to proceed with the performance of the Contract, the City may annul the Notice of Award and the Bid Guaranty of that Bidder will be forfeited as liquidated damages, it being agreed that exact damages are difficult or impossible to calculate, and the Bid Guaranty amount is the best estimate.

9. CONTRACT TIME.

The number of days within which, or the date by which, the Work is to be completed (the Contract Time) is set forth in the Bid Form and will be included in the Agreement.

10. LIQUIDATED DAMAGES.

Provisions for liquidated damages are to be set forth in the Agreement.

11. MATERIAL AND EQUIPMENT.

11.1 The materials, products, and equipment described in the Bidding Documents establish a standard or required function, dimension, appearance, and quality to be met by any proposed substitution.

11.2 Materials containing asbestos will not be accepted.

11.3 No substitution will be considered unless written request for approval has been submitted by the Bidder on an appropriate form, and has been received by the Engineer or the City's designated agent at least TEN (10) DAYS prior to the date for receipt of bids. Each such request shall include the name of the material or equipment for which it is to be substituted and a complete description of the proposed substitute including drawings, cuts, performance and test data, and any other information necessary for an evaluation. A statement setting forth any changes in other materials, equipment, or work that incorporation of the substitute would require, shall be included. The burden of proof of the merit and adequacy of a proposed substitute is upon the Bidder. The decision of approval or disapproval of a proposed substitution by the Engineer or the City's designated agent will be final.

If any proposed substitution is approved, such approval will be described in an addendum. Bidders shall not rely upon approvals made in any other manner.

11.4 When generic parameters for performance and/or appearance are specified, those materials which comply with specifics as delineated do not require a written request for approval. They must be capable of withstanding specification comparison, however, at the time of product data and shop drawing submittal.

12.5 Pursuant to T.S. 12-4-121, "Preference is hereby given to materials, supplies, equipment, machinery, and provisions produced, manufactured, supplied or grown in Tennessee, quality being equal to articles offered by the competitors outside of the State."

12. SUBCONTRACTORS, ETC.

12.1 If required by the City, the identity of certain Subcontractors and other persons and organizations shall be submitted to the City in advance of the Notice of Award. The apparent Successful Bidder, and any other Bidder so requested by the City, will within seven (7) days after the day of the Bid opening, submit to the City a list of names and addresses of all Subcontractors and other persons and organizations whom Bidder proposes will furnish material and/or equipment for the Work. Such list shall be accompanied by an experience statement with pertinent information as to similar projects and other evidence of qualification for each Subcontractor, person, and organization if requested by the City. If the City or Engineer after due investigation has reasonable objection to any proposed Subcontractor, or other person, or organization, the City may, before giving the Notice of Award, request the apparent Successful Bidder to submit an acceptable substitute without an increase in Bid price. If the apparent Successful Bidder declines to make any such substitution and the Agreement is not awarded to such Bidder for that reason, the Bidder's

refusal will not constitute grounds for forfeiting the Bid Guaranty. Any Subcontractor, other person, or organization so listed and to whom the City or Engineer does not make written objections prior to giving of the Notice of Award will be deemed acceptable to the Owner and Engineer.

13. BID FORM

13.1 The Bid Form is included with the Bidding Documents. Bidders shall bid all schedules and alternates (if any) as set forth in the Bid Form.

13.2 Bid Forms must be completed in ink or by typewriter. Corrections must be initialed by the Bidder. The Bid price of each item on the form must be stated in words and numerals; in case of a conflict, words will take precedence.

13.3 Bids by corporations or limited liability companies must be executed in the business entity's name by the president or a vice-president (or other officer or member accompanied by evidence of authority to sign), and the signature attested to by an authorized officer or member. The business entity's address and state of incorporation shall be shown below the signature.

13.4 Bids by partnerships must be executed in the partnership name and signed by a partner, whose title must appear under the signature. The official address of the partnership must be shown below the signature.

13.5 All names must be typed or printed below the signature.

13.6 The bid shall contain an acknowledgment of receipt of all Addenda (the numbers of which shall be filled in on the Bid Form). Failure to acknowledge receipt of Addenda shall not constitute an adjustment of the Contract Price provided on the Bid Form.

13.7 The address to which communications regarding the Bid are to be directed must be shown.

13.8 All items which are not specifically referred to in the Bid Form but are included in the plans or specifications are to be considered incidental to the performance of the major work described and shall be constructed as indicated on the plans or called for in the specifications without additional remuneration.

14. SUBMISSION OF BIDS.

14.1 Bids shall be submitted not later than the time and at the place indicated in the Advertisement for Bids and shall be included in an opaque sealed envelope, marked with the Project title and name and address of the Bidder and accompanied by the Bid Guaranty and other required documents. If the Bid is sent through the mail or other delivery system, the sealed envelope shall be enclosed in a separate envelope with the notation "BID ENCLOSED" on the face thereof. All bidding information shall be included in the sealed envelope.

14.2 Contractors' Licenses, Bids Contractors and electrical, plumbing, and HVAC subcontractors who do jobs costing \$25,000 or more must be licensed by the state (T.C.A. § 62-6-102, T.C.A. § 62-6-111). Officials issuing a permit or work order to an unlicensed contractor are guilty of a Class A misdemeanor (T.C.A. § 62-6-120). The name, license number, license expiration date, and classification of contractors applying to bid on jobs must appear on the bid envelope when the bid is more than \$25,000. If the bid is less than \$25,000, only the name of the contractor must appear on the outside of the envelope. Upon opening the envelope, if the bid exceeds \$25,000, the bid is automatically disqualified (T.C.A. § 62-6-119(b)). The name of a prime contractor who does electrical, plumbing, heating, ventilation, and air conditioning must appear on the outside of the envelope. Failure of a bidder to comply voids the bid, and it may not be opened. It is a Class A misdemeanor for any person to disregard the above requirements. Municipalities may not impose additional licensing requirements on state-licensed contractors (T.C.A. § 62-6-111(i)(2)(c)). T.C.A. § 62-6-137, however, allows municipalities to require a permit bond for contractors to ensure that the contractor complies with applicable laws and ordinances. Approving the permit bond program requires a two-thirds vote of the governing body.

15. MODIFICATION AND WITHDRAWAL OF BIDS.

15.1 Bids may be modified or withdrawn by an appropriate document duly executed (in the same manner that a Bid must be executed) and delivered to the place where Bids are to be submitted at any time prior to the opening of Bids.

15.2 If, within twenty-four (24) hours after Bids are opened, any bidder files a duly signed written notice with the City and promptly thereafter demonstrates to the satisfaction of the City that there was a material and substantial mistake in the preparation of his Bid, that Bidder may withdraw its Bid and the Bid Guaranty will be returned. Thereafter, that Bidder will be disqualified from further bidding on the Work.

16. OPENING OF BIDS.

Bids will be opened publicly and read aloud. An abstract of the bid schedule will be made available after the opening of Bids.

17. BIDS TO REMAIN EFFECTIVE.

All Bids not modified or withdrawn as provided in Section 16, shall remain effective for thirty (30) days after the day of the Bid opening, but the Owner may, in its sole discretion, release any Bid and return the Bid Guaranty prior to that date.

18. AWARD OF CONTRACT.

18.1 The City reserves the right to reject any and all Bids; to waive any and all irregularities or informalities; to negotiate specific contract terms not inconsistent with the

Advertisement for Bids, with the Successful Bidder; and to disregard all nonconforming, nonresponsive, unbalanced, or conditional Bids. Discrepancies between words and numerals will be resolved in favor of words. Discrepancies between the indicated sum of any column of numerals and the correct sum thereof will be resolved in favor of the correct sum.

18.2 A Bidder shall bid all schedules and alternates (if any) as set forth in the Bid Form. The City reserves the right in awarding the Agreement to consider the competency, responsibility, and suitability of the Bidder, as well as the amounts of the various bids. The Work, therefore, may not necessarily be awarded to the low bidder.

18.3 In evaluating Bids, the Owner reserves the right to limit the scope of the project to the monies available for the project.

18.4 The Owner may consider, among other things, the qualifications and experience of Subcontractors and other persons and organizations who are proposed to furnish material or equipment for the Work; operating costs; maintenance considerations; performance data; and guarantees of materials and equipment.

18.5 The Owner may conduct such investigations as it deems necessary to assist in the evaluation of any Bid and to establish the responsibility, qualification, and financial ability of the Bidders, proposed Subcontractors, and other persons and organizations proposed to do the Work in accordance with the Bidding Documents.

18.6 If the Agreement is to be awarded, it will be to the lowest Bidder who is determined qualified and responsible in the sole discretion and best interest of the City. The low bid shall be determined based upon an evaluation of the Total Base Bid. The City reserves the right to accept or reject alternates in any order or combination; and to accept or reject any schedule or all schedules.

If the low bid is to be awarded in any other manner, applicable laws must be consulted and the above paragraphs must be modified.

18.7 If the Agreement is to be awarded, the Owner will give the Successful Bidder a Notice of Award within thirty (30) Days after the day of the Bid opening.

19. PERFORMANCE AND PAYMENT BONDS AND INSURANCE CERTIFICATES.

The General and Supplementary Conditions set forth the City's requirements as to Performance and Payment Bonds and Insurance Certificate(s). When the Successful Bidder delivers the executed Agreement to the Owner, it shall be accompanied by the required Bonds and Insurance Certificate(s).

19.1 Pursuant to T.S. 12-4-201, no contract shall be let for any public work in this state, by any city, county or state authority, until the contractor shall have first executed a good and solvent bond to the effect that the contractor will pay for all the labors and materials used by the contractor, or any immediate or remote subcontractor under the contractor, in such contract, in lawful money of

the United States. The bond to be so given shall be for twenty-five (25%) of the contract price on all contracts in excess of one hundred thousand dollars (\$100,000). Where advertisement is made, the condition of the bond shall be stated in advertisement; provided that T.S. 12-4-201 shall not apply to contracts of one hundred thousand dollars (\$100,000) or less.

20. SIGNING OF AGREEMENT.

When the City gives a Notice of Award to the Successful Bidder, it will be accompanied by one (1) unsigned counterpart of the Agreement and the Performance and Payment Bonds. Within thirty (30) days thereafter, Contractor shall comply with the conditions precedent in the Notice of Award. Within ten (10) days thereafter, the City will deliver one (1) fully signed counterpart to Contractor. The City will deliver one signed copy of the Agreement within the project manual.

Notes:

Revised 10.11.09 paragraph 14.1 and 14.2

EXHIBIT "A"
STANDARD
BID FORM

PROJECT IDENTIFICATION: City of Lakeland, Tennessee
Project Description: FY23 Street Paving Project

THIS BID SUBMITTED TO: City of Lakeland, Tennessee
10001 U.S. Highway 70
Lakeland, Tennessee 38002

1. The undersigned Bidder proposes and agrees, if this Bid is accepted, to enter into an Agreement with the City in the form included in the Bidding Documents and to substantially complete all Work as specified or indicated in the Bidding Documents for the Contract Price by July 21, 2023, and completed and ready for final payment not later than July 28, 2023, in accordance with the Bidding Documents.
2. Bidder accepts all of the terms and conditions of the Advertisement for Bids and Instructions to Bidders, including without limitation those dealing with the disposition of Bid Guaranty. This Bid will remain effective for thirty (30) days after the day of Bid opening. Bidder will sign the Agreement and submit the Bonds and other documents required by the Bidding Documents within thirty (30) days after the date of the City's Notice of Award.
3. Notice that preferences will be granted pursuant to Tennessee Statutes is hereby acknowledged.
4. In submitting this Bid, Bidder represents, as more fully set forth in the Bidding Documents, that:
 - A. Bidder has examined copies of all the Bidding Documents and of the following addenda (receipt of all which is hereby acknowledged):

Addendum No. _____ Dated _____
Addendum No. _____ Dated _____
 - B. Bidder has examined the site and locality where the work is to be performed, the federal, state, and local Laws and Regulations, and the conditions affecting cost, progress, or performance of the work and has made such independent investigations as Bidder deems necessary;

- C. This Bid is genuine and not made in the interest of or on behalf of any undisclosed person, firm, corporation, or other business entity. Bidder has not directly or indirectly induced or solicited any other Bidder to submit a false or sham Bid. Bidder has not solicited or induced any person, firm, or a corporation to refrain from bidding. Bidder has not sought by collusion to obtain for itself any advantage over any other Bidder or against the City.
 - D. Each bidder and each person signing on behalf of any bidder certifies, and in the case of a joint bid each party thereto certifies as to its organization, under penalty of perjury, that to the best of its knowledge and belief that each bidder is not on the list created pursuant to Tennessee Statute 12-12-106
5. Bidder is bidding all schedules, alternates, if any, and will complete the Work for unit price(s) stated on the attached bid schedule based on materials actually furnished and installed and services actually provided. The Bid is summarized below on the basis of estimated quantities:

TOTAL BASE BID, IN NUMERALS: \$ _____

TOTAL BASE BID, IN WORDS: _____ DOLLARS.

- 7. Bidder agrees that the work for the City will be as provided above.
- 8. Bidder accepts the provisions of the Bidding Documents as to liquidated damages in the event of failure to complete the work on time, unless otherwise stated as provided below. Bidder agrees that such liquidated damages are not a penalty and that the amount provided is as close an estimate as possible to actual damages. Any exceptions or objections to this provision are stated in writing and attached hereto by Bidder.
- 9. The following documents are attached to and made a condition of this Bid:
 - A. Required Bid Guaranty in the form of a Bid Bond. (Unless otherwise provided by the City.)
 - B. Itemized Bid Schedule.
- 10. Communications concerning this Bid shall be addressed to:

Address of Bidder: _____

11. The terms used in this Bid are defined in and have the meanings assigned to them in the General Conditions, except as provided in the Supplementary Conditions and Bidding Documents.

Submitted on _____, 2023.

Bidder is bidding as a _____ (Insert Resident or Non-Resident)

IF BIDDER IS:

AN INDIVIDUAL

By: _____ (seal)
(Individual's Name)

doing business as: _____

Business Address: _____

Phone Number: _____

A PARTNERSHIP

By: _____ (seal)
(Firm's Name)

(General Partner)

Business Address: _____

Phone Number: _____

A CORPORATION OR LIMITED LIABILITY COMPANY

By: _____ (seal)
(Corporation's or Limited Liability Company's Name)

(State of Incorporation or Organization)

By: _____ (seal)

(Title)

(Seal)

Attest: _____

Business Address: _____

Phone Number: _____

A JOINT VENTURE

By: _____ (seal)
(Name)

(Address)

By: _____ (seal)
(Name)

(Address)

(Each joint venturer must sign. The manner of signing for each individual, partnership, and corporation that is a party to the joint venture should be in the manner indicated above.)

**BID SCHEDULE
FY2023 STREET PAVING**

BID DATE: _____

COMPANY NAME: _____

ADDRESS: _____

Contractor shall furnish and install items as shown on the Drawings or called for in the Specifications. All costs not included in the schedule that are necessary to provide a complete, functional project as depicted in the Drawings and Specifications are to be considered incidental and merged with costs of other related bid items.

LS = Lump Sum R&R = Remove and Replace LF = Linear Feet F&I = Furnish and Install
SY = Square Yard CY = Cubic Yard EA = Each Ton = Ton LB = Pounds

Schedule A

ITEM	DESCRIPTION	UNIT	QUANTITY	UNIT COST	TOTAL COST
1	Cold Planing of Asphalt Pavement	SY	67,616		
2	F&I Select Backfill (Sand)	CY	4,508		
3	F&I Granular Base (LA610)	CY	2,254		
4	F&I Geotextile	SY	6,762		
5	F&I Tack Coat	TON	29		
6	F&I Asphalt Patch	CY	376		
7	F&I Asphaltic Concrete Pavement (411-E)	TON	7,269		
8	F&I Temporary Traffic Control	LS	1		
9	R&R 6-30 Concrete Curb & Gutter	LF	2,171		
10	R&R ADA Ramps	EA	18		
11	F&I ADA Ramps	EA	2		
12	F&I Concrete Sidewalk	LF	575		
13	60 mil Thermoplastic Pavement Marking (4" Solid White Line)	LF	20,575		
14	60 mil Thermoplastic Pavement Marking (4" Double Yellow Line)	LF	10,287		
15	90 mil Thermoplastic 24" White Stop Bar	LF	29		
16	Material/ Density Testing	LS	1	\$5,000	\$5,000
17	Mobilization	EA	1		
				Total Bid Schedule A	

Total Base Bid : _____

_____ Dollars (\$ _____).

STANDARD
BID BOND

KNOW ALL MEN BY THESE PRESENTS, that we, the undersigned, _____ as Principal, and _____ as Surety, are hereby held and firmly bound, unto the City of Lakeland, Tennessee a Municipal Corporation as OWNER, in the penal sum of _____ Dollar(s) (\$ _____) for the payment of which, well and truly to be made, we hereby jointly and severally bind ourselves, successors and assigns, which represents five percent (5%) of the Principal's Total Base Bid.

The Condition of the above obligation is such that whereas the Principal has submitted to the City of Lakeland, Tennessee a certain BID, whereby it has offered to enter into an Agreement in writing with OWNER, for FY2023 Street Paving.

NOW, THEREFORE,

A. If said BID shall be rejected; or,

B. If said BID shall be accepted and the Principal shall execute and deliver the Agreement to OWNER within thirty (30) days after Notice of Award (which shall constitute presentation of the Agreement to the Principal for the purpose of execution) and shall furnish Guarantors as provided in the Bidding Documents for this Project for Principal's faithful performance of said Agreement and for the payment of all persons performing labor or furnishing materials in connection therewith, and shall otherwise proceed with the performance of said Agreement, then this obligation shall be void, otherwise the same shall remain in full force and effect and OWNER may proceed against the BOND. It is expressly understood and agreed, however, that the liability of Surety for any and all claims hereunder shall, in no event, exceed the penal amount of this obligation as herein stated.

The Surety, for value received, hereby stipulates and agrees that the obligations of said Surety and its BOND shall be in no way impaired or affected by an extension of the time within which the OWNER may accept such BID, to a maximum of ninety (90) days after its submission to OWNER; and said Surety does hereby waive notice of any such extension.

IN WITNESS WHEREOF, the Principal and the Surety have hereunto set their hands and seals, and such of them as are corporations have caused their corporate seals to be hereto affixed and these presents to be signed by their proper officers, this ____ day of _____, 2023.

STANDARD FORM OF
AGREEMENT BETWEEN OWNER AND CONTRACTOR

THIS AGREEMENT is made between the City of Lakeland, hereinafter referred to as the "Owner," and _____, hereinafter referred to as the "Contractor."

WHEREAS, the City of Lakeland is desirous of paving ; and,

WHEREAS _____ is able and willing to provide those services to the City of Lakeland, Tennessee.

NOW, THEREFORE, it is hereby agreed as follows:

ARTICLE 1. WORK.

Contractor shall perform all the work required by the Contract documents for FY23 STREET PAVING PROJECT , Lakeland, Tennessee.

ARTICLE 2. ENGINEER.

The Project has been designed by the City of Lakeland Engineering Office, 10001 U.S. Highway 70, Lakeland, Tennessee, who is hereinafter referred to as the "Engineer" and who is to act as Owner's representative, assume all duties and responsibilities and have the rights and authority assigned to Engineer in the Contract documents in connection with completion of the Work in accordance with the Contract documents.

ARTICLE 3. CONTRACT TIME.

- 3.1 The Work will be substantially completed by July 21, 2023 and completed and ready for final payment in accordance with Paragraph 15.06 of the General Conditions by July 28, 2023.
- 3.2 Liquidated Damages. Owner and Contractor recognize that time is of the essence of this Agreement and that Owner will suffer financial loss if the Work is not substantially completed by the time specified in Paragraph 3.1 above, plus any extension thereof allowed in accordance with Article 15 of the General Conditions. They also recognize the delays, expense, and difficulties involved in proving in a legal or arbitration proceeding, the actual loss suffered by Owner if the Work is not substantially completed on time. Accordingly, instead of requiring any such proof, Owner and Contractor agree that as liquidated damages for delay (but not as a penalty) Contractor shall pay Owner one Hundred Dollars (\$100.00) for each day that expires after the time specified in Paragraph 3.1 for substantial completion. After Substantial Completion, if the Contractor shall neglect, refuse, or fail to complete the remaining work within the time specified in paragraph 3.1 for completion and readiness for final payment or any proper extension thereof granted by Owner, Contractor shall pay Owner One Hundred Dollars (\$100.00)

for each day that expires after the time specified in paragraph 3.1 for completion and readiness for final payment. It is further agreed that such liquidated damages are not a penalty but represent the parties' best estimate of actual damages.

ARTICLE 4. CONTRACT PRICE.

In Consideration of the performance of the work in accordance with the Contract documents for this Unit Price Contract, Owner shall pay Contractor in current funds a not-to-exceed total contract price of _____, subject to additions and deductions by Change Order approved by the Owner. The contract fee shall be based on materials actually furnished and installed and services actually provided based on the unit prices contained in the Bid Form and Itemized Bid Schedule, included as Exhibit "A" (pages BF-1 -- BS-1) and by this reference made a part of this Agreement.

ARTICLE 5. PAYMENT PROCEDURES.

Contractor shall submit Applications for Payment in accordance with Article 15 of the General Conditions. Applications for Payment will be processed through the Engineer as provided in the General Conditions.

- 5.1 Progress Payments. Owner shall make progress payments on the basis of Contractor's Applications for Payment as recommended by Engineer, on or about the 25th day of each month during construction as provided below. All progress payments will be on the basis of the progress of the Work measured by the Schedule of Values provided for in Paragraph 15 of the General Conditions, subject to the cutoff and submittal dates provided in the General Provisions.
 - 5.1.1 During the course of the Contract progress payments will be made in an amount equal to 95% of the Work completed, less in each case the aggregate of payments previously made.
 - 5.1.2 In the event the Contractor makes only one application for payment upon substantially completing the Work, progress payment will be made in an amount equal to 95% of the Work completed. Owner shall withhold five percent (5%) of the work completed as retainage, said retainage to be paid in accordance with the provisions of Paragraph 5.2, Final Payment.
- 5.2 Final Payment. Upon final completion and acceptance of the Work in accordance with Paragraph 15.06 of the General Conditions, Engineer shall recommend payment and present Contractor's Final Application for Payment to the City in accordance with Tennessee Statutes 54-5-122. Before final acceptance of the project as having been finally completed, the contractor shall furnish evidence of payment in full for materials and labor to the City in accordance with Tennessee 54-5-122. When this is done, full settlement may be made with the contractor, but not until thirty (30) day's notice is some newspaper published in the county where the work is done, if there is a newspaper there, and if not, in a newspaper in an adjoining county that settlement is about to be made and notifying all claimants to file notice of their claims with the

officials and the period for filing shall not be less than thirty (30) days after the last published notice. In the event claims are filed, the officials shall withhold a sufficient sum to pay the claims in the same way and manner as is provided for claimants making claims against contractors dealing with the Department of Transportation in accordance with Statutes 54-5-123, and claimants may bring suits against contractors in the way and manner provided in 54-5-124, as suits are brought against contractors dealing with the department. Where claims are allowed by the Courts, Statutes 54-5-125 and 54-5-127 shall be applicable.

ARTICLE 6. WITHHELD FUNDS.

Pursuant to Tennessee Statutes Section 66-11-104 et seq., withheld percentages for Contracts exceeding \$500,000.00 will be retained in an account in the name of the Contractor (except when specifically waived in writing by Contractor) which has been assigned to the Owner until the Contract is completely, satisfactorily, and finally accepted by the Owner. Unless a depository is designated by the Contractor in a written attachment hereto, the Contractor's signature hereon shall act as authority for the Owner to designate a retainage depository on behalf of the Contractor, for the purposes specified in Tennessee Statutes Section 66-11-104. The Contractor's signature hereon shall act as an assignment of the depository account to the Owner, as provided by Tennessee Statutes Section 66-11-104 et seq., whether the depository is designated by the Contractor or by the Owner.

ARTICLE 7. CONTRACTOR'S REPRESENTATIONS.

In order to induce Owner to enter into this Agreement, Contractor makes the following representations:

- 7.1 Contractor has familiarized himself with the nature and extent of the Contract documents, Work, locality, and with all local conditions and federal, state, and local Laws and Regulations that in any manner may affect cost, progress, or performance of the Work.
- 7.2 Contractor has studied carefully all reports of investigations and test of subsurface and latent physical conditions at the site or otherwise affecting cost, progress, or performance of the Work which were relied upon by Engineer in the preparation of the Drawings and Specifications and which have been identified in the Supplementary Conditions.
- 7.3 Contractor has made or caused to be made examinations, investigations, and test and studies as he deems necessary for the performance of the Work at the Contract price, within the Contract Time, and in accordance with the other terms and conditions of the Contract documents; and no additional examinations, investigations, tests, reports, or similar data are or will be required by Contractor for such purposes.
- 7.4 Contractor has correlated the results of all such observations, examinations, investigations, tests, reports, and data with the terms and conditions of the Contract documents.

7.5 Contractor has given Engineer written notice of all conflicts, errors, or discrepancies that he has discovered in the Contract documents and the written resolution thereof by Engineer is acceptable to Contractor.

ARTICLE 8. CONTRACT DOCUMENTS.

The Contract documents which comprise the entire agreement between Owner and Contractor are attached to this Agreement, made a part hereof and consist of the following:

- 8.1 This Agreement (Pages SFA-1 to SFA-5, inclusive).
- 8.2 Joint Account Agreement or Letter of Forfeiture waiving same (if applicable)
- 8.3 Exhibit "A" - Bid Form and Bid Schedule.
- 8.4 Affidavit of Drug Free Work Program
- 8.5 Addenda
- 8.6 Performance & Payment Bonds
- 8.7 Certificates of Insurance, of Workers' Compensation Coverage, and of Unemployment Insurance Coverage.
- 8.8 2013 Standard General Conditions of the Construction Contract (Pages i to 62, inclusive).
- 8.8 Standard Supplementary Conditions (Pages SSC-1 to SSC-16, inclusive).
- 8.9 General Requirements
- 8.10 Special Provisions (Section 01810)
- 8.11 Technical Specifications
- 8.12 Notice of Award.
- 8.13 Notice to Proceed.
- 8.14 Minutes of the Pre-Bid Conference, if any.
- 8.15 Shop Drawings and other Submittals furnished by Contractor during performance of the Work and accepted by the Owner.

8.16 Any modifications, amendments, and supplements, including Change Orders, issued pursuant to Article 11 of the General Conditions, on or after the effective date of this Agreement.

8.17 Notice of Substantial Completion.

ARTICLE 9. MISCELLANEOUS PROVISIONS.

9.1 The CONTRACTOR hereby agrees, warrants, and assures compliance with the provisions of Title VI and VII of the Civil Rights Act of 1964 and all other federal statutory laws which provide in whole or in part that no person shall be excluded from participation or be denied benefits of or be otherwise subjected to discrimination in the performance of this Contract or in the employment practices of the CONTRACTOR on the grounds of handicap and/or disability, age, race, color, religion, sex, national origin, or any other classification protected by federal, Tennessee State Constitutional or statutory law. The CONTRACTOR shall upon request show proof of such non-discrimination and shall post in conspicuous places available to all employees and applicants notices of non-discrimination.

Terms used in this Agreement, which are defined in the General Conditions, shall have the meanings designated in those conditions.

IN WITNESS WHEREOF, the parties hereto have caused this Agreement to be executed in one (1) original copy on the day and year first above written.

APPROVED AS TO FORM:

(PROJECT: _____)

DATED this _____ day of _____, 2023

ATTEST:

CONTRACTOR:

By: _____

By: _____

Title: _____

Title: _____

OWNER:
CITY OF LAKELAND, TENNESSEE

ATTEST:

A Municipal Corporation

By: _____

Debra Murrell

Title: City Recorder

By: _____

Michael Walker

Title: City Manager

DRUG-FREE WORKPLACE AFFIDAVIT

STATE OF _____

COUNTY OF _____

The undersigned, principal officer of _____, an employer of five (5) or more employees contracting with _____ County government to provide construction services, hereby states under oath as follows:

1. The undersigned is a principal officer of _____ (hereinafter referred to as the "Company"), and is duly authorized to execute this Affidavit on behalf of the Company.
2. The Company submits this Affidavit pursuant to T.C.A. § 50-9-113, which requires each employer with no less than five (5) employees receiving pay who contracts with the state or any local government to provide construction services to submit an affidavit stating that such employer has a drug-free workplace program that complies with Title 50, Chapter 9, of the *Tennessee Code Annotated*.
3. The Company is in compliance with T.C.A. § 50-9-113.

Further affiant saith not.

Principal Officer

STATE OF _____

COUNTY OF _____

Before me personally appeared _____, with whom I am personally acquainted (or proved to me on the basis of satisfactory evidence), and who acknowledged that such person executed the foregoing affidavit for the purposes therein contained.

Witness my hand and seal at office this _____ day of _____, 20_____.

Notary Public

My commission expires: _____

PERFORMANCE BOND

CONTRACTOR *(name and address):*

SURETY *(name and address of principal place of business):*

OWNER *(name and address):*

City of Lakeland
10001 Highway 70, Lakeland, TN 38002

CONSTRUCTION CONTRACT

Effective Date of the Agreement: February , 2023

Amount: \$

Description *(name and location):* FY23 Street Paving Project

BOND

Bond Number:

Date *(not earlier than the Effective Date of the Agreement of the Construction Contract):*

Amount:

Modifications to this Bond Form: None See Paragraph 16

Surety and Contractor, intending to be legally bound hereby, subject to the terms set forth below, do each cause this Performance Bond to be duly executed by an authorized officer, agent, or representative.

CONTRACTOR AS PRINCIPAL

SURETY

Contractor's Name and Corporate Seal *(seal)*

Surety's Name and Corporate Seal *(seal)*

By: _____
Signature

By: _____
Signature *(attach power of attorney)*

Print Name

Print Name

Title

Title

Attest: _____
Signature

Attest: _____
Signature

Title

Title

Notes: (1) Provide supplemental execution by any additional parties, such as joint venturers. (2) Any singular reference to Contractor, Surety, Owner, or other party shall be considered plural where appl

1. The Contractor and Surety, jointly and severally, bind themselves, their heirs, executors, administrators, successors, and assigns to the Owner for the performance of the Construction Contract, which is incorporated herein by reference.

2. If the Contractor performs the Construction Contract, the Surety and the Contractor shall have no obligation under this Bond, except when applicable to participate in a conference as provided in Paragraph 3.

3. If there is no Owner Default under the Construction Contract, the Surety's obligation under this Bond shall arise after:

3.1 The Owner first provides notice to the Contractor and the Surety that the Owner is considering declaring a Contractor Default. Such notice shall indicate whether the Owner is requesting a conference among the Owner, Contractor, and Surety to discuss the Contractor's performance. If the Owner does not request a conference, the Surety may, within five (5) business days after receipt of the Owner's notice, request such a conference. If the Surety timely requests a conference, the Owner shall attend. Unless the Owner agrees otherwise, any conference requested under this Paragraph 3.1 shall be held within ten (10) business days of the Surety's receipt of the Owner's notice. If the Owner, the Contractor, and the Surety agree, the Contractor shall be allowed a reasonable time to perform the Construction Contract, but such an agreement shall not waive the Owner's right, if any, subsequently to declare a Contractor Default;

3.2 The Owner declares a Contractor Default, terminates the Construction Contract and notifies the Surety; and

3.3 The Owner has agreed to pay the Balance of the Contract Price in accordance with the terms of the Construction Contract to the Surety or to a contractor selected to perform the Construction Contract.

4. Failure on the part of the Owner to comply with the notice requirement in Paragraph 3.1 shall not constitute a failure to comply with a condition precedent to the Surety's obligations, or release the Surety from its obligations, except to the extent the Surety demonstrates actual prejudice.

5. When the Owner has satisfied the conditions of Paragraph 3, the Surety shall promptly and at the Surety's expense take one of the following actions:

5.1 Arrange for the Contractor, with the consent of the Owner, to perform and complete the Construction Contract;

5.2 Undertake to perform and complete the Construction Contract itself, through its agents or independent contractors;

5.3 Obtain bids or negotiated proposals from qualified contractors acceptable to the Owner for a contract for performance and completion of the Construction Contract, arrange for a contract to be prepared for execution by the Owner and a contractor selected with the Owners concurrence, to be secured with performance and payment bonds executed by a qualified surety equivalent to the bonds issued on the Construction Contract, and pay to the Owner the amount of damages as described in Paragraph 7 in excess of the Balance of the Contract Price incurred by the Owner as a result of the Contractor Default; or

5.4 Waive its right to perform and complete, arrange for completion, or obtain a new contractor, and with reasonable promptness under the circumstances:

5.4.1 After investigation, determine the amount for which it may be liable to the Owner and, as soon as practicable after the amount is determined, make payment to the Owner; or

5.4.2 Deny liability in whole or in part and notify the Owner, citing the reasons for denial.

6. If the Surety does not proceed as provided in Paragraph 5 with reasonable promptness, the Surety shall be deemed to be in default on this Bond seven days after receipt of an additional written notice from the Owner to the Surety demanding that the Surety perform its obligations under this Bond, and the Owner shall be entitled to enforce any remedy available to the Owner. If the Surety proceeds as provided in Paragraph 5.4, and the Owner refuses the payment or the Surety has denied liability, in whole or in part, without further notice the Owner shall be entitled to enforce any remedy available to the Owner.

7. If the Surety elects to act under Paragraph 5.1, 5.2, or 5.3, then the responsibilities of the Surety to the Owner shall not be greater than those of the Contractor under the Construction Contract, and the responsibilities of the Owner to the Surety shall not be greater than those of the Owner under the Construction Contract. Subject to the commitment by the Owner to pay the Balance of the Contract Price, the Surety is obligated, without duplication for:

7.1 the responsibilities of the Contractor for correction of defective work and completion of the Construction Contract;

7.2 additional legal, design professional, and delay costs resulting from the Contractor's Default, and

resulting from the actions or failure to act of the Surety under Paragraph 5; and

7.3 liquidated damages, or if no liquidated damages are specified in the Construction Contract, actual damages caused by delayed performance or non-performance of the Contractor.

8. If the Surety elects to act under Paragraph 5.1, 5.3, or 5.4, the Surety's liability is limited to the amount of this Bond.

9. The Surety shall not be liable to the Owner or others for obligations of the Contractor that are unrelated to the Construction Contract, and the Balance of the Contract Price shall not be reduced or set off on account of any such unrelated obligations. No right of action shall accrue on this Bond to any person or entity other than the Owner or its heirs, executors, administrators, successors, and assigns.

10. The Surety hereby waives notice of any change, including changes of time, to the Construction Contract or to related subcontracts, purchase orders, and other obligations.

11. Any proceeding, legal or equitable, under this Bond may be instituted in any court of competent jurisdiction in the location in which the work or part of the work is located and shall be instituted within two years after a declaration of Contractor Default or within two years after the Contractor ceased working or within two years after the Surety refuses or fails to perform its obligations under this Bond, whichever occurs first. If the provisions of this paragraph are void or prohibited by law, the minimum periods of limitations available to sureties as a defense in the jurisdiction of the suit shall be applicable.

12. Notice to the Surety, the Owner, or the Contractor shall be mailed or delivered to the address shown on the page on which their signature appears.

13. When this Bond has been furnished to comply with a statutory or other legal requirement in the location where the construction was to be performed, any provision in this Bond conflicting with said statutory or legal requirement shall be deemed deleted herefrom and provisions conforming to such statutory or other legal requirement shall be deemed incorporated herein. When so furnished, the intent is that this Bond shall be construed as a statutory bond and not as a common law bond.

14. Definitions

14.1 Balance of the Contract Price: The total amount payable by the Owner to the Contractor under the Construction Contract after all proper adjustments have been made including allowance for the Contractor for any amounts received or to be received by the Owner in settlement of insurance or other claims for damages to which the Contractor is entitled, reduced by all valid and proper payments made to or on behalf of the Contractor under the Construction Contract.

14.2 Construction Contract: The agreement between the Owner and Contractor identified on the cover page, including all Contract Documents and changes made to the agreement and the Contract Documents.

14.3 Contractor Default: Failure of the Contractor, which has not been remedied or waived, to perform or otherwise to comply with a material term of the Construction Contract.

14.4 Owner Default: Failure of the Owner, which has not been remedied or waived, to pay the Contractor as required under the Construction Contract or to perform and complete or comply with the other material terms of the Construction Contract.

14.5 Contract Documents: All the documents that comprise the agreement between the Owner and Contractor.

15. If this Bond is issued for an agreement between a contractor and subcontractor, the term Contractor in this Bond shall be deemed to be Subcontractor and the term Owner shall be deemed to be Contractor.

16. Modifications to this Bond are as follows:

PAYMENT BOND

Any singular reference to Contractor, Surety, Owner, or other party shall be considered plural where applicable.

CONTRACTOR (*Name and Address*):

SURETY (*Name, and Address of Principal Place of Business*):

OWNER (*Name and Address*):

City of Lakeland
10001 Highway 70, Lakeland, TN 38002

CONTRACT

Effective Date of

Agreement: February, 2023

Amount: \$

Description (*Name and Location*): **FY23 Street Paving**

BOND

Bond Number:

Date (*Not earlier than Effective Date of Agreement*):

Amount:

Modifications to this Bond Form:

Surety and Contractor, intending to be legally bound hereby, subject to the terms set forth below, do each cause this Payment Bond to be duly executed by an authorized officer, agent, or representative.

CONTRACTOR AS PRINCIPAL

SURETY

(Seal)
Contractor's Name and Corporate Seal

(Seal)
Surety's Name and Corporate Seal

By: _____
Signature

By: _____
Signature (Attach Power of Attorney)

Print Name

Print Name

Title

Title

Attest: _____
Signature

Attest: _____
Signature

Title

Title

Note: Provide execution by additional parties, such as joint venturers, if necessary.

1. Contractor and Surety, jointly and severally, bind themselves, their heirs, executors, administrators, successors, and assigns to Owner to pay for labor, materials, and equipment furnished by Claimants for use in the performance of the Contract, which is incorporated herein by reference.
2. With respect to Owner, this obligation shall be null and void if Contractor:
 - 2.1 Promptly makes payment, directly or indirectly, for all sums due Claimants, and
 - 2.2 Defends, indemnifies, and holds harmless Owner from all claims, demands, liens, or suits alleging non-payment by Contractor by any person or entity who furnished labor, materials, or equipment for use in the performance of the Contract, provided Owner has promptly notified Contractor and Surety (at the addresses described in Paragraph 12) of any claims, demands, liens, or suits and tendered defense of such claims, demands, liens, or suits to Contractor and Surety, and provided there is no Owner Default.
3. With respect to Claimants, this obligation shall be null and void if Contractor promptly makes payment, directly or indirectly, for all sums due.
4. Surety shall have no obligation to Claimants under this Bond until:
 - 4.1 Claimants who are employed by or have a direct contract with Contractor have given notice to Surety (at the address described in Paragraph 12) and sent a copy, or notice thereof, to Owner, stating that a claim is being made under this Bond and, with substantial accuracy, the amount of the claim.
 - 4.2 Claimants who do not have a direct contract with Contractor:
 1. Have furnished written notice to Contractor and sent a copy, or notice thereof, to Owner, within 90 days after having last performed labor or last furnished materials or equipment included in the claim stating, with substantial accuracy, the amount of the claim and the name of the party to whom the materials or equipment were furnished or supplied, or for whom the labor was done or performed; and
 2. Have either received a rejection in whole or in part from Contractor, or not received within 30 days of furnishing the above notice any communication from Contractor by which Contractor had indicated the claim will be paid directly or indirectly; and
 3. Not having been paid within the above 30 days, have sent a written notice to Surety (at the address described in Paragraph 12) and sent a copy, or notice thereof, to Owner, stating that a claim is being made under this Bond and enclosing a copy of the previous written notice furnished to Contractor.
5. If a notice by a Claimant required by Paragraph 4 is provided by Owner to Contractor or to Surety, that is sufficient compliance.
6. Reserved.
7. Surety's total obligation shall not exceed the amount of this Bond, and the amount of this Bond shall be credited for any payments made in good faith by Surety.
8. Amounts owed by Owner to Contractor under the Contract shall be used for the performance of the Contract and to satisfy claims, if any, under any performance bond. By Contractor furnishing and Owner accepting this Bond, they agree that all funds earned by Contractor in the performance of the Contract are dedicated to satisfy obligations of Contractor and Surety under this Bond, subject to Owner's priority to use the funds for the completion of the Work.
9. Surety shall not be liable to Owner, Claimants, or others for obligations of Contractor that are unrelated to the Contract. Owner shall not be liable for payment of any costs or expenses of any Claimant under this Bond, and shall have under this Bond no obligations to make payments to, give notices on behalf of, or otherwise have obligations to Claimants under this Bond.
10. Surety hereby waives notice of any change, including changes of time, to the Contract or to related

subcontracts, purchase orders, and other obligations.

11. No suit or action shall be commenced by a Claimant under this Bond other than in a court of competent jurisdiction in the location in which the Work or part of the Work is located or after the expiration of one year from the date (1) on which the Claimant gave the notice required by Paragraph 4.1 or Paragraph 4.2.3, or (2) on which the last labor or service was performed by anyone or the last materials or equipment were furnished by anyone under the Contract, whichever of (1) or (2) first occurs. If the provisions of this paragraph are void or prohibited by law, the minimum period of limitation available to sureties as a defense in the jurisdiction of the suit shall be applicable.

12. Notice to Surety, Owner, or Contractor shall be mailed or delivered to the addresses shown on the signature page. Actual receipt of notice by Surety, Owner, or Contractor, however accomplished, shall be sufficient compliance as of the date received at the address shown on the signature page.

13. When this Bond has been furnished to comply with a statutory requirement in the location where the Contract was to be performed, any provision in this Bond conflicting with said statutory requirement shall be deemed deleted herefrom and provisions conforming to such statutory requirement shall be deemed incorporated herein. The intent is that this Bond shall be construed as a statutory Bond and not as a common law bond.

14. Upon request of any person or entity appearing to be a potential beneficiary of this Bond, Contractor shall promptly furnish a copy of this Bond or shall permit a copy to be made.

15. Definitions

15.1 Claimant: An individual or entity having a direct contract with Contractor, or with a first-tier subcontractor of Contractor, to furnish labor, materials, or equipment for use in the performance of the Contract. The intent of this Bond shall be to include without limitation in the terms “labor, materials or equipment” that part of water, gas, power, light, heat, oil, gasoline, telephone service, or rental equipment used in the Contract, architectural and engineering services required for performance of the Work of Contractor and Contractor’s subcontractors, and all other items for which a mechanic’s lien may be asserted in the jurisdiction where the labor, materials, or equipment were furnished.

15.2 Contract: The agreement between Owner and Contractor identified on the signature page, including all Contract Documents and changes thereto.

15.3 Owner Default: Failure of Owner, which has neither been remedied nor waived, to pay Contractor as required by the Contract, or to perform and complete or otherwise comply with the other terms thereof.

FOR INFORMATION ONLY – (*Name, Address, and Telephone*)

Surety Agency or Broker:

Owner’s Representative (*Engineer or other*):

This document has important legal consequences; consultation with an attorney is encouraged with respect to its use or modification. This document should be adapted to the particular circumstances of the contemplated Project and the controlling Laws and Regulations.

STANDARD GENERAL CONDITIONS OF THE CONSTRUCTION CONTRACT

Prepared by



Issued and Published Jointly by



Endorsed by



These General Conditions have been prepared for use with the Agreement Between Owner and Contractor for Construction Contract (EJCDC® C-520, Stipulated Sum, or C-525, Cost-Plus, 2013 Editions). Their provisions are interrelated and a change in one may necessitate a change in the other.

To prepare supplementary conditions that are coordinated with the General Conditions, use EJCDC's Guide to the Preparation of Supplementary Conditions (EJCDC® C-800, 2013 Edition). The full EJCDC Construction series of documents is discussed in the Commentary on the 2013 EJCDC Construction Documents (EJCDC® C-001, 2013 Edition).

Copyright © 2013:

National Society of Professional Engineers
1420 King Street, Alexandria, VA 22314-2794
(703) 684-2882
www.nspe.org

American Council of Engineering Companies
1015 15th Street N.W., Washington, DC 20005
(202) 347-7474
www.acec.org

American Society of Civil Engineers
1801 Alexander Bell Drive, Reston, VA 20191-4400
(800) 548-2723
www.asce.org

The copyright for this document is owned jointly by the three sponsoring organizations listed above. The National Society of Professional Engineers is the Copyright Administrator for the EJCDC documents; please direct all inquiries regarding EJCDC copyrights to NSPE.

NOTE: EJCDC publications may be purchased at www.ejcdc.org, or from any of the sponsoring organizations above.

STANDARD GENERAL CONDITIONS OF THE CONSTRUCTION CONTRACT

TABLE OF CONTENTS

	Page
Article 1 – Definitions and Terminology	1
1.01 Defined Terms	1
1.02 Terminology	5
Article 2 – Preliminary Matters.....	6
2.01 Delivery of Bonds and Evidence of Insurance	6
2.02 Copies of Documents	6
2.03 Before Starting Construction	6
2.04 Preconstruction Conference; Designation of Authorized Representatives	7
2.05 Initial Acceptance of Schedules	7
2.06 Electronic Transmittals.....	7
Article 3 – Documents: Intent, Requirements, Reuse	8
3.01 Intent.....	8
3.02 Reference Standards	8
3.03 Reporting and Resolving Discrepancies	8
3.04 Requirements of the Contract Documents	9
3.05 Reuse of Documents	10
Article 4 – Commencement and Progress of the Work	10
4.01 Commencement of Contract Times; Notice to Proceed	10
4.02 Starting the Work.....	10
4.03 Reference Points	10
4.04 Progress Schedule	10
4.05 Delays in Contractor’s Progress	11
Article 5 – Availability of Lands; Subsurface and Physical Conditions; Hazardous Environmental Conditions	12
5.01 Availability of Lands	12
5.02 Use of Site and Other Areas	12
5.03 Subsurface and Physical Conditions.....	13
5.04 Differing Subsurface or Physical Conditions	14
5.05 Underground Facilities	15

5.06	Hazardous Environmental Conditions at Site	17
Article 6 – Bonds and Insurance		19
6.01	Performance, Payment, and Other Bonds	19
6.02	Insurance—General Provisions	19
6.03	Contractor’s Insurance	20
6.04	Owner’s Liability Insurance	23
6.05	Property Insurance.....	23
6.06	Waiver of Rights	25
6.07	Receipt and Application of Property Insurance Proceeds	25
Article 7 – Contractor’s Responsibilities		26
7.01	Supervision and Superintendence	26
7.02	Labor; Working Hours	26
7.03	Services, Materials, and Equipment.....	26
7.04	“Or Equals”	27
7.05	Substitutes	28
7.06	Concerning Subcontractors, Suppliers, and Others	29
7.07	Patent Fees and Royalties	31
7.08	Permits	31
7.09	Taxes	32
7.10	Laws and Regulations.....	32
7.11	Record Documents.....	32
7.12	Safety and Protection.....	32
7.13	Safety Representative	33
7.14	Hazard Communication Programs	33
7.15	Emergencies	34
7.16	Shop Drawings, Samples, and Other Submittals.....	34
7.17	Contractor’s General Warranty and Guarantee.....	36
7.18	Indemnification	37
7.19	Delegation of Professional Design Services	37
Article 8 – Other Work at the Site		38
8.01	Other Work	38
8.02	Coordination	39
8.03	Legal Relationships.....	39

Article 9 – Owner’s Responsibilities.....	40
9.01 Communications to Contractor.....	40
9.02 Replacement of Engineer	40
9.03 Furnish Data	40
9.04 Pay When Due.....	40
9.05 Lands and Easements; Reports, Tests, and Drawings	40
9.06 Insurance.....	40
9.07 Change Orders.....	40
9.08 Inspections, Tests, and Approvals.....	41
9.09 Limitations on Owner’s Responsibilities	41
9.10 Undisclosed Hazardous Environmental Condition.....	41
9.11 Evidence of Financial Arrangements.....	41
9.12 Safety Programs	41
Article 10 – Engineer’s Status During Construction.....	41
10.01 Owner’s Representative.....	41
10.02 Visits to Site.....	41
10.03 Project Representative.....	42
10.04 Rejecting Defective Work.....	42
10.05 Shop Drawings, Change Orders and Payments.....	42
10.06 Determinations for Unit Price Work	42
10.07 Decisions on Requirements of Contract Documents and Acceptability of Work	42
10.08 Limitations on Engineer’s Authority and Responsibilities.....	42
10.09 Compliance with Safety Program.....	43
Article 11 – Amending the Contract Documents; Changes in the Work	43
11.01 Amending and Supplementing Contract Documents	43
11.02 Owner-Authorized Changes in the Work	44
11.03 Unauthorized Changes in the Work	44
11.04 Change of Contract Price	44
11.05 Change of Contract Times	45
11.06 Change Proposals	45
11.07 Execution of Change Orders.....	46
11.08 Notification to Surety.....	47
Article 12 – Claims.....	47

12.01	Claims	47
Article 13 –	Cost of the Work; Allowances; Unit Price Work.....	48
13.01	Cost of the Work	48
13.02	Allowances	50
13.03	Unit Price Work	51
Article 14 –	Tests and Inspections; Correction, Removal or Acceptance of Defective Work.....	52
14.01	Access to Work.....	52
14.02	Tests, Inspections, and Approvals.....	52
14.03	Defective Work.....	53
14.04	Acceptance of Defective Work.....	53
14.05	Uncovering Work	53
14.06	Owner May Stop the Work	54
14.07	Owner May Correct Defective Work.....	54
Article 15 –	Payments to Contractor; Set-Offs; Completion; Correction Period	55
15.01	Progress Payments.....	55
15.02	Contractor’s Warranty of Title	58
15.03	Substantial Completion.....	58
15.04	Partial Use or Occupancy	59
15.05	Final Inspection	59
15.06	Final Payment.....	59
15.07	Waiver of Claims	61
15.08	Correction Period	61
Article 16 –	Suspension of Work and Termination	62
16.01	Owner May Suspend Work	62
16.02	Owner May Terminate for Cause	62
16.03	Owner May Terminate For Convenience	63
16.04	Contractor May Stop Work or Terminate	63
Article 17 –	Final Resolution of Disputes	64
17.01	Methods and Procedures.....	64
Article 18 –	Miscellaneous	64
18.01	Giving Notice	64
18.02	Computation of Times.....	64
18.03	Cumulative Remedies	64

18.04	Limitation of Damages	65
18.05	No Waiver	65
18.06	Survival of Obligations	65
18.07	Controlling Law	65
18.08	Headings.....	65

ARTICLE 1 – DEFINITIONS AND TERMINOLOGY

1.01 *Defined Terms*

- A. Wherever used in the Bidding Requirements or Contract Documents, a term printed with initial capital letters, including the term's singular and plural forms, will have the meaning indicated in the definitions below. In addition to terms specifically defined, terms with initial capital letters in the Contract Documents include references to identified articles and paragraphs, and the titles of other documents or forms.
1. *Addenda*—Written or graphic instruments issued prior to the opening of Bids which clarify, correct, or change the Bidding Requirements or the proposed Contract Documents.
 2. *Agreement*—The written instrument, executed by Owner and Contractor, that sets forth the Contract Price and Contract Times, identifies the parties and the Engineer, and designates the specific items that are Contract Documents.
 3. *Application for Payment*—The form acceptable to Engineer which is to be used by Contractor during the course of the Work in requesting progress or final payments and which is to be accompanied by such supporting documentation as is required by the Contract Documents.
 4. *Bid*—The offer of a Bidder submitted on the prescribed form setting forth the prices for the Work to be performed.
 5. *Bidder*—An individual or entity that submits a Bid to Owner.
 6. *Bidding Documents*—The Bidding Requirements, the proposed Contract Documents, and all Addenda.
 7. *Bidding Requirements*—The advertisement or invitation to bid, Instructions to Bidders, Bid Bond or other Bid security, if any, the Bid Form, and the Bid with any attachments.
 8. *Change Order*—A document which is signed by Contractor and Owner and authorizes an addition, deletion, or revision in the Work or an adjustment in the Contract Price or the Contract Times, or other revision to the Contract, issued on or after the Effective Date of the Contract.
 9. *Change Proposal*—A written request by Contractor, duly submitted in compliance with the procedural requirements set forth herein, seeking an adjustment in Contract Price or Contract Times, or both; contesting an initial decision by Engineer concerning the requirements of the Contract Documents or the acceptability of Work under the Contract Documents; challenging a set-off against payments due; or seeking other relief with respect to the terms of the Contract.
 10. *Claim*—(a) A demand or assertion by Owner directly to Contractor, duly submitted in compliance with the procedural requirements set forth herein: seeking an adjustment of Contract Price or Contract Times, or both; contesting an initial decision by Engineer concerning the requirements of the Contract Documents or the acceptability of Work under the Contract Documents; contesting Engineer's decision regarding a Change Proposal; seeking resolution of a contractual issue that Engineer has declined to address; or seeking other relief with respect to the terms of the Contract; or (b) a demand or assertion by Contractor directly to Owner, duly submitted in compliance with the procedural requirements set forth herein, contesting Engineer's decision regarding a Change Proposal; or seeking resolution of a contractual issue that Engineer

has declined to address. A demand for money or services by a third party is not a Claim.

11. *Constituent of Concern*—Asbestos, petroleum, radioactive materials, polychlorinated biphenyls (PCBs), hazardous waste, and any substance, product, waste, or other material of any nature whatsoever that is or becomes listed, regulated, or addressed pursuant to (a) the Comprehensive Environmental Response, Compensation and Liability Act, 42 U.S.C. §§9601 et seq. (“CERCLA”); (b) the Hazardous Materials Transportation Act, 49 U.S.C. §§5101 et seq.; (c) the Resource Conservation and Recovery Act, 42 U.S.C. §§6901 et seq. (“RCRA”); (d) the Toxic Substances Control Act, 15 U.S.C. §§2601 et seq.; (e) the Clean Water Act, 33 U.S.C. §§1251 et seq.; (f) the Clean Air Act, 42 U.S.C. §§7401 et seq.; or (g) any other federal, state, or local statute, law, rule, regulation, ordinance, resolution, code, order, or decree regulating, relating to, or imposing liability or standards of conduct concerning, any hazardous, toxic, or dangerous waste, substance, or material.
12. *Contract*—The entire and integrated written contract between the Owner and Contractor concerning the Work.
13. *Contract Documents*—Those items so designated in the Agreement, and which together comprise the Contract.
14. *Contract Price*—The money that Owner has agreed to pay Contractor for completion of the Work in accordance with the Contract Documents. .
15. *Contract Times*—The number of days or the dates by which Contractor shall: (a) achieve Milestones, if any; (b) achieve Substantial Completion; and (c) complete the Work.
16. *Contractor*—The individual or entity with which Owner has contracted for performance of the Work.
17. *Cost of the Work*—See Paragraph 13.01 for definition.
18. *Drawings*—The part of the Contract that graphically shows the scope, extent, and character of the Work to be performed by Contractor.
19. *Effective Date of the Contract*—The date, indicated in the Agreement, on which the Contract becomes effective.
20. *Engineer*—The individual or entity named as such in the Agreement.
21. *Field Order*—A written order issued by Engineer which requires minor changes in the Work but does not change the Contract Price or the Contract Times.
22. *Hazardous Environmental Condition*—The presence at the Site of Constituents of Concern in such quantities or circumstances that may present a danger to persons or property exposed thereto. The presence at the Site of materials that are necessary for the execution of the Work, or that are to be incorporated in the Work, and that are controlled and contained pursuant to industry practices, Laws and Regulations, and the requirements of the Contract, does not establish a Hazardous Environmental Condition.
23. *Laws and Regulations; Laws or Regulations*—Any and all applicable laws, statutes, rules, regulations, ordinances, codes, and orders of any and all governmental bodies, agencies, authorities, and courts having jurisdiction.

24. *Liens*—Charges, security interests, or encumbrances upon Contract-related funds, real property, or personal property.
25. *Milestone*—A principal event in the performance of the Work that the Contract requires Contractor to achieve by an intermediate completion date or by a time prior to Substantial Completion of all the Work.
26. *Notice of Award*—The written notice by Owner to a Bidder of Owner’s acceptance of the Bid.
27. *Notice to Proceed*—A written notice by Owner to Contractor fixing the date on which the Contract Times will commence to run and on which Contractor shall start to perform the Work.
28. *Owner*—The individual or entity with which Contractor has contracted regarding the Work, and which has agreed to pay Contractor for the performance of the Work, pursuant to the terms of the Contract.
29. *Progress Schedule*—A schedule, prepared and maintained by Contractor, describing the sequence and duration of the activities comprising the Contractor’s plan to accomplish the Work within the Contract Times.
30. *Project*—The total undertaking to be accomplished for Owner by engineers, contractors, and others, including planning, study, design, construction, testing, commissioning, and start-up, and of which the Work to be performed under the Contract Documents is a part.
31. *Project Manual*—The written documents prepared for, or made available for, procuring and constructing the Work, including but not limited to the Bidding Documents or other construction procurement documents, geotechnical and existing conditions information, the Agreement, bond forms, General Conditions, Supplementary Conditions, and Specifications. The contents of the Project Manual may be bound in one or more volumes.
32. *Resident Project Representative*—The authorized representative of Engineer assigned to assist Engineer at the Site. As used herein, the term Resident Project Representative or “RPR” includes any assistants or field staff of Resident Project Representative.
33. *Samples*—Physical examples of materials, equipment, or workmanship that are representative of some portion of the Work and that establish the standards by which such portion of the Work will be judged.
34. *Schedule of Submittals*—A schedule, prepared and maintained by Contractor, of required submittals and the time requirements for Engineer’s review of the submittals and the performance of related construction activities.
35. *Schedule of Values*—A schedule, prepared and maintained by Contractor, allocating portions of the Contract Price to various portions of the Work and used as the basis for reviewing Contractor’s Applications for Payment.
36. *Shop Drawings*—All drawings, diagrams, illustrations, schedules, and other data or information that are specifically prepared or assembled by or for Contractor and submitted by Contractor to illustrate some portion of the Work. Shop Drawings, whether approved or not, are not Drawings and are not Contract Documents.

37. *Site*—Lands or areas indicated in the Contract Documents as being furnished by Owner upon which the Work is to be performed, including rights-of-way and easements, and such other lands furnished by Owner which are designated for the use of Contractor.
38. *Specifications*—The part of the Contract that consists of written requirements for materials, equipment, systems, standards, and workmanship as applied to the Work, and certain administrative requirements and procedural matters applicable to the Work.
39. *Subcontractor*—An individual or entity having a direct contract with Contractor or with any other Subcontractor for the performance of a part of the Work.
40. *Substantial Completion*—The time at which the Work (or a specified part thereof) has progressed to the point where, in the opinion of Engineer, the Work (or a specified part thereof) is sufficiently complete, in accordance with the Contract Documents, so that the Work (or a specified part thereof) can be utilized for the purposes for which it is intended. The terms “substantially complete” and “substantially completed” as applied to all or part of the Work refer to Substantial Completion thereof.
41. *Successful Bidder*—The Bidder whose Bid the Owner accepts, and to which the Owner makes an award of contract, subject to stated conditions.
42. *Supplementary Conditions*—The part of the Contract that amends or supplements these General Conditions.
43. *Supplier*—A manufacturer, fabricator, supplier, distributor, materialman, or vendor having a direct contract with Contractor or with any Subcontractor to furnish materials or equipment to be incorporated in the Work by Contractor or a Subcontractor.
44. *Technical Data*—Those items expressly identified as Technical Data in the Supplementary Conditions, with respect to either (a) subsurface conditions at the Site, or physical conditions relating to existing surface or subsurface structures at the Site (except Underground Facilities) or (b) Hazardous Environmental Conditions at the Site. If no such express identifications of Technical Data have been made with respect to conditions at the Site, then the data contained in boring logs, recorded measurements of subsurface water levels, laboratory test results, and other factual, objective information regarding conditions at the Site that are set forth in any geotechnical or environmental report prepared for the Project and made available to Contractor are hereby defined as Technical Data with respect to conditions at the Site under Paragraphs 5.03, 5.04, and 5.06.
45. *Underground Facilities*—All underground pipelines, conduits, ducts, cables, wires, manholes, vaults, tanks, tunnels, or other such facilities or attachments, and any encasements containing such facilities, including but not limited to those that convey electricity, gases, steam, liquid petroleum products, telephone or other communications, fiber optic transmissions, cable television, water, wastewater, storm water, other liquids or chemicals, or traffic or other control systems.
46. *Unit Price Work*—Work to be paid for on the basis of unit prices.
47. *Work*—The entire construction or the various separately identifiable parts thereof required to be provided under the Contract Documents. Work includes and is the result of performing or providing all labor, services, and documentation necessary to produce such construction; furnishing, installing, and incorporating all materials and equipment into such construction; and may include related services such as testing, start-up, and commissioning, all as required by the Contract Documents.

48. *Work Change Directive*—A written directive to Contractor issued on or after the Effective Date of the Contract, signed by Owner and recommended by Engineer, ordering an addition, deletion, or revision in the Work.

1.02 Terminology

- A. The words and terms discussed in the following paragraphs are not defined but, when used in the Bidding Requirements or Contract Documents, have the indicated meaning.
- B. *Intent of Certain Terms or Adjectives:*
 1. The Contract Documents include the terms “as allowed,” “as approved,” “as ordered,” “as directed” or terms of like effect or import to authorize an exercise of professional judgment by Engineer. In addition, the adjectives “reasonable,” “suitable,” “acceptable,” “proper,” “satisfactory,” or adjectives of like effect or import are used to describe an action or determination of Engineer as to the Work. It is intended that such exercise of professional judgment, action, or determination will be solely to evaluate, in general, the Work for compliance with the information in the Contract Documents and with the design concept of the Project as a functioning whole as shown or indicated in the Contract Documents (unless there is a specific statement indicating otherwise). The use of any such term or adjective is not intended to and shall not be effective to assign to Engineer any duty or authority to supervise or direct the performance of the Work, or any duty or authority to undertake responsibility contrary to the provisions of Article 10 or any other provision of the Contract Documents.
- C. *Day:*
 1. The word “day” means a calendar day of 24 hours measured from midnight to the next midnight.
- D. *Defective:*
 1. The word “defective,” when modifying the word “Work,” refers to Work that is unsatisfactory, faulty, or deficient in that it:
 - a. does not conform to the Contract Documents; or
 - b. does not meet the requirements of any applicable inspection, reference standard, test, or approval referred to in the Contract Documents; or
 - c. has been damaged prior to Engineer’s recommendation of final payment (unless responsibility for the protection thereof has been assumed by Owner at Substantial Completion in accordance with Paragraph 15.03 or 15.04).
- E. *Furnish, Install, Perform, Provide:*
 1. The word “furnish,” when used in connection with services, materials, or equipment, shall mean to supply and deliver said services, materials, or equipment to the Site (or some other specified location) ready for use or installation and in usable or operable condition.
 2. The word “install,” when used in connection with services, materials, or equipment, shall mean to put into use or place in final position said services, materials, or equipment complete and ready for intended use.

3. The words “perform” or “provide,” when used in connection with services, materials, or equipment, shall mean to furnish and install said services, materials, or equipment complete and ready for intended use.
 4. If the Contract Documents establish an obligation of Contractor with respect to specific services, materials, or equipment, but do not expressly use any of the four words “furnish,” “install,” “perform,” or “provide,” then Contractor shall furnish and install said services, materials, or equipment complete and ready for intended use.
- F. Unless stated otherwise in the Contract Documents, words or phrases that have a well-known technical or construction industry or trade meaning are used in the Contract Documents in accordance with such recognized meaning.

ARTICLE 2 – PRELIMINARY MATTERS

2.01 *Delivery of Bonds and Evidence of Insurance*

- A. *Bonds*: When Contractor delivers the executed counterparts of the Agreement to Owner, Contractor shall also deliver to Owner such bonds as Contractor may be required to furnish.
- B. *Evidence of Contractor’s Insurance*: When Contractor delivers the executed counterparts of the Agreement to Owner, Contractor shall also deliver to Owner, with copies to each named insured and additional insured (as identified in the Supplementary Conditions or elsewhere in the Contract), the certificates and other evidence of insurance required to be provided by Contractor in accordance with Article 6.
- C. *Evidence of Owner’s Insurance*: After receipt of the executed counterparts of the Agreement and all required bonds and insurance documentation, Owner shall promptly deliver to Contractor, with copies to each named insured and additional insured (as identified in the Supplementary Conditions or otherwise), the certificates and other evidence of insurance required to be provided by Owner under Article 6.

2.02 *Copies of Documents*

- A. Owner shall furnish to Contractor four printed copies of the Contract (including one fully executed counterpart of the Agreement), and one copy in electronic portable document format (PDF). Additional printed copies will be furnished upon request at the cost of reproduction.
- B. Owner shall maintain and safeguard at least one original printed record version of the Contract, including Drawings and Specifications signed and sealed by Engineer and other design professionals. Owner shall make such original printed record version of the Contract available to Contractor for review. Owner may delegate the responsibilities under this provision to Engineer.

2.03 *Before Starting Construction*

- A. *Preliminary Schedules*: Within 10 days after the Effective Date of the Contract (or as otherwise specifically required by the Contract Documents), Contractor shall submit to Engineer for timely review:
 1. a preliminary Progress Schedule indicating the times (numbers of days or dates) for starting and completing the various stages of the Work, including any Milestones specified in the Contract;
 2. a preliminary Schedule of Submittals; and

3. a preliminary Schedule of Values for all of the Work which includes quantities and prices of items which when added together equal the Contract Price and subdivides the Work into component parts in sufficient detail to serve as the basis for progress payments during performance of the Work. Such prices will include an appropriate amount of overhead and profit applicable to each item of Work.

2.04 *Preconstruction Conference; Designation of Authorized Representatives*

- A. Before any Work at the Site is started, a conference attended by Owner, Contractor, Engineer, and others as appropriate will be held to establish a working understanding among the parties as to the Work and to discuss the schedules referred to in Paragraph 2.03.A, procedures for handling Shop Drawings, Samples, and other submittals, processing Applications for Payment, electronic or digital transmittals, and maintaining required records.
- B. At this conference Owner and Contractor each shall designate, in writing, a specific individual to act as its authorized representative with respect to the services and responsibilities under the Contract. Such individuals shall have the authority to transmit and receive information, render decisions relative to the Contract, and otherwise act on behalf of each respective party.

2.05 *Initial Acceptance of Schedules*

- A. At least 10 days before submission of the first Application for Payment a conference, attended by Contractor, Engineer, and others as appropriate, will be held to review for acceptability to Engineer as provided below the schedules submitted in accordance with Paragraph 2.03.A. Contractor shall have an additional 10 days to make corrections and adjustments and to complete and resubmit the schedules. No progress payment shall be made to Contractor until acceptable schedules are submitted to Engineer.
 1. The Progress Schedule will be acceptable to Engineer if it provides an orderly progression of the Work to completion within the Contract Times. Such acceptance will not impose on Engineer responsibility for the Progress Schedule, for sequencing, scheduling, or progress of the Work, nor interfere with or relieve Contractor from Contractor's full responsibility therefor.
 2. Contractor's Schedule of Submittals will be acceptable to Engineer if it provides a workable arrangement for reviewing and processing the required submittals.
 3. Contractor's Schedule of Values will be acceptable to Engineer as to form and substance if it provides a reasonable allocation of the Contract Price to the component parts of the Work.

2.06 *Electronic Transmittals*

- A. Except as otherwise stated elsewhere in the Contract, the Owner, Engineer, and Contractor may transmit, and shall accept, Project-related correspondence, text, data, documents, drawings, information, and graphics, including but not limited to Shop Drawings and other submittals, in electronic media or digital format, either directly, or through access to a secure Project website.
- B. If the Contract does not establish protocols for electronic or digital transmittals, then Owner, Engineer, and Contractor shall jointly develop such protocols.
- C. When transmitting items in electronic media or digital format, the transmitting party makes no representations as to long term compatibility, usability, or readability of the items resulting from the recipient's use of software application packages, operating systems, or

computer hardware differing from those used in the drafting or transmittal of the items, or from those established in applicable transmittal protocols.

ARTICLE 3 – DOCUMENTS: INTENT, REQUIREMENTS, REUSE

3.01 *Intent*

- A. The Contract Documents are complementary; what is required by one is as binding as if required by all.
- B. It is the intent of the Contract Documents to describe a functionally complete project (or part thereof) to be constructed in accordance with the Contract Documents.
- C. Unless otherwise stated in the Contract Documents, if there is a discrepancy between the electronic or digital versions of the Contract Documents (including any printed copies derived from such electronic or digital versions) and the printed record version, the printed record version shall govern.
- D. The Contract supersedes prior negotiations, representations, and agreements, whether written or oral.
- E. Engineer will issue clarifications and interpretations of the Contract Documents as provided herein.

3.02 *Reference Standards*

- A. Standards Specifications, Codes, Laws and Regulations
 - 1. Reference in the Contract Documents to standard specifications, manuals, reference standards, or codes of any technical society, organization, or association, or to Laws or Regulations, whether such reference be specific or by implication, shall mean the standard specification, manual, reference standard, code, or Laws or Regulations in effect at the time of opening of Bids (or on the Effective Date of the Contract if there were no Bids), except as may be otherwise specifically stated in the Contract Documents.
 - 2. No provision of any such standard specification, manual, reference standard, or code, or any instruction of a Supplier, shall be effective to change the duties or responsibilities of Owner, Contractor, or Engineer, or any of their subcontractors, consultants, agents, or employees, from those set forth in the part of the Contract Documents prepared by or for Engineer. No such provision or instruction shall be effective to assign to Owner, Engineer, or any of their officers, directors, members, partners, employees, agents, consultants, or subcontractors, any duty or authority to supervise or direct the performance of the Work or any duty or authority to undertake responsibility inconsistent with the provisions of the part of the Contract Documents prepared by or for Engineer.

3.03 *Reporting and Resolving Discrepancies*

- A. *Reporting Discrepancies:*
 - 1. *Contractor's Verification of Figures and Field Measurements:* Before undertaking each part of the Work, Contractor shall carefully study the Contract Documents, and check and verify pertinent figures and dimensions therein, particularly with respect to applicable field measurements. Contractor shall promptly report in writing to Engineer any conflict, error, ambiguity, or discrepancy that Contractor discovers, or has actual knowledge of, and shall not proceed with any Work affected thereby until the conflict,

error, ambiguity, or discrepancy is resolved, by a clarification or interpretation by Engineer, or by an amendment or supplement to the Contract Documents issued pursuant to Paragraph 11.01.

2. *Contractor's Review of Contract Documents:* If, before or during the performance of the Work, Contractor discovers any conflict, error, ambiguity, or discrepancy within the Contract Documents, or between the Contract Documents and (a) any applicable Law or Regulation, (b) actual field conditions, (c) any standard specification, manual, reference standard, or code, or (d) any instruction of any Supplier, then Contractor shall promptly report it to Engineer in writing. Contractor shall not proceed with the Work affected thereby (except in an emergency as required by Paragraph 7.15) until the conflict, error, ambiguity, or discrepancy is resolved, by a clarification or interpretation by Engineer, or by an amendment or supplement to the Contract Documents issued pursuant to Paragraph 11.01.
3. Contractor shall not be liable to Owner or Engineer for failure to report any conflict, error, ambiguity, or discrepancy in the Contract Documents unless Contractor had actual knowledge thereof.

B. *Resolving Discrepancies:*

1. Except as may be otherwise specifically stated in the Contract Documents, the provisions of the part of the Contract Documents prepared by or for Engineer shall take precedence in resolving any conflict, error, ambiguity, or discrepancy between such provisions of the Contract Documents and:
 - a. the provisions of any standard specification, manual, reference standard, or code, or the instruction of any Supplier (whether or not specifically incorporated by reference as a Contract Document); or
 - b. the provisions of any Laws or Regulations applicable to the performance of the Work (unless such an interpretation of the provisions of the Contract Documents would result in violation of such Law or Regulation).

3.04 *Requirements of the Contract Documents*

- A. During the performance of the Work and until final payment, Contractor and Owner shall submit to the Engineer all matters in question concerning the requirements of the Contract Documents (sometimes referred to as requests for information or interpretation—RFIs), or relating to the acceptability of the Work under the Contract Documents, as soon as possible after such matters arise. Engineer will be the initial interpreter of the requirements of the Contract Documents, and judge of the acceptability of the Work thereunder.
- B. Engineer will, with reasonable promptness, render a written clarification, interpretation, or decision on the issue submitted, or initiate an amendment or supplement to the Contract Documents. Engineer's written clarification, interpretation, or decision will be final and binding on Contractor, unless it appeals by submitting a Change Proposal, and on Owner, unless it appeals by filing a Claim.
- C. If a submitted matter in question concerns terms and conditions of the Contract Documents that do not involve (1) the performance or acceptability of the Work under the Contract Documents, (2) the design (as set forth in the Drawings, Specifications, or otherwise), or (3) other engineering or technical matters, then Engineer will promptly give written notice to Owner and Contractor that Engineer is unable to provide a decision or interpretation. If Owner and Contractor are unable to agree on resolution of such a matter in question, either party may pursue resolution as provided in Article 12.

3.05 *Reuse of Documents*

- A. Contractor and its Subcontractors and Suppliers shall not:
 - 1. have or acquire any title to or ownership rights in any of the Drawings, Specifications, or other documents (or copies of any thereof) prepared by or bearing the seal of Engineer or its consultants, including electronic media editions, or reuse any such Drawings, Specifications, other documents, or copies thereof on extensions of the Project or any other project without written consent of Owner and Engineer and specific written verification or adaptation by Engineer; or
 - 2. have or acquire any title or ownership rights in any other Contract Documents, reuse any such Contract Documents for any purpose without Owner's express written consent, or violate any copyrights pertaining to such Contract Documents.
- B. The prohibitions of this Paragraph 3.05 will survive final payment, or termination of the Contract. Nothing herein shall preclude Contractor from retaining copies of the Contract Documents for record purposes.

ARTICLE 4 – COMMENCEMENT AND PROGRESS OF THE WORK

4.01 *Commencement of Contract Times; Notice to Proceed*

- A. The Contract Times will commence to run on the thirtieth day after the Effective Date of the Contract or, if a Notice to Proceed is given, on the day indicated in the Notice to Proceed. A Notice to Proceed may be given at any time within 30 days after the Effective Date of the Contract. In no event will the Contract Times commence to run later than the sixtieth day after the day of Bid opening or the thirtieth day after the Effective Date of the Contract, whichever date is earlier.

4.02 *Starting the Work*

- A. Contractor shall start to perform the Work on the date when the Contract Times commence to run. No Work shall be done at the Site prior to such date.

4.03 *Reference Points*

- A. Owner shall provide engineering surveys to establish reference points for construction which in Engineer's judgment are necessary to enable Contractor to proceed with the Work. Contractor shall be responsible for laying out the Work, shall protect and preserve the established reference points and property monuments, and shall make no changes or relocations without the prior written approval of Owner. Contractor shall report to Engineer whenever any reference point or property monument is lost or destroyed or requires relocation because of necessary changes in grades or locations, and shall be responsible for the accurate replacement or relocation of such reference points or property monuments by professionally qualified personnel.

4.04 *Progress Schedule*

- A. Contractor shall adhere to the Progress Schedule established in accordance with Paragraph 2.05 as it may be adjusted from time to time as provided below.
 - 1. Contractor shall submit to Engineer for acceptance (to the extent indicated in Paragraph 2.05) proposed adjustments in the Progress Schedule that will not result in changing the Contract Times.

2. Proposed adjustments in the Progress Schedule that will change the Contract Times shall be submitted in accordance with the requirements of Article 11.
- B. Contractor shall carry on the Work and adhere to the Progress Schedule during all disputes or disagreements with Owner. No Work shall be delayed or postponed pending resolution of any disputes or disagreements, or during any appeal process, except as permitted by Paragraph 16.04, or as Owner and Contractor may otherwise agree in writing.

4.05 *Delays in Contractor's Progress*

- A. If Owner, Engineer, or anyone for whom Owner is responsible, delays, disrupts, or interferes with the performance or progress of the Work, then Contractor shall be entitled to an equitable adjustment in the Contract Times and Contract Price. Contractor's entitlement to an adjustment of the Contract Times is conditioned on such adjustment being essential to Contractor's ability to complete the Work within the Contract Times.
- B. Contractor shall not be entitled to an adjustment in Contract Price or Contract Times for delay, disruption, or interference caused by or within the control of Contractor. Delay, disruption, and interference attributable to and within the control of a Subcontractor or Supplier shall be deemed to be within the control of Contractor.
- C. If Contractor's performance or progress is delayed, disrupted, or interfered with by unanticipated causes not the fault of and beyond the control of Owner, Contractor, and those for which they are responsible, then Contractor shall be entitled to an equitable adjustment in Contract Times. Contractor's entitlement to an adjustment of the Contract Times is conditioned on such adjustment being essential to Contractor's ability to complete the Work within the Contract Times. Such an adjustment shall be Contractor's sole and exclusive remedy for the delays, disruption, and interference described in this paragraph. Causes of delay, disruption, or interference that may give rise to an adjustment in Contract Times under this paragraph include but are not limited to the following:
1. severe and unavoidable natural catastrophes such as fires, floods, epidemics, and earthquakes;
 2. abnormal weather conditions;
 3. acts or failures to act of utility owners (other than those performing other work at or adjacent to the Site by arrangement with the Owner, as contemplated in Article 8); and
 4. acts of war or terrorism.
- D. Delays, disruption, and interference to the performance or progress of the Work resulting from the existence of a differing subsurface or physical condition, an Underground Facility that was not shown or indicated by the Contract Documents, or not shown or indicated with reasonable accuracy, and those resulting from Hazardous Environmental Conditions, are governed by Article 5.
- E. Paragraph 8.03 governs delays, disruption, and interference to the performance or progress of the Work resulting from the performance of certain other work at or adjacent to the Site.
- F. Contractor shall not be entitled to an adjustment in Contract Price or Contract Times for any delay, disruption, or interference if such delay is concurrent with a delay, disruption, or interference caused by or within the control of Contractor.

- G. Contractor must submit any Change Proposal seeking an adjustment in Contract Price or Contract Times under this paragraph within 30 days of the commencement of the delaying, disrupting, or interfering event.

ARTICLE 5 – AVAILABILITY OF LANDS; SUBSURFACE AND PHYSICAL CONDITIONS; HAZARDOUS ENVIRONMENTAL CONDITIONS

5.01 *Availability of Lands*

- A. Owner shall furnish the Site. Owner shall notify Contractor of any encumbrances or restrictions not of general application but specifically related to use of the Site with which Contractor must comply in performing the Work.
- B. Upon reasonable written request, Owner shall furnish Contractor with a current statement of record legal title and legal description of the lands upon which permanent improvements are to be made and Owner's interest therein as necessary for giving notice of or filing a mechanic's or construction lien against such lands in accordance with applicable Laws and Regulations.
- C. Contractor shall provide for all additional lands and access thereto that may be required for temporary construction facilities or storage of materials and equipment.

5.02 *Use of Site and Other Areas*

- A. *Limitation on Use of Site and Other Areas:*
 - 1. Contractor shall confine construction equipment, temporary construction facilities, the storage of materials and equipment, and the operations of workers to the Site, adjacent areas that Contractor has arranged to use through construction easements or otherwise, and other adjacent areas permitted by Laws and Regulations, and shall not unreasonably encumber the Site and such other adjacent areas with construction equipment or other materials or equipment. Contractor shall assume full responsibility for (a) damage to the Site; (b) damage to any such other adjacent areas used for Contractor's operations; (c) damage to any other adjacent land or areas; and (d) for injuries and losses sustained by the owners or occupants of any such land or areas; provided that such damage or injuries result from the performance of the Work or from other actions or conduct of the Contractor or those for which Contractor is responsible.
 - 2. If a damage or injury claim is made by the owner or occupant of any such land or area because of the performance of the Work, or because of other actions or conduct of the Contractor or those for which Contractor is responsible, Contractor shall (a) take immediate corrective or remedial action as required by Paragraph 7.12, or otherwise; (b) promptly attempt to settle the claim as to all parties through negotiations with such owner or occupant, or otherwise resolve the claim by arbitration or other dispute resolution proceeding, or at law; and (c) to the fullest extent permitted by Laws and Regulations, indemnify and hold harmless Owner and Engineer, and the officers, directors, members, partners, employees, agents, consultants and subcontractors of each and any of them from and against any such claim, and against all costs, losses, and damages (including but not limited to all fees and charges of engineers, architects, attorneys, and other professionals and all court or arbitration or other dispute resolution costs) arising out of or relating to any claim or action, legal or equitable, brought by any such owner or occupant against Owner, Engineer, or any other party indemnified hereunder to the extent caused directly or indirectly, in whole or in part

by, or based upon, Contractor's performance of the Work, or because of other actions or conduct of the Contractor or those for which Contractor is responsible.

- B. *Removal of Debris During Performance of the Work:* During the progress of the Work the Contractor shall keep the Site and other adjacent areas free from accumulations of waste materials, rubbish, and other debris. Removal and disposal of such waste materials, rubbish, and other debris shall conform to applicable Laws and Regulations.
- C. *Cleaning:* Prior to Substantial Completion of the Work Contractor shall clean the Site and the Work and make it ready for utilization by Owner. At the completion of the Work Contractor shall remove from the Site and adjacent areas all tools, appliances, construction equipment and machinery, and surplus materials and shall restore to original condition all property not designated for alteration by the Contract Documents.
- D. *Loading of Structures:* Contractor shall not load nor permit any part of any structure to be loaded in any manner that will endanger the structure, nor shall Contractor subject any part of the Work or adjacent structures or land to stresses or pressures that will endanger them.

5.03 *Subsurface and Physical Conditions*

- A. *Reports and Drawings:* The Supplementary Conditions identify:
 - 1. those reports known to Owner of explorations and tests of subsurface conditions at or adjacent to the Site;
 - 2. those drawings known to Owner of physical conditions relating to existing surface or subsurface structures at the Site (except Underground Facilities); and
 - 3. Technical Data contained in such reports and drawings.
- B. *Reliance by Contractor on Technical Data Authorized:* Contractor may rely upon the accuracy of the Technical Data expressly identified in the Supplementary Conditions with respect to such reports and drawings, but such reports and drawings are not Contract Documents. If no such express identification has been made, then Contractor may rely upon the accuracy of the Technical Data (as defined in Article 1) contained in any geotechnical or environmental report prepared for the Project and made available to Contractor. Except for such reliance on Technical Data, Contractor may not rely upon or make any claim against Owner or Engineer, or any of their officers, directors, members, partners, employees, agents, consultants, or subcontractors, with respect to:
 - 1. the completeness of such reports and drawings for Contractor's purposes, including, but not limited to, any aspects of the means, methods, techniques, sequences, and procedures of construction to be employed by Contractor, and safety precautions and programs incident thereto; or
 - 2. other data, interpretations, opinions, and information contained in such reports or shown or indicated in such drawings; or
 - 3. any Contractor interpretation of or conclusion drawn from any Technical Data or any such other data, interpretations, opinions, or information.

5.04 *Differing Subsurface or Physical Conditions*

- A. *Notice by Contractor:* If Contractor believes that any subsurface or physical condition that is uncovered or revealed at the Site either:
1. is of such a nature as to establish that any Technical Data on which Contractor is entitled to rely as provided in Paragraph 5.03 is materially inaccurate; or
 2. is of such a nature as to require a change in the Drawings or Specifications; or
 3. differs materially from that shown or indicated in the Contract Documents; or
 4. is of an unusual nature, and differs materially from conditions ordinarily encountered and generally recognized as inherent in work of the character provided for in the Contract Documents;

then Contractor shall, promptly after becoming aware thereof and before further disturbing the subsurface or physical conditions or performing any Work in connection therewith (except in an emergency as required by Paragraph 7.15), notify Owner and Engineer in writing about such condition. Contractor shall not further disturb such condition or perform any Work in connection therewith (except with respect to an emergency) until receipt of a written statement permitting Contractor to do so.

- B. *Engineer's Review:* After receipt of written notice as required by the preceding paragraph, Engineer will promptly review the subsurface or physical condition in question; determine the necessity of Owner's obtaining additional exploration or tests with respect to the condition; conclude whether the condition falls within any one or more of the differing site condition categories in Paragraph 5.04.A above; obtain any pertinent cost or schedule information from Contractor; prepare recommendations to Owner regarding the Contractor's resumption of Work in connection with the subsurface or physical condition in question and the need for any change in the Drawings or Specifications; and advise Owner in writing of Engineer's findings, conclusions, and recommendations.
- C. *Owner's Statement to Contractor Regarding Site Condition:* After receipt of Engineer's written findings, conclusions, and recommendations, Owner shall issue a written statement to Contractor (with a copy to Engineer) regarding the subsurface or physical condition in question, addressing the resumption of Work in connection with such condition, indicating whether any change in the Drawings or Specifications will be made, and adopting or rejecting Engineer's written findings, conclusions, and recommendations, in whole or in part.
- D. *Possible Price and Times Adjustments:*
1. Contractor shall be entitled to an equitable adjustment in Contract Price or Contract Times, or both, to the extent that the existence of a differing subsurface or physical condition, or any related delay, disruption, or interference, causes an increase or decrease in Contractor's cost of, or time required for, performance of the Work; subject, however, to the following:
 - a. such condition must fall within any one or more of the categories described in Paragraph 5.04.A;
 - b. with respect to Work that is paid for on a unit price basis, any adjustment in Contract Price will be subject to the provisions of Paragraph 13.03; and,

- c. Contractor's entitlement to an adjustment of the Contract Times is conditioned on such adjustment being essential to Contractor's ability to complete the Work within the Contract Times.
2. Contractor shall not be entitled to any adjustment in the Contract Price or Contract Times with respect to a subsurface or physical condition if:
 - a. Contractor knew of the existence of such condition at the time Contractor made a commitment to Owner with respect to Contract Price and Contract Times by the submission of a Bid or becoming bound under a negotiated contract, or otherwise; or
 - b. the existence of such condition reasonably could have been discovered or revealed as a result of any examination, investigation, exploration, test, or study of the Site and contiguous areas expressly required by the Bidding Requirements or Contract Documents to be conducted by or for Contractor prior to Contractor's making such commitment; or
 - c. Contractor failed to give the written notice as required by Paragraph 5.04.A.
3. If Owner and Contractor agree regarding Contractor's entitlement to and the amount or extent of any adjustment in the Contract Price or Contract Times, or both, then any such adjustment shall be set forth in a Change Order.
4. Contractor may submit a Change Proposal regarding its entitlement to or the amount or extent of any adjustment in the Contract Price or Contract Times, or both, no later than 30 days after Owner's issuance of the Owner's written statement to Contractor regarding the subsurface or physical condition in question.

5.05 *Underground Facilities*

- A. *Contractor's Responsibilities:* The information and data shown or indicated in the Contract Documents with respect to existing Underground Facilities at or adjacent to the Site is based on information and data furnished to Owner or Engineer by the owners of such Underground Facilities, including Owner, or by others. Unless it is otherwise expressly provided in the Supplementary Conditions:
 1. Owner and Engineer do not warrant or guarantee the accuracy or completeness of any such information or data provided by others; and
 2. the cost of all of the following will be included in the Contract Price, and Contractor shall have full responsibility for:
 - a. reviewing and checking all information and data regarding existing Underground Facilities at the Site;
 - b. locating all Underground Facilities shown or indicated in the Contract Documents as being at the Site;
 - c. coordination of the Work with the owners (including Owner) of such Underground Facilities, during construction; and
 - d. the safety and protection of all existing Underground Facilities at the Site, and repairing any damage thereto resulting from the Work.
- B. *Notice by Contractor:* If Contractor believes that an Underground Facility that is uncovered or revealed at the Site was not shown or indicated in the Contract Documents, or was not shown or indicated with reasonable accuracy, then Contractor shall, promptly after

becoming aware thereof and before further disturbing conditions affected thereby or performing any Work in connection therewith (except in an emergency as required by Paragraph 7.15), identify the owner of such Underground Facility and give written notice to that owner and to Owner and Engineer.

- C. *Engineer's Review:* Engineer will promptly review the Underground Facility and conclude whether such Underground Facility was not shown or indicated in the Contract Documents, or was not shown or indicated with reasonable accuracy; obtain any pertinent cost or schedule information from Contractor; prepare recommendations to Owner regarding the Contractor's resumption of Work in connection with the Underground Facility in question; determine the extent, if any, to which a change is required in the Drawings or Specifications to reflect and document the consequences of the existence or location of the Underground Facility; and advise Owner in writing of Engineer's findings, conclusions, and recommendations. During such time, Contractor shall be responsible for the safety and protection of such Underground Facility.
- D. *Owner's Statement to Contractor Regarding Underground Facility:* After receipt of Engineer's written findings, conclusions, and recommendations, Owner shall issue a written statement to Contractor (with a copy to Engineer) regarding the Underground Facility in question, addressing the resumption of Work in connection with such Underground Facility, indicating whether any change in the Drawings or Specifications will be made, and adopting or rejecting Engineer's written findings, conclusions, and recommendations in whole or in part.
- E. *Possible Price and Times Adjustments:*
 - 1. Contractor shall be entitled to an equitable adjustment in the Contract Price or Contract Times, or both, to the extent that any existing Underground Facility at the Site that was not shown or indicated in the Contract Documents, or was not shown or indicated with reasonable accuracy, or any related delay, disruption, or interference, causes an increase or decrease in Contractor's cost of, or time required for, performance of the Work; subject, however, to the following:
 - a. Contractor did not know of and could not reasonably have been expected to be aware of or to have anticipated the existence or actual location of the Underground Facility in question;
 - b. With respect to Work that is paid for on a unit price basis, any adjustment in Contract Price will be subject to the provisions of Paragraph 13.03;
 - c. Contractor's entitlement to an adjustment of the Contract Times is conditioned on such adjustment being essential to Contractor's ability to complete the Work within the Contract Times; and
 - d. Contractor gave the notice required in Paragraph 5.05.B.
 - 2. If Owner and Contractor agree regarding Contractor's entitlement to and the amount or extent of any adjustment in the Contract Price or Contract Times, or both, then any such adjustment shall be set forth in a Change Order.
 - 3. Contractor may submit a Change Proposal regarding its entitlement to or the amount or extent of any adjustment in the Contract Price or Contract Times, or both, no later than 30 days after Owner's issuance of the Owner's written statement to Contractor regarding the Underground Facility in question.

5.06 *Hazardous Environmental Conditions at Site*

- A. *Reports and Drawings*: The Supplementary Conditions identify:
1. those reports and drawings known to Owner relating to Hazardous Environmental Conditions that have been identified at or adjacent to the Site; and
 2. Technical Data contained in such reports and drawings.
- B. *Reliance by Contractor on Technical Data Authorized*: Contractor may rely upon the accuracy of the Technical Data expressly identified in the Supplementary Conditions with respect to such reports and drawings, but such reports and drawings are not Contract Documents. If no such express identification has been made, then Contractor may rely on the accuracy of the Technical Data (as defined in Article 1) contained in any geotechnical or environmental report prepared for the Project and made available to Contractor. Except for such reliance on Technical Data, Contractor may not rely upon or make any claim against Owner or Engineer, or any of their officers, directors, members, partners, employees, agents, consultants, or subcontractors with respect to:
1. the completeness of such reports and drawings for Contractor's purposes, including, but not limited to, any aspects of the means, methods, techniques, sequences and procedures of construction to be employed by Contractor and safety precautions and programs incident thereto; or
 2. other data, interpretations, opinions and information contained in such reports or shown or indicated in such drawings; or
 3. any Contractor interpretation of or conclusion drawn from any Technical Data or any such other data, interpretations, opinions or information.
- C. Contractor shall not be responsible for removing or remediating any Hazardous Environmental Condition encountered, uncovered, or revealed at the Site unless such removal or remediation is expressly identified in the Contract Documents to be within the scope of the Work.
- D. Contractor shall be responsible for controlling, containing, and duly removing all Constituents of Concern brought to the Site by Contractor, Subcontractors, Suppliers, or anyone else for whom Contractor is responsible, and for any associated costs; and for the costs of removing and remediating any Hazardous Environmental Condition created by the presence of any such Constituents of Concern.
- E. If Contractor encounters, uncovers, or reveals a Hazardous Environmental Condition whose removal or remediation is not expressly identified in the Contract Documents as being within the scope of the Work, or if Contractor or anyone for whom Contractor is responsible creates a Hazardous Environmental Condition, then Contractor shall immediately: (1) secure or otherwise isolate such condition; (2) stop all Work in connection with such condition and in any area affected thereby (except in an emergency as required by Paragraph 7.15); and (3) notify Owner and Engineer (and promptly thereafter confirm such notice in writing). Owner shall promptly consult with Engineer concerning the necessity for Owner to retain a qualified expert to evaluate such condition or take corrective action, if any. Promptly after consulting with Engineer, Owner shall take such actions as are necessary to permit Owner to timely obtain required permits and provide Contractor the written notice required by Paragraph 5.06.F. If Contractor or anyone for whom Contractor is responsible created the Hazardous Environmental Condition in question, then Owner may remove and remediate the Hazardous Environmental Condition, and impose a set-off against payments to account for the associated costs.

- F. Contractor shall not resume Work in connection with such Hazardous Environmental Condition or in any affected area until after Owner has obtained any required permits related thereto, and delivered written notice to Contractor either (1) specifying that such condition and any affected area is or has been rendered safe for the resumption of Work, or (2) specifying any special conditions under which such Work may be resumed safely.
- G. If Owner and Contractor cannot agree as to entitlement to or on the amount or extent, if any, of any adjustment in Contract Price or Contract Times, or both, as a result of such Work stoppage or such special conditions under which Work is agreed to be resumed by Contractor, then within 30 days of Owner's written notice regarding the resumption of Work, Contractor may submit a Change Proposal, or Owner may impose a set-off.
- H. If after receipt of such written notice Contractor does not agree to resume such Work based on a reasonable belief it is unsafe, or does not agree to resume such Work under such special conditions, then Owner may order the portion of the Work that is in the area affected by such condition to be deleted from the Work, following the contractual change procedures in Article 11. Owner may have such deleted portion of the Work performed by Owner's own forces or others in accordance with Article 8.
- I. To the fullest extent permitted by Laws and Regulations, Owner shall indemnify and hold harmless Contractor, Subcontractors, and Engineer, and the officers, directors, members, partners, employees, agents, consultants, and subcontractors of each and any of them from and against all claims, costs, losses, and damages (including but not limited to all fees and charges of engineers, architects, attorneys, and other professionals and all court or arbitration or other dispute resolution costs) arising out of or relating to a Hazardous Environmental Condition, provided that such Hazardous Environmental Condition (1) was not shown or indicated in the Drawings, Specifications, or other Contract Documents, identified as Technical Data entitled to limited reliance pursuant to Paragraph 5.06.B, or identified in the Contract Documents to be included within the scope of the Work, and (2) was not created by Contractor or by anyone for whom Contractor is responsible. Nothing in this Paragraph 5.06.I shall obligate Owner to indemnify any individual or entity from and against the consequences of that individual's or entity's own negligence.
- J. To the fullest extent permitted by Laws and Regulations, Contractor shall indemnify and hold harmless Owner and Engineer, and the officers, directors, members, partners, employees, agents, consultants, and subcontractors of each and any of them from and against all claims, costs, losses, and damages (including but not limited to all fees and charges of engineers, architects, attorneys, and other professionals and all court or arbitration or other dispute resolution costs) arising out of or relating to the failure to control, contain, or remove a Constituent of Concern brought to the Site by Contractor or by anyone for whom Contractor is responsible, or to a Hazardous Environmental Condition created by Contractor or by anyone for whom Contractor is responsible. Nothing in this Paragraph 5.06.J shall obligate Contractor to indemnify any individual or entity from and against the consequences of that individual's or entity's own negligence.
- K. The provisions of Paragraphs 5.03, 5.04, and 5.05 do not apply to the presence of Constituents of Concern or to a Hazardous Environmental Condition uncovered or revealed at the Site.

ARTICLE 6 – BONDS AND INSURANCE

6.01 *Performance, Payment, and Other Bonds*

- A. Contractor shall furnish a performance bond and a payment bond, each in an amount at least equal to the Contract Price, as security for the faithful performance and payment of all of Contractor's obligations under the Contract. These bonds shall remain in effect until one year after the date when final payment becomes due or until completion of the correction period specified in Paragraph 15.08, whichever is later, except as provided otherwise by Laws or Regulations, the Supplementary Conditions, or other specific provisions of the Contract. Contractor shall also furnish such other bonds as are required by the Supplementary Conditions or other specific provisions of the Contract.
- B. All bonds shall be in the form prescribed by the Contract except as provided otherwise by Laws or Regulations, and shall be executed by such sureties as are named in "Companies Holding Certificates of Authority as Acceptable Sureties on Federal Bonds and as Acceptable Reinsuring Companies" as published in Circular 570 (as amended and supplemented) by the Financial Management Service, Surety Bond Branch, U.S. Department of the Treasury. A bond signed by an agent or attorney-in-fact must be accompanied by a certified copy of that individual's authority to bind the surety. The evidence of authority shall show that it is effective on the date the agent or attorney-in-fact signed the accompanying bond.
- C. Contractor shall obtain the required bonds from surety companies that are duly licensed or authorized in the jurisdiction in which the Project is located to issue bonds in the required amounts.
- D. If the surety on a bond furnished by Contractor is declared bankrupt or becomes insolvent, or its right to do business is terminated in any state or jurisdiction where any part of the Project is located, or the surety ceases to meet the requirements above, then Contractor shall promptly notify Owner and Engineer and shall, within 20 days after the event giving rise to such notification, provide another bond and surety, both of which shall comply with the bond and surety requirements above.
- E. If Contractor has failed to obtain a required bond, Owner may exclude the Contractor from the Site and exercise Owner's termination rights under Article 16.
- F. Upon request, Owner shall provide a copy of the payment bond to any Subcontractor, Supplier, or other person or entity claiming to have furnished labor or materials used in the performance of the Work.

6.02 *Insurance—General Provisions*

- A. Owner and Contractor shall obtain and maintain insurance as required in this Article and in the Supplementary Conditions.
- B. All insurance required by the Contract to be purchased and maintained by Owner or Contractor shall be obtained from insurance companies that are duly licensed or authorized, in the state or jurisdiction in which the Project is located, to issue insurance policies for the required limits and coverages. Unless a different standard is indicated in the Supplementary Conditions, all companies that provide insurance policies required under this Contract shall have an A.M. Best rating of A-VII or better.
- C. Contractor shall deliver to Owner, with copies to each named insured and additional insured (as identified in this Article, in the Supplementary Conditions, or elsewhere in the Contract), certificates of insurance establishing that Contractor has obtained and is

maintaining the policies, coverages, and endorsements required by the Contract. Upon request by Owner or any other insured, Contractor shall also furnish other evidence of such required insurance, including but not limited to copies of policies and endorsements, and documentation of applicable self-insured retentions and deductibles. Contractor may block out (redact) any confidential premium or pricing information contained in any policy or endorsement furnished under this provision.

- D. Owner shall deliver to Contractor, with copies to each named insured and additional insured (as identified in this Article, the Supplementary Conditions, or elsewhere in the Contract), certificates of insurance establishing that Owner has obtained and is maintaining the policies, coverages, and endorsements required of Owner by the Contract (if any). Upon request by Contractor or any other insured, Owner shall also provide other evidence of such required insurance (if any), including but not limited to copies of policies and endorsements, and documentation of applicable self-insured retentions and deductibles. Owner may block out (redact) any confidential premium or pricing information contained in any policy or endorsement furnished under this provision.
- E. Failure of Owner or Contractor to demand such certificates or other evidence of the other party's full compliance with these insurance requirements, or failure of Owner or Contractor to identify a deficiency in compliance from the evidence provided, shall not be construed as a waiver of the other party's obligation to obtain and maintain such insurance.
- F. If either party does not purchase or maintain all of the insurance required of such party by the Contract, such party shall notify the other party in writing of such failure to purchase prior to the start of the Work, or of such failure to maintain prior to any change in the required coverage.
- G. If Contractor has failed to obtain and maintain required insurance, Owner may exclude the Contractor from the Site, impose an appropriate set-off against payment, and exercise Owner's termination rights under Article 16.
- H. Without prejudice to any other right or remedy, if a party has failed to obtain required insurance, the other party may elect to obtain equivalent insurance to protect such other party's interests at the expense of the party who was required to provide such coverage, and the Contract Price shall be adjusted accordingly.
- I. Owner does not represent that insurance coverage and limits established in this Contract necessarily will be adequate to protect Contractor or Contractor's interests.
- J. The insurance and insurance limits required herein shall not be deemed as a limitation on Contractor's liability under the indemnities granted to Owner and other individuals and entities in the Contract.

6.03 *Contractor's Insurance*

- A. *Workers' Compensation:* Contractor shall purchase and maintain workers' compensation and employer's liability insurance for:
 - 1. claims under workers' compensation, disability benefits, and other similar employee benefit acts.
 - 2. United States Longshoreman and Harbor Workers' Compensation Act and Jones Act coverage (if applicable).
 - 3. claims for damages because of bodily injury, occupational sickness or disease, or death of Contractor's employees (by stop-gap endorsement in monopolist worker's compensation states).

4. Foreign voluntary worker compensation (if applicable).
- B. *Commercial General Liability—Claims Covered:* Contractor shall purchase and maintain commercial general liability insurance, covering all operations by or on behalf of Contractor, on an occurrence basis, against:
1. claims for damages because of bodily injury, sickness or disease, or death of any person other than Contractor's employees.
 2. claims for damages insured by reasonably available personal injury liability coverage.
 3. claims for damages, other than to the Work itself, because of injury to or destruction of tangible property wherever located, including loss of use resulting therefrom.
- C. *Commercial General Liability—Form and Content:* Contractor's commercial liability policy shall be written on a 1996 (or later) ISO commercial general liability form (occurrence form) and include the following coverages and endorsements:
1. Products and completed operations coverage:
 - a. Such insurance shall be maintained for three years after final payment.
 - b. Contractor shall furnish Owner and each other additional insured (as identified in the Supplementary Conditions or elsewhere in the Contract) evidence of continuation of such insurance at final payment and three years thereafter.
 2. Blanket contractual liability coverage, to the extent permitted by law, including but not limited to coverage of Contractor's contractual indemnity obligations in Paragraph 7.18.
 3. Broad form property damage coverage.
 4. Severability of interest.
 5. Underground, explosion, and collapse coverage.
 6. Personal injury coverage.
 7. Additional insured endorsements that include both ongoing operations and products and completed operations coverage through ISO Endorsements CG 20 10 10 01 and CG 20 37 10 01 (together); or CG 20 10 07 04 and CG 20 37 07 04 (together); or their equivalent.
 8. For design professional additional insureds, ISO Endorsement CG 20 32 07 04, "Additional Insured—Engineers, Architects or Surveyors Not Engaged by the Named Insured" or its equivalent.
- D. *Automobile liability:* Contractor shall purchase and maintain automobile liability insurance against claims for damages because of bodily injury or death of any person or property damage arising out of the ownership, maintenance, or use of any motor vehicle. The automobile liability policy shall be written on an occurrence basis.
- E. *Umbrella or excess liability:* Contractor shall purchase and maintain umbrella or excess liability insurance written over the underlying employer's liability, commercial general liability, and automobile liability insurance described in the paragraphs above. Subject to industry-standard exclusions, the coverage afforded shall follow form as to each and every one of the underlying policies.
- F. *Contractor's pollution liability insurance:* Contractor shall purchase and maintain a policy covering third-party injury and property damage claims, including clean-up costs, as a result

of pollution conditions arising from Contractor's operations and completed operations. This insurance shall be maintained for no less than three years after final completion.

- G. *Additional insureds*: The Contractor's commercial general liability, automobile liability, umbrella or excess, and pollution liability policies shall include and list as additional insureds Owner and Engineer, and any individuals or entities identified in the Supplementary Conditions; include coverage for the respective officers, directors, members, partners, employees, agents, consultants, and subcontractors of each and any of all such additional insureds; and the insurance afforded to these additional insureds shall provide primary coverage for all claims covered thereby (including as applicable those arising from both ongoing and completed operations) on a non-contributory basis. Contractor shall obtain all necessary endorsements to support these requirements.
- H. *Contractor's professional liability insurance*: If Contractor will provide or furnish professional services under this Contract, through a delegation of professional design services or otherwise, then Contractor shall be responsible for purchasing and maintaining applicable professional liability insurance. This insurance shall provide protection against claims arising out of performance of professional design or related services, and caused by a negligent error, omission, or act for which the insured party is legally liable. It shall be maintained throughout the duration of the Contract and for a minimum of two years after Substantial Completion. If such professional design services are performed by a Subcontractor, and not by Contractor itself, then the requirements of this paragraph may be satisfied through the purchasing and maintenance of such insurance by such Subcontractor.
- I. *General provisions*: The policies of insurance required by this Paragraph 6.03 shall:
1. include at least the specific coverages provided in this Article.
 2. be written for not less than the limits of liability provided in this Article and in the Supplementary Conditions, or required by Laws or Regulations, whichever is greater.
 3. contain a provision or endorsement that the coverage afforded will not be canceled, materially changed, or renewal refused until at least 10 days prior written notice has been given to Contractor. Within three days of receipt of any such written notice, Contractor shall provide a copy of the notice to Owner, Engineer, and each other insured under the policy.
 4. remain in effect at least until final payment (and longer if expressly required in this Article) and at all times thereafter when Contractor may be correcting, removing, or replacing defective Work as a warranty or correction obligation, or otherwise, or returning to the Site to conduct other tasks arising from the Contract Documents.
 5. be appropriate for the Work being performed and provide protection from claims that may arise out of or result from Contractor's performance of the Work and Contractor's other obligations under the Contract Documents, whether it is to be performed by Contractor, any Subcontractor or Supplier, or by anyone directly or indirectly employed by any of them to perform any of the Work, or by anyone for whose acts any of them may be liable.
- J. The coverage requirements for specific policies of insurance must be met by such policies, and not by reference to excess or umbrella insurance provided in other policies.

6.04 *Owner's Liability Insurance*

- A. In addition to the insurance required to be provided by Contractor under Paragraph 6.03, Owner, at Owner's option, may purchase and maintain at Owner's expense Owner's own liability insurance as will protect Owner against claims which may arise from operations under the Contract Documents.
- B. Owner's liability policies, if any, operate separately and independently from policies required to be provided by Contractor, and Contractor cannot rely upon Owner's liability policies for any of Contractor's obligations to the Owner, Engineer, or third parties.

6.05 *Property Insurance*

- A. *Builder's Risk*: Unless otherwise provided in the Supplementary Conditions, Contractor shall purchase and maintain builder's risk insurance upon the Work on a completed value basis, in the amount of the full insurable replacement cost thereof (subject to such deductible amounts as may be provided in the Supplementary Conditions or required by Laws and Regulations). This insurance shall:
 - 1. include the Owner and Contractor as named insureds, and all Subcontractors, and any individuals or entities required by the Supplementary Conditions to be insured under such builder's risk policy, as insureds or named insureds. For purposes of the remainder of this Paragraph 6.05, Paragraphs 6.06 and 6.07, and any corresponding Supplementary Conditions, the parties required to be insured shall collectively be referred to as "insureds."
 - 2. be written on a builder's risk "all risk" policy form that shall at least include insurance for physical loss or damage to the Work, temporary buildings, falsework, and materials and equipment in transit, and shall insure against at least the following perils or causes of loss: fire; lightning; windstorm; riot; civil commotion; terrorism; vehicle impact; aircraft; smoke; theft; vandalism and malicious mischief; mechanical breakdown, boiler explosion, and artificially generated electric current; earthquake; volcanic activity, and other earth movement; flood; collapse; explosion; debris removal; demolition occasioned by enforcement of Laws and Regulations; water damage (other than that caused by flood); and such other perils or causes of loss as may be specifically required by the Supplementary Conditions. If insurance against mechanical breakdown, boiler explosion, and artificially generated electric current; earthquake; volcanic activity, and other earth movement; or flood, are not commercially available under builder's risk policies, by endorsement or otherwise, such insurance may be provided through other insurance policies acceptable to Owner and Contractor.
 - 3. cover, as insured property, at least the following: (a) the Work and all materials, supplies, machinery, apparatus, equipment, fixtures, and other property of a similar nature that are to be incorporated into or used in the preparation, fabrication, construction, erection, or completion of the Work, including Owner-furnished or assigned property; (b) spare parts inventory required within the scope of the Contract; and (c) temporary works which are not intended to form part of the permanent constructed Work but which are intended to provide working access to the Site, or to the Work under construction, or which are intended to provide temporary support for the Work under construction, including scaffolding, form work, fences, shoring, falsework, and temporary structures.
 - 4. cover expenses incurred in the repair or replacement of any insured property (including but not limited to fees and charges of engineers and architects).

5. extend to cover damage or loss to insured property while in temporary storage at the Site or in a storage location outside the Site (but not including property stored at the premises of a manufacturer or Supplier).
 6. extend to cover damage or loss to insured property while in transit.
 7. allow for partial occupation or use of the Work by Owner, such that those portions of the Work that are not yet occupied or used by Owner shall remain covered by the builder's risk insurance.
 8. allow for the waiver of the insurer's subrogation rights, as set forth below.
 9. provide primary coverage for all losses and damages caused by the perils or causes of loss covered.
 10. not include a co-insurance clause.
 11. include an exception for ensuing losses from physical damage or loss with respect to any defective workmanship, design, or materials exclusions.
 12. include performance/hot testing and start-up.
 13. be maintained in effect, subject to the provisions herein regarding Substantial Completion and partial occupancy or use of the Work by Owner, until the Work is complete.
- B. *Notice of Cancellation or Change:* All the policies of insurance (and the certificates or other evidence thereof) required to be purchased and maintained in accordance with this Paragraph 6.05 will contain a provision or endorsement that the coverage afforded will not be canceled or materially changed or renewal refused until at least 10 days prior written notice has been given to the purchasing policyholder. Within three days of receipt of any such written notice, the purchasing policyholder shall provide a copy of the notice to each other insured.
- C. *Deductibles:* The purchaser of any required builder's risk or property insurance shall pay for costs not covered because of the application of a policy deductible.
- D. *Partial Occupancy or Use by Owner:* If Owner will occupy or use a portion or portions of the Work prior to Substantial Completion of all the Work as provided in Paragraph 15.04, then Owner (directly, if it is the purchaser of the builder's risk policy, or through Contractor) will provide notice of such occupancy or use to the builder's risk insurer. The builder's risk insurance shall not be canceled or permitted to lapse on account of any such partial use or occupancy; rather, those portions of the Work that are occupied or used by Owner may come off the builder's risk policy, while those portions of the Work not yet occupied or used by Owner shall remain covered by the builder's risk insurance.
- E. *Additional Insurance:* If Contractor elects to obtain other special insurance to be included in or supplement the builder's risk or property insurance policies provided under this Paragraph 6.05, it may do so at Contractor's expense.
- F. *Insurance of Other Property:* If the express insurance provisions of the Contract do not require or address the insurance of a property item or interest, such as tools, construction equipment, or other personal property owned by Contractor, a Subcontractor, or an employee of Contractor or a Subcontractor, then the entity or individual owning such property item will be responsible for deciding whether to insure it, and if so in what amount.

6.06 *Waiver of Rights*

- A. All policies purchased in accordance with Paragraph 6.05, expressly including the builder's risk policy, shall contain provisions to the effect that in the event of payment of any loss or damage the insurers will have no rights of recovery against any insureds thereunder, or against Engineer or its consultants, or their officers, directors, members, partners, employees, agents, consultants, or subcontractors. Owner and Contractor waive all rights against each other and the respective officers, directors, members, partners, employees, agents, consultants, and subcontractors of each and any of them, for all losses and damages caused by, arising out of, or resulting from any of the perils or causes of loss covered by such policies and any other property insurance applicable to the Work; and, in addition, waive all such rights against Engineer, its consultants, all Subcontractors, all individuals or entities identified in the Supplementary Conditions as insureds, and the officers, directors, members, partners, employees, agents, consultants, and subcontractors of each and any of them, under such policies for losses and damages so caused. None of the above waivers shall extend to the rights that any party making such waiver may have to the proceeds of insurance held by Owner or Contractor as trustee or fiduciary, or otherwise payable under any policy so issued.
- B. Owner waives all rights against Contractor, Subcontractors, and Engineer, and the officers, directors, members, partners, employees, agents, consultants and subcontractors of each and any of them, for:
 - 1. loss due to business interruption, loss of use, or other consequential loss extending beyond direct physical loss or damage to Owner's property or the Work caused by, arising out of, or resulting from fire or other perils whether or not insured by Owner; and
 - 2. loss or damage to the completed Project or part thereof caused by, arising out of, or resulting from fire or other insured peril or cause of loss covered by any property insurance maintained on the completed Project or part thereof by Owner during partial occupancy or use pursuant to Paragraph 15.04, after Substantial Completion pursuant to Paragraph 15.03, or after final payment pursuant to Paragraph 15.06.
- C. Any insurance policy maintained by Owner covering any loss, damage or consequential loss referred to in Paragraph 6.06.B shall contain provisions to the effect that in the event of payment of any such loss, damage, or consequential loss, the insurers will have no rights of recovery against Contractor, Subcontractors, or Engineer, or the officers, directors, members, partners, employees, agents, consultants, or subcontractors of each and any of them.
- D. Contractor shall be responsible for assuring that the agreement under which a Subcontractor performs a portion of the Work contains provisions whereby the Subcontractor waives all rights against Owner, Contractor, all individuals or entities identified in the Supplementary Conditions as insureds, the Engineer and its consultants, and the officers, directors, members, partners, employees, agents, consultants, and subcontractors of each and any of them, for all losses and damages caused by, arising out of, relating to, or resulting from any of the perils or causes of loss covered by builder's risk insurance and any other property insurance applicable to the Work.

6.07 *Receipt and Application of Property Insurance Proceeds*

- A. Any insured loss under the builder's risk and other policies of insurance required by Paragraph 6.05 will be adjusted and settled with the named insured that purchased the

policy. Such named insured shall act as fiduciary for the other insureds, and give notice to such other insureds that adjustment and settlement of a claim is in progress. Any other insured may state its position regarding a claim for insured loss in writing within 15 days after notice of such claim.

- B. Proceeds for such insured losses may be made payable by the insurer either jointly to multiple insureds, or to the named insured that purchased the policy in its own right and as fiduciary for other insureds, subject to the requirements of any applicable mortgage clause. A named insured receiving insurance proceeds under the builder's risk and other policies of insurance required by Paragraph 6.05 shall distribute such proceeds in accordance with such agreement as the parties in interest may reach, or as otherwise required under the dispute resolution provisions of this Contract or applicable Laws and Regulations.
- C. If no other special agreement is reached, the damaged Work shall be repaired or replaced, the money so received applied on account thereof, and the Work and the cost thereof covered by Change Order, if needed.

ARTICLE 7 – CONTRACTOR'S RESPONSIBILITIES

7.01 Supervision and Superintendence

- A. Contractor shall supervise, inspect, and direct the Work competently and efficiently, devoting such attention thereto and applying such skills and expertise as may be necessary to perform the Work in accordance with the Contract Documents. Contractor shall be solely responsible for the means, methods, techniques, sequences, and procedures of construction.
- B. At all times during the progress of the Work, Contractor shall assign a competent resident superintendent who shall not be replaced without written notice to Owner and Engineer except under extraordinary circumstances.

7.02 Labor; Working Hours

- A. Contractor shall provide competent, suitably qualified personnel to survey and lay out the Work and perform construction as required by the Contract Documents. Contractor shall at all times maintain good discipline and order at the Site.
- B. Except as otherwise required for the safety or protection of persons or the Work or property at the Site or adjacent thereto, and except as otherwise stated in the Contract Documents, all Work at the Site shall be performed during regular working hours, Monday through Friday. Contractor will not perform Work on a Saturday, Sunday, or any legal holiday. Contractor may perform Work outside regular working hours or on Saturdays, Sundays, or legal holidays only with Owner's written consent, which will not be unreasonably withheld.

7.03 Services, Materials, and Equipment

- A. Unless otherwise specified in the Contract Documents, Contractor shall provide and assume full responsibility for all services, materials, equipment, labor, transportation, construction equipment and machinery, tools, appliances, fuel, power, light, heat, telephone, water, sanitary facilities, temporary facilities, and all other facilities and incidentals necessary for the performance, testing, start up, and completion of the Work, whether or not such items are specifically called for in the Contract Documents.
- B. All materials and equipment incorporated into the Work shall be of good quality and new, except as otherwise provided in the Contract Documents. All special warranties and

guarantees required by the Specifications shall expressly run to the benefit of Owner. If required by Engineer, Contractor shall furnish satisfactory evidence (including reports of required tests) as to the source, kind, and quality of materials and equipment.

- C. All materials and equipment shall be stored, applied, installed, connected, erected, protected, used, cleaned, and conditioned in accordance with instructions of the applicable Supplier, except as otherwise may be provided in the Contract Documents.

7.04 "Or Equals"

- A. Whenever an item of material or equipment is specified or described in the Contract Documents by using the name of a proprietary item or the name of a particular Supplier, the Contract Price has been based upon Contractor furnishing such item as specified. The specification or description of such an item is intended to establish the type, function, appearance, and quality required. Unless the specification or description contains or is followed by words reading that no like, equivalent, or "or equal" item is permitted, Contractor may request that Engineer authorize the use of other items of material or equipment, or items from other proposed suppliers under the circumstances described below.
 - 1. If Engineer in its sole discretion determines that an item of material or equipment proposed by Contractor is functionally equal to that named and sufficiently similar so that no change in related Work will be required, Engineer shall deem it an "or equal" item. For the purposes of this paragraph, a proposed item of material or equipment will be considered functionally equal to an item so named if:
 - a. in the exercise of reasonable judgment Engineer determines that:
 - 1) it is at least equal in materials of construction, quality, durability, appearance, strength, and design characteristics;
 - 2) it will reliably perform at least equally well the function and achieve the results imposed by the design concept of the completed Project as a functioning whole;
 - 3) it has a proven record of performance and availability of responsive service; and
 - 4) it is not objectionable to Owner.
 - b. Contractor certifies that, if approved and incorporated into the Work:
 - 1) there will be no increase in cost to the Owner or increase in Contract Times; and
 - 2) it will conform substantially to the detailed requirements of the item named in the Contract Documents.
- B. *Contractor's Expense:* Contractor shall provide all data in support of any proposed "or equal" item at Contractor's expense.
- C. *Engineer's Evaluation and Determination:* Engineer will be allowed a reasonable time to evaluate each "or-equal" request. Engineer may require Contractor to furnish additional data about the proposed "or-equal" item. Engineer will be the sole judge of acceptability. No "or-equal" item will be ordered, furnished, installed, or utilized until Engineer's review is complete and Engineer determines that the proposed item is an "or-equal", which will be evidenced by an approved Shop Drawing or other written communication. Engineer will advise Contractor in writing of any negative determination.

- D. *Effect of Engineer's Determination:* Neither approval nor denial of an "or-equal" request shall result in any change in Contract Price. The Engineer's denial of an "or-equal" request shall be final and binding, and may not be reversed through an appeal under any provision of the Contract Documents.
- E. *Treatment as a Substitution Request:* If Engineer determines that an item of material or equipment proposed by Contractor does not qualify as an "or-equal" item, Contractor may request that Engineer considered the proposed item as a substitute pursuant to Paragraph 7.05.

7.05 *Substitutes*

- A. Unless the specification or description of an item of material or equipment required to be furnished under the Contract Documents contains or is followed by words reading that no substitution is permitted, Contractor may request that Engineer authorize the use of other items of material or equipment under the circumstances described below. To the extent possible such requests shall be made before commencement of related construction at the Site.
 - 1. Contractor shall submit sufficient information as provided below to allow Engineer to determine if the item of material or equipment proposed is functionally equivalent to that named and an acceptable substitute therefor. Engineer will not accept requests for review of proposed substitute items of material or equipment from anyone other than Contractor.
 - 2. The requirements for review by Engineer will be as set forth in Paragraph 7.05.B, as supplemented by the Specifications, and as Engineer may decide is appropriate under the circumstances.
 - 3. Contractor shall make written application to Engineer for review of a proposed substitute item of material or equipment that Contractor seeks to furnish or use. The application:
 - a. shall certify that the proposed substitute item will:
 - 1) perform adequately the functions and achieve the results called for by the general design,
 - 2) be similar in substance to that specified, and
 - 3) be suited to the same use as that specified.
 - b. will state:
 - 1) the extent, if any, to which the use of the proposed substitute item will necessitate a change in Contract Times,
 - 2) whether use of the proposed substitute item in the Work will require a change in any of the Contract Documents (or in the provisions of any other direct contract with Owner for other work on the Project) to adapt the design to the proposed substitute item, and
 - 3) whether incorporation or use of the proposed substitute item in connection with the Work is subject to payment of any license fee or royalty.
 - c. will identify:
 - 1) all variations of the proposed substitute item from that specified, and

- 2) available engineering, sales, maintenance, repair, and replacement services.
 - d. shall contain an itemized estimate of all costs or credits that will result directly or indirectly from use of such substitute item, including but not limited to changes in Contract Price, shared savings, costs of redesign, and claims of other contractors affected by any resulting change.
- B. *Engineer's Evaluation and Determination:* Engineer will be allowed a reasonable time to evaluate each substitute request, and to obtain comments and direction from Owner. Engineer may require Contractor to furnish additional data about the proposed substitute item. Engineer will be the sole judge of acceptability. No substitute will be ordered, furnished, installed, or utilized until Engineer's review is complete and Engineer determines that the proposed item is an acceptable substitute. Engineer's determination will be evidenced by a Field Order or a proposed Change Order accounting for the substitution itself and all related impacts, including changes in Contract Price or Contract Times. Engineer will advise Contractor in writing of any negative determination.
 - C. *Special Guarantee:* Owner may require Contractor to furnish at Contractor's expense a special performance guarantee or other surety with respect to any substitute.
 - D. *Reimbursement of Engineer's Cost:* Engineer will record Engineer's costs in evaluating a substitute proposed or submitted by Contractor. Whether or not Engineer approves a substitute so proposed or submitted by Contractor, Contractor shall reimburse Owner for the reasonable charges of Engineer for evaluating each such proposed substitute. Contractor shall also reimburse Owner for the reasonable charges of Engineer for making changes in the Contract Documents (or in the provisions of any other direct contract with Owner) resulting from the acceptance of each proposed substitute.
 - E. *Contractor's Expense:* Contractor shall provide all data in support of any proposed substitute at Contractor's expense.
 - F. *Effect of Engineer's Determination:* If Engineer approves the substitution request, Contractor shall execute the proposed Change Order and proceed with the substitution. The Engineer's denial of a substitution request shall be final and binding, and may not be reversed through an appeal under any provision of the Contract Documents. Contractor may challenge the scope of reimbursement costs imposed under Paragraph 7.05.D, by timely submittal of a Change Proposal.

7.06 *Concerning Subcontractors, Suppliers, and Others*

- A. Contractor may retain Subcontractors and Suppliers for the performance of parts of the Work. Such Subcontractors and Suppliers must be acceptable to Owner.
- B. Contractor shall retain specific Subcontractors, Suppliers, or other individuals or entities for the performance of designated parts of the Work if required by the Contract to do so.
- C. Subsequent to the submittal of Contractor's Bid or final negotiation of the terms of the Contract, Owner may not require Contractor to retain any Subcontractor, Supplier, or other individual or entity to furnish or perform any of the Work against which Contractor has reasonable objection.
- D. Prior to entry into any binding subcontract or purchase order, Contractor shall submit to Owner the identity of the proposed Subcontractor or Supplier (unless Owner has already deemed such proposed Subcontractor or Supplier acceptable, during the bidding process or otherwise). Such proposed Subcontractor or Supplier shall be deemed acceptable to Owner unless Owner raises a substantive, reasonable objection within five days.

- E. Owner may require the replacement of any Subcontractor, Supplier, or other individual or entity retained by Contractor to perform any part of the Work. Owner also may require Contractor to retain specific replacements; provided, however, that Owner may not require a replacement to which Contractor has a reasonable objection. If Contractor has submitted the identity of certain Subcontractors, Suppliers, or other individuals or entities for acceptance by Owner, and Owner has accepted it (either in writing or by failing to make written objection thereto), then Owner may subsequently revoke the acceptance of any such Subcontractor, Supplier, or other individual or entity so identified solely on the basis of substantive, reasonable objection after due investigation. Contractor shall submit an acceptable replacement for the rejected Subcontractor, Supplier, or other individual or entity.
- F. If Owner requires the replacement of any Subcontractor, Supplier, or other individual or entity retained by Contractor to perform any part of the Work, then Contractor shall be entitled to an adjustment in Contract Price or Contract Times, or both, with respect to the replacement; and Contractor shall initiate a Change Proposal for such adjustment within 30 days of Owner's requirement of replacement.
- G. No acceptance by Owner of any such Subcontractor, Supplier, or other individual or entity, whether initially or as a replacement, shall constitute a waiver of the right of Owner to the completion of the Work in accordance with the Contract Documents.
- H. On a monthly basis Contractor shall submit to Engineer a complete list of all Subcontractors and Suppliers having a direct contract with Contractor, and of all other Subcontractors and Suppliers known to Contractor at the time of submittal.
- I. Contractor shall be fully responsible to Owner and Engineer for all acts and omissions of the Subcontractors, Suppliers, and other individuals or entities performing or furnishing any of the Work just as Contractor is responsible for Contractor's own acts and omissions.
- J. Contractor shall be solely responsible for scheduling and coordinating the work of Subcontractors, Suppliers, and all other individuals or entities performing or furnishing any of the Work.
- K. Contractor shall restrict all Subcontractors, Suppliers, and such other individuals or entities performing or furnishing any of the Work from communicating with Engineer or Owner, except through Contractor or in case of an emergency, or as otherwise expressly allowed herein.
- L. The divisions and sections of the Specifications and the identifications of any Drawings shall not control Contractor in dividing the Work among Subcontractors or Suppliers or delineating the Work to be performed by any specific trade.
- M. All Work performed for Contractor by a Subcontractor or Supplier shall be pursuant to an appropriate contractual agreement that specifically binds the Subcontractor or Supplier to the applicable terms and conditions of the Contract Documents for the benefit of Owner and Engineer.
- N. Owner may furnish to any Subcontractor or Supplier, to the extent practicable, information about amounts paid to Contractor on account of Work performed for Contractor by the particular Subcontractor or Supplier.

O. Nothing in the Contract Documents:

1. shall create for the benefit of any such Subcontractor, Supplier, or other individual or entity any contractual relationship between Owner or Engineer and any such Subcontractor, Supplier, or other individual or entity; nor
2. shall create any obligation on the part of Owner or Engineer to pay or to see to the payment of any money due any such Subcontractor, Supplier, or other individual or entity except as may otherwise be required by Laws and Regulations.

7.07 *Patent Fees and Royalties*

- A. Contractor shall pay all license fees and royalties and assume all costs incident to the use in the performance of the Work or the incorporation in the Work of any invention, design, process, product, or device which is the subject of patent rights or copyrights held by others. If a particular invention, design, process, product, or device is specified in the Contract Documents for use in the performance of the Work and if, to the actual knowledge of Owner or Engineer, its use is subject to patent rights or copyrights calling for the payment of any license fee or royalty to others, the existence of such rights shall be disclosed by Owner in the Contract Documents.
- B. To the fullest extent permitted by Laws and Regulations, Owner shall indemnify and hold harmless Contractor, and its officers, directors, members, partners, employees, agents, consultants, and subcontractors from and against all claims, costs, losses, and damages (including but not limited to all fees and charges of engineers, architects, attorneys, and other professionals, and all court or arbitration or other dispute resolution costs) arising out of or relating to any infringement of patent rights or copyrights incident to the use in the performance of the Work or resulting from the incorporation in the Work of any invention, design, process, product, or device specified in the Contract Documents, but not identified as being subject to payment of any license fee or royalty to others required by patent rights or copyrights.
- C. To the fullest extent permitted by Laws and Regulations, Contractor shall indemnify and hold harmless Owner and Engineer, and the officers, directors, members, partners, employees, agents, consultants and subcontractors of each and any of them from and against all claims, costs, losses, and damages (including but not limited to all fees and charges of engineers, architects, attorneys, and other professionals and all court or arbitration or other dispute resolution costs) arising out of or relating to any infringement of patent rights or copyrights incident to the use in the performance of the Work or resulting from the incorporation in the Work of any invention, design, process, product, or device not specified in the Contract Documents.

7.08 *Permits*

- A. Unless otherwise provided in the Contract Documents, Contractor shall obtain and pay for all construction permits and licenses. Owner shall assist Contractor, when necessary, in obtaining such permits and licenses. Contractor shall pay all governmental charges and inspection fees necessary for the prosecution of the Work which are applicable at the time of the submission of Contractor's Bid (or when Contractor became bound under a negotiated contract). Owner shall pay all charges of utility owners for connections for providing permanent service to the Work

7.09 *Taxes*

- A. Contractor shall pay all sales, consumer, use, and other similar taxes required to be paid by Contractor in accordance with the Laws and Regulations of the place of the Project which are applicable during the performance of the Work.

7.10 *Laws and Regulations*

- A. Contractor shall give all notices required by and shall comply with all Laws and Regulations applicable to the performance of the Work. Except where otherwise expressly required by applicable Laws and Regulations, neither Owner nor Engineer shall be responsible for monitoring Contractor's compliance with any Laws or Regulations.
- B. If Contractor performs any Work or takes any other action knowing or having reason to know that it is contrary to Laws or Regulations, Contractor shall bear all resulting costs and losses, and shall indemnify and hold harmless Owner and Engineer, and the officers, directors, members, partners, employees, agents, consultants, and subcontractors of each and any of them from and against all claims, costs, losses, and damages (including but not limited to all fees and charges of engineers, architects, attorneys, and other professionals and all court or arbitration or other dispute resolution costs) arising out of or relating to such Work or other action. It shall not be Contractor's responsibility to make certain that the Work described in the Contract Documents is in accordance with Laws and Regulations, but this shall not relieve Contractor of Contractor's obligations under Paragraph 3.03.
- C. Owner or Contractor may give notice to the other party of any changes after the submission of Contractor's Bid (or after the date when Contractor became bound under a negotiated contract) in Laws or Regulations having an effect on the cost or time of performance of the Work, including but not limited to changes in Laws or Regulations having an effect on procuring permits and on sales, use, value-added, consumption, and other similar taxes. If Owner and Contractor are unable to agree on entitlement to or on the amount or extent, if any, of any adjustment in Contract Price or Contract Times resulting from such changes, then within 30 days of such notice Contractor may submit a Change Proposal, or Owner may initiate a Claim.

7.11 *Record Documents*

- A. Contractor shall maintain in a safe place at the Site one printed record copy of all Drawings, Specifications, Addenda, Change Orders, Work Change Directives, Field Orders, written interpretations and clarifications, and approved Shop Drawings. Contractor shall keep such record documents in good order and annotate them to show changes made during construction. These record documents, together with all approved Samples, will be available to Engineer for reference. Upon completion of the Work, Contractor shall deliver these record documents to Engineer.

7.12 *Safety and Protection*

- A. Contractor shall be solely responsible for initiating, maintaining, and supervising all safety precautions and programs in connection with the Work. Such responsibility does not relieve Subcontractors of their responsibility for the safety of persons or property in the performance of their work, nor for compliance with applicable safety Laws and Regulations. Contractor shall take all necessary precautions for the safety of, and shall provide the necessary protection to prevent damage, injury, or loss to:
 - 1. all persons on the Site or who may be affected by the Work;

2. all the Work and materials and equipment to be incorporated therein, whether in storage on or off the Site; and
 3. other property at the Site or adjacent thereto, including trees, shrubs, lawns, walks, pavements, roadways, structures, other work in progress, utilities, and Underground Facilities not designated for removal, relocation, or replacement in the course of construction.
- B. Contractor shall comply with all applicable Laws and Regulations relating to the safety of persons or property, or to the protection of persons or property from damage, injury, or loss; and shall erect and maintain all necessary safeguards for such safety and protection. Contractor shall notify Owner; the owners of adjacent property, Underground Facilities, and other utilities; and other contractors and utility owners performing work at or adjacent to the Site, when prosecution of the Work may affect them, and shall cooperate with them in the protection, removal, relocation, and replacement of their property or work in progress.
 - C. Contractor shall comply with the applicable requirements of Owner's safety programs, if any. The Supplementary Conditions identify any Owner's safety programs that are applicable to the Work.
 - D. Contractor shall inform Owner and Engineer of the specific requirements of Contractor's safety program with which Owner's and Engineer's employees and representatives must comply while at the Site.
 - E. All damage, injury, or loss to any property referred to in Paragraph 7.12.A.2 or 7.12.A.3 caused, directly or indirectly, in whole or in part, by Contractor, any Subcontractor, Supplier, or any other individual or entity directly or indirectly employed by any of them to perform any of the Work, or anyone for whose acts any of them may be liable, shall be remedied by Contractor at its expense (except damage or loss attributable to the fault of Drawings or Specifications or to the acts or omissions of Owner or Engineer or anyone employed by any of them, or anyone for whose acts any of them may be liable, and not attributable, directly or indirectly, in whole or in part, to the fault or negligence of Contractor or any Subcontractor, Supplier, or other individual or entity directly or indirectly employed by any of them).
 - F. Contractor's duties and responsibilities for safety and protection shall continue until such time as all the Work is completed and Engineer has issued a notice to Owner and Contractor in accordance with Paragraph 15.06.B that the Work is acceptable (except as otherwise expressly provided in connection with Substantial Completion).
 - G. Contractor's duties and responsibilities for safety and protection shall resume whenever Contractor or any Subcontractor or Supplier returns to the Site to fulfill warranty or correction obligations, or to conduct other tasks arising from the Contract Documents.

7.13 *Safety Representative*

- A. Contractor shall designate a qualified and experienced safety representative at the Site whose duties and responsibilities shall be the prevention of accidents and the maintaining and supervising of safety precautions and programs.

7.14 *Hazard Communication Programs*

- A. Contractor shall be responsible for coordinating any exchange of material safety data sheets or other hazard communication information required to be made available to or

exchanged between or among employers at the Site in accordance with Laws or Regulations.

7.15 *Emergencies*

- A. In emergencies affecting the safety or protection of persons or the Work or property at the Site or adjacent thereto, Contractor is obligated to act to prevent threatened damage, injury, or loss. Contractor shall give Engineer prompt written notice if Contractor believes that any significant changes in the Work or variations from the Contract Documents have been caused thereby or are required as a result thereof. If Engineer determines that a change in the Contract Documents is required because of the action taken by Contractor in response to such an emergency, a Work Change Directive or Change Order will be issued.

7.16 *Shop Drawings, Samples, and Other Submittals*

A. *Shop Drawing and Sample Submittal Requirements:*

1. Before submitting a Shop Drawing or Sample, Contractor shall have:
 - a. reviewed and coordinated the Shop Drawing or Sample with other Shop Drawings and Samples and with the requirements of the Work and the Contract Documents;
 - b. determined and verified all field measurements, quantities, dimensions, specified performance and design criteria, installation requirements, materials, catalog numbers, and similar information with respect thereto;
 - c. determined and verified the suitability of all materials and equipment offered with respect to the indicated application, fabrication, shipping, handling, storage, assembly, and installation pertaining to the performance of the Work; and
 - d. determined and verified all information relative to Contractor's responsibilities for means, methods, techniques, sequences, and procedures of construction, and safety precautions and programs incident thereto.
2. Each submittal shall bear a stamp or specific written certification that Contractor has satisfied Contractor's obligations under the Contract Documents with respect to Contractor's review of that submittal, and that Contractor approves the submittal.
3. With each submittal, Contractor shall give Engineer specific written notice of any variations that the Shop Drawing or Sample may have from the requirements of the Contract Documents. This notice shall be set forth in a written communication separate from the Shop Drawings or Sample submittal; and, in addition, in the case of Shop Drawings by a specific notation made on each Shop Drawing submitted to Engineer for review and approval of each such variation.

- B. *Submittal Procedures for Shop Drawings and Samples:* Contractor shall submit Shop Drawings and Samples to Engineer for review and approval in accordance with the accepted Schedule of Submittals. Each submittal will be identified as Engineer may require.

1. *Shop Drawings:*

- a. Contractor shall submit the number of copies required in the Specifications.
- b. Data shown on the Shop Drawings will be complete with respect to quantities, dimensions, specified performance and design criteria, materials, and similar data to show Engineer the services, materials, and equipment Contractor proposes to

provide and to enable Engineer to review the information for the limited purposes required by Paragraph 7.16.D.

2. *Samples:*
 - a. Contractor shall submit the number of Samples required in the Specifications.
 - b. Contractor shall clearly identify each Sample as to material, Supplier, pertinent data such as catalog numbers, the use for which intended and other data as Engineer may require to enable Engineer to review the submittal for the limited purposes required by Paragraph 7.16.D.
3. Where a Shop Drawing or Sample is required by the Contract Documents or the Schedule of Submittals, any related Work performed prior to Engineer's review and approval of the pertinent submittal will be at the sole expense and responsibility of Contractor.
- C. *Other Submittals:* Contractor shall submit other submittals to Engineer in accordance with the accepted Schedule of Submittals, and pursuant to the applicable terms of the Specifications.
- D. *Engineer's Review:*
 1. Engineer will provide timely review of Shop Drawings and Samples in accordance with the Schedule of Submittals acceptable to Engineer. Engineer's review and approval will be only to determine if the items covered by the submittals will, after installation or incorporation in the Work, conform to the information given in the Contract Documents and be compatible with the design concept of the completed Project as a functioning whole as indicated by the Contract Documents.
 2. Engineer's review and approval will not extend to means, methods, techniques, sequences, or procedures of construction or to safety precautions or programs incident thereto.
 3. Engineer's review and approval of a separate item as such will not indicate approval of the assembly in which the item functions.
 4. Engineer's review and approval of a Shop Drawing or Sample shall not relieve Contractor from responsibility for any variation from the requirements of the Contract Documents unless Contractor has complied with the requirements of Paragraph 7.16.A.3 and Engineer has given written approval of each such variation by specific written notation thereof incorporated in or accompanying the Shop Drawing or Sample. Engineer will document any such approved variation from the requirements of the Contract Documents in a Field Order.
 5. Engineer's review and approval of a Shop Drawing or Sample shall not relieve Contractor from responsibility for complying with the requirements of Paragraph 7.16.A and B.
 6. Engineer's review and approval of a Shop Drawing or Sample, or of a variation from the requirements of the Contract Documents, shall not, under any circumstances, change the Contract Times or Contract Price, unless such changes are included in a Change Order.
 7. Neither Engineer's receipt, review, acceptance or approval of a Shop Drawing, Sample, or other submittal shall result in such item becoming a Contract Document.

8. Contractor shall perform the Work in compliance with the requirements and commitments set forth in approved Shop Drawings and Samples, subject to the provisions of Paragraph 7.16.D.4.

E. *Resubmittal Procedures:*

1. Contractor shall make corrections required by Engineer and shall return the required number of corrected copies of Shop Drawings and submit, as required, new Samples for review and approval. Contractor shall direct specific attention in writing to revisions other than the corrections called for by Engineer on previous submittals.
2. Contractor shall furnish required submittals with sufficient information and accuracy to obtain required approval of an item with no more than three submittals. Engineer will record Engineer's time for reviewing a fourth or subsequent submittal of a Shop Drawings, sample, or other item requiring approval, and Contractor shall be responsible for Engineer's charges to Owner for such time. Owner may impose a set-off against payments due to Contractor to secure reimbursement for such charges.
3. If Contractor requests a change of a previously approved submittal item, Contractor shall be responsible for Engineer's charges to Owner for its review time, and Owner may impose a set-off against payments due to Contractor to secure reimbursement for such charges, unless the need for such change is beyond the control of Contractor.

7.17 *Contractor's General Warranty and Guarantee*

- A. Contractor warrants and guarantees to Owner that all Work will be in accordance with the Contract Documents and will not be defective. Engineer and its officers, directors, members, partners, employees, agents, consultants, and subcontractors shall be entitled to rely on Contractor's warranty and guarantee.
- B. Contractor's warranty and guarantee hereunder excludes defects or damage caused by:
 1. abuse, modification, or improper maintenance or operation by persons other than Contractor, Subcontractors, Suppliers, or any other individual or entity for whom Contractor is responsible; or
 2. normal wear and tear under normal usage.
- C. Contractor's obligation to perform and complete the Work in accordance with the Contract Documents shall be absolute. None of the following will constitute an acceptance of Work that is not in accordance with the Contract Documents or a release of Contractor's obligation to perform the Work in accordance with the Contract Documents:
 1. observations by Engineer;
 2. recommendation by Engineer or payment by Owner of any progress or final payment;
 3. the issuance of a certificate of Substantial Completion by Engineer or any payment related thereto by Owner;
 4. use or occupancy of the Work or any part thereof by Owner;
 5. any review and approval of a Shop Drawing or Sample submittal;
 6. the issuance of a notice of acceptability by Engineer;
 7. any inspection, test, or approval by others; or
 8. any correction of defective Work by Owner.

- D. If the Contract requires the Contractor to accept the assignment of a contract entered into by Owner, then the specific warranties, guarantees, and correction obligations contained in the assigned contract shall govern with respect to Contractor's performance obligations to Owner for the Work described in the assigned contract.

7.18 *Indemnification*

- A. To the fullest extent permitted by Laws and Regulations, and in addition to any other obligations of Contractor under the Contract or otherwise, Contractor shall indemnify and hold harmless Owner and Engineer, and the officers, directors, members, partners, employees, agents, consultants and subcontractors of each and any of them from and against all claims, costs, losses, and damages (including but not limited to all fees and charges of engineers, architects, attorneys, and other professionals and all court or arbitration or other dispute resolution costs) arising out of or relating to the performance of the Work, provided that any such claim, cost, loss, or damage is attributable to bodily injury, sickness, disease, or death, or to injury to or destruction of tangible property (other than the Work itself), including the loss of use resulting therefrom but only to the extent caused by any negligent act or omission of Contractor, any Subcontractor, any Supplier, or any individual or entity directly or indirectly employed by any of them to perform any of the Work or anyone for whose acts any of them may be liable.
- B. In any and all claims against Owner or Engineer or any of their officers, directors, members, partners, employees, agents, consultants, or subcontractors by any employee (or the survivor or personal representative of such employee) of Contractor, any Subcontractor, any Supplier, or any individual or entity directly or indirectly employed by any of them to perform any of the Work, or anyone for whose acts any of them may be liable, the indemnification obligation under Paragraph 7.18.A shall not be limited in any way by any limitation on the amount or type of damages, compensation, or benefits payable by or for Contractor or any such Subcontractor, Supplier, or other individual or entity under workers' compensation acts, disability benefit acts, or other employee benefit acts.
- C. The indemnification obligations of Contractor under Paragraph 7.18.A shall not extend to the liability of Engineer and Engineer's officers, directors, members, partners, employees, agents, consultants and subcontractors arising out of:
 - 1. the preparation or approval of, or the failure to prepare or approve maps, Drawings, opinions, reports, surveys, Change Orders, designs, or Specifications; or
 - 2. giving directions or instructions, or failing to give them, if that is the primary cause of the injury or damage.

7.19 *Delegation of Professional Design Services*

- A. Contractor will not be required to provide professional design services unless such services are specifically required by the Contract Documents for a portion of the Work or unless such services are required to carry out Contractor's responsibilities for construction means, methods, techniques, sequences and procedures. Contractor shall not be required to provide professional services in violation of applicable Laws and Regulations.
- B. If professional design services or certifications by a design professional related to systems, materials, or equipment are specifically required of Contractor by the Contract Documents, Owner and Engineer will specify all performance and design criteria that such services must satisfy. Contractor shall cause such services or certifications to be provided by a properly licensed professional, whose signature and seal shall appear on all drawings, calculations, specifications, certifications, and other submittals prepared by such professional. Shop

Drawings and other submittals related to the Work designed or certified by such professional, if prepared by others, shall bear such professional's written approval when submitted to Engineer.

- C. Owner and Engineer shall be entitled to rely upon the adequacy, accuracy, and completeness of the services, certifications, or approvals performed by such design professionals, provided Owner and Engineer have specified to Contractor all performance and design criteria that such services must satisfy.
- D. Pursuant to this paragraph, Engineer's review and approval of design calculations and design drawings will be only for the limited purpose of checking for conformance with performance and design criteria given and the design concept expressed in the Contract Documents. Engineer's review and approval of Shop Drawings and other submittals (except design calculations and design drawings) will be only for the purpose stated in Paragraph 7.16.D.1.
- E. Contractor shall not be responsible for the adequacy of the performance or design criteria specified by Owner or Engineer.

ARTICLE 8 – OTHER WORK AT THE SITE

8.01 *Other Work*

- A. In addition to and apart from the Work under the Contract Documents, the Owner may perform other work at or adjacent to the Site. Such other work may be performed by Owner's employees, or through contracts between the Owner and third parties. Owner may also arrange to have third-party utility owners perform work on their utilities and facilities at or adjacent to the Site.
- B. If Owner performs other work at or adjacent to the Site with Owner's employees, or through contracts for such other work, then Owner shall give Contractor written notice thereof prior to starting any such other work. If Owner has advance information regarding the start of any utility work at or adjacent to the Site, Owner shall provide such information to Contractor.
- C. Contractor shall afford each other contractor that performs such other work, each utility owner performing other work, and Owner, if Owner is performing other work with Owner's employees, proper and safe access to the Site, and provide a reasonable opportunity for the introduction and storage of materials and equipment and the execution of such other work. Contractor shall do all cutting, fitting, and patching of the Work that may be required to properly connect or otherwise make its several parts come together and properly integrate with such other work. Contractor shall not endanger any work of others by cutting, excavating, or otherwise altering such work; provided, however, that Contractor may cut or alter others' work with the written consent of Engineer and the others whose work will be affected.
- D. If the proper execution or results of any part of Contractor's Work depends upon work performed by others under this Article 8, Contractor shall inspect such other work and promptly report to Engineer in writing any delays, defects, or deficiencies in such other work that render it unavailable or unsuitable for the proper execution and results of Contractor's Work. Contractor's failure to so report will constitute an acceptance of such other work as fit and proper for integration with Contractor's Work except for latent defects and deficiencies in such other work.

8.02 *Coordination*

- A. If Owner intends to contract with others for the performance of other work at or adjacent to the Site, to perform other work at or adjacent to the Site with Owner's employees, or to arrange to have utility owners perform work at or adjacent to the Site, the following will be set forth in the Supplementary Conditions or provided to Contractor prior to the start of any such other work:
 - 1. the identity of the individual or entity that will have authority and responsibility for coordination of the activities among the various contractors;
 - 2. an itemization of the specific matters to be covered by such authority and responsibility; and
 - 3. the extent of such authority and responsibilities.
- B. Unless otherwise provided in the Supplementary Conditions, Owner shall have sole authority and responsibility for such coordination.

8.03 *Legal Relationships*

- A. If, in the course of performing other work at or adjacent to the Site for Owner, the Owner's employees, any other contractor working for Owner, or any utility owner for whom the Owner is responsible causes damage to the Work or to the property of Contractor or its Subcontractors, or delays, disrupts, interferes with, or increases the scope or cost of the performance of the Work, through actions or inaction, then Contractor shall be entitled to an equitable adjustment in the Contract Price or the Contract Times, or both. Contractor must submit any Change Proposal seeking an equitable adjustment in the Contract Price or the Contract Times under this paragraph within 30 days of the damaging, delaying, disrupting, or interfering event. The entitlement to, and extent of, any such equitable adjustment shall take into account information (if any) regarding such other work that was provided to Contractor in the Contract Documents prior to the submittal of the Bid or the final negotiation of the terms of the Contract. When applicable, any such equitable adjustment in Contract Price shall be conditioned on Contractor assigning to Owner all Contractor's rights against such other contractor or utility owner with respect to the damage, delay, disruption, or interference that is the subject of the adjustment. Contractor's entitlement to an adjustment of the Contract Times is conditioned on such adjustment being essential to Contractor's ability to complete the Work within the Contract Times.
- B. Contractor shall take reasonable and customary measures to avoid damaging, delaying, disrupting, or interfering with the work of Owner, any other contractor, or any utility owner performing other work at or adjacent to the Site. If Contractor fails to take such measures and as a result damages, delays, disrupts, or interferes with the work of any such other contractor or utility owner, then Owner may impose a set-off against payments due to Contractor, and assign to such other contractor or utility owner the Owner's contractual rights against Contractor with respect to the breach of the obligations set forth in this paragraph.
- C. When Owner is performing other work at or adjacent to the Site with Owner's employees, Contractor shall be liable to Owner for damage to such other work, and for the reasonable direct delay, disruption, and interference costs incurred by Owner as a result of Contractor's failure to take reasonable and customary measures with respect to Owner's other work. In response to such damage, delay, disruption, or interference, Owner may impose a set-off against payments due to Contractor.

- D. If Contractor damages, delays, disrupts, or interferes with the work of any other contractor, or any utility owner performing other work at or adjacent to the Site, through Contractor's failure to take reasonable and customary measures to avoid such impacts, or if any claim arising out of Contractor's actions, inactions, or negligence in performance of the Work at or adjacent to the Site is made by any such other contractor or utility owner against Contractor, Owner, or Engineer, then Contractor shall (1) promptly attempt to settle the claim as to all parties through negotiations with such other contractor or utility owner, or otherwise resolve the claim by arbitration or other dispute resolution proceeding or at law, and (2) indemnify and hold harmless Owner and Engineer, and the officers, directors, members, partners, employees, agents, consultants and subcontractors of each and any of them from and against any such claims, and against all costs, losses, and damages (including but not limited to all fees and charges of engineers, architects, attorneys, and other professionals and all court or arbitration or other dispute resolution costs) arising out of or relating to such damage, delay, disruption, or interference.

ARTICLE 9 – OWNER'S RESPONSIBILITIES

9.01 *Communications to Contractor*

- A. Except as otherwise provided in these General Conditions, Owner shall issue all communications to Contractor through Engineer.

9.02 *Replacement of Engineer*

- A. Owner may at its discretion appoint an engineer to replace Engineer, provided Contractor makes no reasonable objection to the replacement engineer. The replacement engineer's status under the Contract Documents shall be that of the former Engineer.

9.03 *Furnish Data*

- A. Owner shall promptly furnish the data required of Owner under the Contract Documents.

9.04 *Pay When Due*

- A. Owner shall make payments to Contractor when they are due as provided in the Agreement.

9.05 *Lands and Easements; Reports, Tests, and Drawings*

- A. Owner's duties with respect to providing lands and easements are set forth in Paragraph 5.01.
- B. Owner's duties with respect to providing engineering surveys to establish reference points are set forth in Paragraph 4.03.
- C. Article 5 refers to Owner's identifying and making available to Contractor copies of reports of explorations and tests of conditions at the Site, and drawings of physical conditions relating to existing surface or subsurface structures at the Site.

9.06 *Insurance*

- A. Owner's responsibilities, if any, with respect to purchasing and maintaining liability and property insurance are set forth in Article 6.

9.07 *Change Orders*

- A. Owner's responsibilities with respect to Change Orders are set forth in Article 11.

9.08 *Inspections, Tests, and Approvals*

- A. Owner's responsibility with respect to certain inspections, tests, and approvals is set forth in Paragraph 14.02.B.

9.09 *Limitations on Owner's Responsibilities*

- A. The Owner shall not supervise, direct, or have control or authority over, nor be responsible for, Contractor's means, methods, techniques, sequences, or procedures of construction, or the safety precautions and programs incident thereto, or for any failure of Contractor to comply with Laws and Regulations applicable to the performance of the Work. Owner will not be responsible for Contractor's failure to perform the Work in accordance with the Contract Documents.

9.10 *Undisclosed Hazardous Environmental Condition*

- A. Owner's responsibility in respect to an undisclosed Hazardous Environmental Condition is set forth in Paragraph 5.06.

9.11 *Evidence of Financial Arrangements*

- A. Upon request of Contractor, Owner shall furnish Contractor reasonable evidence that financial arrangements have been made to satisfy Owner's obligations under the Contract Documents (including obligations under proposed changes in the Work).

9.12 *Safety Programs*

- A. While at the Site, Owner's employees and representatives shall comply with the specific applicable requirements of Contractor's safety programs of which Owner has been informed.
- B. Owner shall furnish copies of any applicable Owner safety programs to Contractor.

ARTICLE 10 – ENGINEER'S STATUS DURING CONSTRUCTION

10.01 *Owner's Representative*

- A. Engineer will be Owner's representative during the construction period. The duties and responsibilities and the limitations of authority of Engineer as Owner's representative during construction are set forth in the Contract.

10.02 *Visits to Site*

- A. Engineer will make visits to the Site at intervals appropriate to the various stages of construction as Engineer deems necessary in order to observe as an experienced and qualified design professional the progress that has been made and the quality of the various aspects of Contractor's executed Work. Based on information obtained during such visits and observations, Engineer, for the benefit of Owner, will determine, in general, if the Work is proceeding in accordance with the Contract Documents. Engineer will not be required to make exhaustive or continuous inspections on the Site to check the quality or quantity of the Work. Engineer's efforts will be directed toward providing for Owner a greater degree of confidence that the completed Work will conform generally to the Contract Documents. On the basis of such visits and observations, Engineer will keep Owner informed of the progress of the Work and will endeavor to guard Owner against defective Work.
- B. Engineer's visits and observations are subject to all the limitations on Engineer's authority and responsibility set forth in Paragraph 10.08. Particularly, but without limitation, during

or as a result of Engineer's visits or observations of Contractor's Work, Engineer will not supervise, direct, control, or have authority over or be responsible for Contractor's means, methods, techniques, sequences, or procedures of construction, or the safety precautions and programs incident thereto, or for any failure of Contractor to comply with Laws and Regulations applicable to the performance of the Work.

10.03 *Project Representative*

- A. If Owner and Engineer have agreed that Engineer will furnish a Resident Project Representative to represent Engineer at the Site and assist Engineer in observing the progress and quality of the Work, then the authority and responsibilities of any such Resident Project Representative will be as provided in the Supplementary Conditions, and limitations on the responsibilities thereof will be as provided in Paragraph 10.08. If Owner designates another representative or agent to represent Owner at the Site who is not Engineer's consultant, agent, or employee, the responsibilities and authority and limitations thereon of such other individual or entity will be as provided in the Supplementary Conditions.

10.04 *Rejecting Defective Work*

- A. Engineer has the authority to reject Work in accordance with Article 14.

10.05 *Shop Drawings, Change Orders and Payments*

- A. Engineer's authority, and limitations thereof, as to Shop Drawings and Samples, are set forth in Paragraph 7.16.
- B. Engineer's authority, and limitations thereof, as to design calculations and design drawings submitted in response to a delegation of professional design services, if any, are set forth in Paragraph 7.19.
- C. Engineer's authority as to Change Orders is set forth in Article 11.
- D. Engineer's authority as to Applications for Payment is set forth in Article 15.

10.06 *Determinations for Unit Price Work*

- A. Engineer will determine the actual quantities and classifications of Unit Price Work performed by Contractor as set forth in Paragraph 13.03.

10.07 *Decisions on Requirements of Contract Documents and Acceptability of Work*

- A. Engineer will render decisions regarding the requirements of the Contract Documents, and judge the acceptability of the Work, pursuant to the specific procedures set forth herein for initial interpretations, Change Proposals, and acceptance of the Work. In rendering such decisions and judgments, Engineer will not show partiality to Owner or Contractor, and will not be liable to Owner, Contractor, or others in connection with any proceedings, interpretations, decisions, or judgments conducted or rendered in good faith.

10.08 *Limitations on Engineer's Authority and Responsibilities*

- A. Neither Engineer's authority or responsibility under this Article 10 or under any other provision of the Contract, nor any decision made by Engineer in good faith either to exercise or not exercise such authority or responsibility or the undertaking, exercise, or performance of any authority or responsibility by Engineer, shall create, impose, or give rise to any duty in contract, tort, or otherwise owed by Engineer to Contractor, any Subcontractor, any Supplier, any other individual or entity, or to any surety for or employee or agent of any of them.

- B. Engineer will not supervise, direct, control, or have authority over or be responsible for Contractor's means, methods, techniques, sequences, or procedures of construction, or the safety precautions and programs incident thereto, or for any failure of Contractor to comply with Laws and Regulations applicable to the performance of the Work. Engineer will not be responsible for Contractor's failure to perform the Work in accordance with the Contract Documents.
- C. Engineer will not be responsible for the acts or omissions of Contractor or of any Subcontractor, any Supplier, or of any other individual or entity performing any of the Work.
- D. Engineer's review of the final Application for Payment and accompanying documentation and all maintenance and operating instructions, schedules, guarantees, bonds, certificates of inspection, tests and approvals, and other documentation required to be delivered by Paragraph 15.06.A will only be to determine generally that their content complies with the requirements of, and in the case of certificates of inspections, tests, and approvals, that the results certified indicate compliance with the Contract Documents.
- E. The limitations upon authority and responsibility set forth in this Paragraph 10.08 shall also apply to the Resident Project Representative, if any.

10.09 *Compliance with Safety Program*

- A. While at the Site, Engineer's employees and representatives will comply with the specific applicable requirements of Owner's and Contractor's safety programs (if any) of which Engineer has been informed.

ARTICLE 11 – AMENDING THE CONTRACT DOCUMENTS; CHANGES IN THE WORK

11.01 *Amending and Supplementing Contract Documents*

- A. The Contract Documents may be amended or supplemented by a Change Order, a Work Change Directive, or a Field Order.
 1. *Change Orders:*
 - a. If an amendment or supplement to the Contract Documents includes a change in the Contract Price or the Contract Times, such amendment or supplement must be set forth in a Change Order. A Change Order also may be used to establish amendments and supplements of the Contract Documents that do not affect the Contract Price or Contract Times.
 - b. Owner and Contractor may amend those terms and conditions of the Contract Documents that do not involve (1) the performance or acceptability of the Work, (2) the design (as set forth in the Drawings, Specifications, or otherwise), or (3) other engineering or technical matters, without the recommendation of the Engineer. Such an amendment shall be set forth in a Change Order.
 2. *Work Change Directives:* A Work Change Directive will not change the Contract Price or the Contract Times but is evidence that the parties expect that the modification ordered or documented by a Work Change Directive will be incorporated in a subsequently issued Change Order, following negotiations by the parties as to the Work Change Directive's effect, if any, on the Contract Price and Contract Times; or, if negotiations are unsuccessful, by a determination under the terms of the Contract Documents governing adjustments, expressly including Paragraph 11.04 regarding change of Contract Price. Contractor must submit any Change Proposal seeking an

adjustment of the Contract Price or the Contract Times, or both, no later than 30 days after the completion of the Work set out in the Work Change Directive. Owner must submit any Claim seeking an adjustment of the Contract Price or the Contract Times, or both, no later than 60 days after issuance of the Work Change Directive.

3. *Field Orders*: Engineer may authorize minor changes in the Work if the changes do not involve an adjustment in the Contract Price or the Contract Times and are compatible with the design concept of the completed Project as a functioning whole as indicated by the Contract Documents. Such changes will be accomplished by a Field Order and will be binding on Owner and also on Contractor, which shall perform the Work involved promptly. If Contractor believes that a Field Order justifies an adjustment in the Contract Price or Contract Times, or both, then before proceeding with the Work at issue, Contractor shall submit a Change Proposal as provided herein.

11.02 *Owner-Authorized Changes in the Work*

- A. Without invalidating the Contract and without notice to any surety, Owner may, at any time or from time to time, order additions, deletions, or revisions in the Work. Such changes shall be supported by Engineer's recommendation, to the extent the change involves the design (as set forth in the Drawings, Specifications, or otherwise), or other engineering or technical matters. Such changes may be accomplished by a Change Order, if Owner and Contractor have agreed as to the effect, if any, of the changes on Contract Times or Contract Price; or by a Work Change Directive. Upon receipt of any such document, Contractor shall promptly proceed with the Work involved; or, in the case of a deletion in the Work, promptly cease construction activities with respect to such deleted Work. Added or revised Work shall be performed under the applicable conditions of the Contract Documents. Nothing in this paragraph shall obligate Contractor to undertake work that Contractor reasonably concludes cannot be performed in a manner consistent with Contractor's safety obligations under the Contract Documents or Laws and Regulations.

11.03 *Unauthorized Changes in the Work*

- A. Contractor shall not be entitled to an increase in the Contract Price or an extension of the Contract Times with respect to any work performed that is not required by the Contract Documents, as amended, modified, or supplemented, except in the case of an emergency as provided in Paragraph 7.15 or in the case of uncovering Work as provided in Paragraph 14.05.

11.04 *Change of Contract Price*

- A. The Contract Price may only be changed by a Change Order. Any Change Proposal for an adjustment in the Contract Price shall comply with the provisions of Paragraph 11.06. Any Claim for an adjustment of Contract Price shall comply with the provisions of Article 12.
- B. An adjustment in the Contract Price will be determined as follows:
 1. where the Work involved is covered by unit prices contained in the Contract Documents, then by application of such unit prices to the quantities of the items involved (subject to the provisions of Paragraph 13.03); or
 2. where the Work involved is not covered by unit prices contained in the Contract Documents, then by a mutually agreed lump sum (which may include an allowance for overhead and profit not necessarily in accordance with Paragraph 11.04.C.2); or
 3. where the Work involved is not covered by unit prices contained in the Contract Documents and the parties do not reach mutual agreement to a lump sum, then on

the basis of the Cost of the Work (determined as provided in Paragraph 13.01) plus a Contractor's fee for overhead and profit (determined as provided in Paragraph 11.04.C).

- C. *Contractor's Fee*: When applicable, the Contractor's fee for overhead and profit shall be determined as follows:
1. a mutually acceptable fixed fee; or
 2. if a fixed fee is not agreed upon, then a fee based on the following percentages of the various portions of the Cost of the Work:
 - a. for costs incurred under Paragraphs 13.01.B.1 and 13.01.B.2, the Contractor's fee shall be 15 percent;
 - b. for costs incurred under Paragraph 13.01.B.3, the Contractor's fee shall be five percent;
 - c. where one or more tiers of subcontracts are on the basis of Cost of the Work plus a fee and no fixed fee is agreed upon, the intent of Paragraphs 11.04.C.2.a and 11.04.C.2.b is that the Contractor's fee shall be based on: (1) a fee of 15 percent of the costs incurred under Paragraphs 13.01.A.1 and 13.01.A.2 by the Subcontractor that actually performs the Work, at whatever tier, and (2) with respect to Contractor itself and to any Subcontractors of a tier higher than that of the Subcontractor that actually performs the Work, a fee of five percent of the amount (fee plus underlying costs incurred) attributable to the next lower tier Subcontractor; provided, however, that for any such subcontracted work the maximum total fee to be paid by Owner shall be no greater than 27 percent of the costs incurred by the Subcontractor that actually performs the work;
 - d. no fee shall be payable on the basis of costs itemized under Paragraphs 13.01.B.4, 13.01.B.5, and 13.01.C;
 - e. the amount of credit to be allowed by Contractor to Owner for any change which results in a net decrease in cost will be the amount of the actual net decrease in cost plus a deduction in Contractor's fee by an amount equal to five percent of such net decrease; and
 - f. when both additions and credits are involved in any one change, the adjustment in Contractor's fee shall be computed on the basis of the net change in accordance with Paragraphs 11.04.C.2.a through 11.04.C.2.e, inclusive.

11.05 *Change of Contract Times*

- A. The Contract Times may only be changed by a Change Order. Any Change Proposal for an adjustment in the Contract Times shall comply with the provisions of Paragraph 11.06. Any Claim for an adjustment in the Contract Times shall comply with the provisions of Article 12.
- B. An adjustment of the Contract Times shall be subject to the limitations set forth in Paragraph 4.05, concerning delays in Contractor's progress.

11.06 *Change Proposals*

- A. Contractor shall submit a Change Proposal to Engineer to request an adjustment in the Contract Times or Contract Price; appeal an initial decision by Engineer concerning the requirements of the Contract Documents or relating to the acceptability of the Work under the Contract Documents; contest a set-off against payment due; or seek other relief under

the Contract. The Change Proposal shall specify any proposed change in Contract Times or Contract Price, or both, or other proposed relief, and explain the reason for the proposed change, with citations to any governing or applicable provisions of the Contract Documents.

1. *Procedures:* Contractor shall submit each Change Proposal to Engineer promptly (but in no event later than 30 days) after the start of the event giving rise thereto, or after such initial decision. The Contractor shall submit supporting data, including the proposed change in Contract Price or Contract Time (if any), to the Engineer and Owner within 15 days after the submittal of the Change Proposal. The supporting data shall be accompanied by a written statement that the supporting data are accurate and complete, and that any requested time or price adjustment is the entire adjustment to which Contractor believes it is entitled as a result of said event. Engineer will advise Owner regarding the Change Proposal, and consider any comments or response from Owner regarding the Change Proposal.
 2. *Engineer's Action:* Engineer will review each Change Proposal and, within 30 days after receipt of the Contractor's supporting data, either deny the Change Proposal in whole, approve it in whole, or deny it in part and approve it in part. Such actions shall be in writing, with a copy provided to Owner and Contractor. If Engineer does not take action on the Change Proposal within 30 days, then either Owner or Contractor may at any time thereafter submit a letter to the other party indicating that as a result of Engineer's inaction the Change Proposal is deemed denied, thereby commencing the time for appeal of the denial under Article 12.
 3. *Binding Decision:* Engineer's decision will be final and binding upon Owner and Contractor, unless Owner or Contractor appeals the decision by filing a Claim under Article 12.
- B. *Resolution of Certain Change Proposals:* If the Change Proposal does not involve the design (as set forth in the Drawings, Specifications, or otherwise), the acceptability of the Work, or other engineering or technical matters, then Engineer will notify the parties that the Engineer is unable to resolve the Change Proposal. For purposes of further resolution of such a Change Proposal, such notice shall be deemed a denial, and Contractor may choose to seek resolution under the terms of Article 12.

11.07 Execution of Change Orders

- A. Owner and Contractor shall execute appropriate Change Orders covering:
1. changes in the Contract Price or Contract Times which are agreed to by the parties, including any undisputed sum or amount of time for Work actually performed in accordance with a Work Change Directive;
 2. changes in Contract Price resulting from an Owner set-off, unless Contractor has duly contested such set-off;
 3. changes in the Work which are: (a) ordered by Owner pursuant to Paragraph 11.02, (b) required because of Owner's acceptance of defective Work under Paragraph 14.04 or Owner's correction of defective Work under Paragraph 14.07, or (c) agreed to by the parties, subject to the need for Engineer's recommendation if the change in the Work involves the design (as set forth in the Drawings, Specifications, or otherwise), or other engineering or technical matters; and
 4. changes in the Contract Price or Contract Times, or other changes, which embody the substance of any final and binding results under Paragraph 11.06, or Article 12.

- B. If Owner or Contractor refuses to execute a Change Order that is required to be executed under the terms of this Paragraph 11.07, it shall be deemed to be of full force and effect, as if fully executed.

11.08 *Notification to Surety*

- A. If the provisions of any bond require notice to be given to a surety of any change affecting the general scope of the Work or the provisions of the Contract Documents (including, but not limited to, Contract Price or Contract Times), the giving of any such notice will be Contractor's responsibility. The amount of each applicable bond will be adjusted to reflect the effect of any such change.

ARTICLE 12 – CLAIMS

12.01 *Claims*

- A. *Claims Process:* The following disputes between Owner and Contractor shall be submitted to the Claims process set forth in this Article:
 - 1. Appeals by Owner or Contractor of Engineer's decisions regarding Change Proposals;
 - 2. Owner demands for adjustments in the Contract Price or Contract Times, or other relief under the Contract Documents; and
 - 3. Disputes that Engineer has been unable to address because they do not involve the design (as set forth in the Drawings, Specifications, or otherwise), the acceptability of the Work, or other engineering or technical matters.
- B. *Submittal of Claim:* The party submitting a Claim shall deliver it directly to the other party to the Contract promptly (but in no event later than 30 days) after the start of the event giving rise thereto; in the case of appeals regarding Change Proposals within 30 days of the decision under appeal. The party submitting the Claim shall also furnish a copy to the Engineer, for its information only. The responsibility to substantiate a Claim shall rest with the party making the Claim. In the case of a Claim by Contractor seeking an increase in the Contract Times or Contract Price, or both, Contractor shall certify that the Claim is made in good faith, that the supporting data are accurate and complete, and that to the best of Contractor's knowledge and belief the amount of time or money requested accurately reflects the full amount to which Contractor is entitled.
- C. *Review and Resolution:* The party receiving a Claim shall review it thoroughly, giving full consideration to its merits. The two parties shall seek to resolve the Claim through the exchange of information and direct negotiations. The parties may extend the time for resolving the Claim by mutual agreement. All actions taken on a Claim shall be stated in writing and submitted to the other party, with a copy to Engineer.
- D. *Mediation:*
 - 1. At any time after initiation of a Claim, Owner and Contractor may mutually agree to mediation of the underlying dispute. The agreement to mediate shall stay the Claim submittal and response process.
 - 2. If Owner and Contractor agree to mediation, then after 60 days from such agreement, either Owner or Contractor may unilaterally terminate the mediation process, and the Claim submittal and decision process shall resume as of the date of the termination. If the mediation proceeds but is unsuccessful in resolving the dispute, the Claim

submittal and decision process shall resume as of the date of the conclusion of the mediation, as determined by the mediator.

3. Owner and Contractor shall each pay one-half of the mediator's fees and costs.
- E. *Partial Approval*: If the party receiving a Claim approves the Claim in part and denies it in part, such action shall be final and binding unless within 30 days of such action the other party invokes the procedure set forth in Article 17 for final resolution of disputes.
- F. *Denial of Claim*: If efforts to resolve a Claim are not successful, the party receiving the Claim may deny it by giving written notice of denial to the other party. If the receiving party does not take action on the Claim within 90 days, then either Owner or Contractor may at any time thereafter submit a letter to the other party indicating that as a result of the inaction, the Claim is deemed denied, thereby commencing the time for appeal of the denial. A denial of the Claim shall be final and binding unless within 30 days of the denial the other party invokes the procedure set forth in Article 17 for the final resolution of disputes.
- G. *Final and Binding Results*: If the parties reach a mutual agreement regarding a Claim, whether through approval of the Claim, direct negotiations, mediation, or otherwise; or if a Claim is approved in part and denied in part, or denied in full, and such actions become final and binding; then the results of the agreement or action on the Claim shall be incorporated in a Change Order to the extent they affect the Contract, including the Work, the Contract Times, or the Contract Price.

ARTICLE 13 – COST OF THE WORK; ALLOWANCES; UNIT PRICE WORK

13.01 *Cost of the Work*

- A. *Purposes for Determination of Cost of the Work*: The term Cost of the Work means the sum of all costs necessary for the proper performance of the Work at issue, as further defined below. The provisions of this Paragraph 13.01 are used for two distinct purposes:
 1. To determine Cost of the Work when Cost of the Work is a component of the Contract Price, under cost-plus-fee, time-and-materials, or other cost-based terms; or
 2. To determine the value of a Change Order, Change Proposal, Claim, set-off, or other adjustment in Contract Price. When the value of any such adjustment is determined on the basis of Cost of the Work, Contractor is entitled only to those additional or incremental costs required because of the change in the Work or because of the event giving rise to the adjustment.
- B. *Costs Included*: Except as otherwise may be agreed to in writing by Owner, costs included in the Cost of the Work shall be in amounts no higher than those prevailing in the locality of the Project, shall not include any of the costs itemized in Paragraph 13.01.C, and shall include only the following items:
 1. Payroll costs for employees in the direct employ of Contractor in the performance of the Work under schedules of job classifications agreed upon by Owner and Contractor. Such employees shall include, without limitation, superintendents, foremen, and other personnel employed full time on the Work. Payroll costs for employees not employed full time on the Work shall be apportioned on the basis of their time spent on the Work. Payroll costs shall include, but not be limited to, salaries and wages plus the cost of fringe benefits, which shall include social security contributions, unemployment, excise, and payroll taxes, workers' compensation, health and retirement benefits, bonuses, sick leave, and vacation and holiday pay applicable

thereto. The expenses of performing Work outside of regular working hours, on Saturday, Sunday, or legal holidays, shall be included in the above to the extent authorized by Owner.

2. Cost of all materials and equipment furnished and incorporated in the Work, including costs of transportation and storage thereof, and Suppliers' field services required in connection therewith. All cash discounts shall accrue to Contractor unless Owner deposits funds with Contractor with which to make payments, in which case the cash discounts shall accrue to Owner. All trade discounts, rebates, and refunds and returns from sale of surplus materials and equipment shall accrue to Owner, and Contractor shall make provisions so that they may be obtained.
3. Payments made by Contractor to Subcontractors for Work performed by Subcontractors. If required by Owner, Contractor shall obtain competitive bids from subcontractors acceptable to Owner and Contractor and shall deliver such bids to Owner, who will then determine, with the advice of Engineer, which bids, if any, will be acceptable. If any subcontract provides that the Subcontractor is to be paid on the basis of Cost of the Work plus a fee, the Subcontractor's Cost of the Work and fee shall be determined in the same manner as Contractor's Cost of the Work and fee as provided in this Paragraph 13.01.
4. Costs of special consultants (including but not limited to engineers, architects, testing laboratories, surveyors, attorneys, and accountants) employed for services specifically related to the Work.
5. Supplemental costs including the following:
 - a. The proportion of necessary transportation, travel, and subsistence expenses of Contractor's employees incurred in discharge of duties connected with the Work.
 - b. Cost, including transportation and maintenance, of all materials, supplies, equipment, machinery, appliances, office, and temporary facilities at the Site, and hand tools not owned by the workers, which are consumed in the performance of the Work, and cost, less market value, of such items used but not consumed which remain the property of Contractor.
 - c. Rentals of all construction equipment and machinery, and the parts thereof, whether rented from Contractor or others in accordance with rental agreements approved by Owner with the advice of Engineer, and the costs of transportation, loading, unloading, assembly, dismantling, and removal thereof. All such costs shall be in accordance with the terms of said rental agreements. The rental of any such equipment, machinery, or parts shall cease when the use thereof is no longer necessary for the Work.
 - d. Sales, consumer, use, and other similar taxes related to the Work, and for which Contractor is liable, as imposed by Laws and Regulations.
 - e. Deposits lost for causes other than negligence of Contractor, any Subcontractor, or anyone directly or indirectly employed by any of them or for whose acts any of them may be liable, and royalty payments and fees for permits and licenses.
 - f. Losses and damages (and related expenses) caused by damage to the Work, not compensated by insurance or otherwise, sustained by Contractor in connection with the performance of the Work (except losses and damages within the deductible amounts of property insurance established in accordance with Paragraph 6.05), provided such losses and damages have resulted from causes

other than the negligence of Contractor, any Subcontractor, or anyone directly or indirectly employed by any of them or for whose acts any of them may be liable. Such losses shall include settlements made with the written consent and approval of Owner. No such losses, damages, and expenses shall be included in the Cost of the Work for the purpose of determining Contractor's fee.

- g. The cost of utilities, fuel, and sanitary facilities at the Site.
- h. Minor expenses such as communication service at the Site, express and courier services, and similar petty cash items in connection with the Work.
- i. The costs of premiums for all bonds and insurance that Contractor is required by the Contract Documents to purchase and maintain.

C. *Costs Excluded:* The term Cost of the Work shall not include any of the following items:

- 1. Payroll costs and other compensation of Contractor's officers, executives, principals (of partnerships and sole proprietorships), general managers, safety managers, engineers, architects, estimators, attorneys, auditors, accountants, purchasing and contracting agents, expeditors, timekeepers, clerks, and other personnel employed by Contractor, whether at the Site or in Contractor's principal or branch office for general administration of the Work and not specifically included in the agreed upon schedule of job classifications referred to in Paragraph 13.01.B.1 or specifically covered by Paragraph 13.01.B.4. The payroll costs and other compensation excluded here are to be considered administrative costs covered by the Contractor's fee.
- 2. Expenses of Contractor's principal and branch offices other than Contractor's office at the Site.
- 3. Any part of Contractor's capital expenses, including interest on Contractor's capital employed for the Work and charges against Contractor for delinquent payments.
- 4. Costs due to the negligence of Contractor, any Subcontractor, or anyone directly or indirectly employed by any of them or for whose acts any of them may be liable, including but not limited to, the correction of defective Work, disposal of materials or equipment wrongly supplied, and making good any damage to property.
- 5. Other overhead or general expense costs of any kind and the costs of any item not specifically and expressly included in Paragraph 13.01.B.

D. *Contractor's Fee:* When the Work as a whole is performed on the basis of cost-plus, Contractor's fee shall be determined as set forth in the Agreement. When the value of any Work covered by a Change Order, Change Proposal, Claim, set-off, or other adjustment in Contract Price is determined on the basis of Cost of the Work, Contractor's fee shall be determined as set forth in Paragraph 11.04.C.

E. *Documentation:* Whenever the Cost of the Work for any purpose is to be determined pursuant to this Article 13, Contractor will establish and maintain records thereof in accordance with generally accepted accounting practices and submit in a form acceptable to Engineer an itemized cost breakdown together with supporting data.

13.02 Allowances

- A. It is understood that Contractor has included in the Contract Price all allowances so named in the Contract Documents and shall cause the Work so covered to be performed for such sums and by such persons or entities as may be acceptable to Owner and Engineer.

- B. *Cash Allowances*: Contractor agrees that:
 - 1. the cash allowances include the cost to Contractor (less any applicable trade discounts) of materials and equipment required by the allowances to be delivered at the Site, and all applicable taxes; and
 - 2. Contractor's costs for unloading and handling on the Site, labor, installation, overhead, profit, and other expenses contemplated for the cash allowances have been included in the Contract Price and not in the allowances, and no demand for additional payment on account of any of the foregoing will be valid.
- C. *Contingency Allowance*: Contractor agrees that a contingency allowance, if any, is for the sole use of Owner to cover unanticipated costs.
- D. Prior to final payment, an appropriate Change Order will be issued as recommended by Engineer to reflect actual amounts due Contractor on account of Work covered by allowances, and the Contract Price shall be correspondingly adjusted.

13.03 *Unit Price Work*

- A. Where the Contract Documents provide that all or part of the Work is to be Unit Price Work, initially the Contract Price will be deemed to include for all Unit Price Work an amount equal to the sum of the unit price for each separately identified item of Unit Price Work times the estimated quantity of each item as indicated in the Agreement.
- B. The estimated quantities of items of Unit Price Work are not guaranteed and are solely for the purpose of comparison of Bids and determining an initial Contract Price. Payments to Contractor for Unit Price Work will be based on actual quantities.
- C. Each unit price will be deemed to include an amount considered by Contractor to be adequate to cover Contractor's overhead and profit for each separately identified item.
- D. Engineer will determine the actual quantities and classifications of Unit Price Work performed by Contractor. Engineer will review with Contractor the Engineer's preliminary determinations on such matters before rendering a written decision thereon (by recommendation of an Application for Payment or otherwise). Engineer's written decision thereon will be final and binding (except as modified by Engineer to reflect changed factual conditions or more accurate data) upon Owner and Contractor, subject to the provisions of the following paragraph.
- E. Within 30 days of Engineer's written decision under the preceding paragraph, Contractor may submit a Change Proposal, or Owner may file a Claim, seeking an adjustment in the Contract Price if:
 - 1. the quantity of any item of Unit Price Work performed by Contractor differs materially and significantly from the estimated quantity of such item indicated in the Agreement;
 - 2. there is no corresponding adjustment with respect to any other item of Work; and
 - 3. Contractor believes that it is entitled to an increase in Contract Price as a result of having incurred additional expense or Owner believes that Owner is entitled to a decrease in Contract Price, and the parties are unable to agree as to the amount of any such increase or decrease.

ARTICLE 14 – TESTS AND INSPECTIONS; CORRECTION, REMOVAL OR ACCEPTANCE OF DEFECTIVE WORK

14.01 *Access to Work*

- A. Owner, Engineer, their consultants and other representatives and personnel of Owner, independent testing laboratories, and authorities having jurisdiction will have access to the Site and the Work at reasonable times for their observation, inspection, and testing. Contractor shall provide them proper and safe conditions for such access and advise them of Contractor's safety procedures and programs so that they may comply therewith as applicable.

14.02 *Tests, Inspections, and Approvals*

- A. Contractor shall give Engineer timely notice of readiness of the Work (or specific parts thereof) for all required inspections and tests, and shall cooperate with inspection and testing personnel to facilitate required inspections and tests.
- B. Owner shall retain and pay for the services of an independent inspector, testing laboratory, or other qualified individual or entity to perform all inspections and tests expressly required by the Contract Documents to be furnished and paid for by Owner, except that costs incurred in connection with tests or inspections of covered Work shall be governed by the provisions of Paragraph 14.05.
- C. If Laws or Regulations of any public body having jurisdiction require any Work (or part thereof) specifically to be inspected, tested, or approved by an employee or other representative of such public body, Contractor shall assume full responsibility for arranging and obtaining such inspections, tests, or approvals, pay all costs in connection therewith, and furnish Engineer the required certificates of inspection or approval.
- D. Contractor shall be responsible for arranging, obtaining, and paying for all inspections and tests required:
 - 1. by the Contract Documents, unless the Contract Documents expressly allocate responsibility for a specific inspection or test to Owner;
 - 2. to attain Owner's and Engineer's acceptance of materials or equipment to be incorporated in the Work;
 - 3. by manufacturers of equipment furnished under the Contract Documents;
 - 4. for testing, adjusting, and balancing of mechanical, electrical, and other equipment to be incorporated into the Work; and
 - 5. for acceptance of materials, mix designs, or equipment submitted for approval prior to Contractor's purchase thereof for incorporation in the Work.

Such inspections and tests shall be performed by independent inspectors, testing laboratories, or other qualified individuals or entities acceptable to Owner and Engineer.

- E. If the Contract Documents require the Work (or part thereof) to be approved by Owner, Engineer, or another designated individual or entity, then Contractor shall assume full responsibility for arranging and obtaining such approvals.
- F. If any Work (or the work of others) that is to be inspected, tested, or approved is covered by Contractor without written concurrence of Engineer, Contractor shall, if requested by Engineer, uncover such Work for observation. Such uncovering shall be at Contractor's expense unless Contractor had given Engineer timely notice of Contractor's intention to

cover the same and Engineer had not acted with reasonable promptness in response to such notice.

14.03 *Defective Work*

- A. *Contractor's Obligation:* It is Contractor's obligation to assure that the Work is not defective.
- B. *Engineer's Authority:* Engineer has the authority to determine whether Work is defective, and to reject defective Work.
- C. *Notice of Defects:* Prompt notice of all defective Work of which Owner or Engineer has actual knowledge will be given to Contractor.
- D. *Correction, or Removal and Replacement:* Promptly after receipt of written notice of defective Work, Contractor shall correct all such defective Work, whether or not fabricated, installed, or completed, or, if Engineer has rejected the defective Work, remove it from the Project and replace it with Work that is not defective.
- E. *Preservation of Warranties:* When correcting defective Work, Contractor shall take no action that would void or otherwise impair Owner's special warranty and guarantee, if any, on said Work.
- F. *Costs and Damages:* In addition to its correction, removal, and replacement obligations with respect to defective Work, Contractor shall pay all claims, costs, losses, and damages arising out of or relating to defective Work, including but not limited to the cost of the inspection, testing, correction, removal, replacement, or reconstruction of such defective Work, fines levied against Owner by governmental authorities because the Work is defective, and the costs of repair or replacement of work of others resulting from defective Work. Prior to final payment, if Owner and Contractor are unable to agree as to the measure of such claims, costs, losses, and damages resulting from defective Work, then Owner may impose a reasonable set-off against payments due under Article 15.

14.04 *Acceptance of Defective Work*

- A. If, instead of requiring correction or removal and replacement of defective Work, Owner prefers to accept it, Owner may do so (subject, if such acceptance occurs prior to final payment, to Engineer's confirmation that such acceptance is in general accord with the design intent and applicable engineering principles, and will not endanger public safety). Contractor shall pay all claims, costs, losses, and damages attributable to Owner's evaluation of and determination to accept such defective Work (such costs to be approved by Engineer as to reasonableness), and for the diminished value of the Work to the extent not otherwise paid by Contractor. If any such acceptance occurs prior to final payment, the necessary revisions in the Contract Documents with respect to the Work shall be incorporated in a Change Order. If the parties are unable to agree as to the decrease in the Contract Price, reflecting the diminished value of Work so accepted, then Owner may impose a reasonable set-off against payments due under Article 15. If the acceptance of defective Work occurs after final payment, Contractor shall pay an appropriate amount to Owner.

14.05 *Uncovering Work*

- A. Engineer has the authority to require additional inspection or testing of the Work, whether or not the Work is fabricated, installed, or completed.

- B. If any Work is covered contrary to the written request of Engineer, then Contractor shall, if requested by Engineer, uncover such Work for Engineer's observation, and then replace the covering, all at Contractor's expense.
- C. If Engineer considers it necessary or advisable that covered Work be observed by Engineer or inspected or tested by others, then Contractor, at Engineer's request, shall uncover, expose, or otherwise make available for observation, inspection, or testing as Engineer may require, that portion of the Work in question, and provide all necessary labor, material, and equipment.
 - 1. If it is found that the uncovered Work is defective, Contractor shall be responsible for all claims, costs, losses, and damages arising out of or relating to such uncovering, exposure, observation, inspection, and testing, and of satisfactory replacement or reconstruction (including but not limited to all costs of repair or replacement of work of others); and pending Contractor's full discharge of this responsibility the Owner shall be entitled to impose a reasonable set-off against payments due under Article 15.
 - 2. If the uncovered Work is not found to be defective, Contractor shall be allowed an increase in the Contract Price or an extension of the Contract Times, or both, directly attributable to such uncovering, exposure, observation, inspection, testing, replacement, and reconstruction. If the parties are unable to agree as to the amount or extent thereof, then Contractor may submit a Change Proposal within 30 days of the determination that the Work is not defective.

14.06 *Owner May Stop the Work*

- A. If the Work is defective, or Contractor fails to supply sufficient skilled workers or suitable materials or equipment, or fails to perform the Work in such a way that the completed Work will conform to the Contract Documents, then Owner may order Contractor to stop the Work, or any portion thereof, until the cause for such order has been eliminated; however, this right of Owner to stop the Work shall not give rise to any duty on the part of Owner to exercise this right for the benefit of Contractor, any Subcontractor, any Supplier, any other individual or entity, or any surety for, or employee or agent of any of them.

14.07 *Owner May Correct Defective Work*

- A. If Contractor fails within a reasonable time after written notice from Engineer to correct defective Work, or to remove and replace rejected Work as required by Engineer, or if Contractor fails to perform the Work in accordance with the Contract Documents, or if Contractor fails to comply with any other provision of the Contract Documents, then Owner may, after seven days written notice to Contractor, correct or remedy any such deficiency.
- B. In exercising the rights and remedies under this Paragraph 14.07, Owner shall proceed expeditiously. In connection with such corrective or remedial action, Owner may exclude Contractor from all or part of the Site, take possession of all or part of the Work and suspend Contractor's services related thereto, and incorporate in the Work all materials and equipment stored at the Site or for which Owner has paid Contractor but which are stored elsewhere. Contractor shall allow Owner, Owner's representatives, agents and employees, Owner's other contractors, and Engineer and Engineer's consultants access to the Site to enable Owner to exercise the rights and remedies under this paragraph.
- C. All claims, costs, losses, and damages incurred or sustained by Owner in exercising the rights and remedies under this Paragraph 14.07 will be charged against Contractor as set-offs against payments due under Article 15. Such claims, costs, losses and damages will

include but not be limited to all costs of repair, or replacement of work of others destroyed or damaged by correction, removal, or replacement of Contractor's defective Work.

- D. Contractor shall not be allowed an extension of the Contract Times because of any delay in the performance of the Work attributable to the exercise by Owner of Owner's rights and remedies under this Paragraph 14.07.

ARTICLE 15 – PAYMENTS TO CONTRACTOR; SET-OFFS; COMPLETION; CORRECTION PERIOD

15.01 Progress Payments

- A. *Basis for Progress Payments:* The Schedule of Values established as provided in Article 2 will serve as the basis for progress payments and will be incorporated into a form of Application for Payment acceptable to Engineer. Progress payments on account of Unit Price Work will be based on the number of units completed during the pay period, as determined under the provisions of Paragraph 13.03. Progress payments for cost-based Work will be based on Cost of the Work completed by Contractor during the pay period.
- B. *Applications for Payments:*
1. At least 20 days before the date established in the Agreement for each progress payment (but not more often than once a month), Contractor shall submit to Engineer for review an Application for Payment filled out and signed by Contractor covering the Work completed as of the date of the Application and accompanied by such supporting documentation as is required by the Contract Documents. If payment is requested on the basis of materials and equipment not incorporated in the Work but delivered and suitably stored at the Site or at another location agreed to in writing, the Application for Payment shall also be accompanied by a bill of sale, invoice, or other documentation warranting that Owner has received the materials and equipment free and clear of all Liens, and evidence that the materials and equipment are covered by appropriate property insurance, a warehouse bond, or other arrangements to protect Owner's interest therein, all of which must be satisfactory to Owner.
 2. Beginning with the second Application for Payment, each Application shall include an affidavit of Contractor stating that all previous progress payments received on account of the Work have been applied on account to discharge Contractor's legitimate obligations associated with prior Applications for Payment.
 3. The amount of retainage with respect to progress payments will be as stipulated in the Agreement.
- C. *Review of Applications:*
1. Engineer will, within 10 days after receipt of each Application for Payment, including each resubmittal, either indicate in writing a recommendation of payment and present the Application to Owner, or return the Application to Contractor indicating in writing Engineer's reasons for refusing to recommend payment. In the latter case, Contractor may make the necessary corrections and resubmit the Application.
 2. Engineer's recommendation of any payment requested in an Application for Payment will constitute a representation by Engineer to Owner, based on Engineer's observations of the executed Work as an experienced and qualified design professional, and on Engineer's review of the Application for Payment and the accompanying data and schedules, that to the best of Engineer's knowledge, information and belief:

- a. the Work has progressed to the point indicated;
 - b. the quality of the Work is generally in accordance with the Contract Documents (subject to an evaluation of the Work as a functioning whole prior to or upon Substantial Completion, the results of any subsequent tests called for in the Contract Documents, a final determination of quantities and classifications for Unit Price Work under Paragraph 13.03, and any other qualifications stated in the recommendation); and
 - c. the conditions precedent to Contractor's being entitled to such payment appear to have been fulfilled in so far as it is Engineer's responsibility to observe the Work.
3. By recommending any such payment Engineer will not thereby be deemed to have represented that:
 - a. inspections made to check the quality or the quantity of the Work as it has been performed have been exhaustive, extended to every aspect of the Work in progress, or involved detailed inspections of the Work beyond the responsibilities specifically assigned to Engineer in the Contract; or
 - b. there may not be other matters or issues between the parties that might entitle Contractor to be paid additionally by Owner or entitle Owner to withhold payment to Contractor.
 4. Neither Engineer's review of Contractor's Work for the purposes of recommending payments nor Engineer's recommendation of any payment, including final payment, will impose responsibility on Engineer:
 - a. to supervise, direct, or control the Work, or
 - b. for the means, methods, techniques, sequences, or procedures of construction, or the safety precautions and programs incident thereto, or
 - c. for Contractor's failure to comply with Laws and Regulations applicable to Contractor's performance of the Work, or
 - d. to make any examination to ascertain how or for what purposes Contractor has used the money paid on account of the Contract Price, or
 - e. to determine that title to any of the Work, materials, or equipment has passed to Owner free and clear of any Liens.
 5. Engineer may refuse to recommend the whole or any part of any payment if, in Engineer's opinion, it would be incorrect to make the representations to Owner stated in Paragraph 15.01.C.2.
 6. Engineer will recommend reductions in payment (set-offs) necessary in Engineer's opinion to protect Owner from loss because:
 - a. the Work is defective, requiring correction or replacement;
 - b. the Contract Price has been reduced by Change Orders;
 - c. Owner has been required to correct defective Work in accordance with Paragraph 14.07, or has accepted defective Work pursuant to Paragraph 14.04;
 - d. Owner has been required to remove or remediate a Hazardous Environmental Condition for which Contractor is responsible; or

- e. Engineer has actual knowledge of the occurrence of any of the events that would constitute a default by Contractor and therefore justify termination for cause under the Contract Documents.

D. *Payment Becomes Due:*

- 1. Ten days after presentation of the Application for Payment to Owner with Engineer's recommendation, the amount recommended (subject to any Owner set-offs) will become due, and when due will be paid by Owner to Contractor.

E. *Reductions in Payment by Owner:*

- 1. In addition to any reductions in payment (set-offs) recommended by Engineer, Owner is entitled to impose a set-off against payment based on any of the following:
 - a. claims have been made against Owner on account of Contractor's conduct in the performance or furnishing of the Work, or Owner has incurred costs, losses, or damages on account of Contractor's conduct in the performance or furnishing of the Work, including but not limited to claims, costs, losses, or damages from workplace injuries, adjacent property damage, non-compliance with Laws and Regulations, and patent infringement;
 - b. Contractor has failed to take reasonable and customary measures to avoid damage, delay, disruption, and interference with other work at or adjacent to the Site;
 - c. Contractor has failed to provide and maintain required bonds or insurance;
 - d. Owner has been required to remove or remediate a Hazardous Environmental Condition for which Contractor is responsible;
 - e. Owner has incurred extra charges or engineering costs related to submittal reviews, evaluations of proposed substitutes, tests and inspections, or return visits to manufacturing or assembly facilities;
 - f. the Work is defective, requiring correction or replacement;
 - g. Owner has been required to correct defective Work in accordance with Paragraph 14.07, or has accepted defective Work pursuant to Paragraph 14.04;
 - h. the Contract Price has been reduced by Change Orders;
 - i. an event that would constitute a default by Contractor and therefore justify a termination for cause has occurred;
 - j. liquidated damages have accrued as a result of Contractor's failure to achieve Milestones, Substantial Completion, or final completion of the Work;
 - k. Liens have been filed in connection with the Work, except where Contractor has delivered a specific bond satisfactory to Owner to secure the satisfaction and discharge of such Liens;
 - l. there are other items entitling Owner to a set off against the amount recommended.
- 2. If Owner imposes any set-off against payment, whether based on its own knowledge or on the written recommendations of Engineer, Owner will give Contractor immediate written notice (with a copy to Engineer) stating the reasons for such action and the specific amount of the reduction, and promptly pay Contractor any amount

remaining after deduction of the amount so withheld. Owner shall promptly pay Contractor the amount so withheld, or any adjustment thereto agreed to by Owner and Contractor, if Contractor remedies the reasons for such action. The reduction imposed shall be binding on Contractor unless it duly submits a Change Proposal contesting the reduction.

3. Upon a subsequent determination that Owner's refusal of payment was not justified, the amount wrongfully withheld shall be treated as an amount due as determined by Paragraph 15.01.C.1 and subject to interest as provided in the Agreement.

15.02 *Contractor's Warranty of Title*

- A. Contractor warrants and guarantees that title to all Work, materials, and equipment furnished under the Contract will pass to Owner free and clear of (1) all Liens and other title defects, and (2) all patent, licensing, copyright, or royalty obligations, no later than seven days after the time of payment by Owner.

15.03 *Substantial Completion*

- A. When Contractor considers the entire Work ready for its intended use Contractor shall notify Owner and Engineer in writing that the entire Work is substantially complete and request that Engineer issue a certificate of Substantial Completion. Contractor shall at the same time submit to Owner and Engineer an initial draft of punch list items to be completed or corrected before final payment.
- B. Promptly after Contractor's notification, Owner, Contractor, and Engineer shall make an inspection of the Work to determine the status of completion. If Engineer does not consider the Work substantially complete, Engineer will notify Contractor in writing giving the reasons therefor.
- C. If Engineer considers the Work substantially complete, Engineer will deliver to Owner a preliminary certificate of Substantial Completion which shall fix the date of Substantial Completion. Engineer shall attach to the certificate a punch list of items to be completed or corrected before final payment. Owner shall have seven days after receipt of the preliminary certificate during which to make written objection to Engineer as to any provisions of the certificate or attached punch list. If, after considering the objections to the provisions of the preliminary certificate, Engineer concludes that the Work is not substantially complete, Engineer will, within 14 days after submission of the preliminary certificate to Owner, notify Contractor in writing that the Work is not substantially complete, stating the reasons therefor. If Owner does not object to the provisions of the certificate, or if despite consideration of Owner's objections Engineer concludes that the Work is substantially complete, then Engineer will, within said 14 days, execute and deliver to Owner and Contractor a final certificate of Substantial Completion (with a revised punch list of items to be completed or corrected) reflecting such changes from the preliminary certificate as Engineer believes justified after consideration of any objections from Owner.
- D. At the time of receipt of the preliminary certificate of Substantial Completion, Owner and Contractor will confer regarding Owner's use or occupancy of the Work following Substantial Completion, review the builder's risk insurance policy with respect to the end of the builder's risk coverage, and confirm the transition to coverage of the Work under a permanent property insurance policy held by Owner. Unless Owner and Contractor agree otherwise in writing, Owner shall bear responsibility for security, operation, protection of the Work, property insurance, maintenance, heat, and utilities upon Owner's use or occupancy of the Work.

- E. After Substantial Completion the Contractor shall promptly begin work on the punch list of items to be completed or corrected prior to final payment. In appropriate cases Contractor may submit monthly Applications for Payment for completed punch list items, following the progress payment procedures set forth above.
- F. Owner shall have the right to exclude Contractor from the Site after the date of Substantial Completion subject to allowing Contractor reasonable access to remove its property and complete or correct items on the punch list.

15.04 *Partial Use or Occupancy*

- A. Prior to Substantial Completion of all the Work, Owner may use or occupy any substantially completed part of the Work which has specifically been identified in the Contract Documents, or which Owner, Engineer, and Contractor agree constitutes a separately functioning and usable part of the Work that can be used by Owner for its intended purpose without significant interference with Contractor's performance of the remainder of the Work, subject to the following conditions:
 - 1. At any time Owner may request in writing that Contractor permit Owner to use or occupy any such part of the Work that Owner believes to be substantially complete. If and when Contractor agrees that such part of the Work is substantially complete, Contractor, Owner, and Engineer will follow the procedures of Paragraph 15.03.A through E for that part of the Work.
 - 2. At any time Contractor may notify Owner and Engineer in writing that Contractor considers any such part of the Work substantially complete and request Engineer to issue a certificate of Substantial Completion for that part of the Work.
 - 3. Within a reasonable time after either such request, Owner, Contractor, and Engineer shall make an inspection of that part of the Work to determine its status of completion. If Engineer does not consider that part of the Work to be substantially complete, Engineer will notify Owner and Contractor in writing giving the reasons therefor. If Engineer considers that part of the Work to be substantially complete, the provisions of Paragraph 15.03 will apply with respect to certification of Substantial Completion of that part of the Work and the division of responsibility in respect thereof and access thereto.
 - 4. No use or occupancy or separate operation of part of the Work may occur prior to compliance with the requirements of Paragraph 6.05 regarding builder's risk or other property insurance.

15.05 *Final Inspection*

- A. Upon written notice from Contractor that the entire Work or an agreed portion thereof is complete, Engineer will promptly make a final inspection with Owner and Contractor and will notify Contractor in writing of all particulars in which this inspection reveals that the Work, or agreed portion thereof, is incomplete or defective. Contractor shall immediately take such measures as are necessary to complete such Work or remedy such deficiencies.

15.06 *Final Payment*

- A. *Application for Payment:*
 - 1. After Contractor has, in the opinion of Engineer, satisfactorily completed all corrections identified during the final inspection and has delivered, in accordance with the Contract Documents, all maintenance and operating instructions, schedules, guarantees, bonds, certificates or other evidence of insurance, certificates of

inspection, annotated record documents (as provided in Paragraph 7.11), and other documents, Contractor may make application for final payment.

2. The final Application for Payment shall be accompanied (except as previously delivered) by:
 - a. all documentation called for in the Contract Documents;
 - b. consent of the surety, if any, to final payment;
 - c. satisfactory evidence that all title issues have been resolved such that title to all Work, materials, and equipment has passed to Owner free and clear of any Liens or other title defects, or will so pass upon final payment.
 - d. a list of all disputes that Contractor believes are unsettled; and
 - e. complete and legally effective releases or waivers (satisfactory to Owner) of all Lien rights arising out of the Work, and of Liens filed in connection with the Work.
3. In lieu of the releases or waivers of Liens specified in Paragraph 15.06.A.2 and as approved by Owner, Contractor may furnish receipts or releases in full and an affidavit of Contractor that: (a) the releases and receipts include all labor, services, material, and equipment for which a Lien could be filed; and (b) all payrolls, material and equipment bills, and other indebtedness connected with the Work for which Owner might in any way be responsible, or which might in any way result in liens or other burdens on Owner's property, have been paid or otherwise satisfied. If any Subcontractor or Supplier fails to furnish such a release or receipt in full, Contractor may furnish a bond or other collateral satisfactory to Owner to indemnify Owner against any Lien, or Owner at its option may issue joint checks payable to Contractor and specified Subcontractors and Suppliers.

B. *Engineer's Review of Application and Acceptance:*

1. If, on the basis of Engineer's observation of the Work during construction and final inspection, and Engineer's review of the final Application for Payment and accompanying documentation as required by the Contract Documents, Engineer is satisfied that the Work has been completed and Contractor's other obligations under the Contract have been fulfilled, Engineer will, within ten days after receipt of the final Application for Payment, indicate in writing Engineer's recommendation of final payment and present the Application for Payment to Owner for payment. Such recommendation shall account for any set-offs against payment that are necessary in Engineer's opinion to protect Owner from loss for the reasons stated above with respect to progress payments. At the same time Engineer will also give written notice to Owner and Contractor that the Work is acceptable, subject to the provisions of Paragraph 15.07. Otherwise, Engineer will return the Application for Payment to Contractor, indicating in writing the reasons for refusing to recommend final payment, in which case Contractor shall make the necessary corrections and resubmit the Application for Payment.

C. *Completion of Work:* The Work is complete (subject to surviving obligations) when it is ready for final payment as established by the Engineer's written recommendation of final payment.

D. *Payment Becomes Due:* Thirty days after the presentation to Owner of the final Application for Payment and accompanying documentation, the amount recommended by Engineer (less any further sum Owner is entitled to set off against Engineer's recommendation,

including but not limited to set-offs for liquidated damages and set-offs allowed under the provisions above with respect to progress payments) will become due and shall be paid by Owner to Contractor.

15.07 *Waiver of Claims*

- A. The making of final payment will not constitute a waiver by Owner of claims or rights against Contractor. Owner expressly reserves claims and rights arising from unsettled Liens, from defective Work appearing after final inspection pursuant to Paragraph 15.05, from Contractor's failure to comply with the Contract Documents or the terms of any special guarantees specified therein, from outstanding Claims by Owner, or from Contractor's continuing obligations under the Contract Documents.
- B. The acceptance of final payment by Contractor will constitute a waiver by Contractor of all claims and rights against Owner other than those pending matters that have been duly submitted or appealed under the provisions of Article 17.

15.08 *Correction Period*

- A. If within one year after the date of Substantial Completion (or such longer period of time as may be prescribed by the terms of any applicable special guarantee required by the Contract Documents, or by any specific provision of the Contract Documents), any Work is found to be defective, or if the repair of any damages to the Site, adjacent areas that Contractor has arranged to use through construction easements or otherwise, and other adjacent areas used by Contractor as permitted by Laws and Regulations, is found to be defective, then Contractor shall promptly, without cost to Owner and in accordance with Owner's written instructions:
 - 1. correct the defective repairs to the Site or such other adjacent areas;
 - 2. correct such defective Work;
 - 3. if the defective Work has been rejected by Owner, remove it from the Project and replace it with Work that is not defective, and
 - 4. satisfactorily correct or repair or remove and replace any damage to other Work, to the work of others, or to other land or areas resulting therefrom.
- B. If Contractor does not promptly comply with the terms of Owner's written instructions, or in an emergency where delay would cause serious risk of loss or damage, Owner may have the defective Work corrected or repaired or may have the rejected Work removed and replaced. Contractor shall pay all claims, costs, losses, and damages (including but not limited to all fees and charges of engineers, architects, attorneys, and other professionals and all court or arbitration or other dispute resolution costs) arising out of or relating to such correction or repair or such removal and replacement (including but not limited to all costs of repair or replacement of work of others).
- C. In special circumstances where a particular item of equipment is placed in continuous service before Substantial Completion of all the Work, the correction period for that item may start to run from an earlier date if so provided in the Specifications.
- D. Where defective Work (and damage to other Work resulting therefrom) has been corrected or removed and replaced under this paragraph, the correction period hereunder with respect to such Work will be extended for an additional period of one year after such correction or removal and replacement has been satisfactorily completed.

- E. Contractor's obligations under this paragraph are in addition to all other obligations and warranties. The provisions of this paragraph shall not be construed as a substitute for, or a waiver of, the provisions of any applicable statute of limitation or repose.

ARTICLE 16 – SUSPENSION OF WORK AND TERMINATION

16.01 *Owner May Suspend Work*

- A. At any time and without cause, Owner may suspend the Work or any portion thereof for a period of not more than 90 consecutive days by written notice to Contractor and Engineer. Such notice will fix the date on which Work will be resumed. Contractor shall resume the Work on the date so fixed. Contractor shall be entitled to an adjustment in the Contract Price or an extension of the Contract Times, or both, directly attributable to any such suspension. Any Change Proposal seeking such adjustments shall be submitted no later than 30 days after the date fixed for resumption of Work.

16.02 *Owner May Terminate for Cause*

- A. The occurrence of any one or more of the following events will constitute a default by Contractor and justify termination for cause:
 - 1. Contractor's persistent failure to perform the Work in accordance with the Contract Documents (including, but not limited to, failure to supply sufficient skilled workers or suitable materials or equipment or failure to adhere to the Progress Schedule);
 - 2. Failure of Contractor to perform or otherwise to comply with a material term of the Contract Documents;
 - 3. Contractor's disregard of Laws or Regulations of any public body having jurisdiction; or
 - 4. Contractor's repeated disregard of the authority of Owner or Engineer.
- B. If one or more of the events identified in Paragraph 16.02.A occurs, then after giving Contractor (and any surety) ten days written notice that Owner is considering a declaration that Contractor is in default and termination of the contract, Owner may proceed to:
 - 1. declare Contractor to be in default, and give Contractor (and any surety) notice that the Contract is terminated; and
 - 2. enforce the rights available to Owner under any applicable performance bond.
- C. Subject to the terms and operation of any applicable performance bond, if Owner has terminated the Contract for cause, Owner may exclude Contractor from the Site, take possession of the Work, incorporate in the Work all materials and equipment stored at the Site or for which Owner has paid Contractor but which are stored elsewhere, and complete the Work as Owner may deem expedient.
- D. Owner may not proceed with termination of the Contract under Paragraph 16.02.B if Contractor within seven days of receipt of notice of intent to terminate begins to correct its failure to perform and proceeds diligently to cure such failure.
- E. If Owner proceeds as provided in Paragraph 16.02.B, Contractor shall not be entitled to receive any further payment until the Work is completed. If the unpaid balance of the Contract Price exceeds the cost to complete the Work, including all related claims, costs, losses, and damages (including but not limited to all fees and charges of engineers, architects, attorneys, and other professionals) sustained by Owner, such excess will be paid to Contractor. If the cost to complete the Work including such related claims, costs, losses,

and damages exceeds such unpaid balance, Contractor shall pay the difference to Owner. Such claims, costs, losses, and damages incurred by Owner will be reviewed by Engineer as to their reasonableness and, when so approved by Engineer, incorporated in a Change Order. When exercising any rights or remedies under this paragraph, Owner shall not be required to obtain the lowest price for the Work performed.

- F. Where Contractor's services have been so terminated by Owner, the termination will not affect any rights or remedies of Owner against Contractor then existing or which may thereafter accrue, or any rights or remedies of Owner against Contractor or any surety under any payment bond or performance bond. Any retention or payment of money due Contractor by Owner will not release Contractor from liability.
- G. If and to the extent that Contractor has provided a performance bond under the provisions of Paragraph 6.01.A, the provisions of that bond shall govern over any inconsistent provisions of Paragraphs 16.02.B and 16.02.D.

16.03 *Owner May Terminate For Convenience*

- A. Upon seven days written notice to Contractor and Engineer, Owner may, without cause and without prejudice to any other right or remedy of Owner, terminate the Contract. In such case, Contractor shall be paid for (without duplication of any items):
 - 1. completed and acceptable Work executed in accordance with the Contract Documents prior to the effective date of termination, including fair and reasonable sums for overhead and profit on such Work;
 - 2. expenses sustained prior to the effective date of termination in performing services and furnishing labor, materials, or equipment as required by the Contract Documents in connection with uncompleted Work, plus fair and reasonable sums for overhead and profit on such expenses; and
 - 3. other reasonable expenses directly attributable to termination, including costs incurred to prepare a termination for convenience cost proposal.
- B. Contractor shall not be paid on account of loss of anticipated overhead, profits, or revenue, or other economic loss arising out of or resulting from such termination.

16.04 *Contractor May Stop Work or Terminate*

- A. If, through no act or fault of Contractor, (1) the Work is suspended for more than 90 consecutive days by Owner or under an order of court or other public authority, or (2) Engineer fails to act on any Application for Payment within 30 days after it is submitted, or (3) Owner fails for 30 days to pay Contractor any sum finally determined to be due, then Contractor may, upon seven days written notice to Owner and Engineer, and provided Owner or Engineer do not remedy such suspension or failure within that time, terminate the contract and recover from Owner payment on the same terms as provided in Paragraph 16.03.
- B. In lieu of terminating the Contract and without prejudice to any other right or remedy, if Engineer has failed to act on an Application for Payment within 30 days after it is submitted, or Owner has failed for 30 days to pay Contractor any sum finally determined to be due, Contractor may, seven days after written notice to Owner and Engineer, stop the Work until payment is made of all such amounts due Contractor, including interest thereon. The provisions of this paragraph are not intended to preclude Contractor from submitting a Change Proposal for an adjustment in Contract Price or Contract Times or otherwise for

expenses or damage directly attributable to Contractor's stopping the Work as permitted by this paragraph.

ARTICLE 17 – FINAL RESOLUTION OF DISPUTES

17.01 *Methods and Procedures*

- A. *Disputes Subject to Final Resolution:* The following disputed matters are subject to final resolution under the provisions of this Article:
 - 1. A timely appeal of an approval in part and denial in part of a Claim, or of a denial in full; and
 - 2. Disputes between Owner and Contractor concerning the Work or obligations under the Contract Documents, and arising after final payment has been made.
- B. *Final Resolution of Disputes:* For any dispute subject to resolution under this Article, Owner or Contractor may:
 - 1. elect in writing to invoke the dispute resolution process provided for in the Supplementary Conditions; or
 - 2. agree with the other party to submit the dispute to another dispute resolution process; or
 - 3. if no dispute resolution process is provided for in the Supplementary Conditions or mutually agreed to, give written notice to the other party of the intent to submit the dispute to a court of competent jurisdiction.

ARTICLE 18 – MISCELLANEOUS

18.01 *Giving Notice*

- A. Whenever any provision of the Contract Documents requires the giving of written notice, it will be deemed to have been validly given if:
 - 1. delivered in person, by a commercial courier service or otherwise, to the individual or to a member of the firm or to an officer of the corporation for which it is intended; or
 - 2. delivered at or sent by registered or certified mail, postage prepaid, to the last business address known to the sender of the notice.

18.02 *Computation of Times*

- A. When any period of time is referred to in the Contract by days, it will be computed to exclude the first and include the last day of such period. If the last day of any such period falls on a Saturday or Sunday or on a day made a legal holiday by the law of the applicable jurisdiction, such day will be omitted from the computation.

18.03 *Cumulative Remedies*

- A. The duties and obligations imposed by these General Conditions and the rights and remedies available hereunder to the parties hereto are in addition to, and are not to be construed in any way as a limitation of, any rights and remedies available to any or all of them which are otherwise imposed or available by Laws or Regulations, by special warranty or guarantee, or by other provisions of the Contract. The provisions of this paragraph will be as effective as if repeated specifically in the Contract Documents in connection with each particular duty, obligation, right, and remedy to which they apply.

18.04 *Limitation of Damages*

- A. With respect to any and all Change Proposals, Claims, disputes subject to final resolution, and other matters at issue, neither Owner nor Engineer, nor any of their officers, directors, members, partners, employees, agents, consultants, or subcontractors, shall be liable to Contractor for any claims, costs, losses, or damages sustained by Contractor on or in connection with any other project or anticipated project.

18.05 *No Waiver*

- A. A party's non-enforcement of any provision shall not constitute a waiver of that provision, nor shall it affect the enforceability of that provision or of the remainder of this Contract.

18.06 *Survival of Obligations*

- A. All representations, indemnifications, warranties, and guarantees made in, required by, or given in accordance with the Contract, as well as all continuing obligations indicated in the Contract, will survive final payment, completion, and acceptance of the Work or termination or completion of the Contract or termination of the services of Contractor.

18.07 *Controlling Law*

- A. This Contract is to be governed by the law of the state in which the Project is located.

18.08 *Headings*

- A. Article and paragraph headings are inserted for convenience only and do not constitute parts of these General Conditions.

STANDARD
SUPPLEMENTARY CONDITIONS*

These Supplementary Conditions amend or supplement the General Conditions of the Construction Contract and other provisions of the Contract Documents as follows. All provisions which are not so amended or supplemented remain in full force and effect.

G.C. – 1.02.D

Delete the definition of "Defective," on Page 5 of the General Conditions, in its entirety, and insert the following:

"Defective - An adjective which when modifying the word "Work" refers to Work that is unsatisfactory, faulty or deficient, or does not conform to the Contract Documents, or does not meet the requirements of any inspection, reference standard, test or approval referred to in the Contract Documents, or which has been damaged prior to Engineer's recommendation of final payment (unless responsibility for the protection thereof has been assumed by Owner at Substantial Completion in accordance with Paragraph 14.04 or 14.05 , and the Work is damaged through no fault of the Contractor after Owner has assumed said responsibility)."

G.C. –1.01.28

Delete the definition of "Owner," on Page 3 of the General Conditions, in its entirety, and insert the following:

"Owner - i.e., City of Lakeland, Tennessee, a municipal corporation."

G.C. – 2.01

All bonds, including Bid Bond, Performance Bond, and Labor and Material Payment Bond, shall be submitted on the forms provided for such purpose by Owner.

G.C. - 2.02

Delete the first sentence of paragraph 2.02 of the General Conditions, and insert the following:

"Owner shall furnish Contractor two (2) sets of the Contract Documents."

* For Use with EJCDC C-700 (2013 Edition) Standard General Conditions Of The Construction Contract.

G.C. - 2.05.A

Add the following to paragraph 2.05.A of the General Conditions:

"This schedule shall be a bar chart, CPM, or PERT Schedule. This schedule shall be updated as required because of actual progress, or as requested by Owner."

G.C. - 3.02.A.1

Add the following to paragraph 3.02.A.1 of the General Conditions:

"In the event of any conflict between the provisions of the Contract Documents and any such referenced provisions, the language of the Contract Documents will take precedence over that of any standard specification, manual, or code."

G.C. - 4.03.A

Delete the following to paragraph 4.03.A of the General Conditions, in its entirety, and insert the following:

"Contractor shall provide construction surveying services to establish horizontal and vertical control and set appropriate bench marks for Contractor's use during construction. The Contractor shall be responsible for any additional surveying required for the construction of the project.

The Contractor shall protect all existing survey monuments, brass caps, property corner markers, right-of-way monuments, and reference points from damage during his operations. If it is necessary to remove any of these to accomplish the Work, the Contractor shall hire a Surveyor licensed to practice in the State of Tennessee to reference and reset such monuments.

All costs required by this Supplementary Condition shall be merged with the other bid items and the Contractor will not receive any additional compensation."

G.C. - 5.03.A

Add the following after paragraph 5.03.A.3 of the General Conditions:

"5.03.A.4 Copies of these reports and drawings that are not included with Bidding Documents may be examined at the Engineer's office during regular business hours. These reports and drawings are not part of the Contract Documents, but the technical data contained therein upon which Contractor is entitled to rely, as provided in Paragraph 5.03.B of the General Conditions, are incorporated therein by reference."

G.C. - 6.01.A

Amend the first sentence of paragraph 6.01.A of the General Conditions to read as follows:

"Contractor shall furnish Performance and Payment Bonds, as required by Tennessee Statutes, each in an amount as specified as security for the faithful performance and payment of all Contractor's obligations under the Contract Documents."

All bonds, including Bid Bond, Performance Bond, and Labor and Material Payment Bond, shall be submitted on the forms provided for such purpose by Owner.

G.C. -6.01.D

Amend paragraph 6.01.D of the General Conditions to read as follows:

"If the surety on any Bond furnished by Contractor is declared a bankrupt, becomes insolvent, or is no longer proper or sufficient, as provided by Tennessee Statutes, or its right to do business is terminated in Tennessee or it ceases to meet the requirements of Paragraph 6.01, Contractor shall within ten (10) days thereafter substitute another Bond and Surety, both of which must be acceptable to Owner."

G.C. - 6.03.A through 6.03.E

Delete paragraphs 5.04.A.1 through 5.04.A.6 of the General Conditions in their entirety and insert the following:

- 6.03.A A. Workmen's Compensation - Statutory Limit; and,
- B. Employer's Liability, with limits of \$500,000; on all employees.
- 6.03.B Comprehensive General Liability (IF USING ISO NEW OCCURRENCE FORM)

General Contractor:

- A. Bodily Injury: \$1,000,000 per claimant
 \$ 1,000,000 per occurrence
 \$ 2,000,000 aggregate
- B. Personal Injury: \$ 2,000,000 aggregate
- C. Property Damage: \$ 1,000,000 per claimant
 \$ 1,000,000 per occurrence
 \$ 2,000,000 aggregate

6.03.C Comprehensive General Liability (IF USING ISO NEW SIMPLIFIED CGL OCCURRENCE FORM)

CONTRACTOR:

- A. General Aggregate: \$2,000,000
- B. Products-Completed Operations Aggregate: \$2,000,000
- C. Personal and Advertising Injury: \$2,000,000
- D. Each Occurrence: \$2,000,000
- E. Fire Damage (any one fire): 1,000,000
- F. Medical Expense (any one person): \$5,000

6.03.D Automobile Liability:

- A. Bodily Injury: \$1,000,000 each person
\$1,000,000 per accident
- B. Property Damage: \$1,000,000 each occurrence

Independent CONTRACTORS: \$1,000,000

6.03.E Coverage General Contractor Only:

- A. Umbrella/Excess Policy Amount: \$2,000,000

G.C. 6.03.I

Add the following after paragraph 6.03.I.5 of the General Conditions:

6. Contractor shall require all subs to carry at least \$500,000 limits in ALL areas described above and provide proof of insurance if required by the Owner.
7. All policies must contain a minimum 30-day notice of cancellation to the Owner.
8. All policies referenced herein shall name the Owner, its agents and executive officers as additional insured.
9. All insurance shall be maintained continuously during the life of the Contract including warranty period, but the Contractor's liabilities under this Contract shall not be deemed limited in any way by the insurance coverage required.

10. The comprehensive general liability insurance shall include completed operations insurance.
11. All of the policies of insurance so required to be purchased and maintained (or the certificates or other evidence thereof) shall contain a provision or endorsement that the coverage afforded will not be canceled, materially changed, or renewal refused until at least thirty (30) days prior written notice has been given to Owner and Engineer by certified mail.
12. All such insurance shall remain in effect until final payment and at all times thereafter when Contractor may be correcting, removing, or replacing defective Work. In addition, Contractor shall maintain such completed operations insurance for at least two (2) years after final payment and furnish owner with evidence of continuation of such insurance upon final payment and one (1) year thereafter. The Owner shall be named as an additional insured on the Contractor's general liability, automobile liability, and umbrella liability policies with respect to Contractor's and its Subcontractor's work under the Agreement. The insurance coverage described herein shall in no way limit or relieve Contractor from indemnifying and holding Owner harmless with respect to claims. Nothing herein shall be construed as a waiver of any immunities, defenses or tort liability limits that the City may have under the Tennessee Governmental Tort Liability Act or other applicable law.
13. Prior to commencement of work, Contractor shall procure and at all times thereafter maintain with an insurer acceptable to the Owner the above referenced minimum insurance protecting the Contractor and Owner against liability from damages because of injuries, including death, suffered by persons, including employees of the Owner, and liability from damages to property arising from or growing out of the Contractor's negligent operations in connection with the performance of this contract.

G.C. -6.04.A

Delete paragraph 6.04.A of the General Conditions in its entirety and insert the following:

“6.04.A Owner shall be responsible for purchasing and maintaining Owner's own liability insurance as it desires, and, at Owner's option, it may purchase and maintain such insurance as will protect Owner against claims which may arise from its operations under the Contract Documents.”

G.C. -6.05.A

Delete paragraph 6.05.A of the General Conditions in its entirety and insert the following:

“6.05.A Contractor shall purchase and maintain property insurance upon the Work at the site in the amount of the full replacement cost thereof. This insurance shall:”

G.C. - 6.05.A.1

Delete paragraph 6.05.A.1 of the General Conditions in their entirety and insert the following:

“6.05.A.1 Owner shall not be responsible for purchasing and maintaining any property insurance to protect the interests of Contractor, Subcontractors, or others in the Work. Risk of loss will be borne by Contractor, Subcontractor, or others suffering any such loss and if any of them wishes property insurance coverage within the limits of such amounts, each may purchase and maintain it at the purchaser's own expense.”

G.C. – 6.06.A through 6.06.D

Delete paragraphs 6.06.A through 6.06.D of the General Conditions in their entirety.

G.C. -6.07.A through 6.07.B

Delete paragraph 6.07.A and 6.07B of the General Conditions in its entirety and insert the following:

“6.07.A Any insured loss under the policies of insurance required by Paragraphs 6.05 will be adjusted with Contractor and Owner and the proceeds made payable to Contractor and Owner.”

“6.07.B Such proceeds shall be held by Owner and Owner shall serve as trustee for the insureds, as their interests may appear. Owner shall distribute the proceeds in accordance with such agreement as the parties in interest may reach. If no other special agreement is reached, the damaged Work shall be repaired or replaced, the monies so received applied on account thereof and the Work and the cost thereof covered by an appropriate Change Order or Written Amendment.”

G.C. - 7.04.C

Delete the first sentence of paragraph 7.04.C of the General Conditions and insert the following:

“The Contractor shall supply the Engineer with three (3) copies of all information and supporting data on each proposal or submittal made pursuant to Paragraphs 7.04.A.2 and 7.04.B, not less than ten (10) days prior to the bid opening date. If approved, the Engineer will approve such request in writing by Addendum.”

G.C. – 7.12.C

Add the following to paragraph 7.12.C of the General Conditions:

“It is the Owner's policy to provide contractors performing work at/on Owner–owned facilities with a list of hazardous chemicals on site, and labeled containers of which are reasonably anticipated to be contained in unlabeled pipes, confined space, or other areas of hazardous chemical exposures, together with related Material Safety Data Sheets. It is the responsibility of the Contractor to properly

and adequately train their employees with respect to hazards presented by such chemicals and remedial measures to be taken in case of exposure."

G.C. - 9.06.A

Delete paragraph 9.06.A of the General Conditions in its entirety.

G.C. - 10.08.B through 10.08.C

Add the following to the end of both paragraphs 10.08.B and 10.08.C of the General Conditions:

"...except to the extent such is in conflict with the Contract Documents or applicable law, known to Engineer, and not disclosed to Owner upon discovery by Engineer."

G.C. - 10.08.D through 10.08.E

Delete paragraph 10.08.D through 10.08.E of the General Conditions in its entirety.

G.C. - 13.01.B.1

Add the following to the end of paragraph 13.01.A.1 of the General Conditions to read as follows:

"The expenses of performing Work after regular working hours, on Saturday, Sunday, or legal holidays, shall be included in the above to the extent authorized by Owner and which are incurred consistent with provisions of Tennessee Statutes."

G.C. - 13.01.B.5.c

Delete paragraph 13.01.B.5.c of the General Conditions in its entirety and insert the following:

"13.01.B.5.c Equipment. For any machinery or special equipment (other than small tools) including fuel and lubricants, plus transportation costs, the use of which has been authorized by the Engineer, the Contractor shall receive payment in accordance with the latest approved edition of the Equipment Rental Rates and Construction Sign Rate Schedule of the Tennessee State Transportation Commission. In the event that any of the equipment to be used is not shown in said schedule, the rental rate for such equipment shall be agreed upon in writing before the Work is started.

13.01.B.5.c.1 Rental of equipment will be measured by time in hours of actual working time and necessary travel time within the limits of the Project. If special equipment ordered by the Engineer is to be used in connection with additional work, travel time to the Project will be measured for payment.

13.01.B.5.c.2 Payment will be made based on the number of hours as outlined above, the sum of which will have no percentage added thereto.

13.01.B.5.c.3 Standby time will be paid only on equipment ordered brought to the Project and/or ordered held on the Project by the Engineer. Equipment already on the Project to complete regular contract items will not be considered for payment for standby time.

13.01.B.5.c.4 No formal rate determination schedule will be required as stated in the "Equipment Rental Rates and Sign Rate Schedule;" however, the Contractor shall submit to the Engineer at the Pre-construction conference his proposed base and service rates schedule for each type, model, and size of equipment to be used on this Project. These rates must be approved by the Engineer and accepted by the Contractor before payment to the Contractor for utilization of these rental items is made.

13.01.B.5.c.5 Should there be no specific bid item for mobilization, mobilization for equipment, normally on the Project, that is involved in additional work shall be considered incidental to the payment provisions for mobilization made in the original Agreement."

G.C. – 13.03.E

Delete paragraph 13.03.E of the General Conditions in its entirety and insert the following:

"13.03.E Adjustments in unit prices for increased or decreased quantities of major pay items will be governed as follows:

13.03.E.1 If the quantity of any major pay item of Work required to complete the project varies from the original contract quantity by 25% or less, payment will be made at the contract unit price.

13.03.E.2 Should the original contract quantity of any major pay item of Work be increased or decreased by more than 25%, either party to the Agreement may demand in writing within fifteen (15) days that a Change Order be negotiated with an adjustment of contract unit prices satisfactory to both parties.

Where the original contract quantity of a major pay item is increased, the adjusted contract price will apply only to that portion of the pay item which is in excess of 125% of the original contract quantity. The adjusted contract unit price for the quantity of the major pay item which is in excess of 125% of the original contract quantity will be negotiated on the basis of the actual cost of the entire item, complete, in place, plus a negotiated allowance for profit and applicable overhead costs.

In the case where a major pay item is decreased by more than 25% from the original contract quantity, the adjusted contract unit price will apply to the quantity measured and accepted for payment. At the request of the

Contractor, adjustment of the contract unit price for the quantity of a pay item which is less than 75% of the original contract quantity will be considered, insofar as it justifies an increase in the pro rata share of the fixed expense chargeable to such pay item because of the decreased quantity of the item. However, total payment for the pay item shall not exceed that amount which would be paid for 75% of the original contract quantity for the pay item at the original contract unit price.

- 13.03.E.3 If neither party demands in writing, an adjustment of unit prices for major pay items of Work, within fifteen (15) days of proposed quantity adjustment, then the contract unit prices will govern.
- 13.03.E.4 No contract unit price adjustment as provided for herein will be made for any major pay item of Work for which the total amount of the adjustment is less than \$1,000.00.
- 13.03.E.5 For the purpose of this Supplementary Condition, major pay items are defined as any contract pay items having an original amount bid in excess of 5% of the total original Contract Price."

G.C. - 14.02.C

Add the following to paragraph 14.02.C of the General Conditions:

"The Contractor shall be responsible for payment of all costs associated with pressure– leakage testing, material testing, asphalt and concrete mix designs, and for direct payment to the testing laboratory for all retests due to failing test results. These retesting costs must be paid before Final Payment."

G.C. - 14.07.A

Amend the first sentence of paragraph 14.07.A of the General Conditions to read as follows:

"If within one (1) year after the date of Final Payment, or such longer period of time as may be prescribed by Laws or Regulations..."

G.C. - 15.01.B.1

Amend the first sentence of paragraph 15.01.B.1 of the General Conditions to read as follows:

"By the date established for each progress payment (but not more often than once a month), Contractor shall prepare and submit to Engineer for review, an Application for Payment filled out and signed by Contractor covering the Work completed as of the date of the Application and accompanied by such supporting documentation as is required by the Contract Documents."

G.C. - 15.01.C.2.d

Add the following to paragraph 15.01.C.2.d of the General Conditions:

“In fulfilling his or her obligations under Tennessee Statute, Owner's representative may rely upon the recommendations of Engineer.”

G.C. - 15.01.C.2.e

Add the following to paragraph 15.01.C.2.e of the General Conditions:

“Owner shall make the progress payment as defined in the Agreement, provided the Application is in order and is approved.”

G.C. - 15.05.A

Add the following after paragraph 15.05.A of the General Conditions:

"15.05.A.1 Correction of Work Before Final Payment. The Contractor shall promptly remove from the premises all materials condemned by the Owner as failing to conform to the Agreement, whether incorporated in the Work or not, and where materials and/or Work have been condemned by the Owner, the Contractor shall promptly replace and re-execute his Work in accordance with the Contract Documents and without expense to the Owner, and shall bear the expense of all retests and making good all Work of other contractors destroyed or damaged by such removal or replacement or re-execution of the Work. Correction of any such condemned Work shall be a condition precedent to any further payment under the Agreement.

15.05.A.2 Deductions for Uncorrected Work. If the Owner deems it inexpedient to correct Work which has been damaged or which has not been done in accordance with the Contract Documents, the difference in value, together with a fair allowance for damage, as determined by the Owner, shall be deducted from the sum agreed to be paid the Contractor for the performance of the Contract."

G.C. - 15.06.A.3

Amend the last sentence of paragraph 15.06.A.3 of the General Conditions to read as follows:

"If any Subcontractor or Supplier fails to furnish a release or receipt in full, and to the extent permissible pursuant to Tennessee Statutes. Contractor may furnish a Bond or other collateral satisfactory to Owner to indemnify Owner against any Lien."

G.C. - 15.06.D.1

Delete paragraph 15.06.D.1 of the General Conditions in its entirety and insert the following:

"15.06.D.1 The Owner shall not be required to make Final Payment to the Contractor until such time as the provisions of Tennessee Statute Sections 66-11-205, have been fulfilled, the retained percentage will be paid within fifteen (15) days of the expiration thereof.

15.06.D.2 Should any liens or claims be filed, retainage equal to the amount of the lien or claim will be held until a satisfactory agreement is reached between the Owner, Contractor, and Contractor's surety.

15.06.D.3 All warranties and guarantees from the Contractor, Subcontractors, Suppliers, etc., shall be delivered to the Owner and be of acceptable form and content as determined by the Owner before Final Payment is made."

G.C. - 15.07.A. through 15.07.B

Amend paragraph 15.07.A of the General Conditions to read as follows:

"A waiver of all claims by Owner against Contractor, except claims arising from unsettled claims for labor and materials, from unsettled Liens, from defective Work appearing after final inspection pursuant to Paragraph 14.06 or from failure to comply with the Contract Documents or the terms of any special guarantees specified therein; however, it will not constitute a waiver by Owner of any rights in respect of Contractor's continuing obligations under the Contract Documents; and,"

Amend paragraph 15.07.B of the General Conditions to read as follows:

"A waiver of all claims by Contractor against Owner other than those previously made known to Owner in writing and still unsettled."

G.S. – 16.02.D

Delete paragraph 16.02.D in its entirety.

G.C. - 16.02.E

Add the following immediately after paragraph 16.02.E of the General Conditions:

"16.02.E.1 Should an act of God result in substantial damage to all or a portion of the Work, or should the Owner's convenience necessitate termination in the sole discretion of the Owner, the Owner shall have the option of terminating the Agreement. If the Owner exercises the option to terminate, a Notice of Termination so providing will be issued. Such Notice of Termination may provide for the Contractor to perform any Work deemed by the OWNER as necessary to put the project in satisfactory condition for the termination of all Work. Payment to the Contractor shall be made in accordance with the

Agreement. Upon the issuance of Notice of Termination, the Contractor shall be relieved of further responsibilities for damage to the Work (excluding materials not already incorporated into the Work) and will not be required to perform any further Work other than that specified in the Notice of Termination.

- 16.02.E.2 When the Owner determines that the Work specified in the Notice of Termination has been completed, the Owner shall accept the Project, and immediately upon such acceptance, the Contractor will not be required to perform any further Work thereon, and shall be relieved of his responsibility for injuries to persons or property.
- 16.02.E.3 After acceptance of the Work, pursuant to the General Conditions, the Contractor will be paid for the Work done prior to termination. The Owner will determine the value of the partially completed Work as follows: The Contractor will be paid for all Work to date. This amount shall be computed by determining the percentage of Work completed prior to termination and multiplying that percentage against the Total Contract Price. The amount to be paid shall not exceed the amounts previously paid or due. The Contractor shall not be entitled to his anticipated profits for the Work which would have been performed, but for termination.
- 16.02.E.4 If, prior to such termination, the Contractor has placed an order for materials specially manufactured for the Project, which materials are not suitable for use in other projects of the Owner or sale to others in the ordinary course of the vendor's business, the Contractor will be paid the actual cost of the materials to the Contractor or the cancellation charges, if any, assessed by the vendor. The determination of whether the order shall be completed or canceled shall be made by the Owner. Any materials approved for payment by the Owner and Contractor shall become the property of the Owner and the actual cost of any further handling will be paid for by the Owner.
- 16.02.E.4 No payment will be made for materials which have been damaged and are not acceptable for incorporation in the Work in accordance with the requirements of the Agreement. The Contractor shall reimburse the OWNER for any amounts previously paid by the Owner for such unacceptable material, and agrees that the Owner may deduct the amount of such previous payment made by the Owner for any monies due or which may become due the Contractor. If the Owner has paid for acceptable materials not incorporated into the Work under the General Conditions, the Owner will have the option of taking title to all or any portion of such materials, or of receiving reimbursement from the Contractor for any amounts previously paid to the Contractor. The Contractor agrees to pay to the Owner upon demand any amounts previously paid for such materials, and agrees that the Owner may

deduct the amount of such previous payments from any monies due or which become due the Contractor.

G.C.- 16.02.G

Add the following paragraphs immediately after paragraph 16.02.G of the General Conditions:

“16.02.G Contractor's Responsibility on Receipt of Notice of Termination.

Upon receipt of Notice of Termination from the Owner, whether for default, convenience of the Owner, or otherwise, the Contractor shall:

1. Stop all Work under the Agreement on the date of, and to the extent specified in, the Notice of Termination.
2. Place no further orders or subcontracts for materials, equipment, or services except as may be necessary for completion of such portions of the Work specified in the Notice of Termination.
3. Cancel or terminate all orders of subcontracts to the extent that they relate to the performance of Work specified in the Notice of Termination; and,
4. Comply with all other requirements of the Owner as may be specified in the Notice of Termination.

16.02.H Subcontract Provision.

The Contractor shall insert in all subcontracts a provision that the Subcontractor shall stop all Work on the date of, or to the extent specified in, a Notice of Termination from the Owner and shall require the Subcontractors to insert the same provision in their subcontracts.

16.02.I Duty to Notify Subcontractors.

The Contractor shall immediately, upon receipt, communicate any Notice of Termination issued by the Owner to all affected Subcontractors."

SECTION 01010

SUMMARY OF WORK

A. Project Identification:

FY2023 Street Paving

B. Project Summary:

This project consists of mill and overlay in the Evergreen Hills Subdivision, Bentbrooke Hills Subdivision and Salem Road as depicted on the enclosed maps. Curb and gutter along with ADA Ramp replacement will be conducted in the Evergreen Hills Subdivision. In addition, two concrete ADA Ramps will be replaced at the raised crosswalk located on Maple Walk Dr. in The Grove Subdivision. A 5-foot wide concrete sidewalk and two concrete ADA ramps will be installed from the intersection of Maple Walk Dr. and Gillespie Oak Dr. to the intersection of Mt Gillespie Dr and Gillespie Oak Dr. in the Oakwood Subdivision.

All base failures repairs and curb and gutter replacement shall be conducted prior to new asphalt being placed.

- Temporary traffic control measures shall be used during all phases of construction. All attempts shall be made to keep at least one lane of roadway open. In the event of a road closure, the Owner shall be notified within 48 hours of the impending work. A traffic control plan for each location shall be submitted to the City Engineer for approval prior to construction.
- The contractor is responsible for all utility locates in the area of work and for those that may be affected by the construction. Coordination with utility company may be required.
- All construction material shall be removed and properly disposed of in accordance with State and local regulations within the time limits of the project. Removal and hauling away of all construction debris including unsuitable soils shall be the responsibility of the Contractor.
- All pavement markings shall meet the current Manual on Uniform Traffic Control Devices (MUTCD) and Tennessee Department of Transportation (TDOT) Specification for pavement markings. All new pavement markings shall be 60 mil thermoplastic for striping and 90 mil thermoplastic for stop bars.
- Material/Density testing will be performed at the request of the Owner. Testing will be paid by invoice.

Mill and Overlay:

Evergreen Hills, Bentbrooke Hills, and Salem Road

- All designated streets shall be milled and a two-inch (2") overlay placed. Asphalt overlay shall be Mix No.1 TDOT 411.E surface course hot mix asphalt. A tack coat shall be applied to the milled surface prior to placement of the asphalt.
- Locations of street repairs will be marked by the City of Lakeland.
- In areas marked for repair, the existing asphalt pavement shall be removed within the marked area. Edges shall be trimmed to a straight vertical line and tacked. All loose or disturbed pavement and base material shall be removed and disposed of.
- Where soft soils are encountered, the area shall be over excavated a maximum of three (3) feet and backfilled with sand. If the soils are still unsatisfactory, a nonwoven geotextile shall be installed in the bottom of the excavation prior to backfilling.
- Asphalt repair shall be two inches (2") Mix No.1 TDOT 411.E surface course hot mix asphalt placed on eight inches (8") of a granular base (LA610). Street repairs shall have a total of three inches (3") of asphalt. Asphalt shall be installed according to City of Lakeland and TDOT Specifications.
- Location of curb and gutter replacement will be marked by the City of Lakeland.
- Curb and gutter shall be replaced in ten (10) foot sections per City of Lakeland Specifications.

Concrete Sidewalk and ADA Ramps:

- Install a 5ft wide 4in thick concrete sidewalk and two concrete ADA Ramps on Gillespie Oak Drive from Maple Walk Dr. to Mt Gillespie Dr. according to Lakeland specifications.
- Remove and replace concrete ADA ramps within Evergreen Hills Subdivision. New ramps shall meet current ADA standards.
- Remove and replace two concrete ADA ramps at the raised crosswalk on Maple Walk Dr. New ramps shall meet current ADA standards.

C. Particular project requirements.

1. Apply for, obtain, and pay for permits when required to perform the work.

2. Field-verify dimensions indicated on drawings (when applicable) before fabricating or ordering materials. Do not scale drawings.
3. Notify Owner of existing conditions differing from those indicated on the drawings. Verify the existence and location of underground utilities along the route of proposed work. Omission from, or inclusion of, locations on the drawings, is not to be considered as the nonexistence of, or the definite location of, existing underground utilities. Do not remove or alter existing utilities without prior written approval.
6. The Contract Documents are intended to provide the basis for proper completion of the work suitable for the intended use of the Owner. Anything not expressly set forth but which is reasonably implied or necessary for proper performance of the project shall be included.
7. The Provisions are written in the imperative mode. Except where specifically intended otherwise, the subject of all imperative statements is the Contractor. For example, "furnish..." means "Contractor shall furnish..."

END OF SECTION

SECTION 01100

GENERAL CONSTRUCTION REQUIREMENTS

PART 1 - Description.

To establish uniform requirements for construction of water distribution facilities, sanitary sewerage collection facilities, storm sewer collection systems, streets, and associated appurtenances which will enable the construction to be performed in accordance with Local, State, and Federal laws.

1.01 Definitions.

A. For the purposes of these specifications, the words and phrases set out in the following articles shall have the meanings as follows:

1. "City" means the governing body of the city of Lakeland, TN.
2. "Contractor" means the individual, partnership, firm, or corporation contracting with the developer or the City which will be performing the work, or which will be performing the construction activities.
3. "Developer" means partnership, firm, or corporation developing property where construction will be performed.
4. "Engineer" means the consultant or City Engineer.
5. "Owner" means the individual, partnership, firm or corporation being the owner of record of property where construction will be performed.
6. "Underground facility" means any item of personal or public property buried or placed below ground for use in connection with the storage or conveyance of electronic, water, sewage, telephonic or telegraphic communications, cable television, electric energy, oil, gas, hazardous liquids, or other substances and including, but not limited to pipes, sewers, water, storm water, conduits, cables, valves, lines, wires, manholes, and attachments.

B. The following abbreviations shall have the designated meanings:

1. "APWA" means the American Public Works Association.
2. "ASTM" means the American Society for Testing and Materials.
3. "AWWA" means the American Water Works Association.

4. "AASHTO" means the American Association of State Highway & Transportation Officials.
- C. Reference to a specific specification, i.e., AWWA C900, means the latest Edition of that specification.

PART 3 Execution

3.01 Scheduling and Construction Progress.

- A. Prior to the start of any work, the Contractor shall submit in writing to the Engineer for review, a progress schedule that shall be followed as closely as possible. Progress scheduling using critical path method is approved and encouraged. Once work has started on a street, it must be pursued continuously until all work on that street is finished.
1. The Contractor shall schedule a preconstruction conference prior to the start of work. Persons attending shall include representatives of the Contractor, subcontractors, owner, developer, Engineer, and affected utilities.
- B. Each successive phase of work will follow the preceding phase as closely as possible so that the time any one street is under construction is kept to a minimum.
- C. In the event that the work is not being accomplished expeditiously or in accordance with the time period set forth in the progress schedule, or if the work on an excavation has ceased or is abandoned without due cause, the Engineer may give written notice to the Contractor and/or the surety company for the project.

3.02 Notification of Landowners, Residents, and Businesses

- A. At least one (1) week prior to beginning construction operations Contractor shall notify in writing, all those directly affected by the Work, including the Fire, Ambulance, Police Departments, and the Engineer's Office. The notification shall include the following as a minimum:
1. Name, address, telephone number, and contact person for Developer, Developer's Contractor, Owner, and Engineer.
 2. A brief description of the proposed Work.
 3. Name and telephone number of Contractor's person to contact in emergency.
 4. A map showing the Work area, the traffic control plan, and the planned access to be provided to the affected properties. The map should also show the property or business owners' access during construction, and access in case of an emergency for fire, ambulance, police, or other emergency service agency vehicles.

5. A schedule for start up and completion of the Work. Schedules shall be updated as needed as the work progresses.
6. Contractor shall notify property owner and occupant 24 hours in advance of any disruption of service or access.

3.03 Available Maintenance Personnel

The Contractor shall have personnel available to maintain the Work as required, 24 hours per day every day. Accordingly, the Contractor shall furnish the City, the Owner, the Engineer, and the Shelby County Sheriff's Office with the names, addresses, and telephone numbers of local employees or representatives who will be available to maintain the Contractor's work during non-working periods, evenings, nights, weekends, and holidays.

3.04 Utility Locates

- A. It is the responsibility of the Contractor to obtain locates for buried facilities within the project area prior to the start of work as necessary and as required by law. The Contractor is responsible for any damage to buried utilities or damage or injury to persons or property resulting from Contractor's work in the vicinity of the utilities.
- B. It is the responsibility of the Contractor to provide advance notice to all utility notification centers serving that area. The Contractor shall request the notification center to provide the nature, location, and elevation of the utility at each location and at whatever interval is necessary for the work. If the utility company cannot or will not provide the information, the Contractor shall obtain the information by whatever means are necessary. For each location that the utility is exposed, the Contractor shall locate the utility by tying it both horizontally and vertically by coordinates, to the datum established by the City.
- C. At all utility crossings the Contractor shall locate the utility at a minimum of one point directly over the proposed line or appurtenance. When existing utilities that parallel the proposed line or appurtenance are exposed by excavation, the Contractor shall locate the utility by tying it both horizontally and vertically to the datum and include the information on the record drawings. At a minimum, the utility shall be tied horizontally and vertically at 300-foot (90 m) intervals.
- D. If during the field location of the utilities, additional unforeseen utilities are discovered, the Contractor shall immediately notify the Engineer and proceed in accordance with approval of the Engineer. The utility must be located by the Contractor as specified above and include the information on the record drawings.
- E. The Contractor must protect all existing utilities and improvements, public or private, located on the right-of-way, and other work areas, during the entire period of his work. Special care must be taken in backfilling and compacting under and around

such improvements. Any breakage or damage to underground facilities caused by trenching, backfilling, resurfacing, or any other activity associated with the work shall be the responsibility of the Contractor.

- F. Whenever utility mains or services are crossed, the utility owner shall be notified and the crossing shall be constructed in accordance with the utility owner's requirements.
- G. Before the Contractor begins his grading operations, he shall confer with the owners of any underground or overhead utilities which may be in or in close proximity to the grading areas, and shall arrange for the necessary disconnection of these utilities in accordance with the regulations of the utility companies concerned. The Contractor shall take such measures as the Engineer may direct in protecting these utilities properly throughout the period his grading operations are in progress. The party or parties owning or operating overhead or underground utilities shall perform the actual work of moving, repairing, reconditioning, or revising the utilities, except as otherwise specified in this Section. Whenever and wherever such operations are undertaken by the owners of utilities, the Contractor shall cooperate to the extent that ample protection of their work will be provided so that the entire work as contemplated may be expedited to the best interests of all concerned, as judged by the Engineer.
- H. Protect and safeguard existing service lines and utilities structures, the locations of which have been made known to the Contractor by the owners of the utilities or by others, prior to excavation or construction of fills or embankments, from damage during grading operations. Any damage to such lines or structures shall be repaired at the Contractor's expense. The above provisions are applicable to all service lines or utilities structures, all or any portion of which protrude above the original ground or street surfaces, or lie beneath such surfaces in any grading area or any other area upon which the Contractor has encroached.

3.05 Protection of Existing Buildings and Structures

For collapse of adjacent buildings, sidewalks, structures, and underground or above ground utilities, the Contractor shall repair damage done to the owner's property or any other property, on or off the premises, by reason of his operations. The Contractor shall adequately brace walls during backfilling and compacting operations.

3.06 Construction Stakes – Alignment and Grades

- A. All work shall be constructed in accordance with lines and grades shown on the drawings and as designated by the Engineer. These lines and grades may be modified by the Engineer as provided in the General Conditions.
- B. The Contractor shall provide experienced personnel, materials, and equipment necessary to complete all survey, layout, and measurement work. The Contractor shall keep the Engineer informed a reasonable time in advance, of the times and places he wishes to do work so that initial control points may be designated.

3.07 Restoration of Street Surface, Street Signs, Curbs, Driveways, Sidewalks, Irrigation and Landscaping

- A. Wherever existing improvements are removed, damaged or otherwise disturbed by Contractor's activities, Contractor shall replace or repair the improvements to conditions equal to or better than the condition prior to the start of work. Any crushed rock, sod, or natural vegetation disturbed by the Contractor shall be replaced, rebuilt or restored to conditions equal to or better than the condition prior to the start of work.

3.08 Temporary Utilities, Public Access and Safety

- A. Contractor shall provide temporary water and sewer service to properties when permanent facilities will be out of service for eight (8) hours or longer, or when other circumstances make it necessary. Where service cannot be interrupted, such as sewer mains, Contractor shall provide plant and equipment to pump around the sections which are out of service.
- B. Where the Engineer deems necessary, the Contractor shall provide access wherever possible to public and private property to prevent serious inconvenience to pedestrian and vehicular traffic. This shall not be construed to require the Contractor to provide such access at the times and locations where it will interfere with his construction progress. The Contractor shall furnish, place, and maintain sufficient flags, flares, barricades, signs, etc., along the location of his work in accordance with the Federal Highway Administration, "Manual on Uniform Traffic Control Devices." Flag persons shall be utilized if necessary to maintain safe traffic flow.

3.09 Erosion and Sediment Control

- A. Erosion and sediment control shall be performed in accordance with rules and regulations adopted by the City of Lakeland and the Tennessee Department of Environment and Conservation.

3.10 City Permits

- A. All necessary permits shall be obtained prior to the beginning of any construction project. Those permits may include: City of Lakeland/TDEC Permit to Construct, Street Cut Permits, Traffic Control Permits, Bonds, and Erosion and Sediment Control Permit, as well as any other appropriate permits required for the project by the City.

3.11 Punchlist and Final Closeout

- A. Initial City Punchlist

1. The Contractor, Owner, Engineer, and City personnel will conduct an initial walkthrough and develop a list of deficiencies that will be presented to the Contractor by the Engineer.
2. The Contractor, Owner, and Engineer will conduct a walkthrough identifying items to be corrected. A final punch list will be developed by the Contractor and Engineer. The punch list will contain dates for completion of the various identified items.
3. All items on the list will be completed to the satisfaction of the City prior to acceptance of the project and start of the one-year warranty period.

3.12 Submittals

The Contractor shall submit for approval by the Engineer a minimum of five (5) copies of data required by specific sections of this specification.

3.13 Workmanship and Cleanup

- A. All debris and rubbish caused by the operations of the Contractor shall be removed, and the areas occupied during his operations shall be left in a neat and presentable condition satisfactory to the Engineer. Construction cleanup and all backfill operations shall immediately follow installation of underground facilities. Cleanup shall be completed to allow local traffic on the street and access to driveways, parking lots, etc. During construction, all existing gutters, storm drains, runoff channels, etc. shall be kept clean of dirt, rubble, or debris which would impede the flow of storm sewer.
- B. Excess, unsuitable, and waste materials from the project (including that from trench excavation, pavement removal, curbside removal, and grading operations), shall be suitably disposed of, offsite, by Contractor.
- C. Excess material resulting from parkway and shoulder finishing and other final operations shall not be permitted to accumulate on the pavement surface and shall be removed concurrently with the finishing operations. Care shall be taken to prevent the entrance of this material into drainage structures or other waterways during the construction period. It shall be the responsibility of the Contractor to properly dispose of all excess material.

3.14 Design Mixes, Testing and Quality Assurance

- A. The testing requirements and cost responsibilities of design mixes, testing requirements, and quality assurance testing are listed in each specific section of these specifications.
- B. Unless specified by the contract documents, or addressed specifically within these

Standard Specifications, the Owner will be responsible for moisture/density/compaction testing only. If the initial moisture/density/compaction test fails to meet the minimum standards as established by these specifications, the Contractor shall pay for any and all additional tests until a moisture/density/compaction test meeting the minimum standards is obtained.

END OF SECTION

SECTION 01200

PROJECT COORDINATION

PART 1 – Description

1.01 SUMMARY

- A. Contractor shall schedule a preconstruction conference (if required) to be held within twenty (20) days of the Notice of Award. Contractor's assigned supervisory personnel and subcontractors shall attend this conference. Contractor shall provide a work schedule at or prior to this meeting for review by all parties. A corrected schedule shall be provided within seven (7) days following the meetings.
- B. Conduct all construction activities between the hours of 7:00 a.m. and 6:00 p.m., Monday through Friday, except in cases of emergencies. No work will be allowed on Saturdays without the Owner's permission, and no work, except for emergencies, will be allowed on Sundays or City of Lakeland Holidays. All pavement subgrade excavation shall be observed by the Owner Representative. The Owner's Representative shall determine the depth of the subgrade excavation prior to backfill.
- C. Contractor shall obtain water for use during construction at his expense. If Contractor elects to obtain water from the public water utility, he will make all the arrangements, comply with their regulations, and pay all fees and charges.

1.02 COORDINATION WITH PUBLIC AND PRIVATE AGENCIES

- A. If utility companies elect to repair or replace their lines in the project area, their crews will be permitted access to the area to accomplish their work.
- B. Contractor is responsible for locating and protecting existing underground improvements. Contact all utility companies for location of their facilities. To contact all utility companies call the local underground number at least 48 hours prior to excavation for field locates.
- C. Contractor shall have personnel available to maintain his work as required 24 hours per day every day. Contractor is responsible for housekeeping, dust and erosion control, and shall provide all equipment and personnel necessary to meet the requirements of this responsibility. Contractor shall provide Engineer with the name(s) and telephone number(s) of the person(s) designated to be available for after-hours contact. If this person cannot be contacted, Owner may use its equipment to correct problems. In this case, Contractor shall pay all costs incurred by Owner.
- D. Do not utilize private property for any purpose without written permission from the property owner.

1.03 COORDINATION WITH OWNER AND ENGINEER

- A. Construct all work in accordance with the lines and grades shown on the Drawings, and as designated by Engineer (when applicable). Engineer may modify these lines and grades as provided in the General Conditions. Where the Contract Documents specify survey work to be provided by Engineer, give Engineer a minimum of 24 hours notice.
- B. Owner shall employ and pay for the services for an independent testing agency to perform tests as required by the Contract Documents. Notify Engineer a minimum of 24 hours in advance to request testing. Contractor shall be responsible for cost of re-tests required if the results of the original tests do not meet the minimum requirements.
- C. Coordinate on-site staging areas, access and temporary facilities with Owner.
- D. For additional information, contact Emily Harrell, PE, Lakeland City Engineer at 867-5418.

1.04 COORDINATION OF CONSTRUCTION

- A. Contractor is responsible for coordinating work of all trades by preparation of schedules and progress reports, coordination of drawings and other work as necessary.
- B. Schedule work to produce orderly, continuous progress and avoid delays due to lack of materials, subcontractor schedule, lack of available manpower, etc.
- F. Contractor is responsible for ensuring that installed and/or completed work is complete and satisfactory prior to enclosing or covering. Call for required inspections in a timely manner and do not cover work that requires inspection.

END OF SECTION

SECTION 01340

SUBMITTALS

PART 1 - Description

1.01 Summary

- A. Comply with Submittal format requirements as specified in the Contract Documents.
- B. Provide, in a timely manner, the number of copies and types of submittals listed in individual sections of the Contract Documents. If not specified elsewhere, provide the following as a minimum:
 - 1. Mix designs and certifications of compliance for Portland Cement Concrete, Cement Treated Base, Aggregate Base Course, Asphaltic paving material, and any other material or product used as part of this project as required in the Standard Specifications.
 - 2. Closeout submittals.
- C. Provide required resubmittals in the appropriate quantities if original submittals are not approved.
- D. Samples and shop drawings shall be prepared specifically for this project. Shop drawings shall include dimensions and details, including adjacent construction and related work. Note any special coordination required. Note any deviations from requirements of the Contract Documents. Submittal data shall be properly labeled indicating specific service for which material or equipment is to be used, section and article number of specifications, project name, Contractor, etc. Data of a general nature will not be accepted.
- E. Failure of Contractor to submit shop drawings in ample time for checking shall not entitle him to an extension of contract time.

END OF SECTION

SECTION 01505

TEMPORARY FACILITIES

PART 1 - Description

1.01 Summary

A. Provide temporary services and utilities, including utility costs:

1. Potable and non-potable water.
2. Lighting and power.
3. Toilet facilities.
4. Materials storage.
5. Heating.

B. Provide construction facilities, including utility costs;

1. Construction equipment.
2. Dewatering and pumping.

C. Provide security and protection requirements:

1. Fire extinguishers.
2. Site enclosure fence, barricades, warning signs, and lights.
3. Snow and ice removal, if applicable.

D. Provide personnel support facilities:

1. Sanitary facilities.
2. Drinking water.
3. Cleaning and trash removal.
4. First aid and Emergency Medical Services.
5. Trash removal.

END OF SECTION

SECTION 01650

MEASUREMENT AND PAYMENT PROCEDURES

PART 1 – Description.

All work completed under this Contract will be measured by the Engineering according to the bid items and to the construction drawings. Units of measurement and dimensions will be shown in these specifications.

1.01 Payment

A. Progress payments will be processed in accordance with the following schedule.

<u>Cut-Off Date</u>	<u>Date of Submittal</u>
March 17, 2023	March 24, 2023
April 21, 2023	April 28, 2023
May 19, 2023	May 26, 2023
June 16, 2023	June 23, 2023
July 21, 2023	July 28, 2023

Submit pay requests to the City by the dates of submittal listed above.

- B. Owner will make progress payments as defined in Article 5 of the Agreement, on the forms provided by the Engineer.
- C. If the Contractor elects to enter into a joint account agreement, two (2) pay requests and vouchers must be submitted. One pay request and voucher for the appropriate progress payment amount, the other for the retained amount.

1.02 Measurement of Quantities

Quantities shown on the bid schedule are estimated and are to be considered approximate. Actual constructed quantities will vary. The Contractor will be compensated only for those items and materials actually installed and approved as part of the project. No additional pay will be granted for items or materials not installed.

- A. Payment will be made for the work completed and stored materials less retained amounts in accordance with provisions of the contract documents.
- B. Payment amounts will be based on the scheduled values and mutually agreed upon percentage of completion for each item.

1.03 Bid Item Descriptions

The cost of all material and labor required to complete this project as specified and shown on the drawings, but not specifically included as a pay item, shall be included in the bid price of its related bid item. No extra pay shall be granted for items that are reasonably foreseen as necessary for the proper installation of an item.

PART 2 Execution

2.01 Measurement and Payment of Bid Items

A. Cold Planing of Asphalt Pavement

1. Measurement of this item shall be by the number of square yards (SY) of asphalt planed and removed. Measurement shall be made on the surface of the existing asphalt cut and removed. This item shall include equipment, materials and labor to perform cold planing and cutting disposal. Payment shall be made by the contract unit price per Square Yard (SY).

B. Furnish and Install Select Backfill (Sand)

1. Measurement of this item shall be by the number of cubic yards (CY) of select backfill furnished and installed in place and approved. Quantities shall be verified and paid by haul ticket. This item includes excavation, disposal of existing material, furnishing and installing granular backfill, and compaction. Payment shall be by the contract unit price per Cubic Yards (CY) in place.

C. Furnish and Install Granular Base (LA610)

1. Measurement of this item shall be by the number of cubic yards (CY) of granular base furnished and installed in place and approved. Quantities shall be verified and paid by haul ticket. This item includes excavation, removal and disposal of existing base, furnishing and installing granular base, and compaction. Payment shall be by the contract unit price per Cubic Yards (CY) in place.

D. Furnish and Install Nonwoven Geotextile

1. Measurement of this item shall be paid by square yard (SY) of nonwoven geotextile furnished and installed in place and approved. This item shall include furnishing and placement of geotextile in excavated areas. Payment shall be made by the contract unit price per Square Yard (SY) in place

E. Furnish and Install Tack Coat

1. Measurement of this item shall be by the number of tons (Tons) of tack coat furnished and installed in place and approved. Quantities shall be verified and paid by haul ticket. This item shall include furnishing and placement of tack coat at a rate of 0.10 gal/SY. Payment shall be made by the contract unit price per Ton (Ton) in place

F. Furnish and Install Asphalt Patch

1. Measurement of this item shall be by the cubic yard (CY) of asphalt furnished, installed in place and approved. Measurement shall be made from the lines formed by the junction of new asphalt and old asphalt. Quantities shall be verified and paid by haul ticket. This item shall include furnishing and placement of new hot mix asphalt and compaction. Asphalt patch shall have a compacted thickness of no less than two inches (2") of hot mix asphalt pavement. Payment shall be by the contract unit price per Cubic Yard (CY) in place.

G. Furnish and Install Asphaltic Concrete Pavement (411-E)

1. Measurement of this item shall be by the tons (Ton) of hot-mix asphaltic concrete furnished and installed in place and approved. Measurements shall be made from the lines formed by the junction of new asphalt and old asphalt. Quantities shall be verified and paid by haul ticket. This item shall include furnishing and placement of new hot mix asphalt and compaction. New asphalt overlay shall have a compacted thickness of no less than two inches (2") of mill and overlay of asphalt pavement after compaction. Payment shall be by the contract unit price per Ton (Ton) in place.

H. Furnish and Install Temporary Traffic Control

1. Measurement of this item shall be paid by lump sum (LS) for temporary traffic control furnished and installed. Payment shall be consistent with the percentage of work completed at the time of the request for payment. The lump sum payment shall cover all of the Contractor's activities in meeting traffic control requirements for the project. Flagging, replacement of traffic control devices damaged or destroyed from any cause whatsoever, furnishing and installing cones, wands, portable flashers, any barricades and channelizing devices will be incidental to Traffic Control and no separate payment will be made for any item or activity necessary to comply with this specification. Payment shall be made by the contract unit price per Lump Sum (LS) of work completed.

I. Remove and Replace 6-30 Concrete Curb and Gutter

1. Measurement of this item shall be paid by lineal foot (LF) of 6-30 concrete curb and gutter constructed in place and approved. Measurement shall be made on the surface of the new curb and gutter from the lines formed by the junction of the new concrete and old concrete. This item shall include excavation, forming, concrete, and all other materials needed to perform work. Payment shall be made by the contract unit price per Lineal Foot (LF) in place and approved.

J. Remove and Replace ADA Concrete Ramps

1. Measurement of this item shall be paid by each (EA) ADA concrete ramp constructed in place and approved. This item shall include excavation, forming, concrete, truncated domes and all other materials needed to perform work. Payment shall be made by the contract unit price each (EA) in place and approved.

K. Furnish and Install ADA Concrete Ramps

1. Measurement of this item shall be paid by each (EA) ADA concrete ramp constructed in place and approved. This item shall include excavation, forming, concrete, truncated domes and all other materials needed to perform work. Payment shall be made by the contract unit price each (EA) in place and approved.

L. Installation of Concrete Sidewalk

1. Measurement of this item shall be paid by linear feet (LF) of 5ft wide 4-inch-thick concrete sidewalk constructed in place and approved. Measurements shall be made on the surface of the new sidewalk from the existing ramp to the new ramp. This item shall include excavation, forming, concrete, and all other materials needed to perform work. Payment shall be made by the contract unit price per Linear Feet (LF) in place and approved.

M. Furnish and Install 60 mil Thermoplastic 4" Solid White Line

1. Measurement of this item shall be paid by the linear feet (LF) of 60 mil thermoplastic 4" solid white line pavement marking furnished and installed. Measurements shall be made on the surface of the new pavement marking to the end. The item shall include thermoplastic material, glass beads, equipment, and any other material needed to perform the work.

N. Furnish and Install 60 mil Thermoplastic 4" Double Yellow Line

1. Measurement of this item shall be paid by the linear feet (LF) of 60 mil thermoplastic 4" double yellow line furnished and installed. Measurements shall be made on the surface of the new pavement marking to the end. The item shall include thermoplastic material, glass beads, equipment, and any other material needed to perform the work.

O. Furnish and Install 90 mil Extruded Thermoplastic 24" White Stop Bar

1. Measurement of this item shall be paid by the linear feet (LF) of 24" white stop bar extruded thermoplastic marking furnished and installed. Measurements shall be made on the surface of the new pavement marking to the end. The item shall include thermoplastic material, glass beads, equipment, and any other material needed to perform the work.

P. Material/Density Testing

1. Measurement of this item shall be paid by lump sum (LS) for density testing. Contractor performing testing shall be approved by the Owner prior to performing work. Payment shall be made by invoice from Geotechnical Engineer of actual testing performed. This item includes but is not limited to density testing. Payment shall be made by the contract unit price per Lump Sum (LS) of work completed.

D. Mobilization

1. Measurement of this item shall be paid by lump sum (LS) for mobilization. This item shall include all costs for mobilization, including mobilization of equipment to the project site and property owner notifications in accordance with these specifications. Payment shall be by the contract unit price per Lump Sum (LS).

END OF SECTION

SECTION 01750

CONTRACT CLOSEOUT

PART I Description

1.01 Summary

- A. Provide prerequisites to substantial completion.
 - 1. Punch list.
 - 2. Supporting documentation.
 - 3. Warranties.
 - 4. Certifications.

- B. Provide prerequisites to final acceptance.
 - 1. Final payment request with supporting affidavits.
 - 2. Completed punch list.
 - 3. Submit record documents: One set of drawings and project manual with all changes noted in red and Project Manual changes flagged with page tabs.
 - 4. Final clean-up.
 - 5. Removal of temporary facilities.

END OF SECTION

SECTION 01810

SPECIAL PROVISIONS

PART 1 Description

1.01 SUMMARY

- A. These "Special Provisions" supplement, clarify, or modify provisions of Specifications as they apply to this project.
- B. Requirements of Special Provisions, General and Supplemental Conditions apply to work performed under all sections of this project.
- C. Work of this contract shall include all work required to construct the entire Project as shown on the drawings and defined by the Specifications and other contract documents, unless specific exceptions are stated therein.
- D. DISCREPANCY BETWEEN SPECIAL PROVISIONS, SPECIFICATIONS, AND PLANS. In the event of discrepancy between Special Provisions and other sections of the Specifications, the Special Provisions will take precedence over the Specifications, the General Conditions, and the Supplemental Conditions. The Specifications will take precedence over the Plans.

1.02 LABOR PRACTICES

A. EIGHT-HOUR WORK DAY

The Contractor's attention is directed to, Limitation on work hours; overtime; exceptions. a) No person shall require laborers, workmen, or mechanics to work more than eight hours in any one calendar day or forty hours in any one week upon any public works of the state, or any of its political subdivisions, except as hereafter authorized. An employee may agree to work more than eight hours per day or more than forty hours in any week provided the employee shall be paid at the rate of one and one-half times the regularly established hourly rate for all work in excess of forty hours in any one week.

1.03 BACKFILL OBSERVATION

No work shall be covered before the Project Representative or Engineer has approved the work. If any piping or appurtenance is covered without the approval of the Engineer or Project Representative, at the discretion of the Engineer, the Contractor will be required to re-excavate to expose the covered materials. The cost of exposing those materials and then backfilling and compaction will be at the Contractor's expense, regardless of the condition of

the pipe and/or the materials under question.

1.04 CONSTRUCTION WATER

The Contractor is responsible for supplying water for construction purposes. If the Contractor wishes to use existing fire hydrants for water, he shall make the proper arrangements with the owner of the hydrant. The Contractor will be responsible for compliance with that owner's requirements as well as the payment of any fees for its use. Construction water is considered incidental to this project and no separate payment will be made to the Contractor for this item. If the Contractor wishes to use water from a resident, he shall obtain written permission from that resident to do so.

1.05 SAFETY

In accordance with generally accepted construction practices, the Contractor will be solely and completely responsible for safety conditions at and adjacent to the job site, including the safety of all persons and property during the performance of the work. The Contractor shall comply with all federal, state, and local safety laws and regulations. This requirement shall apply continuously, and shall not be limited to normal working operations. The Engineer's construction review of the Contractor's performance is not intended to include review of the adequacy of the Contractor's safety measures, in, on, or near the construction site. This paragraph shall be applicable to the Contractor and all of the Contractor's subcontractors.

In addition, the Contractor shall provide barriers, fences, signs, lights, etc. as necessary to control access to the site.

Contractor shall provide Owner a written copy of their confined spaced program, proof of record-keeping protocol and inventory of appropriate equipment such as monitors for atmospheric hazards and rescue equipment. These documents shall be submitted at the preconstruction conference.

1.07 DUST CONTROL

The Contractor shall be responsible for dust and erosion control, and for minimizing dust and erosion to the Owner's satisfaction. Dust and erosion control shall be deemed to be incidental and shall not be a pay item.

1.08 DISPOSAL OF WASTE MATERIALS

Excess, unsuitable, and waste materials from this project (including that from trench excavation, pavement removal, piping removal, and grading operations), shall be disposed of, offsite, by Contractor. Such disposal shall be considered incidental, and shall not be a pay item.

1.09 CODES AND STANDARDS

All materials and the completed installation shall comply with applicable standards promulgated pursuant to the State of Tennessee and City of Lakeland.

1.10 OPEN EXCAVATIONS

The Contractor shall completely backfill all excavations before stopping work for the day. No excavation (fenced or unfenced) shall be left open overnight, over a weekend, nor any period in which no work at that location is underway. The cost of reopening or re-excavation due to this provision will be borne by the Contractor.

1.11 CONSTRUCTION SURVEYING AND STAKING

In this project, lines and grades of replaced appurtenances shall match those existing. When new appurtenances such as drain lines, catch basins, curb, sidewalks, and new roadway crowns are to be installed, the Contractor will provide construction surveying and staking, unless otherwise noted.

1.12 CLEANING AND FINISHING

After completion of all work all debris and foreign material will be removed by the contractor. The project area, including staging areas, shall be clean and functional. This will include the restoration of any disturbed landscaping in the work area.

1.13 TRAFFIC CONTROL

A traffic control plan is required for repairs in areas affecting traffic. The Contractor is responsible for furnishing a traffic control plan to the City Engineer at least one week prior to the start of construction. Excavations which traverse a street shall be limited to one-half the width of the street at any one time, unless an emergency situation exists which requires the entire width of the street be excavated. The City Engineer's approval is required prior to traversing an entire street. The closure should not exceed forty-eight (48) hours and proper signage shall be installed detouring traffic and warning of construction.

END OF SECTION

SECTION 01551

TEMPORARY TRAFFIC CONTROLS

PART 1. Description

To establish uniform requirements for detours, signs and barricades, and traffic control plans associated with construction activities performed on or affecting City of Lakeland streets. The work in this article shall consist of furnishing, erecting, maintaining, relocating, and removing temporary traffic control devices at the locations specified on the drawings and as directed by the Engineer. All traffic control devices shall conform to the provision for construction signing as set forth in the Manual on Uniform Traffic Control Devices for Streets and Highways (MUTCD) latest edition.

PART 2 MATERIALS

2.01 Traffic Control Products

A. Sign Panels

1. Sign panels will be constructed of ¾" plywood conforming to plywood sign panels and barricades of the standard specification for road and bridge construction; or 6061-T6 or 5052-H38 aluminum alloy sheeting conforming to ASTM B209.
2. Wood sign panels will be backed with metal backing angles; except that backing is not required for those sign panels 48" x 60" or smaller.
3. Aluminum sign panels will be 0.125" thick and backed with metal backing angles; except that those sign panels 48" x 60" or smaller may be:
 - i. 0.080" thick and backed with metal backing angles or 2 x 4 lumber; or,
 - ii. Unbacked, 0.125" thick.
4. Special signs which are unique to the project, i.e., signs not shown on the plans or included in part VI of the MUTCD, and signs shown on the plans which contain a message that is unique to the project, will be furnished by the contractor, as specified on the plans, and erected by the Contractor. Posts and hardware for fixed special sign installations, and all equipment for portable special sign installations will be furnished by the contractor. Post lengths will be specified by the Engineer. Upon removal, the special sign panels, posts, hardware, and portable installation equipment will remain the property of the Contractor.

- i. Special signs will be erected on fixed mountings unless portable mountings are authorized by the Engineer.
- B. Barrels will be plastic conforming to the MUTCD, with 6” wide reflective stripes.
- C. Temporary markings
 1. Temporary reflective pavement markings will be paint, preformed tape, or raised pavement markers, and will be suitable for use on either Portland cement concrete or asphalt pavements. Minimum acceptable standards are as follows:
 - i. Paint used for temporary markings will be commercially manufactured highway striping paint. The paint will be applied without dilution.
 - ii. All painted stripes will be 4” wide, and will be reflectorized by dropping or spraying glass beads onto the wet paint.
 - iii. The reflective beads will conform to AASHTO Specification M247, Type 1.
 2. Temporary reflective pavement striping tape will be 4” wide, pressure-sensitive tape manufactured for use as pavement striping.
 - i. Striping tape applied to finished pavement surfaces which will be returned to normal traffic use will be a removable type.
 - ii. Striping tape applied to temporary pavement surfaces which will be obliterated may be a non-removable type.
 - iii. Striping tape applied to the surface of intermediate lifts of asphalt pavement may be non-removable type, and may be let in place. If a removable type is used, it will be removed before placing the next lift.
 3. Temporary retro-reflective raised pavement markers manufactured by Astro Optics of Schaumburg, Illinois, Model No. TPM, or Stimsonite Products of Niles, Illinois, Model No. 66, or an approved equal will be acceptable.
 4. Temporary retro-reflective motorist guidance markers manufactured by Davidson Plastic Company of Ken, Washington, Model NO. TRPM, or TOM, or an approved equal will be acceptable.

PART 3 EXECUTION

3.01 Traffic Control Plans

- A. A complete traffic control plan shall be submitted to the Engineer and the Lakeland City Engineering office at least one week prior to the start of construction.
1. Traffic will be permitted to use the street at all times, unless a detour is specifically permitted on the drawings or by the Engineer. Access to all abutting residences and properties shall be maintained to the maximum extent possible.
 2. The Contractor shall construct and maintain temporary crossings, complete with flagmen, whenever necessary to expedite the work or to maintain traffic. The Contractor shall furnish not less than two flagmen at each location where loading or depositing of material requires the turning of the trucks on any highway or street and where the operation of construction equipment endangers traffic. Temporary crossings shall be of ample size to safely carry the load which comes upon them.
 - i. The Contractor shall maintain the streets in a passable condition. The work shall be conducted so as to create a minimum of inconvenience to traffic.
 - ii. Excavations which traverse a street shall be limited to one-half the width of the street at any one time, unless an emergency situation exists which requires that the entire width of the street be excavated. City Engineer's office approval is required prior to excavation traversing an entire street.
 3. The Contractor shall furnish sufficient signs and barricades to facilitate the directing of traffic. Unless directed otherwise by the Engineer, all signs and barricades shall conform to:
 - i. Within the "Manual on Uniform Traffic Control Devices (MUTCD), " latest edition.
 4. The Contractor shall have a sufficient number of barricades and signs on hand prior to the start of the construction
 - i. Each detour sign shall be reflectorized and shall be illuminated with two battery-powered blinkers with six-inch (6") amber lenses.
 - ii. All barricades shall have blinker lights on each end.
 - iii. It shall be the Contractor's responsibility to make necessary checks and inspections of all lights and barricades every day, including Sundays and holidays.
 5. Temporary suspension of work does not relieve the Contractor of the responsibility outlined in the above requirements.

3.02 Permits

- A. The Contractor shall obtain all necessary permits from the City Engineer's office for any closure of any street or portion thereof, as provided in the Lakeland Municipal Code. Along with the permit application, the Contractor shall provide a sketch showing traffic routing and traffic control devices to be used. The construction traffic control sketch shall be approved by the City Engineer's office before the permit is issued.

3.03 Street Closure

- A. The City Engineer may permit the closing of streets to all traffic for a period of time prescribed by the office if, in the City Engineer's Opinion, it is necessary.

END OF SECTION

SECTION 02340

GEOTEXTILE FABRICS AND MEMBRANES

PART 1 - Description

This section covers furnishing and placing geotextiles as shown on the plans or directed, in accordance with these specifications. The geotextile usage will determine the applicable specifications and the corresponding pay item.

PART 2 - Materials

A. The geotextile shall consist only of woven or non-woven, long-chain polymeric filaments or yarns such as polyethylene, polyester, polypropylene, polyamide, or polyvinylidene chloride formed into a stable network such that the filaments or yarns retain their relative positions to each other.

B. Membrane Requirements

Geotextile and Impermeable Plastic Membrane Specifications								
Fabric and Membrane Property	Test Method	Drainage And Filtration	Erosion Control	Silt Fence	Separation & Stabilization		Embankment & Retaining Wall Reinforcement	Impermeable Plastic Membrane
					Woven	Non-Woven		
*EOS (mm)	ASTM D4751	40-70	40-100	40-100	30-50	40-100	30-70	-----
Thickness, Mils (mm)	ASTM D5199	-----	-----	-----	----	-----	-----	12 (0.305)
Permittivity, cm/sec	ASTM D5199	1.0	1.0	0.1	0.05	1.0	0.05	<10 ⁻⁷ cm/sec
Grab Tensile Strength	ASTM D4632	90	180	90	200	160	300	150
Elongation at Failure% Min	ASTM D4533	40	40	50	15	40	15	20
Trap Tear Strength, lbs	ASTM D4833	40	70	50	65	60	110	50
Puncture Strength, lbs	ASTM D4632	50	90	60	90	80	110	60

*Equivalent or Apparent Opening Size, U.S. Standard Sieve (mm)

PART 3 – Execution for Stabilization Fabric

3.01 Equipment

- A. Equipment loads when placing and compacting the material placed over the stabilization geotextiles shall comply with the following:
 - 1. Maximum wheel load shall be 9,945 pounds (4500 kg), or as specified.
 - 2. Maximum contact pressure shall be 60 psi (400kPa). The contact pressure is calculated from the applied wheel load in newtons and the resulting contact area in square meters.
 - 3. Rutting in excess of three inches (3”) (75mm) will not be allowed. Equipment loads are to be lightened if this occurs. Ruts shall be repaired by filling the ruts with additional material.

3.02 Construction Requirements.

- A. The geotextile shall be lapped at the ends and sides of adjoining sheets unless shown otherwise on the plans or described herein. Geotextile that is joined by sewing shall have strength properties at the seam equal to the specified strength requirements of the geotextile. All seams shall be exposed for ease of inspection. High-strength polyester, polypropylene or kevlar thread shall be used for sewn seams. Nylon threads shall not be used. Overlapping J seams and double sewing are required for field seams.
- B. Gravel, pit run base course, sand, or other specified material shall be placed on the geotextile so that it is not torn, punctured, or shifted. Maximum pile heights of materials shall be limited to prevent geotextile distortion. Any geotextile that is torn or punctured shall be repaired. The repair shall consist of a patch of the same type of geotextile placed over the ruptured area and overlapped a minimum of three feet (3’) (1m) from the edge of any part of the rupture, or a sewn patch with the same requirements for seam strength as that of the geotextile being repaired.
- C. Pegs or pins, as approved by the Engineer, may be used to hold the geotextile for embankment erosion control in place until the specified cover material has been placed. Pegs or pins shall not be used for other types of geotextile installations without approval of the Engineer. If such approval is given, pegs or pins shall be used only at locations that are not detrimental to the finished product.
- D. When geotextile is used for foundation stabilization, the following criteria shall govern:
 - 1. The cover material shall be placed over the geotextile in 1-foot (0.3m)+/- lifts.
 - 2. Equipment shall not be operated directly on the geotextile. The minimum left thickness shall be maintained at all times.

3. The cover material shall be compacted with a roller or other equipment as approved by the Engineer.
 4. Prior to the installation of geotextile, the subgrade shall be leveled and smoothed to remove ruts, depressions, or humps, which exceed four inches (4") (100mm). The surface also shall be free of rocks, stumps, roots, brush, limbs, or other objects that might tear or puncture the geotextile or result in geotextile wear.
- E. During periods of shipment and storage, the geotextile shall be enclosed in heavy duty wrapping to protect it from direct sunlight, ultraviolet rays, temperatures greater than 140°F (60°C), mud, dirt, dust, and debris. Any geotextile left unprotected shall be removed from the project.
- F. The product name, type of material and the lot or batch identification shall be clearly labeled on each roll.
- G. Except for geotextile used for erosion control and silt fence, the cover material shall be placed over the fabric within five (5) days.
- H. Test results, with a certification by the manufacturer showing the geotextile performance in regard to the material requirements of this specification, shall be submitted to the Engineer. At least two weeks before the use of any geotextile, a sample six feet (6') (2 m) in length by the full width of the roll shall be submitted to the Engineer. The sample shall be labeled with the product name, machine direction, the lot and batch number, date of sampling, project number, and certification of compliance with the material specifications. If sewing is specified, a seam sample also shall be submitted to the Engineer. The sample sewn section shall be six feet (6') (2 m) by three feet (3') (1 m) with the seam in the center and parallel to the six feet (6') (2 m) length.

3.03 Installation

- A. The geotextile shall be laid smooth without wrinkles or folds on the prepared subgrade in the direction of construction traffic. Adjacent geotextile rolls shall be overlapped, sewn, or joined as required in the plans. Overlaps shall be in the direction as shown on the plans. See table below for overlap requirements.

Stabilization Fabric

Soil CBR	Method of Joining
Greater than 3	300 - 450 mm (12 - 18 in) overlap
1 - 3	600 - 1000 mm (24 - 40 in) overlap
0.5 - 1	1000 mm (40 in) overlap or sewn
Less than 0.5	Sewn
All roll ends	1000 mm (40 in) overlap or sewn

- B. On curves, the geotextile may be folded or cut to conform to the curves. The fold or overlap shall be in the direction of construction and held in place by pins, staples, or piles of fill or rock.
- C. Prior to covering, the geotextile shall be inspected by a certified inspector of the Engineer to ensure that the geotextile has not been damaged during installation. Damaged geotextiles, as identified by the Engineer, shall be repaired immediately. Cover the damaged area with a geotextile patch which extends an amount equal to the required overlap beyond the damaged area.
- D. The subbase shall be placed by end dumping onto the geotextile from the edge of the geotextile, or over previously placed subbase aggregate. On soils with $CBR > 3$, most rubber-tired vehicles can be driven at slow speeds, less than 10 mph (16 km/h) and in straight paths over the exposed geotextile without causing damage to the geotextile. Sudden braking and sharp turning should be avoided. Tracked construction equipment should not be operated directly upon the geotextile. A minimum fill soil thickness of 6 in (15cm) is required prior to operation of tracked vehicles over the geotextile. Turning of tracked vehicles should be kept to a minimum to prevent tracks from displacing the fill and damaging the geotextile. Turning of vehicles shall not be permitted on the first lift above the geotextile.
- E. On subgrades having a CBR value of less than 1, the subbase aggregate should be spread in its full thickness as soon as possible after dumping to minimize the potential of localized subgrade failure due to overloading of the subgrade.
- F. Any ruts occurring during construction shall be filled with additional subbase material, and compacted to the specified density.
- G. If placement of the backfill material causes damage to the geotextile, the damaged area shall be repaired as previously described above. The placement procedure shall then be modified to eliminate further damage from taking place.

END OF SECTION

SECTION 02710

BOUND AGGREGATE BASE COURSES

PART 1 – Description

- 1.01 This section describes the work and materials associated with various aggregates, and binders to produce the following bound aggregate base courses: Cement Stabilized Aggregate Base, Portland Cement Concrete Base (Plain), Asphaltic Concrete (General), and Soil Cement, in accordance with these Specifications and in conformity with the lines, grades, thickness, and typical cross-section shown on the Plans or as directed by the Owner.

PART 2 – Materials

2.01. Submittals

- A. Before any soil cement aggregate base course or cement stabilized aggregate base are applied the following submittals shall be submitted for review to the Engineer: a geotechnical report describing and classifying the soil, previously prepared soil cement mix designs covering durability tests such as wet-dry and freeze thaw report which are less than one year old and which specify a recommended cement content by volume for the type of soil. In general ranges of cement content by volume shall be applied to differing types of soil (classified as per AASHTO) as follows:

Soil Groups A-1, A-2-4, A-2-5, and A-3 not over 14 percent

Soil Groups A-2-6, A-2-7, A-4 and A-5, not over 10 percent

Soil Groups A-6 and A-7, not over 7 percent.

Compressive strengths should increase both with age and with increases in cement content within the ranges of cement content producing results that meet requirements of the freezer-thaw and the wet-dry test. The 14 days unconfined compressive strengths shall be used to determine the design cement content. The design cement content shall produce a minimum unconfined compressive strength of 300 psi within fourteen (14) days.

- B. Pavement and Base Design Criteria

To facilitate the structure design process, several standard combinations of pavement and base courses are provided below.

Projected Traffic ADT	Pavement Type and Thickness	Bituminous Surfacing Course over Binder Course over Cement Treated Course Thickness
Under 1000	Dbl Bituminous Surface Tr	1 ½ inches over 2 inches over 6 inches
1000 to 2000	Dbl Bituminous Surface Tr	1 ½ inches over 2 inches over 8 inches
2000 to 4000	Dbl Bituminous Surface Tr	1 ½ inches over 2 inches over 8 inches

2.02 Materials

A. Cement Stabilized Aggregate Base

1. Aggregate

- a. Aggregates for Graded Aggregate Base Course shall be crushed stone or crushed or uncrushed gravel together with such material as manufactured sand or other fine materials naturally contained or added thereto as needed to conform with one of the three gradations shown in the table below, as specified

Grading Table for Graded Aggregate Base Course
Total Percent, by Dry Weight, Passing Each Sieve (U.S. Standard)

Size No.	2 ½ “	2”	1 ½ “	1”	3/8”	No. 40	Clay*
1	100	95-100			35-65	10-30	1-12
2		100	95-100		40-65	10-30	1-12
3			100	90-100	45-65	10-35	2-12

* Clay content shall be determined by the Hydrometer Test – AASHTO T 88 4. Clay content may exceed 12 percent with the written permission of the Owner.

- b. Mineral aggregate for graded aggregate base course shall consist of hard durable particles or fragments of stone or gravel and other finely divided mineral matter. Individual materials shall meet the requirements specified hereinafter.
 - i. Crushed Stone - Crushed stone shall be free of silt and clay. The coarse aggregate portion of the stone shall have a percentage of wear of not more than 50, and when subjected to five (5) alternations of the sodium sulfate soundness test, the weighted percentage of loss shall not exceed fifteen (15).

- ii. Gravel - Gravel shall be screened and all oversize material may be crushed and fed uniformly back over the screen. The coarse aggregate portion (retained on the No. 4 sieve) shall have a percentage of wear of not more than 50, and when subjected to five (5) alternations of the sodium sulfate soundness test, the weighted percentage of loss shall not exceed fifteen (15). The portion of the material passing the No. 40 sieve shall be nonplastic or shall have a liquid limit of not more than thirty (30) and plasticity index of not more than eight (8).
- iii. If fine aggregate, coarse aggregate, or binder, in addition to that present in the base material, is needed in order to meet the gradation or density requirements or for satisfactory bonding of the material, it shall be uniformly blended with the base course material at the mixing plant by a mechanical feeder to maintain a uniform flow on the belt to the mixer. Blending of materials on the stockpiles or in the pits by bulldozer, clamshell, dragline, or similar equipment will not be permitted. The composite gradation of aggregate shall be the grading specified.

2. Portland Cement

- a. Portland Cement shall comply with the latest specifications for Portland Cement, AASHTO M 85 or AASHTO M 240 for the type specified.

3. Water

- a. Water shall be free of injurious quantities of oil, salt, acid, alkali, sugar, vegetable matter, or other substances detrimental to hardening of the treated base.

4. Bituminous Material

- a. Bituminous material for curing shall be Emulsified Asphalt Type SS-1, RS-2, or Cut-Back Asphalt, Grade RC-250.

B. Soil Cement Base

1. Soil.

- a. Soil for soil-cement base shall be of such general character as to be classified as Group A-1 or A-2, AASHTO M 145. The material shall be of such size that all will pass the standard two (2) inch sieve. Samples shall be tested by the Owner before work is started for determination of cement application rates and optimum moisture content.

2. Portland Cement.

- a. Portland Cement shall comply with the latest specifications for Portland Cement, AASHTO M 85 or AASHTO M 240 for the type specified.

3. Water.

- a. Water shall be free of injurious quantities of oil, salt, acid, alkali, sugar, vegetable matter, or other substances detrimental to hardening of the treated base.
- 4. Bituminous Material.
 - a. Bituminous material for curing shall be Emulsified Asphalt Type SS-1, RS-2, or Cut-Back Asphalt, Grade RC-250.
- 5. Hydraulic Cement
 - a. Hydraulic Cement shall comply with the latest specifications for Hydraulic Cement, ASTM C1157 for the type specified.
- C. Portland Cement Concrete Base (Plain)
 - 1. Concrete Material
 - a. Concrete materials shall meet the requirements of Specification Section 03050, Portland Cement Concrete, for Class B concrete.
 - 2. Curing Materials
 - a. Curing materials shall conform to the applicable provisions of Specification Section 02750 Paragraph 2.03.
 - 3. Chemical Additives
 - a. Chemical additives shall conform to the applicable provisions of Specification Section 02750 Paragraph
- D. Asphaltic Concrete (General)
 - 1. Aggregates, Filler, and Bituminous Material
 - a. Aggregates, filler if required, and bituminous material for the various types of hot mix asphaltic concrete will be stipulated in the applicable Section of these Specifications.
 - b. Each size and type of aggregate shall be stocked in a separate bin or stall in a manner that will prevent segregation. The mineral aggregate will be accepted for quality in the stockpile and for gradation immediately preceding addition of bituminous material. This acceptance will be based on periodic samples of the various sizes of aggregate taken as they are weighed from the bins, of the combined aggregate as it is fed to the pugmill, or of batches to which the bituminous material has not been added. The bituminous material may be conditionally accepted at the source.
 - c. The plant mixed material will be accepted after blending and mixing at the plant.

E. Asphaltic Concrete Base (Black Base)

1. Asphalt Cement

- a. Asphalt cement for this construction shall be penetration grade AC-20 or AC-10, or as directed by the Owner if these grades are not available. The proportion by weight of asphalt cement to the total mixture shall be between 3.5 percent and 5.5 percent as approved by the Owner.

2. Course Aggregate

- a. Course aggregate (aggregate retained on the No. 4 sieve) shall be crushed limestone conforming to the quality requirements of AASHTO M 62 or washed gravel, as approved by the Owner.

3. Fine Aggregate

- a. Fine aggregate shall consist of natural sand consisting of hard, clean, tough grains which will have a maximum weight loss of twelve (12) percent when subjected to the sodium sulfate soundness test.

4. Aggregate Gradation

- a. The aggregate gradation for black base shall conform to the following master range:

Sieve Size	Total % Passing by Weight
2"	100
1-1/2"	75-100
3/4"	45-70
3/8"	30-55
No. 4	20-40
No. 8	10-30
No. 30	5-20

F. Equipment.

- 1. All equipment necessary for the satisfactory performance of this construction shall be on the Project and approved before work will be permitted to begin.

PART 3- Execution

3.01 Construction Requirements For Cement Stabilized Aggregate Base

A. Limitations

- 1. No cement shall be applied when the aggregate base is frozen or contains frost. Before beginning construction operations for the day, the ambient temperature

shall be at least 40° F in the shade and rising. Application of cement, mixing, application of water and moist mixing, compaction, and finishing shall be continuous, and surface finishing shall be completed in daylight hours. Mixing, application of water and moist mixing, and compaction inclusively shall be completed within 6 hours.

B. Preparation

1. Before other construction operations are begun, the area to be paved shall be graded and shaped in accordance with Section 02335 of these Specifications in order to construct the base in conformance with grades, lines, thickness, and typical cross-section shown on the Plans. Unsuitable materials shall be removed and replaced with acceptable aggregate. Soft or yielding subgrade shall be corrected and made stable before construction proceeds.

C. Spreading

1. After subgrade preparation is complete, aggregate base material shall be spread over the moistened subgrade. The placement shall be uniform in thickness and surface contour and in such quantity that the completed base will conform to the required grade and cross-section. Aggregate shall be placed and initially compacted to specified thickness before proceeding with pulverization and application of cement.

D. Moisture Content

1. The optimum moisture content of the graded aggregate cement mixture shall be considered to be ten (10) percent unless otherwise determined by laboratory testing by the Owner. The maximum percentage of moisture in the aggregate at the time cement is added shall not exceed the specified optimum moisture content for the aggregate cement mixture. When water application and mixing have been completed, the percentage of moisture in the mixture based on oven dried weights shall not be more than one (1) percentage point below or more than three (3) percentage points above the specified optimum moisture content and shall be such that the mixture will not become unstable during compacting and finishing. During finishing operations, the moisture content of the surface material shall be maintained at not less than the specified optimum moisture content.

E. Application of Cement

1. Before application of the cement, the aggregate shall be pulverized as directed by the Owner. Approved Portland Cement shall then be applied uniformly on the base at the rate as specified below for the type of soil. The Owner reserves the right to increase the rate of cement application where in his judgment additional

cement is desired. When bulk cement is used, adequate equipment for handling, weighing, and spreading the cement shall be provided.

2. The percentage of moisture in the aggregate at the time of cement application shall not exceed the quantity that will permit a uniform mixture of aggregate and cement during mixing operations.

F. Mixing

1. After the cement has been applied it shall be mixed with the aggregate so that the base material shall be a homogeneous aggregate cement mixture. Water shall be added and mixing shall continue until the mixture is sufficiently blended to prevent the formation of cement balls when additional water is added. Aggregate cement mixture shall not remain undisturbed for more than thirty (30) minutes.

G. Application of Water and Moist Misting

1. Immediately after the initial mixing operation, required water shall be applied uniformly and incorporated into the mixture, and excessive concentration of water on or near the surface shall be avoided. A water supply shall be provided that will assure the application within three (3) hours of all water required. After all water has been applied, mixing shall continue until a uniform mixture of aggregate, cement, and water has been obtained.

H. Compaction

1. Prior to the beginning of compaction, the mixture shall be in a loose condition for sufficient depth to produce the specified finished thickness. Compaction will be obtained by use of a sheeps-foot roller which will be followed by rolling with pneumatic-tire rollers or other types of rollers as required to thoroughly compact the base for its full thickness. Shaping may be required to obtain uniform compaction. The aggregate cement mixture shall be compacted to ninety-five (95) percent of maximum density as determined by the applicable method of ASTM D698.

I. Finishing

1. After compaction is completed, the surface of the base shall be shaped to the lines, grades, and typical cross-sections shown on the Plans. During shaping operations, the surface shall be scarified as necessary to loosen any imprints left by the compacting or shaping equipment. The resulting surface shall then be compacted to the specified density with steel wheel or pneumatic tire rollers or both. Rolling may be supplemented by broom dragging if required.
2. Surface compaction and finishing shall be done in such a manner as to produce, within two (2) hours, a smooth, dense surface free of surface compaction planes,

cracks, ridges, or loose material. Any approved surface finishing method may be used provided the above final results are produced.

J. Curing

1. After finishing is completed, the aggregate cement shall be protected against drying for seven (7) days by the application of bituminous material as specified or allowed by the Owner. The bituminous material shall be applied as soon as possible, but no later than two (2) hours after finishing is completed. The finished aggregate cement shall be kept moist until the bituminous material is placed. The bituminous material shall be uniformly applied at the rate of approximately 0.2 gallons per square yard with approved heating and distributing equipment.
2. The exact rate and temperature will be specified by the Owner.
3. During application, the surface shall be dense, free of all loose and extraneous material, and shall contain sufficient moisture to prevent penetration of the bituminous material. If necessary, water shall be applied in sufficient quantity to fill any surface voids immediately before the bituminous material is applied.
4. The curing material shall be maintained by the Contractor during the seven (7) day protection period so that all of the aggregate cement will be covered effectively, and should it be necessary for construction equipment or any other traffic to use the bituminous covered surface before it has dried sufficiently to prevent pickup, sufficient granular cover shall be applied before such use as directed by the Owner. Finished portions of aggregate cement that are traveled on by equipment or other traffic for any reason shall be protected in such a manner as to prevent marring or damaging the completed work.
5. When the ambient temperature may be expected to reach the freezing point, sufficient protection from freezing shall be given the aggregate cement for seven (7) days after finishing is completed.

K. Construction Joints

1. At the end of each day's construction a straight transverse construction joint shall be formed by cutting back into the completed work to form a true vertical face free of loose or shattered material.
2. Aggregate cement for large, wide areas shall be built in a series of parallel lanes of convenient length and width meeting the approval of the Owner. Straight longitudinal joints shall be formed at the edge of each day's construction by cutting back into the completed work to form a true vertical face free of loose or shattered material.

L. Manhole Adjustments

1. Drainage and sanitary sewer manholes owned by the City shall be adjusted and set at final grade by the Contractor as necessary for compliance with the Plans. Adjustments of City owned manholes shall be as specified in Sections 02530 and 02632 of these specifications. Manholes, valve boxes, and other utility structures not owned by the City but within the right-of-way of the Project shall be adjusted as necessary by the owner of such facilities. The Contractor shall be responsible for notifying other owners of any required adjustments and for the accomplishment of that work by the owner of such facilities according to the project schedule.

M. Traffic and Maintenance

1. Completed portions of the base may be immediately opened to construction equipment or local traffic and to all traffic after the seven (7) day curing period, provided the base has hardened sufficiently to prevent damage and provided curing is not impaired.
2. The Contractor shall be required to maintain the base in good condition and in a manner satisfactory to the Owner from the time work first starts until all work has been completed and accepted. Maintenance shall include immediate repairs to any defects that may occur. This work shall be done by the Contractor at his own expense and repeated as often as may be necessary to keep the area continuously intact. This work shall include immediate repairs to any defects that may occur in a manner that will ensure restoration of a smooth, uniform surface and durability of the area repaired. Any faulty work shall be replaced to the full depth of the treatment, rather than adding a thin layer of material to the completed work.

3.02 Construction Requirements For Soil Cement Base

A. Limitations.

1. No soil-cement shall be processed that will not be covered with the succeeding stage of base or pavement during the same construction season. No cement shall be applied when the soil is frozen or contains frost. Before beginning construction operations for the day, the ambient temperature shall be at least 40° F in the shade and rising. All operations shall be continuous, and all operations but final surface finish shall be completed within four (4) hours from the time cement is applied. No uncompacted soil cement mixture shall be left undisturbed for more than thirty (30) minutes.

B. Preparation.

1. Before other operations are begun, the roadbed, including depth of soil for the soil-cement base, shall be graded and shaped in accordance with Section 02335 of these Specifications. After grading operations are complete and approved, any

work and material required to regrade the roadbed to finished grade shall be at the Contractor's expense. The area to receive treatment shall be thoroughly scarified and pulverized for sufficient depth and width to give, after treatment and compaction, the cross-sections shown on the Plans.

C. Moisture Content

1. The optimum moisture content should be established by soil tests or as designated by the Owner on the Plans. The maximum percentage of moisture in the soil at the time cement is added shall not exceed the specified moisture content of the soil-cement mixture by more than three (3) percentage points. When water application and mixing have been completed, the percentage of moisture in the mixture, based on oven dried weights, shall not be more than one (1) percentage point below or more than three (3) percentage points above the specified optimum moisture content and shall be such that the mixture will not become unstable during compacting and finishing. During finishing operations, the moisture content of the surface material shall be maintained at not less than the specified optimum moisture content.

D. Application of Portland or Hydraulic Cement.

1. Before application of the cement, the aggregate shall be pulverized as directed by the Owner. Approved Portland or Hydraulic Cement shall then be applied uniformly on the base at the rate as specified by previously approved mix submittals. The Owner reserves the right to increase the rate of cement application where in his judgment additional cement is desired. When bulk cement is used, adequate equipment for handling, weighing, and spreading the cement shall be provided.
2. Approved Portland Cement shall be applied uniformly on the in-place soil at the rate shown on the Plans or established by the Owner, based on tests of the soil performed before work is begun. The Owner reserves the right to increase the rate of cement where in his judgment additional cement is desired. When bulk cement is used, adequate equipment for handling, weighing, and spreading the cement shall be provided.

E. Mixing.

1. After the cement has been applied it shall be mixed with the soil so that the specified thickness of base shall be a homogeneous soil-cement mixture. Water shall be added and mixing shall continue until the mixture is sufficiently blended to prevent the formation of cement balls when additional water is added.

F. Application of Water And Moist Misting.

1. Immediately after the soil and cement have been mixed, water shall be applied uniformly and incorporated into the mixture. Excessive concentration of water on or near the surface shall be avoided. A water supply and pressure distributing equipment that will assure the application within three (3) hours of all water required. After all water has been applied, mixing shall continue until a uniform and intimate mixture of soil-cement and water has been obtained.

G. Compaction.

1. Prior to the beginning of compaction, the mixture shall be in a loose condition for a depth to produce the specified finished thickness. As a continuation of mixing operations, the loose mixture then shall be uniformly compacted to ninety-five (95) percent of maximum density as determined by ASTM D698 with two (2) hours. Initial compaction shall be obtained by use of a sheeps-foot roller of adequate weight to thoroughly compact the base for the full thickness. During compaction operations, shaping may be required to obtain uniform compaction and required grade and cross.

H. Finishing.

1. After the mixture has been compacted, the surface of the soil-cement shall be shaped, if necessary, to the required lines, grades, and cross-sections shown on the Plans. During shaping operations, the surface shall be lightly scarified as necessary to loosen any imprints left by the compacting or shaping equipment. The resulting surface shall then be compacted to the specified density with steel wheel or pneumatic tire rollers or both. Rolling shall be supplemented by broom dragging if required.
2. Surface compaction and finishing shall be done in such a manner as to produce, within two (2) hours, a smooth, dense surface free of surface compaction planes, cracks, ridges, or loose material. Any approved surface finishing method may be used provided the above final results are produced.

I. Curing.

1. After the soil-cement has been finished as specified herein, it shall be protected against drying for seven (7) days by the application of bituminous material as specified or allowed by the Owner. The bituminous material shall be applied as soon as possible, but no later than two (2) hours after finishing is completed. The finished soil-cement shall be kept continuously moist until the bituminous material is placed.
2. The bituminous material shall be uniformly applied at the rate of approximately 0.2 gallons per square yard with approved heating and distributing equipment. The exact rate and temperature of application to give complete coverage without excessive run-off will be specified by the Owner.

3. At the time the bituminous material is applied the soil-cement shall be dense, free of all loose and extraneous material, and shall contain sufficient moisture to prevent penetration of the bituminous material. Water shall be applied in sufficient quantity to fill any surface voids immediately before the bituminous material is applied.
4. The curing material shall be maintained by the Contractor during the seven (7) day protection period so that all of the soil-cement will be covered effectively.
5. Should it be necessary for construction equipment or any other traffic to use the bituminous covered surface before it has dried sufficiently to prevent pickup, sufficient granular cover shall be applied before such use as directed by the Owner. Finished portions of the soil-cement that are traveled on by equipment or other traffic for any reason shall be protected in such a manner as to prevent marring or damaging the completed work.
6. When the ambient temperature may be expected to reach the freezing point, sufficient protection from freezing shall be given the soil-cement for seven (7) days after finishing and until it has hardened.

J. Construction Joints.

1. At the end of each day's construction a straight transverse construction joint shall be formed by cutting back into the completed work to form a true vertical face free of loose or shattered material.
2. Soil-cement for large, wide areas shall be built in a series of parallel lanes of convenient lengths and width meeting the approval of the Owner. Straight longitudinal joints shall be formed at the edge of each day's construction by cutting back into the completed work to form a true vertical face free of loose or shattered material.

K. Manhole Adjustments.

1. Drainage and sanitary sewer manholes owned by the City shall be adjusted and set at final grade by the Contractor as necessary for compliance with the Plans. Adjustments of City owned manholes shall be as specified in Sections 02530 and 02632 of these specifications. Manholes, valve boxes, and other utility structures not owned by the City but within the right-of-way of the Project shall be adjusted as necessary by the owner of such facilities. The Contractor shall be responsible for notifying other owners of any required adjustments and for the accomplishment of that work by the owner of such facilities according to the project schedule.

L. Traffic And Maintenance.

1. Completed portions of the soil-cement may be opened immediately to construction equipment and local traffic, and to all traffic after the seven (7) day curing period, provided the soil-cement has hardened sufficiently to prevent marring or distorting of the surface by equipment or traffic and provided curing specified above is not impaired.
2. The Contractor shall be required to maintain the soil-cement in good condition and in a manner satisfactory to the Owner from the time work first starts until all work has been completed and accepted. Maintenance shall include immediate repairs of any defects that may occur. This work shall be done by the Contractor at his own expense and repeated as often as may be necessary to keep the area continuously intact. This work shall include immediate repairs to any defects that may occur in a manner that will ensure restoration of a smooth, uniform surface and durability of the area repaired. Any faulty work shall be replaced to the full depth of treatment, rather than adding a thin layer of material to the completed work.

3.03 Construction Requirements For Portland Cement Concrete Base (Plain)

A. Proportioning

1. The proportioning of materials for Portland cement concrete base shall be in accordance with the provision of Specification Section 03050 Portland Cement Concrete, for Class B concrete.

B. Mixing Limitations and Placing Concrete

1. Limitations of mixing of concrete due to weather shall be in accordance with limitations specified herein and in Section 03050.
2. The concrete shall be unloaded into an approved spreading device, or deposited on the subgrade or subbase, and spread in such manner as to prevent segregation of the materials. As deposited, the mixture shall be placed where it will require as little re-handling as possible.
3. Placing shall be continuous between transverse joints without the use of intermediate bulkheads. Necessary hand spreading shall be done with shovels or other approved tools. Workmen shall not be allowed to walk in the freshly mixed concrete with boots or shoes coated with earth or other foreign substances.
4. Where concrete is to be placed adjoining a previously constructed lane of pavement and mechanical equipment will be operated upon the existing lane of pavement, that lane shall meet the requirements for opening to traffic stipulated in Specifications elsewhere. If only finishing equipment is carried on the existing lane, paving in adjoining lanes may be permitted after 7 days.

5. Concrete shall be thoroughly consolidated against and along the faces of all forms and along the full length and on both sides of all joint assemblies, by means of vibrators inserted in the concrete. Vibrators shall not be permitted to come in contact with a joint assembly, the grade, or a side form. In no case shall the vibrator be operated longer than 5 seconds in any one location.
6. The use of hand operated vibrators will be permitted. Vibrators mounted on a machine shall be operated only while the machine is in motion.
7. Concrete shall be deposited as near to expansion and contraction joints as possible without disturbing them but shall not be dumped from the discharge bucket or hopper onto a joint assembly unless the hopper is well centered on the joint assembly.
8. Should any concrete materials fall on or be worked into the surface of a completed slab, they shall be removed immediately

C. Preparation and Construction Procedures

1. The subgrade shall be prepared in accordance with the provisions of Specification Section 02335.

D. Surface Finish And Tolerances

1. As soon as the concrete has hardened sufficiently, the pavement surface shall be tested with a 12 foot steel straightedge provided by the Contractor or other specified device. When the straightedge is placed parallel to the centerline of the pavement, the surface shall not vary more than 1/8 inch from the lower edge of the straightedge. Areas showing high spots of more than 1/8 inch, but not exceeding 1/2 inch in 12 feet, shall be marked and immediately ground down with an approved grinding tool to an elevation where the area will not show surface deviations in excess of 1/8 inch when tested with a 12 foot straightedge.
1. When a bituminous concrete surface is specified, the surface of the base shall be rolled prior to initial set with a roller having projections that will form grooves in the surface approximately one (1) inch wide and one-half (1/2) inch deep at intervals of approximately five (5) inches. These grooves shall form an angle of approximately 60° with the pavement centerline. A tamping device may be used which will produce the same general results.

E. Traffic And Maintenance

2. The Owner will determine when the concrete base has cured sufficiently for the application of bituminous concrete surface material or when local traffic or construction equipment will be allowed on the base.

F. Tolerance In Base Thickness

1. The owner will determine the thickness of the base by average measurements taken at the frequency he determines to be sufficient. When the finished base thickness is not deficient by more than one-quarter (1/4) inch from the Plan thickness, full payment will be made. When concrete base is determined to be deficient by more than one-quarter (1/4) inch, the Contractor shall remove and replace the deficient base at his expense.

G. Manhole Adjustments

1. Drainage and sanitary sewer manholes owned by the City shall be adjusted and set at final grade by the Contractor as necessary for compliance with the Plans. Adjustments of City owned manholes shall be as specified in Specification Sections 02530 and 02632 respectively. Manholes, valve boxes, and other utility structures not owned by the City but within the right-of-way of the project shall be adjusted as necessary by the owner of such facilities. The Contractor shall be responsible for notifying other owners of any required adjustments and for the accomplishment of that work by the owner of such facilities according to the project schedule.

3.04 Construction Requirements For Asphaltic Concrete Pavement (General)

A. Composition of Mixtures

1. The bituminous plant mix shall be composed of a job-mix formula of aggregate, filler if required, and bituminous material approved by the Owner. The several aggregate fractions shall be sized, uniformly graded, and combined in such proportions that the resulting mixture meets the grading requirements of the job-mix formula. The job-mix formula shall establish a single percentage of aggregate passing each required sieve size, a single percentage of bituminous material to be added to the aggregate, and a single temperature at which the mixture is to be discharged from the plant. All mixtures shall continually conform to the job-mix formula within tolerances established by Subsection 407.03 of the Tennessee Department of Transportation Standard Specifications for Road and Bridge Construction. When unsatisfactory results or other conditions make it necessary, the job-mix formula may be adjusted by the Owner.

B. Equipment

1. Bituminous Mixing Plants

- a. Bituminous mixing plants, regardless of type, shall conform to the current requirements of the Tennessee Department of Transportation Standard Specifications for Road and Bridge Construction, Subsection 407.04.

- b. At any time and without notice, the Owner shall have free access to any plant producing hot mix asphaltic concrete for the City of the purpose of checking equipment, materials, scales, or plant mixed material for compliance with these Specifications. He shall be furnished whatever assistance he requests in checking the plant, including the provision of testing equipment to check the mix and materials.

2. Trucks

- a. Trucks used for hauling bituminous mixtures shall have tight, clean, smooth metal beds.
- b. The beds shall have been coated with an approved material not harmful to the mixture to prevent adherence to the beds. Each truck shall have a canvas cover to protect the mixture from the weather, and when necessary to control temperature, truck beds shall be insulated and covers securely fastened.

3. Bituminous Pavers

- a. Bituminous pavers shall be self-contained units, provided with an activated screed or strike-off assembly equipped to be heated and capable of spreading and finishing courses of plant mix material in lane widths according to the typical sections and thicknesses shown on the Plans. Materials for shoulders and similar construction shall be placed by any mechanical spreading equipment approved by the Owner.
- b. Bituminous pavers shall be equipped with a receiving hopper of sufficient capacity to ensure a uniform spreading operation. The hopper shall be equipped with a distribution system which prevents “cold spots” and which will place the mixture uniformly in front of the screed. The screed or strike-off assembly shall effectively produce a finished surface of the required evenness and texture without tearing, shoving, or gouging the mixture. When laying mixtures, the paver shall be capable of forward speeds consistent with satisfactory laying of the mixtures.
- c. All asphalt paving machines shall be equipped with automatic grade and slope controls which shall be in good working order at all times. In the event of mechanical failure of any of the automatic controls, the Contractor will be permitted to complete only the current day’s work using manual controls.

4. Rollers

- a. Rollers shall be self-propelled and of the steel-wheel, pneumatic tire, and/or vibratory type. Rollers shall be in good condition, capable of reversing without backlash and shall be operated at speeds slow enough to avoid displacement of the bituminous mixture. All rollers shall be equipped with devices to moisten and clean the wheels as required.
- b. The steel wheel roller shall weigh a minimum of eight tons and may be a three-wheel or tandem type.
- c. The pneumatic tire roller shall meet the requirements of Specification Section 02335.
- d. The use of vibratory rollers will be permitted only after being specifically approved by the Owner.
- e. All required rollers shall be on the job, inspected, and approved before paving operations will be permitted to begin.

5. Platform Truck Scales

- a. Platform truck scales shall meet the requirements of Subsection 109.01 of the Tennessee Department of Transportation Standard Specifications for Road and Bridge Construction.

6. Small Tools

- a. The Contractor shall provide all necessary small tools and suitable means for keeping them clean and free from accumulations of bituminous materials.

C. Weather Limitations

- 1. Bituminous plant mix may be placed on properly constructed and accepted subgrade, base, previously applied layers of asphaltic concrete, or concrete pavement provided the following conditions are met:
 - a. The area to be paved is not in a frozen condition and is free from snow, ice, and excessive moisture.
 - b. Plant production and paving operations shall be so coordinated that a uniform continuity of operation is maintained.
 - c. The bituminous plant mix shall be placed in accordance with the following:

1. when the compacted thickness of the mix is less than 1-1/2 inch, the minimum air or surface temperature shall be 50°F
2. when the compacted thickness of the mix is 1-1/2 inch or more, the minimum air or surface temperature shall be 40° F.

D. Conditioning of the Existing Surface

1. When bituminous mixes are to be placed upon an existing concrete pavement, with or without a bituminous overlay, all loose or excess bituminous material shall be removed from joints and cracks. Sections of existing pavement that are broken and pumping under traffic shall be removed to subgrade as directed by the Owner. Unsatisfactory subgrade material encountered when existing pavement is removed shall also be removed as directed by the Owner. Materials removed from existing pavement, including base and subbase, and from subgrade shall be replaced with asphaltic concrete Mix No. 2, as specified in Specification Section 02741
2. B. When the bituminous mixture is to be placed upon an existing bituminous pavement, any areas having excess bitumen and any failures in the existing surface and base shall be removed to subgrade as directed by the Owner. Unsatisfactory subgrade material encountered when existing pavement is removed shall also be removed to subgrade as directed by the Owner. Materials removed from existing pavement, including base and subbase, and from subgrade shall be replaced with asphaltic concrete Mix No. 2, as specified in Specification Section 02741, to the level of existing pavement surface or as directed by the Owner. Payment for removal and replacement shall be made as defined for in Specification Section 02741.

E. Prime or Tack Coats

1. A prime coat shall be applied to Graded Aggregate Base Course, Cement-Stabilized Aggregate Base, and Soil-Cement Base uniformly at the rate of 0.25 gallons per square yard. Prime coat shall be grade MC-30. Bituminous material for tack coat shall be applied to concrete or asphaltic concrete bases or surfaces to provide bond for superimposed courses. Tack coat shall be emulsified asphalt, grade SS-1, applied at a uniform rate not to exceed 0.05 gallons of residual bitumen per square year.

F. Preparation of Bituminous Material

1. The bituminous material for hot mixes shall be heated to a temperature between 275° F and 325° F in a manner that will avoid local overheating and provide a continuous supply to the mixer at a uniform temperature at all times.

G. Preparation Of Aggregates

1. The aggregates for hot mixes shall be dried and heated to a uniform temperature between 225° F and 325° F. Flames used for drying and heating shall be properly adjusted to avoid damage to the aggregate and to avoid soot on the aggregate.
2. B. On all plants requiring screens, the hot dried aggregate shall be screened into two (2) or more fractions as specified. The separated fractions shall then be conveyed into separate compartments ready for batching and mixing with bituminous material.

H. Mixing

1. The dried aggregates shall be combined within the mixer in the amount of each fraction of aggregates required to meet the job-mix formula. The bituminous material shall be measured or gauged and introduced into the mixer in the amount specified by the job-mix formula.
2. After the required amounts of aggregate and bituminous material have been introduced into the mixer, the materials shall be mixed until a complete and uniform coating of the particles and a thorough distribution of the bituminous material throughout the aggregate is secured. Wet-mixing time shall be determined by the Owner for each plant and for each type of aggregate used, but in no case shall the wet-mixing time be less than twenty-five (25) seconds for batch type plants and forty (40) seconds for continuous mix plants.
3. For hot-mix bituminous pavement, the temperature of the completed mixture, determined at the time it is dumped from the mixer, shall be not less than 275° F, except that the temperature of mixtures made with aggregates containing absorbed moisture which causes foaming or boiling in the completed mixtures at these higher temperatures shall be not less than 225° F.
4. Hot-mix bituminous mixtures may be stored in surge or storage silos provided that the mixture as used from the silos meets all the specification requirements for the particular mix involved. When the use of surge or storage silos is permitted, the following additional requirements shall apply:
 - a. The surge and storage systems shall be of such design that there are no appreciable differences between material being discharged from the silo and material being discharged directly from the pugmill.
 - b. The surge and storage silos must be equipped with low and high mix level indicators. The low level indicator shall be placed at a location on the silo that has been predetermined to prevent segregation of the mix.

- c. The conveyor system used with the surge or storage silos shall be arranged in such a manner that samples of the mix or dry material may be conveniently taken from the pugmill.
- d. Storage silos shall be closed, insulated, and heated in such a manner that localized heating (hot spots) does not occur. The storage system shall be capable of sealing the bin to prevent oxidation of the mixture.
- e. Surge silos shall be equipped with a rain cover capable of preventing water from entering the mix in the silo.
- f. Approval of a surge or storage system will be dependent upon inspection and tests which indicate that the system is capable of conveying, retaining, and delivering the bituminous mixture within the tolerance ranges as set forth on the job, mix formula without segregation, and without balling or hardening.
- g. Approval of a surge or storage system may be withdrawn if tests and/or inspections indicate that the system is having a detrimental effect on the bituminous mixture.
- h. Any bituminous mix which, in the judgment of the Owner, is damaged in any way by the use of a surge or storage system will be rejected.
- i. Platform truck scales meeting the requirements of Specification Section 02710 shall be mounted under the loading hopper and shall be capable of recording tare and gross weight.
- j. The storage or surge bin shall be emptied when directed by the Owner in order to check material quantities.
- k. Hours of plant operation, whether for storage or direct shipment to the road, shall be limited to reasonable working hours in order that normal inspection of plant operations may be performed.
- l. Bituminous material in a surge silo must be removed on the same day in which it is placed.
- m. Samples of the stored material may be taken following the period of storage.
- n. Material stored will be subject to the temperature, segregation, and laying requirements as required for normal un-stored plant production.
- o. Excessive segregation, lumpiness, or stiffness of the mix shall be sufficient cause for rejection by the Owner.
- p. Surge and storage silos shall be located in a position that enables the top of the truck bed to be visible to the load operator during the loading operation.

I. Spreading and Finishing

1. Unless otherwise specified or permitted, bituminous mixtures shall be and spread on the roadway in ample time to secure thorough compaction during daylight hours. Its temperature at the time of depositing in the paver hopper shall be not more than 25° F less than the temperature at which it is discharged from the mixer. The mixture shall be laid upon an approved surface to which the appropriate tack coat or prime coat has been applied and spread and struck off to the established line, grade, and elevation by means of approved asphalt paving machines in echelon or by one (1) paver when echelon paving is not permitted. Echelon paving will not be permitted on two (2) lane projects where traffic is being maintained. Alignment of the outside edges of the pavement shall be controlled by preset control string lines. Where multicourse pavements are placed, the longitudinal joint in one (1) layer shall offset that in the layer immediately before by approximately one (1) foot; however, the joint in the top layer shall be at the centerline of the pavement if the roadway comprises two (2) lanes of width or at lane lines if the roadway is more than two (2) lanes in width.
2. Automatic screed controls utilizing either the string line or ski type grade reference systems will be required on all work regardless of the paver width. The string line reference system may be required on new construction. In the event the base has been finished with equipment having automatic grade controls or the Contractor demonstrates that an alternate method of spreading and finishing will result in a satisfactory riding surface, the Owner may conditionally waive the string line requirement and authorize use of the ski type reference system. In any event, the Owner may at any time require the use of a string line reference system even though it may have previously been waived, if in his opinion the use of the string line will result in a superior riding surface. Where the ski type system is used, the ski shall have the maximum practical length and in no case shall it be less than forty (40) feet in length. Pavement lanes previously placed with automatic controls or to form grade may serve as longitudinal control reference for laying adjacent lanes by utilizing a ski or joint matching shoe.
3. The string line reference system shall consist of suitable wire or twine supported by approved devices which will be compatible with the type of automatic paver control systems used. The string line and supports shall be capable of maintaining the line and grade designated by the Plans at the point of support while withstanding the tensioning necessary to prevent sag in excess of ¼ inch between supports spaced fifty (50) feet apart. Additional supports shall then be installed to provide a minimum spacing of twenty-five (25) feet, or less, as directed by the Owner and to remove and deviation of the string line from Plan grade.
4. The Owner will furnish sufficient control reference stakes to enable the Contractor to establish the string line reference system. The Contractor shall furnish all materials, equipment, labor, and incidentals required to construct the string line reference system as described herein and shall maintain same until its use is no longer required.

5. The string line reference system shall be complete in place at least 300 feet in advance of the point where the pavement is being place.
6. Automatic screed controls will not be required on sections of projects where service connections and other conditions interfere with their efficient operation.
7. The cost of erecting and maintaining the string line reference system shall be included in the unit price bid for other items of construction.
8. On areas where irregularities or unavoidable obstacles make the use of mechanical spreading and finishing equipment impracticable, the mixture shall be taken from the hopper of the spreading machine and shall be distributed immediately into place by means of suitable shovels and other tools and spread with rakes and lutes in a uniformly loose layer of such depth as will result in a completed course having the required thickness.

J. Compaction

1. After the bituminous mixture has been spread, struck off, and surface irregularities adjusted, it shall be thoroughly compacted. The method employed must be approved by the Owner and capable of compacting the mixture to the desired density while it is in a workable condition. When no density requirements are specified, a system of compaction for roadway pavements shall be employed which has previously produced required bituminous pavement densities. A control strip and random density samples may be employed to aid the Owner in evaluating the system.
2. In general, compaction shall be accomplished by the use of a combination of the equipment designated in Specification Section 02710. The following are minimum roller requirements; however, the number of rollers shall be increased if the required results are not being obtained.
 1. For each paver up to sixteen (16) feet wide, two (2) rollers shall be required.
 2. For each paver over sixteen (16) feet wide, three (3) rollers shall be required.
3. The minimum number of rollers listed above may, with the approval of the Owner, be reduced to one roller of either the steel-wheel or vibratory type on the following types of construction:
 1. on shoulder construction
 2. on incidental construction such as bridge approaches, driveways, etc.
 3. on projects containing less than 10,000 square yards of bituminous pavement

4. Unless otherwise directed, rolling shall begin at the low side and proceed longitudinally parallel to the road centerline. When paving in echelon or abutting a previously placed lane, the longitudinal joint shall be rolled first, followed by the regular rolling procedure. When paving in echelon, rollers shall not compact within six (6) inches of an edge where an adjacent lane is to be placed. Rollers shall move in a slow uniform speed with the drive wheels nearer the paver and shall be kept as nearly as possible in continuous operation. Rolling shall continue until all roller marks are eliminated.
5. To prevent adhesion of the mixture to the rollers, the wheels shall be kept properly moistened with water or water mixed with very small quantities of detergent or other approved material. An excess of liquid shall not be used.

K. Density Requirements

1. Asphaltic Concrete Surface Course, Mix No. 1 as specified in Specification Section 02741, shall be compacted to 93 percent of laboratory density as determined by the Marshall Method, 75 blow.
2. Asphaltic Concrete Binder Course (Leveling or Bushing), Mix No. 2 as specified in Specification Section 02741, shall be compacted to 90 percent of maximum theoretical density.
3. Asphaltic Concrete Base (Black Base), as specified in Specification Section 02710, shall be compacted to 90 percent of maximum theoretical density.
4. It is intended that acceptance density testing will be accomplished while the bituminous mixture is hot enough to permit further densification if such is shown to be necessary.
5. If the density does not conform to the requirement stated herein above, the Contractor shall continue his compactive effort until the required density is obtained.
6. Along forms, curbs, headers, walls and other places not accessible to the rollers, the mixture shall be compacted thoroughly with hot hand tampers, smoothing irons, or with mechanical tampers. On depressed areas, a trench roller or cleated compression strips may be used to compact the mix.
7. Any mixture that becomes loose or broken, mixed with dirt, or is in any way defective shall be repaired with rakes and the addition of fresh mix or shall be removed and replaced with fresh mix which shall be compacted to conform with the surrounding area. Any area showing an excess or deficiency of bituminous material shall be removed and replaced.

L. Density by Control Strips

1. When approved by the Owner, the required density may be determined by the control strip method. The target density obtained by the control strip method shall be used in lieu of theoretical or laboratory densities.
 - a. When this method is used, the density of all paving shall be at least 96 percent of the density obtained on the control strip. Construction of the control strip shall be as follows:
 - a. The base course or other pavement structure course upon which a control strip is constructed shall have been approved by the Owner prior to the construction of the control strip.
 - b. Equipment proposed for use in the compaction of control strips meet the requirements set forth in Specification Section 02710.
 - c. To determine the target density, a control strip shall be constructed at the beginning of work on the pavement course. New control strips shall be required when
 1. a change in the Job Mix Formula is necessary
 2. a change in the source of materials occurs
 3. a change in the material from the source is observed
 4. a change in the paving or rolling equipment occurs
 5. there is reason to believe that the control strip density is not representative of the bituminous mixture being placed
2. With the approval of the Owner, the Contractor may be permitted to construct additional control strips.
3. Each control strip shall be constructed with approved bituminous mixture and shall remain in place as a section of the completed work. Each control strip shall be one paver width wide and have an area of at least 400 square yards and shall be of the depth specified for the pavement structure course concerned.
4. Compaction of the control strip shall commence immediately after placement of the bituminous mixture and be continuous and uniform over the entire control strip.
5. The compaction of the control strip shall be continued until no appreciable increase in density (1.0 lbs/ft³) can be obtained by additional roller coverage.
6. During the rolling process, the density of the control strip will be determined by the Owner from randomly selected tests within the control strip.

M. Surface Requirements

1. The surface shall be tested with a twelve (12) foot steel straightedge, furnished by the Contractor, applied parallel to the centerline of the pavement. The deviation of the surface from the testing edge of the straightedge shall not exceed that specified for the respective types of bituminous construction as follows:
 - a. Surface Courses shall not deviate more than 1/4"
 - b. Base Courses shall not deviate more than 3/8"
2. The Contractor shall be required to repair all straightedge deviations as approved by the City Engineer.
3. The transverse slopes of tilted pavements shall be tested with a string line and string level applied at right angles to the centerline of the pavement and the percent of slope, when computed for the full width of the pavement, shall not deviate more than one-half (1/2) of one percentage point from that specified on the Plans.
4. The crown in crowned pavements shall be tested with a string line applied at right angles to the centerline of the pavement, and the crown shall not deviate more than one-half (1/2) inch from that specified on the Plans.
5. Deviations greater than the specified tolerances shall be corrected by methods best suited for the purpose. Pavement that cannot be corrected to comply with the specified tolerances shall be removed and replaced at the Contractor's expense.

N. Blotting Sand

1. When directed by the Owner in order to control tracking of excess bituminous material from curing of base materials or from application of prime coat, a protective cover of blotting sand shall be spread over the bituminous material at a rate specified by the Owner, but not to exceed ten (10) pounds per square yard. Application of blotting sand shall be considered incidental to the work and no separate payment will be made.

3.04 Construction Requirements For Asphaltic Concrete Base (Black Base)

A. General

1. The general construction requirements for black base shall be as prescribed in the applicable portions of Specification Section 02710.

B. Preparation of Subgrade or Surface

The surface upon which black base is to be placed shall meet the requirements of Specification Section 02335 or 02710, whichever is applicable. Black base shall be placed only upon a surface that is dry and cleaned of all loose particles.

C. Thickness and Surface Requirements

1. Thickness shall be controlled during the spreading operations by frequent measurements taken of the freshly spread mixture to establish a relationship between the uncompacted and compacted material. This thickness shall remain in conformity with that specified on the Plans. The surface of the base shall meet the requirements specified under Specification Section 02710 and when tested in accordance with the provisions of Specification Section 02710, the deviation of the surfaces from the testing edge of the straightedge shall not exceed 3/8 inch.

D. Manhole Adjustments

1. Drainage and sanitary sewer manholes owned by the City shall be adjusted and set at final grade by the Contractor as necessary for compliance with the Plans. Adjustments of City owned manholes shall be as specified in Specification Sections 02530 and other utility structures not owned by the City but within the right-of-way of the Project shall be adjusted as necessary by the owner of such facilities. The Contractor shall be responsible for notifying other owners of any required adjustments and for the accomplishment of that work by the owner of such facilities according to the project schedule.

E. Traffic And Maintenance

1. The Owner will determine when the base has sufficient compaction and has cured sufficiently to allow construction equipment, local traffic, and/or normal traffic on the base.

END OF SECTION

SECTION 02741

ASPHALTIC CONCRETE PAVEMENT

PART 1 – Description

This work shall consist of an asphaltic concrete pavement constructed in one or more layers for surface course(s) and binder course(s). The binder course may also be used as a leveling or bushing course. Binder course shall consist of a hot mixture of aggregate and asphalt prepared in a hot bituminous mixing plant. The binder course shall be constructed on a prepared subgrade, subbase, or base conforming to the lines, grades, thicknesses, and cross-sections shown on the Plans or as directed by the Engineer. The surface course shall consist of an asphaltic concrete pavement composed of a mixture of coarse aggregate, fine aggregate, mineral filler, and asphalt cement, constructed on a prepared roadbed in conformity with the lines, grades, thicknesses, and cross-sections shown on the Plans or directed by the Owner.

PART 2 – Materials And Equipment

2.01 MATERIALS

- A. Asphalt Cement. Asphalt cement shall conform to the requirements of ASSHTO M 226, Table 2, for the grade specified. Unless otherwise directed, asphalt shall be Viscosity Grade AC-20, PG64-22, or PG 64-28. The type and grade of bituminous material may be changed one step by the Engineer during construction, at now change in unit price.
- B. Course Aggregate. Course aggregate (aggregate retained on the No. 4 sieve) shall be crushed stone meeting the quality requirements of ASTM D 692 with the following exceptions:
 - 1. Crushed limestone shall have a sodium sulfate soundness loss not exceeding 9 percent.
 - 2. For Mix No. 1, material retained on the No. 4 sieve shall have a maximum of 20 percent elongated pieces (length greater than five times the average thicknesses).
 - 3. For Mix No. 2, the aggregate shall contain no more than 5 percent soft or nondurable particles.
 - 4. For Mix No. 3, the aggregate shall contain no more than 5 percent soft or nondurable particles.
- C. Fine Aggregate. The fine aggregate shall consist of natural sand consisting of hard, clean, tough grains which will have a maximum loss of 12 percent when subjected to the sodium sulfate soundness test.
- D. Composition of Mixtures

1. Asphaltic Concrete Surface, Mix No. 1, shall be laid in one course to the thickness shown on the Plans.
2. Asphaltic Concrete Binder, Mix No. 2, shall be laid in one or more courses to the thicknesses shown on the Plans. Mix No. 2 may also be used as a leveling course or bushing course.
3. Asphaltic Concrete Binder, Mix No. 3 shall be laid in one or more courses to the thickness shown on the plans.
4. The composition of the mixes shall be as follows:

Sieve Size	Total Percent Passing by Weight		
	Mix No. 1	Mix No. 2	Mix No. 3
2"	100	100	100
1-1/2"	100	100	90 - 100
3/4"	100	100	65 - 90
3/8"	76 - 96	65 - 95	-----
No. 4	51 - 76	45 - 70	30 - 55
No. 8	36 - 60	25 - 50	20 - 45
No. 30	16 - 40	12 - 30	8 - 25
No. 100	3 - 12	2 - 12	2 - 12
No. 200	2 - 8	1 - 6	1 - 6

5. The proportions of the total mixture, in percent by weight, shall be as follows:

Courses	Combined Mineral Asphalt	Aggregate Cement
Mix No. 1, Surface(Limestone)	92.0 - 96.0	4.0 - 8.0
Mix No. 2, Binder	93.0 - 97.5	2.5 - 7.0
Mix No. 3, Binder	93.0 - 97.5	2.5 - 7.0

6. It is the intent of this Section of the Specifications that the above described mixes shall conform to the following mixtures specified in the Tennessee Department of Transportation Standard Specifications for Road and Bridge construction.

Mix No. 1 - Section 411, Asphaltic Concrete Surface (Hot Mix), Aggregate Grading E.
 Mix No. 2 - Section 307, Bituminous Plant Mix Base (Hot Mix), Aggregate Grading C.

Mix No. 3 – Section 307, Bituminous Plant Mix Base (Hot Mix),
Aggregate Grading B.

7. For multiple layer construction, succeeding layers shall not be laid until the previous layer has cooled sufficiently to support the construction equipment
8. When Mix No. 1 is to be used as a surface for traffic lanes, the mineral aggregate shall be composed of not less than 50 percent nor more than 80 percent crushed limestone and not more than 50 percent nor less than 20 percent natural sand. When Mix No. 1 is used for surfacing of shoulders or other non-traffic lane construction, the mineral aggregate may be composed entirely of limestone, including screening and manufactured sand, but in no case shall the mineral aggregate for this construction consist of less than 50 percent limestone. The natural sand shall be so graded that not more than 5 percent will be retained on the No. 4 sieve.

2.02 EQUIPMENT

- A. All equipment necessary for the satisfactory performance of this construction shall be on the Project and approved of before work will be permitted to begin. The equipment shall meet the requirements of Specification Section 02710.

PART 3 – Execution

3.01 General

- A. The general construction requirements for surface and binder courses shall be as prescribed in the applicable portions of Specification Section 02710

3.02 Preparation of Base or Existing Surface

- A. The designated surface upon which asphalt concrete courses are to be placed shall meet the applicable requirements of Specification 02710 and be thoroughly cleaned of all dirt and other foreign or loose matter prior to the application of the Tack Coat or Prime Coat, as specified in TDOT Specification Sections 402 and 403.

3.03 Thickness And Surface Requirements

- A. Thickness shall be controlled during the spreading operations by frequent measurements taken of freshly spread mixture to establish a relationship between the un-compacted and compacted material. This thickness shall remain in conformity with that specified on the Plans. The surface of all courses shall meet the requirements specified under Specification Section 02710 and when tested in

accordance with the provisions of Specification Section 02710 the deviation of the surfaces from the testing edge of the straightedge shall not exceed 1/4 inch for Mix No. 1 or 3/8 inch for Mix No. 2 and Mix No. 3.

3.04 Manhole Adjustments

- A. Drainage and sanitary sewer manholes owned by the City shall be adjusted and set at final grade by the Contractor as necessary for compliance with the Plans. Adjustments of City owned manholes shall be as specified in Section 02530 or 02632 of these Specifications. Manholes, valve boxes, and other utility structures not owned by the City but within the right-of-way of the project shall be adjusted as necessary by the owner of such facilities. The Contractor shall be responsible for notifying other owners of any required adjustments and for the accomplishment of that work by the owner of such facilities according to the project schedule.

3.05 Traffic And Maintenance

- A. The Owner will determine when the surface course has sufficient compaction and has cured sufficiently to allow construction equipment, slow moving local traffic, or normal traffic to use the completed surface.

END OF SECTION

SECTION 03050

PORTLAND CEMENT CONCRETE

Part 1-Description.

The work covered in this section includes the classification, materials, proportioning of materials, equipment, mixing requirements, and testing for Portland Cement Concrete to be used for curbs, curb and gutter, and sidewalks, streets, bridges, and miscellaneous structures.

Part 2 - Materials

2.01. Classes of Portland Cement Concrete. Portland cement concrete used for construction of the various items specified elsewhere in these Specifications shall be classified by usage as follows:

A. Class A.

Class A concrete shall be used as specified for such items as directed by the Engineer and other uses as noted in the Special Provisions.

B. Class AS.

Class AS concrete shall be used for storm and sanitary structures, concrete curb, curb and gutter, valley gutters, sidewalks, ditch paving, and similar structures unless otherwise noted in the Special Provisions.

C. Class B.

Class B concrete shall be used for roadway base, soil cement, and pavement.

D. Class C.

Class C concrete shall be used as specified for such items as concrete cradles, encasements, embankment slope paving at bridge abutments, and other low strength applications.

E. Class P.

Class P concrete shall be used for cast-in-place box culverts and precast and precast-prestressed concrete structures or structural members. High-early-strength concrete shall be as specified in Specification Section 03050 Paragraph 6.05.

2.02 Materials.

A. Portland Cement.

1. Type I or Type I-SM cement shall be used unless otherwise specified. Different types of cement shall not be mixed. Portland Cement shall conform to all requirements of the "Standard Specifications for Portland Cement," AASHTO M 85. M. Specification C150

for Class Type I, except that for high early strength concrete, Type III cement may be used.

B. Fine Aggregate.

1. Fine aggregate for concrete shall consist of sand and shall conform to the following ASSHTO M6 with the following exceptions.

i. General Composition. Concrete sand shall be composed of clean (washed), hard, durable, uncoated grains, free from injurious amounts of clay, dust, soft flaky particles, loam, shale, alkali, organic matter, or other deleterious matter. Fine aggregate shall not contain appreciable materials which have unsatisfactory expansive properties when combined with Portland Cement and water.

ii. Sieve Analysis. Fine aggregate shall be graded within the following limits:

Sieve	% Passing by Weight	
	Min.	Max.
3/8" (9.5mm)	100	---
No. 4 (4.75mm)	95	100
No. 8 (2.36mm)	80	100
No. 16 (1.18mm)	50	90
No. 50 (330um)	5-30	
No. 100 (150um)	0	10
No. 200 (75um)	0	3

Deleterious Substances. The fine aggregate shall not contain more than the following maximum amounts of deleterious substances:

	Max. % of Weight
Clay lumps.	0.5
Coal, lignite, or shale.	0.5
Material passing the No. 200 Sieve.	3.0
Other deleterious substances such as Shale, alkali, mica, coated/grains soft and flaky particles.	3.0

If the fine aggregate is manufactured from limestone or dolomite and if the material finer than the No. 200 sieve consists of dust of fracture, essentially free from clay or shale, this limit may be increased from 3% to 5%

iv. Organic Impurities. Fine aggregate subjected to the colorimetric test as per ASTM C40 for organic impurities and producing a color darker than the standard shall be rejected unless it passes the mortar strength test as specified herein, Organic Impurities ASTM

C40.

C. Coarse Aggregate. Coarse aggregate for concrete shall consist of crushed stone or gravel or crushed or uncrushed gravel and shall conform to the following requirements:

1. Coarse aggregate for Class A, Class B, or Class C concrete shall be furnished in two sizes: Size No. 4 and Size No. 67 as shown hereinafter in the attached Table Coarse Aggregate Gradation Table.

2. The two sizes shall be manufactured, within the specified limits, to produce Size No. 467 when combined in the proper proportions at the batching plant. If the supplier provides a proper stockpile to prevent segregation, then a combined Size No. 467 can be used in lieu of blending Size No. 4 and Size No. 67.

3. Coarse aggregate for Class AS concrete shall be Size No. 57. Only limestone coarse aggregate will be used for Class AS concrete; gravel coarse aggregate will not be permitted.

4. Coarse aggregate for Class P concrete shall be size No. 57 or Size No. 67 as may be specified or directed. Only limestone coarse aggregate shall be used for Class P concrete; gravel coarse aggregate will not be permitted.

5. Coarse aggregate for concrete curbing placed by machine extrusion methods shall be Size No. 57 or Size No. 67.

6. The coarse aggregates shall otherwise conform to the requirements of AASHTO M 80 and ASTM C 33 with the following exceptions and stipulations:

a. Deleterious Substances. The coarse aggregate shall not contain more than the following maximum amounts of deleterious substances:

	<u>Max. % of Weight</u>
Clay lumps	0.25
Material passing No. 200 sieve	1.0
Coal or Lignite	1.0
Other deleterious substances such as	
friable, thin, elongated, or laminated pieces	10.00
Other Local deleterious substances	1.00
Soft or nondurable fragments (fragments which	
Are structurally weak such as shale, soft	
Sandstone, limonite concretions, gypsum,	
Weathered schist, or cemented gravel.	3.0

7. The sum of the above, excepting thin or elongated pieces, shall not exceed 5% by weight.

8. Soundness. When subjected to 5 cycles of the soundness test, as set forth in ASTM C88, the loss in weight of coarse aggregate weighted in accordance with the grading of a sample complying with the grading requirements specified, shall not exceed nine (9) percent for sodium sulfate.
9. Abrasion. The coarse aggregate shall not have an abrasive loss greater than 40% as determined by AASHTO T96.
10. In the case of crushed aggregate, if all the material finer than the 200 mesh sieve consists of the dust of fracture essentially free of clay or shale, Item 4, Maximum Per Cent by Weight, may be increased to 1.5.

COARSE AGGREGATE GRADATION TABLE
Amounts Finer than Each Lab. Sieve (Sq. Opening), %By Weight

SIZE NO.	2"	1-1/2"	1"	3/4"	1/2"	3/8"	NO. 4	NO. 8
4	100	90-100	20-55	0-15	-----	0-5	----	----
467	100	95-100	-----	35-70	-----	10-30	0-5	----
57	-----	100	95-100	----	25-60	----	0-10	0-5
67	----	----	100	90--100	----	20-55	0-10	0-5

- D. Water for Concrete. The water shall be clean and free from objectionable amounts of oil, acid, alkali, organic matter, or other deleterious materials and shall not be used until the source of supply has been approved. If at any time the water from an approved source becomes of unsatisfactory quality or insufficient quantity, the Contractor will be required to provide satisfactory water from another source. Water of questionable quality shall be subject to the acceptance criteria of Table I, as specified in ASHTO T26.
- E. Air-Entraining Admixture. The Contractor shall use a regular Portland Cement with the addition of an air-entraining admixture meeting requirements of AASHTO M 154. Air-entraining admixtures to be used in air-entrained concrete shall be Darex AEA, Neutralized Vinsol Resin, and Protex, or any other air-entraining agent meeting the approval of the Engineer. Air-entraining admixtures shall contain no chlorides. The air-entraining characteristics of the admixture, in suitable proportions in combination with Portland Cement, fine aggregate and water, within the limits of the proportion specified, shall be such that the resulting concrete will have a satisfactory workability, and the total air content shall be as provided below in the following table.

Nominal Max Size of Coarse Aggregate	Total Air Content Percentage by Volume Concrete
3/8 inch	6 to 10
1/2 inch	5 to 9
3/4 inch	4 to 8
1 inch	3 1/2 to 6 1/2
1 1/2 inch	3 to 6
2 inch	2 1/2 to 5 1/2
3inch	1 1/2 to 4 1/2

- F. Chemical Admixtures. Chemical admixtures shall conform to ASTM C494, except TYPE C accelerating admixtures shall contain no chlorides, shall be non-toxic after thirty (30) days, and shall be compatible with air-entraining admixtures. The amount of admixture added to the concrete shall be in accordance with the manufacturer's recommendations.
- G. Pozzolan Admixture. Pozzolan admixture shall conform to the requirements of ASTM C311 and ASTM C618-85 (including Table IA) for either Class C or Class F. Class C fly ash may be used as a replacement for Portland cement if approved in writing by the Owner. The maximum amount of cement being replaced by fly ash shall not exceed 15 percent. When a specific air content has been required and fly ash is being used, the air content shall be tested on each truck load of concrete at the batch plant and the tested value shall be indicated on the ticket.
- H. Fiber-Reinforced Concrete shall conform to ASTM C1116 material requirements and classifications. Concrete containing fibers (steel, glass fibers, or synthetic fibers) shall conform to the manufacturers addition rate and shall be included in the mix design approved by the Engineer. Glass Fiber and synthetic fiber reinforced concrete shall not be used to replace structural reinforcement, and shall be added at the batch plant.

PART 3 – Execution

3.01 Sampling and Testing and Storage of Materials.

- A. Cement. Cement may be accepted on the basis of mill tests and the manufacturer's certification of compliance with the specifications, provided the cement is the product of a mill with a record for production of high quality cement. Certificates of compliance shall be furnished the Engineer by the Contractor, for each lot of cement furnished prior to use of cement in the work. This requirement is applicable to cement for job- mixed, ready-mixed, or transit-mixed concrete. Cement proposed for use where no certificate of compliance is furnished, or where,

in the opinion of the Engineer, the cement furnished under certificate of compliance may have become damaged in transit or deteriorated because of age or improper storage, will be sampled at the mixing site and tested for conformance to the specifications.

1. Cement will be approved for use if it satisfactorily passes the fineness, soundness, and time of set test requirements specified, provided the general run of materials has been satisfactorily meeting the 28-day strength requirements. Any approved cement failing to pass the 28-day strength requirements, if unused, shall be rejected. If, in the judgement of the Engineer, it is considered necessary, other lots of shipments from the same mill may be held for the results of tests before being used.
 2. If cement is supplied from a new source or from a source of unknown quality, it may be held for the results of strength test before being approved.
- B. Fine and Coarse Aggregate. At least two (2) weeks in advance of the beginning of concrete work the Contractor shall submit to an approved materials testing laboratory approximately five hundred pound (500#) (225kg) samples of each concrete aggregate proposed for use unless otherwise waived by the Engineer in writing. All tests which are necessary to determine the compliance of the concrete materials with these specifications shall be performed on these samples. These samples shall also be used by the laboratory as the basis for a concrete mix design. The results of all tests and the concrete mix design shall be submitted to and approved by the City Engineer prior to the start of any concrete work. Standards shall conform to the latest applicable codes. The sampling and testing shall conform to the following standard procedures:
- C. Cement. The Contractor shall provide adequate protection for the cement against dampness. No cement shall be used that has become caked or lumpy. Accepted cement which has been held in storage more than 90 days after shipment from the mill shall be retested, and if failing to meet the requirements specified herein shall be rejected.
1. Accepted cement which has been stored in approved sealed bins at the mill for not more than six (6) months may be used without further testing unless a retest is specifically requested by the Engineer.
- D. Aggregate. Aggregates shall be handled and stored in separate piles at the site in such manner as to avoid a separation of the coarse and fine particles and contamination by foreign materials. Sites for stockpiles shall be prepared and maintained in such a manner as to prevent the mixing of deleterious materials with the aggregate. The Contractor shall deposit material in stockpiles at the batching plant site until the moisture content becomes uniform. Stockpiles shall be built in layers not to exceed three feet (3') (1m) in height, and each layer shall be completed before beginning the next one.

1. Coning or building up stockpiles by depositing the materials in one place will not be permitted. The storing of aggregates in stockpiles, or otherwise, upon the subgrade or shoulders will not be permitted.

3.02 Concrete Mixture Requirements.

- A. The concrete shall meet the following requirements as outlined in the Concrete Classification Table attached to the end of this Section.
 1. If it is found impossible to produce concrete having the required air content with the materials and mixing procedures that are being used, the Contractor shall make such changes in the materials or mixing procedures, or both, as may be necessary to insure full compliance with the requirements of air content in the concrete.
 2. The total weight of aggregates per sack of cement and the relative proportions of coarse and fine aggregate shall be determined by yield tests made during the progress of the work. The Engineer may, at his discretion, adjust the laboratory mix design to obtain the proper yield, and consistency of concrete.
 3. The Contractor shall receive written permission from the Engineer prior to adding Pozzolan admixture to Portland Cement Concrete.
 4. Any combination of aggregates which requires the use of more than six and one-half gallons (6.5g) (25l) of water per sack of cement to produce a workable mixture, with the brand of cement used will be considered as being unsatisfactory, and all such combinations of aggregate will be rejected.
 5. Concrete shall be uniformly plastic, cohesive, and workable. Workable concrete is defined as concrete which can be placed without honeycomb and without voids in the surface. Workability shall be obtained without producing a condition such that free water appears on the surface when finished. The consistency of the mixture shall be that required for the specified conditions and methods of placement; however, the previously determined maximum water cement ratio shall not be exceeded.

3.03 Proportioning of Materials.

All materials shall be separately and accurately measured by weight, and each batch shall be uniform. The coarse and fine aggregates shall be weighed separately. A sack of cement shall weigh ninety-four pounds (94#) (43kg). When bulk cement is used, ninety-four pounds (94#) (43kg) shall be considered as one sack. The Contractor shall furnish and use approved weighing devices, which, in operation, will give the exact quantity of materials required for the class of concrete. When the cement is in contact with the aggregate, it shall not remain more

than forty-five (45) minutes before being deposited into the mixer.

3.04 Measurement of Aggregate.

- A. Where sack cement is used, the quantities of aggregate for each batch shall be exactly sufficient for one or more sacks of cement. No batch requiring a fraction of a sack of cement will be permitted. All measurements shall be by weight, upon approved weighing scales and shall be such as will insure separate and uniform proportions. Scales shall be of either beam or springless dial types, and shall be suitable for supporting the hopper or hoppers. They shall be set accurately in substantial mountings which will insure a permanent spacing of the knife edges under all conditions of loading and use. They shall be so designed and maintained that they will at all times be accurate to within one-half (1/2) of one (1) percent throughout the entire weight range. Clearance shall be provided between the scale parts and the hopper or the bin structure to prevent displacement of the scale parts due to vibrations, accumulations, or any other cause. The value of the minimum gradations on any scale shall not be greater than five pounds (5#) (2.3kg). The weighing beam or dial shall be so placed that it will be in full view of the operator during the operation of the gate which delivers the material to the hopper. Scales shall be protected from air currents that may affect the accuracy of weighing.
- B. Separate hoppers shall be provided for weighing fine and coarse aggregate. They shall be of suitable size and tight enough to hold the aggregate without leakage, and shall be supported entirely upon the scales. Suitable provisions shall be made for removal of overload from the hopper by the operator while he operates the bin gates.
- C. The Contractor shall provide a sufficient number of fifty-pound (50#) (23kg) standard test weights for calibrating the weighing equipment.
- D. The volume of concrete mixed per batch shall not exceed the manufacturer's guaranteed capacity of the mixer.
- E. When the aggregates are delivered to the mixer in trucks, each batch shall be in a separate compartment of the capacity required by the Engineer. Suitable covers shall be provided for the batch compartments of the trucks to protect the cement from the wind. All trucks, truck bodies, bulkheads, and compartments used in proportioning and transporting to the mixer of concrete materials shall be so designed and operated to insure the charging of the mixer, batch by batch, with the proper amounts of each material without overspillage, intermixing of batches or wastage. Any units which, in the opinion of the Engineer, do not operate satisfactorily, shall be removed from the work until properly rebuilt and corrected.

3.05 Mixing Concrete.

- A. Consistency. The quantity of water to be used shall be determined by the Engineer and shall not be varied without his consent. The Contractor shall furnish and use with the mixer an

approved adjustable, water measuring device which will prevent excess water flowing into the mixer, in order that the consistency may be under positive control and that all batches may be of the same consistency.

1. In general, the minimum amount of water shall be used which will produce the required workability. The mortar shall cling to the coarse aggregate and shall show no free water when removed from the mixer.
- B. Mixer. The mixing machine used shall be of an approved type known as a batch mixer, and of a design having a suitable device attached for automatically measuring the proper amount of water accurate to one percent (1%) and for automatically timing each batch of concrete so that all materials will be mixed together for the minimum time required. Such device shall be easily regulated and controlled to meet the variable conditions encountered. If the time device becomes broken or fails to operate, the Contractor will be permitted to continue the balance of the day without the timing device while the same is being repaired, provided that each batch of concrete is mixed two (2) minutes.
1. The normal mixing time for each batch shall be one (1) minute, and the measuring of this period shall begin after all the materials are in the drum. During this mixing period, the drum shall revolve at the speed for which the mixer is designed, but shall make not less than fourteen (14) nor more than twenty (20) revolutions per minute.
 2. No materials for a batch of concrete shall be placed in the drum of the mixer until all of the previous batch has been discharged therefrom. The discharge of water into the drum shall commence with the flow of the aggregates, but shall not be started before the entrance into the drum of part of the aggregates. The discharge of all of the mixing water for any batch shall be completed within ten (10) seconds after all of the aggregates are in the drum. The inside of the drum shall be kept free from hardened concrete.
 3. The use of mixers having a chute delivery will not be permitted except by permission of the Engineer. In all such cases the arrangement of chutes, baffle plates, etc., shall be such as will insure the placing of fresh concrete without segregation.
 4. Ready-mixed concrete from a central mixing plant delivered at the work ready for use, will be permitted, provided the mixture is transported to the job site in an agitating truck having the concrete contained in a revolving drum and provided there is no segregation of the mixture at the point of placing. Ready-mixed concrete from a central batching plant and mixed in transit will be permitted; however, the mixing and transporting equipment will be subject to the special approval of the Engineer. Any ready-mixed concrete shall comply with all of the requirements of these specifications.
 5. The time elapsing from the time the water is added to the mix until the concrete is deposited in place at the site of the Work shall not exceed 30 minutes when hauled in non-agitating

trucks, not 60 minutes when hauled in truck mixers or truck agitators. In addition, the total revolutions at mixing speed shall not be less than 70 nor more than 100. When truck mixers are used on hauls in excess of 1 hour, the cement shall be added at the site of the work. The concrete must be of workable consistency when placed. No mixer which has a capacity of less than a two-sack batch shall be used.

- i. Hand mixing will not be permitted except with the permission of the Engineer and then only in very small quantities or in case of an emergency.
6. Retempering concrete by adding water or by other means will not be permitted; however, a portion of the mixing water may be withheld from transit mixers and added at the work site provided the delivery ticket indicates the amount withheld. The batch shall be mixed for 30 revolutions at mixing speed after adding the water. Water cannot be added to a partial load of concrete mix. Concrete that is not within the specified slump limits at time of placement shall not be used.
7. In using air-entraining admixtures, the mixer shall be equipped with a suitable automatic dispensing device which will proportion the air entraining admixture accurately to each batch of concrete. The device shall be calibrated and adjusted to deliver to each batch of concrete the quantity of admixture required to produce the specified air content in the concrete.
8. The manufacturer of the concrete shall furnish to the purchaser with each batch of concrete before unloading at the site, a delivery ticket. The purchaser shall provide the Engineer with one (1) copy of each delivery ticket.

3.06 Forms.

- A. Forms shall be made of wood or metal. Forms shall be provided with adequate devices for secure setting so that when in place they will withstand, without visible spring or settlement, the impact and vibration of the consolidating and finishing equipment. The top and face of forms shall be cleaned and oiled prior to the placing of concrete.

3.07 Placing Concrete.

- A. The concrete shall be unloaded into an approved spreading device, or deposited on the base, and spread in such a manner as to prevent segregation of the materials. As deposited, the mixture shall be placed where it will require as little rehandling as possible. No concrete shall be placed on frozen grade.
- B. Necessary hand spreading shall be done with shovels or other approved tools. Workmen shall not be allowed to walk in the freshly mixed concrete with boots or shoes coated in earthen or

other foreign substances.

- C. Concrete shall be thoroughly consolidated against and along the faces of all forms and along the full length and on both sides of all joint assemblies, by means of vibrators inserted in the concrete. Vibrators shall not be permitted to come in contact with a joint assembly, the grade, or a side form. In no case shall the vibrator be operated longer than 5 seconds in any one location.

3.08 Protection.

- A. It shall be the responsibility of the Contractor to protect from damage all freshly poured concrete regardless of the location or type of structure for a minimum period of seven (7) days or for such longer period as the Engineer may direct. Any concrete which is damaged shall be repaired to the satisfaction of the Engineer prior to acceptance of the completed work.

3.09 Quality Control Testing.

- A. The Owner or Consultant will employ a testing laboratory to perform test and submit test reports. Test reports will be reported in writing to Consultant, Owner, and Contractor as soon as possible upon completion of tests.

- 1. Compressive Strength Tests. Concrete test cylinders will be made by a qualified technician from a certified material testing laboratory.

- 2. The cylinders shall be made and tested in accordance with ASTM C39.

- 2. Tests may be required for each day's run or according to the following schedule:

<u>Total Cubic Yards of Concrete Placed (m³)</u>	<u>Minimum Number of Tests* (3 cylinders each)</u>
0 – 100(0-75)	One for 7 days, two at 28 days
100 – 1000 (75 -750)	One for each 50 cu. Yds. (38m ³)
1000 – 2000 (750 – 1500)	One for each 125 cu. Yds. (100m ³)
2000 and Over (1500)	One for each 175 cu. Yds. (125 m ³) One for each 250 cu. Yds. (200 m ³)

*One test per pour minimum.

- iii. Results of all tests shall be furnished to the Engineer as soon as they are available.

- 2. Slump. Slump test shall be conducted in accordance with ASTM C172. A test shall be performed for each day's pour of each type of concrete and for each set of compressive strength test.

2. Air Content. Air content shall be tested in accordance with ASTM C143 or ASTM C231. Air content test shall be performed for each set of compressive strength tests of each type of air-entrained concrete.

CONCRETE CLASSIFICATION TABLE

Class of Concrete	Min. 28 day Compressive Strength (psi)	Slump in Inches	Min Cement–Sacks//CY (3)		Min Cement–#/CY (3)		Net Water Max. Gal/CY (3)		Net Water Max-#/CY (3)	
			Gravel Course Aggregate	Limestone Course Aggregate	Gravel Course Aggregate	Limestone Course Aggregate	Gravel Course Aggregate	Limestone Course Aggregate	Gravel Course Aggregate	Limestone Course Aggregate
A	3000	3-5	6.0	5.5	564	517	36	33	300	275
AS	4000	3-5	(2)	6.2	(2)	583	(2)	37.2	(2)	310
B	3500(1)	1-2.5	6.2	5.8	583	545	34.1	31.9	284	266
C	2500	2-4	5.0	4.5	470	423	34	30.6	283	255
P	5000	1-3	(2)	7.0	(2)	658	(2)	35	(2)	292

Notes:

- (1) Minimum compressive strength at 14 days. Minimum flexural strength at 14 days of 550 psi per AASHTO T 22
- (2) Gravel Coarse Aggregate not permitted.
- (3) Tabulated values are for Type I cement conforming to the requirement of AASHTO M 85 only.

END OF SECTION

Appendix A

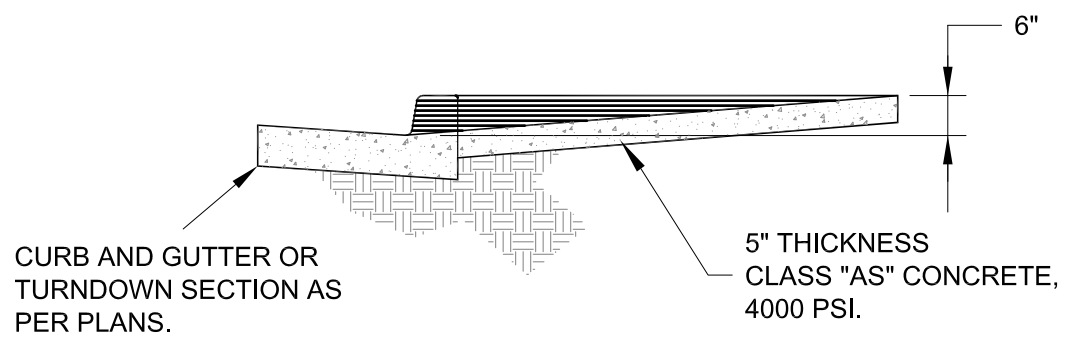
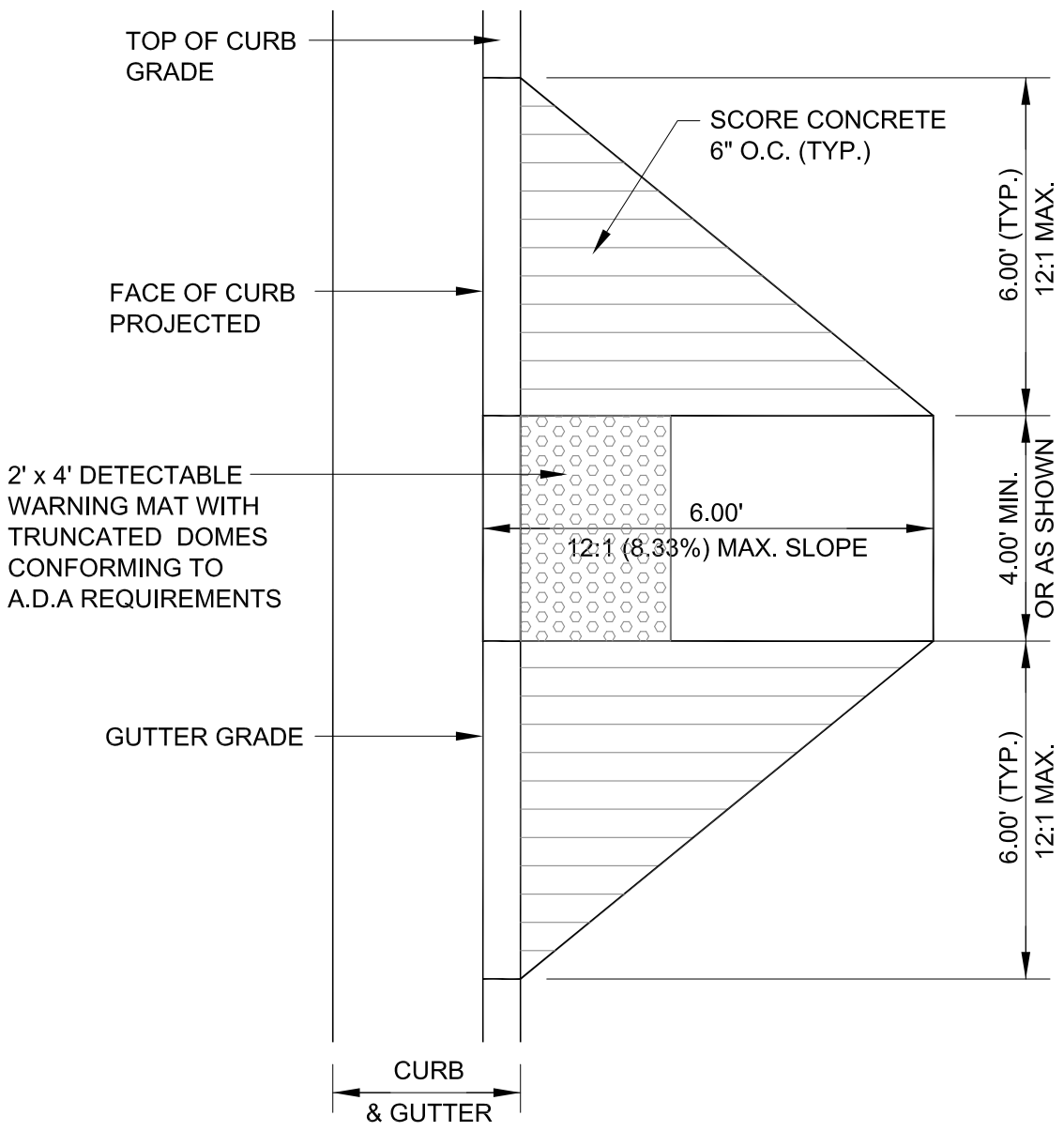

STANDARD ACCESSIBILITY RAMP DETAIL
 NOT TO SCALE

<i>CITY OF LAKELAND ENGINEERING DIVISION</i>		
STD. ACCESSIBILITY RAMP DETAIL		
REV.	DESCRIPTION	DATE
1	ORIGINAL ISSUE	8/2008

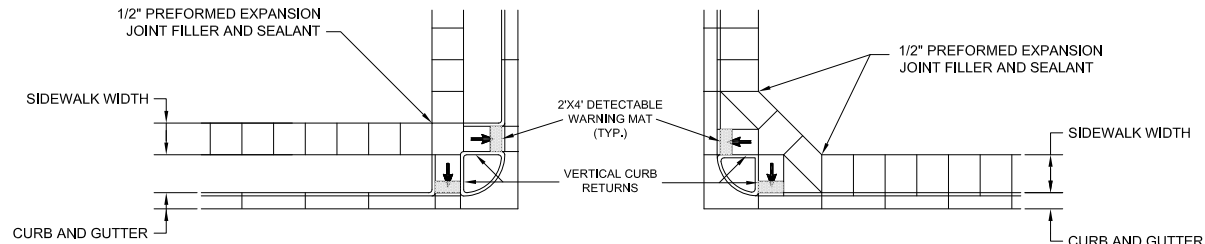

DETACHED SIDEWALK - BACK TO BACK RAMP

DIAGONAL CORNER- BACK TO BACK RAMP

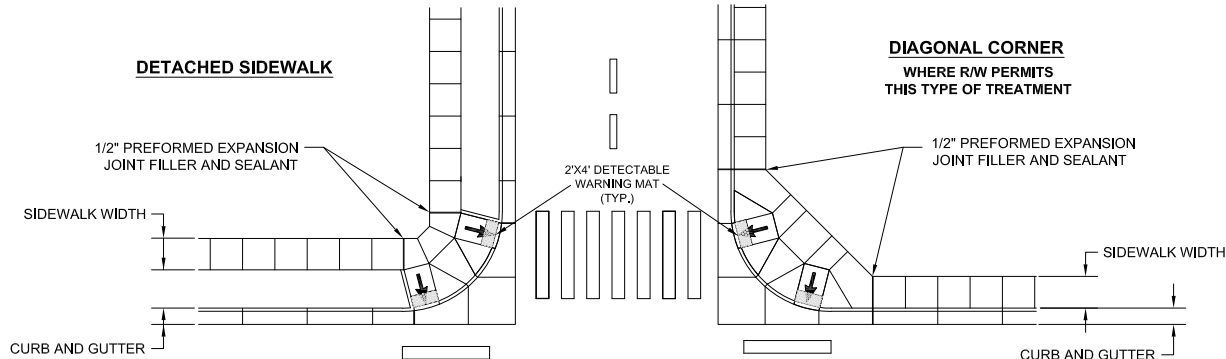

DETACHED SIDEWALK

**DIAGONAL CORNER
WHERE R/W PERMITS
THIS TYPE OF TREATMENT**

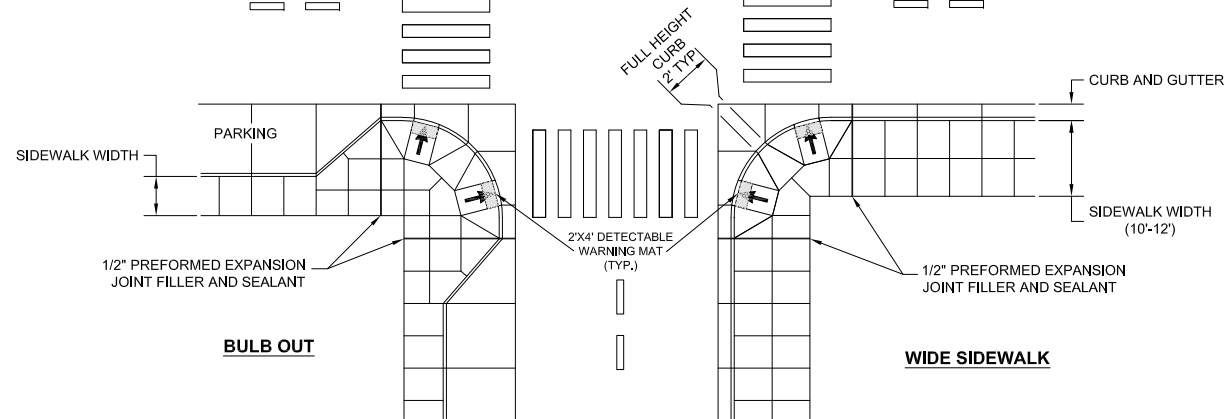

BULB OUT

WIDE SIDEWALK

TYPICAL CURB RAMP TYPE I TREATMENTS

GENERAL SIDEWALK REQUIREMENTS FOR ADA ACCESSIBILITY

NOT TO SCALE

GENERAL SIDEWALK AND ADA REQUIREMENTS

SIDEWALKS SHALL BE CONSTRUCTED TO PROVIDE ACCESSIBILITY CONSISTENT WITH THESE SPECIFICATIONS AND ADA STANDARDS UNLESS OTHERWISE SHOWN IN THE PLANS OR DIRECTED BY THE ENGINEER.

MINIMUM SIDEWALK WIDTH SHALL BE 5 FEET. THE MINIMUM WIDTH FOR AN ACCESSIBILITY ROUTE IS 36".

THE CROSS-SLOPE ON SIDEWALKS AND CURB RAMP SHALL NOT EXCEED 1:48. ALL SIDEWALKS SHALL BE SLOPED 1:48 TOWARDS THE CURB AND GUTTER UNLESS OTHERWISE INDICATED TO PROVIDE POSITIVE DRAINAGE. SIDEWALKS SHALL PROVIDE A MINIMUM OF 36" CLEAR PASSAGE AROUND DRIVEWAYS AND OTHER FEATURES TO PREVENT EXCEEDING THE MAXIMUM CROSS-SLOPE.

CURB RAMP SHALL BE PROVIDED AT STREET INTERSECTIONS AND ELSEWHERE AS SHOWN ON THE PLANS. RAMP SHALL ALSO BE PROVIDED AT ANY OTHER LOCATION WHERE A CROSSWALK OR WHEELCHAIR ACCESS IS NEEDED AS DETERMINED BY THE ENGINEER.

CURB RAMP SHALL BE MEASURED AND PAID FOR AS CONCRETE SIDEWALK AND WILL INCLUDE CURB RETURNS AND INTERIOR CURBS. THE AREA OF THE CURB RAMP THAT FALLS ON THE STREET SIDE OF THE BACK OF CURB LINE WILL BE MEASURED AND PAID FOR AS CURB AND GUTTER OR AS DETERMINED BY THE ENGINEER.

STREET DRAINAGE STRUCTURES SHALL NOT BE PLACED IN LINE WITH CURB RAMP NOR IN THE PATH OF PEDESTRIANS. GRATINGS AND ACCESS COVERS SHALL NOT BE PLACED IN SIDEWALK CURB RAMP.

SIDEWALKS AND CURB AND GUTTER SHALL BE CONSTRUCTED WITH 1/2" PREFORMED EXPANSION JOINT FILLER AT RADIUS POINTS, JUNCTIONS WITH EXISTING CONCRETE, INTERSECTIONS OF CONCRETE SIDEWALK RUNS, AT THE JUNCTURE OF CURB AND GUTTER AND SIDEWALK WHEN THE STREET PAVEMENT IS CONCRETE, AROUND INLETS, AROUND MANHOLES, AROUND OTHER STRUCTURES AND AT INTERVALS. PREFORMED EXPANSION JOINTS SHALL BE SEALED WITH AN APPROVED SILICONE JOINT SEALANT.

CURB RAMP SHALL BE TYPE I OR TYPE I MODIFIED UNLESS OTHERWISE SHOWN IN PLANS.

4" THICKNESS CLASS "AS" CONCRETE, 4000 PSI.

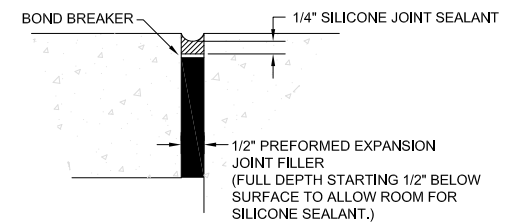

CITY OF LAKELAND ENGINEERING DIVISION		
GENERAL SIDEWALK REQUIREMENTS FOR ADA ACCESSIBILITY		
REV.	DESCRIPTION	DATE
1	ORIGINAL ISSUE	8/2008

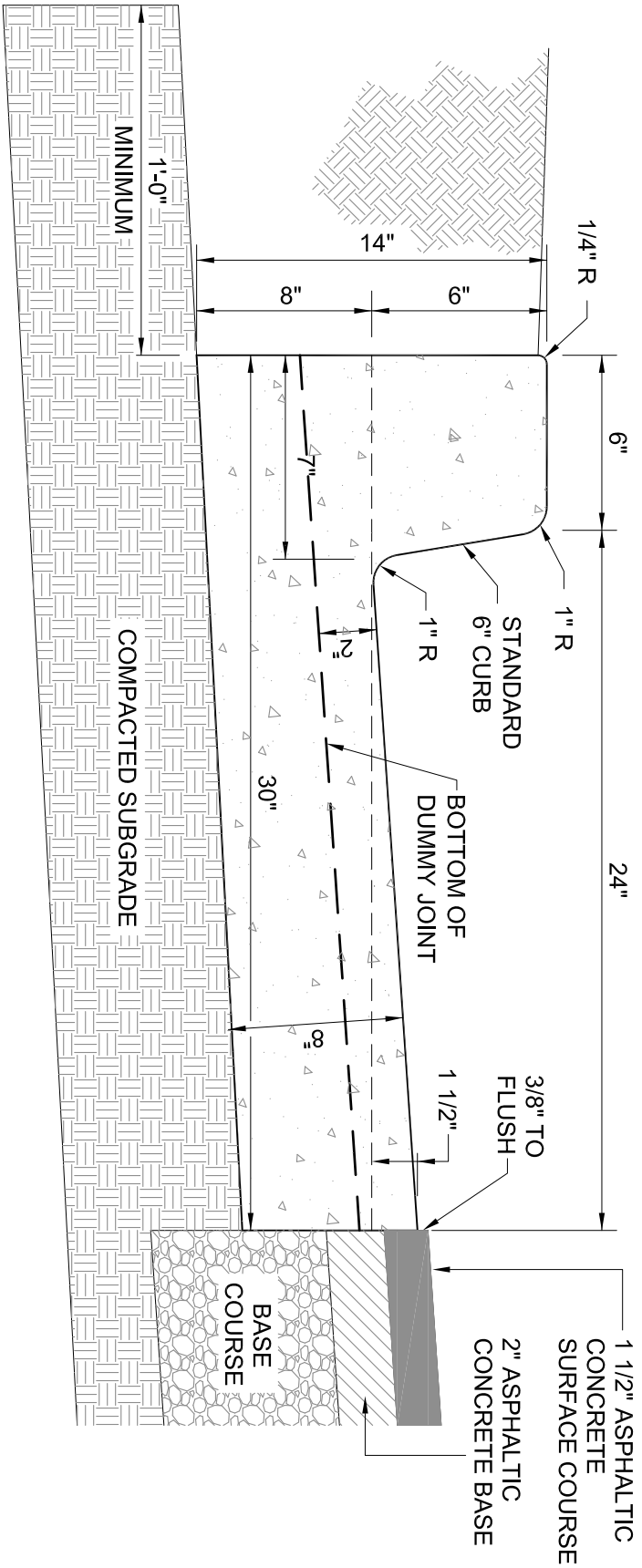

CONSTRUCTION NOTES:

1. PRECUT EXPANSION JOINT MATERIAL WILL BE USED IN ALL EXPANSION JOINTS.
2. DUMMY JOINTS WILL BE INSTALLED AT 10' MAXIMUM INTERVALS.
3. EXPANSION JOINTS WILL BE INSTALLED AT 40' O.C. MAX.
4. EXPANSION JOINTS WILL BE INSTALLED AT ENDS OF RADII.
5. EXPANSION JOINTS WILL BE LOCATED ADJACENT TO INLET STRUCTURES.
6. CONCRETE WILL BE CLASS "AS" CONCRETE, 4000 PSI.
7. SEE DETAIL FOR EXPANSION JOINTS.

6-30 CURB AND GUTTER

NOT TO SCALE

*CITY OF LAKELAND
ENGINEERING DIVISION*

6-30 CURB AND GUTTER

REV.	DESCRIPTION	DATE
1	ORIGINAL ISSUE	8/2008

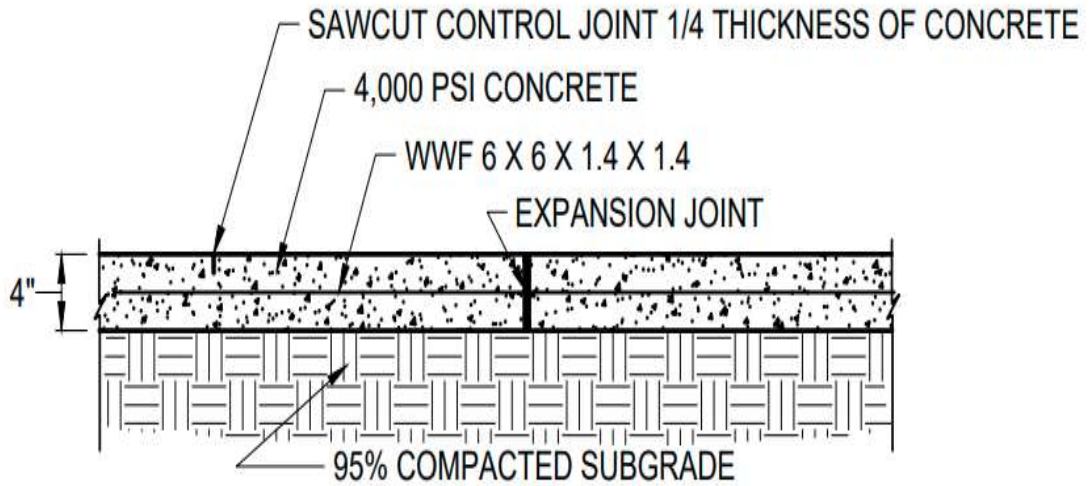

SECTION VIEW

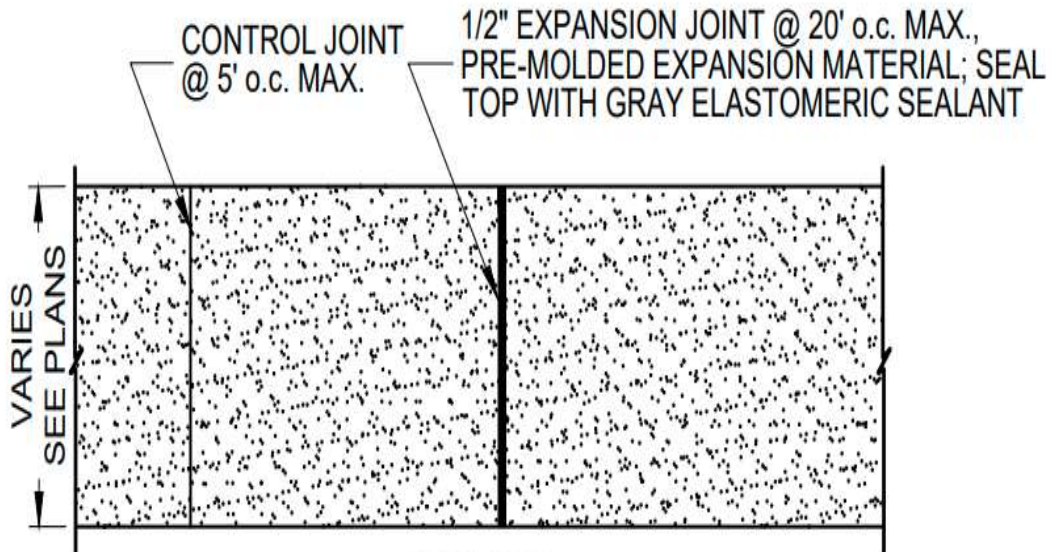

PLAN VIEW

NOTE:

BROOM FINISH PERPENDICULAR TO DIRECTION OF TRAVEL.

NOT TO SCALE

<i>CITY OF LAKELAND ENGINEERING DIVISION</i>		
CONCRETE SIDEWALK		
REV.	DESCRIPTION	DATE
1	ORIGINAL ISSUE	/200.