

BIDDING DOCUMENTS

PREPARED FOR

**EFFINGHAM COUNTY BOARD OF
COMMISSIONERS**

For

**HONEY RIDGE ROAD BRIDGE
REPLACEMENT**



PURCHASING BID NO. 19-25-002

October 2018

Effingham County Board of Commissioners
Honey Ridge Road Bridge Replacement
ITB No. 19-25-002

TABLE OF CONTENTS

<u>SECTION</u>	<u>DESCRIPTION</u>	<u>PAGES</u>
01100	Notice to Contractors	1 – 2
01150	Instructions for Bidders	1 – 13
01160	General Conditions	1 - 8
01200	Supplemental Conditions	1 – 8
01210	Scope of Work	1 – 3
01250	Bid Form	1 – 6
01300	Bid Bond	1 - 1
01350	Agreement	1 - 7
01400	Notice to Proceed	1 - 1
SP 150	Traffic Control	1 - 60

NOTICE TO CONTRACTORS

EFFINGHAM COUNTY BOARD OF COMMISSIONERS

Sealed BIDS will be received by the **Effingham County Board of Commissioners** at the office of the **Purchasing Agent** until **11.00am** (Eastern Time) on **Tuesday December 4, 2018** and then at said office publicly opened and read aloud.

The Work to be bid consists of furnishing all materials, labor and equipment for the Construction of:

HONEY RIDGE ROAD BRIDGE REPLACEMENT

The purpose of this project is to **remove the existing concrete bridge and replace it with a GDOT Standard Triple 10' X 5' cast in place box culvert 38' in length, parapet to parapet; install guardrail; and remove and replace asphalt paving.**

A MANDATORY PRE-PROPOSAL CONFERENCE has been scheduled for **11.00am** (Eastern Time) on **Monday November 5, 2018** and will be conducted at the EFFINGHAM COUNTY ADMINISTRATIVE COMPLEX, 601 N. LAUREL STREET, SPRINGFIELD, GEORGIA, 31329, to discuss the specifications and resolve any questions and/or misunderstanding that may arise.

Proposals will not be accepted from any firm that is not represented at the Mandatory Pre-Proposal Conference.

Any questions that arise after the pre-proposal conference **must** be made in writing and must be received at the office of the Purchasing Agent no later than **1.00pm** (Eastern Time) on **Thursday November 8, 2018** No response will be given to any questions received after **1.00pm** (Eastern Time) on **Thursday November 8, 2018** Questions may be faxed to 912-754-8413; emailed to fcharleton@effinghamcounty.org or mailed to the address above. If questions are mailed, please DO NOT put the bid number on the outside of the envelope.

The response to all questions will be in the form of an addendum and will be posted on the Effingham County website www.effinghamcounty.org before **5.00pm** (Eastern Time) on **Thursday November 29, 2018**.

All proposals shall be accompanied by a BID BOND in favor of the Effingham County Board of Commissioners in the amount of at least five percent (5%) of the BID for the complete work. The BID BOND shall be forfeited to the **Effingham County Board of Commissioners** as liquidated damages if the BIDDER fails to execute the CONTRACT and provide PERFORMANCE BOND and PAYMENT BOND within ten (10) calendar days after being notified that he has been awarded the Contract.

Payment will be made on a monthly basis for work performed the previous month, less retainage. Until 50% of the value of the contract (including change orders and additions), or if the Contractor fails to maintain his construction schedule to the satisfaction of the Engineer, the County will retain 10% of the gross value of the completed work as indicated by the current estimate approved by the Engineer. After the contract (including change orders and additions) is 50% complete, there shall be no additional retainage withheld unless the work is determined to be unsatisfactory or has fallen behind schedule.

The BIDDER is expected to examine the sites of the proposed work, the BIDDERS CHECKLIST, INSTRUCTIONS TO BIDDERS, GENERAL CONDITIONS, SPECIFICATIONS and AGREEMENT forms before submitting a BID.

The **Effingham County Board of Commissioners** reserves the right to reject any and all Bids and to waive any informality in the bidding. Additionally Effingham County may issue change orders altering the original

scope of work to address changes or unforeseen conditions necessary for the project completion. No Bids shall be withdrawn within 60 days after the actual date of the opening thereof. Bids from noncertified Bidders will not be considered.

The CONTRACT DOCUMENTS may be examined at the following location: **Effingham County Board of Commissioners, 601 North Laurel Street, Springfield GA, 31329.**

Copies of the CONTRACT DOCUMENTS may be obtained at:
<http://www.effinghamcounty.org/279/Purchasing-Procurement>

The Completion Date for this Contract shall be 90 calendar days from the date of the NOTICE TO PROCEED.

Bids shall be submitted in a sealed envelope, marked with the Purchasing Bid Number and Title, as well as the BIDDER'S name, and shall be addressed to the **Effingham County Board of Commissioners.**

ATTENTION: Effingham County Purchasing Agent
601 N. Laurel Street
Springfield, GA 31329

The BID must be submitted in duplicate and will include the following signed documents:

1. DOCUMENT CHECK LIST
2. DRUG FREE WORKPLACE CERTIFICATION, Attachment A
3. PROMISE OF NON-DISCRIMINATION STATEMENT, Attachment B
4. DISCLOSURE OF RESPONSIBILITY STATEMENT, Attachment C
5. GEORGIA SECURITY AND IMMIGRATION COMPLIANCE ACT AFFIDAVIT (E-VERIFY) - CONTRACTOR, Attachment D
6. GEORGIA SECURITY AND IMMIGRATION COMPLIANCE ACT AFFIDAVIT (E-VERIFY) – SUBCONTRACTOR, Attachment E
7. LIST OF SUBCONTRACTORS, Attachment G
8. BIDDERS CERTIFICATION REGARDING DEBARMENT, SUSPENSION, INELIGIBILITY AND VOLUNTARY EXCLUSION, Attachment H
9. GENERAL CONDITIONS
10. COMPLETED BID FORM
11. BID BOND, CERTIFIED CHECK OR CASHIER'S CHECK
12. CERTIFICATE OF INSURANCE
13. COMPLETED W-9

INSTRUCTIONS TO BIDDERS

1.1 PURPOSE: The purpose of this document is to provide general and specific information for use in submitting a Bid to supply Effingham County with construction, equipment, supplies and/or services as described herein. All Bids/proposals are governed by the Code of Effingham County, and the laws of the State of Georgia.

1.2 HOW TO SUBMIT BIDS: All bids shall be:

A. Submitted in sealed opaque package (envelope or box as necessary), plainly marked with the bid number and title, date and time of submission, and company name.

B. Mailed or delivered in sufficient time to ensure receipt by the Purchasing Agent on or before the time and date specified above.

Hand Delivery and Mailing Address:

Effingham County Purchasing Agent,
601 North Laurel Street,
Springfield, Georgia, 31329.

BIDS NOT RECEIVED BY THE TIME AND DATE SPECIFIED WILL NOT BE OPENED OR CONSIDERED.

1.4 HOW TO SUBMIT AN OBJECTION: Objections from Bidders to this invitation to bid and/or these specifications should be brought to the attention of the County Purchasing Agent in writing. The objections contemplated may pertain to form and/or substance of the invitation to bid documents. Failure to object in accordance with the above procedure will constitute a waiver on the part of the business to protest this invitation to bid

1.5 QUESTIONS: Any questions pertaining to the bid **must** be made in writing and must be received at the office of the Purchasing Agent no later than **1.00pm** (Eastern Time) on **Thursday November 8, 2018**. Questions may be faxed to 912-754-8413; emailed to fcharleton@effinghamcounty.org or hand delivered/mailed to Effingham County Board of Commissioners, Purchasing Office, 601 N Laurel Street, Springfield, GA 31329. The response to all questions will be in the form of an addendum and will be posted on the Effingham County website www.effinghamcounty.org before **5.00pm** (Eastern Time) on **Thursday November 29, 2018**. If hand delivering or mailing questions, please DO NOT mark the outside of the envelope with the bid number.

The only official answer or position of Effingham County will be the one stated in writing.

1.6 ERRORS IN BIDS: Bidders or their authorized representatives are expected to fully inform themselves as to the conditions, requirements, and specifications before submitting Bids. Failure to do so will be at the Bidders own risk. In case of error in extension of prices in the Bid, the unit price will govern.

1.7 STANDARDS FOR ACCEPTANCE OF BID FOR CONTRACT AWARD: The County reserves the right to reject any or all Bids and to waive any irregularities or technicalities in Bids received whenever such rejection or waiver is in the best interest of the County. The County reserves the right to reject the Bid of a Bidder who has previously failed to perform properly or complete on time contracts of a similar nature, or a Bid from a Bidder whom investigation shows is not in a position to perform the contract.

1.8 BIDDER: Whenever the term "Bidder" is used it shall encompass the "person," "business," "firm," "contractor" or other party submitting a bid to Effingham County in such capacity before a contract has been entered into between such party and the County. At times throughout this Invitation to Bid the term "contractor" may be used interchangeably with the term "bidder".

1.9 COMPLIANCE WITH LAWS: The Proposer shall obtain and maintain all licenses, permits, liability insurance, workman's compensation insurance and comply with any and all other standards or regulations required by Federal, State or County statute, ordinances and rules during the performance of any contract between the Proposer and the County. Any such requirement specifically set forth in any contract document between the Proposer and the County shall be supplementary to this section and not in substitution thereof.

1.10 COUNTY: Whenever the term "County" or "Owner" is used it is to refer to the Effingham County Board of Commissioners.

1.11 DEBARRED FIRMS AND PENDING LITIGATION: Any potential bidder/firm listed on the Federal or State of Georgia Parties Listing (barred from doing business) **will not** be considered for contract award. Bidders **shall disclose** any record of pending criminal violations (indictment) and/or convictions, pending lawsuits, etc., and any actions that may be a conflict of interest occurring within the past five (5) years.

Bids will not be accepted from any company, firm, person, party or parent subsidiary, against which Effingham County has an outstanding claim, or financial dispute relating to prior contract performance. If the County, at any time, discovers such a dispute during any point of evaluation, the bid will not be considered further. Any bidder/firm previously defaulting or terminating a contract with the County will not be considered

Bidder acknowledges that in performing contract work for the County, Bidder shall not utilize any firms that have been a party to any of the above actions. If Bidder has engaged any firm to work on this contract or project that is later debarred, Bidder shall sever its relationship with the firm with respect to County contract.

** All Bidders are to read and complete the Bidders certification regarding debarment, suspension, ineligibility, and voluntary exclusion enclosed as Attachment H to be returned with response. Failure to do so may result in your proposal being rejected as non-responsive.

1.12 IMMIGRATION: On 1 July 2009, the Georgia Security and Immigration Compliance Act (SB 529, Section 2) became effective. All employers, contractors and subcontractors entering into a contract or performing work must sign an affidavit that he/she has used the E-Verify System. E-Verify is a no-cost federal employment verification system to insure employment eligibility. Affidavits are enclosed in this solicitation. You may download M-274 Handbook for Employers at <http://www.dol.state.ga.us/spotlight/employment/rules>. You may go to <http://www.uscis.gov> to find the E-Verify information.

** All Proposers are to read and complete the E-Verify affidavit enclosed as Attachment D to be returned with response. Failure to do so may result in your solicitation response being rejected as non-responsive

1.13 PROTECTION OF RESIDENT WORKERS: Effingham County Board of Commissioners actively supports the Immigration and Nationality Act (INA) which includes provisions addressing employment eligibility, employment verification, and nondiscrimination. Under the INA, employers may hire only persons who may legally work in the United States (i.e., citizens and nationals of the U.S.) and aliens authorized to work in the U.S. The employer must verify the identity and employment eligibility of anyone to be hired, which includes completing the Employment Eligibility Verification Form (I-9). The Contractor shall establish appropriate procedures and controls so no services or products under the Contract Documents will be performed or manufactured by any worker who is not legally eligible to perform such services or employment.

1.14 STATEMENT OF DISCLOSURE : All Vendors must provide a statement of disclosure which will

allow the County to evaluate possible conflicts of interest.

Interests of Public Officials.

The vendor warrants for itself and any subcontractor that no elected or appointed official or employee of Effingham County, Georgia, has any interest in their bid or the proceeds of any contract/agreement which may result thereof. In the event that an elected or appointed official or employee acquires any interest in any contract/agreement which may result from this bid, or the proceeds thereof, the vendor agrees to disclose such interest to the BOARD immediately by written notice. For breach or violation of this clause, the BOARD may annul any contract/agreement resulting from this bid without liability, terminate any contract/agreement resulting from this bid for default, or take other remedial measures. “Interest” as used herein means direct or indirect pecuniary or material benefit accruing to a county commissioner, official or employee as a result of a matter which is or which is expected to become the subject of an official action by or with the county, except for such actions which, by their terms and by the substance of their provisions, confer the opportunity and right to realize the accrual of similar benefits to all other persons and/or property similarly situated. The term “interest” shall not include any remote interest. For purposes of this bid, a county commissioner, official or employee shall be deemed to have an interest in the affairs of: (1) his or her family; (2) any business entity in which the county commissioner, official or employee is a member, officer, director, employee, or prospective employee; and (3) any business entity as to which the stock, legal ownership, or beneficial ownership of a county commissioner, official or employee is in excess of five percent of the total stock or total legal and beneficial ownership, or which is controlled or owned directly or indirectly by the county commissioner, official or employee. *Remote interest* as used herein means the interest of (1) a volunteer director, officer, or employee of a nonprofit corporation; (2) a holder of less than 5 percent of the legal or beneficial ownership of the total shares of a business; (3) any person in a representative capacity, such as a receiver, trustee, or administrator. *Family* as used herein means the spouse, parents, children, and siblings, related by blood, marriage, or adoption, of a county official or employee.

1.15 ITB SCHEDULE:

Invitation to Bid	Date/ Time
Owner issues public advertisement of ITB	Monday October 15, 2018
Mandatory Pre-bid conference	11.00am (Eastern Time) on Monday November 5, 2018
Deadline for submission of written questions: Fax : 912-754-8413 / Email : fcharleton@EffinghamCounty.org Hand deliver /regular mail : Effingham County Board of Commissioners, Purchasing Office, 601 N Laurel Street, Springfield, GA 31329	1.00pm (Eastern Time) on Thursday November 8, 2018.
Addendum issued to answer questions (if any) and posted online at www.effinghamcounty.org	5.00pm (Eastern Time) on Thursday 29 November, 2018
Deadline for submission of Bids	11.00am (Eastern Time) on Tuesday December 4, 2018
Bid goes before the Board of Commissioners for approval	Tuesday December 20, 2018
Results posted online at www.effinghamcounty.org	5.00pm (Eastern Time) on Wednesday December 21, 2018

ATTACHMENT A
DRUG FREE WORKPLACE CERTIFICATION

The undersigned certifies that the provisions of Code Sections 50-24-1 through 50-24-6 of the Official Code to Georgia Annotated, related to the Drug Free Workplace have been complied with.

1. A drug-free workplace will be provided for the employees during the performance of the contract;

and;

2. Each Sub-Contractor under the direction of the Contractor shall secure the following written certification:

_____ (Contractor) certifies to Effingham County that a drug-free workplace will be provided for the employees during the performance of this contract known as **ITB No. 19-25-002 – Honey Ridge Road Bridge Replacement** pursuant to paragraph (7) of subsection (B) of Code Section 50-24-3. Also, the undersigned further certifies that he/she will not engage in the unlawful manufacture, sale, distribution, dispensation, possession, or use of a controlled substance or marijuana during the performance of the contract.

CONTRACTOR

DATE

NOTARY

DATE

ATTACHMENT B

PROMISE OF NON-DISCRIMINATION STATEMENT

Know all men by these presence, that I (We), _____, _____,
Name Title

Name of Bidder

(herein after "Company"), in consideration of the privilege to Bid/Propose on the following Effingham

County Procurement titled **ITB No. 19-25-002 – Honey Ridge Road Bridge Replacement** hereby consent, covenant, and agree as follows:

- A. No person shall be excluded from participation in, denied the benefit of, or otherwise discriminated against on the basis of race, color, national origin or gender in connection with the Bid submitted to Effingham County or the performance of the contract resulting there from;
- B. That it is and shall be the policy of this Company to provide equal opportunity to all business persons seeking to contract with or otherwise interested in the Company, including those companies owned and controlled by racial minorities and women; and
- C. That the promises of non-discrimination as made and set forth herein shall be continuing throughout the duration of this contract with Effingham County.
- D. That the promises of non-discrimination as made and set forth herein shall be and are hereby deemed to be made part of and incorporated by reference in the contract which this Company may be awarded.
- E. That the failure of this Company to satisfactorily discharge any of the promises of non-discrimination as made and set forth above may constitute a material breach of contract entitling the County to declare the contract in default and to exercise appropriate remedies including but not limited to termination of the contract.

SIGNATURE

DATE:

ATTACHMENT C

DISCLOSURE OF RESPONSIBILITY STATEMENT (page 1)

Failure to complete and return this information will result in your bid/offer/proposal being disqualified from further competition as non-responsive.

1. List any convictions of any person, subsidiary, or affiliate of the company, arising out of obtaining, or attempting to obtain a public or private contract or subcontract, or in the performance of such contract or subcontract.
2. List any indictments or convictions of any person, subsidiary, or affiliate of this company for offenses such as embezzlement, theft, fraudulent schemes, etc. or any other offenses indicating a lack of business integrity or business honesty which affects the responsibility of the contractor.
3. List any convictions or civil judgments under states or federal antitrust statutes.
4. List any violations of contract provisions such as knowingly failing (without good cause) failing to perform, or unsatisfactory performance, in accordance with the specifications of a contract.
5. List any prior suspensions or debarments by any governmental agency.
6. List any contracts not completed on time.
7. List any penalties imposed for time delays and/or quality of materials and workmanship.
8. List any documented violations of federal or any state labor laws, regulations, or standards, and any occupational safety and health rules.

NOTE: The penalty for making false statements in offers is prescribed in 18 U.S.C. 1001

DISCLOSURE OF RESPONSIBILITY STATEMENT (page 2)

I, _____, as _____
Name of individual Title & Authority

of _____, declare under oath that the above statements,
Company Name

including any supplemental responses attached hereto, are true.

Signature

State of: _____

County of: _____

Subscribed and sworn to before me on this _____ day of _____ 2018

by _____ representing him/herself to be

_____ of the company named.

Notary Public

My Commission expires:

Resident State: _____

**ATTACHMENT D
CONTRACTOR AFFIDAVIT AND AGREEMENT (E-VERIFY)**

By executing this affidavit, the undersigned contractor verifies its compliance with O.C.G.A. § 13-10-91, stating affirmatively that the individual, firm, or corporation that is contracting with Effingham County has registered with and is participating in a federal work authorization program* [any of the electronic verification of work authorization programs operated by the United States Department of Homeland Security or any equivalent federal work authorization program operated by the United States Department of Homeland Security to verify information of newly hired employees, pursuant to the Immigration Reform and Control Act of 1986 (IRCA), P.L. 99-603], in accordance with the applicability provisions and deadlines established in O.C.G.A. § 13-10-91, and shall agree to use this program for any newly hired employees throughout the duration of the contract.

The undersigned further agrees that, should it employ or contract with any subcontractor(s) in connection with the physical performance of services pursuant to this contract with Effingham County, contractor will secure from such subcontractors) similar verification of compliance with O.C.G.A. § 13-10-91 on the Subcontractor Affidavit provided in Rule 300-10-01-.08 or a substantially similar form. The contractor further agrees to provide notice to the County of the identity of each subcontractor hired under the contract within five (5) business days of entering into a contract for hire. Such notice shall include a copy of the Subcontractor Affidavit for each subsequent subcontractor attesting to the subcontractor's name, address, user identification number, and date of authorization to use the federal work authorization program. Contractor further agrees to maintain records of such compliance and provide a copy of each such verification to the Effingham County within five (5) days of the time the subcontractor(s) is retained to perform such service.

EEV/ Basic Pilot Program* User Identification Number

BY: Authorized Officer or Agent (Contractor Name) Date

Title of Authorized Officer or Agent of Contractor

Printed Name of Authorized Officer or Agent

SUBSCRIBED AND SWORN BEFORE ME ON THIS THE

____ DAY OF _____ 20

Notary Public

My Commission Expires: - _____, 20 ____

* As of the effective date of O.C.G.A. § 13-10-91, the applicable federal work authorization program is the "EEV/ Basic Pilot Program" operated by the U.S. Citizenship and Immigration Services Bureau of the U.S. Department of Homeland Security, in conjunction with the Social Security Administration (SSA).

ATTACHMENT E

SUBCONTRACTOR AFFIDAVIT (E-VERIFY)

By executing this affidavit, the undersigned subcontractor verifies its compliance with O.C.G.A. § 13-10-91, stating affirmatively that the individual, firm or corporation that is engaged in the physical performance of services under a contract with (name of contractor) on behalf of Effingham County has registered with and is participating in a federal work authorization program* [any of the electronic verification of work authorization programs operated by the United States Department of Homeland Security or any equivalent federal work authorization program operated by the United States Department of Homeland Security to verify information of newly hired employees, pursuant to the Immigration Reform and Control Act of 1986 (IRCA), P.L. 99-603], in accordance with the applicability provisions and deadlines established in O.C.G.A. § 13-10-91 and will agree to use this program for any newly hired employees throughout the duration of the contract. The subcontractor further agrees to provide a copy of the executed Subcontractor Affidavit to the Contractor in order to be provided to the County within five (5) days entering into the contract for hire.

EEV / Basic Pilot Program* User Identification Number

Date of E-Verify Authorization

Address

BY: Authorized Officer or Agent (Subcontractor Name) Date

Title of Authorized Officer or Agent of Subcontractor

Printed Name of Authorized Officer or Agent

SUBSCRIBED AND SWORN BEFORE ME ON THIS THE

____ DAY OF _____ 20

Notary Public

My Commission Expires: _____, 20 ____

* As of the effective date of O.C.G.A. 13-10-91, the applicable federal work authorization program is the "EEV/ Basic Pilot Program" operated by the U. S. Citizenship and Immigration Services Bureau of the U.S. Department of Homeland Security, in conjunction with the Social Security Administration (SSA).

**ATTACHMENT F
NO-BID STATEMENT**

In an effort to make the procurement of construction, goods and services for Effingham County as competitive as possible, we are soliciting information from contractors and or vendors who cannot Bid. Your "responsiveness" and "constructive" comments will be appreciated. Completion of this form will assist us in evaluating factors which relate to the competitiveness of our Bids. Please check any of the boxes below which may apply.

- Specifications - Restrictive, too "tight", unclear, specialty item, geared toward one (1) brand or manufacturer only. (Explain below)
- Manufacturing - Unique item, production time for model or item has expired, etc.
- Bid Time - Insufficient time to properly respond to Bid or proposal.
- Delivery Time - Specified delivery time cannot be met.
- Payment - Delay in payment terms. Please be specific.
- Bonding - We are unable to meet bonding requirements.
- Insurance -We are unable to meet insurance requirements.
- Removal - From Bidders list for this particular commodity or service.
- Keep - Our Company on your Bidders list for future reference.
- Project is - Too Large _____ Too Small _____
- Site Location Too Distant.
- Miscellaneous - Do not wish to Bid, do not handle this type of item (s), unable to compete, contract clause (s) not acceptable, etc. Please be specific.

CONSTRUCTION PROJECTS: Please provide reason for obtaining a Bid package. Check one below.

Interest in this project as a:

Prime Contractor _____

Sub-Contractor _____

Supplier _____

ITB No. 19-25-002 – Honey Ridge Road Bridge Replacement

Signature: _____

Telephone Number: _____

Firm Name: _____

**ATTACHMENT G
LIST OF SUBCONTRACTORS**

I _____/DO, _____/DO NOT, propose to subcontract some of the work on this project. I propose to subcontract work to the following contractors/firms:

CONTRACTOR/FIRM NAME:	ADDRESS:	DESCRIPTION OF WORK/SERVICES TO BE PERFORMED:	CONTRACT AMOUNT	DBE (Y/N)

ATTACHMENT H

**BIDDER’S CERTIFICATION REGARDING DEBARMENT, SUSPENSION,
INELIGIBILITY AND VOLUNTARY EXCLUSION**

I hereby certify that I am the _____ and duly authorized representative of _____ (Contractor) whose address is _____ and I certify that I have read and understand the attached instructions and that to the best of my knowledge and belief the firm and its representatives:

(a) Are not presently debarred, suspended, proposed for debarment, declared ineligible, or voluntarily excluded from covered transactions by the Georgia Department of Transportation, any Federal Department or Agency, Board of Education or local municipality.

(b) I acknowledge that this certification is provided pursuant to Executive Order 12549 and 49 CFR Part 29 and that this firm agrees to abide by the rules and conditions set forth therein for any misrepresentation that would render this certification erroneous, including termination of this Agreement and other remedies available to the Georgia Department of Transportation, Federal Government, Board of Education or local municipality.

(c) I further acknowledge that this firm will include this clause without modification in all lower tier transactions, solicitations, proposals, contracts and subcontracts. Where the Bidder or any lower tier participant is unable to certify to this statement, that participant shall attach an explanation to this document.

(Date)

(Signature)

ATTACHMENT I

Legal Notice

Invitation to Bid

ITB No. 19-25-002 – Honey Ridge Road Bridge Replacement

Effingham County, Georgia is seeking bids from firms interested in **ITB No. 19-25-002 – Honey Ridge Road Bridge Replacement**.

Sealed proposals are due by **11.00am** (Eastern Time) on **Tuesday December 4, 2018**, and must be mailed or hand delivered to the Effingham County Purchasing Office, 601 N. Laurel Street, Springfield, GA 31329.

A copy of this Invitation to Bid is available at the address listed above or online at www.effinghamcounty.org - Purchasing tab. For additional information please contact, Fiona Charleton at (912) 754-2159 or via email: fcharleton@effinghamcounty.org

EFFINGHAM COUNTY RESERVES THE RIGHT TO REJECT ANY/AND ALL BIDS AND TO WAIVE ALL FORMALITIES. "EFFINGHAM COUNTY IS AN EQUAL OPPORTUNITY EMPLOYER, M/F/H, ALL BIDDERS ARE TO BE EQUAL OPPORTUNITY EMPLOYERS".

GENERAL CONDITIONS

- 2.1 SPECIFICATIONS:** Any obvious error or omission in the specifications shall not inure to the benefit of the Bidder but shall put the Bidder on notice to inquire of or identify the same to the County.
- 2.2 GEORGIA OPEN RECORDS ACT:** The responses will become part of the County's official files without any obligation on the County's part. Ownership of all data, materials, and documentation prepared for and submitted to Effingham County in response to a solicitation, regardless of type, shall belong exclusively to Effingham County and will be considered a record prepared, maintained or received in the course of operations of public office or agency and is subject to public inspection in accordance with the *Georgia Open Records Act, Official Code of Georgia Annotated, Section 50-18-070, et.Seq.* unless otherwise provided by law. The Georgia Open Records Act is applicable to the records of all contractors and subcontractors under contract with the County. This applies to those specific contracts currently in effect and those which have been completed or closed up to three (3) years following completion.
- 2.3 GEORGIA TRADE SECRET ACT OF 1990:** In the event that a Bidder submits secret information to the County, the information must be clearly labeled as a "Trade Secret". The County will maintain the confidentiality of such trade secrets to the extent provided by law.
- 2.4 PRICES TO BE FIRM:** The Bidder warrants that Bid prices, terms and conditions quoted in his Bid will be firm for acceptance for a period of sixty (60) days from Bid opening date, unless otherwise stated in the Bid.
- 2.5 COMPLETENESS:** All information required by the Invitation to Bid must be completed and submitted to constitute a proper bid. The County shall have sole discretion in evaluating qualifications and responses of Bidders. Bidder acknowledges that in performing a contract for the Board, Bidder shall not utilize any firms that have been a party to any of the actions listed in paragraph **1.10**. If Bidder has engaged any firm to work on this contract or project that is later debarred, Bidder shall sever its relationship with that firm with respect to the Board's contract.
- 2.6 MULTIPLE PROPOSALS:** No Bidder will be allowed to submit more than one offer. Any alternate proposals must be brought to the Purchasing Agent's attention during the Pre-bid Conference or submitted in writing at least five (5) days preceding the date for submission of bids.
- 2.7 PATENT INDEMNITY:** Except as otherwise provided, the successful Bidder agrees to indemnify Effingham County and its officers, agents and employees against liability.
- 2.8 QUALIFICATION OF BUSINESS (RESPONSIBLE BIDDER):** A responsible Bidder is defined as one who meets, or by the date of the Bid acceptance can meet, all requirements for licensing, insurance, and service contained within this Invitation for Bids. Effingham County has the right to require any or all Proposers to submit documentation of their ability to perform, provide or carry out the service requested and to disqualify the proposal of any Proposer as being unresponsive or un-responsible whenever such Proposer cannot.
- 2.9 CERTIFICATION OF INDEPENDENT PRICE DETERMINATION:** By submission of this bid, the Bidder certifies, and in the case of a joint bid each party thereto as to its own organization, that in connection with this procurement.
- A. The prices in this Bid have been arrived at independently, without consultation, communication, or agreement, for the purpose of restricting competition, as to any matter relating to such price

- with any other bidder or with any competitor;
- B. Unless otherwise required by law, the prices which have been quoted in this bid have not been knowingly disclosed by the bidder and will not knowingly be disclosed by the bidder prior to opening, directly or indirectly to any other competitor; and;
- C. No attempt has been made or will be made by the bidder to induce any other person or firm to submit or not to submit a bid for the purpose or restricting competition.

2.10 AWARD OF CONTRACT: The contract, if awarded, shall be awarded to the lowest responsible and responsive bidder whose combined bid meets the requirements and criteria set forth in the advertisement for bids; provided, however, that if the bid from the lowest responsible and responsive bidder exceeds funds budgeted for the contract, the county may negotiate with such apparent low bidder to obtain a contract price within the budgeted amount. Such negotiations may include changes in the scope of work and other bid requirements. Effingham County reserves the right to reject any of all bids, and to waive formalities.

2.11 TERM OF THE CONTRACT: The contract period will be for the period specified in the contract document **UNLESS DIRECTED OTHERWISE BY THE BOARD OF COMMISSIONERS.**

2.12 INSURANCE PROVISIONS: The selected Bidder shall be required to procure and maintain for the duration of the contract insurance against claims for injuries to persons or damages to property which may arise from or in connection with the performance of the work hereunder by the Bidder, his agents, representatives, employees or subcontractors. The cost of such insurance shall be included in the Bid. **Contract work will not proceed unless Effingham County has in their possession, a current Certificate of Insurance. Effingham County invokes the defense of sovereign immunity. The County is not to be included as an additional insured on insurance contracts.**

General Information that shall appear on a Certificate of Insurance:

- A. Name of Producer (Contractor's insurance Broker/Agent).
- B. Companies affording coverage (there may be several).
- C. Name and address of the Insured (this should be the Company or Parent of the firm Effingham County is contracting with).
- D. A Summary of all current insurance for the insured (includes effective dates of coverage).
- E. A brief description of the operations to be performed, the specific job to be performed, or contract number.
- F. Certificate Holder (**This is to always include Effingham County**).

2.13 LIMITS OF INSURANCE: Effective coverage shall have the following limits:

- A. **Commercial General Liability:** Provides protection against bodily injury and property damage claims arising from operations of a Contractor or Tenant. Minimum limits: \$1,000,000 bodily injury and property damage per occurrence and annual aggregate.
- B. **Worker's Compensation and Employer's Liability:** Provides statutory protection against bodily injury, sickness or disease sustained by employees of the Contractor while performing within the scope of duties. Minimum limits: \$500,000 for each accident, disease policy limit, and disease each employee and Statutory Worker's Compensation limit.
- C. **Business Automobile Liability:** Coverage insures against liability claims arising out of the Contractor's use of automobiles. Minimum limit: \$1,000,000 combined single limit per accident for bodily injury, property damage, and should be written on an "Any Auto" basis.

2.14 SPECIAL REQUIREMENTS:

- A. **Claims-Made Coverage:** The limits of liability shall remain the same as the occurrence basis, however, the Retroactive date shall be prior to or coincident with the date of any contract, and the Certificate of Insurance shall state the retroactive date and the coverage is claims-made.
- B. **Extended Reporting Periods:** The Contractor shall provide the County with a notice of the election to initiate any Supplemental Extended Reporting Period and the reason(s) for invoking this option.
- C. **Reporting Provisions:** Any failure to comply with reporting provisions of the policies shall not affect coverage provided in relation to this request.
- D. **Cancellation/Non-Renewal Notification:** Each insurance policy supplied in response to this request shall be endorsed to state that it shall not be suspended, voided, or canceled, except after thirty (30) days prior to written notice by certified mail, return receipt requested, has been given to the County.
- E. **Proof of Insurance:** Effingham County shall be furnished with certificates of insurance and original endorsements affecting coverage required by this request. The certificates and endorsements are to be signed by a person authorized by the insurer to bind coverage on its behalf. All certificates of insurance are to be submitted prior to, and approved by, the County before services are rendered. The Proposer must ensure Certificates of Insurance are updated for the entire term of the Contract.
- F. **Insurer Acceptability:** Insurance is to be placed with an insurer having an A.M. Best's rating of A and a five (5) year average financial rating of not less than V. If an insurer does not qualify for averaging on a five year basis, the current total Best's rating will be used to evaluate insurer acceptability.
- G. **Lapse in Coverage:** A lapse in coverage shall constitute grounds for contract termination by Effingham County Board of Commissioners.
- H. **Deductible and Self-Insured Retention:** Any deductibles or self-insured retention must be declared to, and approved by, the County. At the option of the County, either: the insurer shall reduce or eliminate such deductibles or self-insured retention as related to the County, its officials, officers, employees, and volunteers; or the Proposer shall procure a bond guaranteeing payment of related suits, losses, claims and related investigation, claim administration and defense expenses

2.15 ADDITIONAL COVERAGE FOR SPECIFIC PROCUREMENT PROJECTS:

Professional Liability: Insure errors or omission on behalf of architects, engineers, attorneys, medical professionals, and consultants.

Minimum Limits: \$1,000,000 per claim/occurrence.

Coverage Requirement: If “claims made,” retroactive date must precede or coincide with the contract effective date or the date of the Notice to Proceed. The professional must state if “tail” coverage has been purchased and the duration of the coverage.

Builder’s Risk: (for Construction or Installation Contracts) Covers against insured perils while in the course of construction.

Minimum Limits: All-risk coverage equal 100% of contract value.

Coverage requirements: Occupancy clause – permits Effingham County Board of Commissioners to use the facility prior to issuance of Notice of Substantial Completion.

- 2.16 INDEMNIFICATION:** The CONTRACTOR agrees to protect, defend, indemnify, and hold harmless Effingham County, Georgia, its commissioners, officers, agents, and employees from and against any and all liability, damages, claims, suits, liens, and judgments, of whatever nature, including claims for contribution and/or indemnification, for injuries to or death of any person or persons, or damage to the property or other rights of any person or persons caused by the CONTRACTOR or its subcontractors.

The CONTRACTOR'S obligation to protect, defend, indemnify, and hold harmless, as set forth herein above shall include, but not be limited to, any matter arising out of any actual or alleged infringement of any patent, trademark, copyright, or service mark, or any actual or alleged unfair competition, disparagement of product or service, or other business tort of any type whatsoever, or any actual or alleged violation of trade regulations. CONTRACTOR further agrees to investigate, handle, respond to, provide defense for, and to protect, defend, indemnify, and hold harmless Effingham County, Georgia, at his sole expense, and agrees to bear all other costs and expenses related thereto, even if such claims, suits, etc., are groundless, false, or fraudulent, including any and all claims or liability for compensation under the Worker's Compensation Act arising out of injuries sustained by any employee of the CONTRACTOR or his subcontractors or anyone directly or indirectly employed by any of them. The CONTRACTOR'S obligation to indemnify Effingham County under this Section shall not be limited in any way by the agreed-upon contract price, or to the scope and amount of coverage provided by any insurance maintained by the CONTRACTOR.

- 2.17 INTERPRETING SPECIFICATION:** The specifications or scope of services contained herein are intended to be descriptive rather than restrictive. The County is soliciting a bid to provide a complete product or service package which meets all requirements. Specific equipment and system references may be included in the ITB for guidance, but they are not intended to preclude bidders from recommending alternative solutions for offering comparable or better performance or value to the County. Changes in the scope of services, specifications, or terms and conditions of the ITB will be made in writing by the County prior to the bid opening or due date. Results of informal meetings between a potential Bidder and a County official or employee may not be used as a basis for deviations from the requirements contained in this solicitation.
- 2.18 SIGNED RESPONSE CONSIDERED AN OFFER:** The signed Bid shall be considered an offer on the part of the Bidder, which offer shall be deemed accepted upon approval by the Effingham County Board of Commissioners, or their designee. In case of a default on the part of the Bidder after such acceptance, Effingham County may take such action as it deems appropriate, including legal action for damages or lack of required performance.
- 2.19 NOTICE TO PROCEED:** The successful bidder shall not commence work under this Invitation to Bid until a written contract is awarded and a Notice to Proceed is issued by the Purchasing Agent or his designee. If the successful Bidder does commence any work or deliver items prior to receiving official notification, he does so at his own risk.
- 2.20 PAYMENT TO CONTRACTORS:** Instructions for invoicing the County for services delivered to the County are specified in the contract document.
- A. Questions regarding payment may be directed to the Effingham County Finance Department, at (912) 754-8057.
 - B. Contractors will be paid the agreed upon compensation upon satisfactory progress or completion of the work as more fully described in the contract document.
 - C. Effingham County is a tax exempt entity. Every contractor, vendor, business or person under contract with Effingham County is required by Georgia law to pay State sales or use taxes for products purchased in Georgia or transported into Georgia and sold to Effingham County by contract. Please consult the State of Georgia, Department of Revenue, Sales and Use Tax Unit in Atlanta (404) 656-4065 for additional information.

- 2.21 CONTRACT COST ADJUSTMENTS:** Prices quoted shall be firm for the contract term.
- 2.22 VENDOR DEFAULT:** In case of vendor default, the County will provide a letter of official notice of non-performance. If the issue(s) are not remedied 30 days from receipt of said notice, the County reserves the right to procure services from other sources.
- 2.23 METHOD OF COMPENSATION:** The successful Contractor will be compensated in accordance with the approved compensation schedule. Should the Project begin within any one month, the first invoice shall cover the partial period from the beginning date of the project through the last day of the month (or a mutually agreeable time). All invoices shall be submitted on a monthly basis until the project is completed. Invoices shall be itemized to reflect actual expenses for each individual task and will be accompanied by a summary progress report which outlines the work accomplished during the billing period and shall identify any problems which may be inhibiting project execution. The terms of the resulting contract are intended to supersede all provisions of the Georgia Prompt Pay Act. As long as the gross value of work is less than 50% of the total contract amount, or if the Contractor fails to maintain his construction schedule to the satisfaction of the Engineer, the County will retain 10% of the gross value of the completed work as indicated by the current estimate approved by the Engineer. After the gross value of completed work meets or exceeds 50% of the total contract amount within a time period satisfactory to the County, there shall be no additional retainage withheld unless the work is determined to be unsatisfactory or has fallen behind schedule. The contractor may submit a final invoice to the County for the remaining retainage upon the County’s acceptance of the Certificate of Substantial Completion. Final payment constituting the entire unpaid balance due shall be paid by the County to the Contractor when work has been fully completed and the contract fully performed, except for the responsibilities of the Contractor which survive final payment. The making of final payment shall constitute a waiver of all claims by Effingham County except those arising from unsettled liens, faulty or defective work appearing after substantial completion, failure of the work to comply with the requirements of the contract document, or the terms of any warranties required by the contract document or items previously made in writing and identified by the County as unsettled at the time of final application for payment. Acceptance of final payment shall constitute a waiver of all claims by the Contractor, except for those previously made in writing and identified by the Contractor as unsettled at the time of final application for payment.
- 2.24 RAIN DELAYS:** The time of completion includes an allowance for Rain Days that is based upon normal and anticipated rainfall events for the region for each month or part of a month that the resulting contract work is to be performed. For periods of less than a whole month, the number of days for that part of a month is determined on a prorated basis rounded to the nearest whole day. For the purpose of the resulting contract in determining the actual number of days incurred during the period of the contract, the following table shall apply:

January	4 Days	July	6 Days
February	5 Days	August	12 Days
March	6 Days	September	10 Days
April	8 Days	October	6 Days
May	1 Day	November	6 Days
June	8 Days	December	6 Days

Source: Mean number of days with precipitation 0.01 inch or more, U.S. Department of Commerce, National Oceanic & Atmospheric Administration - www.ncdc.noaa.gov.

No claim shall be made by the Contractor for delay of work due to an excessive number of rain days except when accordance with the following procedures. The above listed rain days shall be applied to the corresponding months during which construction occurs. The start of construction shall be the date of “Notice to Proceed” and the end of construction shall be the date of “Substantial Completion”. The Contractor shall provide and install a rain gauge meeting the requirements of the County. Rainfall amounts shall be recorded in a permanently bound booklet indicating the date and time of the reading, the amount of rainfall during the preceding 24 hour period and the name of the person taking the reading. The gauge shall be reset to zero after each reading. The reading shall be taken at the same times each day, at times of day that are mutually agreeable to the County and the Contractor and represent the normal beginning and ending times of workdays. A missed beginning time reading may be considered cause for invalidating the subsequent ending time reading.

Any rain day shall be considered to have occurred if the amount of the rain measured at the normal ending time of a scheduled work day exceeds 0.01 inch and the Contractor provides satisfactory evidence that expected work was not performed on such day as a result of rainfall.

High groundwater provision, high tide conditions including storm surges, base-flow drainage and drainage caused by wet weather conditions, and other causes of wet ground conditions at the job site shall not be considered as rain days or in any other way considered to be unexpected. The Contractor shall plan the work under these conditions.

2.25 GUARANTEE: Unless otherwise specified by County, the Bidder shall unconditionally guarantee the materials and workmanship on all material and/or services for a period of not less than one year. If, within the guarantee period any defects occur which are due to faulty material and or services, the contractor at his expense, shall repair or adjust the condition, or replace the material and/or services to the complete satisfaction of the County. These repairs, replacement or adjustments shall be made only at such time as will be designed by the County as being least detrimental to the operation of County business.

2.26 SURETY BOND REQUIREMENTS (CHECKED WHERE APPLICABLE):

- A.** Bidder shall post a Bid Bond, Certified Check, or Money Order made payable to the Effingham County Finance Department in the amount of 5% of the Bid price.
- B.** Contractor(s) shall post a Payment/Performance Bond, Certified Check, or Money Order made payable to the Effingham County Board of Commissioners, in the amount of 100% of the Bid price if awarded the contract or purchase. Bond(s) are due prior to contract execution as a guarantee that goods meet specifications and will be delivered in accordance with the contract document. Bond(s) will also guarantee quality performance of services and timely payment of invoices due any sub-contractors.
- C.** Whenever a Bond is provided, it shall be executed by a surety authorized to do business in the State of Georgia and approved by Effingham County.
- D.** Bidder acknowledges Effingham County’s right to require a Performance Bond of specific kind and origin.

- X E. Forfeit in the amount of the Bid Bond as liquidated damages if he/she fails to enter into a contract with Effingham County to do and/or furnish everything necessary to provide service and/or accomplish the work stated and/or specified in this Bid Proposal for the Bid amount, and;
- X F. Forfeit the amount of the Performance Bond as liquidated damages if he/she fails to execute and fulfill the terms of the contract entered. The amount of forfeiture shall be:
1. The difference between his/her Bid and the next lowest, responsible Bid that has not expired or been withdrawn, or;
 2. The difference between his/her Bid and the lowest, responsible Bid received as a result of re-Bidding, including all costs related to re-Bidding.

THIS SECTION INTENTIONALLY LEFT BLANK

ITB No. 19-25-002 – Honey Ridge Road Bridge Replacement

The undersigned Bidder certifies that he/she has carefully read the preceding list of instructions and all other data applicable hereto and made a part of this invitation to Bid; and, further certifies that the prices shown in his/her bid are in accordance with all documents contained in this Invitation to Bid package, and that any exception taken thereto may disqualify his/her proposal.

This is to certify that I, the undersigned Bidder, have read the instructions to Bidder and agree to be bound by the provisions of the same.

This _____ day of _____ 20 _____.

BY: _____
SIGNATURE

PRINTED NAME AND TITLE

COMPANY

ADDRESS

PHONE NUMBER

SUPPLEMENTAL CONDITIONS

PROJECT: ITB No. 19-25-002 – Honey Ridge Road Bridge Replacement

DESCRIPTION OF WORK:

The work will consist of furnishing all materials, labor and equipment for:

Saw-cutting and removing the existing asphalt paving as shown on the construction plans.

Removing the existing concrete bridge in Honey Ridge Road as shown on the construction plans.

Excavation of materials necessary to construct the new box culvert including one (1') below the new subgrade.

All testing is to be done by a certified Testing Firm using ASTM and shall be paid by the contractor.

Preparation of the subgrade shall be in accordance with the report by Terracon Consultants, Inc. which is attached to and included in this ITB. The contractor shall notify the Engineer in advance of the testing of the subgrade.

Construction of a GDOT Specification Triple 10' X 5' Box Culvert 38' long, parapet to parapet, complete with wing walls and 57 stone base as shown on the construction plans and the report by Terracon Consultants, Inc. Contractor shall notify Engineer when the forms and rebar are in place for inspection before any concrete is poured. Testing Firm shall make at least 3 concrete cylinders of each pour with one break at 7 days, one break at 21 days and one to be kept for future in case of failure.

Backfilling and compaction of material around and over the box culvert to 98% Standard Proctor to the subgrade for Honey Ridge Road.

Repaving and restriping Honey Ridge Road as shown on the construction plans.

Installing GDOT Specification 31" high guardrail as shown on the construction plans.

Designing, installing, maintaining and removing water control dikes to maintain dry conditions in the construction area. This includes any dewatering necessary. Payment for this item is included in the price of the box culvert.

Installation, maintenance and removal of Erosion and Sediment Control structures, including seeding and mulching. Erosion control shall be performed and paid for in accordance with Section 161 of the specifications. Grassing shall be performed and paid for in accordance with Section 700 of the specifications.

Provide traffic control devices to close Honey Ridge Road on both sides of the construction area and provide warning signs of Road Closed Ahead in both directions. Contractor to submit a Traffic Control Plan to the Engineer before construction commences.

Other miscellaneous activities need to deliver a complete product.

Ensure that all construction related activities in places adjacent to environmentally sensitive areas (ESAs) (Easements, staging, vehicular use, borrow or waste activities, construction trailer placement and staging) be restricted to the existing right-of-way.

This project does not require an NOI. Limit land disturbing activities to less than one (1) acre of exposed material.

Work cannot start before 7:00 AM and must be concluded no later than 8:00 PM, Monday thru Saturday.

Note: This is a unit price contract. Quantities are approximate and payment shall be for actual in-place work measurements.

Commencement and Completion:

WORK SHALL BEGIN WITHIN 10 DAYS AFTER RECEIPT OF A “NOTICE TO PROCEED”.

ALL WORK SHALL BE COMPLETED WITHIN 90 CALENDAR DAYS AFTER THE TEN DAY PERIOD.

THIS SECTION INTENTIONALLY LEFT BLANK

Unless otherwise directed, all work performed under this contract shall be in accordance with and all materials shall meet the requirements of The Georgia Department of Transportation Standard Specifications, Construction of Transportation Systems, 2013 Edition and any supplemental specification modifying them except as noted below.

MODIFICATION OF STANDARD SPECIFICATIONS

SECTION 101

DEFINITION AND TERMS

Section 101.14
COMMISSIONER

Delete as written and substitute the following:
THE EFFINGHAM COUNTY BOARD OF
COMMISSIONERS

Section 101.22
DEPARTMENT

Delete as written and substitute the following:
THE EFFINGHAM COUNTY BOARD OF
COMMISSIONERS

Section 101.24
ENGINEER

Delete as written and substitute the following:
EFFINGHAM COUNTY, ENGINEERING
DEPARTMENT

Section 101.26
EXTENSION AGREEMENT

Delete in its entirety:

Section 101.28
FORCE ACCOUNT

Delete in its entirety:

Section 101.84
COUNT

Add:
THE EFFINGHAM COUNTY BOARD OF
COMMISSIONERS

SECTION 102

BIDDING REQUIREMENTS AND CONDITIONS

Section 102.01
PREQUALIFICATION OF BIDDERS

Delete in its entirety and substitute the
following paragraph:

"Bids will be considered only from experienced and well equipped Contractors engaged in work of this type and magnitude. Contractors must be presently prequalified to do this type of work with the Georgia Department of Transportation and have received a Certificate of Qualification in accordance with the Rules and Regulations approved and adopted by the State Transportation Board." Bidders may be required to submit evidence setting forth qualifications, which entitle him to considerations as a responsible Contractor. A list of work of similar character successfully completed within the last two years may be required giving the location, size and listing equipment available for use on this work. Before accepting any bid, the County

ITB No. 19-25-002 – Honey Ridge Road Bridge Replacement

may require evidence of the Contractor's financial ability to successfully perform the work to be accomplished under the contract."

Section 102.05

EXAMINATION OF PLANS, SPECIFICATIONS, SPECIAL PROVISIONS AND SITE OF THE WORK:

Add the following paragraph:

"The County will not be responsible for Bidders' errors or misjudgment, nor for any information on local conditions or general laws and regulations."

Section 102.07

REJECTION OF PROPOSALS:

Add the following subparagraphs:

"I. The County reserves the right to reject any and all bids, to waive technicalities, and to make an award as deemed in its best interest. It is understood that all bids are made subject to this Agreement, that the County reserves the right to award the bid to the lowest responsive and responsible Bidder, and in arriving at this decision, full consideration will be given to the reputation of the Bidder, his financial responsibility, and work of this type successfully completed.

"J. The County also reserves the right to reject any and all bids from any person, firm, or corporation who is in arrears in any debt or obligation to the Effingham County, Georgia."

Section 102.08

PROPOSAL GUARANTY:

Substitute the following for the first sentence:

"No bid will be considered unless it is accompanied by a certified check or acceptable bid bond in an amount not less than five percent (5%) of the amount bid and made payable to the Board of Commissioners of Effingham County. Such Bid Bond shall be on the forms provided by the County."

Section 102.09

DELIVERY OF PROPOSALS:

Delete in its entirety and substitute the following:

"Bids must be submitted in duplicate in a sealed envelope of sufficient size with the following clearly typed or printed on the outside:

Effingham County Purchasing Agent
Bid for Construction
Bid Number
Date and Hour of Bid Opening
Company Name

Bid shall be submitted on the Bid Form provided by the County.

The bid package as described in Notice to Contractors must be submitted with the bid. Failure to do so could result in the omission of pertinent documents and the rejection of the apparent low bid."

Add Section 102.15

ADDENDA AND INTERPRETATION:

Add the following as 102.15:

"No interpretation of the meaning of the Contract Documents will be made orally to any Bidder. Any request for such interpretation should be in writing addressed to the Office of County Purchasing Agent, 601 North

Laurel Street, Springfield, Georgia 31329. Each such interpretation shall be given in writing, separately numbered and dated, and furnished to each interested Bidder. Any request not received in time to accomplish such interpretation and distribution will not be accepted."

SECTION 103

AWARD OF AND EXECUTION OF CONTRACT

Section 103.02

AWARD OF CONTRACT:

Delete in its entirety and substitute the following:

"The contract, if awarded, shall be awarded to the most responsive and responsible bidder. Effingham County reserves the right to exercise exclusive discretion as to the responsibility of any bidder.

The contract shall be executed on the forms attached, will be subject to all requirements of the Contract Document, and shall form a binding Contract between the contracting parties."

Section 103.04

RETURN OF PROPOSAL GUARANTY:

Delete in its entirety and substitute the following:

All Bid Guaranties may be retained until the Contract and Contract Bond have been signed and approved. Early release of Bid Guaranties will be considered if a request is made in writing.

Section 103.06

EXECUTION AND APPROVAL OF CONTRACT:

Delete in its entirety and substitute the following:

The Contract shall be signed by the successful Bidder and returned within 15 calendar days after the date of the letter transmitting the Contract to the Bidder. No Contract shall be considered as effective until it has been fully executed by all of the parties.

Section 103.07

FAILURE TO EXECUTE CONTRACT:

Delete in its entirety and substitute the following:

"Failure to execute the Contract, Contract Performance and Payment Bond, or furnish satisfactory proof of carriage of the insurance required within ten days after the date of Notice of Award of the Contract may be just cause for the annulment of the award and for the forfeiture of the proposal guaranty to Effingham County, not as a penalty, but as liquidation damages sustained. At the discretion of the County, the award may then be made to the next lowest responsible Bidder, or the Work may be re-advertised or constructed by County forces.

SECTION 104

SCOPE OF WORK

SECTION 104.03.A

AUTHORITY TO MAKE CHANGES:

Delete the second paragraph and substitute the following:

Whenever an alteration in character of work involves a substantial change in the nature of the design or in the type of construction or materially increases or decreases the cost of performance, a Supplemental Agreement acceptable to both parties shall be executed before work is started on such alternation, except that in the absence of a Supplemental Agreement acceptable to both parties, the Engineer may direct that the work be done either by Force Account or at existing Contract prices subject to the provisions of Sub-Section 105.13. Any Force Account Agreement must be in writing, specifying the terms of payment, signed by the State Highway Engineer and agreed to in writing by the Contractor.

All work shall be performed as directed and in accordance with the Specifications.

SECTION 105

CONTROL OF WORK

105.13

CLAIMS FOR ADJUSTMENTS AND DISPUTES:

Retain as written and add the following to Sub-Section 105.13.B.7:

Stand-By Rate will be 50 percent of the operating rate.

SECTION 107

LEGAL REGULATIONS & RESPONSIBILITY TO THE PUBLIC

SECTION 108

PROSECUTION AND PROGRESS

108.01 SUBLETTING OF CONTRACT

Retain this Section as written and add the following:

In accordance with the provisions stated above, the following items are designated Specialty Items whenever they appear in the Contract:

- All Grassing Items
- All Fencing Items
- All Highway Lighting Items
- All Highway Sign Items
- All Guardrail Items (Except Bridge Handrail)
- All Utility Items
- All Comfort and Convenience Facilities in Rest Areas
- All Landscaping Items
- All Pressure Grouting, Slab Removal and Replacement
- All Permanent Traffic Markings
- All Signal Systems
- All Railroad Track work above Sub-ballast
- Construction Layout

The cost of the above items will be subtracted from the original Contract Amount and the subsequent balance used to determine the percent limitation mentioned above.

If the Contractor elects to sublet a Specialty Item, no work on any such Specialty Items shall be begun without prior approval of the necessary Subcontract.

The Contractor's cost for Construction Layout shall be fully documented prior to deduction from the original Contract Amount.

The Contractor is advised that State Law O.C.G.A. 43-14-1 et. Seq. concerning Contractor Licensing Requirements is in effect and applicable to this project.

108.02 NOTICE TO PROCEED:

Retain as written except as follows:

Delete the second paragraph which begins "Within 10 calendar days" and substitute the following:

Within 10 calendar days after the Notice to Proceed has been issued, the Contractor shall begin the work. Contract Time charges for Available Day and Calendar Day projects will begin on the date the Contractor starts to work, or 10 days after the Notice to Proceed, whichever comes first. For Completion Date Projects Contract Time charges shall begin on the day after the Notice to Proceed.

Right-of-Way Acquisition on this project is complete.

The Engineer has the authority to suspend the Work wholly or in part, for as long as he may deem necessary, because of unsuitable weather, or other conditions considered unfavorable for continuing the Work, or for as long as he may deem necessary by reason of failure of the Contractor to carry out orders given, or to comply with any provision of the Contract. If the performance of all or any portion of the Work is suspended or delayed by the Engineer, in writing, for an unreasonable period of time (not originally anticipated, customary, or inherent to the construction industry) and the Contractor believes that additional compensation and/or contract time is due as a result of such

suspension or delay, the Contractor shall submit to the Engineer, in writing, a request for adjustment within 7 calendar days of receipt of the notice to resume work. The request shall set forth the reasons and support for such adjustment.

Upon receipt, the Engineer will evaluate the Contractor's request. If the Engineer agrees that the cost and/or time required for the performance of the Contract has increased as a result of such suspension and the suspension was caused by conditions beyond the control of, and not the fault of, the Contractor, its suppliers, or subcontractors at any approved tier, and not caused by weather, the Engineer will make an adjustment (excluding profit) and modify the Contract in writing accordingly. The Engineer will notify the Contractor of his/her determination whether or not an adjustment of the Contract is warranted.

No contract adjustment will be allowed unless the Contractor has submitted the request for adjustment within the time prescribed.

No contract adjustment will be allowed under this clause to the extent that performance would have been suspended or delayed by any other cause, or for which an adjustment is provided for or excluded under any other term or condition of this Contract

SECTION 109

MEASUREMENT AND PAYMENT

Section 109.07

PARTIAL PAYMENTS:

Delete the first sentence of the second Paragraph under "A. General". Delete Article A, 8.a, b, & d and substitute the following:

a. As long as the gross value of completed work is less than 50% of the total Contract amount, or if the Contractor is not maintaining his construction schedule to the satisfaction of the Engineer, the Department shall retain 10% of the gross value of the completed work as indicated by the current estimate certified by the Engineer for payment.

b. After the gross value of completed work becomes equal to or exceeds 50% of the total Contract amount within a time period satisfactory to the Department, then the total amount to be retained shall be 0% of the gross value of the completed work as indicated by current estimates, until all pay items are substantially completed. When time charges have ceased as defined in 108.07.G and pending final acceptance and final payment, the amount retained may be further reduced at the discretion of the Engineer, subject to agreement by the Contractor and his Surety.

Section 109.08

FINAL PAYMENT:

Delete in its entirety and substitute the following:

"Final Payment: Upon completion by the Contractor of the work, including the receipt of any final written submission of the Contractor and the approval thereof by the Department, the COUNTY will pay the Contractor a sum equal to 100 percent (100%) of the compensation set forth herein, less the total of all previous partial payments, paid or in the process of payment.

The Contractor agrees that acceptance of this final payment shall be in full and final settlement of all claims arising against the COUNTY for work done, materials furnished, costs incurred, or otherwise arising out of this Agreement and shall release the COUNTY from any and all further claims of whatever nature, whether known or unknown for and on account of said Agreement, and for any and all work done, and labor and materials furnished, in connection with same."

SECTION 109.10

INTEREST:

Delete as written and substitute the following:

B. INTEREST: In the event the Contractor fails to execute the Final Supplemental Agreement as prepared by the County because he disputes the amount of the final payment as stated therein, the amount due the Contractor shall be deemed by the Contractor and the Department to be an unliquidated sum and no interest shall accrue or be payable on the sum finally determined to be due to the Contractor for any period prior to final determination of such sum, whether such determination be by agreement of the Contractor and the Department or by final judgment of the proper court in the event of litigation between the Department and the Contractor. The Contractor specifically waives and

renounces any and all rights it may have under Section 13-6-13 of the Official Code of Georgia and agrees that in the event suit is brought by the Contractor against the Department for any sum claimed by the Contractor under the Contract, for delay damages resulting from a breach of contract, for any breach of contract or for any extra or additional work, no interest shall be awarded on any sum found to be due from the Department to the Contractor in the final judgment entered in such suit. All final judgments shall draw interest at the legal rate, as specified by law. Also, the Contractor agrees that notwithstanding any provision or provisions of Chapter 11 of Title 13 of the Official Code of Georgia that the provisions of this contract control as to when and how the Contractor shall be paid for The Work. Further, the Contractor waives and renounces any and all rights it may have under Chapter 11 of Title 13 of the Official Code of Georgia.

SECTION 109.11

PRICE ADJUSTMENTS:

Delete as written and substitute the following:

No price adjustments will be made for this project.

GEORGIA DOT STANDARDS & CONSTRUCTION DETAILS

APPLICABLE FOR THIS PROJECT

	CONSTRUCTION STANDARDS
GA STD 2327	STANDARD REINFORCED CONCRETE BOX CULVERTS (SHEET 1 & 2)
GA STD 4380	STANDARD “W” BEAM GUARDRAIL 31 INCH GUARDRAIL HEIGHT
GA STD 4383	STANDARD GUARDRAIL ANCHORAGE TYPE I 31 INCH GUARDRAIL HEIGHT
GA STD 4381	STANDARD POSTS AND OFFSET BLOCKS FOR “W” & “T” BEAM GAURDRAIL 31 INCH GUARDRAIL HEIGHT
GA STD 9100	TRAFFIC CONTROL GENERAL NOTES, STANDARD LEGEND AND MISCELLANEOUS DETAILS
	GDOT STANDARD SPECIFICATIONS 2013
SECTION 400	HOT MIX ASPHALTIC CONCRETE CONSTRUCTION
SECTION 805	RIPRAP
SECTION 815	GRADED AGGREGATE
SECTION 859	GUARDRAIL
SECTION 919	RAISED PAVEMENT MARKERS

SCOPE OF WORK

GENERAL INFORMATION:

The purpose of this solicitation is to describe the requirements for:

Furnishing all materials, labor and equipment for:

Saw-cutting and removing the existing asphalt paving as shown on the construction plans.

Removing the existing concrete bridge in Honey Ridge Road as shown on the construction plans.

Excavation of materials necessary to construct the new box culvert including one (1') below the new subgrade.

All testing is to be done by a certified Testing Firm using ASTM and shall be paid by the contractor.

Preparation of the subgrade shall be in accordance with the report by Terracon Consultants, Inc. which is attached to and included in this ITB. The contractor shall notify the Engineer in advance of the testing of the subgrade.

Construction of a GDOT Specification Triple 10' X 5' Box Culvert 38' long, parapet to parapet, complete with wing walls and 57 stone base as shown on the construction plans and the report by Terracon Consultants, Inc. Contractor shall notify Engineer when the forms and rebar are in place for inspection before any concrete is poured. Testing Firm shall make at least 3 concrete cylinders of each pour with one break at 7 days, one break at 21 days and one to be kept for future in case of failure.

Backfilling and compaction of material around and over the box culvert to 98% Standard Proctor to the subgrade for Honey Ridge Road.

Repaving and restriping Honey Ridge Road as shown on the construction plans.

Installing GDOT Specification 31" high guardrail as shown on the construction plans.

Designing, installing, maintaining and removing water control dikes to maintain dry conditions in the construction area. This includes any dewatering necessary. Payment for this item is included in the price of the box culvert.

Installation, maintenance and removal of Erosion and Sediment Control structures, including seeding and mulching. Erosion control shall be performed and paid for in accordance with Section 161 of the specifications. Grassing shall be performed and paid for in accordance with Section 700 of the specifications.

Provide traffic control devices to close Honey Ridge Road on both sides of the construction area and provide warning signs of Road Closed Ahead in both directions. Contractor to submit a Traffic Control Plan to the Engineer before construction commences.

Other miscellaneous activities need to deliver a complete product.

Ensure that all construction related activities in places adjacent to environmentally sensitive areas (ESAs) (Easements, staging, vehicular use, borrow or waste activities, construction trailer placement and staging) be restricted to the existing right-of-way.

This project does not require an NOI. Limit land disturbing activities to less than one (1) acre of exposed material.

Work cannot start before 7:00 AM and must be concluded no later than 8:00 PM, Monday thru Saturday.

Safety:

The Contractor shall provide all barricades and signage per the MUTCD and take necessary precautions to protect buildings, general public and Contractor personnel. The Contractor shall at all times guard against damage or loss of

Effingham County property or the general public and shall be held responsible for replacing or repairing any loss or damage to the satisfaction of The Effingham County Board of Commissioners.

GENERAL CONSTRUCTION GUIDELINES:

1. The General Contractor shall be required to perform 100% of the actual construction of the box culvert. Subletting of the additional items (paving, striping, erosion and sediment control structures, guardrail, etc.) shall be in accordance with Section 108.01 of the Standard Specifications of the Georgia Department of Transportation.
2. Control and testing of materials will be the contractor's responsibility. The cost of such testing shall be included in the unit price of the material being used, and no additional compensation will be made.
3. Effingham County does not commit to furnishing full-time inspection or testing of the work in progress or at material sources. Lack of inspection and/or testing by the Effingham will in no way relieve the Contractor of his responsibility to provide quality workmanship in accordance with the Specifications.
4. The contractor shall furnish, install, maintain and remove all necessary traffic signs, barricades, lights, signals, cones and other traffic control devices, and all flagging and other means of traffic protection and guidance as required by the Standard Specifications of the Georgia Department of Transportation. Such work shall be considered incidental to the overall contract, and no additional compensation will be made.
5. The contractor shall re-establish the traffic striping in accordance with the details in the construction plans.

HOT MIX RECYCLED ASPHALTIC CONCRETE:

1. All work shall be performed in accordance with the Georgia Department of Transportation Standard Specifications-Section 402 except where otherwise noted herein:
2. References to "The Department" shall be taken to mean Effingham County or its representative.
3. References to "The Laboratory" shall be taken to mean either the Georgia Department of Transportation's Materials Lab, or a private testing consultant firm approved by Effingham County.
4. It shall be the responsibility of the Contractor to determine the actual composition of the RAP material and to fabricate from that the final asphaltic concrete design(s) and grade of asphalt cement necessary to meet the performance requirements of these Specifications. The contractor shall be responsible for performing daily testing on plant produced asphalt mixes as described in the 2013 Edition of the Georgia Department of Transportation Standard Specifications section 400.3.06. The contractor shall fax these results to inspecting contractor designated by Effingham County by noon of the day following production. Any deficiencies in the material characteristics or performance will be corrected by the Contractor, as provided for in the Specifications, at no additional cost to the Effingham.
5. References to "The Plans" shall be taken to mean the contents of the contract and bid documents, or written supplements to these documents.
6. The work performed and materials furnished, as prescribed by these specifications, will be paid for at Contract Unit Price per ton for the type of mix being placed. This payment shall be full compensation for providing all materials, hauling and necessary crushing, processing, placing, rolling, and finishing of the recycled mixture, and labor, tools, equipment, and incidentals necessary to complete the work, including hauling and stockpiling of any surplus RAP material.

Note: This is a unit price contract. Quantities are approximate and payment shall be for actual in-place work measurements.

Commencement and Completion:

WORK SHALL BEGIN WITHIN 10 DAYS AFTER RECEIPT OF A “NOTICE TO PROCEED”.

ALL WORK SHALL BE COMPLETED WITHIN 90 CALENDAR DAYS AFTER THE TEN DAY PERIOD.

THIS SECTION INTENTIONALLY LEFT BLANK

BID FORM

ARTICLE 1 - BID RECIPIENT

1.01 This Bid is submitted to:

Effingham County Board of Commissioners

1.02 The undersigned Bidder proposes and agrees, if this Bid is accepted, to enter into an Agreement with Owner in the form included in the Bidding Documents to perform all Work as specified or indicated in the Bidding Documents for the prices and within the times indicated in this Bid and in accordance with the other terms and conditions of the Bidding Documents.

ARTICLE 2 - BIDDER’S ACKNOWLEDGEMENTS

2.01 Bidder accepts all of the terms and conditions of the Instructions to Bidders, including without limitation those dealing with the disposition of Bid security. This Bid will remain subject to acceptance for 60 days after the Bid opening, or for such longer period of time that Bidder may agree to in writing upon request of Owner.

ARTICLE 3 - BIDDER’S REPRESENTATIONS

3.01 In submitting this Bid, Bidder represents that:

A. Bidder has examined and carefully studied the Bidding Documents, other related data identified in the Bidding Documents, and the following Addenda, receipt of which is hereby acknowledged:

<u>Addendum No.</u>	<u>Addendum Date</u>
_____	_____
_____	_____
_____	_____

B. Bidder has visited the Site and become familiar with and is satisfied as to the general, local, and Site conditions that may affect cost, progress, and performance of the Work.

C. Bidder is familiar with and is satisfied as to all Laws and Regulations that may affect cost, progress, and performance of the Work.

D. Bidder has considered the information known to Bidder; information commonly known to contractors doing business in the locality of the Site; information and observations obtained from visits to the Site; and the Bidding Documents, with respect to the effect of such information, observations, and documents on (1) the cost, progress, and performance of the Work; (2) the means, methods, techniques, sequences, and procedures of construction to be employed by Bidder, including applying the specific means, methods, techniques, sequences, and procedures of construction expressly required by the Bidding Documents; and (3) Bidder’s safety precautions and programs.

E. Based on the information and observations referred to in Paragraph 3.01.D above, Bidder does not consider that further examinations, investigations, explorations, tests, studies, or data are necessary for the determination of this Bid for performance of the Work at the price(s) bid and within the times required, and in accordance with the other terms and conditions of the Bidding Documents.

- F. Bidder is aware of the general nature of work to be performed by Owner and others at the Site that relates to the Work as indicated in the Bidding Documents.
- G. Bidder has given Engineer written notice of all conflicts, errors, ambiguities, or discrepancies that Bidder has discovered in the Bidding Documents, and the written resolution thereof by Engineer is acceptable to Bidder.
- H. The Bidding Documents are generally sufficient to indicate and convey understanding of all terms and conditions for the performance of the Work for which this Bid is submitted.

ARTICLE 4 - BIDDER'S CERTIFICATION

4.01 Bidder certifies that:

- A. This Bid is genuine and not made in the interest of or on behalf of any undisclosed individual or entity and is not submitted in conformity with any collusive agreement or rules of any group, association, organization, or corporation;
- B. Bidder has not directly or indirectly induced or solicited any other Bidder to submit a false or sham Bid;
- C. Bidder has not solicited or induced any individual or entity to refrain from bidding; and
- D. Bidder has not engaged in corrupt, fraudulent, collusive, or coercive practices in competing for the Contract. For the purposes of this Paragraph 4.01.D:
 - 1. "corrupt practice" means the offering, giving, receiving, or soliciting of anything of value likely to influence the action of a public official in the bidding process;
 - 2. "fraudulent practice" means an intentional misrepresentation of facts made (a) to influence the bidding process to the detriment of Owner, (b) to establish bid prices at artificial non-competitive levels, or (c) to deprive Owner of the benefits of free and open competition;
 - 3. "collusive practice" means a scheme or arrangement between two or more Bidders, with or without the knowledge of Owner, a purpose of which is to establish bid prices at artificial, non-competitive levels; and
 - 4. "coercive practice" means harming or threatening to harm, directly or indirectly, persons or their property to influence their participation in the bidding process or affect the execution of the Contract.

THIS SECTION INTENTIONALLY LEFT BLANK

ARTICLE 5 - BASIS OF BID

HONEY RIDGE ROAD BRIDGE REPLACEMENT					
Item No.	Description	Unit	Estimated Quantity	Bid Unit Price	Bid Price
150-1000	TRAFFIC CONTROL	LS	1	\$	\$
163-0300	CONSTRUCTION EXIT	EA	2	\$	\$
171-0030	TEMPORARY SILT FENCE TYPE C	LF	450	\$	\$
205-0001	R & R UNSUITABLE MATERIAL	CY	4	\$	\$
210-0100	GRADING COMPLETE	LS	1	\$	\$
310-5080	GRADED AGGREGATE BASE 8" THICK	TN	280	\$	\$
402-3100	RECYCLED ASPH CONC 9.5 MM SUPERPAVE, GP 1, INCL BITUM MATL & H LIME (165 LB/SY)	SY	160	\$	\$
402-3190	RECYCLED ASPH CONC 19 MM SUPERPAVE, GP 1 OR GP2, INCL BITUM MATL & H LIME (220 LB/SY)	SY	140	\$	\$
500-1006	CONCRETE STRUCTURE – TRIPLE 10 X 5 BOX CULVERT 38' PARAPET TO PARAPET COMPLETE W/WING WALLS, NEEDLE PUNCHED NON WOVEN GEO FABRIC & 57 STONE BASE	LS	1	\$	\$
540-1101	REMOVAL OF EXISTING BRIDGE	LS	1	\$	\$
603-1050	STONE PLAIN RIP RAP	TN	150	\$	\$
641-1200	GUARDRAIL TYPE W	LF	168	\$	\$
641-5001	GUARDRAIL ANCHOR TYPE I	EA	2	\$	\$
652-5451	SOLID TRAFFIC STRIPE, 5 IN, WHITE	LF	200	\$	\$
652-5452	SOLID TRAFFIC STRIPE, 5 IN, YELLOW	LF	200	\$	\$
654-1002	RAISED PVMT MARKERS TP 2 YELLOW	EA	10	\$	\$
700-6910	PERMANENT GRASSING	AC	0.25	\$	\$
Total of all Bid Prices					\$

Bidder acknowledges that estimated quantities are not guaranteed, and are solely for the purpose of comparison of Bids, and final payment for all unit price Bid items will be based on actual quantities, determined as provided in the Contract Documents.

ARTICLE 6 - TIME OF COMPLETION

- 6.01 Bidder agrees to commence work within ten (10) days after the Notice to Proceed is issued and to complete all Work within **90** calendar days after the 10 day period.
- 6.02 Bidder accepts the provisions of the Agreement as to liquidated damages.

ARTICLE 7 - ATTACHMENTS TO THIS BID

7.01 The following documents are submitted with and made a condition of this Bid:

- A. Required Bid security in the form of _____;
- B. List of Proposed Subcontractors (Attachment G);
- C. Evidence of authority to do business in the state of the Project;
- D. Drug Free Workplace Certification (Attachment A);
- E. Promise of Non Discrimination Statement (Attachment B);
- F. Disclosure of Responsibility Statement (Attachment C);
- G. Bidders Certification Regarding Debarment, Suspension, Ineligibility and Voluntary Exclusion (Attachment H);
- H. Contractor Affidavit and Agreement (E-VERIFY) (Attachment D);
- I. Subcontractor Affidavit if applicable (E-VERIFY) (Attachment E);

ARTICLE 8 - DEFINED TERMS

8.01 The terms used in this Bid with initial capital letters have the meanings stated in the Instructions to Bidders, the General Conditions, and the Supplementary Conditions.

ARTICLE 9 - BID SUBMITTAL

9.01 This Bid is submitted by:

If Bidder is:

An Individual

Name (typed or printed): _____

By: _____
(Individual's signature)

Doing business as: _____

A Partnership

Partnership Name: _____

By: _____
(Signature of general partner -- attach evidence of authority to sign)

Name (typed or printed): _____

A Corporation

Corporation Name: _____ (SEAL)

State of Incorporation: _____
Type (General Business, Professional, Service, Limited Liability): _____

By: _____
(Signature -- attach evidence of authority to sign)

Name (typed or printed): _____

Title: _____
(CORPORATE SEAL)

Attest _____

Date of Qualification to do business in Georgia is ____/____/____.

A Joint Venture

Name of Joint Venture: _____

First Joint Venturer Name: _____ (SEAL)

By: _____
(Signature of first joint venture partner -- attach evidence of authority to sign)

Name (typed or printed): _____

Title: _____

Second Joint Venturer Name: _____ (SEAL)

By: _____
(Signature of second joint venture partner -- attach evidence of authority to sign)

Name (typed or printed): _____

Title: _____

(Each joint venturer must sign. The manner of signing for each individual, partnership, and corporation that is a party to the joint venture should be in the manner indicated above.)

Bidder's Business Address _____

Phone No. _____ Fax No. _____

E-mail _____

SUBMITTED on _____, 20____.

State Contractor License No. _____.

THIS SECTION INTENTIONALLY LEFT BLANK

BID BOND

KNOW ALL MEN BY THESE PRESENTS THAT WE _____ [*Insert contractor's name*], as Principal, hereinafter called the Principal, and (Surety) _____ a corporation duly organized under the laws of the State of _____ as Surety, hereinafter called the Surety, and held and firmly bound unto

Effingham County Board of Commissioners
601 N. Laurel Street,
Springfield, Georgia 31329

as Obligee, hereinafter called Obligee, in the sum of _____ Dollars (\$_____), or percent (**5** %) of the amount bid, whichever is less, for the payment of which sum well and truly to be made, the said Principal and the said Surety, bind ourselves, our heirs, executors, administrators, successors and assigns, jointly and severally, firmly by these presents.

WHEREAS, the Principal has submitted a bid for:

ITB No. 19-25-002 – Honey Ridge Road Bridge Replacement

NOW, THEREFORE, if the Obligee shall accept the bid of the Principal and the Principal shall enter into a Contract with the Obligee in accordance with the terms of such bid and give such bonds or bond as may be specified in the bidding or Contract Documents with good and sufficient surety for the faithful performance of such Contract and for the prompt payment of labor and material furnished in the prosecution thereof, or in the event of the failure of the Principal to enter such Contract and give such bond or bonds, if the Principal shall pay to the Obligee the difference not to exceed the penalty hereof between the amount specified in said bid and such larger amount for which the Obligee may in good faith contract with another party to perform the Work covered by said bid, then this obligation shall be null and void, otherwise to remain in full force and effect.

Signed and Sealed this _____ day of _____, 20_____.

(Principal)

By:

(Witness) (Title)

**AGREEMENT
BETWEEN OWNER AND CONTRACTOR
FOR CONSTRUCTION CONTRACT**

THIS AGREEMENT is by and between Effingham County Board of Commissioners (“Owner”) and _____ (“Contractor”).

Owner and Contractor hereby agree as follows:

ARTICLE 1 – WORK

Contractor shall complete all Work as specified or indicated in the Contract Documents. The Work is generally described as follows: an estimated 170,900 linear feet (LF) of road way for restriping, 189,100 linear feet (LF) of road way for two foot widening, RPM installation, and sign replacement for all roads in the Unincorporated Area of Effingham County. There is also an estimated 9,300 linear feet (LF) of roadway resurfacing on Blue Jay Road, as further described below.

1.01 *The Project*

The Project for which the Work under the Contract Documents may be the whole or only a part is generally described as follows: **ITB No. 19-25-002 – Honey Ridge Road Bridge Replacement**

ARTICLE 2 – ENGINEER

2.01 The Project has been designed by Effingham County Engineering Department, which is to act as Owner’s representative, assume all duties and responsibilities, and have the rights and authority assigned to Engineer in the Contract Documents in connection with the completion of the Work in accordance with the Contract Documents.

ARTICLE 3 – CONTRACT TIMES

3.01 *Time of the Essence*

All time limits for Milestones, if any, Substantial Completion, and completion and readiness for final payment as stated in the Contract Documents are of the essence of the Contract.

3.02 *Days to Achieve Completion and Final Payment*

3.02 *The Work will be completed within 90 calendar days after the date of the Notice to Proceed.*

ARTICLE 4 – LIQUIDATED DAMAGES

4.01 Contractor and Owner recognize that time is of the essence as stated in Paragraph 3.01 above and that Owner will suffer financial loss if the Work is not completed within the times specified in Paragraph 3.02 above, plus any extensions thereof allowed. The parties also recognize the delays, expense, and difficulties involved in proving in a legal or arbitration proceeding the actual loss suffered by Owner if the Work is not completed on time. Accordingly, instead of requiring any such proof, Owner and Contractor agree that as liquidated damages for delay (but not as a penalty), Contractor shall pay Owner **\$250** for each day that expires after the time specified in Paragraph 4.02 above for Completion until the Work is complete.

ARTICLE 5 – CONTRACT PRICE

5.01 Owner shall pay Contractor for completion of the Work in accordance with the Contract Documents an amount in current funds equal to the sum of the amounts determined pursuant to Paragraphs 5.01.A, below: *For all Unit Price Work, an amount equal to the sum of the established unit price for each separately identified item of Unit Price Work times the actual quantity of that item:*

HONEY RIDGE ROAD BRIDGE REPLACEMENT					
Item No.	Description	Unit	Estimated Quantity	Bid Unit Price	Bid Price
150-1000	TRAFFIC CONTROL	LS	1	\$	\$
163-0300	CONSTRUCTION EXIT	EA	2	\$	\$
171-0030	TEMPORARY SILT FENCE TYPE C	LF	450	\$	\$
205-0001	R & R UNSUITABLE MATERIAL	SY	4	\$	\$
210-0100	GRADING COMPLETE	LS	1	\$	\$
310-5080	GRADED AGGREGATE BASE 8" THICK	TN	240	\$	\$
402-3100	RECYCLED ASPH CONC 9.5 MM SUPERPAVE, GP 1, INCL BITUM MATL & H LIME (165 LB/SY)	SY	160	\$	\$
402-3190	RECYCLED ASPH CONC 19 MM SUPERPAVE, GP 1 OR GP2, INCL BITUM MATL & H LIME (220 LB/SY)	SY	140	\$	\$
500-1006	CONCRETE STRUCTURE – TRIPLE 10 X 5 BOX CULVERT 38' PARAPET TO PARAPET COMPLETE W/WING WALLS, NON WOVEN NEEDLE PUNCHED GEO FABRIC & 57 STONE BASE	LS	1	\$	\$
540-1101	REMOVAL OF EXISTING BRIDGE	LS	1	\$	\$
603-1050	STONE PLAIN RIP RAP	TN	50	\$	\$
641-1200	GUARDRAIL TYPE W	LS	1	\$	\$
641-5001	GUARDRAIL ANCHOR TYPE I	LS	1	\$	\$
652-5451	SOLID TRAFFIC STRIPE, 5 IN, WHITE	LF	200	\$	\$
652-5452	SOLID TRAFFIC STRIPE, 5 IN, YELLOW	LF	200	\$	\$
700-6910	PERMANENT GRASSING	AC	0.25	\$	\$
Total of all Bid Prices					\$

The Bid prices for Unit Price Work set forth as of the Effective Date of the Agreement are based on estimated quantities. Estimated quantities are not guaranteed, and determinations of actual quantities and classifications are to be made by Engineer.

ARTICLE 6 – PAYMENT PROCEDURES

6.01 Submittal and Processing of Payments

- A. Contractor shall submit Applications for Payment in accordance with Section 1.30 of the General Conditions. Applications for Payment will be processed by Engineer as provided in the General Conditions.

6.02 Progress Payments; Retainage

- A. Owner shall make progress payments on account of the Contract Price on the basis of Contractor's Applications for Payment on or about the **25th** day of each month during performance of the Work as provided in Paragraph 6.02.A.1 below as long as the pay request is received by the **1st** of the month. All such payments will be measured based on the number of units completed times the unit price of each completed unit.

- 1. Prior to Substantial Completion, progress payments will be made in an amount equal to the percentage indicated below but, in each case, less the aggregate of payments previously made and less such amounts as Engineer may determine or Owner may withhold, including but not limited to liquidated damages, in accordance with Paragraph 4.01 above.

- a. **90** percent of Work completed (with the balance being retainage). Until 50% of the value of the contract (including change orders and additions), or if the Contractor fails to maintain his construction schedule to the satisfaction of the Engineer, the County will retain 10% of the gross value of the completed work as indicated by the current estimate approved by the Engineer. After the contract (including change orders and additions) is 50% complete, there shall be no additional retainage withheld unless the work is determined to be unsatisfactory or has fallen behind schedule; and

- b. **90** percent of cost of materials and equipment not incorporated in the Work (with the balance being retainage).

- B. Upon Substantial Completion, Owner shall pay an amount sufficient to increase total payments to Contractor to **100** percent of the Work completed, less such amounts as Engineer shall determine and less **150** percent of Engineer's estimate of the value of Work to be completed or corrected as shown on the tentative list of items to be completed or corrected.

6.03 Final Payment

- A. Upon final completion and acceptance of the Work, Owner shall pay the remainder of the Contract Price as recommended by Engineer.

ARTICLE 7 – INTEREST

7.01 All moneys not paid when due as provided in Section 1.30 of The General Conditions and Paragraph 6.02 above, shall bear interest at the rate of 1 percent per annum.

ARTICLE 8 – CONTRACTOR’S REPRESENTATIONS

8.01 In order to induce Owner to enter into this Agreement, Contractor makes the following representations:

- A. Contractor has examined and carefully studied the Contract Documents and the other related data identified in the Bidding Documents.
- B. Contractor has visited the Site and become familiar with and is satisfied as to the general, local, and Site conditions that may affect cost, progress, and performance of the Work.
- C. Contractor is familiar with and is satisfied as to all federal, state, and local Laws and Regulations that may affect cost, progress, and performance of the Work.
- D. Contractor has considered the information known to Contractor; information commonly known to contractors doing business in the locality of the Site; information and observations obtained from visits to the Site; the Contract Documents; and the Site-related reports and drawings identified in the Contract Documents, with respect to the effect of such information, observations, and documents on (1) the cost, progress, and performance of the Work; (2) the means, methods, techniques, sequences, and procedures of construction to be employed by Contractor, including any specific means, methods, techniques, sequences, and procedures of construction expressly required by the Contract Documents; and (3) Contractor’s safety precautions and programs. Based on the information and observations referred to in Paragraph 8.01.D above, Contractor does not consider that further examinations, investigations, explorations, tests, studies, or data are necessary for the performance of the Work at the Contract Price, within the Contract Times, and in accordance with the other terms and conditions of the Contract Documents.
- E. Contractor is aware of the general nature of work to be performed by Owner and others at the Site that relates to the Work as indicated in the Contract Documents.
- F. Contractor has given Engineer written notice of all conflicts, errors, ambiguities, or discrepancies that Contractor has discovered in the Contract Documents, and the written resolution thereof by Engineer is acceptable to Contractor.
- G. The Contract Documents are generally sufficient to indicate and convey understanding of all terms and conditions for performance and furnishing of the Work.

ARTICLE 9 – CONTRACT DOCUMENTS

9.01 *Contents*

- A. The Contract Documents consist of the following:
 - 1. This Agreement (pages 1 to 8, inclusive).

2. General Conditions (pages 1 to 8, inclusive).
 3. Supplemental Conditions (pages 1 to 8, inclusive).
 4. Specifications as listed in the table of contents of the Project Manual.
 5. Addenda (numbers _____ to _____, inclusive).
 6. Exhibits to this Agreement (enumerated as follows):
 - a. Contractor's Bid (pages 1 to 6, inclusive).
 - b. Documentation submitted by Contractor prior to Notice of Award (pages _____ to _____, inclusive).
 - c. Drawings (pages 1 to 12, inclusive)
 - d. Culvert Foundation Investigation Report (pages 1 to 15, inclusive)
 7. The following which may be delivered or issued on or after the Effective Date of the Agreement and are not attached hereto:
 - a. Notice to Proceed (pages 1 to 1, inclusive).
 - b. Work Change Directives.
 - c. Change Orders.
- B. The documents listed in Paragraph 9.01.A are attached to this Agreement (except as expressly noted otherwise above).
- C. There are no Contract Documents other than those listed above in this Article 9.
- D. The Contract Documents may be amended to provide for additions, deletions, and revisions in the Work or to modify the terms and conditions thereof by either a Change Order or a Work Change Directive.
- E. The requirements of the Contract Documents may be supplemented, and minor variations and deviations in the Work may be authorized, by one or more of the following ways:
- A Field Order;
1. Engineer's approval of a Shop Drawing or Sample; or
 2. Engineer's written interpretation or clarification.

ARTICLE 10 – MISCELLANEOUS

10.01 *Terms*

- A. Terms used in this Agreement will have the meanings stated in the General Conditions and the Supplementary Conditions.

10.02 *Assignment of Contract*

- A. No assignment by a party hereto of any rights under or interests in the Contract will be binding on another party hereto without the written consent of the party sought to be bound; and, specifically but without limitation, moneys that may become due and moneys that are due may not be assigned without such consent (except to the extent that the effect of this restriction may be limited by law), and unless specifically stated to the contrary in any written consent to an assignment, no assignment will release or discharge the assignor from any duty or responsibility under the Contract Documents.

10.03 *Successors and Assigns*

- A. Owner and Contractor each binds itself, its partners, successors, assigns, and legal representatives to the other party hereto, its partners, successors, assigns, and legal representatives in respect to all covenants, agreements, and obligations contained in the Contract Documents.

10.04 *Severability*

- A. Any provision or part of the Contract Documents held to be void or unenforceable under any Law or Regulation shall be deemed stricken, and all remaining provisions shall continue to be valid and binding upon Owner and Contractor, who agree that the Contract Documents shall be reformed to replace such stricken provision or part thereof with a valid and enforceable provision that comes as close as possible to expressing the intention of the stricken provision.

10.05 *Contractor's Certifications*

- A. Contractor certifies that it has not engaged in corrupt, fraudulent, collusive, or coercive practices in competing for or in executing the Contract. For the purposes of this Paragraph 10.05:
 - 1. “corrupt practice” means the offering, giving, receiving, or soliciting of anything of value likely to influence the action of a public official in the bidding process or in the Contract execution;
 - 2. “fraudulent practice” means an intentional misrepresentation of facts made (a) to influence the bidding process or the execution of the Contract to the detriment of Owner, (b) to establish Bid or Contract prices at artificial non-competitive levels, or (c) to deprive Owner of the benefits of free and open competition;

3. “collusive practice” means a scheme or arrangement between two or more Bidders, with or without the knowledge of Owner, a purpose of which is to establish Bid prices at artificial, non-competitive levels; and
4. “coercive practice” means harming or threatening to harm, directly or indirectly, persons or their property to influence their participation in the bidding process or affect the execution of the Contract.

THIS SECTION INTENTIONALLY LEFT BLANK

ITB No. 19-25-002 – Honey Ridge Road Bridge Replacement

IN WITNESS WHEREOF, Owner and Contractor have signed this Agreement. Counterparts have been delivered to Owner and Contractor. All portions of the Contract Documents have been signed or have been identified by Owner and Contractor or on their behalf.

This Agreement will be effective on _____ (which is the Effective Date of the Agreement).

OWNER:

Effingham County Board of Commissioners

By: _____

Title: Chairman

Attest: _____

Title: County Clerk

Address for giving notices:

601 N. Laurel Street
Springfield, GA 31329

CONTRACTOR:

By: _____

Title: _____

(If Contractor is a corporation, a partnership, or a joint venture, attach evidence of authority to sign.)

Attest: _____

Title: _____

Address for giving notices:

NOTICE TO PROCEED

TO:

RE: NOTICE TO PROCEED – CONSTRUCTION

ITB No. 19-25-002 – Honey Ridge Road Bridge Replacement

Gentlemen:

Please consider this your NOTICE TO PROCEED on the above referenced project. In accordance with the terms of the contract, work is to commence within ten (10) days of receipt of the Notice to Proceed and to be completed within 90 calendar days from that time. Failure to complete the work by this time/date will result in deductions from the monies due the contractor as “liquated” damages in an amount equal to \$250.00 per calendar day. Requests for time extensions shall be documented and made in writing within 7 calendar days after the delay.

Dated this ____ day of _____, 2018

Effingham County Board of Commissioners

Wesley Corbitt, Chairman

ACCEPTANCE OF NOTICE:

Receipt of the above Notice to Proceed is acknowledged.

Contractor: _____

By: _____

Title: _____

Date of Acceptance: _____

**DEPARTMENT OF TRANSPORTATION
STATE OF GEORGIA**

SPECIAL PROVISION

Section 150—Traffic Control

150.1 General Description

This section, as supplemented by the Plans, Specifications, and Manual on Uniform Traffic Control Devices (MUTCD) shall be considered the Temporary Traffic Control (TTC) Plan in accordance with Work Zone Safety and Mobility Policy. Activities shall consist of furnishing, installing, maintaining, and removing necessary traffic signs, pedestrian signs, barricades, lights, signals, cones, pavement markings and other traffic control devices and shall include flagging and other means for guidance and protection of vehicular and pedestrian traffic through the Work Zone. This Work shall include both maintaining existing devices and installing additional devices as necessary in construction work zones.

The contractor shall be responsible for the maintenance of traffic signals and Advanced Traffic Management system (ATMs) devices from the time that the system is modified until final acceptance. The maintenance of traffic signals and ATMs devices that are not a part of the work and that are not in conflict with any portion of the work shall not be the responsibility of the contractor. However, the contractor is still responsible for damages to all devices that he or his subcontractors cause, in accordance with Section 107 and other specifications.

When any provisions of this Specification or the Plans do not meet the minimum requirements of the MUTCD, the MUTCD shall control. The 2009 Edition of the MUTCD shall be in effect for the duration of the project.

All traffic control devices used during the construction of the project shall meet the standards utilized in the MUTCD, and shall comply with the requirements of these Specifications, Georgia Construction Standards and Details, Project Plans, Design Manuals, and Special Provisions.

The needs and control of all road users (motorists, bicyclists and pedestrians within the highway right-of-way and easements, including persons with disabilities in accordance with the Americans with Disabilities Act of 1990 (ADA), Title II, Paragraph 35.130) through a Temporary Traffic Control (TTC) zone shall be an essential part of highway construction, utility work, maintenance operations and management of traffic incidents.

Utilities included in the contract are bounded by Special Provision 150 and shall follow its requirements. For utilities not included in the contract but working within the project limits, they shall, at a minimum follow the MUTCD. Moreover, in accordance with Utility Accommodation Policy and Standards Manual dated 2016, the Engineer reserves the right to require additional certified flaggers, signs, warning lights, channelization devices, and other safety devices as may be necessary to properly protect, warn, and safeguard the traveling public. In addition, the Department reserves the right to place time restrictions or moratoriums on all utility work covered under a permit when, in the opinion of the Department, the continuance of the Work would seriously hinder traffic flow, be needlessly disruptive, or would unnecessarily inconvenience the traveling public. In case of emergencies, Utilities shall be provided access in accordance with Utility Accommodation Policy and Standard Manual.

150.1.01 Definitions

For Special Provision 150, the definitions for “shall”, “ should”, and “may” will be in accordance with MUTCD (1A.13).

Shall (Standard) - a statement of required, mandatory, or specifically prohibitive practice regarding a traffic control device.

Should (Guidance) - a statement of recommended, but not mandatory, practice in typical situations, with deviations allowed if engineering judgment or engineering study indicates the deviation to be appropriate.

May (Option) — a statement of practice that is a permissive condition and carries no requirement or recommendation.

150.1.02 Content

150.1 General Description

150.1.01 Definitions

150.1.02 Content

150.1.03 Related References

A. Standard Specification

B. Reference Documents

150.1.04 Submittals/Preconstruction

A. Worksite Traffic Control Supervisor

B. Sequence of Operations

C. Pedestrian Considerations

1. Pedestrian Signage

2. Temporary Pedestrian Facilities

150.2 Materials and Traffic Control Devices

150.2.01 Traffic Control Devices

A. NCHRP 350 and MASH

B. Approval

C. Quality Guidelines for All Temporary Traffic Devices

150.2.02 Reflectorization Requirements

A. Signs

1. For All Projects Let Prior to and Including April/May 2018

1. For All Projects Let Prior to and Including April/May 2018

B. Channelization Devices

1. For All Projects Let Prior to and Including April/May 2018
2. For All Projects Let Prior to and Including April/May 2018

150.2.03 Arrow Panels

150.2.04 Channelization Devices

A. General

B. Drums

1. Design
2. Application
3. Longitudinal Channelization
4. Removal

C. Vertical Panels

1. Design
2. Application

D. Cones

1. Design
2. Applications

E. Barricades

1. Design
2. Application

F. Warning Lights

1. Design
2. Application

150.2.05 Flashing Beacon

150.2.06 Guardrail

150.2.07 Interim Signs

A. Posts

B. Sign Blanks and Panels

150.2.08 Pavement Markings

- A. All Traffic Striping for Forty-Five (45) Days or Less (≤ 45 Days)
- B. All Temporary Striping Beyond Forty-Five (45) days (>45 Days)
- C. All Temporary Traffic Striping on Final Surface

150.2.09 Portable Changeable Message Signs

150.2.10 Portable Impact Attenuators

150.2.11 Portable Temporary Traffic Control Signals

150.2.12 Raised Pavement Markers

150.2.13 Rumble Strips

150.2.14 Temporary Barriers

A. Design

B. Application

150.2.15 Temporary Guardrail Anchorage- Type 12

150.2.16 Temporary Traffic Signal

150.3 Construction Requirements

150.3.01 General

A. Implementation Requirements

B. Maintenance of Traffic Control Devices

C. Traffic Interruption Restrictions

D. Work Zone Restrictions

1. Interstate

2. Non-Interstate Divided Highways

3. Non-Divided Highways

E. Work Zone Geometric Restrictions

F. Clear Zone

G. Milled Surface Restrictions

H. Construction Vehicle

I. Environmental Impacts

J. Existing Street Lights

K. Nighttime Work Lighting

L. Removal/Reinstallation of Miscellaneous Items

150.3.02 Personnel – Worker Safety Apparel

150.3.03 Signage – General

A. Signing Requirements of the Temporary Traffic Control (TTC) Plan

B. Conflicting or Non-Applicable Signs

C. Removal of Existing Signs and Supports

D. Interim Guide, Warning and Regulatory Signs

E. Existing Special Guide Signs

1. Special Guide Signs

2. Interim Special Guide Signs

3. Interim Overhead Guide Sign Structures

4. Permanent Special Guide Signs

F. Stop Sign Regulated Intersections

G. Low Shoulder Signage

1. Low Shoulder for Construction/Reconstruction/Resurfacing Projects
2. Shoulder Drop-Off for Construction/Reconstruction/Resurfacing Project

H. Bump Signage

I. Sign Visibility

150.3.04 Advance Warning Signs

A. Project Signs - All Type of Highways

1. State Routes
2. Interstate, Limited Access and Multilane Divided Highways
3. Ramp Work on Limited Access Highways

B. Highway Work Zone

1. No Reduction in the Existing Posted Speed Limit in Highway Work Zone
2. Reducing the Speed Limit in a Highway Work Zone
3. Variable Speed Limit Zones

C. Installation/Removal of Work Area Signage

150.3.05 Shoulder/Lane Closure

A. Approval/Restrictions

1. Closure Length
2. Duration

B. Shoulder Closure

C. Lane Closure

1. Advance Warning Signs
2. Transition Area – Taper
3. Activity Area
4. Termination Area

D. Removal of Lane Closures

E. Exit and Entrance Ramps

150.3.06 Traffic Pacing Method

A. Pacing Of Traffic

B. Methods of Signing For Traffic Pacing

150.3.07 Flagging Operation

A. Flaggers

B. Flagger Certification

C. Flagger Appearance and Equipment

D. Flagger Warning Signs

E. Pilot Vehicle Requirements

F. Automated Flagger Assistance Devices

G. Portable Temporary Traffic Control Signals

150.3.08 Traffic Signals

- A. Responsibility/Cost
- B. Law Enforcement Officer Requirement

150.3.09 Mobile Operations

150.3.10 Pavement Markings

A. General

- 1. Resurfacing Projects
- 2. Widening and Reconstruction Projects
- 3. New Location Construction Projects

B. Installation and Removal of Pavement Markings

- 1. Installation
- 2. Removal
- 3. Intermediate Surface
- 4. Final Surface
- 5. Pay Factor Reduction for Asphaltic Concrete Final Surfaces
- 6. Preparation and Planning for Traffic Shifts

C. Raised Pavement Markers

- 1. Supplementing Lane Lines
- 2. Supplementing Ramp Gore Lines
- 3. Other Lines

D. Exceptions for Interim Markings

- 1. Two-Lane, Two-Way Roadway
- 2. Multi-Lane Highway – with No Paved Shoulder(s) or Paved Shoulder(s) Four Feet or Less ($\leq 4'$)
- 3. Limited Access Roadways and Roadways with Paved Shoulder Greater than Four Feet ($>4'$)
- 4. Ramps for Multi-lane Divided Highways
- 5. Miscellaneous Pavement Markings

150.3.11 Differences in Elevation between Travel Lanes and Shoulders

A. Differences in Elevations

- 1. Difference of Two Inches ($\leq 2''$) or Less Between Adjacent Travel Lanes
- 2. Difference of Two Inches ($\leq 2''$) or Less Between Adjacent Travel Lane and Paved Shoulder Should
- 3. Difference of Greater Than Two Inches ($>2''$) is Permitted for Continuous Operations
- 4. Difference of Greater Than Two Inches ($>2''$) Between Travel Lanes and/or Shoulders for Non-Continuous Operations

B. Healed Section

C. Emergency Situations

D. Plating

E. Asphaltic Concrete Resurfacing Projects

1. Shoulder Construction Included as a Part of the Contract
2. Shoulder Construction Not Included as a Part of the Contract

150.3.12 Work Zone Law Enforcement

150.4 Measurement

150.4.01 Traffic Control Items

- A. Traffic Control
- B. Changeable Message Sign, Portable
- C. Flashing Beacon Assembly
- D. Pavement Markings
- E. Portable Impact Attenuators
- F. Signs

1. Interim Ground Mounted or Interim Overhead Special Guide Signs
2. Remove And Reset Existing Special Guide Signs, Ground Mount or Overhead
3. Modify Special Guide Signs, Ground Mount or Overhead

- G. Temporary Audible Information Device
- H. Temporary Barrier
- I. Temporary Curb Cut Wheelchair Ramps
- J. Temporary Guardrail Anchorage, Type 12
- K. Temporary Walkways with Detectable Edging
- L. Traffic Signal Installation - Temporary
- M. Work Zone Law Enforcement

150.5 Payment

150.5.01 Enforcement and Adjustments

150.1.03 Related References

A. Standard Specifications

Section 104-Scope of Work

Section 105-Legal Regulations and Responsibility to the Public

Section 107-Legal Regulations and Responsibly to the Public

Section 108-Prosecution and Progress

Section 209-Subgrade Construction

Section 400-Hot Mix Asphaltic Concrete Construction

Section 441-Miscellaneous Concrete

Section 429-Rumble Strips

Section 620-Temporary Barrier

Section 632-Portable Changeable Message Signs

Section 641-Guardrail

Section 647-Traffic Signal Installation

Section 648-Traffic Impact Attenuator

Section 652-Painting Traffic Stripe

Section 653 – Thermoplastic Traffic Stripe

Section 654-Raised Pavement Markers

Section 656-Removal of Pavement Markings

Section 657 – Preformed Plastic Pavement Markings

Section 658 – Standard and Wet Weather Polyurea Traffic Stripe

Section 659 Hot Applied Preformed Plastic Pavement Markings

Section 911-Sign Posts

Section 912-Sign Blanks and Panels

Section 913 - ReflectORIZING Materials

B. Referenced Documents

ASTM D4956-13 (Retro-reflectivity)

American Traffic Safety Services Association (ATSSA)

Construction Detail A-3 Curb Cut (Wheelchair) Ramps Concrete Sidewalk Details

Construction Detail A-4 Detectable Warning Surface Truncated Dome Size, Spacing and Alignment Requirements

Construction Detail T-3A (Type 7, 8, and 9 Square Tube Post Installation Detail)

GDOT Signing and Marking Design Guidelines

Georgia Standard 4000W “Lengths of Advancement, Clear Zone Distances, Fill Height Embankment”

Georgia Standard 4960 “Temporary Barrier (End Treatment Options)”

Georgia Standard 9102 “Traffic Control Detail for Lane Closure on Two-Lane Highway”

Georgia Standard 9106 “Traffic Control Detail for Lane Closure on Multi-Lane Divided Highway”

Georgia Standard 9107 “Traffic Control Detail for Lane Closure on Multi-Lane Undivided Highway”

Georgia Standard 9121 “Tapers, Signs, and Markings for Passing Lanes”

Manual for Assessing Safety Hardware (MASH)

Manual on Uniform Traffic Control Devices (MUTCD)

National Cooperative Highway Research Program (NCHRP) 350

National Safety Council

Quality Product List #29 (QPL-29) Reflective Sheeting

Quality Product List #34 (QPL-34) Work Zone Traffic Control Devices (Drums, Type III Barricades, Vertical Panels, and Portable Sign Systems)

Quality Product List #35 (QPL-35) Drive Type Galvanized Steel Sign Posts

Quality Product List #46 (QPL-46) Traffic Pavement Markings

Quality Product List #64 (QPL-64) Attenuator Units (Compression Crash Cushion) and Guardrail End Treatments

Quality Product List #76 (QPL-76) Raised Pavement Markers and Channel Markers

Quality Product List #79 (QPL -79) Portable Arrow Boards

Quality Product List #82 (QPL -82) “Portable Changeable Message Signs”

Utility Accommodation Policy and Standards Manual

Work Zone Safety and Mobility Policy

150.1.04 Submittals/Preconstruction

A. Worksite Traffic Control Supervisor

The Contractor shall designate a qualified individual as the Worksite Traffic Control Supervisor (WTCS). The WTCS shall be responsible for selecting, installing and maintaining all traffic control devices in accordance with the Plans, Specifications, Special Provisions and the MUTCD. The WTCS shall be currently certified by the American Traffic Safety Services Association (ATSSA) Work Site Traffic Supervisor Certification program or the National Safety Council Certification program. On-line classes will not be accepted.

The WTCS shall be available on a twenty-four (24) hour basis to perform his duties. If the work requires traffic control activities to be performed during the daylight and nighttime hours, it may be necessary for the Contractor to designate an alternate WTCS. An alternate WTCS must meet the same requirements and qualifications as the primary WTCS and be accepted by the Engineer prior to beginning any traffic control duties. The Worksite Traffic Control Supervisor's traffic control responsibilities shall have priority over all other assigned duties.

As the representative of the Contractor, the WTCS shall have full authority to act on behalf of the Contractor in administering the TTC Plan. The WTCS shall have appropriate training in safe traffic control practices in accordance with Part 6 of the MUTCD. In addition to the WTCS, all other individuals making decisions regarding traffic control shall meet the training requirements of the Part 6 of the MUTCD.

The Worksite Traffic Control Supervisor (WTCS) shall have a copy of Part 6 of the MUTCD and the Contract on the job site. Copies of the current MUTCD may be obtained from the FHWA web page at <http://mutcd.fhwa.dot.gov>.

The WTCS shall supervise the initial installation of traffic control devices. The Engineer, prior to the beginning of construction, will review the initial installation. Modifications to traffic control devices as required by sequence of operations or staged construction shall be reviewed by the WTCS.

Any work performed on the interstate or limited access highway right-of-way that requires traffic control shall be supervised by a submitted/approved certified Worksite Traffic Control Supervisor. No work requiring traffic control shall be performed unless the certified WTCS is on the worksite. Failure to maintain a Certified Worksite Traffic Control Supervisor on the work will be considered as non-performance under Subsection 150.5.01.

The WTCS or alternate WTCS shall be available on a full-time basis to maintain traffic control devices with access to all personnel, materials, and equipment necessary to respond effectively to an emergency situation within forty-five (45) minutes of notification of the emergency.

The WTCS shall perform inspections, at a minimum once a month, to ensure that traffic control is maintained. For all interstate and limited access highways, the WTCS shall perform, as a minimum, weekly traffic control inspections. The inspections will start with the installation of the advance warning signs and will stop when a maintenance acceptance is issued or when the punch list is completed.

An inspection shall include both daytime and nighttime reviews. The inspection shall be reported to the Engineer on a Traffic Control Inspection Report, (TC-1). Unless modified by the special conditions or by the Engineer, routine deficiencies shall be corrected within a twenty-four (24) hour period. Failure to comply with these provisions shall be grounds for dismissal from the duties of WTCS and/or removal of the WTCS from the project. Failure of the WTCS to execute his duties shall be considered as non-performance under Subsection 150.5.01.

TRAFFIC CONTROL INSPECTION REPORT (TC-1)

Project No.: _____ County: _____

Contractor: _____ Date: _____ Daytime: _____

Nighttime: _____

PURPOSE: To provide adequate warning, delineation, and channelization to assist in guiding road users in advance of and through the work zone by utilizing proper pavement markings, signs, and other MUTCD compliant devices.

RESPONSIBILITY: The Worksite Traffic Control Supervisor (WTCS) has the duty of ensuring that all traffic control devices are installed and maintained according to the requirements of the Traffic Control Plan.

DEFICIENCIES: Items noted below required corrective measures be performed with the next _____ hours/days.

<u>LOCATION</u>	<u>DESCRIPTION</u>	<u>ACTION REQUIRED</u>

(use additional sheets if needed)

Signature: _____ WTCS or DOT performing inspection

DOT inspection presented to WTCS Date: _____ Time: _____

TO BE COMPLETED BY THE WTCS

The attached deficiencies were corrected by Date: _____ Time: _____

Signature _____ Return TC-1 to DOT inspector.

The WTCS certifies that all traffic control devices in use on the project are MASH/NCHRP 350 crashworthy compliant.

Traffic Control Checklist

Satisfactory Unsatisfactory Non-applicable

Signs

 S U N

- Are the signs correctly installed?
- Signs are in place according to TTC plans. Signs are plumb and level. Signs are at the proper height.
- Are the signs visible and readable to the public both daytime and nighttime?
- Is retroreflectivity good?
- Are signs not in use including PCMS properly stored?

TTC Devices

 S U N

- Are they MASH/NHCRP 350 approved? Do they meet MUTCD and Special Provision 150 requirements?
- Are they installed according to manufacture recommendation?
- Are they in acceptable/marginal condition? Are they stable? Is the retroreflectivity good?

Clear Zone

 S U N

- Are all material and equipment stored beyond the clear zone?
- If stored in clear zone, are they protected by positive barrier?
- Are drop-off marked and healed according to Special Provision 150?

Positive Barriers

 S U N

- Are the barriers in acceptable/marginal condition and FHWA approved?
- Are the barrier reflectors proper and in good condition?
- Do the barriers extend to the proper advancement length? Are the tapers according to GA Standards?

Attenuators and Guardrails

 S U N

- Are the proper attenuators assemblies in use?
- Gating Is the recovery area free of debris and provide the necessary recovery area?
- Is the assembly in accordance with manufacture recommendation?
- Are the guardrails properly anchor and/or attached to the barrier?
- Are shoes and transition sections in accordance with Standards?

Pavement Markings

 S U N

- Are the pavement markings visible and legible?
- Can they be seen during the daytime and nighttime?
- Are there no conflicting pavement markings?
- Are the pavement markings including RPM installed and maintained according to section 150?

The Engineer will periodically review the work for compliance with the requirements of the TTC plan.

On projects where traffic control duties will not require full time WCTS supervision, the Engineer may allow the Contractor's Project superintendent, foreman, subcontractor, or other designated personnel to serve as the WTCS as long as satisfactory results are obtained. Nevertheless, the individual shall meet the requirements and perform the duties of a WTCS.

B. Sequence of Operations

Any Sequence of Operations provided in this Contract in conjunction with any staging details which may be shown in the plans, is a suggested sequence for performing the Work. It is intended as a general staging plan for the orderly execution of the work while minimizing the impact on pedestrian facilities, mainline, cross-streets and side streets. The Contractor shall develop detailed staging and temporary traffic control plans for performing specific areas of the Work including but not limited to all traffic shifts, detours, bridge widenings, paces, or other activities that disrupt traffic or pedestrian flow. The Engineer may require detailed staging and TTC plans for lane closures or disruption to pedestrian facilities. These plans shall be submitted for approval at least two (2) weeks prior to the scheduled date of the activity. Activities that have not been approved at least seven (7) days prior to the scheduled date shall be rescheduled.

Where traffic is permitted through the work area under stage construction, the Contractor may choose to construct, at no additional expense to the Department, temporary on-site bypasses or detours in order to expedite the work. Plans for such temporary bypasses or detours shall be submitted to the Engineer for review and approval thirty (30) calendar days prior to the proposed construction. Such bypasses or detours shall be removed promptly when in the opinion of the Engineer; they are no longer necessary for the satisfactory progress of the Work. Bypasses and detours shall meet the minimum requirements of Subsection 150.3.01.D.

As an option to the Sequence of Operations in the Contract, the Contractor may submit an alternative Sequence of Operations for review and approval. Alternate Sequence of Operations for pedestrian facilities shall be in compliance with the MUTCD and ADA. Pedestrian needs identified in the preconstruction phase shall be included in the proposed alternate plan.

The Department will not pay, or in any way, reimburse the Contractor for claims arising from the Contractor's inability to perform the Work in accordance with the Sequence of Operations provided in the Contract or from an approved Contractor alternate.

The Contractor shall secure the Engineer's approval of the Contractor's proposed plan of operation, sequence of work and methods of providing for the safe passage of vehicular and pedestrian traffic before it is placed in operation. The proposed plan of operation shall supplement the approved traffic control plan. Any major changes to the approved TTC plan, proposed by the Contractor, shall be submitted to the Department for approval.

Some additional traffic control details will be required prior to any major shifts or changes in traffic. The traffic control details shall include, but not be limited to, the following:

1. A detailed drawing showing traffic locations and lanes for each step of the change.
2. The location, size, and message of all signs required by the MUTCD, Plan, Special Provisions, and other signs as required to fit conditions. Any portable changeable message signs used shall be included in the details.
3. The method to be used in, and the limits of, the obliteration of conflicting lines and markings.
4. Type, location, and extent of new lines and markings.

5. Horizontal and vertical alignment and superelevation rates for detours, including cross-section and profile grades along each edge of existing pavement.
6. Drainage details for temporary and permanent alignments.
7. Location, length, and/or spacing of channelization and protective devices (temporary barrier, guardrail, barricades, etc.)
8. Starting time, duration and date of planned change.
9. For each traffic shift, a paving plan, erection plan, or work site plan, as appropriate, detailing workforce, materials, and equipment necessary to accomplish the proposed work. This will be the minimum resource allocation required in order to start the work.

A minimum of three (3) copies of the above details shall be submitted to the Engineer for approval at least fourteen (14) days prior to the anticipated traffic shift. The Contractor shall have traffic control details for a traffic shift which has been approved by the Engineer prior to commencement of the physical shift. All preparatory work relative to the traffic shift, which does not interfere with traffic, shall be accomplished prior to the designated starting time. The Engineer and the Contractor's representative will verify that all conditions have been met prior to the Contractor obtaining materials for the actual traffic shift.

C. Pedestrian Considerations

All existing pedestrian facilities, including access to transit stops, shall be maintained. Where pedestrian routes are closed, alternate routes shall be provided. Closures of existing, interim and final pedestrian facilities shall have the prior written approval of the Engineer. When existing pedestrian facilities are disrupted, closed or relocated in a TTC zone, the temporary facilities shall be detectable and shall include accessibility features consistent with the features present in the existing pedestrian facility. Pedestrian facilities are considered improvements and provisions made to accommodate or encourage walking. Whenever a sidewalk is to be closed, the Engineer shall notify the maintaining agency two (2) weeks prior to the closure. Prior to closure, detectable barriers (that are detectable by a person with a visual disability traveling with the aid of a long cane), as described by the MUTCD, shall be placed across the full width of the closed sidewalk. Barriers and channelizing devices used along a temporary pedestrian route shall be in compliance with the MUTCD.

Temporary Traffic Control devices used to delineate a Temporary Traffic Control Zone Pedestrian Walkway shall be in compliance with Subsection 150.3.01.A. Appropriate signs as described in the MUTCD shall be maintained to allow safe passage of pedestrian traffic or to advise pedestrians of walkway closures (Refer to MUTCD Figures TA-28 and TA-29 for guidance). Advance closure signing should be placed at intersections rather than midblock locations so that pedestrians are not confronted with midblock work sites that will induce them to attempt skirting the work site or making a midblock crossing. Temporary Traffic Control devices and construction material shall not intrude into the usable width of the pedestrian walkway. Signs and other devices shall be placed such that they do not narrow or restrict any pedestrian passage to less than forty-eight inches ($\geq 48''$).

1. Pedestrian Signage

A pedestrian walkway shall not be severed or relocated for non-construction activities, such as parking for construction vehicles and equipment. Movement by construction vehicles and equipment across designated pedestrian walkways should be minimized. When necessary, construction activities shall be controlled by flaggers. Pedestrian walkways shall be kept free of mud, loose gravel or other debris.

When temporary covered walkways are used, they shall be lighted during nighttime hours. When temporary traffic barrier is used to separate pedestrian and vehicular traffic, the temporary barrier shall meet NCHRP-350 Test Level Three. The barrier ends shall be protected in accordance with Georgia

Standard 4960. Curbing shall not be used as a substitute for temporary traffic barriers when temporary traffic barriers are required. Tape, rope or plastic chain strung between temporary traffic control devices are not considered as detectable and shall not be used as a control for pedestrian movements.

The WTCS shall inspect the activity area daily to ensure that effective pedestrian TTC is being maintained. The inspection of TTC for pedestrian traffic shall be included as part of the TC-1 report.

2. Temporary Pedestrian Facilities

Temporary pedestrian facilities shall be detectable and include accessibility features consistent with the features present in the existing pedestrian facility. The geometry, alignment and construction of the facility should meet the applicable requirements of the “Americans with Disabilities Act Accessibility Guidelines for Buildings and Facilities (ADAAG)”.

a. Temporary Walkways with Detectable Edging

A smooth, continuous hard surface (firm, stable and slip resistant) shall be provided throughout the entire length of the temporary pedestrian facility. Compacted soils, sand, crushed stone or asphaltic pavement millings shall not be used as a surface course for walkways.

Temporary walkways shall include detectable edging as defined in the MUTCD. When temporary traffic barrier is included as a pay item in the contract and where locations identified on the plans for positive protection will also allow them to serve as pedestrian detectable edging, payment will be made for the temporary traffic barrier in accordance with Section 620. No payment will be made for temporary walkways with Detectable Edging where existing pavements or existing edging (that meets the requirements of MUTCD) are utilized as temporary walkways. Payment for temporary detectable edging, including approved barriers and channelizing devices, installed on existing pavements shall be included in Traffic Control-Lump Sum.

Regardless of the materials used, temporary walkways shall be constructed with sufficient thickness and durability to withstand the intended use for the duration of the construction project. If concrete or asphalt is used as the surface course for the walkway, it shall be a minimum of one and one-half inches ($\geq 1\text{-}1/2''$) thick. Temporary walkways constructed across unimproved streets and drives shall be a minimum thickness of four inches ($\geq 4''$) for concrete and three inches ($\geq 3''$) for asphalt. Joints formed in concrete sidewalks shall be in accordance with Section 441. Concrete surfaces shall have a broom finish.

If plywood is used as a walkway, it must be a minimum of three quarters of an inch ($\geq 3/4''$) thick, pressure treated and supported with pressure treated longitudinal joists spaced a maximum of sixteen inches ($\leq 16''$) on center. The plywood shall be secured to the joist with galvanized nails or galvanized deck screws. Nails and screws shall be countersunk to prevent snagging or tripping the pedestrians. A slip resistant friction course shall be applied to any plywood surface that is used as a walkway. Any slip resistant material used shall have the prior written approval of the engineer.

The contractor may propose alternate types of Temporary Walkways provided that the contractor can document that the proposed walkway meets the requirements of the “Americans with Disabilities Act Accessibility Guidelines for Buildings and Facilities (ADAAG)”. Alternate types of Temporary Walkways shall have the prior written approval of the engineer.

Temporary walkways shall be constructed and maintained so there are no abrupt changes in grade or terrain that could cause a tripping hazard or could be a barrier to wheelchair use. The contractor shall construct and maintain the walkway to ensure that joints in the walkway have a vertical difference in elevation of no more than one quarter ($\leq 1/4''$) of an inch and that the horizontal joints have gaps no greater than one half ($\leq 1/2''$) of an inch. The grade of the temporary walkway should parallel the grade of the existing walkway or roadway and the cross slope should be no greater than two percent ($\leq 2\%$).

A width of sixty inches (60”), if practical, should be provided throughout the entire length of any temporary walkway. The temporary walkway shall be a minimum width of forty eight inches (48”). When it is not possible to maintain a minimum width of sixty inches (60”) throughout the entire length of temporary walkway, a sixty inch (60”) by sixty inch (60”) passing space should be provided at least every two hundred feet (200 ft.), to allow individuals in wheelchairs to pass.

Temporary walkways shall be constructed on firm subgrade. Compact the subgrade according to Section 209. Furnish and install any needed temporary pipes prior to constructing any walkway to ensure positive drainage away from or beneath the temporary walkway. Once the walkway is no longer required, remove any temporary materials and restore the area to the original conditions or as shown in the plans.

b. Temporary Curb Cut Wheelchair Ramps

Temporary curb cut wheelchair ramps shall be constructed in accordance with Section 441 and Construction Detail A-3 Curb Cut (Wheelchair) Ramps Concrete Sidewalk Details. Ramps shall also include a detectable warning surface in accordance with Construction Detail A-4 Detectable Warning Surface Truncated Dome Size, Spacing and Alignment Requirements. Other types of material for the construction of the temporary curb cut wheelchair ramps, including the detectable warning surface, may be used provided the contractor can provide documentation that the material to be used meets the requirements of the “Americans with Disabilities Act Accessibility Guidelines for Buildings and Facilities (ADAAG)”. When a wheelchair ramp is no longer required, remove the temporary materials and restore the area to existing conditions or as shown in the plans. For the items required to restore the area to original conditions or as shown in the plans, measures for payment shall be covered by contract pay items. If pay items are not included in the contract, then payment for these items shall be included in Traffic Control-Lump Sum.

c. Temporary Audible Information Device

Temporary audible information devices, when shown in the plans, shall be installed in compliance with the “Americans with Disabilities Act Accessibility Guidelines for Buildings and Facilities (ADAAG)”. The devices shall be installed in accordance with the manufacturer’s recommendations. Prior to installation, the contractor shall provide the engineer with a set of manufacturer’s drawings detailing the proper installation procedures for each device. When no longer required, the devices shall remain the property of the contractor.

150.2 Materials and Traffic Control Devices

150.2.01 Traffic Control Devices

A. NCHRP 350 and MASH

All devices shall be certified in accordance with the Manual for Assessing Safety Hardware (MASH) Test Level 3 and/or the National Cooperative Highway Research Program (NCHRP) 350 Test Level 3 as applicable unless modified by this Special Provision. In addition, temporary work zone devices, including portable barriers, manufactured after December 31, 2019, must have been successfully tested under 2016 edition of MASH requirements. Such devices manufactured on or before this date, and successfully tested under either NCHRP Report 350 or the 2009 edition of MASH, may continue to be used throughout their normal service lives.

B. Approval

All traffic control devices with applicable Qualified Products List (QPL) categories shall come from the appropriate QPL list. Products not on the QPL may be used with an approval letter from the Georgia Department of Transportation Office of Materials and Testing. If there are no applicable QPL, the Contractor shall provide proof of MASH/NCHRP 350 certification. The proof may be a letter or written statement from the manufacturer that the product is MASH/NCHRP 350 approved. Decal certifications are not proof of certification and are not required.

C. Quality Guidelines for All Temporary Traffic Devices

All traffic control devices found to be unacceptable in accordance with the current ATSSA, "Quality Guidelines for Temporary Traffic Devices and Features" regardless of total numbers shall be replaced within twenty-four (24) hours unless stated otherwise in the specifications, in the contract, or as directed by the Engineer.

150.2.02 Retroreflectivity Requirements

A. Signs

Reflective sheeting should meet the requirements of Section 913 and QPL-29

1. For all projects let prior to and including April/May 2018, signs can be:
 - a. All rigid fluorescent orange construction warning signs (black on fluorescent orange) shall meet the minimum retroreflectivity and color requirements of ASTM Type VII, VIII, IX or X regardless of the mounting height.
 - b. Warning signs (W3-1) for stop conditions that have rumble strips located in the travel lane shall be reflectorized with ASTM Type IX fluorescent yellow sheeting.
 - c. All other signs shall meet the requirements of ASTM Type III or IV except for "Pass With Care" and "Do Not Pass" signs which may be ASTM Type I unless otherwise specified
2. For all projects let May/June 2018 and afterward, all construction warning signs (black on fluorescent orange) shall meet the minimum reflectivity and color requirements of ASTM D4956 Type XI regardless of the mounting height. All other signs reflectorization shall be in accordance with the plans, contract, and "GDOT Signing and Marking Design Guidelines".

B. Channelization Devices

Reflective sheeting should meet the requirements of Section 913 and QPL-29

1. For all projects let prior to and including April/May 2018, channelization devices shall meet the minimum requirements of ASTM Type III or IV high intensity sheeting.
2. For all projects let May/June 2018 and afterward, all channelization devices (white/ fluorescent orange and white/red) shall meet the minimum retroreflectivity requirements of ASTM D4956 Type VI.

150.2.03 Arrow Panels

Arrow panel should meet the requirements for MUTCD (6F.61) and QPL-79.

Portable sequential arrow, sequential chevron, or flashing arrow panels shall be a minimum size of forty-eight inches (48”) high by ninety-six inches (96”) wide with not less than fifteen (15) lamps used for the arrow. The arrow shall occupy virtually the entire size of the arrow panel and shall have a minimum legibility distance of one (1) mile. The minimum legibility distance is the distance at which the arrow panel can be comprehended by an observer on a sunny day, or clear night. Arrow panels shall be equipped with automatic dimming features for use during hours of darkness. The arrow panels shall also meet the requirements for a Type C panel as shown in the MUTCD (6F.61). The sequential or flashing arrow panels shall not be used for lane closure on two-lane, two-way highways when traffic is restricted to one-lane operations in which case, appropriate signing, flaggers and when required, pilot vehicles will be deemed sufficient.

The arrow panels shall be placed on the shoulder at or near the point where the lane closing transition begins. The panels shall be mounted on a vehicle, trailer, or other suitable support. Vehicle mounted panels shall be provided with remote controls. Minimum mounting height shall be seven feet (7’) above the roadway to the bottom of the panel, except on vehicle mounted panels which should be as high as practical.

For emergency situations, arrow display panels that meet the MUTCD requirements for Type A or Type B panels may be used until Type C panels can be located and placed at the site. The use of Type A and Type B panels shall be held to the minimum length of time possible before having the Type C panel(s) in operation. The Engineer shall determine when conditions and circumstances are considered to be emergencies. The Contractor shall notify the Engineer, in writing, when any non-specification arrow display panel(s) is being used in the work.

150.2.04 Channelization Devices

A. General

Channelization shall clearly delineate the travel way through the work zone and alert drivers and pedestrians to conditions created by work activities in or near the travel way. Channelization shall be accordance with the plans, specifications, MUTCD, QPL-34, and the following requirements.

B. Drums

1. Design

Drums shall meet the minimum requirement of the MUTCD (6F.67). For all projects let May/June 2018 and afterward, drums shall have six inch (6”) wide stripes – white/fluorescent orange.

2. Application

Drums shall be used as the required channelizing device to delineate the full length of a lane closure, shift, or encroachment, except as modified by this Subsection.

3. Longitudinal Channelization

Drums shall be spaced as listed below for various roadside work conditions except as modified by Subsection 150.3.11. Spacing shall be used for situations meeting any of the conditions listed as follows:

a. FORTY FOOT (40') SPACING MAXIMUM

- For difference in elevation exceeding two inches ($> 2''$).
- For heeled sections no steeper than 4:1 as shown in Subsection 150.3.11, Detail 150-H..

b. EIGHTY FOOT (80') SPACING MAXIMUM

- For difference in elevation of two inches ($\leq 2''$) or less.
- Flush areas where equipment or workers are within ten feet ($\leq 10'$) of the travel lane.

c. 200 FOOT SPACING MAXIMUM: Where equipment or workers are more than ten feet ($> 10'$) from travel lane. Lateral offset clearance to be four feet (4') from the travel lane.

- For paved areas, eight feet ($> 8'$) or greater in width that are paved flush with a standard width travel lane.
- For disturbed shoulder areas not completed to typical section that are flush to the travel lane and considered a usable shoulder.

4. Removal of Drums

Drums may be removed after shoulders are completed to typical section and grassed. Guardrail and other safety devices shall be installed and appropriate signs advising of conditions such as soft or low shoulder shall be posted before the drums are removed.

C. Vertical Panels

1. Design

All vertical panels shall meet the minimum requirements of the MUTCD (6F.66). All vertical panels shall have a minimum of 270 square inches of retroreflective area facing the traffic and be a minimum thirty-six inches ($\geq 36''$) high. For all projects let May/June 2018 and afterward, the vertical panel shall be in addition a minimum eight inches ($\geq 8''$) wide with a stripe width of six inches (6") – white/fluorescent orange.

2. Application

Vertical panels with retroreflectivity less than type VI can only be used when traffic drums reduce the travel lane to less than ten feet ($\leq 10'$); vertical panels shall be used to restore the travel lane to ten feet ($\geq 10'$) or greater. No other application of vertical panels with retroreflectivity less than type VI will be permitted.

Vertical panels with a minimum type VI retroreflectivity and six inch (6") stripe may be used for longitudinal channelization in the activity zone where work takes place for short-term stationary lane closures and intermediate-term stationary lane closures. They can be used for lane closures lasting three (3) days and with Engineer approval up to seven (7) days. They shall not be used in the transition zone including the tapers and the tangent lengths between tapers.

D. Cones

1. Design:

All cones shall be a minimum of twenty-eight inches ($\geq 28''$) in height regardless of application and shall meet the requirements of the MUTCD (6F.64).

Retroreflectivity may be deleted from all cones.

2. Application

On interstate cones shall be prohibited. On all other routes cones may only be used for longitudinal channelization in the activity zone where work takes place for short-term stationary lane closures. They shall not be used in the transition zone including the tapers and the tangent lengths between tapers. The use of cones for nighttime work will not be permitted. Cones shall not be stored or allowed to be visible on the worksite during nighttime.

Cones may be used for daytime flagging operations including tapers at flagging stations.

E. Barricades

1. Design

Type 3 barricades shall meet the minimum requirements of the MUTCD (6F.68). The Contractor has the option of choosing Type 3 barricades from the QPL-34 or the Contractor may utilize generic barricades that are approved by the Federal Highway Administration (FHWA). When barricades have been specifically crash tested with signs attached, the contractor has the responsibility to attach the signs as per the manufacturer's recommendations to ensure crashworthiness. If the barricades were not tested with the signs, crashworthy compliance may require that rigid signs be mounted separate from the Type 3 barricade.

The use of Type 1 and Type 2 barricades will not be permitted.

2. Application

Type 3 barricades shall be placed as required by the plans, the Standards, and as directed by the Engineer.

When a barricade is placed so that it is subject to side impact from a vehicle, a drum shall be placed at the side of the barricade to add target value to the barricade.

F. Warning Lights

1. Design

All warning lights shall meet the requirements of the MUTCD (6F.83).

2. Application:

- a. Type A low-intensity flashing lights shall be used as shown in the Plans, the Standards, and as directed by the Engineer.
- b. Type C Steady-Burn lights shall be used as shown in the Plans, the Standards, and as directed by the Engineer.

150.2.05 Flashing Beacon

The flashing beacon assembly, when specified, shall be used in conjunction with construction warning signs, regulatory, or guide signs to inform traffic of special road conditions which require additional driver attention. The flashing beacon assembly shall be installed in accordance with the requirements of Section 647.

150.2.06 Guardrail

Guardrail shall comply with Section 641 Guardrail and the guardrail standards.

When the removal and installation of guardrail is required, as a part of the work, the following time restrictions shall apply unless modified by the special conditions:

From the time that the existing guardrail or temporary positive barrier protection is removed, the Contractor has fourteen (14) days to install the new guardrail and anchors. During the interim, the location without guardrail shall be protected with drums spaced at a maximum spacing of twenty feet (20'). The guardrail blunt end is to be treated as a fix object and shall be projected. The maximum length of rail that can be removed at any time without being replaced with positive barrier protection is a total of 2000 linear feet of existing rail or the total length of one run of existing rail, whichever is less. Based on existing field conditions, the Engineer may review the work and require that the guardrail be installed earlier than the maximum time allowed.

The contractor shall install new guardrail, such that traffic exposure to fixed objects is minimized. Within the same workday, temporary attenuators, as defined in Subsection 150.2.10, should be installed on the approach to fixed objects that can't be protected with guardrail. Truck mounted attenuators may be used to shield exposed fixed objects for periods not to exceed fourteen (14) days. No separate payment will be made for truck mounted attenuators, attenuators, or other methods unless provided for in the contract.

When the roadway is open to traffic, guardrail panels shall be lapped to comply with the directional flow of traffic. Should the staging of the work require that the lap of the guardrail be changed, this work shall be completed before the roadway is opened to traffic. The work to change the lap of any guardrail shall be included in Traffic Control-Lump Sum.

The laps on anchors shall be in accordance with the manufacture's recommendations and installation instructions. As a result, a trailing anchor may be lapped opposing the flow of traffic.

Failure to comply with the above time and quantity restrictions shall be considered as non-compliance under Subsection 150.5.01.

150.2.07 Interim Signs

A. Posts

Permanent mounting height to the bottom of sign shall be seven (7) feet – eight (8) feet measured vertically from the bottom of the sign to the elevation of the near edge of the pavement or from the walkway. Posts for all interim signs should be square tubular post meeting the requirements of Section 911, QPL-35, and Construction Detail T-3A (Type 7, 8, and 9 Square Tube Post Installation Detail). Ground mounted sign(s) greater than 48" wide shall be mounted on two posts. For barrier mounted sign, single post mount is allowed.

The post(s) shall not extend beyond the top of the sign(s). The sign(s) shall be substantially plumbed and leveled.

Galvanized U-Channel post can be used in lieu of square tubular posts until December 31, 2019. The U-Channel post shall meet the requirements of Section 911. Ground mounted sign(s) greater than nine (9) square feet shall be mounted on two posts. All posts replaced or installed on or after January 01, 2020 shall be square tubular posts.

Unprotected interim posts shall be spliced as shown in Detail 150-A, unless full length unspliced posts are used. Unprotected post splices will not be permitted any higher than four inches above the ground line to lessen the possibility of affecting the undercarriage of a vehicle. Installation of posts may require establishment of openings in existing pavements, islands, shoulders etc.

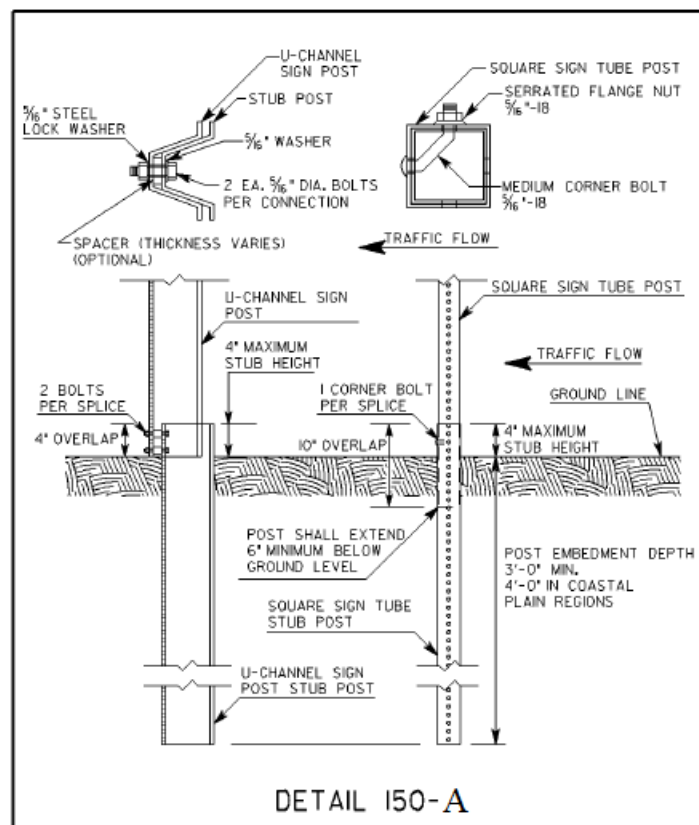

B. Sign Blanks and Panels

All TTC sign blanks and panels should conform to Section 912 of the Specifications. Alternative sign blank materials (composites, polycarbonates, fiberglass reinforced plastics, recycled plastics, etc.) shall have a letter of approval from the Office of Materials and Testing for use as interim construction signs before these materials are allowed to be incorporated into the work, unless these rigid sign blanks are currently approved as a crashworthy sign blank material under QPL 34.

Unless specified elsewhere in the contract, specifications, plans, and/or directed by the Engineer, sign sizes are according to the following:

1. All construction signs sizes should follow the dimensions provide in MUTCD Table 6F-1 “Temporary traffic Control Zone Sign and Plaque Sizes” under the column for “Freeway or Expressway”.
2. For all other signs used just for staging, the sign sizes should follow the dimensions provide in MUTCD Table 2B-1 “Regulatory Sign and Plaque Sizes” for the largest size.
3. Permanent signs used for staging shall be according to plans.

Plywood blanks or panels will not be permitted.

The use of flexible signs will not be permitted.

For utility work not included in the contract, the utility contractor may use flexible signs within the project limits.

150.2.08 Pavement Markings

All temporary traffic striping shall conform to the requirements of Section 652, Section 653, Section 657, Section 658, Section 659, and QPL-46.

A. All Traffic Striping for 45 Days or Less (≤ 45 Days)

All traffic striping that will be in place for 45 days or less shall be 4 inches or greater in width.

B. All Temporary Striping Beyond 45 days (>45 Days)

All traffic striping applied on intermediate surfaces shall be a minimum 5 inches in width or as shown on plans. On final surfaces when temporary striping will be overlaid or eradicated, the temporary striping shall be a minimum 5 inches in width.

C. All Temporary Traffic Striping on Final Surface

All temporary traffic striping applied to final surfaces which will not be overlay or grinded may be 4 inches in width or as shown on the plans.

150.2.09 Portable Changeable Message Signs

Unless specified as a paid item in the contract, the use of a portable changeable message sign will not be required. When specified, a portable changeable message sign (PCMS) shall meet the minimum requirements of Section 632, MUTCD (6F.60) and be on QPL-82. The maximum amount of messages allowed to be flashed on one PCMS is two phases (flashes). The language and the timing of the messages shall comply with the MUTCD and Section 632. When used as an advanced device, the PCMS should typically be placed ahead of the construction activities. If the PCMS is used as a substitute for another device, then the requirements for the other device apply.

Any PCMS in use, which is not protected by positive barrier protection, shall be delineated by a minimum of three drums that meet the requirement of Subsection 150.2.04.B. The drum spacing shall not exceed a maximum of ten

(10') feet as shown in Detail 150-B. When the PCMS is within twenty (20') feet of the opposing traffic flow, the trailing end of the PCMS shall be delineated with a minimum of three drums spaced in the same manner as the approach side of the PCMS.

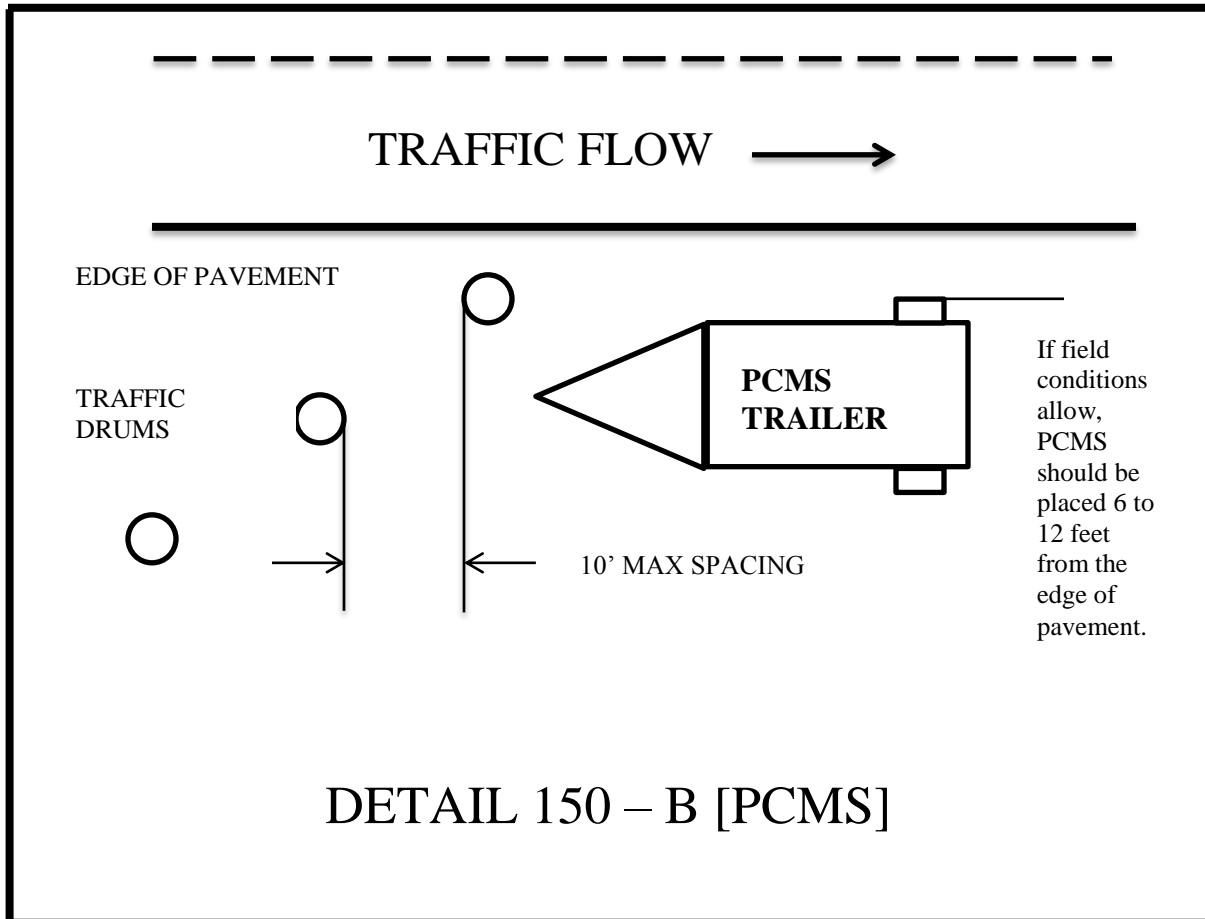

When not in use, the PCMS shall be removed from the roadway, unless protected by positive barrier protection. If the PCMS is protected by positive barrier protection, the sign panel shall be turned away from traffic when not in use.

150.2.10 Portable Impact Attenuators

This work consists of the furnishing (including spare parts), installation, maintenance, relocation, reuse as required, and removal of Portable Impact Attenuator Units/Arrays.

Portable Impact Attenuator Unit/Arrays installation shall conform to the requirements of Section 648, Manufacturer's recommendations and Georgia Standard 4960 "Temporary Barrier (End Treatment Options)" and shall be installed at locations designated by the Engineer, and/or as shown on the plans. When gating

attenuators are used, the contractor shall maintain the appropriate recovery area in accordance with the manufacturers' recommendations.

Generic sand/water loaded modules are prohibited. Manufacturers' sand/water loaded modules with specific arrays that have been NCHRP 350/MASH approved can be used in appropriate locations.

The test level of protection provided shall equal or exceed the speed limit. Test level 3 shall be used for forty-five (45) mph or above.

150.2.11 Portable Temporary Traffic Control Signals

The use of Portable Temporary Traffic Control Signals shall meet the following minimum requirements:

Only two-lane, two-way roadways will be allowed to utilize Portable Temporary Traffic Control Signals.

All portable traffic control signals shall meet the physical display and operational requirements of conventional traffic signals described in the MUTCD.

Each signal face shall have at least three lenses. The lenses shall be red, yellow, or green in color and shall give a circular type of indication. All lenses shall be twelve (12") inches nominal in diameter.

A minimum of two signal faces shall face each direction of traffic. A minimum of one signal head shall be suspended over the roadway travel lane in a manner that will allow the bottom of the signal head housing to be not less than seventeen (17') feet above and not more than nineteen (19') feet above the pavement grade at the center of the travel lane. The second signal head may be located over the travel lane with the same height requirements or the second signal head may be located on the shoulder. When the signal head is located on the shoulder, the bottom of the signal head housing shall be at least eight (8') feet but not more than (15') feet above the pavement grade at the center of highway.

Advance warning signage and appropriate pavement markings shall be installed as part of the temporary signal operation.

The signals shall be operated in a manner consistent with traffic requirements. The signals may be operated in timed-mode or in a vehicle-actuated mode. The signals shall be interconnected in a manner to ensure that conflicting movements cannot occur. To ensure that the appropriate operating pattern, including timing is displayed to the traveling public, regular inspections, including the use of accurate timing devices shall be made by the Worksite Traffic Control Supervisor. If, at any time, any part of the system fails to operate within these requirements then the use of the signal shall be suspended and the appropriate flagging operation shall begin immediately.

The Worksite Traffic Control Supervisor (WTCS) shall continuously monitor the portable traffic control signal to insure compliance with the requirements for maintenance under the MUTCD. The signal shall be maintained in a manner consistent with the intention of the MUTCD, with emphasis on cleaning of the optical system. Timing changes shall be made only by the WTCS. The WTCS shall keep a written record of all timing changes.

The portable temporary signal shall have two power sources and shall be capable of running for seven calendar days continuously.

The Contractor shall have an alternate temporary traffic control plan in the event of failure of the signal.

150.2.12 Raised Pavement Markers

Raised pavement markers (RPMs) shall meet the requirements of Section 654 and QPL-76.

150.2.13 Rumble Strips

Rumble strips incorporated into the work shall meet the requirements of Section 429 and the MUTCD. Existing rumble strips that are positioned in the traveled way to warn traffic of a stop condition shall be reinstalled prior to opening to traffic. Based on the following requirements:

Intermediate surfaces that will be in use for more than forty-five (45) calendar days shall have rumble strips reinstalled on the traveled way in the area of a stop condition. Non-refundable deductions in accordance with Subsection 150.5.01 will be assessed for any intermediate surface in place for greater than 45 days without rumble strips.

Rumble strips shall be installed on the final surface within fourteen (14) calendar days of the placement of the final surface in the area of the stop condition. Failure to install within fourteen (14) calendar days will result in assessment of non-refundable deductions in accordance with Subsection 150.5.01.

Prior to the removal of any rumble strips located in the travel lane, stop ahead (W3-1) warning signs shall be double indicated ahead of the stop condition. These warning signs shall be a minimum of 48 inches by 48 inches. These warning signs shall remain in place until the rumble strips have been reinstalled on the traveled way. Any existing warning signs for the stop ahead condition shall be removed or covered while the 48" X 48" (W3-1) signs are in place. When the rumble strips have been reinstalled, these warning signs should be promptly removed and any existing signage placed back in service.

150.2.14 Temporary Barriers

A. Design:

Temporary barriers shall meet the requirements of Sections 620. The lengths of advancement should be in accordance with Georgia Standard 4000W "Lengths of Advancement, Clear Zone Distances, and Fill Height Embankment". The approach end of the taper should have 10:1 or flatter ground slope. Temporary barriers shall not be used as a channelization device. Their use is in accordance with MUTCD (6F.85).

B. Application:

Temporary barriers shall be placed as required by the plans, standards, and as directed by the Engineer. When Temporary barrier is located twenty feet ($\leq 20'$) or less from a travel lane, yellow reflectors shall be fixed to the top of the barrier at intervals not greater than forty feet ($\leq 40'$) in the longitudinal section and twenty feet ($20'$) in the taper section and shall be mounted approximately two inches (2") above the barrier. If both lanes of a two-lane two-way roadway are within twenty feet ($\leq 20'$) or less of the barrier then the reflectors shall be installed for both directions of traffic.

The reflectors shall be hundred (100) square inches (ASTM Type VII or VIII/ Type XI) reflective sheeting mounted on flat-sheet blanks. The reflectors shall be mounted approximately two inches above the top of the barrier. The reflectors shall be attached to the barrier with adhesive or by a drilled-in anchor type device. The reflectors shall not be attached to a post or board that is placed between the gaps in the barrier sections.

Approach end of Temporary barrier shall be protected according to Georgia Standard 4960 “Temporary Barrier (End Treatment Options)” or by a portable impact attenuator.

On interstates or other controlled access highways where lane shifts or crossovers cause opposing traffic to be separated by less than forty feet (<40’), portable barrier should be used as a separator.

150.2.15 Temporary Guardrail Anchorage- Type 12

This work consists of the furnishing, installation, maintenance and removal of Temporary Guardrail Anchorage-Type 12 used for Portable Barrier or temporary guardrail end treatment. Materials used in the Temporary Guardrail Anchorage- Type 12 shall meet the requirements of Section 641 of the Specifications and current Georgia Standards and may be new or used. Materials salvaged from the Project, which meet the requirements of Standards, may be utilized if available. The use of any salvaged materials will require prior approval of the Engineer.

Installation of the Temporary Guardrail Anchorage- Type 12 shall conform to the requirements of the Plans, current Georgia Standards and Section 641 of the Specifications. Installation shall also include sufficient additional guardrail and appurtenances to effect the transition and connection to Temporary Concrete Barrier as required by the details in Georgia Standard 4960 “Temporary Barrier (End Treatment Options)”.

150.2.16 Temporary Traffic Signals

Temporary traffic signals shall meet the requirements of Section 647 and the MUTCD.

150.3 Construction Requirements

150.3.01 General

A. Implementation Requirements

No work shall be started on any project phase until the appropriate traffic control devices have been placed in accordance with the Project requirements. Changes to traffic flow shall not commence unless all labor, materials, and equipment necessary to make the changes are available on the Project.

When any shift or change is made to the location of traffic or to the flow patterns of traffic, including pedestrian traffic, the permanent safety features shall be installed and fully operational before making the change. If staging or site conditions prevent the installation of permanent features then the equivalent interim devices shall be utilized. This work shall also include any necessary removal and reinstallation of guardrail panels to achieve the required panel lap to accommodate the appropriate shift and traffic flow including the final traffic flow configuration. The cost of performing this work shall be included in Traffic Control-Lump Sum.

Any section of the work that is on a new location shall have all permanent safety features installed and fully operational before the work is opened to traffic. Safety features shall include, but are not limited to the following items:

- 1) Guardrails including anchors and delineation with properly lapped panels
- 2) Impact attenuators
- 3) Traffic signals
- 4) Warning devices
- 5) Pavement markings including words, symbols, stop bars, and crosswalks
- 6) Roadway signs including regulatory, warning, and guide

Outdoor lighting shall be considered as a safety feature for welcome centers, rest areas, and weigh station projects. For typical roadway type projects, new street lighting is not considered a safety feature, unless specifically noted in the plans or in the special conditions.

B. Maintenance of Traffic Control Devices

Traffic control devices shall be in acceptable condition when first erected on the project and shall be maintained in accordance with Section 104, throughout the construction period. All unacceptable traffic control devices shall be replaced within twenty-four (24) hours. When not in use, all traffic control devices shall be removed, placed or covered so as not to be visible to traffic. All construction warning signs shall be removed within seven (7) calendar days after time charges are stopped or pay items are complete. If traffic control devices are left in place for more than ten (10) calendar days after completion of the Work, the Department shall have the right to remove such devices, claim possession thereof, and deduct the cost of such removal from any monies due, or which may become due, the Contractor.

C. Traffic Interruption Restrictions

The Department reserves the right to restrict construction operations when, in the opinion of the Engineer, the continuance of the Work would seriously hinder traffic flow, be needlessly disruptive or unnecessarily inconvenience the traveling public. The Contractor shall suspend and/or reschedule any work when the Engineer deems that conditions are unfavorable for continuing the Work.

Advanced notification requirements to the Contractor to suspend work will be according to the events and the time restrictions outlined below:

Incident management - No advanced notice required

Threatening/Inclement weather – twenty-four (24) hours

Holiday, sporting events, unfavorable conditions - Three (3) calendar days

If the work is suspended, the Contractor may submit a request for additional contract time as allowed under Section 108. The Department will review the request and may grant additional contract time as justified by the impact to the Contractor's schedule. Compensation for loss of productivity, rescheduling of crews, rental of equipment or delays to the Contractor's schedule will not be considered for payment. Additional contract time will be the only consideration granted to the Contractor.

D. Work Zone Restrictions

1. Interstate

The Contractor should not simultaneously perform work on both the inside shoulder and outside shoulder on either direction of traffic flow when the Work is within 12 feet of the travel-way. Shoulders can be alternated if areas are separated by at least one-half mile of distance.

2. Non-Interstate Divided Highways

The Contractor should not simultaneously perform work on both the inside shoulder and outside shoulder on either direction of traffic flow when the Work is within 12 feet of the travel-way. Shoulders can be alternated if areas are separated by at least one-half mile distance in rural areas or at least 500 feet of distance in urban areas.

3. Non-Divided Highways

- a. The Contractor should not simultaneously perform work on opposite sides of the roadway when the work is within 12 feet of the travel-way. Shoulders can be alternated if areas are separated by at least one-half mile of distance in rural areas or at least 500 feet of distance in urban areas.
- b. On two-lane projects where full width sections of the existing subgrade, base or surfacing are to be removed, and new base, subgrade, or surfacing are to be constructed, the Contractor should maintain one-lane traffic through the construction area by removing and replacing the undesirable material for half the width of the existing roadway at a time. Replacement should be made such that paving is completed to the level of the existing pavement in the adjacent lane by the end of the workday or before opening all the roadway to traffic.

E. Work Zone Geometric Restrictions

There should be no reduction in the total number of available traffic lanes including turning lanes that existed prior to construction, except as specifically allowed by the Contract and as approved by the Engineer.

Travel lane Clearances: All portions of the work should maintain the following minimum requirements:

Horizontal: The combined dimensions of the paved shoulder and the roadway surface remaining outside the Work Zone should be no less than sixteen feet ($\geq 16'$) in width at any location.

Vertical: The overhead clearance should not be reduced to less than fifteen feet ($\geq 15'$) at any location.

The restrictions above apply to all shifts, lane closures, on-site detours and off-site detours whether shown in the contract or proposed by the Contractor. It shall be the responsibility of the Contractor to verify that these minimum requirements have been met before proceeding with any phase of the Work. Two-lane, two-way roadways may have temporary horizontal restrictions of less than sixteen feet ($\geq 16'$) during flagging operations. The minimum horizontal clearance should be restored before the flagging operation is removed.

F. Clear Zone

At the end of the workday, all equipment, materials, and TTC devices not in use should be moved out of the clear zone or behind positive protection. The clear zone is defined by Georgia Standard 4000W "Lengths of Advancement, Clear Zone Distances, Fill Height Embankment". For urban roadway with curb, the minimum set back is six (6') feet from the curb face. If stored behind positive protection, proper lengths of advancement should be maintained. If stored behind guardrail the items shall be a minimum five feet ($\geq 5'$) from the face of the guardrail and not in the recovery zone of the anchor.

The Worksite Traffic Control Supervisor (WTCS) shall monitor the work to ensure that all the rocks, boulders, construction debris, stockpiled materials, equipment, tools and other potential hazards are kept clear of the travel lane.

G. Milled Surface Restrictions

Unless modified by the special conditions, a milled surface on any asphaltic concrete surface shall not be allowed to remain open to traffic for a period of time that exceeds thirty (> 30) calendar days.

H. Construction Vehicles

The Contractor’s vehicles shall travel in the direction of normal roadway traffic and shall not reverse direction except at intersections, interchanges, or approved temporary crossings. The Contractor may submit a plan requesting that construction traffic be allowed to travel in the opposite direction of normal traffic when it would be desirable to modify traffic patterns to accommodate specific construction activities.

Prior approval of the Engineer shall be obtained before any construction traffic is allowed to travel in a reverse direction. If the Contractor’s submittal is approved, the construction traffic shall be separated from normal traffic by appropriate traffic control devices.

The parking of Contractor’s and/or workers’ personal vehicles within the work area or adjacent to traffic is prohibited. It shall be the responsibility of the Worksite Traffic Control Supervisor to ensure that any vehicle present at the worksite is necessary for the completion of the work.

I. Environmental Impacts

The Contractor shall ensure that dust, mud, and other debris from construction activities do not interfere with normal traffic operations or adjacent properties.

J. Existing Street Lights

Existing street lighting shall remain lighted as long as practical and until removal is approved by the Engineer.

K. Nighttime Work Lighting

Adequate temporary lighting shall be provided at all nighttime work sites where workers will be immediately adjacent to traffic.

L. Removal/Reinstallation of Miscellaneous Items

In the prosecution of the Work, if it becomes necessary to remove any existing signs, markers, guardrail, etc. not covered by specific pay item, they shall be removed, stored and reinstalled, when directed by the Engineer, to line and grade, and in the same condition as when removed.

150.3.02 Personnel – Worker Safety Apparel

In accordance with MUTCD (6D.03) all workers, within the right-of-way who are exposed either to traffic or to work vehicles and construction equipment within the TTC zone, shall wear high-visibility safety apparel that meets the Performance Class 2 or better.

150.3.03 Signage - General

A. Signing Requirements of the Temporary Traffic Control (TTC) Plan

When existing regulatory, warning or guide signs are required for proper traffic and pedestrian control, the Contractor shall maintain these signs in accordance with the temporary traffic control (TTC) plan. The Contractor shall review the status of all existing signs, interim signs added to the work, and permanent sign installations that are part of the work to eliminate any conflicting or non-applicable signage in the TTC Plan. The Contractor's review of all signs in the TTC Plan shall establish compliance with the requirements of the MUTCD and Section 150. Any conflicts shall be reported to the Engineer immediately and the WTCS shall take the necessary measures to eliminate the conflict.

The Contractor shall make every effort to eliminate the use of interim signs as soon as the Work allows for the installation of permanent signs.

All existing illuminated signs shall remain lighted and be maintained by the Contractor.

Existing street name signs shall be maintained at street intersections.

B. Conflicting or Non-Applicable Signs

Any sign(s) or portions of a sign(s) that are not applicable to the TTC plan shall be covered so as not to be visible to traffic or shall be removed from the roadway when not in use. The WTCS shall review all traffic shifts and changes in the traffic patterns to ensure that all conflicting signs have been removed. The review shall confirm that the highest priority signs have been installed and that signs of lesser significance are not interfering with the visibility of the high priority signs. High priority signs include signs for road closures, shifts, detours, lane closures and curves. Any signs, such as speed zones and speed limits, passing zones, littering fines and litter pick up, that reference activities that are not applicable due to the presence of the Work shall be removed, stored and reinstalled when the Work is completed.

Failure to promptly eliminate conflicting or non-applicable signs shall be considered as non-performance under Subsection 150.5.01.

C. Removal of Existing Signs and Supports

The Contractor shall not remove any existing signs and supports without prior approval from the Engineer. All existing signs and supports which are to be removed shall be stored and protected if this material will be required later in the work as part of the TTC plan. If the signs are not to be utilized in the work then the signs will become the property of the Contractor unless otherwise specified in the contract documents.

D. Interim Guide, Warning and Regulatory Signs

Interim guide, warning, or regulatory signs required to direct traffic and pedestrians shall be furnished, installed, reused, and maintained by the Contractor in accordance with the MUTCD, the Plans, Special Provisions, Special Conditions, or as directed by the Engineer. These signs shall remain the property of the Contractor. When the signs are used for long-term stationary operations as defined MUTCD (6G.02), the bottom of all interim signs shall be mounted seven feet (7') to eight feet (8') above the level of the pavement edge or sidewalk. The signs offset should be six feet (6') to twelve feet (12') from the pavement edge or two feet ($\geq 2'$) minimum for sidewalks according to MUTCD (6F-1). Special Conditions under Subsection 150.6 may modify this requirement.

Portable signs may be used when the duration of the work is less than three (3) days or as allowed by the special conditions in Subsection 150.6. Portable signs shall be used for all punch list work. Portable interim signs shall be mounted a minimum of one foot ($\leq 1'$) above the level of the pavement edge for directional traffic of two (2) lanes or less and at seven feet (7') for directional traffic of three (3) or more lanes according to MUTCD (6F-2). Signs shall be mounted at the height recommended by the manufacturer's crashworthy testing requirements.

All sign blanks shall be rigid whether the sign is mounted as a portable sign, on a Type III barricade or as a permanent mount height sign. Utilities and their subcontractors working in the project limits, and not included in the project contract, may use non-rigid signs.

E. Existing Special Guide Signs

Existing special guide signs on the Project shall be maintained until conditions require a change in location or legend content. When change is required, existing signs shall be modified and continued in use if the required modification can be made within existing sign borders using design requirements (legend, letter size, spacing, border, etc.) equal to that of the existing signs, or of Subsection 150.3.E.2. Differing legend designs shall not be mixed in the same sign.

1. Special Guide Signs

Special guide signs are those expressway or freeway guide signs that are designed with message content (legend) that applies to a particular roadway location. When an existing special guide sign is in conflict with work to be performed, the Contractor shall remove the conflicting sign and reset it in a new, non-conflicting location which has been approved by the Engineer.

2. Interim Special Guide Signs

When it is not possible to utilize existing signs, either in place or relocated, the Contractor shall furnish, erect, maintain, modify, relocate, and remove new interim special guide signs in accordance with the Plans or as directed by the Engineer. Interim special guide signs that may be required in addition to, or a replacement for, existing expressway and freeway (interstate) signs shall be designed and fabricated in compliance with the minimum requirements for guide signing contained in Part 2E "Guide Signs – Freeway and Expressway" of the MUTCD. All interstate shields on these signs shall be 48 inches and 60 inches for two-numeral and three-numeral routes, respectively.

The road name of the exit or route shield shall be placed on the exit gore sign.

3. Interim Overhead Guide Sign Structures

Interim overhead special guide sign structures are not required to be lighted unless specifically required by the Plans. If lighting is required, the sign shall be lighted as soon as erected and shall remain lighted, during the hours of darkness, until the interim sign is no longer required. The Contractor shall notify the Power Company at least thirty (30) days prior to desire connection to the power source.

4. Permanent Special Guide Signs

The installation of new permanent special guide signs and the permanent modification or resetting of existing special guide signs, when included in the contract, shall be accomplished as soon as practical to minimize the use of interim special guide signs. If lighting is required by the Plans, all new permanent overhead special guide signs shall be lighted as soon as erected.

F. Stop Sign Regulated Intersections

For intersections that utilize stop sign(s) to control the flow of traffic and to restrict the movement of vehicles, the stop sign(s) shall be maintained for the duration of the work or until such time that the stop condition is eliminated or until an interim or permanent traffic signal can be installed to provide proper traffic control. The traffic signal shall be installed and properly functioning before the removal of the existing stop sign(s) is permitted. If the existing intersection is enhanced traffic control features, such as stop lines, double indicated stop signs, oversized signs, advanced warning stop ahead signs, rumble strips on the approaches or flashing beacons located overhead or on the shoulders then these features shall be maintained for the duration of the project or until the permanent traffic control plan has been implemented.

Whenever the staging of the work requires that the traveled way be relocated or realigned the Contractor shall reinstall all enhanced traffic control features noted above on the newly constructed sections of the work. The cost of relocating the stop lines, stop signs, advanced warning signs, the rumble strips and the flashing beacons shall be included in the price bid for Traffic Control - Lump Sum unless individual pay items are included in the contract for rumble strips and/or flashing beacons. When pay items are included in the contract for rumble strips or flashing beacons then these items will be paid per each.

When staging requires the relocation or realignment of an existing stop condition, it may be necessary to consider the addition of enhanced traffic control features even though none existed at the original location. Horizontal and vertical alignment changes at a new location may have decreased or restricted sight distance or the stop condition may occur sooner than in the previous alignment. If these conditions occur, then the Engineer and/or the WTCS should consider additional measures to enhance the motorist's awareness of the changes even though the staging plans may not address enhanced features. Stop signs should be a minimum of 36 inches for interim situations. The use of 48 inch stop signs may be warranted under project specific conditions. Flags may be used on interim/permanent stop signs that are mounted at seven (7') feet in height for a short duration in order to direct additional attention to a new or relocated stop sign(s). Flags should not be used for durations exceeding two weeks unless unusual or site specific conditions warrant a longer period of time. The use of Type "A" flashing red light(s) attached to the stop sign(s) may be appropriate during the same period that the flags are in use to increase attention.

The use of rumble strips and/or portable changeable message signs may be considered. The use of new rumble strips, where none previously existed, shall have the prior approval of District Traffic Operations before being included as part of the temporary traffic control plan. The message(s) displayed on any PCMS shall have the prior approval of the Engineer and the message(s) shall be included as part of the TTC plan for the interim staging.

The placement of any additional interim ground mounted signs and posts or stop lines shall be considered as incidental to the price bid for Traffic Control - Lump Sum. The installation of rumble strips, flashing beacons or the use of Portable Changeable Message Signs (PCMS) shall be considered as Extra Work unless pay items are included in the contract.

G. Low Shoulder Signage

1. Low Shoulder for Construction/Reconstruction/Resurfacing Projects

"Low Shoulder" (W8-9) signs shall be erected when a difference in elevation less than four (< 4') feet from the traveled way, exceeds one inch (> 1") but does not exceed three inches (≤ 3 ") between the travel lane and any type of shoulder.

The spacing of the signs shall not exceed one (1) mile and the signs shall be placed immediately past each crossroad intersection. The "Low" signs shall remain in place until the difference in elevation is eliminated and the shoulder has been dressed and permanently grassed for a minimum of thirty (30) calendar days. These signs shall be furnished, installed, maintained and removed by the Contractor as part of Traffic Control-Lump Sum. These signs shall be fluorescent orange with black borders.

2. Shoulder Drop-Off for Construction/Reconstruction/Resurfacing Project

“Shoulder Drop-Off” (W8-17) signs shall be used when a difference in elevation, less than four feet ($< 4'$) from the traveled way, exceeds three inches ($> 3''$) and is not protected by positive barrier protection. These warning signs shall be placed in advance of the drop-off.

The spacing of the signs shall not exceed one (1) mile and the signs shall be placed immediately past each crossroad intersection. The “Shoulder Drop-Off” signs shall remain in place until the difference in elevation is eliminated and the shoulder has been dressed and permanently grassed for a minimum of thirty (30) calendar days. These signs shall be furnished, installed, maintained, and removed by the Contractor as part of Traffic Control-Lump Sum. These signs shall be black borders on fluorescent orange background.

H. Bump Signage

A bump sign (W8-1) shall be utilized when a transverse joint in the pavement structure has a vertical difference in elevation of three quarters ($\geq 3/4''$) of an inch or greater in depth with no horizontal taper to ramp the traffic from one elevation to the other. This condition typically occurs at approach slabs during pavement milling operations and at transverse joints in asphaltic pavement lifts. Other conditions include utility and storm drainage repairs that require concrete placement for patching and/or steel plating.

The W8-1 sign shall be placed sufficiently in advance to warn the motorist of the condition.

I. Sign Visibility

All existing, interim and new permanent signs shall be installed so as to be completely visible and legible for an advance distance in compliance with the MUTCD. Any clearing required for maintaining the line of sight to existing, interim or permanent signs shall be done as part of the requirements of the TTC plan. The clearing shall include any advance warning signs, both interim and permanent, that are installed as a part of the work including advance warning signs that are installed outside the limits of the project. Limbs, brush, construction equipment and materials shall be kept clear of the driver’s line of sight to all signs that are part of the TTC plan.

150.3.04 Advance Warning Signs

A. Project Signs - All Type of Highways

Advance warning signs shall be placed ahead of the work area in accordance with Part 6 of the MUTCD and shall include a series of at least three advance road work (W20-1) signs placed at the termini of the project. The series shall have the legend ROAD WORK (1500 FEET, 1000 FEET, AND 500 FEET).

At grade intersecting roadways and on-ramps shall be signed with a minimum of one ROAD WORK AHEAD sign.

When work terminates at a “T” intersection, a minimum of one “ROAD WORK AHEAD” sign shall be placed in advance of the intersection and one “END ROAD WORK” sign shall be placed at the termination end of the intersection. Field conditions may require the use of additional warning signage.

1. State Routes

Advanced Warning Signs on State Routes shall be a minimum dimension of forty-eight inches by forty-eight inches (48” x 48”). When a State Route intersects a project which consists of adding travel lanes, reconstructing an existing roadway or new location work, the State Route approaches shall have a

minimum of three (W20-1) advanced warning signs (1500 ft., 1000 ft., 500 ft.). The termination end of an intersecting State Route shall have END ROAD WORK signage.

The W20-1 signs shall be placed at the termini of the project or sufficiently in advance of the termini to allow for lane shifts, lane closures and other activities which may also require advanced warning signs. The advanced warning signs for the project should not overlap with the advanced warning signs for lane shifts, lane closures, etc.

The length of a work zone should be held to the minimum length required to accomplish the work. If a project has multiple individual worksites within the overall limits of the project, each site should be signed individually if the advance warning signs for each site can be installed without overlapping an adjacent worksite. As soon as the work is completed at any individual site, the warning signs shall be removed from that site. Clean-up work and punch list work shall be performed with portable signage.

Project mileage indicated on the G20-1 sign shall be the actual project mileage rounded up to the nearest whole mile. Projects less than two (< 2) miles in length or individual worksites that are part of a multiple worksite project may delete this sign. The G20-1 sign shall be forty-eight inches by twenty-four inches (48" x 24") and the G20-2 sign shall be forty-eight inches by twenty-four inches (48" x 24").

2. Interstate, Limited Access and Multilane Divided Highways

In addition to the W20-1 signs required at 500 ft., 1000 ft. and 1500 ft., multi-lane divided highways shall also have additional advanced warning signs installed with the legend "ROAD WORK (2 MILES, 1 MILE and 1/2 MILE). All construction warning signs on divided highways shall be double indicated (i.e., on the left and right sides of the roadway.) If the use of the half (1/2) mile, one (1) mile and two (2) mile advanced warning signs cause an overlap with other work or do not benefit field conditions then the Engineer may review the use of these signs and eliminate their installation. When the posted speed limit is fifty (\leq 50) mph or less, the one-half (1/2) mile, one (1) mile and two (2) mile signs should be eliminated especially in urban areas.

The W20-1 advance warning signs for ROAD WORK 500 FEET; 1000 FEET; and 1500 FEET shall be temporarily covered when work involving the advanced warning signs for lane shifts and lane closures overlap these signs. The ROAD WORK 1/2 MILE, ROAD WORK 1 MILE, and ROAD WORK 2 MILES shall be in place when the 500, 1000 and 1500 foot signs are temporarily covered.

When the temporary traffic control zone already has advanced warning (W20-1) signs installed the W20-1 signs required for lane closures under Standard 9106 should be eliminated.

3. Ramp Work on Limited Access Highways

The work zone shall not be signed for the entire length of the mainline of a limited access highway when only short individual worksites, interchange or ramp work is being performed.

When work is restricted to ramp reconstruction or widening activities, the advance warning signs on the mainline section of the limited access highway shall be limited to the use of portable advance warning signs. These portable advance warning signs shall only be utilized when work activity is within the gore point of the ramp and the mainline traveled way or work is active in the acceleration/deceleration lane adjacent to the mainline traveled way. Portable advance warning signs (W20-1: 1500 ft. /1000 ft. /500 ft.) shall be installed on the traveled way of the limited access highway when the above conditions are present. The advance warning signs shall be installed only in one direction where work is active. All portable signs shall be double indicated. When work is not active, the ramp work shall be advanced warned by the use of a single forty-eight inches by forty-eight inches (48" x 48") "ROAD WORK AHEAD" (W20-1) with an "ON RAMP" plaque (W13-4p) sign along the right shoulder of the mainline traveled way prior to the beginning of the taper for the deceleration lane. Differences in elevation shall be in compliance with the requirements of Subsection 150.3.11 prior to the removal of the portable (W20-1) advanced warning signs from the mainline.

B. Highway Work Zone

In accordance with Georgia Code, O.C.G.A. § 40-6-188, all sections or segments of the roadway under construction or reconstruction shall be signed as a Highway Work Zone except non-state highway two-lane two-way resurfacing projects. Two conditions can be applied to a Highway Work Zone. Condition 1 is when no reduction in the existing speed limit is required. Condition 2 is when worksite conditions require a reduction of the speed limit through the designated Work Zone. Properly marking a Highway Work Zone shall include the following minimum requirements:

1. No Reduction in the Existing Posted Speed Limit in Highway Work Zone

- a. Signage shall be posted at the beginning point of the Highway Work Zone warning the traveling public that increased penalties for speeding violations are in effect. The beginning point of Highway Work Zone is at the project limits, start of work zone, or at the start of the first taper. The HWZ-2 sign shall be placed a minimum of 600 feet in advance of the Highway Work Zone and shall not be placed more than 1000 feet in advance of the Work Zone. If no speed reduction is required, it is recommended that the HWZ-2 be placed at 750 feet from the work area between the ROAD WORK 500 FT. and the ROAD WORK 1000 FT. signs.

HWZ-2 signs shall be placed at intervals not to exceed one mile for the length of the project. HWZ-2 signs should be placed on the mainline after all major intersections except State Routes. State Routes shall be signed as per the requirements for intersecting roadways below.

- b. The existing speed limit shall be posted at the beginning of the Work Zone. Existing Speed Limit signs (R2-1) shall be maintained.
- c. Intersecting state routes shall be signed in advance of each intersection with the Work Zone with a HWZ-2 sign to warn motorists that increased fines are in effect. All other intersecting roadways that enter into a designated Highway Work Zone may be signed in advance of each intersection with the Work Zone. When construction equipment and personnel are present in the intersection on the mainline of a multi-lane roadway, the intersecting side roads shall be signed in advance with HWZ-2 signs. As soon as the work operation clears the intersection, the signage may be removed.
- d. Sign HWZ-3 shall be posted at the end of the Highway Work Zone indicating the end of the zone and indicating that increased penalties for speeding violations are no longer in effect.
- e. When a designated Highway Work Zone is no longer necessary, all signs shall be removed immediately.

2. Reducing the Speed Limit in a Highway Work Zone

Highway Work Zone signs shall be posted as required in Condition 1 above in accordance with Detail 150-C.

A “Reduce Speed Limit Ahead” (W3-5) sign shall be posted 600 feet prior to the reduced speed limit.

Then a “Speed Limit” signage (R2-1) for the reduced speed limit shall be erected at the beginning of the work zone. Additional signs shall be placed at whichever is least:

- a. on non-interstate roads after every junction with a numbered (state or U.S.) route.
- b. on interstates entrance ramp 1,500 feet from the end of the entrance taper. Detail 150-D
- c. on non-interstate and interstate a maximum spacing of no greater than one (1) mile apart.

On multi-lane divided highways, the speed limit signs shall be double indicated when the reduced speed is in use.

Additional signs may be necessary to adjust for actual field conditions.

For limited access (interstate) highways and controlled access multi-lane divided highways, the posted speed limit shall be reduced as required below.

When any one or more of the following conditions exist and the existing speed limit is sixty-five (65) mph or seventy (70) mph, the speed limit shall be reduced by ten (10) mph. If the existing speed limit is sixty (60) mph, the speed limit should be reduced by five (5) mph. If the existing speed limit is fifty-five (≤ 55) mph or less, the Contractor can only reduce the speed limit with the prior approval of the Engineer. The reduction in the speed limit shall be no greater than ten (10) mph:

- a) Lane closure(s) of any type and any duration.
- b) The difference in elevation exceeds two inches ($> 2''$) adjacent to a travel lane as shown in Subsection 150.3.11, Detail 150-E, Detail 150-F.
- c) Any areas where equipment or workers are within ten feet (10') of a travel lane.
- d) Temporary portable concrete barriers located less than two feet (2') from the traveled way.
- e) As directed by the Engineer for conditions distinctive to this project.

When the above conditions are not present, the speed limit shall be immediately returned to the existing posted speed limit. A speed reduction shall not be put in place for the entire length of the project unless conditions warranting the speed reduction are present for the entire project length. All existing speed limit signs within the temporary speed reduction zone shall be covered or removed while the temporary reduction in the speed limit is in effect. All signs shall be erected to comply with the minimum requirements of the MUTCD.

At a minimum, the following records shall be kept by the WTCS:

- a) Identify the need for the reduction.
- b) Record the time of the installation and removal of the temporary reduction.
- c) Fully describe the location and limits of the reduced speed zone.
- d) Document any accident that occurs during the time of the reduction.

A copy of the weekly records for reduced speed zones shall be submitted to the Engineer.

When a pilot vehicle is used on a two-lane two-way roadway, the speed limit should not be reduced. For special conditions specific to the work, on two-lane two-way roadways or multi-lane highways, the contractor may reduce the posted speed limit with the prior approval of the Engineer.

3. Variable Speed Limit Zones

Projects that are within or extends into variable speed limit zones shall be posted according to condition 1 with HWZ-1, HWZ-2, and HWZ-3 signs. No additional "speed limit" signs, (R2-1), shall be posted. Any reduction or increase in speed limits will be controlled by the normal operation of the variable speed limit system.

Upon request, a maximum speed limit of fifty-five (55) mph can be set for the project limits.

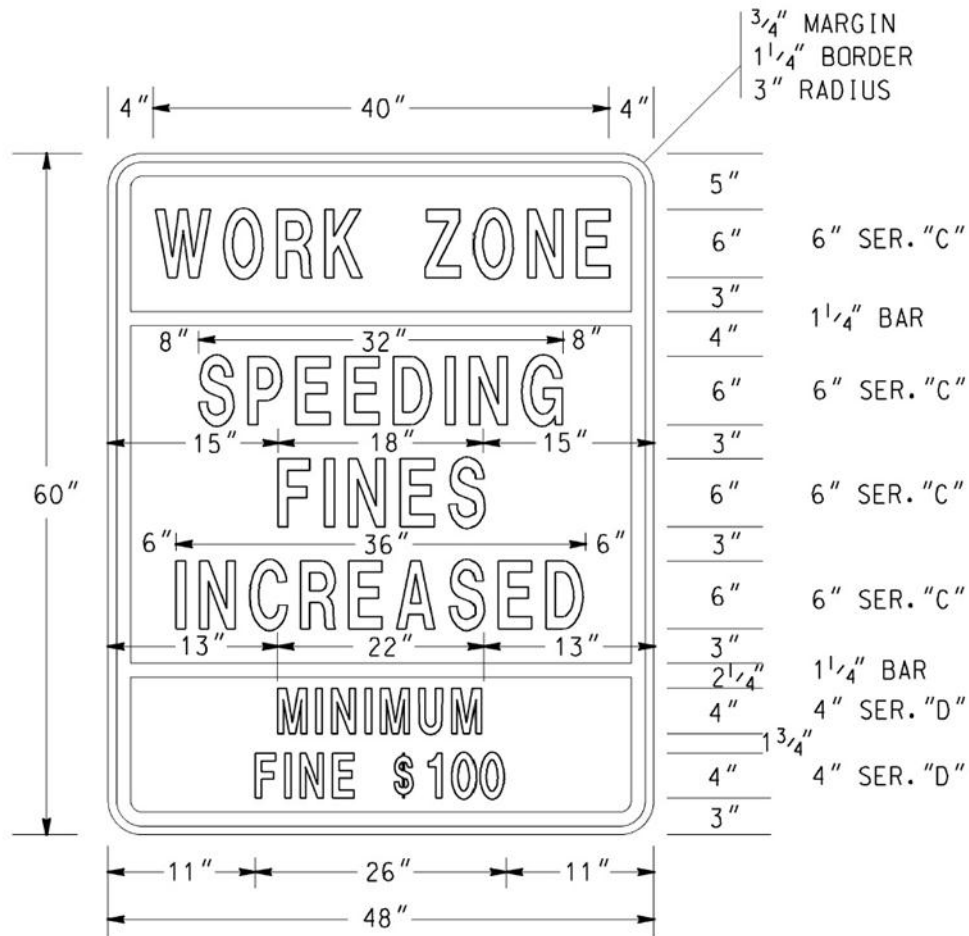

HWZ-2

COLORS

TOP PANEL

LEGEND & BORDER - BLACK (NON-REFL)
 BACKGROUND - FLUORESENT ORANGE

MIDDLE & BOTTOM PANELS

LEGEND & BORDER - BLACK
 BACKGROUND - WHITE

NOTES:

1. ALL HWZ-2 SIGN PANELS SHALL BE RIGID.
2. THE SIZE OF THE HWZ-2 SIGN SHALL NOT BE REDUCED FOR USE ON TWO-LANE ROADWAYS.

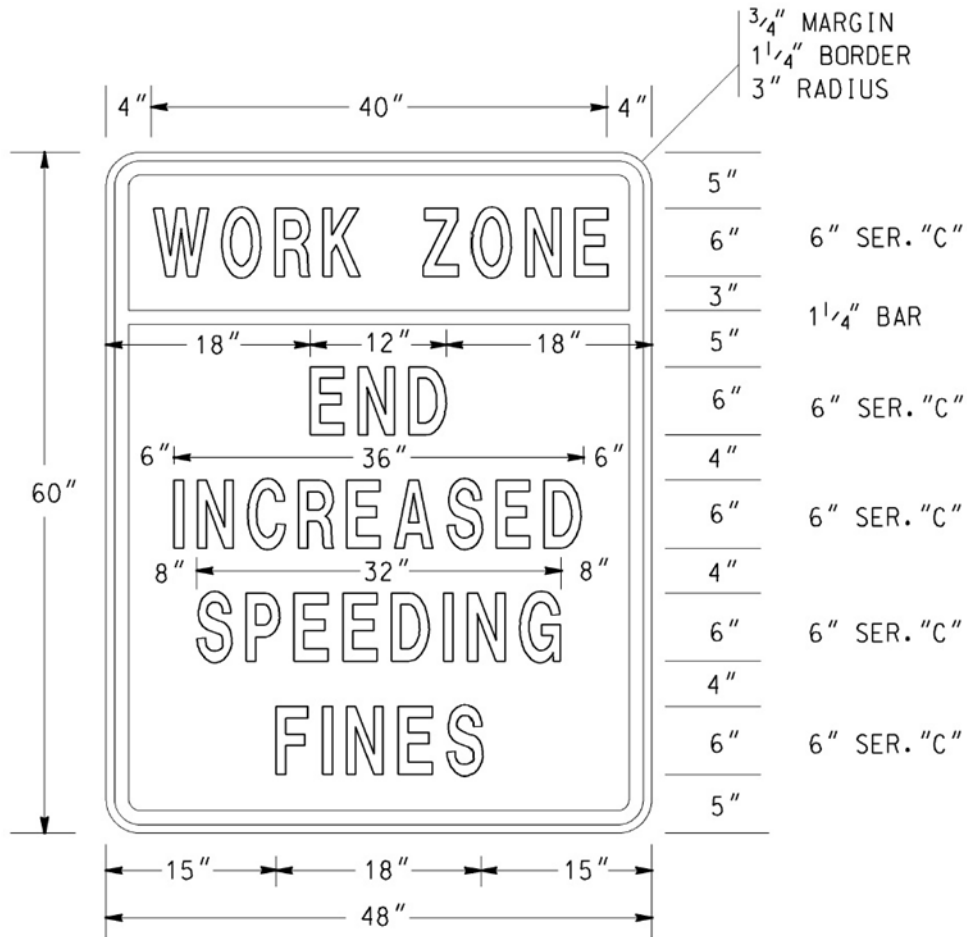

HWZ-3

COLORS

TOP PANEL

LEGEND & BORDER - BLACK (NON-REFL)
BACKGROUND - FLUORESENT ORANGE

BOTTOM PANEL

LEGEND & BORDER - BLACK (NON-REFL)
BACKGROUND - WHITE

NOTES:

1. ALL HWZ-3 SIGN PANELS SHALL BE RIGID.
2. THE SIZE OF THE HWZ-3 SIGN SHALL NOT BE REDUCED FOR USE ON TWO-LANE ROADWAYS.

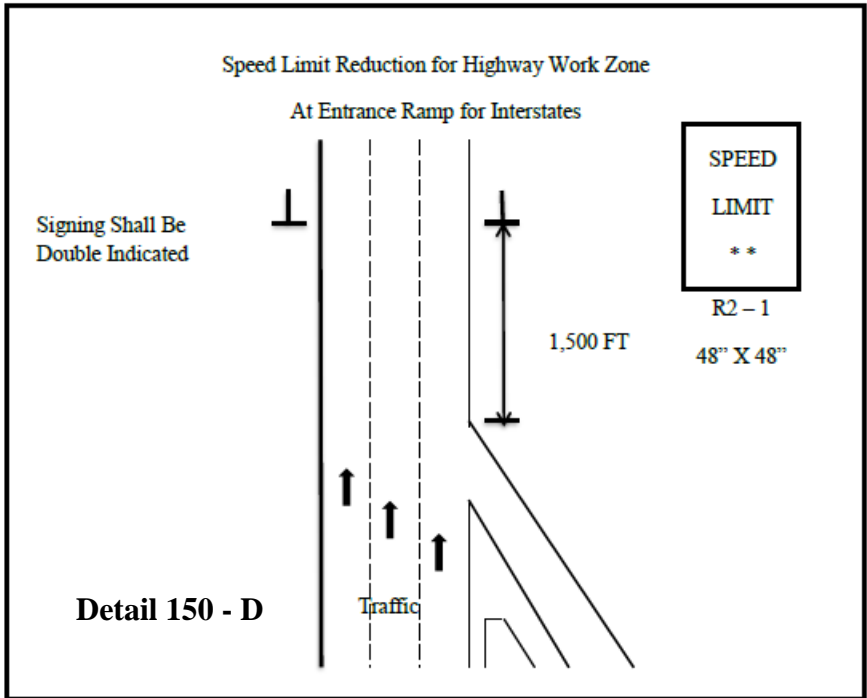
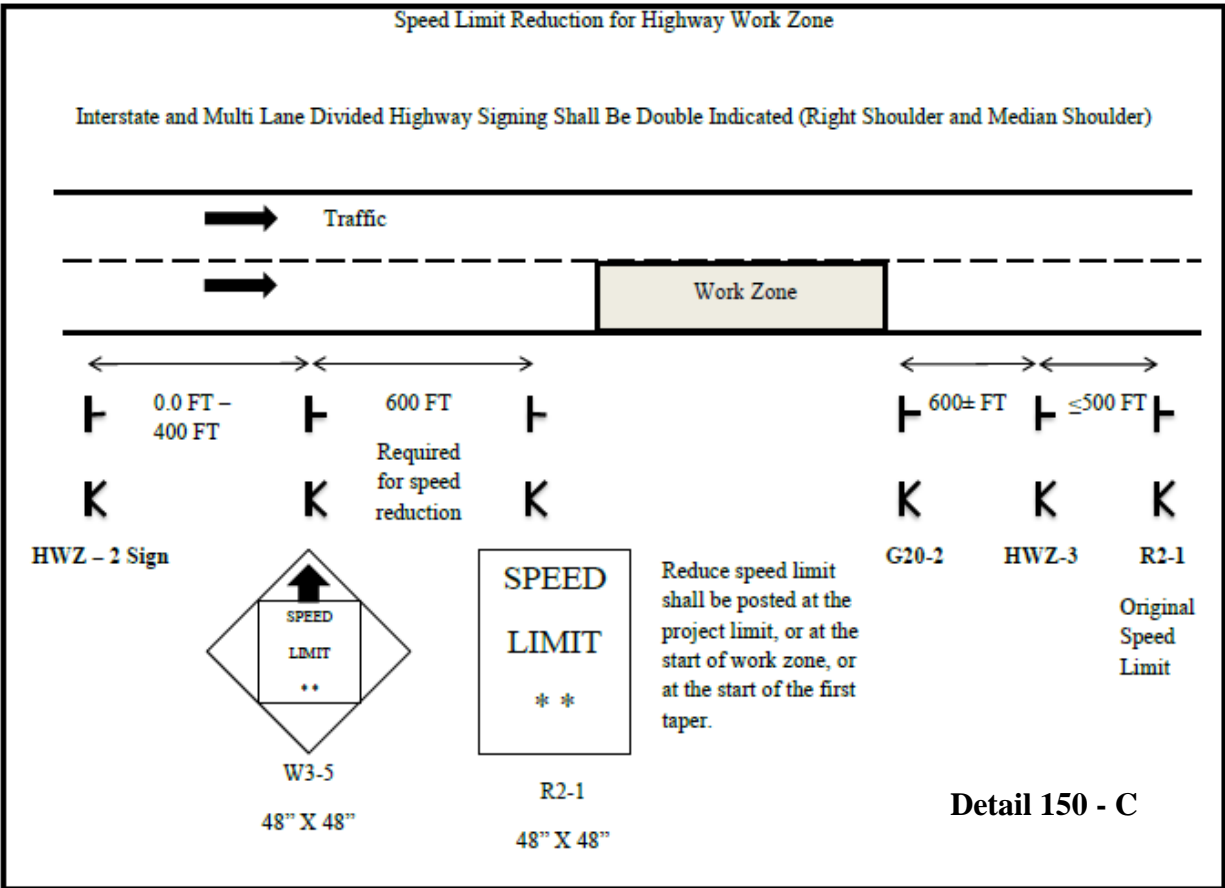

C. Installation/Removal of Work Area Signage

No payment will be made for Traffic Control-Lump Sum until the Work has actually started on the project. The installation of traffic control signage does not qualify as the start of work. Advanced warning signs shall not be installed until the actual beginning of work activities. Any permanent mount height signs installed as the work is preparing to start shall be covered until all signs are installed unless all signs are installed within seven (≤ 7) calendar days after beginning installation.

All temporary traffic control devices shall be removed as soon as practical when these devices are no longer needed. When work is suspended for short periods of time, temporary traffic control devices that are no longer appropriate, shall be removed or covered.

All construction warning signs shall be removed within seven (≤ 7) calendar days after time charges are stopped or pay items are complete. If traffic control devices are left in place for more than ten (> 10) calendar days after completion of the Work, the Department shall have the right to remove such devices, claim possession thereof, and deduct the cost of such removal from any monies due, or which may become due, the Contractor.

PUNCH LIST WORK: Portable signs shall be utilized to accomplish the completion of all punch list items. The portable signs shall be removed daily. All permanent mount height signs shall be removed prior to the beginning of the punch list work except "Low/Soft Shoulder" signs and any signs that have the prior written approval of the Engineer to remain in place while the punch list work is in progress.

Failure to promptly remove the construction warning signs within the seven (7) calendar days after the completion of the Work or failure to remove or cover signs when work is suspended for short periods of time shall be considered as non-performance under Subsection 150.5.01.

150.3.05 Shoulder/Lane Closures

A. Approval/Restrictions

All shoulder closures and lane closures of any type or duration shall have the prior approval of the Engineer.

1. Closure Length

The length of a shoulder closure and a lane closure shall not exceed two (2) miles in length excluding the length of the tapers unless the prior approval of the Engineer has been obtained. The Engineer may extend the length of the closure based upon field conditions; however, the length of a work zone should be held to the minimum length required to accomplish the Work. Shoulder closure and Lane Closures shall not be spaced closer than one mile. The advanced warning signs for the project should not overlap with the advanced warning signs for lane shifts, lane closures, etc.

2. Duration

The first three (3) calendar days of any lane closure shall be signed and marked as per Georgia Standard 9106 "Traffic Control Detail for Lane Closure on Multi-Lane Divided Highway" or Georgia Standard 9107 "Traffic Control Detail for Lane Closure on Multi-Lane Undivided Highway". However, lane closures that exist for a duration longer than three (> 3) calendar days may be signed and marked as per the details in Georgia Standard 9121 "Tapers, Signs, and Markings for Passing Lanes", provided the prior approval of the Engineer is obtained. The approved lane drop shall utilize only the signs and markings shown for the termination end of the lane drop in Georgia Standard 9121. All warning signs in the lane

drop sequence shall be used. Drums may be substituted for the Type I Crystal Delineators at the same spacing.

B. Shoulder Closures

In accordance with MUTCD 6G.07, when paved shoulders, having a width of eight feet ($\geq 8'$) or more are closed, at least one (1) advance warning sign shall be used. The sign(s) should read SHOULDER CLOSED (W21-5a). The signs are only posted on the side with the shoulder closure. Where the downstream end of the shoulder closure extends beyond the distance that can be perceived by road users, a supplementary plaque bearing the message NEXT XX FEET(W16-4P) or MILES (W7-3aP) should be placed below the SHOULDER CLOSED (W21-5a) sign. These signs shall be placed 500 feet prior to the shoulder closure. For multi-shoulder closures, the Shoulder Closed sign shall be repeated after two (2) miles at 500 feet prior to the next shoulder closure.

A shoulder closure will require a shoulder taper of $(1/3)L$ (L =merging taper length). Traffic drums shall be used for the taper. Arrow boards are not required.

If positive barriers are used to close the shoulder, the taper and drums shall be in accordance with Standard 4960, Temporary Barrier (End Treatment Options). The approach end of the barrier taper should be 10:1 or flatter slope.

C. Lane Closure

1. Advance Warning Signs

The advance Warning signs shall be in accordance with MUTCD and Georgia Standard 9106 "Traffic Control Detail for Lane Closure on Multi-Lane Divided Highway" and Georgia Standard 9107 "Traffic Control Detail for Lane Closure on Multi-Lane Undivided Highway".

When the temporary traffic control zone already has advanced warning (W20-1) signs installed the W20-1 signs required for lane closures under Standard 9106 and 9107 should be eliminated.

For Interstate, Limited Access and Multi-lane Divided Highways, an additional Portable Changeable Message Sign (PCMS) shall be placed one (1) mile in advance of a lane closure with a message denoting the appropriate lane closure one (1) mile ahead. No other message shall be displayed on this PCMS. The PCMS shall be placed on the outside shoulder in accordance with Detail 150-B [PCMS]. This is in addition to the other traffic control devices required by Standard 9106.

At the discretion of the Engineer, the Contractor may start placing advance warning signs a half-hour (1/2 hr.) prior to the lane closure.

2. Transition Area – Taper

Drums shall be used on all transition tapers. If traffic drums with retroreflectivity of less than type VI are used for a merge taper that exists into the night, all drums located in the taper shall have, for the length of the taper only, a six inch (6") fluorescent orange (ASTM Type VI, VII, VIII, IX or X) reflectorized top stripe on each drum. The top six inch (6") stripe may be temporarily attached to the drum while in use in a taper. The Engineer may allow the fluorescent orange reflectorized six inch (6") top stripe on each drum in a merging taper to remain in place during daylight hours provided there is a lane closure(s) with a continuous operation that begins during one nighttime period and ends during another nighttime period. All drums that have the six inch (6") top stripe permanently attached shall not be used for any other conditions.

In accordance with MUTCD (6C.08), the minimum length for a merging taper for a lane closure on the travel way shall be as shown in Table 150-1:

TABLE 150-1

Posted Speed Limit, MPH	Lane Width 9 Feet	Lane Width 10 Feet	Lane Width 11 Feet	Lane Width 12 Feet	Maximum Drum Spacing in Tapers, (Feet)
Minimum Taper Length (L) in Feet					
20	60	70	75	80	20
25	95	105	115	125	25
30	135	150	165	180	30
35	185	205	225	245	35
40	240	270	295	320	40
45	405	450	495	540	45
50	450	500	550	600	50
55	495	550	605	660	55
60	540	600	660	720	60
65	585	650	715	780	65
70	630	700	770	840	70
75	675	750	825	900	75

If site conditions require a longer taper, then the taper shall be lengthened to fit particular individual situations.

The length of shifting tapers should be at least one-half (1/2) L.

Multiple Lane Closures:

- a. A maximum of one (1) lane at a time shall be closed with each merge taper.
- b. A minimum tangent length of two (≥ 2) L shall be installed between each individual lane closure taper. The tangent length is part of the transition area. Therefore, only traffic drums can be used in the tangent.

3. Activity Area

The activity area consists of a buffer and the work space. Georgia Standard 9106 “Traffic Control Detail for Lane Closure on Multi-Lane Divided Highway” states “Buffer zones of 300’ minimum, 500’ desirable are required for tangent sections and shall be increased for horizontal or vertical curves due to sight distance considerations”

Georgia Standard 9107 “Traffic Control Detail for Lane Closure on Multi-Lane Undivided Highway” requires a fifty feet (50’) buffer. The buffer shall be increased for horizontal or vertical curves due to sight distance considerations”

The channelization devices are spaced at a maximum of eighty feet (80’).

4. Termination Area

Georgia Standard 9106 “Traffic Control Detail for Lane Closure on Multi-Lane Divided Highway” requires a 150 feet buffer and a minimum 200 feet downstream taper.

Georgia Standard 9107 “Traffic Control Detail for Lane Closure on Multi-Lane Undivided Highway” requires 150 feet downstream taper.

D. Removal of Lane Closures

To provide the greatest possible convenience to the public in accordance with Section 107, the Contractor shall remove all signs, lane closure markings, and devices immediately when lane closure work is completed or temporarily suspended for any length of time or as directed by the Engineer. All portable signs and portable sign mounting devices shall be removed from the roadway to an area which will not allow the sign to be visible and will not allow the sign or sign mounting device to be impacted by traffic. All devices shall be stored beyond the clear zone or behind positive protection.

E. Exit and Entrance Ramps

On multi-lane highways, where traffic has been shifted to the inside lanes, the exit and entrance ramps shall have drums placed on both sides of the ramp. This requirement will apply to any situation where traffic is shifted to contra flows or inside staging lanes to facilitate reconstruction work in the vicinity of exit and entrance ramps. The temporary ramp taper length should be greater than, or equal to, the existing taper length. Interim EXIT gore signs shall be placed at the ramp divergence. The “EXIT OPEN” sign shown in Figure TA-42 of the MUTCD shall be utilized. For exit ramps, drums spacing shall be decreased to ten feet (10’) for 200 feet in advance of the temporary gore, and be decreased to ten feet (10’) for the first 100 feet of the temporary gore, and throughout the exit ramp. For on-ramps, drums should be used 200 feet prior to the ramp and end 100 feet past the merge taper. The drum spacing for the on ramp may be decreased but should not obstruct the view of the drivers i.e. for the ramp vehicles.

150.3.06 Traffic Pacing Method

A. Pacing Of Traffic

With prior approval from the Engineer, traffic may be paced allowing the Contractor up to twenty (20) minutes maximum to work in or above all lanes of traffic for the following purposes:

1. Placing bridge members or other bridge work.
2. Placing overhead sign structures.
3. Other work items requiring interruption of traffic.

The Contractor shall provide a uniformed law enforcement officer with patrol vehicle and blue flashing light for each direction of pacing. The law enforcement officer, Engineer, and flaggers at ramps shall be provided with a radio which will provide continuous contact with the Contractor.

When ready to start the work activity, the law enforcement vehicle will act as a pilot vehicle slowing the traffic, thereby providing a gap in traffic allowing the Contractor to perform the Work. Any on-ramps between the pace and the work area shall be blocked during pacing of traffic, with a flagger properly dressed and equipped with a Stop/Slow paddle. Each ramp should be opened after the law enforcement vehicle has passed.

Pilot vehicles shall travel at a safe pace speed. The Contractor shall provide a vehicle to proceed in front of the law enforcement vehicle and behind the other traffic in order to inform the Contractor's work force when all vehicles have cleared the area.

Traffic should not be permitted to stop during pacing unless approved by the Engineer.

B. Methods of Signing For Traffic Pacing

At a point not less than 1,000 feet in advance of the beginning point of the pace, the Contractor shall place a portable changeable message sign with the message "TRAFFIC SLOWED AHEAD SHORT DELAY".

150.3.07 Flagging Operations

A. Flaggers

Flaggers shall be provided as required to handle traffic, as specified in the Plans or Special Provisions, and as required by the Engineer.

B. Flagger Certification

All flaggers shall meet the requirements of the MUTCD and shall have received training and a certificate upon completion of the training from one of the following organizations:

National Safety Council

American Traffic Safety Services Association (ATSSA)

On-line classes are not accepted.

Failure to provide certified flaggers as required above shall be reason for the Engineer suspending work involving the flagger(s) until the Contractor provides the certified flagger(s). Flaggers shall have proof of certification and valid identification (photo I.D.) available any time they are performing flagger duties.

C. Flagger Appearance and Equipment

Flaggers shall wear Performance Class 3 or better high-visibility clothing. Flagger stations shall be illuminated at night according to MUTCD (6F.82). They shall use a Stop/Slow paddle meeting the requirements of the MUTCD (6E.03) for controlling traffic. The Stop/Slow paddles shall have a shaft length of seven feet ($\geq 7'$) minimum. The Stop/Slow paddle shall be retroreflectorized for both day and night usage. In addition to the Stop/Slow paddle, a flagger may use a flag as an additional device to attract attention. This flag shall meet the minimum requirements of the MUTCD (6E.03). The flag shall, as a minimum, be twenty-four inches ($\geq 24''$) square and red or red/orange in color.

D. Flagger Warning Signs

Signs for flagger traffic control shall be placed in advance of the flagging operation, in accordance with the MUTCD and Georgia Standard 9102 “Traffic Control Detail for Lane Closure on Two-Lane Highway”. In addition, signs at regular intervals, warning of the presence of the flagger shall be placed beyond the point where traffic can reasonably be expected to stop under the most severe conditions for that day’s work.

E. Pilot Vehicle Requirements

Pilot vehicles should be required during placement of bituminous surface treatment or asphaltic concrete on two-lane roadways unless otherwise specified. Pilot vehicles shall meet the requirements of the MUTCD (6C.13).

F. Automated Flagger Assistance Devices

The Contractor may request, in writing, the use of Automated Flagger Assistance Devices (AFAD). The equipment shall meet the requirements of MUTCD (6E.04). As a part of this request, the Contractor shall also submit an alternate temporary traffic control plan in the event of a failure of the AFAD. Any alternate plan that requires the use of flaggers shall include the use of certified flaggers. The Contractor shall obtain the approval of the Engineer before the use of any AFAD will be permitted.

G. Portable Temporary Traffic Control Signals

The Contractor may request, in writing, the substitution of portable temporary traffic control signals for flaggers on two-lane two-way roadways provided the temporary signals meets the requirements of the MUTCD, Section 647, and subsection 150.2.11. As a part of this request, the Contractor shall also submit an alternate temporary traffic control plan in the event of a failure of the signals. Any alternate plan that requires the use of flaggers shall include the use of certified flaggers. The Contractor shall obtain the approval of the Engineer before the use of any portable temporary traffic control signals will be permitted.

150.3.08 Traffic Signals

A. Responsibility/Cost

If the sequence of operations, staging, or the temporary traffic control plan requires the relocation or shifting of any components of an existing traffic signal system then any work on these traffic signals will be considered as part of Traffic Control – Lump Sum.

B. Law Enforcement Officer Requirement

In accordance with Georgia law § 40-6-20, law enforcement officers shall be used to regulate and maintain traffic control at functioning signalized intersections when lane closures or traffic shifts block or restrict movements causing interference with road user flows and will not allow the activated traffic signal to guide the traffic through the signal site.

150.3.09 Mobile Operations

A mobile operation is defined by a minimum speed of three (3) mph. When pavement markings (centerlines, lane lines, and edge lines) are applied in a continuous operation by moving vehicles and equipment, the following minimum equipment and warning devices shall be required. These devices and equipment are in addition to the minimum requirements of the MUTCD.

All vehicles shall be equipped with the official slow moving vehicle symbol sign. All vehicles shall have a minimum of two (2) flashing or rotating beacons visible in all directions. All protection vehicles shall have an arrow panel mounted on the rear. All vehicles requiring an arrow panel shall have, as a minimum, a Type B panel. All vehicle mounted signs shall be mounted with the bottom of the sign a minimum height of forty-eight inches (48") above the pavement. All sign legends shall be covered or removed from view when work is not in progress.

The lead vehicle may be a separate vehicle or the work vehicle applying the pavement markings may be used as the lead vehicle. The lead vehicle shall have an arrow panel mounted so that the panel is easily visible to oncoming (approaching) traffic. The arrow panel should operate in the caution mode.

The work vehicle(s) applying markings shall have an arrow panel mounted on the rear. The arrow panel should typically operate in the caution mode. The work vehicle placing cones shall follow directly behind the work vehicle applying the markings.

A protection vehicle shall follow the last work vehicle at all times and shall be equipped with a truck mounted attenuator that shall be certified for impacts not less than sixty-two (62) mph in accordance with MASH/NCHRP350 Test Level Three (3).

150.3.10 Pavement Markings

A. General

Full pattern pavement markings in conformance with Section 3A and 3B, except 3B.02, of the MUTCD are required on all courses before the roadway is opened to traffic, unless noted in this section. No passing zones shall be marked to conform to Subsection 150.3.10.D.1.b. During construction and maintenance activities on all highways open to traffic, both existing markings and markings applied under this Section shall be fully maintained until Final Acceptance. If the pavement markings are, or become, unsatisfactory in the judgment of the Engineer due to wear, weathering, or construction activities, they shall be restored immediately.

Markings on the final surface course, which must be removed, shall be a removable type. The Contractor will be permitted to use paint, thermoplastic, or tape on pavement which is to be overlaid as part of the project, unless otherwise directed by the Engineer. Partial (skip) reflectorization (i.e. reflectorizing only a portion of a stripe) will not be allowed.

1. Resurfacing Projects

Pavement markings shall be provided on all surfaces that are placed over existing markings. Interim and final markings shall conform in type and location to the markings that existed prior to resurfacing unless changes or additions are noted in the Contract. The replacement of parking spaces will not be required unless a specific item or note has been included in the Contract. Any work to make additions to the markings that existed prior to resurfacing is to be considered as extra work.

2. Widening And Reconstruction Projects

If the lane configuration is altered from the preconstruction layout then pavement markings will be as required by the plans or the Engineer.

3. New Location Construction Projects

Pavement marking plans will be provided.

B. Installation and Removal of Pavement Markings

1. Installation

All pavement markings, both interim and permanent, shall be applied to a clean surface. The Contractor shall furnish the layout and preline the roadway surface for the placement of pavement markings applied as part of the temporary traffic control plan. All interim marking tape and RPM's on the final surface shall be removed prior to the placement of the final markings.

The Contractor shall sequence the work in such a manner as to allow the installation of markings in the final lane configuration at the earliest possible stage of the work.

2. Removal

Markings no longer applicable shall be removed in accordance with Section 656.

The elimination of conflicting pavement markings by overpainting with unapproved paint or any type of liquid asphalt is not acceptable.

3. Intermediate Surface

Interim markings shall be removed by methods that will cause minimal damage to the pavement surface, while also ensuring that traveling public will not be confused or misdirected by any residual markings remaining on the intermediate surface. The use of approved black-out tape and black-out paint (manufactured for the sole purpose of covering existing pavement markings) may be permitted on some interim surfaces, provided the results are satisfactory to the Engineer.

4. Final Surface

No interim paint or thermoplastic markings will be permitted on any final surface unless the interim markings are in alignment with the location of the permanent markings and the interim marking will not interfere or adversely affect placement of the permanent markings. The proposed method of removal for layout errors that require markings to be removed from the final surface shall have the prior approval of the Engineer. Any damage to the final pavement surface caused by the pavement marking removal process shall be repaired at the Contractor's expense by methods acceptable and approved by the Engineer. Section 400 shall apply when corrective measures are required. The use of black-out tape or black-out paint will not be permitted under any circumstance to correct layout errors on any final surface.

Traffic shifts that are done on the final surface shall be accomplished using interim traffic marking tape that can be removed without any blemishing of the final surface. Interim traffic marking tape shall be used on any of the following final surfaces; asphaltic concrete, Portland cement concrete, and bridge deck surfaces. The contractor may propose alternate traffic markings and removal methods on the final surface. Submitted proposals shall include the type of material, method of removal and a cost comparison to the traffic marking tape method. Prior to any approval, the contractor shall field demonstrate to the satisfaction of the Engineer that the proposed traffic markings can be removed without any blemishing of the final surface. If the proposal is determined to be acceptable, a supplemental agreement will be executed prior to the installation of the proposed alternate traffic markings. The supplemental agreement shall denote the type of

traffic marking materials, method of removal and any cost and/or time savings to the Department. The Department will not consider or participate in any cost increase that may result from implementing the proposed alternate method.

5. Pay Factor Reduction for Asphaltic Concrete Final Surfaces

When the correction of an error in the layout of the final pavement markings requires the final surface to be grounded, blemished, scarred, or polished the pay factor shall be reduced to 0.95 for the entire surface area of the final topping that has a blemish, polished or a scarred surface. The reduced pay factor shall not be confined to only the width and length of the stripe or the dimensions of the blemished areas, the whole roadway surface shall have the reduced pay factor applied. The area of the reduced pay factor shall be determined by the total length and the total width of the roadway affected. If the affected area is not corrected, the reduction in pay shall be deducted from the final payment for the topping layer of asphaltic concrete. The Engineer shall make the final determination whether correction or a reduced pay factor is acceptable.

The eradication of pavement markings on intermediate and final concrete surfaces shall be accomplished by a method that does not grind, polish, or blemish the surface of the concrete. The method used for the removal of the interim markings shall not spall chip the joints in the concrete and shall not damage the sealant in the joints. Any joint or sealant repairs shall be included in the bid price for Traffic Control-Lump Sum. The proposed method of removal shall have the prior approval of the Engineer.

Failure to promptly remove conflicting or non-applicable pavement markings shall be considered as non-performance under Subsection 150.5.01.

6. Preparation and Planning For Traffic Shifts

When shifting of traffic necessitates removal of centerline, lane lines, or edge lines, all such lines shall be removed prior to, during, or immediately after any change so as to present the least interference with traffic. Interim traffic marking tape shall be used as a temporary substitute for the traffic markings being removed.

Before any change in traffic lane(s) alignment, marking removal equipment shall be present on the project for immediate use. If marking removal equipment failures occur, the equipment shall be repaired or replaced (including leasing equipment if necessary), so that the removal can be accomplished without delay.

Except for the final surface, markings on asphaltic concrete may be obliterated by an overlay course, when approved by the Engineer. When an asphaltic concrete overlay is placed for the sole purpose of eliminating conflicting markings and the in place asphaltic concrete section will allow, said overlay will be eligible for payment only if designated in the Plans. Overlays to obliterate lines will be paid for only once and further traffic shifts in the same area shall be accomplished with removable markings. Only the minimum asphaltic concrete thickness required to cover lines will be allowed. Excessive build-up will not be permitted. When an overlay for the sole purpose of eliminating conflicting markings is not allowed, the markings no longer applicable shall be removed in accordance with Section 656.

C. Raised Pavement Markers

Retroreflective raised pavement markers (RPMs) should be placed as listed below for all asphaltic concrete pavements before the roadway is open to traffic, unless noted this section. On the final surface, RPM's shall be placed according to the timeframes specified in Subsection 150.3.10.D for full pattern pavement markings. When Portland Cement Concrete is an intermediate or final surface and is open to traffic, one (1) calendar day is allowed for cleaning and drying before the installation of RPMs is required.

Raised pavement markers are not allowed on the right edge lines under any situation.

Retroreflective raised pavement markers (RPMs) should be placed and/or maintained on intermediate pavements surfaces on all highways that are open to traffic. This includes all resurfacing projects along with widening and reconstruction projects. The RPMs shall be placed as follows:

1. Supplementing Lane Lines:
 - a. Eighty foot (80') center on skip lines with curvature less than three degrees. (Includes tangents)
 - b. Forty foot (40') centers on solid lines and all lines with curvature between three degrees and six degrees.
 - c. Twenty foot (20') centers on curves over six degrees.
 - d. Twenty foot (20') centers on lane transitions or shifts.
2. Supplementing Ramp Gore Lines:
 - a. Twenty foot (20') centers, two each, placed side by side.
3. Other Lines:
 - a. As shown on the plans or directed by the Engineer.

D. Exceptions for Interim Markings

Some exceptions to the time of placement and pattern of markings are permitted as noted below; however, full pattern pavement markings are required for the completed project.

1. Two-Lane, Two-Way Roadways
 - a. Skip Lines

If used, interim temporary tape or paint skip (broken) stripe may only be used for a maximum of three (3) calendar days. The stripes shall be at least two feet ($> 2'$) long with a maximum gap of thirty-eight feet ($\leq 38'$). On curves greater than six degrees ($>6^\circ$), a one-foot ($1'$) stripe with a maximum gap of nineteen feet ($\leq 19'$) shall be used. In lane shift areas, solid lines will be required.

Interim raised pavement markers may be substituted for the interim skip (broken) stripes. If raised pavement markers are substituted for the two foot ($2'$) interim skip stripe, three (3) markers spaced at equal intervals over a two foot ($2'$) distance will be required. No separate payment will be made if the interim raised pavement markers are substituted for interim skip lines.

Interim raised pavement markers shall be retro-reflective, shall be the same color as the pavement markers for which they are substituted, and shall be visible during daytime.

The type of interim marker and method of attachment to the pavement shall be approved by the Office of Materials and Testing but in no case will the markers be attached by the use of nails. Flexible reflective markers, Type 14 or Type 15, may be used for a maximum of three (3) calendar days as an interim marker. Any flexible reflective markers in use shall be from the QPL-76.

The interim raised pavement markers shall be maintained until the full pattern pavement markings are applied. At the time full pattern markings are applied the interim raised markers shall be removed in a manner that will not interfere with application of the full pattern pavement markings.

b. No Passing Zones Two-Lane, Two-Way Roadways

Passing zones shall be re-established in the locations existing prior to resurfacing. No changes to the location of passing zones shall be done without the written approval of the Engineer. For periods not to exceed three (3) calendar days where interim skip centerlines are in place, no-passing zones shall be identified by using post or portable mounted DO NOT PASS regulatory signs (R4-1) twenty-four inches by thirty inches (24" x 30") at the beginning and at intervals not to exceed one-half ($\leq 1/2$) mile within each no-passing zone. A post or portable mounted PASS WITH CARE regulatory sign (R4-2) twenty-four inches by thirty inches (24" x 30") shall be placed at the end of each no-passing zone. Post mounted signs shall be placed in accordance with the MUTCD. Portable signs shall be secured in such a manner to prevent misalignment and minimize the possibility of being blown over by weather conditions or traffic.

On new location projects and on projects where either horizontal or vertical alignments has been modified, the location of No-Passing Zones will be identified by the Engineer.

c. Edge lines

- Bituminous Surface Treatment Paving

Edge lines will not be required on intermediate surfaces (including asphaltic concrete leveling for bituminous surface treatment paving) that are in use for a period of less than sixty (<60) calendar days except at bridge approaches, on lane transitions, lane shifts, and in such other areas as determined by the Engineer. On the final surface, edge lines shall be placed within thirty (≤ 30) calendar days of the time that the final surface was placed.

- All Other Types of Pavement

Edge lines will not be required on intermediate surfaces that are in use for a period of less than thirty (<30) calendar days except at bridge approaches, on lane transitions, lane shifts, and in such other areas as determined by the Engineer. On the final surface, edge lines shall be placed within fourteen (≤ 14) calendar days of the time that the surface was placed.

2. Multi-Lane Highways – With No Paved Shoulder(s) or Paved Shoulder(s) Four Feet or Less ($\leq 4'$)

a. Undivided Highways (Includes Paved Center Turn Lane)

- Centerlines and No-Passing Barrier-Full Pattern centerlines and no-passing barriers shall be restored before opening to traffic.
- Lane lines- Interim skip (broken) stripe as described in Subsection 150.3.10.D.1.a. may be used for periods not to exceed three (≤ 3) calendar days. Skip lines are not permitted in lane shift areas. Solid lines shall be used.
- Edge lines- Edge lines shall be placed on intermediate and final surfaces within three (3) calendar days of obliteration.

b. Divided Highways (Grass or Raised Median)

- Lane lines- Full pattern skip stripe shall be restored before opening to traffic. Skip lines are not permitted in lane shift areas. Solid lines shall be required.
- Centerline/Edge line- Solid lines shall be placed on intermediate and final surfaces within three calendar days of obliteration.

3. Limited Access Roadways and Roadways with Paved Shoulders Greater Than Four Feet (> 4')
 - a. Same as Subsection 150.3.10.D.2 except as noted in (b) below.
 - b. Edge lines-
 - Asphaltic Concrete Pavement- Edge lines shall be placed on intermediate and final surfaces prior to opening to traffic.
 - Portland Cement Concrete Pavement- Edge lines shall be placed on any surface open to traffic no later than one calendar day after work is completed on a section of roadway. All water and residue shall be removed prior to daily striping.

4. Ramps for Multi-Lane Divided Highways

A minimum of one solid line edge stripe shall be placed on any intermediate surface of a ramp prior to opening the ramp to traffic. The other edge stripe may be omitted for a maximum period of three (3) calendar days on an intermediate surface. Appropriate channelization devices shall be spaced at a maximum of twenty-five feet (25') intervals until the other stripe has been installed.

The final surface shall have both stripes placed prior to opening the ramp to traffic.

5. Miscellaneous Pavement Markings

- a. Final Surface

School zones, railroads, symbols, words and other similar markings shall be placed on final surfaces conforming to Section 652 within fourteen (14) calendar days of completion of the final surface. Final markings shall conform to the type of pay item in the plans. When no pay item exists in the plans the final markings shall conform to Section 652 for painted markings.

- b. Intermediate Surface

Intermediate surfaces that will be in use for more than forty-five (45) calendar days shall have the miscellaneous pavement markings installed to conform to the requirement of Section 652. Under Subsection 150.6, Special Conditions, or as directed by the Engineer these markings may be eliminated.

- c. Stop Line

All stop signs and traffic signals shall have temporary twelve inch (12") stop lines placed in accordance with MUTCD (3B.16) on all surfaces prior to opening to traffic. Temporary tape can be used.

150.3.11 Differences In Elevations Between Travel Lanes And Shoulders

All time frames and requirements may be changed with the Engineer's approval.

A. Differences in Elevations

Difference in elevations due to construction between travel lanes and/or shoulders within the clear zone should be limited to the following:

1. Difference of two inches ($\leq 2''$) or less between adjacent travel lanes should remain for a maximum period of fourteen (14) calendar days.
2. Difference of two inches ($\leq 2''$) or less between adjacent travel lane and paved shoulder should remain for a maximum of thirty (30) calendar days. Traffic control devices shall be in accordance with Detail 150-G.
3. Difference of greater than two inches ($> 2''$) is permitted for continuous operations. Traffic control devices shall be in accordance with Detail 150-E.
4. Difference of greater than two inches ($> 2''$) between travel lanes and/or shoulders for non-continuous operations will not be allowed for more than a twenty-four (24) hour period. For the first twenty-four (24) hours, traffic control shall be in accordance with Detail 150-E. After twenty-four (24) hours the section should be healed according to Detail 150-H. This condition can exist for a maximum sixty (60) calendar days.
 - a. A single length of area that does not exceed 1000 feet total length may be left open as a startup area for periods not to exceed forty-eight (48) hours provided the Contractor can demonstrate the ability to complete the Work in a proficient manner. Prior approval of the Engineer shall be obtained before any startup area may be allowed.
 - b. For cement stabilized base, work adjacent to the travel lane and/or shoulders shall be healed as per Detail 150-H within forty-eight (48) hours after the seven (7) calendar day curing period is complete for each section placed. During the placement and curing period, traffic control shall be in accordance Detail 150-E.

Failure to meet these requirements shall be considered as non-performance of Work under Subsection 150.5.01.

B. Healed Section

Healed section and traffic control devices should be placed in accordance with Detail 150-H. If crushed stone materials are used to provide a healed section no separate payment will be made for the material used to heal any section. The Contractor may submit a plan to utilize existing pay items for crushed stone provided the plan clearly demonstrates that the materials used to heal an area will be incorporated into the work with minimal waste. Handling and hauling of any crushed stone used to heal shall be kept to a minimum. The Engineer shall determine if the crushed stone used to heal meets the specifications for gradation and quality when the material is placed in the final location.

C. Emergency Situations

Inclement weather, traffic accidents, and other events beyond the control of the Contractor may prevent the work from being completed as required above. The Contractor shall notify the Engineer in writing stating the conditions and reasons that have prevented the Contractor from complying with the time limitations. The Contractor shall also outline a plan detailing immediate steps to complete the work. Failure to correct these conditions on the first calendar day that conditions will allow corrective work shall be considered as non-performance of Work under Subsection 150.5.01.

D. Plating

Plating for drainage structures, utility facilities, etc. is prohibited on the interstates. Plating on State Routes and secondary roads will required the prior approval of the project engineer. Steel plates shall not be used on highways with a posted speed greater than forty-five (45) mph. The plate shall completely cover the pavement cut or excavation. The plate shall be adequately secured and shall provide a safe and reasonable transition to the adjoining roadway surface. An asphalt wedge can be used to provide a smooth transition over the plate(s). Temporary traffic control warning signs W8-24 shall be posted in advance warning motorist about plates in roadway in accordance with the MUTCD. Plating should not remain in place for more than four (4) calendar days.

E. Asphaltic Concrete Resurfacing Projects

1. Shoulder Construction Included as a Part of the Contract

When the placement of asphaltic concrete materials creates a difference in elevation greater than two inches (> 2”) between the earth shoulder (grassed or un-grassed) and the edge of travel lane or between the earth shoulder and a paved shoulder that is less than four feet (< 4’) in width, the Contractor shall place and maintain drums in accordance with the requirements of Subsection 150.2.04.B.3. When the edge of the paved surface is tapered with a safety edge, drums may be spaced at two (2) times the speed limit in MPH. Drums shall remain in place and be maintained until the difference in elevation has been eliminated by the placement of the appropriate shoulder materials.

2. Shoulder Construction Not Included as a Part of the Contract

When the placement of asphaltic concrete materials creates a difference in elevation greater than two inches (> 2”) between the earth shoulder (grassed or un-grassed) and the edge of travel lane or between the earth shoulder and a paved shoulder that is less than four feet (< 4’) in width, the Contractor shall notify the Engineer, in writing, when the resurfacing work including all punch list items has been completed.

Drums spaced at twenty foot (20') intervals. **Note:** If the travel way width is reduced to less than ten feet (< 10') by the use of drums, vertical panels shall be used in lieu of drums.

Location of drums when Elevation Difference exceeds four inches (> 4")

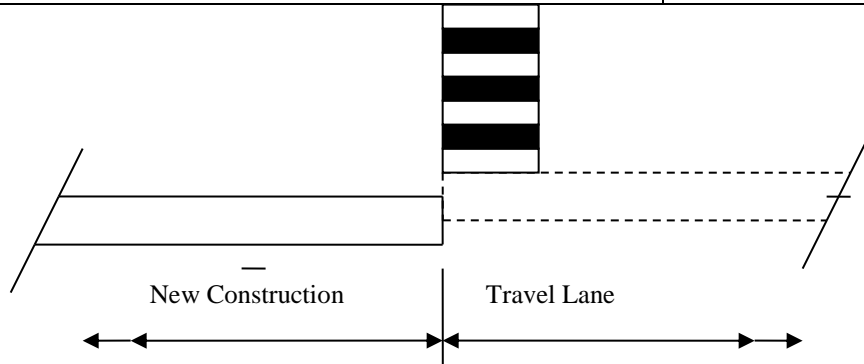

ELEVATION DIFFERENCE GREATER THAN FOUR INCHES (> 4")

DETAIL 150-E

Drums spaced at forty foot (40') intervals.

Location of drums when Elevation Difference is greater than two inches (> 2") to four inches (4")

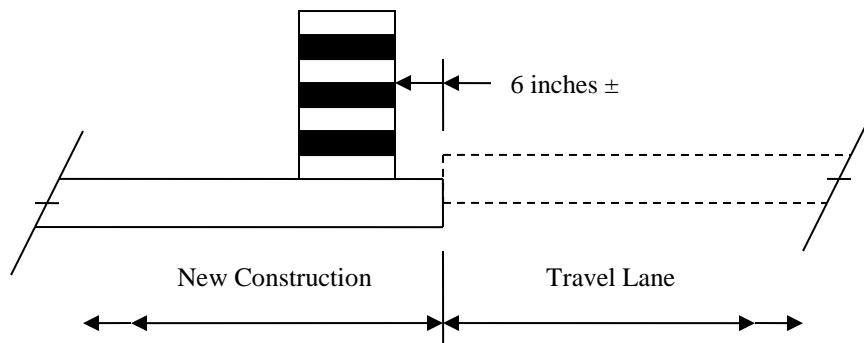

ELEVATION DIFFERENCE GREATER THAN TWO INCHES (> 2") TO FOUR INCHES (4")

DETAIL 150-F

Drums spaced at eighty foot (80') intervals.

Location of drums when Elevation Difference is two inches ($\leq 2''$) or less.

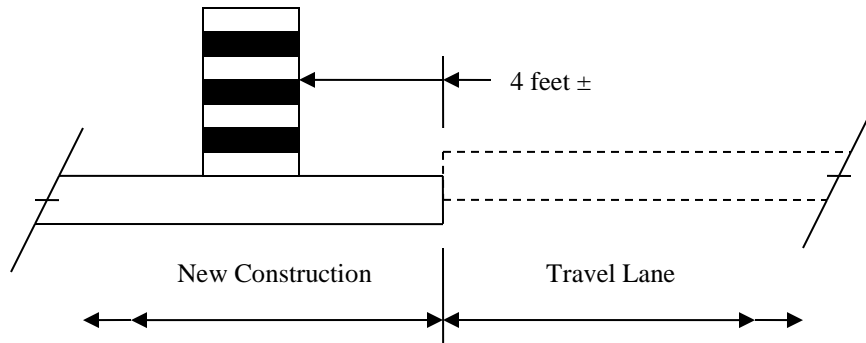

ELEVATION DIFFERENCE OF TWO INCHES ($\leq 2''$) OR LESS

DETAIL 150-G

Location of drums immediately after completion of healed sections spaced at 40 foot (40') intervals

Healed Section

Compacted graded aggregate, subbase material or dirt.

NO STEEPER THAN 4:1

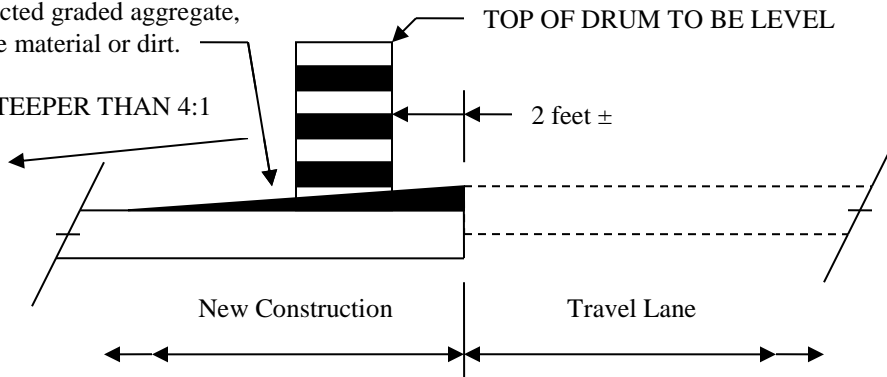

HEALED SECTION

DETAIL 150-H

150.3.12 Work Zone Law Enforcement

Work zone law enforcement consists of utilizing a uniformed law enforcement officer equipped with patrol vehicle and blue flashing lights to enforce traffic laws in construction work zones and the administration of this service. Payment for work zone law enforcement will be made only for the utilization in work zones during lane closures, traffic pacing, or other activities that occur within travel lanes. The Contractor will be responsible for negotiating a rate of reimbursement and making reimbursement to that law enforcement agency.

The Contractor will be responsible for coordinating and scheduling the utilization of the work zone law enforcement. The Engineer may require the use of work zone law enforcement at specific times and locations.

150.4 Measurement

150.4.01 Traffic Control Items

A. Traffic Control

When listed as a pay item in the Proposal, payment will be made at the lump sum price bid, which will include all traffic control not paid for separately, and will be paid as follows:

When the first Construction Report is submitted, a payment of twenty-five percent (25%) of the lump sum price will be made. For each progress payment thereafter, the total of the Project percent complete shown on the last pay statement plus twenty-five percent (25%) will be paid (less previous payments), not to exceed one hundred percent (100%).

When no payment item for Traffic Control-Lump Sum is shown in the Proposal, all of the requirements of Section 150 and the Temporary Traffic Control Plan shall be in full force and effect. The cost of complying with these requirements will not be paid for separately, but shall be included in the overall bid submittal.

B. Changeable Message Sign, Portable

Portable changeable message sign will be measured as specified in Section 632.

C. Flashing Beacon Assembly

Flashing beacon assemblies will be measured as specified in Section 647.

D. Pavement Markings

Pavement markings will be measured as specified in Section 150.

E. Portable Impact Attenuators

Each portable impact attenuator will be measured by the unit/array which shall include all material components, hardware, incidentals, labor, site preparation, and maintenance, including spare parts recommended by the manufacturer for repairing accident damage. Each unit will be measured only once regardless of the number of locations installed, moves required, or number of repairs necessary because of traffic damage. Upon completion of the project, the units shall be removed and retained by the Contractor.

F. Signs

When shown as a pay item in the contract, interim special guide signs will be paid for as listed below. All other regulatory, warning, and guide signs, as required by the Contract, will be paid for under Traffic Control Lump Sum or included in the overall bid submitted.

1. Interim ground mounted or interim overhead special guide signs will be measured for payment by the square foot. This payment shall be full compensation for furnishing the signs, including supports as required, erecting, illuminating overhead signs, maintaining, removing, re-erecting, and final removal from the Project. Payment will be made only one time regardless of the number of moves required.
2. Remove and reset existing special guide signs, ground mount or overhead, complete, in place, will be measured for payment per each. Payment will be made only one time regardless of the number of moves required.
3. Modify special guide signs, ground mount or overhead, will be measured for payment by the square foot. The area measured shall include only that portion of the sign modified. Payment shall include materials, removal from posts or supports when necessary, and remounting as required.

G. Temporary Audible Information Device

Temporary audible information devices are measured as the actual number furnished and installed in accordance with the manufacturer's recommendations, which shall include all necessary materials, equipment, labor, site preparation, maintenance and removal. Each temporary audible information device will be paid for only one time regardless of the number of times it's reused during the duration of The Work. These devices shall remain the property of the Contractor.

H. Temporary Barrier

Temporary barrier shall be measured as specified in Sections 620.

I. Temporary Curb Cut Wheelchair Ramps

Temporary curb cut wheelchair ramps are measured as the actual number formed and poured, complete and accepted, which shall include all necessary materials, equipment, labor, site preparation, maintenance and removal. No additional payment will be made for sawing existing sidewalk and removal and disposal of removed material for temporary wheelchair ramp construction. No additional payment will be made for constructing the detectable warning surface.

J. Temporary Guardrail Anchorage, Type 12

Temporary guardrail anchorage- type 12 will be measured by each assembly, complete in place and accepted according to the details shown in the plans, which shall also include the additional guardrail and appurtenances necessary for transition and connection to temporary concrete barrier. Payment shall include all necessary materials, equipment, labor, site preparation, maintenance and removal.

K. Temporary Walkways with Detectable Edging

Temporary walkways with detectable edging will be measured in linear feet (meters), complete in place and accepted, which shall include all necessary materials, equipment, labor, site preparation, temporary pipes, passing spaces, maintenance and removal. Excavation and backfill are not measured separately for payment. No payment will be made for temporary walkways where existing pavements or existing edging (that meets the requirements of MUTCD) are utilized for the temporary walkway. Payment for temporary detectable edging, including approved barriers and channelizing devices, installed on existing pavement shall be included in Traffic Control-Lump Sum.

L. Traffic Signal Installation- Temporary

Temporary traffic signal installation will be measured as specified in Section 647.

M. Work Zone Law Enforcement

When work zone law enforcement is shown as a pay item, work zone law enforcement will be measured for payment by the hour. The Contractor shall provide a daily work record containing the actual number of hours charged by the law enforcement officer. The daily work record shall be compiled on a form provided by the Department, signed by the law enforcement officer, signed by the Contractor's Worksite Traffic Control Supervisor attesting that the law enforcement was utilized during the time recorded, and then submitted to the Engineer.

Work zone law enforcement will be measured for payment by the hour up to the maximum number of hours included in the contract. The Engineer may at his discretion increase the maximum number of hours.

Payment shall be full compensation for reimbursing the law enforcement agency, and for all cost incurred by the Contractor in coordinating, scheduling, and administering the item work zone law enforcement.

If no work zone law enforcement pay item is included in the contract, then all work zone law enforcement cost shall be included in Traffic Control – Lump Sum.

150.5 Payment

When shown in the Schedule of Items in the Proposal, the following items will be paid for separately. Payment will be made under:

Item No. 150	Traffic control -	Lump sum
Item No. 150	Traffic control, solid traffic stripe ___ inch, (color)	Per linear mile
Item No. 150	Traffic control, skip traffic stripe ___ Inch, (color)	Per linear mile
Item No. 150	Traffic control, solid traffic stripe, thermoplastic 24 inch, color	Per linear mile
Item No. 150	Traffic control, raised pavement markers –all types	Per each
Item No. 150	Remove and reset, existing special guide signs, overhead, complete-in-place	Per each
Item No. 150	Temporary walkways with detectable edging	Per linear foot
Item No. 150	Temporary curb cut wheelchair ramps	Per each
Item No. 150	Temporary audible information device	Per each
Item No. 150	Single lane closure	Per each
Item No. 150	Multilane closure	Per each
Item No, 150	Work Zone Law Enforcement	Per hour

150.5.01 Enforcement and Adjustments

The safe passage of pedestrians and traffic through and around the temporary traffic control zone, while minimizing confusion and disruption to traffic flow, shall have priority over all other Contractor activities. Continued failure of the Contractor to comply with the requirements of Section 150 - Traffic Control will result in non-refundable deductions of monies from the Contract as shown in this Subsection for non-performance of Work.

Failure of the Contractor to comply with this Specification shall be reason for the Engineer suspending all other work on the Project, except erosion control and traffic control, taking corrective action as specified in Section 105, and/or withholding payment of monies due to the Contractor for any work on the Project until traffic control deficiencies are corrected. These other actions shall be in addition to the deductions for non-performance of traffic control.

SCHEDULE OF DEDUCTIONS FOR EACH CALENDAR DAY OF DEFICIENCIES OF TRAFFIC CONTROL INSTALLATION AND/OR MAINTENANCE		
ORIGINAL TOTAL CONTRACT AMOUNT		
From More Than	To and Including	Daily Charge
\$0	\$100,000	\$250
\$100,000	\$1,000,000	\$650
\$1,000,000	\$5,000,000	\$1,300
\$5,000,000	\$20,000,000	\$2,000
\$20,000,000	\$40,000,000	\$2,600
\$40,000,000	\$-----	\$4,000