



Express 250

DC Fast Charging Station

Site Design Guide
for Standalone and Paired Stations



IMPORTANT SAFETY INSTRUCTIONS: SAVE THESE INSTRUCTIONS



WARNING:

- 1. Read and follow all warnings and instructions before installing and operating the ChargePoint® Charging Station.** Install and operate only as instructed. Failure to do so may lead to death, injury, or property damage, and will void the Limited Warranty.
- 2. Only use licensed professionals to install your ChargePoint charging station and adhere to all national and local building codes and standards.** Before installing the ChargePoint® charging station, consult with a licensed contractor, such as a licensed electrician, and use a trained installation expert to ensure compliance with local building and electrical codes and standards, climate conditions, safety standards, and all applicable codes and ordinances. Inspect the charging station for proper installation before use.
- 3. Always ground the ChargePoint charging station.** Failure to ground the charging station can lead to risk of electrocution or fire. The charging station must be connected to a grounded, metal, permanent wiring system, or an equipment grounding conductor shall be run with circuit conductors and connected to the equipment grounding terminal or lead on the Electric Vehicle Supply Equipment (EVSE). Connections to the EVSE shall comply with all applicable codes and ordinances.
- 4. Install the ChargePoint charging station on a concrete pad using a ChargePoint approved method.** Failure to install on a surface that can support the full weight of the charging station can result in death, personal injury, or property damage. Inspect the charging station for proper installation before use.
- 5. This charging station is not suitable for use in or around hazardous locations, such as near flammable, explosive, or combustible materials.**
- 6. Do not use this product if the enclosure, EV cable, or the EV connector is broken, cracked, open, or shows any other indication of damage.**
- 7. Do not put fingers into the electric vehicle connector.**



Important: Under no circumstances will compliance with the information in this manual relieve the user of his/her responsibility to comply with all applicable codes or safety standards. This document describes the most commonly-used installation and mounting scenarios. If situations arise in which it is not possible to perform an installation following the procedures provided in this document, contact ChargePoint, Inc. **ChargePoint, Inc. is not responsible for any damages that may result from custom installations that are not described in this document or for any failure to adhere to installation recommendations.**

Product Disposal

To comply with Directive 2012/19/EU of the European Parliament and of the Council of 4 July 2012 on waste electrical and electronic equipment (WEEE), devices marked with this symbol may not be disposed of as part of unsorted domestic waste inside the European Union. Enquire with local authorities regarding proper disposal. Product materials are recyclable as marked.



No Accuracy Guarantee

Commercially reasonable efforts were made to ensure that the specifications and other information in this manual are accurate and complete at the time of its publication. However, the specifications and other information in this manual are subject to change at any time without prior notice.

Copyright and Trademarks

©2013-2019 ChargePoint, Inc. All rights reserved. This material is protected by the copyright laws of the United States and other countries. It may not be modified, reproduced or distributed without the prior, express written consent of ChargePoint, Inc. CHARGEPOINT is a U.S. and European Union registered trademark and service mark of ChargePoint, Inc. and cannot be used without the prior written consent of ChargePoint.

Symbols Used in This Document

This guide and product use the following symbols:



DANGER: Risk of electric shock.



WARNING: Risk of personal harm or death.



CAUTION: Risk of equipment or property damage.



Important: Crucial step for installation success.



Read the manual for instructions.



Ground/protective earth.

Contents

1	Site Design Guidelines	1
	Pairing Two Express 250s	2
	Initial Site Guidelines	2
	Plan for Future Charging Capacity	2
	Charging Station Placement	3
2	Civil and Mechanical Design	7
	Pad	8
	Drainage	9
	Mounting Specifications	9
	Clearances	10
	Ventilation	11
	Wheel Stops	11
	Bollards	12
	Pairing Previously Installed Charging Stations	14
	Accessibility	15
	Signage	15
3	Electrical Design	17
	Upstream Components	17
	Transformer Configuration	18
	AC Disconnect Switch	18
	RCD Use	18
	Grounding/Earthing Requirements	19
	Shunt Trip Wiring	20
	Conduit	21
	Wiring Requirements for Standalone Stations	22
	Additional Wiring Requirements for Paired Stations	22
	Wiring Diagram	25
	Cellular Connectivity	26
4	The Express 250 Concrete Mounting Template	27
	Bring Tools and Materials	28

CPE250-CMT Overview	29
Assemble the CPE250-CMT	31
Install the CPE250-CMT	32
Appendix A Examples of Express 250 Paired Wire Sizing	33



Site Design Guidelines 1

This document describes how to design an installation site for the ChargePoint® Express 250 DC fast charging station, and install the Concrete Mounting Template, before station installation.

The Express 250 is a DC fast charging station for electric vehicles. Each charging station communicates with ChargePoint using a cellular network. This connectivity is required for diagnostics and reporting, as well as communication with the online dashboard that allows the station owner to control its settings and commands. See the section [Cellular Connectivity \(page 26\)](#) for detailed information.



Important: Always follow all applicable local and national codes and requirements. A site drawing should be engineered for your specific site to reduce installation costs and ensure compliance with local codes. Local authorities might not allow a unit to operate if it is not installed to code.

Access ChargePoint documents online at chargepoint.com/guides or chargepoint.com/eu/guides for each phase of the project:

Document	Content	Audiences
<i>Express 250 Data Sheet</i>	Full station specifications	Site designer, installer, and station owner
This document	Civil, mechanical, and electrical guidelines to scope and construct the site	Site designer or engineer of record
<i>Concrete Mounting Template Guide</i>	Onsite instructions for installing the CMT with anchor bolts and conduit placement	Site construction contractor
<i>Express 250 Installation Guide</i>	Anchoring, wiring, and powering on	Installer
<i>Express 250 Operations and Maintenance Guide</i>	Operation and preventative maintenance	Station owner or facility manager
Full set of Field Replacement Guides	Component replacement procedures	Station owner or third party servicer

Installing the Express 250 requires two people and takes approximately 3-4 hours. This time estimate does not include the time needed to pull DC and Ethernet cable for a Paired installation if it is not already done. Paired installation might also require contacting a ChargePoint support technician to perform any required software updates and configuration if a station is being

retrofitted from Standalone to Paired.



Important: All installers must be licensed electricians and complete an online training course to become a ChargePoint certified installer. Installers who do not complete installation training cannot access the ChargePoint Network to complete pinpointing and station setup. To complete online training and become a certified installer, refer to ChargePoint University at: chargepoint.com/installers or chargepoint.com/eu/installers

Pairing Two Express 250s

The Express 250 can be installed either as a standalone system, or paired with another Express 250 using a DC connection to more flexibly share load. The two Power Modules in the base of each charging station can be shared in any combination according to charging need. This allows high power output in sites with space constraints.

To pair two Express 250 charging stations, all of the following are required:

- Additional conduit, ducting, or armored cable (according to region) correctly installed between the two charging stations for DC conductors and Ethernet wiring
- Both Express 250s must have 62.5 kW power enabled (not allowed on stations only enabled for 50 kW)
- Both Express 250s must be provisioned for full power back to the panel (not allowed on “power select” stations)

Initial Site Guidelines

An onsite evaluation is needed to determine conduit and wiring requirements from the panel to the proposed parking spaces, as well as to measure cellular signal levels and identify suitable locations for any necessary cellular signal booster equipment.

If you have pre-existing infrastructure or are using your own preferred electrical contractor to prepare your site, a completed Construction Signoff Form is required to certify compliance with electrical specification requirements, and to ensure everything was prepared to ChargePoint specifications.



Important: Always check local codes or consult an engineer to ensure the site is prepared in compliance with all applicable regulations. Local authorities might not allow a unit to operate if it is not installed to code.

Plan for Future Charging Capacity

ChargePoint recommends that you plan to install charging stations for 5-10% of parking spaces, or

10-15% for high EV adoption areas like California. Designing electrical infrastructure to support current and future needs for EV charging helps avoid costly upgrades later as demand for EV charging grows.

Consider these methods to prepare a site for future charging stations in a later phase of work:

- Add extra capacity if electrical panels are being upgraded now
- Use sub-panels as a way to shorten electrical paths
- Oversize the conduit between the main electrical panel and future stations
- Install pull or junction boxes at the end of an existing row of charging stations, to ease cable pulls for future stations
- If a junction box or disconnect will be installed between rows of stations, oversize the wiring between the main panel and the junction box to prevent needing to re-pull wire later

Charging Station Placement

To help minimize costs, choose station locations that are as close as possible to the available electrical infrastructure. Selecting these types of locations helps minimize long conduit and wire runs, as well as any trenching work.



WARNING: The ChargePoint charging station must be installed on a level concrete base. Asphalt cannot support the full weight of the charging station. Failure to install the ChargePoint charging station on a level concrete base may cause the charging station to tip over, resulting in death, personal injury, or property damage.

Layout considerations:

- Determine appropriate ground anchoring locations where concrete exists or can be installed (no asphalt surfaces).
- Consider locations where it will be easy to add future stations.
- Determine optimum conduit layout to minimize linear conduit costs to multiple parking spaces. If possible, avoid or minimize trenching requirements, especially more costly trenching to run conduit under asphalt surfaces.
- Evaluate existing electrical infrastructure to determine if the existing utility service and electrical panel capacity is sufficient. Identify costs for any necessary upgrades and/or a new dedicated electrical panel. ChargePoint recommends using a certified electrician to evaluate available capacity and identify any upgrades that may be required.
- If a dedicated EV electrical panel is required, choose a panel location in close proximity to the existing electrical supply.
- Measure cellular signal levels to ensure adequate cellular coverage at the station installation location. To ensure adequate signal strength in underground or enclosed parking structures, cellular repeaters may be required. For more information, see [Cellular Connectivity \(page 26\)](#).
- ChargePoint recommends to avoid locations under trees where sap, pollen, or leaves would fall on the charging station and increase the station owner's site upkeep workload.

- For stall parking, ChargePoint recommends using perpendicular parking stalls that allow a vehicle to enter either front-first or rear-first, to better accommodate the varied charge port locations on different EVs. Diagonal stall parking is not advised.

Note: While ChargePoint tests charging stations with a majority of upcoming vehicles, ChargePoint cannot guarantee the port locations of future vehicles and cannot warrant the configurations proposed will work for all vehicles.

- Choose adjacent parking spaces in an area with adequate lighting.
- Consider how easily drivers can find the stations they need to access.
- Check local requirements for accessibility and pathway width, sometimes called “path of travel”, to ensure station placement does not restrict sidewalk use.
- Building a pad into the head of a parking space (instead of on the sidewalk) is allowed if a) local code allows it compared to the minimum parking space length, and b) the pad meets all pad requirements listed in this document.
- Note that the Express 250’s two charge cables are different types of connectors to maximize usability across EV models. The cables cannot both be used at the same time. Therefore, do not position an Express 250 to share two parking spots.

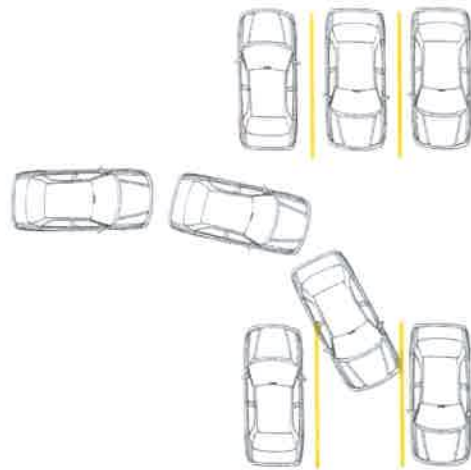

Important: Place each charging station centered at the head of its parking space, with the touchscreen facing the vehicle. This placement maximizes cable reach for the varied charge port locations on different EVs.

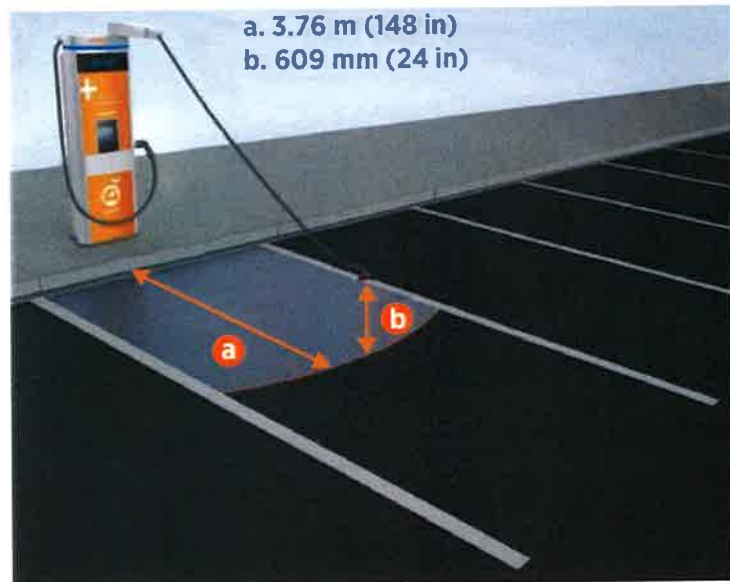

- Pull-through parking (gas station model) is not recommended. If pull-through parking is used, ChargePoint recommends placing at least one charging station on each side of the island. This avoids situations where the charging station is on the opposite side of the vehicle from the charge port. Guidance for station placement in island or curbside parking is shown below.

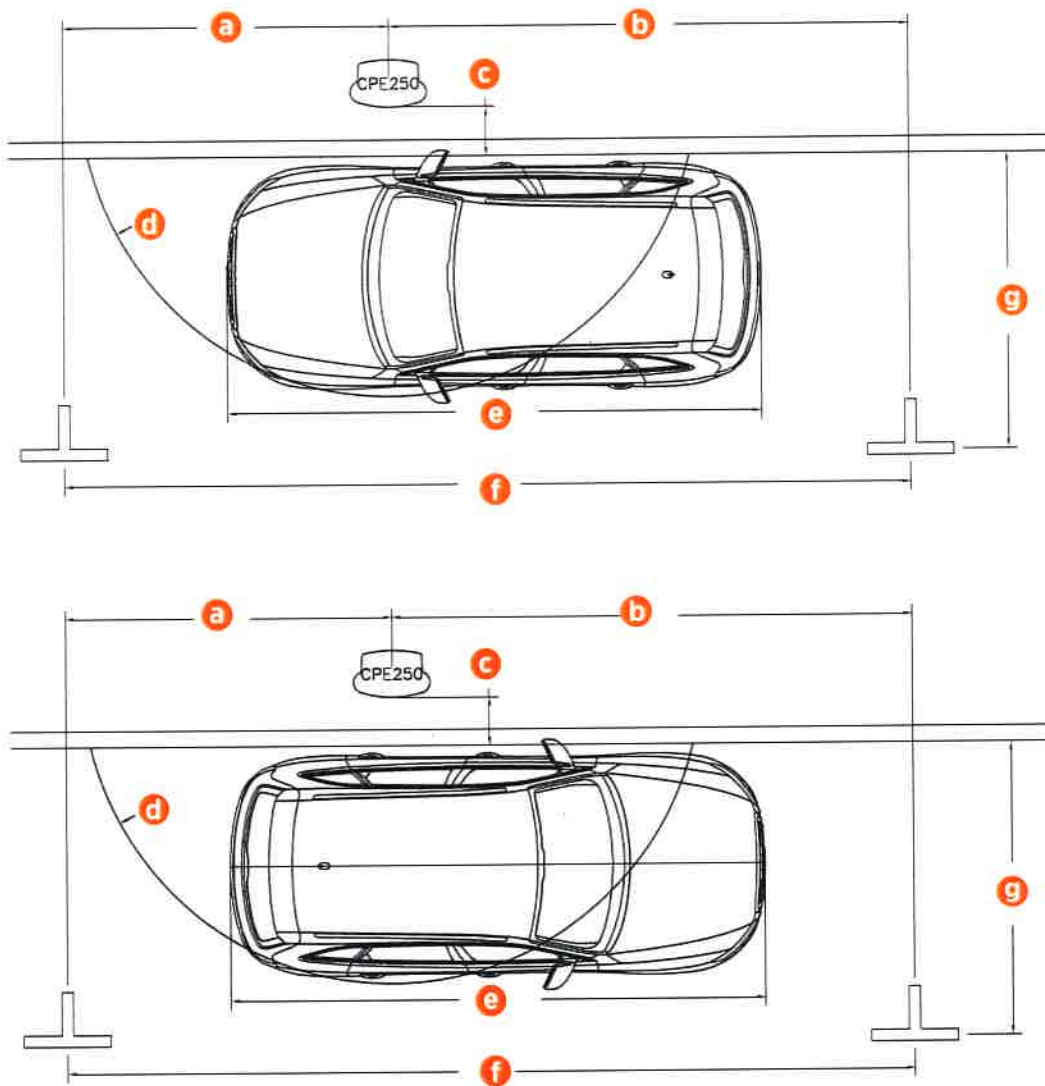

- a. Distance from left space marking: 3048 mm (120 in) maximum
- b. Distance from right space marking: 4876.8 mm (192 in)
- c. Distance from curb: 457.2 mm (18 in)
- d. Cable reach radius: 3.76 m (148 in)
- e. Example EV length: 4978.4 mm (196 in)
- f. Recommended parking space length: 7924.8 mm (312 in)
- g. Recommended parking space width: 2743.2 mm (108 in)

Civil and Mechanical Design 2

Use the guidance below to design the civil and mechanical aspects of the site.

Component Dimensions and Weights

The Express 250 is a vertical enclosure with the dimensions shown here.

Component	Weight
Each Power Module	44 kg (97 lb)
Crated Power Module as shipped	49.9 kg (110 lbs)
Express 250 with two Power Modules, installed	339 kg (746 lb)
Crated Express 250 as shipped	494 kg (1089 lb)



Pad

The station can be installed on either a newly poured pad or an existing concrete surface. The mounting surface must be smooth and cannot exceed a slope of 6.35 mm per 304.8 mm (0.25 inches per foot).

The concrete pad must either be designed to be site-specific, or must meet these specifications:

- At least 305 mm (12 in) deep (or deep enough to be 305 mm (12 in) below the frost line)
- At least 1296 mm (51 in) on each side
- Contains #4 rebar or larger, top and bottom, 305 mm (12 in) on center
- Concrete 2500 PSI minimum

The above pad specifications are designed to meet these conditions:

- 170 mph wind speed
- Wind Risk Category I
- Wind Exposure D
- Seismic Importance Factor 1.0
- Hayward Fault with mapped spectral response accelerations $S_s=2.45$ $S_1=1.019$
- Seismic Design Category E
- Foundation of Sandy Soil with allowable stress = 1500 psf, $C_d = 1.33$

In some extreme conditions, a larger pad would be required. For sites with less stringent seismic, soil, or wind conditions, a smaller pad might be possible.

If the existing pad does not meet the specifications above, it must be inspected and approved by a structural engineer for the Express 250's dimensions and weight. If needed, give these structural design specifications to the structural engineer for verification:

Product Weight	340 kg (750 lbs)
Product Height from Ground	2.230 m (7.317 ft)
Product Width	0.71 m (2.33 ft)
Product Frontal Area	Height * Width
CG Height	1.12 m (3.66 ft)
Number of Anchor Bolts	4
Bolt Pattern	See dimensioned images in this section
Anchor Bolt Size	M16 (5/8 in)
Anchor Bolt Embedment	229 mm (9 in)



WARNING: If not installed correctly, the ChargePoint® charging station may pose a fall hazard, leading to death, personal injury, or property damage. Always use the provided Concrete Mounting Template or a ChargePoint-approved surface mounting solution to install the ChargePoint® charging station and install in accordance with applicable codes and standards using licensed professionals. Non-approved installation methods are performed at the risk of the contractor and void the Limited Warranty.

Drainage

Ensure any site slopes, walls, or fencing do not trap water around the charging station installation site. The system is only built to withstand 457.2 mm (18 in) of standing water.



WARNING: Exposing the ChargePoint® charging station to over 18 inches (457 mm) of standing water could create an electrocution, shock, or fire hazard. Cut power to the charging station if it has been exposed to standing water and contact ChargePoint before the charging station is powered on.

Mounting Specifications

The Express 250 is installed on a concrete pad. Details on how to prepare this pad are described later in this guide.

All installations require four anchor bolts (a). Standalone installations only require the two conduit stub-ups on the left side, for AC wiring and shunt trip wiring (b). Paired installations also require the wiring shown on the right: DC wiring and Ethernet communication (c). For more detail, see [Conduit \(page 21\)](#).

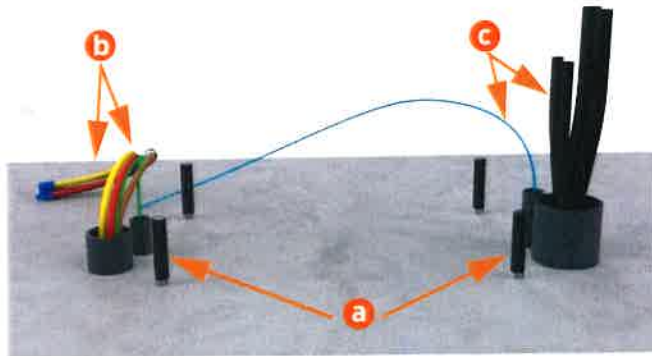

Important: Although the Concrete Mounting Template was originally designed for six anchor bolts, only the four corner anchor bolts are required for station stability. Newer charging stations are designed to only use the four corner anchor bolts. If older sites were already designed with six anchor bolts, removing the middle bolts is not required.



WARNING: If not installed correctly, the ChargePoint® charging station may pose a fall hazard, leading to death, personal injury, or property damage. Always use the provided Concrete Mounting Template shown pre-installed in the Introduction, or a ChargePoint-approved surface mounting solution, to install the ChargePoint® charging station. Always install in accordance with applicable codes and standards using licensed professionals. Non-approved installation methods are performed at the risk of the contractor and void the Limited One-Year Parts Exchange Warranty.

Clearances

The Express 250 requires minimum functional and service clearances as listed in the table below.

Front Clearance	330.2 mm (13 in) at grade; 609.6mm (24 in) minimum open space
Side Clearance*	711.2 mm (28 in) required; 863.6 mm (34 in) recommended**
Rear Clearance	304.8 mm (12 in) required; 609.6 mm (24 in) recommended
Top Clearance	304.8 mm (12 in)

* Side clearance is measured from extrusion to extrusion.

** Side clearance can be shared between two charging stations. However, if the charge handles of both stations are facing each other, add an extra 254 mm (10 in).

Measurements are provided in millimeters (inches).

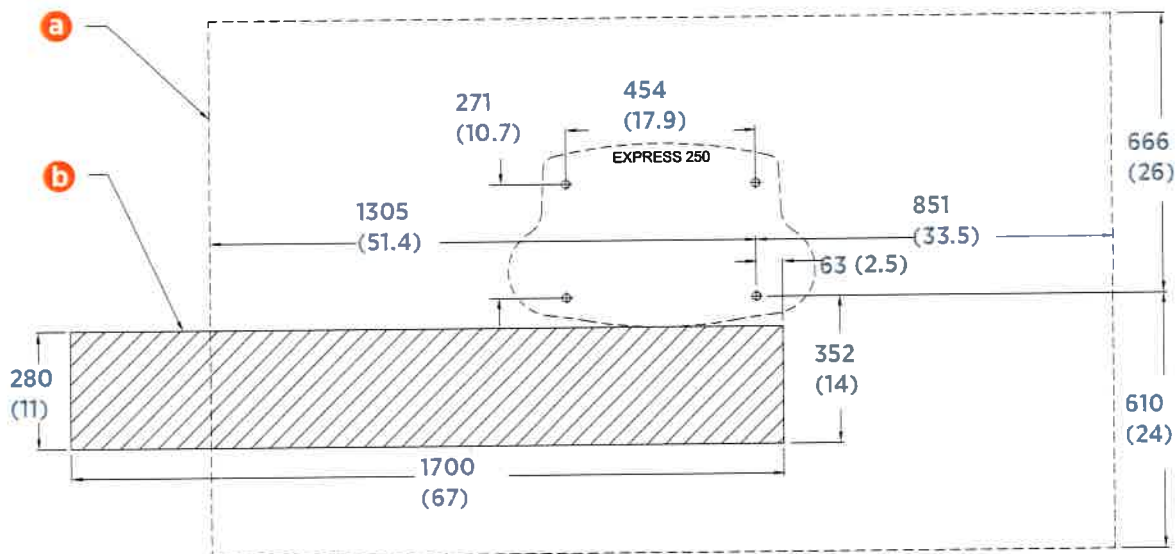

- a. Service clearance of open space (not necessarily at system grade)
- b. Power Module service clearance at grade from the front right anchor, extending 1700 mm (67 in) to the left, without any permanent obstructions (fencing, bollards, wheel stops, etc.)

Note: Listed side clearances are the minimum required for operation and service. For paired charging stations, the bend radius of the DC cable and conduit might require spacing them further apart.

Rear clearance, and the front and side clearance for Power Module service, must be at grade level +/- 25 mm (1 in).

Refer to the "Ventilation" section, and check local and regional code, for any additional clearance requirements.

Ventilation

Ensure that any installation, especially an indoor installation, has adequate airflow to dissipate the charging station's heat at maximum operation. Each Express 250 charging station emits approximately 3.3 kW of waste heat at maximum operation.

The charging station location must allow fresh ambient airflow. Restriction of airflow might result in reduced maximum performance. Do not install a station where it is exposed to air that is heated above ambient temperatures.

In addition to the service clearances listed in the "Clearances" section, consider these figures for site layout:

- If a charging station will have a wall directly behind it, minimum rear clearance is 305 mm (12 in).
- If two Express 250 charging stations will be positioned back to back, increase the rear clearance to a shared 610 mm (24 in) for both stations to reduce exhaust recirculation.

Wheel Stops

Bollards and wheel stops are not explicitly required by ChargePoint. However, ChargePoint recommends these best practices and considerations when designing the site:

- Permanent bollards or wheel stops must not encroach upon the Power Module clearance listed in the clearance diagram above. Removable bollards are allowed if service personnel have the ability to move them as needed.
- Where permitted by code, wheel stops are preferred over bollards for head-in or back-in spaces.
- When using wheel stops, consider the average vehicle overhang distance from tire to bumper (passenger, bus, etc.), as well as leaving space for the driver to walk up and access the touchscreen. General recommended distances are shown in the wheel stop image below.
- Position wheel stops to actively block at least one wheel, without presenting a trip hazard to pedestrians walking between vehicles.

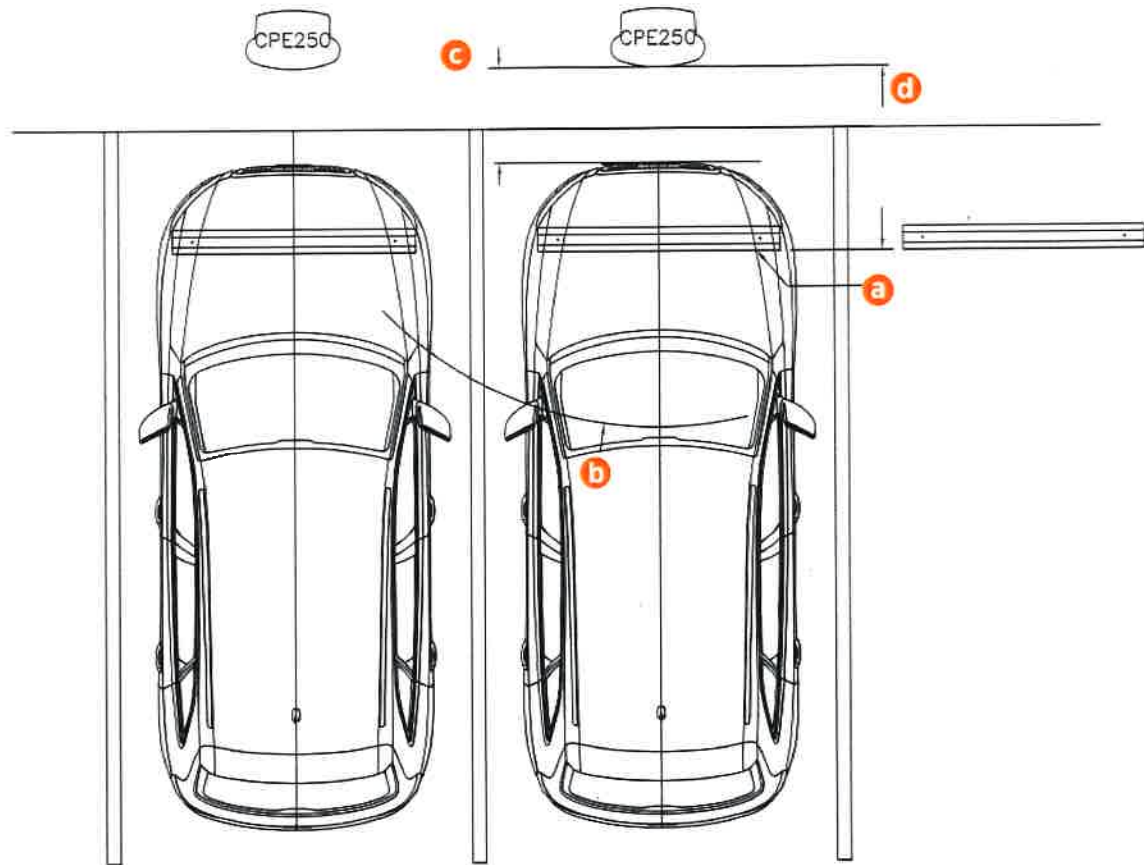

- a. Wheel stop, positioned to actively block at least one wheel
- b. Cable reach radius: 3.76 m (148 in)
- c. Recommended distance for walk-up access: 609 mm (24 in)
- d. Recommended distance between wheel stop and Express 250: 1371 mm (54 in) for passenger vehicles



CAUTION: Shorter wheel stops that are installed in the center of a parking spot can fit between the wheels of a larger vehicle and not prevent forward motion.

Note: For fleet or commercial use, measure the rear or front overhang of the largest vehicle in use, depending on charge port location.

Bollards

Bollards and wheel stops are not explicitly required by ChargePoint. However, ChargePoint recommends these best practices and considerations when designing the site:

- Permanent bollards or wheel stops must not encroach upon the Power Module clearance listed in the clearance diagram above. Removable bollards are allowed if service personnel have the ability to move them as needed.

- Where permitted by code, wheel stops are preferred over bollards for head-in or back-in spaces.
- When bollards are required by code, needed for snowy areas, or needed for curbside spaces, ensure bollard placement does not interfere with removing and replacing charge cables in the station's side holsters. General recommended distances are shown in the bollard images below.
- Try to minimize bollard interference with the movement of charge cables between the station and the vehicle. Bollards are recommended to be no taller than 914 mm (36 in) where needed.
- No bollard can be placed within 457 mm (18 in) of the station, as measured on-center.

Curbside bollard installation:

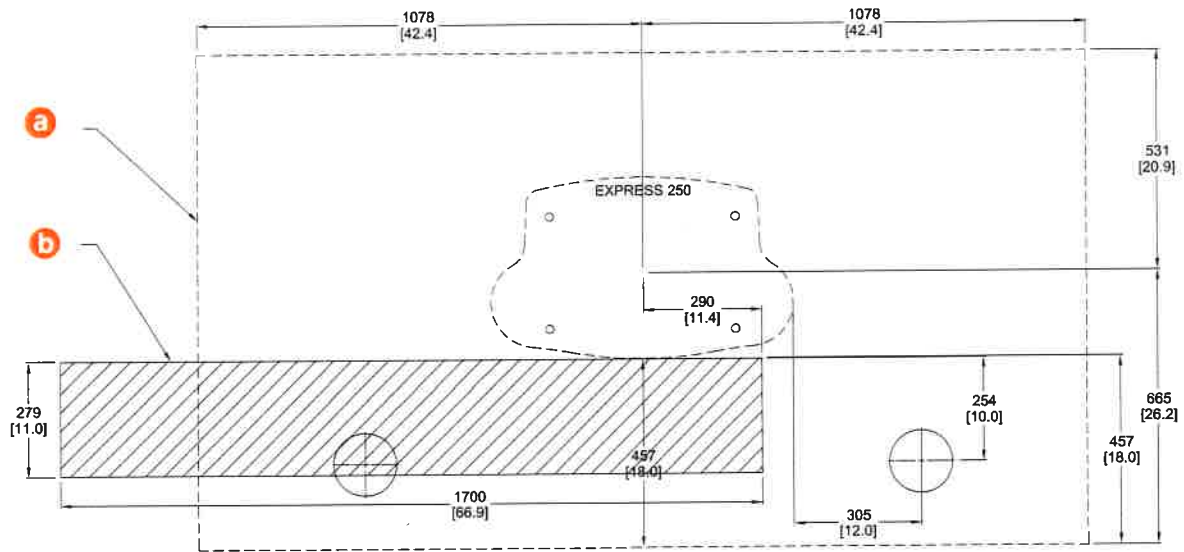

- a. Use and service clearance of open space (not necessarily at grade)
- b. Unobstructed front service clearance at grade

Head-in or back-in space bollard installation:

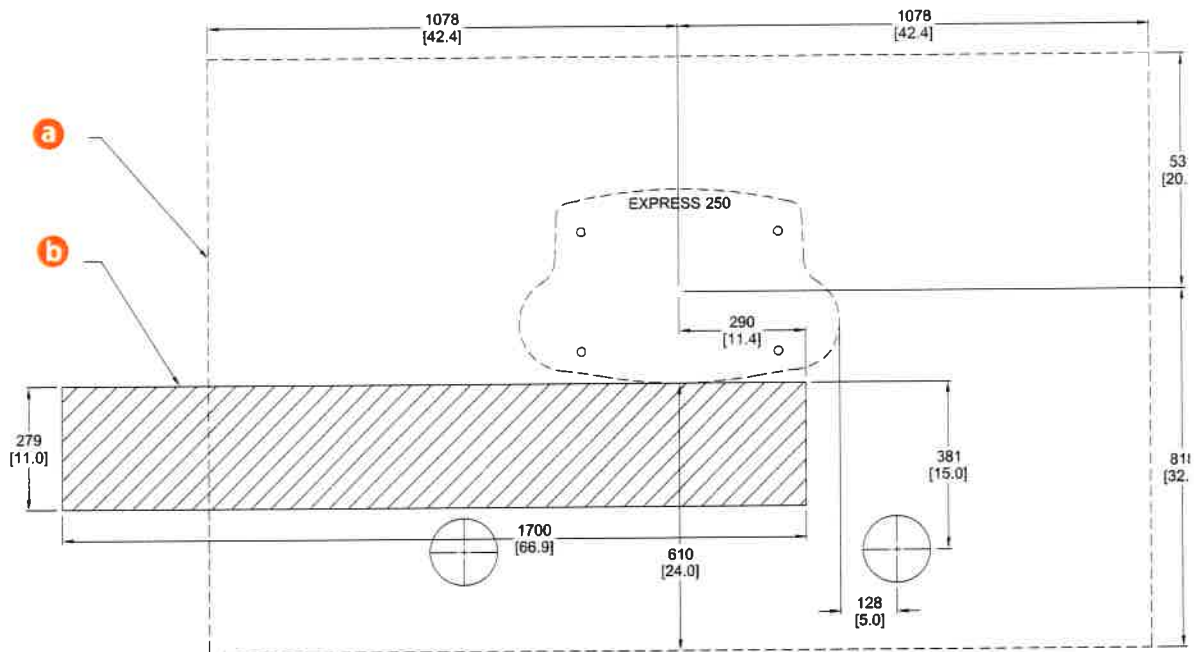

Pairing Previously Installed Charging Stations

If all site construction for paired charging is completed in advance, Express 250 stations can be initially installed as Standalone and paired at a later date. In that case, follow these additional steps:

- During initial site construction, install DC and communication conduit or ducting (as applicable by region) in advance.
- Extend side clearance at both DC conduit stub-up locations to 1.2 m (4 ft) to allow space for cable pulling equipment.
- Run a pull rope through the larger DC conduit before landing the charging stations. Do not pull DC cable in advance, as it is too thick to hide inside the cover panels without risking damage or unwanted electrical contact.
- Install a fishing tape in the smaller communication conduit to assist with routing the Ethernet cable later. If Ethernet is pulled in advance, leave 317.5 cm (125 in) of wire above grade at each end.
- Use duct seal compound to seal the ends of the DC and communications conduit stub-ups. Seal the ends of the fishing tape to hang outside the conduit.
- Install the cover panels and extrusions on the Express 250 stations over the stub-ups as normal.

By only connecting AC wiring (and shunt trip if applicable), each Express 250 can perform as a Standalone station until the station owner is ready to pair them. At a later time, the stations can be paired by installing DC conductors, connecting Ethernet communication, and performing a firmware update if required. Refer to the *Express 250 Installation Guide* for further details.

Once two Express 250s are correctly paired, operation of both stations is inhibited if Ethernet

connectivity is lost or one station loses power. This is a safety feature to prevent one Paired station from accidentally powering the other during maintenance.



WARNING: Do not connect DC power between the charging stations until both stations are ready to complete the full pairing configuration. Station firmware updates are required to enable full Paired behavior. Connecting power before the charging station is properly configured can create a safety risk or can damage equipment.

Accessibility

The Express 250 touchscreen and charging cables are accessible at a height of less than 1219 mm (48 in) from the ground. This complies with American Disability Act (ADA) requirements, if the station is installed at grade. If your installation must comply with ADA standards, or the disability access regulations for other regions, consider this when designing the height of the pad.

Also consider site design factors such as placement of bollards, wheel stops, or other vehicle obstacles when planning charging station access for disabled parking stalls. Check disability access regulations for guidance on the clearances needed for wheelchair access to charging cables and user interfaces.

Signage

Refer to local and regional code to design the following elements for the site:

- Any required re-stripping of parking spaces
- EV or Accessible EV signs
- EV or Accessible EV paint markings on and around the parking spaces

Electrical Design 3

The default Express 250 installation requires service wiring to be installed underground. (If a site requires surface mounting, contact ChargePoint before beginning work, to obtain an approved surface installation method.) Conduit and wire size are determined based on the length of runs from the electrical panel to the station location. Service wiring must be run through conduit or ducting, or use armored cable, as required to comply with local electrical codes. Consult national and local codes or a project engineer to determine the grade, quality, and size of the conduit or cable. The ChargePoint Concrete Mounting Template (CPE250-CMT) accommodates service wiring through the flare, conduit, or locally appropriate wiring method.

Note: All wiring and conduit is supplied by the contractor unless otherwise indicated.

Note: It is possible to pre-install Express 250 charging stations as Standalone initially and pair them at a later date, if desired. In this case, install the DC and Ethernet conduit per [Pairing Previously Installed Charging Stations \(page 14\)](#), and run a pull rope through the conduit before landing the charging stations. Contact ChargePoint for instructions to pair two charging stations when ready.

Upstream Components

Charging stations are considered continuous load devices (EVs draw maximum load for long durations). Therefore, electrical branch circuits to EV chargers must be sized at 125% of the load on each leg of a 3-phase panel for North America installations; in accordance with National Electric Code requirements. For other regions, refer to local code.

When planning multiple EV charging stations, it is best practice to segment non-continuous and continuous loads, with all branch circuits for EV charging on a dedicated electrical panel assembly with adequate circuit breakers. When sizing new electrical panels dedicated for EV charging, all branch circuits must support continuous load.

Each Express 250 requires a service panel breaker as follows:

Nominal Voltage	Max AC Current	Circuit Breaker Size
400 VAC (EU)	96 A	125 A
480 VAC (NA)	80 A	100 A (125% continuous load required for N. America)

The Express 250 does not contain an internal breaker. Therefore, its KAIC rating (KiloAmps

Interrupt) is related to the station's upstream breaker.



CAUTION: The Express 250 charging station is tested to IEC 61000-4-5, Level 5 (6 kV @ 3000 A) standards. In geographic areas that experience frequent thunderstorms, supplemental surge protection must be installed at the service panel to guard against product damage.

Transformer Configuration

Refer to the following tables to configure electrical service.

	North America	Europe
Input Rating	480 VAC, 3-phase, 80 A, 60 Hz	400 VAC, 3-phase, 96 A, 50 Hz
Electrical Service Configuration	277/480 4 wire WYE*	230/400 Y, L1, L2, L3, N, Ground
Product Connection	3-phase 480 plus ground (neutral not required)	3-phase 400 plus protective earth (neutral not required)

**Delta (floating or grounded) is not supported*

AC Disconnect Switch

A local AC disconnect switch, separate from the shunt trip wiring, is recommended to be installed between each charging station and the electrical panel. This is especially important if the main electrical panel or utility room is distant, out of line of sight, or has restricted access. For North America installations, refer to disconnect switch requirements per NEC Article 625, "Electric Vehicle Charging and Supply Equipment Systems".



WARNING: If service is performed on either Paired charging station, both stations must be powered off at their AC disconnect switch(es) and locked out/tagged out for safety.

Do not install a DC disconnect between Paired charging stations.

RCD Use

The use of an RCD is not recommended. RCD use can create nuisance tripping, especially during transient conditions such as power restoration, line surge, line dips, or phase loss.

To reduce the risk of shock, the Express 250 provides:

- Galvanic (reinforced) isolation between the AC input and DC output. Current does not flow to earth ground, even in cases such as charge cable damage.
- An output isolation monitor interrupter (IMI).

If the isolation level is compromised, charging is halted or prevented from starting, and the output

de-energized. The isolation monitor operates continuously during charging to ensure the output is always galvanically isolated. UL 2231-1 requires that an isolation monitor interrupter (IMI) is provided in the product and evaluated during operation as part of certification testing.

Although RCD/GFCI use is required in mode 1,2,3 AC charger installations, neither UL nor IEC mandate an RCD for a permanently installed mode 4 isolated output DC charger.

RCD Settings

For Standalone Express 250 installations where the use of an RCD (RCCB or RCBO) cannot be avoided, use the following settings to minimize nuisance trips:

- Type: A, F or B (type B and F preferred)
- Trip threshold: 500 mA
- Trip delay: 150 ms

If an RCD must be employed for a Paired installation, contact ChargePoint.

Region Specific Notes: UK

When discussing DC charging station installations with a UK DNO (utility), include these two considerations:

- Where possible, request TN-S earthing from the DNO (distribution network operator)
- The Express 250 represents a Class I construction, balanced 3-phase load greater than 500 W

Either statement allows UK DNOs to provide a PME earth terminal and avoids the requirement for a TT earthing arrangement and associated (300 mA) RCD. The second statement meets the clause in the IET Code of Practice for EV Charging Equipment Installation, 3rd Edition that allows the DNO to provide a PME connection for “on the street equipment”.

Installations at petrol stations are a special case that requires additional site planning. Contact ChargePoint for more information.

Grounding/Earthing Requirements

- The Express 250 must be connected to a grounded, metal, permanent wiring system.
 - North America: A grounded service neutral conductor must be run with circuit conductors and connected to an equipment-grounding terminal on the Express 250.
 - Europe: Use TN-S or TN-C-S configurations. (TT is not recommended because it requires RCDs.)
- Ensure a grounding conductor that complies with local codes is properly grounded to earth at the service equipment or, when supplied by a separate system, at the supply transformer.

Shunt Trip Wiring

ChargePoint advises against installing an emergency stop (E-stop) button on charging stations. Drivers can unintentionally trip the emergency shutoff, causing inconvenience and downtime to site hosts. However, wiring to enable a remote shunt trip is standard on each Express 250. This shunt trip wiring is activated when unsafe conditions are detected, such as a missing cover panel or a severe impact. All shunt trip behavior is already hard-coded into the charging station and has no programmable variables.

The Express 250 provides a set of unpowered (dry pair) contacts near the AC input terminals, to connect to a shunt trip device. These contacts are rated to 440 VAC and 5 ARMS.

When a shunt trip is used, select a breaker with a shunt trip that is within the contact rating of the Express 250 shunt trip contacts. Common ratings available for shunt trips are 12, 24, or 48 VDC, or 110-240, 400 VAC depending on the installation region. 480 VAC rated shunt trips may not be used.

Follow the installation guide provided by the breaker or shunt trip vendor. Control power is derived at the electrical panel.

Note: For Paired charging stations, wire the connections so that a shunt trip activation on either station trips the breakers of both Paired stations.

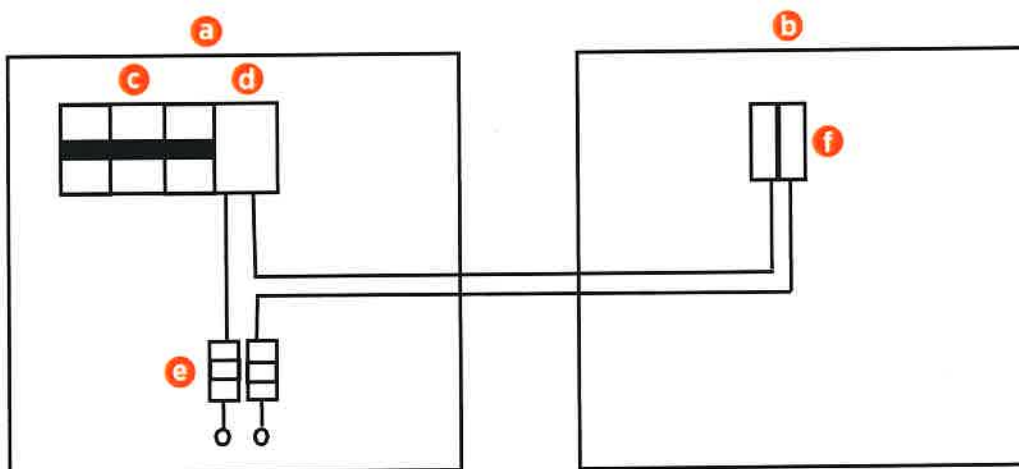

- a. Electrical panel
- b. Express 250
- c. Circuit breakers
- d. Shunt trip
- e. Control power (fused)
- f. Express 250 shunt trip terminal block (near AC terminals)

Conduit

The outer diameter of conduit or armored cable must not exceed the sizes called out in the conduit layout drawing below. Conduit stub-ups cannot extend higher than 76.2 mm (3 in) above the surface of the concrete pad.

In regions that do not use conduit, armored cable may be laid in the same configuration to conform to the wire placement as shown in the section, “[The Express 250 Concrete Mounting Template](#) (page 27)”. Ensure a length of at least 61 cm (2 ft) is left free above grade at each end to allow the wiring to reach the charging station AC terminals.

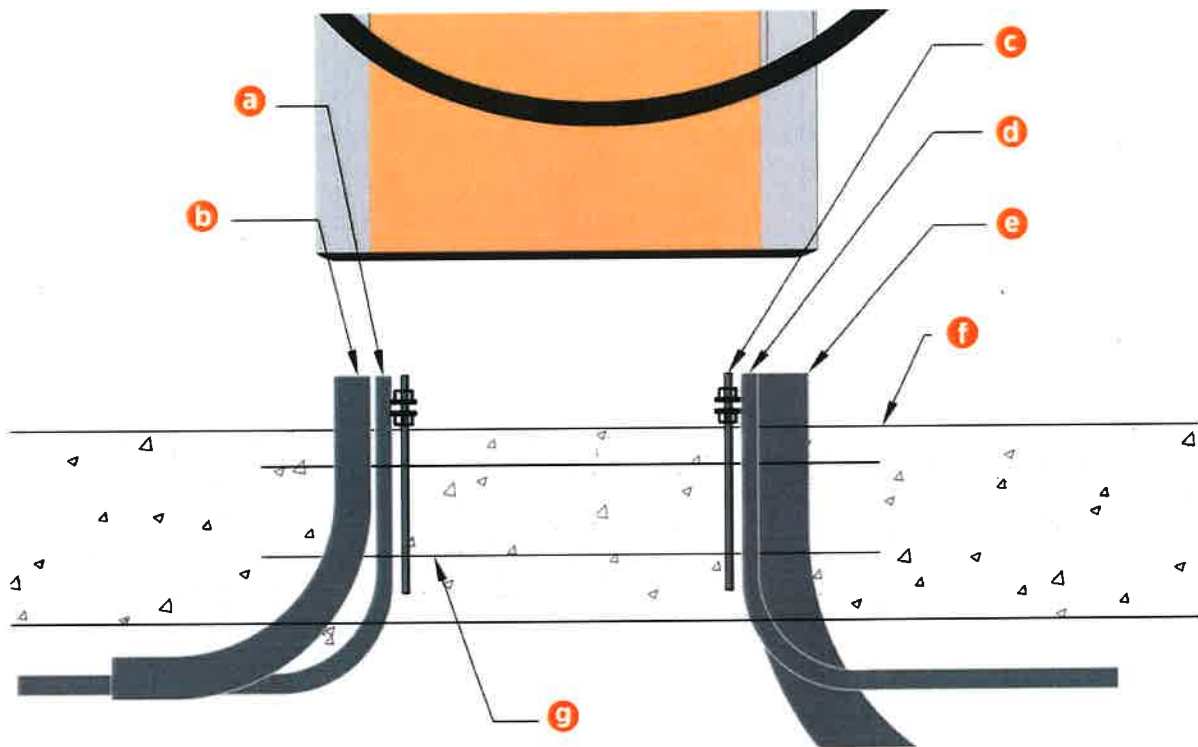

- a. Shunt trip conduit: 19.1 mm (3/4 in trade size)
- b. AC conduit: 50.8 mm (2 in trade size)
- c. Anchor bolts
- d. Paired installations only: Ethernet conduit: 19.1 mm (3/4 in trade size)
- e. Paired installations only: DC conduit: 76.2 mm (3 in trade size)
- f. Concrete surface
- g. Concrete Mounting Template (embedded in concrete)

Note: Ensure no bell ends are left on any conduit after all wires are pulled. Bell ends can interfere with station placement.

Note: Depth of conduit or armored cable may vary by site. The image above does not dictate conduit depth, as long as the stub-ups are vertical and placed correctly.

Wiring Requirements for Standalone Stations



Important: The AC terminal blocks on the Express 250 accept a maximum wire size of 35 mm² (2 AWG) solid or stranded wires. If using a larger gauge wire to accommodate a long run, reduce the wire size at the local external disconnect.

For full product specifications, refer to the *Express 250 Data Sheet*. Using that data, ensure that the installation location is equipped with service wiring that supports the Express 250's power requirements:

- Neutral conductor as required by region (a Neutral connection is not required for equipment operation and the terminal is provided for convenience only)
- Shunt trip wiring: size 0.08 to 2.5 mm² (28 to 14 AWG), fine stranded or solid
- AC conductors (L1, L2, L3) and ground per the following specifications:

Voltage Rating	Temperature Rating	Maximum Conductor Size for Terminals
EU non-armored: 600/1000 V	90°C	35 mm ²
EU armored: 600/1000 V	90°C	35 mm ² multi-core
NA: 600 V	90°C	2 AWG

Additional Wiring Requirements for Paired Stations



Important: The DC terminal blocks on the Express 250 can accept a maximum wire size of 120 mm² (4/0 AWG). Check site plans and local code for site-specific requirements.

For stations that will be installed as Paired, follow all AC wiring requirements above as well as the following additional wiring.

Note: Be sure to acquire, or alert the installer to acquire, lugs in advance of the site visit. Contact ChargePoint in advance if help is required to obtain lugs.

- Ethernet wiring for DC:
 - Minimum of CAT5e or better
 - Outdoor or plenum rated wiring
 - Maximum run length of 100 m (328 ft)
 - Leave 3.2 m (10.5 ft) of wire above grade at each end
 - Field crimp using straight-through pattern 568B

- DC conductors (x4):

Voltage Rating	Temperature Rating	Maximum Conductor Size for Terminals	Insulation Type
EU non-armored: 600/1000 V	90°C	120 mm ²	XLPE
EU armored: 600/1000 V	90°C	120 mm ² 4-core and cable gland sized to local code (such as Cablecraft CCG-CW50 or similar)	XLPE
NA: 1000 V	90°C	4/0 AWG	XHHW-2

- **NOTE:** 95 mm² (3/0 AWG) is sufficient for most sites unless ambient temperatures are $\geq 40^{\circ}\text{C}$ per regional code (ASHRAE Table D101 Summer Dry Bulb Temperature for North America or IEC 60364-5-54 in Europe)
- 2 positive and 2 negative conductors; 1 positive and 1 negative in each direction
- USA/Canada: Copper only, minimum current carrying capacity 160 A
- EU/UK: Rated at 1000 V conductor to conductor (+/-500 V conductor to ground, LV), copper only, minimum current carrying capacity 160 A
- DC cable run must be continuous, with no joints or splices
- Consult site drawings for site-specific conductor size and length (Appendix A provides conductor size calculation examples for reference)
- Leave 61 cm (2 ft) of each conductor above grade at each end
- DC lugs (x4):
 - Silver plated copper compression lug (2-hole specified for North America); tin plated is acceptable if used with dielectric grease
 - Holes for an M6 (1/4 in) stud at 19 mm (3/4 in) stud hole spacing
 - Maximum width 30 mm (1.18 in)
 - **NOTE:** 95 mm² (3/0 AWG) is sufficient for most sites unless ambient temperatures are $\geq 40^{\circ}\text{C}$ per regional code (ASHRAE Table D101 Summer Dry Bulb Temperature for North America or IEC 60364-5-54 in Europe)
 - North America lug size: 3/0 or 4/0 AWG
 - Example UK/EU lugs for average conductor size are Weidmuller 1494410000 120 mm² or similar (always review the lug manufacturer's instructions for crimper tool and die compatibility)
 - Contact ChargePoint if the installer requires lugs for 3/0 (kit 99-002644) or 4/0 (kit 99-002645) conductors

When DC conductors are pulled through conduit, label each end of each DC conductor to aid installation as follows:

- “Station 1 A+” on one end and “Station 2 B1+” on the other end
- “Station 1 A-” on one end and “Station 2 B1-” on the other end
- “Station 1 B1+” on one end and “Station 2 A+” on the other end
- “Station 1 B1-” on one end and “Station 2 A-” on the other end

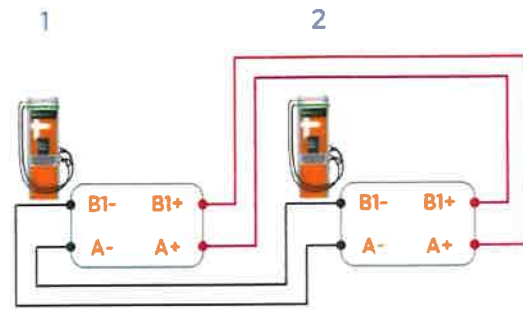

CAUTION: Be sure to connect positive to positive, and negative to negative, on the same wire. Do not reverse the polarity.

Wiring Diagram

GENERAL NOTES:
 ALL OCPDS, CONDUCTOR AND CONDUIT SIZES STATED HERE ARE PROVIDED BY CHARGEPOINT FOR REFERENCE ONLY. SITE SPECIFIC WIRE SIZING SHALL BE PERFORMED BY THE INSTALLATION CONTRACTOR TAKING INTO ACCOUNT SITE SPECIFIC CONDITIONS AND LOCAL CODES AND STANDARDS.
 CONDUCTORS LANDING ON CHARGEPOINT EQUIPMENT SHALL BE COPPER.

(E) HOST SWITCHBOARD

EXPRESS 250 BREAKER SELECTION			
NOMINAL VOLTAGE	MAX AC CURRENT	125% x CONTINUOUS LOAD	BREAKER SIZE
400 V	96 A	120A	125 A
480 V	80A	100 A	100 A

NOTES: EXPRESS 250
 1 SET OF PAIRED EXPRESS 250S, EACH CONTAINING (2) 31.25KW POWER MODULES
 2 x EXPRESS 250 EACH CONTAINING (2) 31.25KW POWER MODULES

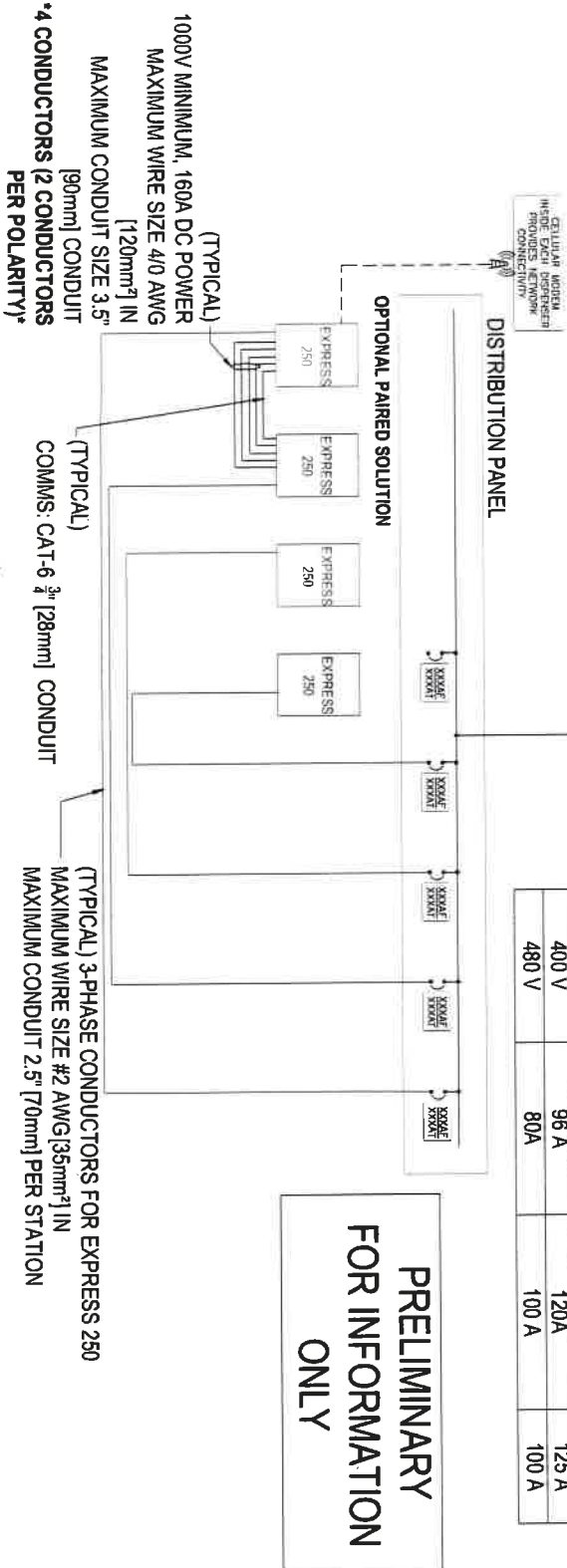

Cellular Connectivity

A consistently strong cellular signal is needed before installers can activate the station. Do not rely on cell phone applications to measure cellular signals when conducting site surveys. Ensure the signal at the installation site is consistently strong. If RSRQ is measured at -10 dB or better, then RSRP can be -90 dBm or better. If RSRQ cannot be measured or is not adequate, RSRP must be -85 dBm or better.

Note that these numbers are all negative, so -70 dBm is stronger than -85 dBm, and -90 dBm is weaker. Use a cellular signal detection device (such as a Snyder, Octopus, or equivalent) to take signal strength readings at the exact proposed charging station locations.

If the signal is below -85 dBm, take cellular readings at the location where a cellular signal booster antennas will be installed, to ensure enough signal exists to be boosted. Install repeaters to boost the strength of the cellular signals. Repeaters are often required when installing charging stations in an underground garage or enclosed parking structure.

When repeaters are needed to boost signal, ChargePoint strongly recommends installing multi-carrier and multi-band units where allowed by local code. Weak or sporadic signal can affect crucial aspects of the charging station, including: accuracy in reporting, ability for drivers to use their mobile app, ability for customer support to troubleshoot problems, and support for advanced features such as Power Management or Waitlist. Strong signal is also required for the Assure maintenance and management program.

Note: Do not use microcells or femtocells, as they are inadequate for this use case.

In the US, the Express 250 supports AT&T 4G/LTE. There must be viable AT&T signal on one or more of the supported bands listed below. For other regions, contact your ChargePoint representative for more detail on carrier support.

- LTE 1900 (B2)
- LTE 1700 (B4)
- LTE 850 (B5)
- LTE 700 (B17)
- LTE 700 (B13)

The Express 250 Concrete Mounting Template **4**

The Express 250 is a DC fast charging station for electric vehicles. The default Express 250 installation requires service wiring to be installed underground and run to a concrete pad. (If a site requires surface mounting, contact ChargePoint before beginning work, to obtain an approved surface installation method.) The ChargePoint Express 250 Concrete Mounting Template (CPE250-CMT) correctly aligns anchor bolts and conduit openings to ensure the Express 250 can be easily installed and connected.



WARNING: Use of a ChargePoint approved mounting method, such as the CPE250-CMT, is required for safe installation of the Express 250. Failure to use an approved mounting method may result in a risk of tip-over, which can cause death, personal injury, or property damage, and will void the Limited One-Year Parts Exchange Warranty.

The CPE250-CMT, available from ChargePoint, includes:

- 16 mm (5/8 in)-11 thread, 305 mm (12 in) long threaded mounting bolts with plastic caps on one end
- 16 mm (5/8 in) nuts
- 16 mm (5/8 in) washers
- Printed specification detailing how to position an assembled CPE250-CMT in the concrete

Note: You must order the CPE250-CMT separately, with sufficient lead time before the site preparation. This kit is not included with the ChargePoint Express 250 charging station.

Bring Tools and Materials

In addition to the CPE250-CMT kit, the site construction team needs:

- Digging tools (shovel, spade, etc.)
- Materials to prepare the form for pouring concrete
- Concrete as specified by site drawings
- Rebar as specified by site drawings
- 24 mm (15/16 in) wrench (x2)
- Pliers to adjust the guide fingers on the CMT conduit openings (if needed)
- Level
- Cut-resistant gloves
- Conduit, ducting, or armored cable in the amounts and types specified by site drawings, that complies with local code (see the rest of this document for conduit sizes and routing)

CPE250-CMT Overview

The Express 250 is a DC fast charging station for electric vehicles. It converts three-phase power from its associated building (callout a in the image below) to DC power to charge the vehicle. A ground conductor also runs in conduit a. Shunt trip wiring (b, optional) is run from the station to the breaker panel to automatically shut down the station if a fault or hazard is detected, such as a damaged cover panel or impact from a vehicle.

If two Express 250 stations are “paired”, they share DC power to allow faster (higher amperage) charging to a vehicle as needed. In this case, DC conductors (d) are run between the stations, as is an Ethernet wire (c) for communication.

Note: Each Express 250 communicates with ChargePoint using a cellular network. No communication wiring is needed between the station and the building.

An assembled CPE250-CMT template is shown below with the positions of all conduit and anchor bolts.

Note: A separate CPE250-CMT is required for each charging station (two per Paired installation).



- a. AC conduit
- b. Shunt trip conduit
- c. Anchor bolts (x4)
- d. Ethernet conduit (Paired installations only)
- e. DC conduit (Paired installations only)

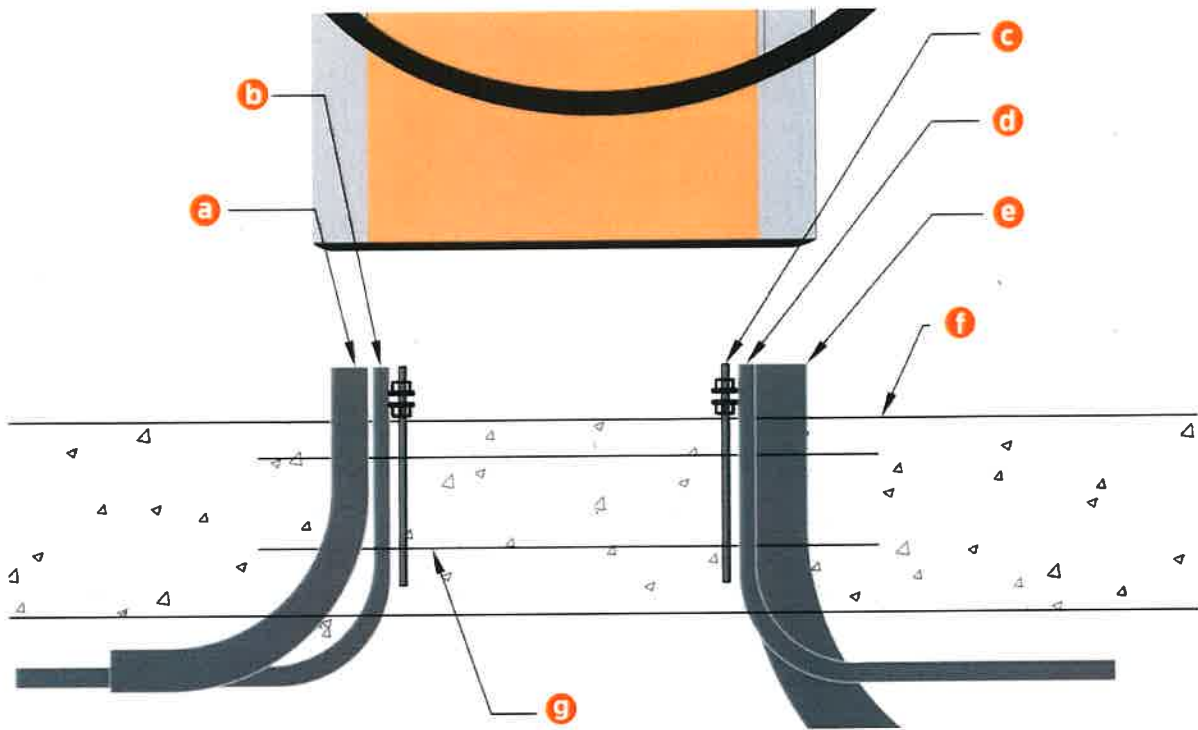

- a. AC conduit from the left side of each station to the breaker panel (possibly with an AC disconnect switch in the circuit): 50.8 mm (2 in trade size)
- b. Shunt trip conduit from the left side of each station to the breaker panel: 19.1 mm (3/4 in trade size)
- c. Anchor bolts (x4)
- d. **Paired installations only:** Ethernet conduit between the two stations to be paired, right side to right side: 19.1 mm (3/4 in trade size)
- e. **Paired installations only:** DC conduit between the two stations to be paired, right side to right side: 76.2 mm (3 in trade size)
- f. Concrete surface
- g. Concrete Mounting Template (embedded in concrete)

Note: Ensure no bell ends are left on any conduit after all wires are pulled. Bell ends can interfere with station placement.

Note: Depth of conduit or armored cable may vary by site. The image above does not dictate conduit depth, as long as the stub-ups are vertical and placed correctly.

Assemble the CPE250-CMT



CAUTION: The CPE250-CMT can have sharp edges. Wear cut-resistant gloves.



Important: Although the CPE250-CMT was originally designed for six anchor bolts, only the four corner anchor bolts are required for station stability. Newer charging stations are designed to only use the four corner anchor bolts.

Before pouring concrete, assemble the CPE250-CMT with its anchor bolts, washers, and nuts.

1. Holding a mounting bolt by its plastic cap, insert the bare end into a corner bolt hole in the top plate of the template.
2. Before inserting the bolt through the bottom plate of the template, thread a nut onto the bolt and add a washer as shown.
3. Ensure the plastic cap is pressed fully down on the bolt.

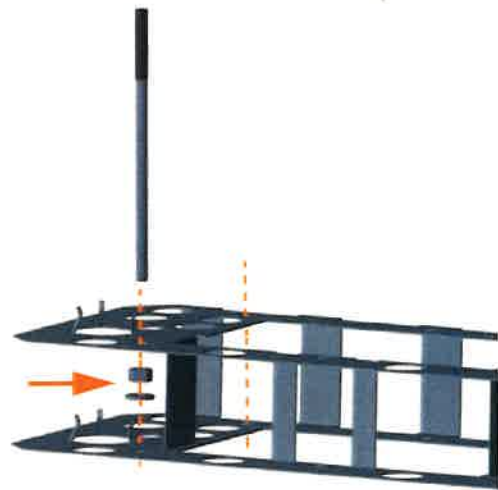

4. Holding the bottom nut and washer flush against the top surface of the bottom plate, thread the bolt onto the nut until the distance between the bottom of the plastic cap and the surface of the top plate is 51 mm (2 in).
5. Repeat Steps 1 to 4 for the remaining three corner bolts.

51 mm (2 in)



Note: Do not insert bolts into the center two holes. Only the four corner bolts are required for system stability.

6. Secure a second washer and nut onto the bottom of each bolt until it is flush with the bottom surface of the bottom plate. Torque each nut to 5.6 Nm (50 in-lb).



Install the CPE250-CMT



WARNING: Failure to install the ChargePoint® charging station in accordance with these instructions and all local building practices, climate conditions, safety standards, and all applicable codes and ordinances may lead to risk of death, injury, or property damage, and will void the Limited One-Year Parts Exchange Warranty.

1. Trench and excavate an opening to accommodate the wiring conduit and the concrete mounting pad that meets local codes and requirements, per site drawings.
2. Run conduit to each station as needed. If the stations will be Paired, run DC and Ethernet conduit between stations as well.
3. Build the form and lay rebar for the foundation.



Important: It is critical that the conduits are positioned properly and plumb. The tolerance where the conduits enter the station is 2 mm (1/16 in).

4. On the CPE250-CMT, locate the “FRONT” marking and the conduit guide fingers. Position the conduit guide fingers facing up.
5. Place the assembled CPE250-CMT so that the “FRONT” marking aligns with the specified front of the station.
6. Slide the CPE250-CMT over the conduit stub-ups until the top surface of the template is positioned 50.8 mm (2 in) below where the top surface of the concrete will be when poured. The surface of the concrete must align with the bottom of the plastic caps.
 - Carefully press the CPE250-CMT down onto the conduit to avoid flexing it.
 - Ensure the conduits are plumb.
 - Use a level to check that the CPE250-CMT is level from front to back and from side to side.
7. Tie or shim the CPE250-CMT to the rebar to prevent movement during concrete pouring.



Important: Before pouring concrete, the CPE250-CMT and the conduit must be secured in place to prevent them from rising or floating out of position while the concrete is poured and curing.

8. Pour the concrete.

Note: Make sure the concrete surface between the conduits is completely level and free of any irregularities.

9. Complete the *Construction Signoff Form* provided by ChargePoint to verify that the site is correctly completed and ready for product installation.

Examples of Express 250 Paired **A** Wire Sizing

The required DC wire gauge varies based on the specific site. Use these example scenarios to help you determine the correct wire gauge for your site.



Important: These scenarios are only examples, and are not intended to replace an assessment by a local electrician. Always follow all applicable local and national codes and requirements. A site drawing should be engineered for your specific site to reduce installation costs and ensure compliance with local codes.

DC Interconnection, Example Calculation: Newark, NJ

Assumptions:

- Breaker and equipment terminal rating minimum 75°C
- Electric Vehicle Charging Equipment rated for continuous duty per Article 625.41
- Maximum 50°C ambient rating
- Installation location: Newark, NJ, USA
- 90°C rated wire required
- Maximum station DC output/input current: 160 A
- Four conductors in conduit, only two current carrying conductors

The continuous duty derating per 625.41 is 160×1.25 , or 200 A.

From the Appendix D ASHRAE, the table summer design temperature is 91°F for Newark, NJ.

Temperature derating from 2017 NEC Table 310.15(B)(2)(a) based on 30°C the derating factor for 91°F and 90°C rated wire is 0.96 (87-95°F row).

From the 90°C column of NEC Table 310.15(B)(16), a 3/0 copper conductor has an ampacity of 225 A.

Applying the temperature derating factor, $225 \times 0.96 = 216$ A

200 A is the minimum rated ampacity this conductor must have per the NEC to prevent potential insulation damage and provide the ability of the conductor to dissipate heat caused by the current flow. After the temperature derating calculation, the resulting 216 A is greater than the 200 A required.

A 3/0 copper conductor has an ampacity of 200 A at 75°C, which is the ampacity column required for equipment rated 100 A or greater per NEC 110.14(C)(1)(b). If, following the derating from the 90°C column, the resultant ampacity of the 3/0, 90°C wire is equal to or greater than the ampacity rating of the same size conductor in the 75°C, the conductor is permitted.

From NEC table 310.15(B)(16) in 90°C column, after the derating, the 3/0 conductor ampacity is 216 A which is greater than the minimum required 200 A. Thus the permitted copper conductor size is 3/0.

The permission to use the 90°C ampacity for ambient temperature adjustment comes from the general requirement in 110.14(C); Conductors with temperature ratings higher than specified for terminations shall be permitted to be used for ampacity adjustment, correction, or both.

AC Mains Input Wiring, Example Calculation: Phoenix, AZ

Assumptions:

- Breaker and equipment terminal rating minimum 75°C
- Continuous duty equipment
- Maximum 50°C ambient rating
- Installation location: Phoenix, AZ, USA
- 90°C rated wire required
- 480 VAC Input, 3 phase, no neutral
- Maximum station AC input rating: 80 A
- Three current carrying conductors in conduit

The continuous duty derating per 625.41 is 80×1.25 , or 100 A.

From the Appendix D ASHRAE table, the summer design temperature is 107°F for Phoenix, AZ.

Temperature derating from 2017 NEC Table 310.15(B)(2)(a) based on 30°C the derating factor for 107°F and 90°C wire is 0.87 (from the 105-113°F row).

The allowable ampacity for a #3 AWG 90°C copper conductor per NEC Table 310.15(B)(16) is 115.

Applying the temperature derating factor from Table 310.15(B)(2)(a), $115 \times .87 = 100.05$ A.

100 is the minimum ampacity this conductor must have per the NEC to prevent potential insulation damage and provide the ability of the conductor to dissipate heat caused by the current flow. After the derating is applied, the resulting ampacity of 100.05 A is greater than the 100 A required.

A #3 AWG copper conductor is rated at 100 A at 75°C, which is the ampacity column required for equipment rated 100 A or greater per NEC 110.14(C)(1)(b). However in this case, the equipment is only rated to 80 A. Since the equipment is listed and identified with a 75°C termination rating, we can use NEC Section 110.14(C)(1)(a)(3). As long as after derating from the 90°C column of table 310.15(B)(16) the resultant ampacity is equal to or greater than the ampacity rating of the conductor in the 75°C column, the #3 AWG conductor is permitted.

From NEC table 310.15(B)(16) in 90°C column, after the derating, the conductor ampacity is

100.05 A, which is greater than the minimum required 100 A. Thus the permitted conductor size is 3 AWG.

The permission to use the 90°C ampacity for ambient temperature comes from the general requirement in 110.14(C); Conductors with temperature ratings higher than specified for terminations shall be permitted to be used for ampacity adjustment, correction, or both.

Limited Warranty Information and Disclaimer

The Limited Warranty you received with your Charging Station is subject to certain exceptions and exclusions. For example, your use of, installation of, or modification to, the ChargePoint® Charging Station in a manner in which the ChargePoint® Charging Station is not intended to be used or modified will void the limited warranty. You should review your limited warranty and become familiar with the terms thereof. Other than any such limited warranty, the ChargePoint products are provided "AS IS," and ChargePoint, Inc. and its distributors expressly disclaim all implied warranties, including any warranty of design, merchantability, fitness for a particular purposes and non-infringement, to the maximum extent permitted by law.

Limitation of Liability

CHARGEPOINT IS NOT LIABLE FOR ANY DIRECT, INDIRECT, INCIDENTAL, SPECIAL, PUNITIVE OR CONSEQUENTIAL DAMAGES, INCLUDING WITHOUT LIMITATION LOST PROFITS, LOST BUSINESS, LOST DATA, LOSS OF USE, OR COST OF COVER INCURRED BY YOU ARISING OUT OF OR RELATED TO YOUR PURCHASE OR USE OF, OR INABILITY TO USE, THE CHARGING STATION, UNDER ANY THEORY OF LIABILITY, WHETHER IN AN ACTION IN CONTRACT, STRICT LIABILITY, TORT (INCLUDING NEGLIGENCE) OR OTHER LEGAL OR EQUITABLE THEORY, EVEN IF CHARGEPOINT KNEW OR SHOULD HAVE KNOWN OF THE POSSIBILITY OF SUCH DAMAGES. IN ANY EVENT, THE CUMULATIVE LIABILITY OF CHARGEPOINT FOR ALL CLAIMS WHATSOEVER RELATED TO THE CHARGING STATION WILL NOT EXCEED THE PRICE YOU PAID FOR THE CHARGING STATION. THE LIMITATIONS SET FORTH HEREIN ARE INTENDED TO LIMIT THE LIABILITY OF CHARGEPOINT AND SHALL APPLY NOTWITHSTANDING ANY FAILURE OF ESSENTIAL PURPOSE OF ANY LIMITED REMEDY.

FCC Compliance Statement

This equipment has been tested and found to comply with the limits for a Class A digital device pursuant to Part 15 of the FCC Rules. These limits are designed to provide reasonable protection against harmful interference when the equipment is operated in a commercial environment. This equipment generates, uses, and can radiate radio frequency energy and, if not installed and used in accordance with the manufacturer's instruction manual, may cause harmful interference with radio communications. Operation of this equipment in a residential area is likely to cause harmful interference, in which case, you will be required to correct the interference at your own expense.

Important: Changes or modifications to this product not authorized by ChargePoint, Inc., could affect the EMC compliance and revoke your authority to operate this product.

Exposure to Radio Frequency Energy: The radiated power output of the 802.11 b/g/n radio and cellular modem (optional) in this device is below the FCC radio frequency exposure limits for uncontrolled equipment. The antenna of this product, used under normal conditions, is at least 20 cm away from the body of the user. This device must not be co-located or operated with any other antenna or transmitter by the manufacturer, subject to the conditions of the FCC Grant.

Industry Canada

This device complies with Industry Canada license-exempt RSS standard(s). Operation is subject to the following two conditions: (1) this device may not cause interference, and (2) this device must accept any interference, including interference that may cause undesired operation of the device.

Le présent appareil est conforme aux CNR d'Industrie Canada applicables aux appareils radio exempts de licence. L'exploitation est autorisée aux deux conditions suivantes : (1) l'appareil ne doit pas produire de brouillage, et (2) l'utilisateur de l'appareil doit accepter tout brouillage radioélectrique subi, même si le brouillage est susceptible d'en compromettre le fonctionnement.

FCC/IC Compliance Labels

Visit chargepoint.com/labels/



chargepoint.com/support

75-001387-01 r1