

# PROJECT MANUAL

For

Spartanburg School District Seven



Multiple School Roof Repair

Carver MS, Jesse Boyd ES & McCracken MS

Prepared for

Spartanburg School District Seven

610 Dupre Drive, Spartanburg, SC 29307

Prepared by



SSD7 Project No. IFB# 20-21-05

WM Project No. 2021-25

Construction Documents

Issued: April 13, 2021

DOCUMENT 000100 – TABLE OF CONTENTS

**PROCUREMENT AND CONTRACTING DOCUMENTS**

DOCUMENT 000101 - PROJECT TITLE PAGE  
DOCUMENT 000107 - SEALS PAGE  
DOCUMENT 001116 - INVITATION TO BID  
AIA DOCUMENT – AIA A701 - INSTRUCTIONS TO BIDDERS  
DOCUMENT 002213 - SUPPLEMENTARY INSTRUCTIONS TO BIDDERS  
AIA DOCUMENT – AIA A310 - BID BOND  
BID FORM  
AIA DOCUMENT – AIA A101 – 2007 – OWNER AND CONTRACTOR AGREEMENT  
AIA DOCUMENT – AIA A201 – 2007 GENERAL CONDITIONS OF THE CONTRACT FOR CONSTRUCTION  
DOCUMENT – STANDARD SUPPLEMENTARY CONDITIONS  
DOCUMENT 002513 - PREBID MEETINGS  
AIA DOCUMENT – AIA A312 – 2010 – PERFORMANCE BOND  
AIA DOCUMENT – AIA A312 – 2010 – PAYMENT BOND  
AIA DOCUMENT – AIA G701 – 2001 – CHANGE ORDER  
AIA DOCUMENT – AIA G702 – 1992 – APPLICATION AND CERTIFICATE FOR PAYMENT  
AIA DOCUMENT – AIA G703 – 1992 – CONTINUATION SHEET  
AIA DOCUMENT – AIA G704 – 2000 – CERTIFICATE OF SUBSTANTIAL COMPLETION  
ASBESTOS FREE WARRANTY

**DIVISION 01 – GENERAL REQUIREMENTS**

SECTION 011000 – SUMMARY  
SECTION 012100 - ALLOWANCE  
SECTION 012200 - UNIT PRICES  
SECTION 012300 - ALTERNATES  
SECTION 012500 - SUBSTITUTION PROCEDURES  
SECTION 012600 - CONTRACT MODIFICATION PROCEDURES  
SECTION 012900 - PAYMENT PROCEDURES  
SECTION 013100 - PROJECT MANAGEMENT AND COORDINATION  
SECTION 013200 - CONSTRUCTION PROGRESS DOCUMENTATION  
SECTION 013233 - PHOTOGRAPHIC DOCUMENTATION  
SECTION 013300 - SUBMITTAL PROCEDURES  
SECTION 014000 - QUALITY REQUIREMENTS  
SECTION 015000 - TEMPORARY FACILITIES AND CONTROLS  
SECTION 016000 - PRODUCT REQUIREMENTS  
SECTION 017300 – EXECUTION  
SECTION 017700 - CLOSEOUT PROCEDURES  
SECTION 017839 - PROJECT RECORD DOCUMENTS

**DIVISION 02 – EXISTING CONDITIONS**

SECTION 024119 - SELECTIVE DEMOLITION

**DIVISION 07 – THERMAL AND MOISTURE PROTECTION**

SECTION 075215 – ROOF MEMBRANE REPAIRS

SECTION 076200 - SHEET METAL FLASHING AND TRIM

**DRAWINGS**

SHEET R-1.0 – COVER PAGE

SHEET R-1.1 – JESSE BOYD E.S. OVERALL EXISTING ROOF PLAN (BASE BID)

SHEET R-1.2 – JESSE BOYD E.S. REPAIR ROOF PLAN (BASE BID)

SHEET R-1.3 – CARVER M.S. OVERALL ROOF PLAN (BASE BID)

SHEET R-1.4 – CARVER M.S. REPAIR ROOF PLAN (BASE BID)

SHEET R-1.5 – McCRACKEN M.S. OVERALL ROOF PLAN (BASE BID)

SHEET R-1.6 – McCRACKEN M.S. REPAIR ROOF PLAN (BASE BID)

SHEET R-1.7 – McCRACKEN M.S. REPAIR ROOF PLAN (ALTERNATE NO.1)

SHEET D-1.1 – DETAILS

SHEET D-1.2 – DETAILS

SHEET D-1.1 – DETAILS

END OF DOCUMENT 000100

DOCUMENT 000101 - PROJECT TITLE PAGE

**PROJECT MANUAL**

Spartanburg School District Seven

Multiple School Roof Repair - Carver MS, Jesse Boyd ES & McCracken MS

Spartanburg School District Seven, Spartanburg, SC

SSD7 Project No. IFB# 20-21-05

WMBE Project No. 2021-25



Daniel Atwell, RBEC (RRC, RWC, REWC), RRO, REWO, CDT

1501 Chapin Road

Chapin, SC 29036

Phone: (803) 422-7493

daniel@wmbeconsultants.com

Construction Documents

Issued: April 13, 2021

END OF DOCUMENT 000101

DOCUMENT 000107 - SEALS PAGE

1.1 DESIGN PROFESSIONAL OF RECORD

Daniel Atwell, RBEC (RRC, RWC, REWC), RRO, REWO, CDT

CONSULTANT

WM Building Envelope Consultants

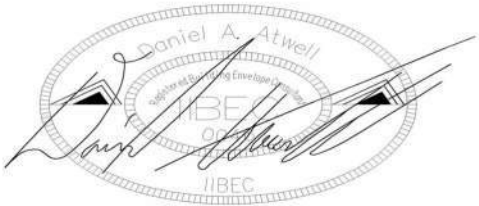

END OF DOCUMENT 000107

DOCUMENT 001116 - INVITATION TO BID

1.1 PROJECT INFORMATION

A. Notice to Bidders: Your firm is one of the bidders invited to submit bids for the Project as described in this Document according to the Instructions to Bidders.

B. Project Identification: Multiple School Roof Repair - Carver MS, Jesse Boyd ES & McCracken MS

1. Project Locations:

- a. Carver Middle School - 467 South Church Street Spartanburg, SC
- b. Jesse Boyd Elementary School - 1505 Fernwood-Glendale Road Spartanburg, SC
- c. McCracken Middle School – 50 Emory Road, Spartanburg, SC

C. Owner: Spartanburg School District Seven

1. Owner's Representative: Mr. Terry Gilmer, 610 Dupre Drive, Spartanburg, SC 29307.

Consultant: Daniel Atwell, WM Building Envelope Consultants, LLC, 1501 Chapin Road, Chapin, SC. Phone: 803-422-7493 or [daniel@wmbeconsultants.com](mailto:daniel@wmbeconsultants.com)

D. Project Description:

Base Bid

1. Scope of work includes miscellaneous selective roof repairs of the low slope roof areas at multiple schools as designated on the drawings. All new sheet metal items associated with the installation of the new repair work are required.

Alternate No. 1

2. Alternate No. 1 scope of work includes roof membrane repair work at McCracken Middle School on Roof Areas U, U1, U2 and V. All other requirements remain unchanged.

1.2 BID SUBMITTAL AND OPENING

A. Owner will receive sealed bids until the bid time and date at the location indicated below. Owner will consider bids prepared in compliance with the Instructions to Bidders issued by Owner, and delivered as follows:

1. Bid Date: Thursday, April 29, 2021.
2. Bid Time: 1:30 P.M.
3. Location: Spartanburg School District Seven Office – 610 Dupre Drive, Spartanburg, SC 29307.
4. Attention: Mr. Terry Gilmer

1.3 BID SECURITY

- A. Bid security shall be submitted with each bid in the amount of 5 percent of the bid amount. No bids may be withdrawn for a period of 60 days after opening of bids. Owner reserves the right to reject any and all bids and to waive informalities and irregularities.

1.4 PREBID CONFERENCE

- A. A **mandatory** pre-bid conference for all bidders will be held at McCracken Middle School, 50 Emory Road, Spartanburg, SC on **Wednesday, April 21, 2021 at 10:00 A.M.** **Prospective bidders are required to attend.**

1.5 DOCUMENTS

- A. Printed Procurement and Contracting Documents: Documents will be provided to the bidders at the pre-bid conference; only complete sets of documents will be issued.

1.6 TIME OF COMPLETION AND LIQUIDATED DAMAGES

- A. Bidders shall begin the Work on receipt of the Notice to Proceed and shall complete the Work within the Contract Time. **Work is subject to liquidated damages.**

1.7 BIDDER'S QUALIFICATIONS

- A. Bidders must be properly licensed under the laws governing their respective trades and be able to obtain insurance and bonds required for the Work. **A Performance Bond, a separate Labor and Material Payment Bond, and Insurance in a form acceptable to Owner will be required of the successful Bidder.**

END OF DOCUMENT 001116



# AIA<sup>®</sup> Document A701<sup>™</sup> – 2018

## Instructions to Bidders

for the following Project:

*(Name, location, and detailed description)*

Spartanburg School District Seven Multiple School Roof Repair

Base Bid scope of work includes miscellaneous selective roof repairs of the low slope roof areas at multiple schools as designated on the drawings. All new sheet metal items associated with the installation of the new repair work are required.

Alternate No. 1 scope of work includes roof membrane repair work at McCracken Middle School on Roof Areas U, U1, U2 and V. All other requirements remain unchanged.

### THE OWNER:

*(Name, legal status, address, and other information)*

Spartanburg School District Seven  
610 Dupre Drive  
Spartanburg, SC

### THE ARCHITECT:

*(Name, legal status, address, and other information)*

WM Building Envelope Consultants, LLC  
1501 Chapin Road  
Chapin, SC 29036

### TABLE OF ARTICLES

- 1 DEFINITIONS
- 2 BIDDER'S REPRESENTATIONS
- 3 BIDDING DOCUMENTS
- 4 BIDDING PROCEDURES
- 5 CONSIDERATION OF BIDS
- 6 POST-BID INFORMATION
- 7 PERFORMANCE BOND AND PAYMENT BOND
- 8 ENUMERATION OF THE PROPOSED CONTRACT DOCUMENTS

### ADDITIONS AND DELETIONS:

The author of this document has added information needed for its completion. The author may also have revised the text of the original AIA standard form. An *Additions and Deletions Report* that notes added information as well as revisions to the standard form text is available from the author and should be reviewed. A vertical line in the left margin of this document indicates where the author has added necessary information and where the author has added to or deleted from the original AIA text.

This document has important legal consequences. Consultation with an attorney is encouraged with respect to its completion or modification.

FEDERAL, STATE, AND LOCAL LAWS MAY IMPOSE REQUIREMENTS ON PUBLIC PROCUREMENT CONTRACTS. CONSULT LOCAL AUTHORITIES OR AN ATTORNEY TO VERIFY REQUIREMENTS APPLICABLE TO THIS PROCUREMENT BEFORE COMPLETING THIS FORM.

It is intended that AIA Document G612<sup>™</sup>–2017, Owner's Instructions to the Architect, Parts A and B will be completed prior to using this document.



## ARTICLE 1 DEFINITIONS

§ 1.1 Bidding Documents include the Bidding Requirements and the Proposed Contract Documents. The Bidding Requirements consist of the advertisement or invitation to bid, Instructions to Bidders, supplementary instructions to bidders, the bid form, and any other bidding forms. The Proposed Contract Documents consist of the unexecuted form of Agreement between the Owner and Contractor and that Agreement's Exhibits, Conditions of the Contract (General, Supplementary and other Conditions), Drawings, Specifications, all Addenda, and all other documents enumerated in Article 8 of these Instructions.

§ 1.2 Definitions set forth in the General Conditions of the Contract for Construction, or in other Proposed Contract Documents apply to the Bidding Documents.

§ 1.3 Addenda are written or graphic instruments issued by the Architect, which, by additions, deletions, clarifications, or corrections, modify or interpret the Bidding Documents.

§ 1.4 A Bid is a complete and properly executed proposal to do the Work for the sums stipulated therein, submitted in accordance with the Bidding Documents.

§ 1.5 The Base Bid is the sum stated in the Bid for which the Bidder offers to perform the Work described in the Bidding Documents, to which Work may be added or deleted by sums stated in Alternate Bids.

§ 1.6 An Alternate Bid (or Alternate) is an amount stated in the Bid to be added to or deducted from, or that does not change, the Base Bid if the corresponding change in the Work, as described in the Bidding Documents, is accepted.

§ 1.7 A Unit Price is an amount stated in the Bid as a price per unit of measurement for materials, equipment, or services, or a portion of the Work, as described in the Bidding Documents.

§ 1.8 A Bidder is a person or entity who submits a Bid and who meets the requirements set forth in the Bidding Documents.

§ 1.9 A Sub-bidder is a person or entity who submits a bid to a Bidder for materials, equipment, or labor for a portion of the Work.

## ARTICLE 2 BIDDER'S REPRESENTATIONS

§ 2.1 By submitting a Bid, the Bidder represents that:

- .1 the Bidder has read and understands the Bidding Documents;
- .2 the Bidder understands how the Bidding Documents relate to other portions of the Project, if any, being bid concurrently or presently under construction;
- .3 the Bid complies with the Bidding Documents;
- .4 the Bidder has visited the site, become familiar with local conditions under which the Work is to be performed, and has correlated the Bidder's observations with the requirements of the Proposed Contract Documents;
- .5 the Bid is based upon the materials, equipment, and systems required by the Bidding Documents without exception; and
- .6 the Bidder has read and understands the provisions for liquidated damages, if any, set forth in the form of Agreement between the Owner and Contractor.

## ARTICLE 3 BIDDING DOCUMENTS

### § 3.1 Distribution

§ 3.1.1 Bidders shall obtain complete Bidding Documents, as indicated below, from the issuing office designated in the advertisement or invitation to bid, for the deposit sum, if any, stated therein.

*(Indicate how, such as by email, website, host site/platform, paper copy, or other method Bidders shall obtain Bidding Documents.)*

Documents can be attained by contacting Daniel Atwell @ 803-422-7493 or [daniel@wmbeconsultants.com](mailto:daniel@wmbeconsultants.com)

**§ 3.1.2** Any required deposit shall be refunded to Bidders who submit a bona fide Bid and return the paper Bidding Documents in good condition within ten days after receipt of Bids. The cost to replace missing or damaged paper documents will be deducted from the deposit. A Bidder receiving a Contract award may retain the paper Bidding Documents, and the Bidder's deposit will be refunded.

**§ 3.1.3** Bidding Documents will not be issued directly to Sub-bidders unless specifically offered in the advertisement or invitation to bid, or in supplementary instructions to bidders.

**§ 3.1.4** Bidders shall use complete Bidding Documents in preparing Bids. Neither the Owner nor Architect assumes responsibility for errors or misinterpretations resulting from the use of incomplete Bidding Documents.

**§ 3.1.5** The Bidding Documents will be available for the sole purpose of obtaining Bids on the Work. No license or grant of use is conferred by distribution of the Bidding Documents.

### **§ 3.2 Modification or Interpretation of Bidding Documents**

**§ 3.2.1** The Bidder shall carefully study the Bidding Documents, shall examine the site and local conditions, and shall notify the Architect of errors, inconsistencies, or ambiguities discovered and request clarification or interpretation pursuant to Section 3.2.2.

**§ 3.2.2** Requests for clarification or interpretation of the Bidding Documents shall be submitted by the Bidder in writing and shall be received by the Architect at least seven days prior to the date for receipt of Bids. *(Indicate how, such as by email, website, host site/platform, paper copy, or other method Bidders shall submit requests for clarification and interpretation.)*

Submit requests via email to [daniel@wmbeconsultants.com](mailto:daniel@wmbeconsultants.com)

**§ 3.2.3** Modifications and interpretations of the Bidding Documents shall be made by Addendum. Modifications and interpretations of the Bidding Documents made in any other manner shall not be binding, and Bidders shall not rely upon them.

### **§ 3.3 Substitutions**

**§ 3.3.1** The materials, products, and equipment described in the Bidding Documents establish a standard of required function, dimension, appearance, and quality to be met by any proposed substitution.

#### **§ 3.3.2 Substitution Process**

**§ 3.3.2.1** Written requests for substitutions shall be received by the Architect at least ten days prior to the date for receipt of Bids. Requests shall be submitted in the same manner as that established for submitting clarifications and interpretations in Section 3.2.2.

**§ 3.3.2.2** Bidders shall submit substitution requests on a Substitution Request Form if one is provided in the Bidding Documents.

**§ 3.3.2.3** If a Substitution Request Form is not provided, requests shall include (1) the name of the material or equipment specified in the Bidding Documents; (2) the reason for the requested substitution; (3) a complete description of the proposed substitution including the name of the material or equipment proposed as the substitute, performance and test data, and relevant drawings; and (4) any other information necessary for an evaluation. The request shall include a statement setting forth changes in other materials, equipment, or other portions of the Work, including changes in the work of other contracts or the impact on any Project Certifications (such as LEED), that will result from incorporation of the proposed substitution.

**§ 3.3.3** The burden of proof of the merit of the proposed substitution is upon the proposer. The Architect's decision of approval or disapproval of a proposed substitution shall be final.

**§ 3.3.4** If the Architect approves a proposed substitution prior to receipt of Bids, such approval shall be set forth in an Addendum. Approvals made in any other manner shall not be binding, and Bidders shall not rely upon them.

§ 3.3.5 No substitutions will be considered after the Contract award unless specifically provided for in the Contract Documents.

#### § 3.4 Addenda

§ 3.4.1 Addenda will be transmitted to Bidders known by the issuing office to have received complete Bidding Documents.

*(Indicate how, such as by email, website, host site/platform, paper copy, or other method Addenda will be transmitted.)*

Addenda will be issued via email.

§ 3.4.2 Addenda will be available where Bidding Documents are on file.

§ 3.4.3 Addenda will be issued no later than four days prior to the date for receipt of Bids, except an Addendum withdrawing the request for Bids or one which includes postponement of the date for receipt of Bids.

§ 3.4.4 Prior to submitting a Bid, each Bidder shall ascertain that the Bidder has received all Addenda issued, and the Bidder shall acknowledge their receipt in the Bid.

### ARTICLE 4 BIDDING PROCEDURES

#### § 4.1 Preparation of Bids

§ 4.1.1 Bids shall be submitted on the forms included with or identified in the Bidding Documents.

§ 4.1.2 All blanks on the bid form shall be legibly executed. Paper bid forms shall be executed in a non-erasable medium.

§ 4.1.3 Sums shall be expressed in both words and numbers, unless noted otherwise on the bid form. In case of discrepancy, the amount entered in words shall govern.

§ 4.1.4 Edits to entries made on paper bid forms must be initialed by the signer of the Bid.

§ 4.1.5 All requested Alternates shall be bid. If no change in the Base Bid is required, enter "No Change" or as required by the bid form.

§ 4.1.6 Where two or more Bids for designated portions of the Work have been requested, the Bidder may, without forfeiture of the bid security, state the Bidder's refusal to accept award of less than the combination of Bids stipulated by the Bidder. The Bidder shall neither make additional stipulations on the bid form nor qualify the Bid in any other manner.

§ 4.1.7 Each copy of the Bid shall state the legal name and legal status of the Bidder. As part of the documentation submitted with the Bid, the Bidder shall provide evidence of its legal authority to perform the Work in the jurisdiction where the Project is located. Each copy of the Bid shall be signed by the person or persons legally authorized to bind the Bidder to a contract. A Bid by a corporation shall further name the state of incorporation and have the corporate seal affixed. A Bid submitted by an agent shall have a current power of attorney attached, certifying the agent's authority to bind the Bidder.

§ 4.1.8 A Bidder shall incur all costs associated with the preparation of its Bid.

#### § 4.2 Bid Security

§ 4.2.1 Each Bid shall be accompanied by the following bid security:

*(Insert the form and amount of bid security.)*

Each bid shall be accompanied by a bid security on the required form and in the amount required in the instructions to bidders.

§ 4.2.2 The Bidder pledges to enter into a Contract with the Owner on the terms stated in the Bid and shall, if required, furnish bonds covering the faithful performance of the Contract and payment of all obligations arising

thereunder. Should the Bidder refuse to enter into such Contract or fail to furnish such bonds if required, the amount of the bid security shall be forfeited to the Owner as liquidated damages, not as a penalty. In the event the Owner fails to comply with Section 6.2, the amount of the bid security shall not be forfeited to the Owner.

**§ 4.2.3** If a surety bond is required as bid security, it shall be written on AIA Document A310™, Bid Bond, unless otherwise provided in the Bidding Documents. The attorney-in-fact who executes the bond on behalf of the surety shall affix to the bond a certified and current copy of an acceptable power of attorney. The Bidder shall provide surety bonds from a company or companies lawfully authorized to issue surety bonds in the jurisdiction where the Project is located.

**§ 4.2.4** The Owner will have the right to retain the bid security of Bidders to whom an award is being considered until (a) the Contract has been executed and bonds, if required, have been furnished; (b) the specified time has elapsed so that Bids may be withdrawn; or (c) all Bids have been rejected. However, if no Contract has been awarded or a Bidder has not been notified of the acceptance of its Bid, a Bidder may, beginning 60 days after the opening of Bids, withdraw its Bid and request the return of its bid security.

### **§ 4.3 Submission of Bids**

**§ 4.3.1** A Bidder shall submit its Bid as indicated below:

*(Indicate how, such as by website, host site/platform, paper copy, or other method Bidders shall submit their Bid.)*

Bids shall be submitted as outlined in 4.3.2

**§ 4.3.2** Paper copies of the Bid, the bid security, and any other documents required to be submitted with the Bid shall be enclosed in a sealed opaque envelope. The envelope shall be addressed to the party receiving the Bids and shall be identified with the Project name, the Bidder's name and address, and, if applicable, the designated portion of the Work for which the Bid is submitted. If the Bid is sent by mail, the sealed envelope shall be enclosed in a separate mailing envelope with the notation "SEALED BID ENCLOSED" on the face thereof.

**§ 4.3.3** Bids shall be submitted by the date and time and at the place indicated in the invitation to bid. Bids submitted after the date and time for receipt of Bids, or at an incorrect place, will not be accepted.

**§ 4.3.4** The Bidder shall assume full responsibility for timely delivery at the location designated for receipt of Bids.

**§ 4.3.5** A Bid submitted by any method other than as provided in this Section 4.3 will not be accepted.

### **§ 4.4 Modification or Withdrawal of Bid**

**§ 4.4.1** Prior to the date and time designated for receipt of Bids, a Bidder may submit a new Bid to replace a Bid previously submitted, or withdraw its Bid entirely, by notice to the party designated to receive the Bids. Such notice shall be received and duly recorded by the receiving party on or before the date and time set for receipt of Bids. The receiving party shall verify that replaced or withdrawn Bids are removed from the other submitted Bids and not considered. Notice of submission of a replacement Bid or withdrawal of a Bid shall be worded so as not to reveal the amount of the original Bid.

**§ 4.4.2** Withdrawn Bids may be resubmitted up to the date and time designated for the receipt of Bids in the same format as that established in Section 4.3, provided they fully conform with these Instructions to Bidders. Bid security shall be in an amount sufficient for the Bid as resubmitted.

**§ 4.4.3** After the date and time designated for receipt of Bids, a Bidder who discovers that it made a clerical error in its Bid shall notify the Architect of such error within two days, or pursuant to a timeframe specified by the law of the jurisdiction where the Project is located, requesting withdrawal of its Bid. Upon providing evidence of such error to the reasonable satisfaction of the Architect, the Bid shall be withdrawn and not resubmitted. If a Bid is withdrawn pursuant to this Section 4.4.3, the bid security will be attended to as follows:

*(State the terms and conditions, such as Bid rank, for returning or retaining the bid security.)*

## **ARTICLE 5 CONSIDERATION OF BIDS**

### **§ 5.1 Opening of Bids**

If stipulated in an advertisement or invitation to bid, or when otherwise required by law, Bids properly identified and received within the specified time limits will be publicly opened and read aloud. A summary of the Bids may be made available to Bidders.

### **§ 5.2 Rejection of Bids**

Unless otherwise prohibited by law, the Owner shall have the right to reject any or all Bids.

### **§ 5.3 Acceptance of Bid (Award)**

**§ 5.3.1** It is the intent of the Owner to award a Contract to the lowest responsive and responsible Bidder, provided the Bid has been submitted in accordance with the requirements of the Bidding Documents. Unless otherwise prohibited by law, the Owner shall have the right to waive informalities and irregularities in a Bid received and to accept the Bid which, in the Owner's judgment, is in the Owner's best interests.

**§ 5.3.2** Unless otherwise prohibited by law, the Owner shall have the right to accept Alternates in any order or combination, unless otherwise specifically provided in the Bidding Documents, and to determine the lowest responsive and responsible Bidder on the basis of the sum of the Base Bid and Alternates accepted.

## **ARTICLE 6 POST-BID INFORMATION**

### **§ 6.1 Contractor's Qualification Statement**

Bidders to whom award of a Contract is under consideration shall submit to the Architect, upon request and within the timeframe specified by the Architect, a properly executed AIA Document A305™, Contractor's Qualification Statement, unless such a Statement has been previously required and submitted for this Bid.

### **§ 6.2 Owner's Financial Capability**

A Bidder to whom award of a Contract is under consideration may request in writing, fourteen days prior to the expiration of the time for withdrawal of Bids, that the Owner furnish to the Bidder reasonable evidence that financial arrangements have been made to fulfill the Owner's obligations under the Contract. The Owner shall then furnish such reasonable evidence to the Bidder no later than seven days prior to the expiration of the time for withdrawal of Bids. Unless such reasonable evidence is furnished within the allotted time, the Bidder will not be required to execute the Agreement between the Owner and Contractor.

### **§ 6.3 Submittals**

**§ 6.3.1** After notification of selection for the award of the Contract, the Bidder shall, as soon as practicable or as stipulated in the Bidding Documents, submit in writing to the Owner through the Architect:

- .1 a designation of the Work to be performed with the Bidder's own forces;
- .2 names of the principal products and systems proposed for the Work and the manufacturers and suppliers of each; and
- .3 names of persons or entities (including those who are to furnish materials or equipment fabricated to a special design) proposed for the principal portions of the Work.

**§ 6.3.2** The Bidder will be required to establish to the satisfaction of the Architect and Owner the reliability and responsibility of the persons or entities proposed to furnish and perform the Work described in the Bidding Documents.

**§ 6.3.3** Prior to the execution of the Contract, the Architect will notify the Bidder if either the Owner or Architect, after due investigation, has reasonable objection to a person or entity proposed by the Bidder. If the Owner or Architect has reasonable objection to a proposed person or entity, the Bidder may, at the Bidder's option, withdraw the Bid or submit an acceptable substitute person or entity. The Bidder may also submit any required adjustment in the Base Bid or Alternate Bid to account for the difference in cost occasioned by such substitution. The Owner may accept the adjusted bid price or disqualify the Bidder. In the event of either withdrawal or disqualification, bid security will not be forfeited.

**§ 6.3.4** Persons and entities proposed by the Bidder and to whom the Owner and Architect have made no reasonable objection must be used on the Work for which they were proposed and shall not be changed except with the written consent of the Owner and Architect.



## ARTICLE 7 PERFORMANCE BOND AND PAYMENT BOND

### § 7.1 Bond Requirements

§ 7.1.1 If stipulated in the Bidding Documents, the Bidder shall furnish bonds covering the faithful performance of the Contract and payment of all obligations arising thereunder.

§ 7.1.2 If the furnishing of such bonds is stipulated in the Bidding Documents, the cost shall be included in the Bid. If the furnishing of such bonds is required after receipt of bids and before execution of the Contract, the cost of such bonds shall be added to the Bid in determining the Contract Sum.

§ 7.1.3 The Bidder shall provide surety bonds from a company or companies lawfully authorized to issue surety bonds in the jurisdiction where the Project is located.

§ 7.1.4 Unless otherwise indicated below, the Penal Sum of the Payment and Performance Bonds shall be the amount of the Contract Sum.

*(If Payment or Performance Bonds are to be in an amount other than 100% of the Contract Sum, indicate the dollar amount or percentage of the Contract Sum.)*

### § 7.2 Time of Delivery and Form of Bonds

§ 7.2.1 The Bidder shall deliver the required bonds to the Owner not later than three days following the date of execution of the Contract. If the Work is to commence sooner in response to a letter of intent, the Bidder shall, prior to commencement of the Work, submit evidence satisfactory to the Owner that such bonds will be furnished and delivered in accordance with this Section 7.2.1.

§ 7.2.2 Unless otherwise provided, the bonds shall be written on AIA Document A312, Performance Bond and Payment Bond.

§ 7.2.3 The bonds shall be dated on or after the date of the Contract.

§ 7.2.4 The Bidder shall require the attorney-in-fact who executes the required bonds on behalf of the surety to affix to the bond a certified and current copy of the power of attorney.

## ARTICLE 8 ENUMERATION OF THE PROPOSED CONTRACT DOCUMENTS

§ 8.1 Copies of the proposed Contract Documents have been made available to the Bidder and consist of the following documents:

- .1 AIA Document A101™–2017, Standard Form of Agreement Between Owner and Contractor, unless otherwise stated below.  
*(Insert the complete AIA Document number, including year, and Document title.)*
- .2 AIA Document A101™–2017, Exhibit A, Insurance and Bonds, unless otherwise stated below.  
*(Insert the complete AIA Document number, including year, and Document title.)*
- .3 AIA Document A201™–2017, General Conditions of the Contract for Construction, unless otherwise stated below.  
*(Insert the complete AIA Document number, including year, and Document title.)*
- .4 AIA Document E203™–2013, Building Information Modeling and Digital Data Exhibit, dated as indicated below:  
*(Insert the date of the E203-2013.)*

**.5 Drawings**

<b>Number</b>	<b>Title</b>	<b>Date</b>
See Section 000100 Table of Contents		

**.6 Specifications**

<b>Section</b>	<b>Title</b>	<b>Date</b>	<b>Pages</b>
See Section 000100 Table of Contents			

**.7 Addenda:**

<b>Number</b>	<b>Date</b>	<b>Pages</b>
---------------	-------------	--------------

**.8 Other Exhibits:**

*(Check all boxes that apply and include appropriate information identifying the exhibit where required.)*

AIA Document E204™–2017, Sustainable Projects Exhibit, dated as indicated below:  
*(Insert the date of the E204-2017.)*

The Sustainability Plan:

<b>Title</b>	<b>Date</b>	<b>Pages</b>
--------------	-------------	--------------

Supplementary and other Conditions of the Contract:

<b>Document</b>	<b>Title</b>	<b>Date</b>	<b>Pages</b>
-----------------	--------------	-------------	--------------

**.9 Other documents listed below:**

*(List here any additional documents that are intended to form part of the Proposed Contract Documents.)*

DOCUMENT 002213 - SUPPLEMENTARY INSTRUCTIONS TO BIDDERS

1.1 INSTRUCTIONS TO BIDDERS

- A. Instructions to Bidders for Project consist of the following:
  - 1. AIA Document A701, "Instructions to Bidders".
  - 2. The following Supplementary Instructions to Bidders that modify and add to the requirements of the Instructions to Bidders.

1.2 SUPPLEMENTARY INSTRUCTIONS TO BIDDERS, GENERAL

- A. The following supplements modify AIA Document A701, "Instructions to Bidders." Where a portion of the Instructions to Bidders is modified or deleted by these Supplementary Instructions to Bidders, unaltered portions of the Instructions to Bidders shall remain in effect.

1.3 ARTICLE 2 - BIDDER'S REPRESENTATIONS

- A. Add Section 2.1.3.1:
  - 1. 2.1.3.1 - The Bidder has investigated all required fees, permits, and regulatory requirements of authorities having jurisdiction and has properly included in the submitted bid the cost of such fees, permits, and requirements not otherwise indicated as provided by Owner.
- B. Add Section 2.1.5:
  - 1. 2.1.5 - The Bidder is a properly licensed Contractor according to the laws and regulations of the state of South Carolina and meets qualifications indicated in the Procurement and Contracting Documents.
- C. Add Section 2.1.6:
  - 1. 2.1.6 - The Bidder has incorporated into the Bid adequate sums for work performed by installers whose qualifications meet those indicated in the Procurement and Contracting Documents.

1.4 ARTICLE 3 - BIDDING DOCUMENTS

- A. 3.2 - Interpretation or Correction of Procurement and Contracting Documents:
  - 1. Add Section 3.2.2.1:
    - a. 3.2.2.1 - Submit Bidder's Requests for Interpretation using form furnished with electronic bid forms and submitted via email.



B. 3.4 - Addenda:

1. Delete Section 3.4.3 and replace with the following:
  - a. 3.4.3 - Addenda may be issued at any time prior to the receipt of bids.
2. Add Section 3.4.4.1:
  - a. 3.4.4.1 - Owner may elect to waive the requirement for acknowledging receipt of 3.4.4 Addenda as follows:
    - 1) 3.4.4.1.1 - Information received as part of the Bid indicates that the Bid, as submitted, reflects modifications to the Procurement and Contracting Documents included in an unacknowledged Addendum.
    - 2) 3.4.4.1.2 - Modifications to the Procurement and Contracting Documents in an unacknowledged Addendum do not, in the opinion of Owner, affect the Contract Sum or Contract Time.

1.5 ARTICLE 4 - BIDDING PROCEDURES

A. 4.1 - Preparation of Bids:

1. Add Section 4.1.1.1:
  - a. 4.1.1.1 - Printable electronic Bid Forms and related documents are available from Consultant.
2. Add Section 4.1.8:
  - a. 4.1.8 - The Bid shall include unit prices when called for by the Procurement and Contracting Documents. Owner may elect to consider unit prices in the determination of award. Unit prices will be incorporated into the Contract.
3. Add Section 4.1.9:
  - a. 4.1.9 - Owner may elect to disqualify a bid due to failure to submit a bid in the form requested, failure to bid requested alternates or unit prices, failure to complete entries in all blanks in the Bid Form, or inclusion by the Bidder of any alternates, conditions, limitations or provisions not called for.
4. Add Section 4.1.10:
  - a. 4.1.10 - Bids shall include sales and use taxes. Contractors shall show separately with each monthly payment application the sales and use taxes paid by them and their subcontractors in the form indicated. Reimbursement of sales and use taxes, if any, shall be applied for by Owner for the sole benefit of Owner.

B. 4.3 - Submission of Bids:

1. Add Section 4.3.1.2:

- a. 4.3.1.2 - Include Bidder's Contractor License Number applicable in Project jurisdiction on the face of the sealed bid envelope.

C. 4.4 - Modification or Withdrawal of Bids:

1. Add the following sections to 4.4.2:

- a. 4.4.2.1 - Such modifications to or withdrawal of a bid may only be made by persons authorized to act on behalf of the Bidder. Authorized persons are those so identified in the Bidder's corporate bylaws, specifically empowered by the Bidder's charter or similar legally binding document acceptable to Owner, or by a power of attorney, signed and dated, describing the scope and limitations of the power of attorney. Make such documentation available to Owner at the time of seeking modifications or withdrawal of the Bid.
- b. 4.4.2.2 - Owner will consider modifications to a bid written on the sealed bid envelope by authorized persons when such modifications comply with the following: the modification is indicated by a percent or stated amount to be added to or deducted from the Bid; the amount of the Bid itself is not made known by the modification; a signature of the authorized person, along with the time and date of the modification, accompanies the modification. Completion of an unsealed bid form, awaiting final figures from the Bidder, does not require power of attorney due to the evidenced authorization of the Bidder implied by the circumstance of the completion and delivery of the Bid.

D. 4.5 - Break-Out Pricing Bid Supplement:

1. Add Section 4.5:

- a. 4.5 - Provide detailed cost breakdowns on forms provided no later than two business days following Architect's request.

E. 4.6 - Subcontractors, Suppliers, and Manufacturers List Bid Supplement:

1. Add Section 4.6:

- a. 4.6 - Provide list of major subcontractors, suppliers, and manufacturers furnishing or installing products on forms provided no later than two business days following Architect's request. Include those subcontractors, suppliers, and manufacturers providing work totaling three percent or more of the Bid amount. Do not change subcontractors, suppliers, and manufacturers from those submitted without approval of Architect.

1.6 ARTICLE 5 - CONSIDERATION OF BIDS

A. 5.2 - Rejection of Bids:

1. Add Section 5.2.1:

- a. 5.2.1 - Owner reserves the right to reject a bid based on Owner's and Architect's evaluation of qualification information submitted following opening of bids.

Owner's evaluation of the Bidder's qualifications will include: status of licensure and record of compliance with licensing requirements, record of quality of completed work, record of Project completion and ability to complete, record of financial management including financial resources available to complete Project and record of timely payment of obligations, record of Project site management including compliance with requirements of authorities having jurisdiction, record of and number of current claims and disputes and the status of their resolution, and qualifications of the Bidder's proposed Project staff and proposed subcontractors.

1.7 ARTICLE 6 - POSTBID INFORMATION

A. 6.1 - Contractor's Qualification Statement:

1. Add Section 6.1.1:

- a. 6.1.1 - Submit Contractor's Qualification Statement no later than two business days following Architect's request.

B. 6.3 - Submittals:

1. Add Section 6.3.1.4:

- a. 6.3.1.4 - Submit information requested in Sections 6.3.1.1, 6.3.1.2, and 6.3.1.3 no later than two business days following Architect's request.

1.8 ARTICLE 7 - PERFORMANCE BOND AND PAYMENT BOND

A. 7.1 - Bond Requirements:

1. Add Section 7.1.1.1:

- a. 7.1.1.1 - Both a Performance Bond and a Payment Bond will be required, each in an amount equal to 100 percent of the Contract Sum.

B. 7.2 - Time of Delivery and Form of Bonds:

1. Delete the first sentence of Section 7.2.1 and insert the following:

- a. The Bidder shall deliver the required bonds to Owner no later than 10 days after the date of Notice of Intent to Award and no later than the date of execution of the Contract, whichever occurs first. Owner may deem the failure of the Bidder to deliver required bonds within the period of time allowed a default.

2. Delete Section 7.2.3 and insert the following:

- a. 7.2.3 - Bonds shall be executed and be in force on the date of the execution of the Contract.

1.9 ARTICLE 9 - EXECUTION OF THE CONTRACT

A. Add Article 9:

1. 9.1.1 - Subsequent to the Notice of Intent to Award, and within 10 days after the prescribed Form of Agreement is presented to the Awardee for signature, the Awardee shall execute and deliver the Agreement to Owner through Architect, in such number of counterparts as Owner may require.
2. 9.1.2 - Owner may deem as a default the failure of the Awardee to execute the Contract and to supply the required bonds when the Agreement is presented for signature within the period of time allowed.
3. 9.1.3 - Unless otherwise indicated in the Procurement and Contracting Documents or the executed Agreement, the date of commencement of the Work shall be the date of the executed Agreement.
4. 9.1.4 - In the event of a default, Owner may declare the amount of the Bid security forfeited and elect to either award the Contract to the next responsible bidder or re-advertise for bids.

END OF DOCUMENT 002213

 **AIA** Document A310™ – 2010**Bid Bond****CONTRACTOR:***(Name, legal status and address)***SURETY:***(Name, legal status and principal place of business)***OWNER:***(Name, legal status and address)*  
Spartanburg School District Seven  
610 Dupre Drive, Spartanburg, SC**BOND AMOUNT: \$****PROJECT:***(Name, location or address, and Project number, if any)*  
Spartanburg School District Seven Multiple School Roof Repair  
Carver Middle School - 467 South Church Street, Spartanburg SC 29307  
Jesse Boyd Elementary School - 1505 Fernwood Glendale Road, Spartanburg, SC 29307  
McCracken Middle School - 50 Emory Road, Spartanburg, SC 29307

The Contractor and Surety are bound to the Owner in the amount set forth above, for the payment of which the Contractor and Surety bind themselves, their heirs, executors, administrators, successors and assigns, jointly and severally, as provided herein. The conditions of this Bond are such that if the Owner accepts the bid of the Contractor within the time specified in the bid documents, or within such time period as may be agreed to by the Owner and Contractor, and the Contractor either (1) enters into a contract with the Owner in accordance with the terms of such bid, and gives such bond or bonds as may be specified in the bidding or Contract Documents, with a surety admitted in the jurisdiction of the Project and otherwise acceptable to the Owner, for the faithful performance of such Contract and for the prompt payment of labor and material furnished in the prosecution thereof; or (2) pays to the Owner the difference, not to exceed the amount of this Bond, between the amount specified in said bid and such larger amount for which the Owner may in good faith contract with another party to perform the work covered by said bid, then this obligation shall be null and void, otherwise to remain in full force and effect. The Surety hereby waives any notice of an agreement between the Owner and Contractor to extend the time in which the Owner may accept the bid. Waiver of notice by the Surety shall not apply to any extension exceeding sixty (60) days in the aggregate beyond the time for acceptance of bids specified in the bid documents, and the Owner and Contractor shall obtain the Surety's consent for an extension beyond sixty (60) days.

If this Bond is issued in connection with a subcontractor's bid to a Contractor, the term Contractor in this Bond shall be deemed to be Subcontractor and the term Owner shall be deemed to be Contractor.

When this Bond has been furnished to comply with a statutory or other legal requirement in the location of the Project, any provision in this Bond conflicting with said statutory or legal requirement shall be deemed deleted herefrom and provisions conforming to such statutory or other legal requirement shall be deemed incorporated herein. When so

**ADDITIONS AND DELETIONS:**

The author of this document has added information needed for its completion. The author may also have revised the text of the original AIA standard form. An *Additions and Deletions Report* that notes added information as well as revisions to the standard form text is available from the author and should be reviewed. A vertical line in the left margin of this document indicates where the author has added necessary information and where the author has added to or deleted from the original AIA text.

This document has important legal consequences. Consultation with an attorney is encouraged with respect to its completion or modification.

Any singular reference to Contractor, Surety, Owner or other party shall be considered plural where applicable.



# BID FORM

---

**BID SUBMITTED BY:** \_\_\_\_\_

**BID SUBMITTED TO:** Spartanburg School District Seven

**FOR: PROJECT NAME:** Multiple School Roof Repair - Carver MS, Jesse Boyd ES & McCracken MS

**PROJECT NUMBER:** IFB# 20-21-05

## **OFFER**

- A. In response to the Invitation for Construction Services and in compliance with the Instructions to Bidders for the subject project, the Bidder agrees, if this Bid is accepted, to enter into a Contract with the Owner on the terms and conditions included in the Bidding Documents, and to perform all Work as specified in the Bidding Documents, for the price and within the time frames indicated in this Bid and in accordance with the other requirements of the Bidding Documents.
- B. The Bidder has submitted Bid Security as follows in the amount and form required by the Bidding Documents:
- Bid Bond with Power of Attorney**
  - Electronic Bid Bond**
  - Cashier's Check**
- C. The Bidder acknowledges the receipt of the following Addenda to the Bidding Documents and has incorporated any and all changes included in the Addenda into this Bid:
- LIST ALL ADDENDA RECEIVED:**
- D. Bidder accepts all terms and conditions of the Invitation for Bids, including, without limitation, those dealing with the disposition of Bid Security. Bidder agrees that this Bid, including all Bid Alternates, if any, may not be revoked or withdrawn after the opening of bids, and shall remain open for acceptance for a period of **60** Days following the Bid Date, or for a longer period of time that Bidder may agree to in writing upon request of the Owner.
- E. Bidder offers to provide all labor, materials, equipment, tools of trades and labor, accessories, appliances, warranties and guarantees, and to pay all royalties, fees, permits, licenses and applicable taxes necessary to complete the following items of construction work:
- F. **BASE BID WORK (Generally described as follows):** Scope of work includes miscellaneous selective roof repairs of the low slope roof areas at multiple schools as designated on the drawings. All new sheet metal items associated with the installation of the new repair work are required.

\$ \_\_\_\_\_, which sum is hereafter called the Base Bid.  
*(Insert Base Bid Amount)*

## BID FORM

G. **BID ALTERNATES** as indicated in the Bidding Documents and generally described as follows:

**ALTERNATE No. 1 (Generally described as follows):** (Add 15 Calendar Days) Scope of work includes roof membrane repair work on Roof Areas U, U1, U2 and V. All other requirements remain unchanged.

ADD or  DEDUCT FROM BASE BID: \$ \_\_\_\_\_

*(Bidder to Mark appropriate box)*

H. **UNIT PRICES:**

**BIDDER** offers for the Owner's consideration and use, the following UNIT PRICES. The UNIT PRICES offered by BIDDER indicate the amount to be added or deducted from the CONTRACT SUM for each item. UNIT PRICES include all costs, including those for materials, labor, equipment, tools of trades and labor, fees, taxes, insurance, bonding, overhead, profit, etc. The Owner reserves the right to include or not to include any of the following UNIT PRICES in the Contract and to negotiate the UNIT PRICES with BIDDER.

<b>No.</b>	<b>Quantity</b>	<b>Item</b>	<b>Unit of Measure</b>	<b>Add/Deduct</b>
1.	<u>100</u>	<u>Roof Membrane Repair</u>	<u>SF</u>	<u>\$</u>
2.	<u>20</u>	<u>Base Flashing Repair</u>	<u>LF</u>	<u>\$</u>
3.	<u>4</u>	<u>VTR Repair</u>	<u>EA</u>	<u>\$</u>
4.	<u>8</u>	<u>Roof Drain Repairs</u>	<u>EA</u>	<u>\$</u>
5.	<u>4</u>	<u>Roof Drain Replacement</u>	<u>EA</u>	<u>\$</u>
6.	<u>-</u>	<u>Pitch Pan Repairs</u>	<u>EA</u>	<u>\$</u>

I. **SUBCONTRACTORS**

- a. **Definition of Subcontractor:** A subcontractor is an entity who will perform work or render service to the prime contractor to or about the construction site pursuant to a contract with the prime contractor. Bidder should not identify sub-subcontractors in the spaces provided on the bid form but only those entities with which bidder will contract directly. Likewise, do not identify material suppliers, manufacturers, and fabricators that will not perform physical work at the site of the project but will only supply materials or equipment to the bidder or proposed subcontractor(s).
- b. **Subcontractor Qualifications:** Bidder must only list subcontractors who possess a South Carolina Contractor's license with the license classification and/or subclassification identified in the left column. The subcontractor license must also be within the appropriate license group for the work of the specialty. If Bidder lists a subcontractor who is not qualified to perform the work, the Bidder will be rejected as non-responsible.
- c. **Use of Own forces:** If under the terms of the Bidding Documents, Bidder is qualified to perform the work of a listed specialty and Bidder does not intend to subcontract such work but to use Bidder's



## BID FORM

own employees to perform such work, the Bidder must insert its own name in the space provided for that specialty.

- d. If bidder is awarded the contract, bidder will not be allowed to substitute another subcontractor in place of a subcontractor listed above unless approved by the Owner.
- e. Bidder's failure to identify a subcontractor or themselves to perform the work of a subcontractor specialty listed in the first column on the left will render the Bid non-responsive.

### LISTING OF PROPOSED SUBCONTRACTORS

Bidder shall use the below-listed Subcontractors in the performance of the Subcontractor Classification work listed:

SUBCONTRACTOR CLASSIFICATION By License Classification and/or Subclassification	SUBCONTRACTOR'S PRIME CONTRACTOR'S NAME <i>(To be completed by Bidder)</i>	SUBCONTRACTOR'S PRIME CONTRACTOR'S SC LICENSE NUMBER <i>(To be completed by Bidder)</i>
<b>BASE BID</b>		
"NO SUBCONTRACTOR LISTING REQUIRED"		
<b>ALTERNATES</b>		
"NO SUBCONTRACTOR LISTING REQUIRED"		

If a Bid Alternate is accepted, Subcontractors listed for the Bid Alternate shall be used for the work of both the Alternate and the Base Bid work.

### J. TIME OF CONTRACT PERFORMANCE AND LIQUIDATED DAMAGES

#### a) CONTRACT TIME

The Date of Commencement of the Work shall be established in a Notice to Proceed. Substantial completion of the Work shall be within (30) Calendar Days from the Date of Commencement. Substantial completion is subject to changes as provided in the Contract Documents.

#### b) LIQUIDATED DAMAGES

The Owner shall retain as Liquidated Damages the amount of \$300 for each Calendar Day the actual construction time required to achieve Substantial Completion exceeds the specified or adjusted time for Substantial Completion.

The Owner shall retain as Liquidated Damages the amount of \$300 for each Calendar Day the actual construction time required to achieve Final Completion exceeds 30 calendar days beyond awarded Substantial Completion.

### K. AGREEMENTS

- a) Bidder agrees that this bid is subject to the requirements of the laws of the State of South Carolina.

## BID FORM

- b) Bidder agrees that at any time prior to the issuance of the Notice to Proceed for this Project, this Project may be canceled for the convenience of, and without cost to, the Owner.
- c) The Owner, employees, representatives, consultants, agents, etc. shall not be responsible for any bid preparation costs or charges of any type, if all bids are rejected or the Project is canceled for any reason prior to the issuance of the Notice to Proceed.

### CONTRACTOR'S CLASSIFICATIONS AND SUBCLASSIFICATIONS WITH LIMITATION

SC Contractor's License No.: \_\_\_\_\_

Classification(s) & Limits.: \_\_\_\_\_

Subclassification(s) & Limits: \_\_\_\_\_

Bidder's Legal Name: \_\_\_\_\_

Address: \_\_\_\_\_

Telephone: \_\_\_\_\_

Email: \_\_\_\_\_

Signature: \_\_\_\_\_ DATE: \_\_\_\_\_

Print Name: \_\_\_\_\_

Title: \_\_\_\_\_

 **AIA** Document A101® – 2017**Standard Form of Agreement Between Owner and Contractor where the basis of payment is a Stipulated Sum**

**AGREEMENT** made as of the    day of    in the year  
*(In words, indicate day, month and year.)*

**BETWEEN** the Owner:  
*(Name, legal status, address and other information)*

Spartanburg School District Seven  
610 Dupre Drive  
Spartanburg, SC

and the Contractor:  
*(Name, legal status, address and other information)*

for the following Project:  
*(Name, location and detailed description)*

Spartanburg School District Seven Multiple School Roof Repair

Base Bid scope of work includes miscellaneous selective roof repairs of the low slope roof areas at multiple schools as designated on the drawings. All new sheet metal items associated with the installation of the new repair work are required.

Alternate No. 1 scope of work includes roof membrane repair work at McCracken Middle School on Roof Areas U, U1, U2 and V. All other requirements remain unchanged.

The Architect:  
*(Name, legal status, address and other information)*

WM Building Envelope Consultants, LLC  
1501 Chapin Road  
Chapin, SC 29036

The Owner and Contractor agree as follows.

**ADDITIONS AND DELETIONS:**

The author of this document has added information needed for its completion. The author may also have revised the text of the original AIA standard form. An *Additions and Deletions Report* that notes added information as well as revisions to the standard form text is available from the author and should be reviewed. A vertical line in the left margin of this document indicates where the author has added necessary information and where the author has added to or deleted from the original AIA text.

This document has important legal consequences. Consultation with an attorney is encouraged with respect to its completion or modification.

The parties should complete A101®–2017, Exhibit A, Insurance and Bonds, contemporaneously with this Agreement. AIA Document A201®–2017, General Conditions of the Contract for Construction, is adopted in this document by reference. Do not use with other general conditions unless this document is modified.

Init.

**AIA Document A101® – 2017.** Copyright © 1915, 1918, 1925, 1937, 1951, 1958, 1961, 1963, 1967, 1974, 1977, 1987, 1991, 1997, 2007 and 2017 by The American Institute of Architects. All rights reserved. The "American Institute of Architects," "AIA," the AIA Logo, "A101," and "AIA Contract Documents" are registered trademarks and may not be used without permission. This document was produced by AIA software at 11:53:28 ET on 03/26/2021 under Order No.0053318563 which expires on 09/28/2021, is not for resale, is licensed for one-time use only, and may only be used in accordance with the AIA Contract Documents® Terms of Service. To report copyright violations, e-mail [copyright@aia.org](mailto:copyright@aia.org).

**User Notes:**

(3B9ADA3B)

## TABLE OF ARTICLES

- 1 THE CONTRACT DOCUMENTS
- 2 THE WORK OF THIS CONTRACT
- 3 DATE OF COMMENCEMENT AND SUBSTANTIAL COMPLETION
- 4 CONTRACT SUM
- 5 PAYMENTS
- 6 DISPUTE RESOLUTION
- 7 TERMINATION OR SUSPENSION
- 8 MISCELLANEOUS PROVISIONS
- 9 ENUMERATION OF CONTRACT DOCUMENTS

### EXHIBIT A INSURANCE AND BONDS

#### ARTICLE 1 THE CONTRACT DOCUMENTS

The Contract Documents consist of this Agreement, Conditions of the Contract (General, Supplementary, and other Conditions), Drawings, Specifications, Addenda issued prior to execution of this Agreement, other documents listed in this Agreement, and Modifications issued after execution of this Agreement, all of which form the Contract, and are as fully a part of the Contract as if attached to this Agreement or repeated herein. The Contract represents the entire and integrated agreement between the parties hereto and supersedes prior negotiations, representations, or agreements, either written or oral. An enumeration of the Contract Documents, other than a Modification, appears in Article 9.

#### ARTICLE 2 THE WORK OF THIS CONTRACT

The Contractor shall fully execute the Work described in the Contract Documents, except as specifically indicated in the Contract Documents to be the responsibility of others.

#### ARTICLE 3 DATE OF COMMENCEMENT AND SUBSTANTIAL COMPLETION

§ 3.1 The date of commencement of the Work shall be:

*(Check one of the following boxes.)*

The date of this Agreement.

A date set forth in a notice to proceed issued by the Owner.

Established as follows:

*(Insert a date or a means to determine the date of commencement of the Work.)*

If a date of commencement of the Work is not selected, then the date of commencement shall be the date of this Agreement.

§ 3.2 The Contract Time shall be measured from the date of commencement of the Work.

#### § 3.3 Substantial Completion

§ 3.3.1 Subject to adjustments of the Contract Time as provided in the Contract Documents, the Contractor shall achieve Substantial Completion of the entire Work:

Init.

AIA Document A101® – 2017. Copyright © 1915, 1918, 1925, 1937, 1951, 1958, 1961, 1963, 1967, 1974, 1977, 1987, 1991, 1997, 2007 and 2017 by The American Institute of Architects. All rights reserved. The "American Institute of Architects," "AIA," the AIA Logo, "A101," and "AIA Contract Documents" are registered trademarks and may not be used without permission. This document was produced by AIA software at 11:53:28 ET on 03/26/2021 under Order No.0053318563 which expires on 09/28/2021, is not for resale, is licensed for one-time use only, and may only be used in accordance with the AIA Contract Documents® Terms of Service. To report copyright violations, e-mail [copyright@aia.org](mailto:copyright@aia.org).  
User Notes:

(3B9ADA3B)

(Check one of the following boxes and complete the necessary information.)

Not later than ( ) calendar days from the date of commencement of the Work.

By the following date:

§ 3.3.2 Subject to adjustments of the Contract Time as provided in the Contract Documents, if portions of the Work are to be completed prior to Substantial Completion of the entire Work, the Contractor shall achieve Substantial Completion of such portions by the following dates:

Portion of Work	Substantial Completion Date
-----------------	-----------------------------

§ 3.3.3 If the Contractor fails to achieve Substantial Completion as provided in this Section 3.3, liquidated damages, if any, shall be assessed as set forth in Section 4.5.

**ARTICLE 4 CONTRACT SUM**

§ 4.1 The Owner shall pay the Contractor the Contract Sum in current funds for the Contractor’s performance of the Contract. The Contract Sum shall be (\$ ), subject to additions and deductions as provided in the Contract Documents.

**§ 4.2 Alternates**

§ 4.2.1 Alternates, if any, included in the Contract Sum:

Item	Price
Alternate No.1	

§ 4.2.2 Subject to the conditions noted below, the following alternates may be accepted by the Owner following execution of this Agreement. Upon acceptance, the Owner shall issue a Modification to this Agreement. (Insert below each alternate and the conditions that must be met for the Owner to accept the alternate.)

Item	Price	Conditions for Acceptance
None	N/A	None

§ 4.3 Allowances, if any, included in the Contract Sum: (Identify each allowance.)

Item	Price
General Lump Sum	\$1,500.00

§ 4.4 Unit prices, if any: (Identify the item and state the unit price and quantity limitations, if any, to which the unit price will be applicable.)

Item	Units and Limitations	Price per Unit (\$0.00)
Roof Membrane Repair	100 SQ.FT.	
Base Flashing Repair	20 L.F.	
VTR Repair	4 EACH	
Roof Drain Repair	8 EACH	
Roof Drain Replacement	4 EACH	
Pitch Pan Repair	EACH	

§ 4.5 Liquidated damages, if any: (Insert terms and conditions for liquidated damages, if any.)

\$300.00

§ 4.6 Other:

Init.

*(Insert provisions for bonus or other incentives, if any, that might result in a change to the Contract Sum.)*

None

## **ARTICLE 5 PAYMENTS**

### **§ 5.1 Progress Payments**

**§ 5.1.1** Based upon Applications for Payment submitted to the Architect by the Contractor and Certificates for Payment issued by the Architect, the Owner shall make progress payments on account of the Contract Sum to the Contractor as provided below and elsewhere in the Contract Documents.

**§ 5.1.2** The period covered by each Application for Payment shall be one calendar month ending on the last day of the month, or as follows:

**§ 5.1.3** Provided that an Application for Payment is received by the Architect not later than the last day of a month, the Owner shall make payment of the amount certified to the Contractor not later than the last day of the following month. If an Application for Payment is received by the Architect after the application date fixed above, payment of the amount certified shall be made by the Owner not later than thirty ( 30 ) days after the Architect receives the Application for Payment.

*(Federal, state or local laws may require payment within a certain period of time.)*

**§ 5.1.4** Each Application for Payment shall be based on the most recent schedule of values submitted by the Contractor in accordance with the Contract Documents. The schedule of values shall allocate the entire Contract Sum among the various portions of the Work. The schedule of values shall be prepared in such form, and supported by such data to substantiate its accuracy, as the Architect may require. This schedule of values shall be used as a basis for reviewing the Contractor's Applications for Payment.

**§ 5.1.5** Applications for Payment shall show the percentage of completion of each portion of the Work as of the end of the period covered by the Application for Payment.

**§ 5.1.6** In accordance with AIA Document A201™–2017, General Conditions of the Contract for Construction, and subject to other provisions of the Contract Documents, the amount of each progress payment shall be computed as follows:

**§ 5.1.6.1** The amount of each progress payment shall first include:

- .1 That portion of the Contract Sum properly allocable to completed Work;
- .2 That portion of the Contract Sum properly allocable to materials and equipment delivered and suitably stored at the site for subsequent incorporation in the completed construction, or, if approved in advance by the Owner, suitably stored off the site at a location agreed upon in writing; and
- .3 That portion of Construction Change Directives that the Architect determines, in the Architect's professional judgment, to be reasonably justified.

**§ 5.1.6.2** The amount of each progress payment shall then be reduced by:

- .1 The aggregate of any amounts previously paid by the Owner;
- .2 The amount, if any, for Work that remains uncorrected and for which the Architect has previously withheld a Certificate for Payment as provided in Article 9 of AIA Document A201–2017;
- .3 Any amount for which the Contractor does not intend to pay a Subcontractor or material supplier, unless the Work has been performed by others the Contractor intends to pay;
- .4 For Work performed or defects discovered since the last payment application, any amount for which the Architect may withhold payment, or nullify a Certificate of Payment in whole or in part, as provided in Article 9 of AIA Document A201–2017; and
- .5 Retainage withheld pursuant to Section 5.1.7.

### **§ 5.1.7 Retainage**

**§ 5.1.7.1** For each progress payment made prior to Substantial Completion of the Work, the Owner may withhold the following amount, as retainage, from the payment otherwise due:

Init.

**AIA Document A101® – 2017.** Copyright © 1915, 1918, 1925, 1937, 1951, 1958, 1961, 1963, 1967, 1974, 1977, 1987, 1991, 1997, 2007 and 2017 by The American Institute of Architects. All rights reserved. The "American Institute of Architects," "AIA," the AIA Logo, "A101," and "AIA Contract Documents" are registered trademarks and may not be used without permission. This document was produced by AIA software at 11:53:28 ET on 03/26/2021 under Order No.0053318563 which expires on 09/28/2021, is not for resale, is licensed for one-time use only, and may only be used in accordance with the AIA Contract Documents® Terms of Service. To report copyright violations, e-mail [copyright@aia.org](mailto:copyright@aia.org).

**User Notes:**

(3B9ADA3B)

*(Insert a percentage or amount to be withheld as retainage from each Application for Payment. The amount of retainage may be limited by governing law.)*

3.5%

**§ 5.1.7.1.1** The following items are not subject to retainage:

*(Insert any items not subject to the withholding of retainage, such as general conditions, insurance, etc.)*

None

**§ 5.1.7.2** Reduction or limitation of retainage, if any, shall be as follows:

*(If the retainage established in Section 5.1.7.1 is to be modified prior to Substantial Completion of the entire Work, including modifications for Substantial Completion of portions of the Work as provided in Section 3.3.2, insert provisions for such modifications.)*

None

**§ 5.1.7.3** Except as set forth in this Section 5.1.7.3, upon Substantial Completion of the Work, the Contractor may submit an Application for Payment that includes the retainage withheld from prior Applications for Payment pursuant to this Section 5.1.7. The Application for Payment submitted at Substantial Completion shall not include retainage as follows:

*(Insert any other conditions for release of retainage upon Substantial Completion.)*

None

**§ 5.1.8** If final completion of the Work is materially delayed through no fault of the Contractor, the Owner shall pay the Contractor any additional amounts in accordance with Article 9 of AIA Document A201–2017.

**§ 5.1.9** Except with the Owner's prior approval, the Contractor shall not make advance payments to suppliers for materials or equipment which have not been delivered and stored at the site.

## **§ 5.2 Final Payment**

**§ 5.2.1** Final payment, constituting the entire unpaid balance of the Contract Sum, shall be made by the Owner to the Contractor when

- .1 the Contractor has fully performed the Contract except for the Contractor's responsibility to correct Work as provided in Article 12 of AIA Document A201–2017, and to satisfy other requirements, if any, which extend beyond final payment; and
- .2 a final Certificate for Payment has been issued by the Architect.

**§ 5.2.2** The Owner's final payment to the Contractor shall be made no later than 30 days after the issuance of the Architect's final Certificate for Payment, or as follows:

Owner

## **§ 5.3 Interest**

Payments due and unpaid under the Contract shall bear interest from the date payment is due at the rate stated below, or in the absence thereof, at the legal rate prevailing from time to time at the place where the Project is located.

*(Insert rate of interest agreed upon, if any.)*

None % None

## **ARTICLE 6 DISPUTE RESOLUTION**

### **§ 6.1 Initial Decision Maker**

The Architect will serve as the Initial Decision Maker pursuant to Article 15 of AIA Document A201–2017, unless the parties appoint below another individual, not a party to this Agreement, to serve as the Initial Decision Maker.

Init.

*(If the parties mutually agree, insert the name, address and other contact information of the Initial Decision Maker, if other than the Architect.)*

### **§ 6.2 Binding Dispute Resolution**

For any Claim subject to, but not resolved by, mediation pursuant to Article 15 of AIA Document A201–2017, the method of binding dispute resolution shall be as follows:

*(Check the appropriate box.)*

Arbitration pursuant to Section 15.4 of AIA Document A201–2017

Litigation in a court of competent jurisdiction

Other *(Specify)*

If the Owner and Contractor do not select a method of binding dispute resolution, or do not subsequently agree in writing to a binding dispute resolution method other than litigation, Claims will be resolved by litigation in a court of competent jurisdiction.

### **ARTICLE 7 TERMINATION OR SUSPENSION**

**§ 7.1** The Contract may be terminated by the Owner or the Contractor as provided in Article 14 of AIA Document A201–2017.

**§ 7.1.1** If the Contract is terminated for the Owner’s convenience in accordance with Article 14 of AIA Document A201–2017, then the Owner shall pay the Contractor a termination fee as follows:

*(Insert the amount of, or method for determining, the fee, if any, payable to the Contractor following a termination for the Owner’s convenience.)*

**§ 7.2** The Work may be suspended by the Owner as provided in Article 14 of AIA Document A201–2017.

### **ARTICLE 8 MISCELLANEOUS PROVISIONS**

**§ 8.1** Where reference is made in this Agreement to a provision of AIA Document A201–2017 or another Contract Document, the reference refers to that provision as amended or supplemented by other provisions of the Contract Documents.

**§ 8.2** The Owner’s representative:

*(Name, address, email address, and other information)*

Terry Gilmer  
610 Dupre Drive, Spartanburg, SC 29307  
TGilmer@spart7.org

**§ 8.3** The Contractor’s representative:

*(Name, address, email address, and other information)*

Init.



§ 8.4 Neither the Owner's nor the Contractor's representative shall be changed without ten days' prior notice to the other party.

**§ 8.5 Insurance and Bonds**

§ 8.5.1 The Owner and the Contractor shall purchase and maintain insurance as set forth in AIA Document A101™–2017, Standard Form of Agreement Between Owner and Contractor where the basis of payment is a Stipulated Sum, Exhibit A, Insurance and Bonds, and elsewhere in the Contract Documents.

§ 8.5.2 The Contractor shall provide bonds as set forth in AIA Document A101™–2017 Exhibit A, and elsewhere in the Contract Documents.

§ 8.6 Notice in electronic format, pursuant to Article 1 of AIA Document A201–2017, may be given in accordance with AIA Document E203™–2013, Building Information Modeling and Digital Data Exhibit, if completed, or as otherwise set forth below:

*(If other than in accordance with AIA Document E203–2013, insert requirements for delivering notice in electronic format such as name, title, and email address of the recipient and whether and how the system will be required to generate a read receipt for the transmission.)*

N/A

§ 8.7 Other provisions:

None

**ARTICLE 9 ENUMERATION OF CONTRACT DOCUMENTS**

§ 9.1 This Agreement is comprised of the following documents:

- .1 AIA Document A101™–2017, Standard Form of Agreement Between Owner and Contractor
- .2 AIA Document A101™–2017, Exhibit A, Insurance and Bonds
- .3 AIA Document A201™–2017, General Conditions of the Contract for Construction
- .4 AIA Document E203™–2013, Building Information Modeling and Digital Data Exhibit, dated as indicated below:  
*(Insert the date of the E203-2013 incorporated into this Agreement.)*

.5 Drawings

Number	Title	Date
--------	-------	------

.6 Specifications

Section	Title	Date	Pages
---------	-------	------	-------

.7 Addenda, if any:

Number	Date	Pages
--------	------	-------

Portions of Addenda relating to bidding or proposal requirements are not part of the Contract

Init.

Documents unless the bidding or proposal requirements are also enumerated in this Article 9.

**.8 Other Exhibits:**

*(Check all boxes that apply and include appropriate information identifying the exhibit where required.)*

AIA Document E204™–2017, Sustainable Projects Exhibit, dated as indicated below:  
(Insert the date of the E204-2017 incorporated into this Agreement.)

The Sustainability Plan:

Title	Date	Pages
-------	------	-------

Supplementary and other Conditions of the Contract:

Document	Title	Date	Pages
----------	-------	------	-------

**.9 Other documents, if any, listed below:**

*(List here any additional documents that are intended to form part of the Contract Documents. AIA Document A201™–2017 provides that the advertisement or invitation to bid, Instructions to Bidders, sample forms, the Contractor's bid or proposal, portions of Addenda relating to bidding or proposal requirements, and other information furnished by the Owner in anticipation of receiving bids or proposals, are not part of the Contract Documents unless enumerated in this Agreement. Any such documents should be listed here only if intended to be part of the Contract Documents.)*

This Agreement entered into as of the day and year first written above.

\_\_\_\_\_  
**OWNER** *(Signature)*

\_\_\_\_\_  
*(Printed name and title)*

\_\_\_\_\_  
**CONTRACTOR** *(Signature)*

\_\_\_\_\_  
*(Printed name and title)*



# AIA® Document A201® – 2017

## General Conditions of the Contract for Construction

### for the following PROJECT:

*(Name and location or address)*

Spartanburg School District Seven Multiple School Roof Repair  
Carver Middle School - 467 South Church Street, Spartanburg, SC 29306  
Jesse Boyd Elementary School - 1505 Fernwood Glendale Road, Spartanburg, SC 29307  
McCracken Middle School - 50 Emory Road, Spartanburg SC 29307

### THE OWNER:

*(Name, legal status and address)*

Spartanburg School District Seven  
610 Dupre Drive, SC 29307

### THE ARCHITECT:

*(Name, legal status and address)*

WM Building Envelope Consultants, LLC  
1501 Chapin Road, Chapin, SC 29036

### TABLE OF ARTICLES

- 1 GENERAL PROVISIONS
- 2 OWNER
- 3 CONTRACTOR
- 4 ARCHITECT
- 5 SUBCONTRACTORS
- 6 CONSTRUCTION BY OWNER OR BY SEPARATE CONTRACTORS
- 7 CHANGES IN THE WORK
- 8 TIME
- 9 PAYMENTS AND COMPLETION
- 10 PROTECTION OF PERSONS AND PROPERTY
- 11 INSURANCE AND BONDS
- 12 UNCOVERING AND CORRECTION OF WORK
- 13 MISCELLANEOUS PROVISIONS
- 14 TERMINATION OR SUSPENSION OF THE CONTRACT

### ADDITIONS AND DELETIONS:

The author of this document has added information needed for its completion. The author may also have revised the text of the original AIA standard form. An *Additions and Deletions Report* that notes added information as well as revisions to the standard form text is available from the author and should be reviewed. A vertical line in the left margin of this document indicates where the author has added necessary information and where the author has added to or deleted from the original AIA text.

This document has important legal consequences. Consultation with an attorney is encouraged with respect to its completion or modification.

For guidance in modifying this document to include supplementary conditions, see AIA Document A503™, Guide for Supplementary Conditions.

Init.

User Notes:

(3B9ADA38)



Init.

/

## INDEX

(Topics and numbers in bold are Section headings.)

### Acceptance of Nonconforming Work

9.6.6, 9.9.3, 12.3

### Acceptance of Work

9.6.6, 9.8.2, 9.9.3, 9.10.1, 9.10.3, 12.3

### Access to Work

3.16, 6.2.1, 12.1

### Accident Prevention

10

### Acts and Omissions

3.2, 3.3.2, 3.12.8, 3.18, 4.2.3, 8.3.1, 9.5.1, 10.2.5, 10.2.8, 13.3.2, 14.1, 15.1.2, 15.2

### Addenda

1.1.1

### Additional Costs, Claims for

3.7.4, 3.7.5, 10.3.2, 15.1.5

### Additional Inspections and Testing

9.4.2, 9.8.3, 12.2.1, 13.4

### Additional Time, Claims for

3.2.4, 3.7.4, 3.7.5, 3.10.2, 8.3.2, 15.1.6

### Administration of the Contract

3.1.3, 4.2, 9.4, 9.5

### Advertisement or Invitation to Bid

1.1.1

### Aesthetic Effect

4.2.13

### Allowances

3.8

### Applications for Payment

4.2.5, 7.3.9, 9.2, 9.3, 9.4, 9.5.1, 9.5.4, 9.6.3, 9.7, 9.10

### Approvals

2.1.1, 2.3.1, 2.5, 3.1.3, 3.10.2, 3.12.8, 3.12.9, 3.12.10.1, 4.2.7, 9.3.2, 13.4.1

### Arbitration

8.3.1, 15.3.2, 15.4

### ARCHITECT

4

### Architect, Definition of

4.1.1

### Architect, Extent of Authority

2.5, 3.12.7, 4.1.2, 4.2, 5.2, 6.3, 7.1.2, 7.3.4, 7.4, 9.2, 9.3.1, 9.4, 9.5, 9.6.3, 9.8, 9.10.1, 9.10.3, 12.1, 12.2.1, 13.4.1, 13.4.2, 14.2.2, 14.2.4, 15.1.4, 15.2.1

### Architect, Limitations of Authority and Responsibility

2.1.1, 3.12.4, 3.12.8, 3.12.10, 4.1.2, 4.2.1, 4.2.2, 4.2.3, 4.2.6, 4.2.7, 4.2.10, 4.2.12, 4.2.13, 5.2.1, 7.4, 9.4.2, 9.5.4, 9.6.4, 15.1.4, 15.2

### Architect's Additional Services and Expenses

2.5, 12.2.1, 13.4.2, 13.4.3, 14.2.4

### Architect's Administration of the Contract

3.1.3, 3.7.4, 15.2, 9.4.1, 9.5

### Architect's Approvals

2.5, 3.1.3, 3.5, 3.10.2, 4.2.7

### Architect's Authority to Reject Work

3.5, 4.2.6, 12.1.2, 12.2.1

### Architect's Copyright

1.1.7, 1.5

### Architect's Decisions

3.7.4, 4.2.6, 4.2.7, 4.2.11, 4.2.12, 4.2.13, 4.2.14, 6.3, 7.3.4, 7.3.9, 8.1.3, 8.3.1, 9.2, 9.4.1, 9.5, 9.8.4, 9.9.1, 13.4.2, 15.2

### Architect's Inspections

3.7.4, 4.2.2, 4.2.9, 9.4.2, 9.8.3, 9.9.2, 9.10.1, 13.4

### Architect's Instructions

3.2.4, 3.3.1, 4.2.6, 4.2.7, 13.4.2

### Architect's Interpretations

4.2.11, 4.2.12

### Architect's Project Representative

4.2.10

### Architect's Relationship with Contractor

1.1.2, 1.5, 2.3.3, 3.1.3, 3.2.2, 3.2.3, 3.2.4, 3.3.1, 3.4.2, 3.5, 3.7.4, 3.7.5, 3.9.2, 3.9.3, 3.10, 3.11, 3.12, 3.16, 3.18, 4.1.2, 4.2, 5.2, 6.2.2, 7, 8.3.1, 9.2, 9.3, 9.4, 9.5, 9.7, 9.8, 9.9, 10.2.6, 10.3, 11.3, 12, 13.3.2, 13.4, 15.2

### Architect's Relationship with Subcontractors

1.1.2, 4.2.3, 4.2.4, 4.2.6, 9.6.3, 9.6.4, 11.3

### Architect's Representations

9.4.2, 9.5.1, 9.10.1

### Architect's Site Visits

3.7.4, 4.2.2, 4.2.9, 9.4.2, 9.5.1, 9.9.2, 9.10.1, 13.4

### Asbestos

10.3.1

### Attorneys' Fees

3.18.1, 9.6.8, 9.10.2, 10.3.3

### Award of Separate Contracts

6.1.1, 6.1.2

### Award of Subcontracts and Other Contracts for Portions of the Work

5.2

### Basic Definitions

1.1

### Bidding Requirements

1.1.1

### Binding Dispute Resolution

8.3.1, 9.7, 11.5, 13.1, 15.1.2, 15.1.3, 15.2.1, 15.2.5, 15.2.6.1, 15.3.1, 15.3.2, 15.3.3, 15.4.1

### Bonds, Lien

7.3.4.4, 9.6.8, 9.10.2, 9.10.3

### Bonds, Performance, and Payment

7.3.4.4, 9.6.7, 9.10.3, 11.1.2, 11.1.3, 11.5

### Building Information Models Use and Reliance

1.8

### Building Permit

3.7.1

### Capitalization

1.3

### Certificate of Substantial Completion

9.8.3, 9.8.4, 9.8.5

Init.

**AIA Document A201® – 2017.** Copyright © 1911, 1915, 1918, 1925, 1937, 1951, 1958, 1961, 1963, 1966, 1970, 1976, 1987, 1997, 2007 and 2017 by The American Institute of Architects. All rights reserved. **The "American Institute of Architects," "AIA," the AIA Logo, "A201," and "AIA Contract Documents" are registered trademarks and may not be used without permission.** This document was produced by AIA software at 11:53:06 ET on 03/26/2021 under Order No.0053318563 which expires on 09/28/2021, is not for resale, is licensed for one-time use only, and may only be used in accordance with the AIA Contract Documents® Terms of Service. To report copyright violations, e-mail [copyright@aia.org](mailto:copyright@aia.org).  
**User Notes:**

(3B9ADA38)

Certificates for Payment  
4.2.1, 4.2.5, 4.2.9, 9.3.3, 9.4, 9.5, 9.6.1, 9.6.6, 9.7,  
9.10.1, 9.10.3, 14.1.1.3, 14.2.4, 15.1.4  
Certificates of Inspection, Testing or Approval  
13.4.4  
Certificates of Insurance  
9.10.2  
Change Orders  
1.1.1, 3.4.2, 3.7.4, 3.8.2.3, 3.11, 3.12.8, 4.2.8, 5.2.3,  
7.1.2, 7.1.3, 7.2, 7.3.2, 7.3.7, 7.3.9, 7.3.10, 8.3.1,  
9.3.1.1, 9.10.3, 10.3.2, 11.2, 11.5, 12.1.2  
Change Orders, Definition of  
7.2.1  
CHANGES IN THE WORK  
2.2.2, 3.11, 4.2.8, 7, 7.2.1, 7.3.1, 7.4, 8.3.1, 9.3.1.1,  
11.5  
Claims, Definition of  
15.1.1  
Claims, Notice of  
1.6.2, 15.1.3  
CLAIMS AND DISPUTES  
3.2.4, 6.1.1, 6.3, 7.3.9, 9.3.3, 9.10.4, 10.3.3, 15, 15.4  
Claims and Timely Assertion of Claims  
15.4.1  
Claims for Additional Cost  
3.2.4, 3.3.1, 3.7.4, 7.3.9, 9.5.2, 10.2.5, 10.3.2, 15.1.5  
Claims for Additional Time  
3.2.4, 3.3.1, 3.7.4, 6.1.1, 8.3.2, 9.5.2, 10.3.2, 15.1.6  
Concealed or Unknown Conditions, Claims for  
3.7.4  
Claims for Damages  
3.2.4, 3.18, 8.3.3, 9.5.1, 9.6.7, 10.2.5, 10.3.3, 11.3,  
11.3.2, 14.2.4, 15.1.7  
Claims Subject to Arbitration  
15.4.1  
Cleaning Up  
3.15, 6.3  
Commencement of the Work, Conditions Relating to  
2.2.1, 3.2.2, 3.4.1, 3.7.1, 3.10.1, 3.12.6, 5.2.1, 5.2.3,  
6.2.2, 8.1.2, 8.2.2, 8.3.1, 11.1, 11.2, 15.1.5  
Commencement of the Work, Definition of  
8.1.2  
Communications  
3.9.1, 4.2.4  
Completion, Conditions Relating to  
3.4.1, 3.11, 3.15, 4.2.2, 4.2.9, 8.2, 9.4.2, 9.8, 9.9.1,  
9.10, 12.2, 14.1.2, 15.1.2  
COMPLETION, PAYMENTS AND  
9  
Completion, Substantial  
3.10.1, 4.2.9, 8.1.1, 8.1.3, 8.2.3, 9.4.2, 9.8, 9.9.1,  
9.10.3, 12.2, 15.1.2  
Compliance with Laws  
2.3.2, 3.2.3, 3.6, 3.7, 3.12.10, 3.13, 9.6.4, 10.2.2,  
13.1, 13.3, 13.4.1, 13.4.2, 13.5, 14.1.1, 14.2.1.3,  
15.2.8, 15.4.2, 15.4.3  
Concealed or Unknown Conditions

3.7.4, 4.2.8, 8.3.1, 10.3  
Conditions of the Contract  
1.1.1, 6.1.1, 6.1.4  
Consent, Written  
3.4.2, 3.14.2, 4.1.2, 9.8.5, 9.9.1, 9.10.2, 9.10.3, 13.2,  
15.4.4.2  
Consolidation or Joinder  
15.4.4  
CONSTRUCTION BY OWNER OR BY  
SEPARATE CONTRACTORS  
1.1.4, 6  
Construction Change Directive, Definition of  
7.3.1  
Construction Change Directives  
1.1.1, 3.4.2, 3.11, 3.12.8, 4.2.8, 7.1.1, 7.1.2, 7.1.3,  
7.3, 9.3.1.1  
Construction Schedules, Contractor's  
3.10, 3.11, 3.12.1, 3.12.2, 6.1.3, 15.1.6.2  
Contingent Assignment of Subcontracts  
5.4, 14.2.2.2  
Continuing Contract Performance  
15.1.4  
Contract, Definition of  
1.1.2  
CONTRACT, TERMINATION OR SUSPENSION  
OF THE  
5.4.1.1, 5.4.2, 11.5, 14  
Contract Administration  
3.1.3, 4, 9.4, 9.5  
Contract Award and Execution, Conditions Relating  
to  
3.7.1, 3.10, 5.2, 6.1  
Contract Documents, Copies Furnished and Use of  
1.5.2, 2.3.6, 5.3  
Contract Documents, Definition of  
1.1.1  
Contract Sum  
2.2.2, 2.2.4, 3.7.4, 3.7.5, 3.8, 3.10.2, 5.2.3, 7.3, 7.4,  
9.1, 9.2, 9.4.2, 9.5.1.4, 9.6.7, 9.7, 10.3.2, 11.5, 12.1.2,  
12.3, 14.2.4, 14.3.2, 15.1.4.2, 15.1.5, 15.2.5  
Contract Sum, Definition of  
9.1  
Contract Time  
1.1.4, 2.2.1, 2.2.2, 3.7.4, 3.7.5, 3.10.2, 5.2.3, 6.1.5,  
7.2.1.3, 7.3.1, 7.3.5, 7.3.6, 7, 7, 7.3.10, 7.4, 8.1.1,  
8.2.1, 8.2.3, 8.3.1, 9.5.1, 9.7, 10.3.2, 12.1.1, 12.1.2,  
14.3.2, 15.1.4.2, 15.1.6.1, 15.2.5  
Contract Time, Definition of  
8.1.1  
CONTRACTOR  
3  
**Contractor**, Definition of  
3.1, 6.1.2  
Contractor's Construction and Submittal Schedules  
3.10, 3.12.1, 3.12.2, 4.2.3, 6.1.3, 15.1.6.2  
Contractor's Employees

2.2.4, 3.3.2, 3.4.3, 3.8.1, 3.9, 3.18.2, 4.2.3, 4.2.6,  
10.2, 10.3, 11.3, 14.1, 14.2.1.1  
Contractor's Liability Insurance  
11.1  
Contractor's Relationship with Separate Contractors  
and Owner's Forces  
3.12.5, 3.14.2, 4.2.4, 6, 11.3, 12.2.4  
Contractor's Relationship with Subcontractors  
1.2.2, 2.2.4, 3.3.2, 3.18.1, 3.18.2, 4.2.4, 5, 9.6.2,  
9.6.7, 9.10.2, 11.2, 11.3, 11.4  
Contractor's Relationship with the Architect  
1.1.2, 1.5, 2.3.3, 3.1.3, 3.2.2, 3.2.3, 3.2.4, 3.3.1, 3.4.2,  
3.5.1, 3.7.4, 3.10, 3.11, 3.12, 3.16, 3.18, 4.2, 5.2,  
6.2.2, 7, 8.3.1, 9.2, 9.3, 9.4, 9.5, 9.7, 9.8, 9.9, 10.2.6,  
10.3, 11.3, 12, 13.4, 15.1.3, 15.2.1  
Contractor's Representations  
3.2.1, 3.2.2, 3.5, 3.12.6, 6.2.2, 8.2.1, 9.3.3, 9.8.2  
Contractor's Responsibility for Those Performing the  
Work  
3.3.2, 3.18, 5.3, 6.1.3, 6.2, 9.5.1, 10.2.8  
Contractor's Review of Contract Documents  
3.2  
Contractor's Right to Stop the Work  
2.2.2, 9.7  
Contractor's Right to Terminate the Contract  
14.1  
Contractor's Submittals  
3.10, 3.11, 3.12, 4.2.7, 5.2.1, 5.2.3, 9.2, 9.3, 9.8.2,  
9.8.3, 9.9.1, 9.10.2, 9.10.3  
Contractor's Superintendent  
3.9, 10.2.6  
Contractor's Supervision and Construction  
Procedures  
1.2.2, 3.3, 3.4, 3.12.10, 4.2.2, 4.2.7, 6.1.3, 6.2.4,  
7.1.3, 7.3.4, 7.3.6, 8.2, 10, 12, 14, 15.1.4  
Coordination and Correlation  
1.2, 3.2.1, 3.3.1, 3.10, 3.12.6, 6.1.3, 6.2.1  
Copies Furnished of Drawings and Specifications  
1.5, 2.3.6, 3.11  
Copyrights  
1.5, 3.17  
Correction of Work  
2.5, 3.7.3, 9.4.2, 9.8.2, 9.8.3, 9.9.1, 12.1.2, 12.2, 12.3,  
15.1.3.1, 15.1.3.2, 15.2.1  
Correlation and Intent of the Contract Documents  
1.2  
Cost, Definition of  
7.3.4  
Costs  
2.5, 3.2.4, 3.7.3, 3.8.2, 3.15.2, 5.4.2, 6.1.1, 6.2.3,  
7.3.3.3, 7.3.4, 7.3.8, 7.3.9, 9.10.2, 10.3.2, 10.3.6,  
11.2, 12.1.2, 12.2.1, 12.2.4, 13.4, 14  
Cutting and Patching  
3.14, 6.2.5  
Damage to Construction of Owner or Separate  
Contractors  
3.14.2, 6.2.4, 10.2.1.2, 10.2.5, 10.4, 12.2.4

Damage to the Work  
3.14.2, 9.9.1, 10.2.1.2, 10.2.5, 10.4, 12.2.4  
Damages, Claims for  
3.2.4, 3.18, 6.1.1, 8.3.3, 9.5.1, 9.6.7, 10.3.3, 11.3.2,  
11.3, 14.2.4, 15.1.7  
Damages for Delay  
6.2.3, 8.3.3, 9.5.1.6, 9.7, 10.3.2, 14.3.2  
Date of Commencement of the Work, Definition of  
8.1.2  
Date of Substantial Completion, Definition of  
8.1.3  
Day, Definition of  
8.1.4  
Decisions of the Architect  
3.7.4, 4.2.6, 4.2.7, 4.2.11, 4.2.12, 4.2.13, 6.3, 7.3.4,  
7.3.9, 8.1.3, 8.3.1, 9.2, 9.4, 9.5.1, 9.8.4, 9.9.1, 13.4.2,  
14.2.2, 14.2.4, 15.1, 15.2  
Decisions to Withhold Certification  
9.4.1, 9.5, 9.7, 14.1.1.3  
Defective or Nonconforming Work, Acceptance,  
Rejection and Correction of  
2.5, 3.5, 4.2.6, 6.2.3, 9.5.1, 9.5.3, 9.6.6, 9.8.2, 9.9.3,  
9.10.4, 12.2.1  
Definitions  
1.1, 2.1.1, 3.1.1, 3.5, 3.12.1, 3.12.2, 3.12.3, 4.1.1, 5.1,  
6.1.2, 7.2.1, 7.3.1, 8.1, 9.1, 9.8.1, 15.1.1  
Delays and Extensions of Time  
3.2, 3.7.4, 5.2.3, 7.2.1, 7.3.1, 7.4, 8.3, 9.5.1, 9.7,  
10.3.2, 10.4, 14.3.2, 15.1.6, 15.2.5  
Digital Data Use and Transmission  
1.7  
Disputes  
6.3, 7.3.9, 15.1, 15.2  
Documents and Samples at the Site  
3.11  
Drawings, Definition of  
1.1.5  
Drawings and Specifications, Use and Ownership of  
3.11  
Effective Date of Insurance  
8.2.2  
Emergencies  
10.4, 14.1.1.2, 15.1.5  
Employees, Contractor's  
3.3.2, 3.4.3, 3.8.1, 3.9, 3.18.2, 4.2.3, 4.2.6, 10.2,  
10.3.3, 11.3, 14.1, 14.2.1.1  
Equipment, Labor, or Materials  
1.1.3, 1.1.6, 3.4, 3.5, 3.8.2, 3.8.3, 3.12, 3.13, 3.15.1,  
4.2.6, 4.2.7, 5.2.1, 6.2.1, 7.3.4, 9.3.2, 9.3.3, 9.5.1.3,  
9.10.2, 10.2.1, 10.2.4, 14.2.1.1, 14.2.1.2  
Execution and Progress of the Work  
1.1.3, 1.2.1, 1.2.2, 2.3.4, 2.3.6, 3.1, 3.3.1, 3.4.1, 3.7.1,  
3.10.1, 3.12, 3.14, 4.2, 6.2.2, 7.1.3, 7.3.6, 8.2, 9.5.1,  
9.9.1, 10.2, 10.3, 12.1, 12.2, 14.2, 14.3.1, 15.1.4  
Extensions of Time  
3.2.4, 3.7.4, 5.2.3, 7.2.1, 7.3, 7.4, 9.5.1, 9.7, 10.3.2,  
10.4, 14.3, 15.1.6, 15.2.5



Failure of Payment  
 9.5.1.3, 9.7, 9.10.2, 13.5, 14.1.1.3, 14.2.1.2  
 Faulty Work  
 (See Defective or Nonconforming Work)  
 Final Completion and Final Payment  
 4.2.1, 4.2.9, 9.8.2, 9.10, 12.3, 14.2.4, 14.4.3  
 Financial Arrangements, Owner's  
 2.2.1, 13.2.2, 14.1.1.4  
**GENERAL PROVISIONS**  
 1  
 Governing Law  
 13.1  
 Guarantees (See Warranty)  
 Hazardous Materials and Substances  
 10.2.4, 10.3  
 Identification of Subcontractors and Suppliers  
 5.2.1  
 Indemnification  
 3.17, 3.18, 9.6.8, 9.10.2, 10.3.3, 11.3  
 Information and Services Required of the Owner  
 2.1.2, 2.2, 2.3, 3.2.2, 3.12.10.1, 6.1.3, 6.1.4, 6.2.5,  
 9.6.1, 9.9.2, 9.10.3, 10.3.3, 11.2, 13.4.1, 13.4.2,  
 14.1.1.4, 14.1.4, 15.1.4  
 Initial Decision  
 15.2  
 Initial Decision Maker, Definition of  
 1.1.8  
 Initial Decision Maker, Decisions  
 14.2.4, 15.1.4.2, 15.2.1, 15.2.2, 15.2.3, 15.2.4, 15.2.5  
 Initial Decision Maker, Extent of Authority  
 14.2.4, 15.1.4.2, 15.2.1, 15.2.2, 15.2.3, 15.2.4, 15.2.5  
 Injury or Damage to Person or Property  
 10.2.8, 10.4  
 Inspections  
 3.1.3, 3.3.3, 3.7.1, 4.2.2, 4.2.6, 4.2.9, 9.4.2, 9.8.3,  
 9.9.2, 9.10.1, 12.2.1, 13.4  
 Instructions to Bidders  
 1.1.1  
 Instructions to the Contractor  
 3.2.4, 3.3.1, 3.8.1, 5.2.1, 7, 8.2.2, 12, 13.4.2  
 Instruments of Service, Definition of  
 1.1.7  
 Insurance  
 6.1.1, 7.3.4, 8.2.2, 9.3.2, 9.8.4, 9.9.1, 9.10.2, 10.2.5,  
 11  
**Insurance, Notice of Cancellation or Expiration**  
**11.1.4, 11.2.3**  
 Insurance, Contractor's Liability  
 11.1  
 Insurance, Effective Date of  
 8.2.2, 14.4.2  
 Insurance, Owner's Liability  
 11.2  
 Insurance, Property  
 10.2.5, 11.2, 11.4, 11.5  
 Insurance, Stored Materials  
 9.3.2

**INSURANCE AND BONDS**  
 11  
 Insurance Companies, Consent to Partial Occupancy  
 9.9.1  
 Insured loss, Adjustment and Settlement of  
 11.5  
 Intent of the Contract Documents  
 1.2.1, 4.2.7, 4.2.12, 4.2.13  
 Interest  
 13.5  
 Interpretation  
 1.1.8, 1.2.3, 1.4, 4.1.1, 5.1, 6.1.2, 15.1.1  
 Interpretations, Written  
 4.2.11, 4.2.12  
 Judgment on Final Award  
 15.4.2  
 Labor and Materials, Equipment  
 1.1.3, 1.1.6, 3.4, 3.5, 3.8.2, 3.8.3, 3.12, 3.13, 3.15.1,  
 5.2.1, 6.2.1, 7.3.4, 9.3.2, 9.3.3, 9.5.1.3, 9.10.2, 10.2.1,  
 10.2.4, 14.2.1.1, 14.2.1.2  
 Labor Disputes  
 8.3.1  
 Laws and Regulations  
 1.5, 2.3.2, 3.2.3, 3.2.4, 3.6, 3.7, 3.12.10, 3.13, 9.6.4,  
 9.9.1, 10.2.2, 13.1, 13.3.1, 13.4.2, 13.5, 14, 15.2.8,  
 15.4  
 Liens  
 2.1.2, 9.3.1, 9.3.3, 9.6.8, 9.10.2, 9.10.4, 15.2.8  
 Limitations, Statutes of  
 12.2.5, 15.1.2, 15.4.1.1  
 Limitations of Liability  
 3.2.2, 3.5, 3.12.10, 3.12.10.1, 3.17, 3.18.1, 4.2.6,  
 4.2.7, 6.2.2, 9.4.2, 9.6.4, 9.6.7, 9.6.8, 10.2.5, 10.3.3,  
 11.3, 12.2.5, 13.3.1  
 Limitations of Time  
 2.1.2, 2.2, 2.5, 3.2.2, 3.10, 3.11, 3.12.5, 3.15.1, 4.2.7,  
 5.2, 5.3, 5.4.1, 6.2.4, 7.3, 7.4, 8.2, 9.2, 9.3.1, 9.3.3,  
 9.4.1, 9.5, 9.6, 9.7, 9.8, 9.9, 9.10, 12.2, 13.4, 14, 15,  
 15.1.2, 15.1.3, 15.1.5  
 Materials, Hazardous  
 10.2.4, 10.3  
 Materials, Labor, Equipment and  
 1.1.3, 1.1.6, 3.4.1, 3.5, 3.8.2, 3.8.3, 3.12, 3.13, 3.15.1,  
 5.2.1, 6.2.1, 7.3.4, 9.3.2, 9.3.3, 9.5.1.3, 9.10.2,  
 10.2.1.2, 10.2.4, 14.2.1.1, 14.2.1.2  
 Means, Methods, Techniques, Sequences and  
 Procedures of Construction  
 3.3.1, 3.12.10, 4.2.2, 4.2.7, 9.4.2  
 Mechanic's Lien  
 2.1.2, 9.3.1, 9.3.3, 9.6.8, 9.10.2, 9.10.4, 15.2.8  
 Mediation  
 8.3.1, 15.1.3.2, 15.2.1, 15.2.5, 15.2.6, 15.3, 15.4.1,  
 15.4.1.1  
 Minor Changes in the Work  
 1.1.1, 3.4.2, 3.12.8, 4.2.8, 7.1, 7.4  
**MISCELLANEOUS PROVISIONS**  
 13



Modifications, Definition of  
1.1.1  
Modifications to the Contract  
1.1.1, 1.1.2, 2.5, 3.11, 4.1.2, 4.2.1, 5.2.3, 7, 8.3.1, 9.7, 10.3.2  
Mutual Responsibility  
6.2  
Nonconforming Work, Acceptance of  
9.6.6, 9.9.3, 12.3  
Nonconforming Work, Rejection and Correction of  
2.4, 2.5, 3.5, 4.2.6, 6.2.4, 9.5.1, 9.8.2, 9.9.3, 9.10.4, 12.2  
Notice  
1.6, 1.6.1, 1.6.2, 2.1.2, 2.2.2., 2.2.3, 2.2.4, 2.5, 3.2.4, 3.3.1, 3.7.4, 3.7.5, 3.9.2, 3.12.9, 3.12.10, 5.2.1, 7.4, 8.2.2, 9.6.8, 9.7, 9.10.1, 10.2.8, 10.3.2, 11.5, 12.2.2.1, 13.4.1, 13.4.2, 14.1, 14.2.2, 14.4.2, 15.1.3, 15.1.5, 15.1.6, 15.4.1  
Notice of Cancellation or Expiration of Insurance  
11.1.4, 11.2.3  
Notice of Claims  
1.6.2, 2.1.2, 3.7.4, 9.6.8, 10.2.8, 15.1.3, 15.1.5, 15.1.6, 15.2.8, 15.3.2, 15.4.1  
Notice of Testing and Inspections  
13.4.1, 13.4.2  
Observations, Contractor's  
3.2, 3.7.4  
Occupancy  
2.3.1, 9.6.6, 9.8  
Orders, Written  
1.1.1, 2.4, 3.9.2, 7, 8.2.2, 11.5, 12.1, 12.2.2.1, 13.4.2, 14.3.1  
OWNER  
2  
Owner, Definition of  
2.1.1  
Owner, Evidence of Financial Arrangements  
2.2, 13.2.2, 14.1.1.4  
Owner, Information and Services Required of the  
2.1.2, 2.2, 2.3, 3.2.2, 3.12.10, 6.1.3, 6.1.4, 6.2.5, 9.3.2, 9.6.1, 9.6.4, 9.9.2, 9.10.3, 10.3.3, 11.2, 13.4.1, 13.4.2, 14.1.1.4, 14.1.4, 15.1.4  
Owner's Authority  
1.5, 2.1.1, 2.3.32.4, 2.5, 3.4.2, 3.8.1, 3.12.10, 3.14.2, 4.1.2, 4.2.4, 4.2.9, 5.2.1, 5.2.4, 5.4.1, 6.1, 6.3, 7.2.1, 7.3.1, 8.2.2, 8.3.1, 9.3.2, 9.5.1, 9.6.4, 9.9.1, 9.10.2, 10.3.2, 11.4, 11.5, 12.2.2, 12.3, 13.2.2, 14.3, 14.4, 15.2.7  
Owner's Insurance  
11.2  
Owner's Relationship with Subcontractors  
1.1.2, 5.2, 5.3, 5.4, 9.6.4, 9.10.2, 14.2.2  
Owner's Right to Carry Out the Work  
2.5, 14.2.2  
Owner's Right to Clean Up  
6.3  
Owner's Right to Perform Construction and to Award

Separate Contracts  
6.1  
Owner's Right to Stop the Work  
2.4  
Owner's Right to Suspend the Work  
14.3  
Owner's Right to Terminate the Contract  
14.2, 14.4  
Ownership and Use of Drawings, Specifications and Other Instruments of Service  
1.1.1, 1.1.6, 1.1.7, 1.5, 2.3.6, 3.2.2, 3.11, 3.17, 4.2.12, 5.3  
Partial Occupancy or Use  
9.6.6, 9.9  
Patching, Cutting and  
3.14, 6.2.5  
Patents  
3.17  
Payment, Applications for  
4.2.5, 7.3.9, 9.2, 9.3, 9.4, 9.5, 9.6.3, 9.7, 9.8.5, 9.10.1, 14.2.3, 14.2.4, 14.4.3  
Payment, Certificates for  
4.2.5, 4.2.9, 9.3.3, 9.4, 9.5, 9.6.1, 9.6.6, 9.7, 9.10.1, 9.10.3, 14.1.1.3, 14.2.4  
Payment, Failure of  
9.5.1.3, 9.7, 9.10.2, 13.5, 14.1.1.3, 14.2.1.2  
Payment, Final  
4.2.1, 4.2.9, 9.10, 12.3, 14.2.4, 14.4.3  
Payment Bond, Performance Bond and  
7.3.4.4, 9.6.7, 9.10.3, 11.1.2  
Payments, Progress  
9.3, 9.6, 9.8.5, 9.10.3, 14.2.3, 15.1.4  
PAYMENTS AND COMPLETION  
9  
Payments to Subcontractors  
5.4.2, 9.5.1.3, 9.6.2, 9.6.3, 9.6.4, 9.6.7, 14.2.1.2  
PCB  
10.3.1  
Performance Bond and Payment Bond  
7.3.4.4, 9.6.7, 9.10.3, 11.1.2  
Permits, Fees, Notices and Compliance with Laws  
2.3.1, 3.7, 3.13, 7.3.4.4, 10.2.2  
PERSONS AND PROPERTY, PROTECTION OF  
10  
Polychlorinated Biphenyl  
10.3.1  
Product Data, Definition of  
3.12.2  
Product Data and Samples, Shop Drawings  
3.11, 3.12, 4.2.7  
Progress and Completion  
4.2.2, 8.2, 9.8, 9.9.1, 14.1.4, 15.1.4  
Progress Payments  
9.3, 9.6, 9.8.5, 9.10.3, 14.2.3, 15.1.4  
Project, Definition of  
1.1.4  
Project Representatives

4.2.10  
 Property Insurance  
 10.2.5, 11.2  
 Proposal Requirements  
 1.1.1  
**PROTECTION OF PERSONS AND PROPERTY**  
 10  
 Regulations and Laws  
 1.5, 2.3.2, 3.2.3, 3.6, 3.7, 3.12.10, 3.13, 9.6.4, 9.9.1,  
 10.2.2, 13.1, 13.3, 13.4.1, 13.4.2, 13.5, 14, 15.2.8,  
 15.4  
 Rejection of Work  
 4.2.6, 12.2.1  
 Releases and Waivers of Liens  
 9.3.1, 9.10.2  
 Representations  
 3.2.1, 3.5, 3.12.6, 8.2.1, 9.3.3, 9.4.2, 9.5.1, 9.10.1  
 Representatives  
 2.1.1, 3.1.1, 3.9, 4.1.1, 4.2.10, 13.2.1  
 Responsibility for Those Performing the Work  
 3.3.2, 3.18, 4.2.2, 4.2.3, 5.3, 6.1.3, 6.2, 6.3, 9.5.1, 10  
 Retainage  
 9.3.1, 9.6.2, 9.8.5, 9.9.1, 9.10.2, 9.10.3  
 Review of Contract Documents and Field Conditions  
 by Contractor  
 3.2, 3.12.7, 6.1.3  
 Review of Contractor's Submittals by Owner and  
 Architect  
 3.10.1, 3.10.2, 3.11, 3.12, 4.2, 5.2, 6.1.3, 9.2, 9.8.2  
 Review of Shop Drawings, Product Data and  
 Samples by Contractor  
 3.12  
 Rights and Remedies  
 1.1.2, 2.4, 2.5, 3.5, 3.7.4, 3.15.2, 4.2.6, 5.3, 5.4, 6.1,  
 6.3, 7.3.1, 8.3, 9.5.1, 9.7, 10.2.5, 10.3, 12.2.1, 12.2.2,  
 12.2.4, 13.3, 14, 15.4  
 Royalties, Patents and Copyrights  
 3.17  
 Rules and Notices for Arbitration  
 15.4.1  
 Safety of Persons and Property  
 10.2, 10.4  
 Safety Precautions and Programs  
 3.3.1, 4.2.2, 4.2.7, 5.3, 10.1, 10.2, 10.4  
 Samples, Definition of  
 3.12.3  
 Samples, Shop Drawings, Product Data and  
 3.11, 3.12, 4.2.7  
 Samples at the Site, Documents and  
 3.11  
 Schedule of Values  
 9.2, 9.3.1  
 Schedules, Construction  
 3.10, 3.12.1, 3.12.2, 6.1.3, 15.1.6.2  
 Separate Contracts and Contractors  
 1.1.4, 3.12.5, 3.14.2, 4.2.4, 4.2.7, 6, 8.3.1, 12.1.2  
 Separate Contractors, Definition of

6.1.1  
 Shop Drawings, Definition of  
 3.12.1  
 Shop Drawings, Product Data and Samples  
 3.11, 3.12, 4.2.7  
 Site, Use of  
 3.13, 6.1.1, 6.2.1  
 Site Inspections  
 3.2.2, 3.3.3, 3.7.1, 3.7.4, 4.2, 9.9.2, 9.4.2, 9.10.1, 13.4  
 Site Visits, Architect's  
 3.7.4, 4.2.2, 4.2.9, 9.4.2, 9.5.1, 9.9.2, 9.10.1, 13.4  
 Special Inspections and Testing  
 4.2.6, 12.2.1, 13.4  
 Specifications, Definition of  
 1.1.6  
 Specifications  
 1.1.1, 1.1.6, 1.2.2, 1.5, 3.12.10, 3.17, 4.2.14  
 Statute of Limitations  
 15.1.2, 15.4.1.1  
 Stopping the Work  
 2.2.2, 2.4, 9.7, 10.3, 14.1  
 Stored Materials  
 6.2.1, 9.3.2, 10.2.1.2, 10.2.4  
 Subcontractor, Definition of  
 5.1.1  
**SUBCONTRACTORS**  
 5  
 Subcontractors, Work by  
 1.2.2, 3.3.2, 3.12.1, 3.18, 4.2.3, 5.2.3, 5.3, 5.4,  
 9.3.1.2, 9.6.7  
 Subcontractual Relations  
 5.3, 5.4, 9.3.1.2, 9.6, 9.10, 10.2.1, 14.1, 14.2.1  
 Submittals  
 3.10, 3.11, 3.12, 4.2.7, 5.2.1, 5.2.3, 7.3.4, 9.2, 9.3,  
 9.8, 9.9.1, 9.10.2, 9.10.3  
 Submittal Schedule  
 3.10.2, 3.12.5, 4.2.7  
 Subrogation, Waivers of  
 6.1.1, 11.3  
 Substances, Hazardous  
 10.3  
 Substantial Completion  
 4.2.9, 8.1.1, 8.1.3, 8.2.3, 9.4.2, 9.8, 9.9.1, 9.10.3,  
 12.2, 15.1.2  
 Substantial Completion, Definition of  
 9.8.1  
 Substitution of Subcontractors  
 5.2.3, 5.2.4  
 Substitution of Architect  
 2.3.3  
 Substitutions of Materials  
 3.4.2, 3.5, 7.3.8  
 Sub-subcontractor, Definition of  
 5.1.2  
 Subsurface Conditions  
 3.7.4  
 Successors and Assigns

13.2  
Superintendent  
3.9, 10.2.6  
Supervision and Construction Procedures  
1.2.2, 3.3, 3.4, 3.12.10, 4.2.2, 4.2.7, 6.1.3, 6.2.4,  
7.1.3, 7.3.4, 8.2, 8.3.1, 9.4.2, 10, 12, 14, 15.1.4  
Suppliers  
1.5, 3.12.1, 4.2.4, 4.2.6, 5.2.1, 9.3, 9.4.2, 9.5.4, 9.6,  
9.10.5, 14.2.1  
Surety  
5.4.1.2, 9.6.8, 9.8.5, 9.10.2, 9.10.3, 11.1.2, 14.2.2,  
15.2.7  
Surety, Consent of  
9.8.5, 9.10.2, 9.10.3  
Surveys  
1.1.7, 2.3.4  
Suspension by the Owner for Convenience  
14.3  
Suspension of the Work  
3.7.5, 5.4.2, 14.3  
Suspension or Termination of the Contract  
5.4.1.1, 14  
Taxes  
3.6, 3.8.2.1, 7.3.4.4  
Termination by the Contractor  
14.1, 15.1.7  
Termination by the Owner for Cause  
5.4.1.1, 14.2, 15.1.7  
Termination by the Owner for Convenience  
14.4  
Termination of the Architect  
2.3.3  
Termination of the Contractor Employment  
14.2.2

#### TERMINATION OR SUSPENSION OF THE CONTRACT

14  
Tests and Inspections  
3.1.3, 3.3.3, 3.7.1, 4.2.2, 4.2.6, 4.2.9, 9.4.2, 9.8.3,  
9.9.2, 9.10.1, 10.3.2, 12.2.1, 13.4  
TIME  
8  
Time, Delays and Extensions of  
3.2.4, 3.7.4, 5.2.3, 7.2.1, 7.3.1, 7.4, 8.3, 9.5.1, 9.7,  
10.3.2, 10.4, 14.3.2, 15.1.6, 15.2.5  
Time Limits

2.1.2, 2.2, 2.5, 3.2.2, 3.10, 3.11, 3.12.5, 3.15.1, 4.2,  
5.2, 5.3, 5.4, 6.2.4, 7.3, 7.4, 8.2, 9.2, 9.3.1, 9.3.3,  
9.4.1, 9.5, 9.6, 9.7, 9.8, 9.9, 9.10, 12.2, 13.4, 14,  
15.1.2, 15.1.3, 15.4  
Time Limits on Claims  
3.7.4, 10.2.8, 15.1.2, 15.1.3  
Title to Work  
9.3.2, 9.3.3  
UNCOVERING AND CORRECTION OF WORK  
12  
Uncovering of Work  
12.1  
Unforeseen Conditions, Concealed or Unknown  
3.7.4, 8.3.1, 10.3  
Unit Prices  
7.3.3.2, 9.1.2  
Use of Documents  
1.1.1, 1.5, 2.3.6, 3.12.6, 5.3  
Use of Site  
3.13, 6.1.1, 6.2.1  
Values, Schedule of  
9.2, 9.3.1  
Waiver of Claims by the Architect  
13.3.2  
Waiver of Claims by the Contractor  
9.10.5, 13.3.2, 15.1.7  
Waiver of Claims by the Owner  
9.9.3, 9.10.3, 9.10.4, 12.2.2.1, 13.3.2, 14.2.4, 15.1.7  
Waiver of Consequential Damages  
14.2.4, 15.1.7  
Waiver of Liens  
9.3, 9.10.2, 9.10.4  
Waivers of Subrogation  
6.1.1, 11.3  
Warranty  
3.5, 4.2.9, 9.3.3, 9.8.4, 9.9.1, 9.10.2, 9.10.4, 12.2.2,  
15.1.2  
Weather Delays  
8.3, 15.1.6.2  
Work, Definition of  
1.1.3  
Written Consent  
1.5.2, 3.4.2, 3.7.4, 3.12.8, 3.14.2, 4.1.2, 9.3.2, 9.10.3,  
13.2, 13.3.2, 15.4.4.2  
Written Interpretations  
4.2.11, 4.2.12  
Written Orders  
1.1.1, 2.4, 3.9, 7, 8.2.2, 12.1, 12.2, 13.4.2, 14.3.1

## **ARTICLE 1 GENERAL PROVISIONS**

### **§ 1.1 Basic Definitions**

#### **§ 1.1.1 The Contract Documents**

The Contract Documents are enumerated in the Agreement between the Owner and Contractor (hereinafter the Agreement) and consist of the Agreement, Conditions of the Contract (General, Supplementary and other Conditions), Drawings, Specifications, Addenda issued prior to execution of the Contract, other documents listed in the Agreement, and Modifications issued after execution of the Contract. A Modification is (1) a written amendment to the Contract signed by both parties, (2) a Change Order, (3) a Construction Change Directive, or (4) a written order for a minor change in the Work issued by the Architect. Unless specifically enumerated in the Agreement, the Contract Documents do not include the advertisement or invitation to bid, Instructions to Bidders, sample forms, other information furnished by the Owner in anticipation of receiving bids or proposals, the Contractor's bid or proposal, or portions of Addenda relating to bidding or proposal requirements.

#### **§ 1.1.2 The Contract**

The Contract Documents form the Contract for Construction. The Contract represents the entire and integrated agreement between the parties hereto and supersedes prior negotiations, representations, or agreements, either written or oral. The Contract may be amended or modified only by a Modification. The Contract Documents shall not be construed to create a contractual relationship of any kind (1) between the Contractor and the Architect or the Architect's consultants, (2) between the Owner and a Subcontractor or a Sub-subcontractor, (3) between the Owner and the Architect or the Architect's consultants, or (4) between any persons or entities other than the Owner and the Contractor. The Architect shall, however, be entitled to performance and enforcement of obligations under the Contract intended to facilitate performance of the Architect's duties.

#### **§ 1.1.3 The Work**

The term "Work" means the construction and services required by the Contract Documents, whether completed or partially completed, and includes all other labor, materials, equipment, and services provided or to be provided by the Contractor to fulfill the Contractor's obligations. The Work may constitute the whole or a part of the Project.

#### **§ 1.1.4 The Project**

The Project is the total construction of which the Work performed under the Contract Documents may be the whole or a part and which may include construction by the Owner and by Separate Contractors.

#### **§ 1.1.5 The Drawings**

The Drawings are the graphic and pictorial portions of the Contract Documents showing the design, location and dimensions of the Work, generally including plans, elevations, sections, details, schedules, and diagrams.

#### **§ 1.1.6 The Specifications**

The Specifications are that portion of the Contract Documents consisting of the written requirements for materials, equipment, systems, standards and workmanship for the Work, and performance of related services.

#### **§ 1.1.7 Instruments of Service**

Instruments of Service are representations, in any medium of expression now known or later developed, of the tangible and intangible creative work performed by the Architect and the Architect's consultants under their respective professional services agreements. Instruments of Service may include, without limitation, studies, surveys, models, sketches, drawings, specifications, and other similar materials.

#### **§ 1.1.8 Initial Decision Maker**

The Initial Decision Maker is the person identified in the Agreement to render initial decisions on Claims in accordance with Section 15.2. The Initial Decision Maker shall not show partiality to the Owner or Contractor and shall not be liable for results of interpretations or decisions rendered in good faith.

### **§ 1.2 Correlation and Intent of the Contract Documents**

**§ 1.2.1** The intent of the Contract Documents is to include all items necessary for the proper execution and completion of the Work by the Contractor. The Contract Documents are complementary, and what is required by one shall be as binding as if required by all; performance by the Contractor shall be required only to the extent

consistent with the Contract Documents and reasonably inferable from them as being necessary to produce the indicated results.

**§ 1.2.1.1** The invalidity of any provision of the Contract Documents shall not invalidate the Contract or its remaining provisions. If it is determined that any provision of the Contract Documents violates any law, or is otherwise invalid or unenforceable, then that provision shall be revised to the extent necessary to make that provision legal and enforceable. In such case the Contract Documents shall be construed, to the fullest extent permitted by law, to give effect to the parties' intentions and purposes in executing the Contract.

**§ 1.2.2** Organization of the Specifications into divisions, sections and articles, and arrangement of Drawings shall not control the Contractor in dividing the Work among Subcontractors or in establishing the extent of Work to be performed by any trade.

**§ 1.2.3** Unless otherwise stated in the Contract Documents, words that have well-known technical or construction industry meanings are used in the Contract Documents in accordance with such recognized meanings.

### **§ 1.3 Capitalization**

Terms capitalized in these General Conditions include those that are (1) specifically defined, (2) the titles of numbered articles, or (3) the titles of other documents published by the American Institute of Architects.

### **§ 1.4 Interpretation**

In the interest of brevity the Contract Documents frequently omit modifying words such as "all" and "any" and articles such as "the" and "an," but the fact that a modifier or an article is absent from one statement and appears in another is not intended to affect the interpretation of either statement.

### **§ 1.5 Ownership and Use of Drawings, Specifications, and Other Instruments of Service**

**§ 1.5.1** The Architect and the Architect's consultants shall be deemed the authors and owners of their respective Instruments of Service, including the Drawings and Specifications, and retain all common law, statutory, and other reserved rights in their Instruments of Service, including copyrights. The Contractor, Subcontractors, Sub-subcontractors, and suppliers shall not own or claim a copyright in the Instruments of Service. Submittal or distribution to meet official regulatory requirements or for other purposes in connection with the Project is not to be construed as publication in derogation of the Architect's or Architect's consultants' reserved rights.

**§ 1.5.2** The Contractor, Subcontractors, Sub-subcontractors, and suppliers are authorized to use and reproduce the Instruments of Service provided to them, subject to any protocols established pursuant to Sections 1.7 and 1.8, solely and exclusively for execution of the Work. All copies made under this authorization shall bear the copyright notice, if any, shown on the Instruments of Service. The Contractor, Subcontractors, Sub-subcontractors, and suppliers may not use the Instruments of Service on other projects or for additions to the Project outside the scope of the Work without the specific written consent of the Owner, Architect, and the Architect's consultants.

### **§ 1.6 Notice**

**§ 1.6.1** Except as otherwise provided in Section 1.6.2, where the Contract Documents require one party to notify or give notice to the other party, such notice shall be provided in writing to the designated representative of the party to whom the notice is addressed and shall be deemed to have been duly served if delivered in person, by mail, by courier, or by electronic transmission if a method for electronic transmission is set forth in the Agreement.

**§ 1.6.2** Notice of Claims as provided in Section 15.1.3 shall be provided in writing and shall be deemed to have been duly served only if delivered to the designated representative of the party to whom the notice is addressed by certified or registered mail, or by courier providing proof of delivery.

### **§ 1.7 Digital Data Use and Transmission**

The parties shall agree upon protocols governing the transmission and use of Instruments of Service or any other information or documentation in digital form. The parties will use AIA Document E203™–2013, Building Information Modeling and Digital Data Exhibit, to establish the protocols for the development, use, transmission, and exchange of digital data.



## § 1.8 Building Information Models Use and Reliance

Any use of, or reliance on, all or a portion of a building information model without agreement to protocols governing the use of, and reliance on, the information contained in the model and without having those protocols set forth in AIA Document E203™–2013, Building Information Modeling and Digital Data Exhibit, and the requisite AIA Document G202™–2013, Project Building Information Modeling Protocol Form, shall be at the using or relying party's sole risk and without liability to the other party and its contractors or consultants, the authors of, or contributors to, the building information model, and each of their agents and employees.

## ARTICLE 2 OWNER

### § 2.1 General

§ 2.1.1 The Owner is the person or entity identified as such in the Agreement and is referred to throughout the Contract Documents as if singular in number. The Owner shall designate in writing a representative who shall have express authority to bind the Owner with respect to all matters requiring the Owner's approval or authorization. Except as otherwise provided in Section 4.2.1, the Architect does not have such authority. The term "Owner" means the Owner or the Owner's authorized representative.

§ 2.1.2 The Owner shall furnish to the Contractor, within fifteen days after receipt of a written request, information necessary and relevant for the Contractor to evaluate, give notice of, or enforce mechanic's lien rights. Such information shall include a correct statement of the record legal title to the property on which the Project is located, usually referred to as the site, and the Owner's interest therein.

### § 2.2 Evidence of the Owner's Financial Arrangements

§ 2.2.1 Prior to commencement of the Work and upon written request by the Contractor, the Owner shall furnish to the Contractor reasonable evidence that the Owner has made financial arrangements to fulfill the Owner's obligations under the Contract. The Contractor shall have no obligation to commence the Work until the Owner provides such evidence. If commencement of the Work is delayed under this Section 2.2.1, the Contract Time shall be extended appropriately.

§ 2.2.2 Following commencement of the Work and upon written request by the Contractor, the Owner shall furnish to the Contractor reasonable evidence that the Owner has made financial arrangements to fulfill the Owner's obligations under the Contract only if (1) the Owner fails to make payments to the Contractor as the Contract Documents require; (2) the Contractor identifies in writing a reasonable concern regarding the Owner's ability to make payment when due; or (3) a change in the Work materially changes the Contract Sum. If the Owner fails to provide such evidence, as required, within fourteen days of the Contractor's request, the Contractor may immediately stop the Work and, in that event, shall notify the Owner that the Work has stopped. However, if the request is made because a change in the Work materially changes the Contract Sum under (3) above, the Contractor may immediately stop only that portion of the Work affected by the change until reasonable evidence is provided. If the Work is stopped under this Section 2.2.2, the Contract Time shall be extended appropriately and the Contract Sum shall be increased by the amount of the Contractor's reasonable costs of shutdown, delay and start-up, plus interest as provided in the Contract Documents.

§ 2.2.3 After the Owner furnishes evidence of financial arrangements under this Section 2.2, the Owner shall not materially vary such financial arrangements without prior notice to the Contractor.

§ 2.2.4 Where the Owner has designated information furnished under this Section 2.2 as "confidential," the Contractor shall keep the information confidential and shall not disclose it to any other person. However, the Contractor may disclose "confidential" information, after seven (7) days' notice to the Owner, where disclosure is required by law, including a subpoena or other form of compulsory legal process issued by a court or governmental entity, or by court or arbitrator(s) order. The Contractor may also disclose "confidential" information to its employees, consultants, sureties, Subcontractors and their employees, Sub-subcontractors, and others who need to know the content of such information solely and exclusively for the Project and who agree to maintain the confidentiality of such information.

### § 2.3 Information and Services Required of the Owner

§ 2.3.1 Except for permits and fees that are the responsibility of the Contractor under the Contract Documents, including those required under Section 3.7.1, the Owner shall secure and pay for necessary approvals, easements,

assessments and charges required for construction, use or occupancy of permanent structures or for permanent changes in existing facilities.

**§ 2.3.2** The Owner shall retain an architect lawfully licensed to practice architecture, or an entity lawfully practicing architecture, in the jurisdiction where the Project is located. That person or entity is identified as the Architect in the Agreement and is referred to throughout the Contract Documents as if singular in number.

**§ 2.3.3** If the employment of the Architect terminates, the Owner shall employ a successor to whom the Contractor has no reasonable objection and whose status under the Contract Documents shall be that of the Architect.

**§ 2.3.4** The Owner shall furnish surveys describing physical characteristics, legal limitations and utility locations for the site of the Project, and a legal description of the site. The Contractor shall be entitled to rely on the accuracy of information furnished by the Owner but shall exercise proper precautions relating to the safe performance of the Work.

**§ 2.3.5** The Owner shall furnish information or services required of the Owner by the Contract Documents with reasonable promptness. The Owner shall also furnish any other information or services under the Owner's control and relevant to the Contractor's performance of the Work with reasonable promptness after receiving the Contractor's written request for such information or services.

**§ 2.3.6** Unless otherwise provided in the Contract Documents, the Owner shall furnish to the Contractor one copy of the Contract Documents for purposes of making reproductions pursuant to Section 1.5.2.

#### **§ 2.4 Owner's Right to Stop the Work**

If the Contractor fails to correct Work that is not in accordance with the requirements of the Contract Documents as required by Section 12.2 or repeatedly fails to carry out Work in accordance with the Contract Documents, the Owner may issue a written order to the Contractor to stop the Work, or any portion thereof, until the cause for such order has been eliminated; however, the right of the Owner to stop the Work shall not give rise to a duty on the part of the Owner to exercise this right for the benefit of the Contractor or any other person or entity, except to the extent required by Section 6.1.3.

#### **§ 2.5 Owner's Right to Carry Out the Work**

If the Contractor defaults or neglects to carry out the Work in accordance with the Contract Documents and fails within a ten-day period after receipt of notice from the Owner to commence and continue correction of such default or neglect with diligence and promptness, the Owner may, without prejudice to other remedies the Owner may have, correct such default or neglect. Such action by the Owner and amounts charged to the Contractor are both subject to prior approval of the Architect and the Architect may, pursuant to Section 9.5.1, withhold or nullify a Certificate for Payment in whole or in part, to the extent reasonably necessary to reimburse the Owner for the reasonable cost of correcting such deficiencies, including Owner's expenses and compensation for the Architect's additional services made necessary by such default, neglect, or failure. If current and future payments are not sufficient to cover such amounts, the Contractor shall pay the difference to the Owner. If the Contractor disagrees with the actions of the Owner or the Architect, or the amounts claimed as costs to the Owner, the Contractor may file a Claim pursuant to Article 15.

### **ARTICLE 3 CONTRACTOR**

#### **§ 3.1 General**

**§ 3.1.1** The Contractor is the person or entity identified as such in the Agreement and is referred to throughout the Contract Documents as if singular in number. The Contractor shall be lawfully licensed, if required in the jurisdiction where the Project is located. The Contractor shall designate in writing a representative who shall have express authority to bind the Contractor with respect to all matters under this Contract. The term "Contractor" means the Contractor or the Contractor's authorized representative.

**§ 3.1.2** The Contractor shall perform the Work in accordance with the Contract Documents.

**§ 3.1.3** The Contractor shall not be relieved of its obligations to perform the Work in accordance with the Contract Documents either by activities or duties of the Architect in the Architect's administration of the Contract, or by tests, inspections or approvals required or performed by persons or entities other than the Contractor.

### **§ 3.2 Review of Contract Documents and Field Conditions by Contractor**

**§ 3.2.1** Execution of the Contract by the Contractor is a representation that the Contractor has visited the site, become generally familiar with local conditions under which the Work is to be performed, and correlated personal observations with requirements of the Contract Documents.

**§ 3.2.2** Because the Contract Documents are complementary, the Contractor shall, before starting each portion of the Work, carefully study and compare the various Contract Documents relative to that portion of the Work, as well as the information furnished by the Owner pursuant to Section 2.3.4, shall take field measurements of any existing conditions related to that portion of the Work, and shall observe any conditions at the site affecting it. These obligations are for the purpose of facilitating coordination and construction by the Contractor and are not for the purpose of discovering errors, omissions, or inconsistencies in the Contract Documents; however, the Contractor shall promptly report to the Architect any errors, inconsistencies or omissions discovered by or made known to the Contractor as a request for information in such form as the Architect may require. It is recognized that the Contractor's review is made in the Contractor's capacity as a contractor and not as a licensed design professional, unless otherwise specifically provided in the Contract Documents.

**§ 3.2.3** The Contractor is not required to ascertain that the Contract Documents are in accordance with applicable laws, statutes, ordinances, codes, rules and regulations, or lawful orders of public authorities, but the Contractor shall promptly report to the Architect any nonconformity discovered by or made known to the Contractor as a request for information in such form as the Architect may require.

**§ 3.2.4** If the Contractor believes that additional cost or time is involved because of clarifications or instructions the Architect issues in response to the Contractor's notices or requests for information pursuant to Sections 3.2.2 or 3.2.3, the Contractor shall submit Claims as provided in Article 15. If the Contractor fails to perform the obligations of Sections 3.2.2 or 3.2.3, the Contractor shall pay such costs and damages to the Owner, subject to Section 15.1.7, as would have been avoided if the Contractor had performed such obligations. If the Contractor performs those obligations, the Contractor shall not be liable to the Owner or Architect for damages resulting from errors, inconsistencies or omissions in the Contract Documents, for differences between field measurements or conditions and the Contract Documents, or for nonconformities of the Contract Documents to applicable laws, statutes, ordinances, codes, rules and regulations, and lawful orders of public authorities.

### **§ 3.3 Supervision and Construction Procedures**

**§ 3.3.1** The Contractor shall supervise and direct the Work, using the Contractor's best skill and attention. The Contractor shall be solely responsible for, and have control over, construction means, methods, techniques, sequences, and procedures, and for coordinating all portions of the Work under the Contract. If the Contract Documents give specific instructions concerning construction means, methods, techniques, sequences, or procedures, the Contractor shall evaluate the jobsite safety thereof and shall be solely responsible for the jobsite safety of such means, methods, techniques, sequences, or procedures. If the Contractor determines that such means, methods, techniques, sequences or procedures may not be safe, the Contractor shall give timely notice to the Owner and Architect, and shall propose alternative means, methods, techniques, sequences, or procedures. The Architect shall evaluate the proposed alternative solely for conformance with the design intent for the completed construction. Unless the Architect objects to the Contractor's proposed alternative, the Contractor shall perform the Work using its alternative means, methods, techniques, sequences, or procedures.

**§ 3.3.2** The Contractor shall be responsible to the Owner for acts and omissions of the Contractor's employees, Subcontractors and their agents and employees, and other persons or entities performing portions of the Work for, or on behalf of, the Contractor or any of its Subcontractors.

**§ 3.3.3** The Contractor shall be responsible for inspection of portions of Work already performed to determine that such portions are in proper condition to receive subsequent Work.

### **§ 3.4 Labor and Materials**

**§ 3.4.1** Unless otherwise provided in the Contract Documents, the Contractor shall provide and pay for labor, materials, equipment, tools, construction equipment and machinery, water, heat, utilities, transportation, and other facilities and services necessary for proper execution and completion of the Work, whether temporary or permanent and whether or not incorporated or to be incorporated in the Work.



**§ 3.4.2** Except in the case of minor changes in the Work approved by the Architect in accordance with Section 3.12.8 or ordered by the Architect in accordance with Section 7.4, the Contractor may make substitutions only with the consent of the Owner, after evaluation by the Architect and in accordance with a Change Order or Construction Change Directive.

**§ 3.4.3** The Contractor shall enforce strict discipline and good order among the Contractor's employees and other persons carrying out the Work. The Contractor shall not permit employment of unfit persons or persons not properly skilled in tasks assigned to them.

### **§ 3.5 Warranty**

**§ 3.5.1** The Contractor warrants to the Owner and Architect that materials and equipment furnished under the Contract will be of good quality and new unless the Contract Documents require or permit otherwise. The Contractor further warrants that the Work will conform to the requirements of the Contract Documents and will be free from defects, except for those inherent in the quality of the Work the Contract Documents require or permit. Work, materials, or equipment not conforming to these requirements may be considered defective. The Contractor's warranty excludes remedy for damage or defect caused by abuse, alterations to the Work not executed by the Contractor, improper or insufficient maintenance, improper operation, or normal wear and tear and normal usage. If required by the Architect, the Contractor shall furnish satisfactory evidence as to the kind and quality of materials and equipment.

**§ 3.5.2** All material, equipment, or other special warranties required by the Contract Documents shall be issued in the name of the Owner, or shall be transferable to the Owner, and shall commence in accordance with Section 9.8.4.

### **§ 3.6 Taxes**

The Contractor shall pay sales, consumer, use and similar taxes for the Work provided by the Contractor that are legally enacted when bids are received or negotiations concluded, whether or not yet effective or merely scheduled to go into effect.

### **§ 3.7 Permits, Fees, Notices and Compliance with Laws**

**§ 3.7.1** Unless otherwise provided in the Contract Documents, the Contractor shall secure and pay for the building permit as well as for other permits, fees, licenses, and inspections by government agencies necessary for proper execution and completion of the Work that are customarily secured after execution of the Contract and legally required at the time bids are received or negotiations concluded.

**§ 3.7.2** The Contractor shall comply with and give notices required by applicable laws, statutes, ordinances, codes, rules and regulations, and lawful orders of public authorities applicable to performance of the Work.

**§ 3.7.3** If the Contractor performs Work knowing it to be contrary to applicable laws, statutes, ordinances, codes, rules and regulations, or lawful orders of public authorities, the Contractor shall assume appropriate responsibility for such Work and shall bear the costs attributable to correction.

### **§ 3.7.4 Concealed or Unknown Conditions**

If the Contractor encounters conditions at the site that are (1) subsurface or otherwise concealed physical conditions that differ materially from those indicated in the Contract Documents or (2) unknown physical conditions of an unusual nature that differ materially from those ordinarily found to exist and generally recognized as inherent in construction activities of the character provided for in the Contract Documents, the Contractor shall promptly provide notice to the Owner and the Architect before conditions are disturbed and in no event later than 14 days after first observance of the conditions. The Architect will promptly investigate such conditions and, if the Architect determines that they differ materially and cause an increase or decrease in the Contractor's cost of, or time required for, performance of any part of the Work, will recommend that an equitable adjustment be made in the Contract Sum or Contract Time, or both. If the Architect determines that the conditions at the site are not materially different from those indicated in the Contract Documents and that no change in the terms of the Contract is justified, the Architect shall promptly notify the Owner and Contractor, stating the reasons. If either party disputes the Architect's determination or recommendation, that party may submit a Claim as provided in Article 15.

**§ 3.7.5** If, in the course of the Work, the Contractor encounters human remains or recognizes the existence of burial markers, archaeological sites or wetlands not indicated in the Contract Documents, the Contractor shall immediately suspend any operations that would affect them and shall notify the Owner and Architect. Upon receipt of such notice, the Owner shall promptly take any action necessary to obtain governmental authorization required to resume the operations. The Contractor shall continue to suspend such operations until otherwise instructed by the Owner but shall continue with all other operations that do not affect those remains or features. Requests for adjustments in the Contract Sum and Contract Time arising from the existence of such remains or features may be made as provided in Article 15.

### **§ 3.8 Allowances**

**§ 3.8.1** The Contractor shall include in the Contract Sum all allowances stated in the Contract Documents. Items covered by allowances shall be supplied for such amounts and by such persons or entities as the Owner may direct, but the Contractor shall not be required to employ persons or entities to whom the Contractor has reasonable objection.

**§ 3.8.2** Unless otherwise provided in the Contract Documents,

- .1 allowances shall cover the cost to the Contractor of materials and equipment delivered at the site and all required taxes, less applicable trade discounts;
- .2 Contractor's costs for unloading and handling at the site, labor, installation costs, overhead, profit, and other expenses contemplated for stated allowance amounts shall be included in the Contract Sum but not in the allowances; and
- .3 whenever costs are more than or less than allowances, the Contract Sum shall be adjusted accordingly by Change Order. The amount of the Change Order shall reflect (1) the difference between actual costs and the allowances under Section 3.8.2.1 and (2) changes in Contractor's costs under Section 3.8.2.2.

**§ 3.8.3** Materials and equipment under an allowance shall be selected by the Owner with reasonable promptness.

### **§ 3.9 Superintendent**

**§ 3.9.1** The Contractor shall employ a competent superintendent and necessary assistants who shall be in attendance at the Project site during performance of the Work. The superintendent shall represent the Contractor, and communications given to the superintendent shall be as binding as if given to the Contractor.

**§ 3.9.2** The Contractor, as soon as practicable after award of the Contract, shall notify the Owner and Architect of the name and qualifications of a proposed superintendent. Within 14 days of receipt of the information, the Architect may notify the Contractor, stating whether the Owner or the Architect (1) has reasonable objection to the proposed superintendent or (2) requires additional time for review. Failure of the Architect to provide notice within the 14-day period shall constitute notice of no reasonable objection.

**§ 3.9.3** The Contractor shall not employ a proposed superintendent to whom the Owner or Architect has made reasonable and timely objection. The Contractor shall not change the superintendent without the Owner's consent, which shall not unreasonably be withheld or delayed.

### **§ 3.10 Contractor's Construction and Submittal Schedules**

**§ 3.10.1** The Contractor, promptly after being awarded the Contract, shall submit for the Owner's and Architect's information a Contractor's construction schedule for the Work. The schedule shall contain detail appropriate for the Project, including (1) the date of commencement of the Work, interim schedule milestone dates, and the date of Substantial Completion; (2) an apportionment of the Work by construction activity; and (3) the time required for completion of each portion of the Work. The schedule shall provide for the orderly progression of the Work to completion and shall not exceed time limits current under the Contract Documents. The schedule shall be revised at appropriate intervals as required by the conditions of the Work and Project.

**§ 3.10.2** The Contractor, promptly after being awarded the Contract and thereafter as necessary to maintain a current submittal schedule, shall submit a submittal schedule for the Architect's approval. The Architect's approval shall not be unreasonably delayed or withheld. The submittal schedule shall (1) be coordinated with the Contractor's construction schedule, and (2) allow the Architect reasonable time to review submittals. If the Contractor fails to submit a submittal schedule, or fails to provide submittals in accordance with the approved submittal schedule, the

Contractor shall not be entitled to any increase in Contract Sum or extension of Contract Time based on the time required for review of submittals.

**§ 3.10.3** The Contractor shall perform the Work in general accordance with the most recent schedules submitted to the Owner and Architect.

### **§ 3.11 Documents and Samples at the Site**

The Contractor shall make available, at the Project site, the Contract Documents, including Change Orders, Construction Change Directives, and other Modifications, in good order and marked currently to indicate field changes and selections made during construction, and the approved Shop Drawings, Product Data, Samples, and similar required submittals. These shall be in electronic form or paper copy, available to the Architect and Owner, and delivered to the Architect for submittal to the Owner upon completion of the Work as a record of the Work as constructed.

### **§ 3.12 Shop Drawings, Product Data and Samples**

**§ 3.12.1** Shop Drawings are drawings, diagrams, schedules, and other data specially prepared for the Work by the Contractor or a Subcontractor, Sub-subcontractor, manufacturer, supplier, or distributor to illustrate some portion of the Work.

**§ 3.12.2** Product Data are illustrations, standard schedules, performance charts, instructions, brochures, diagrams, and other information furnished by the Contractor to illustrate materials or equipment for some portion of the Work.

**§ 3.12.3** Samples are physical examples that illustrate materials, equipment, or workmanship, and establish standards by which the Work will be judged.

**§ 3.12.4** Shop Drawings, Product Data, Samples, and similar submittals are not Contract Documents. Their purpose is to demonstrate how the Contractor proposes to conform to the information given and the design concept expressed in the Contract Documents for those portions of the Work for which the Contract Documents require submittals. Review by the Architect is subject to the limitations of Section 4.2.7. Informational submittals upon which the Architect is not expected to take responsive action may be so identified in the Contract Documents. Submittals that are not required by the Contract Documents may be returned by the Architect without action.

**§ 3.12.5** The Contractor shall review for compliance with the Contract Documents, approve, and submit to the Architect, Shop Drawings, Product Data, Samples, and similar submittals required by the Contract Documents, in accordance with the submittal schedule approved by the Architect or, in the absence of an approved submittal schedule, with reasonable promptness and in such sequence as to cause no delay in the Work or in the activities of the Owner or of Separate Contractors.

**§ 3.12.6** By submitting Shop Drawings, Product Data, Samples, and similar submittals, the Contractor represents to the Owner and Architect that the Contractor has (1) reviewed and approved them, (2) determined and verified materials, field measurements and field construction criteria related thereto, or will do so, and (3) checked and coordinated the information contained within such submittals with the requirements of the Work and of the Contract Documents.

**§ 3.12.7** The Contractor shall perform no portion of the Work for which the Contract Documents require submittal and review of Shop Drawings, Product Data, Samples, or similar submittals, until the respective submittal has been approved by the Architect.

**§ 3.12.8** The Work shall be in accordance with approved submittals except that the Contractor shall not be relieved of responsibility for deviations from the requirements of the Contract Documents by the Architect's approval of Shop Drawings, Product Data, Samples, or similar submittals, unless the Contractor has specifically notified the Architect of such deviation at the time of submittal and (1) the Architect has given written approval to the specific deviation as a minor change in the Work, or (2) a Change Order or Construction Change Directive has been issued authorizing the deviation. The Contractor shall not be relieved of responsibility for errors or omissions in Shop Drawings, Product Data, Samples, or similar submittals, by the Architect's approval thereof.

**§ 3.12.9** The Contractor shall direct specific attention, in writing or on resubmitted Shop Drawings, Product Data, Samples, or similar submittals, to revisions other than those requested by the Architect on previous submittals. In the absence of such notice, the Architect's approval of a resubmission shall not apply to such revisions.

**§ 3.12.10** The Contractor shall not be required to provide professional services that constitute the practice of architecture or engineering unless such services are specifically required by the Contract Documents for a portion of the Work or unless the Contractor needs to provide such services in order to carry out the Contractor's responsibilities for construction means, methods, techniques, sequences, and procedures. The Contractor shall not be required to provide professional services in violation of applicable law.

**§ 3.12.10.1** If professional design services or certifications by a design professional related to systems, materials, or equipment are specifically required of the Contractor by the Contract Documents, the Owner and the Architect will specify all performance and design criteria that such services must satisfy. The Contractor shall be entitled to rely upon the adequacy and accuracy of the performance and design criteria provided in the Contract Documents. The Contractor shall cause such services or certifications to be provided by an appropriately licensed design professional, whose signature and seal shall appear on all drawings, calculations, specifications, certifications, Shop Drawings, and other submittals prepared by such professional. Shop Drawings, and other submittals related to the Work, designed or certified by such professional, if prepared by others, shall bear such professional's written approval when submitted to the Architect. The Owner and the Architect shall be entitled to rely upon the adequacy and accuracy of the services, certifications, and approvals performed or provided by such design professionals, provided the Owner and Architect have specified to the Contractor the performance and design criteria that such services must satisfy. Pursuant to this Section 3.12.10, the Architect will review and approve or take other appropriate action on submittals only for the limited purpose of checking for conformance with information given and the design concept expressed in the Contract Documents.

**§ 3.12.10.2** If the Contract Documents require the Contractor's design professional to certify that the Work has been performed in accordance with the design criteria, the Contractor shall furnish such certifications to the Architect at the time and in the form specified by the Architect.

### **§ 3.13 Use of Site**

The Contractor shall confine operations at the site to areas permitted by applicable laws, statutes, ordinances, codes, rules and regulations, lawful orders of public authorities, and the Contract Documents and shall not unreasonably encumber the site with materials or equipment.

### **§ 3.14 Cutting and Patching**

**§ 3.14.1** The Contractor shall be responsible for cutting, fitting, or patching required to complete the Work or to make its parts fit together properly. All areas requiring cutting, fitting, or patching shall be restored to the condition existing prior to the cutting, fitting, or patching, unless otherwise required by the Contract Documents.

**§ 3.14.2** The Contractor shall not damage or endanger a portion of the Work or fully or partially completed construction of the Owner or Separate Contractors by cutting, patching, or otherwise altering such construction, or by excavation. The Contractor shall not cut or otherwise alter construction by the Owner or a Separate Contractor except with written consent of the Owner and of the Separate Contractor. Consent shall not be unreasonably withheld. The Contractor shall not unreasonably withhold, from the Owner or a Separate Contractor, its consent to cutting or otherwise altering the Work.

### **§ 3.15 Cleaning Up**

**§ 3.15.1** The Contractor shall keep the premises and surrounding area free from accumulation of waste materials and rubbish caused by operations under the Contract. At completion of the Work, the Contractor shall remove waste materials, rubbish, the Contractor's tools, construction equipment, machinery, and surplus materials from and about the Project.

**§ 3.15.2** If the Contractor fails to clean up as provided in the Contract Documents, the Owner may do so and the Owner shall be entitled to reimbursement from the Contractor.



### **§ 3.16 Access to Work**

The Contractor shall provide the Owner and Architect with access to the Work in preparation and progress wherever located.

### **§ 3.17 Royalties, Patents and Copyrights**

The Contractor shall pay all royalties and license fees. The Contractor shall defend suits or claims for infringement of copyrights and patent rights and shall hold the Owner and Architect harmless from loss on account thereof, but shall not be responsible for defense or loss when a particular design, process, or product of a particular manufacturer or manufacturers is required by the Contract Documents, or where the copyright violations are contained in Drawings, Specifications, or other documents prepared by the Owner or Architect. However, if an infringement of a copyright or patent is discovered by, or made known to, the Contractor, the Contractor shall be responsible for the loss unless the information is promptly furnished to the Architect.

### **§ 3.18 Indemnification**

**§ 3.18.1** To the fullest extent permitted by law, the Contractor shall indemnify and hold harmless the Owner, Architect, Architect's consultants, and agents and employees of any of them from and against claims, damages, losses, and expenses, including but not limited to attorneys' fees, arising out of or resulting from performance of the Work, provided that such claim, damage, loss, or expense is attributable to bodily injury, sickness, disease or death, or to injury to or destruction of tangible property (other than the Work itself), but only to the extent caused by the negligent acts or omissions of the Contractor, a Subcontractor, anyone directly or indirectly employed by them, or anyone for whose acts they may be liable, regardless of whether or not such claim, damage, loss, or expense is caused in part by a party indemnified hereunder. Such obligation shall not be construed to negate, abridge, or reduce other rights or obligations of indemnity that would otherwise exist as to a party or person described in this Section 3.18.

**§ 3.18.2** In claims against any person or entity indemnified under this Section 3.18 by an employee of the Contractor, a Subcontractor, anyone directly or indirectly employed by them, or anyone for whose acts they may be liable, the indemnification obligation under Section 3.18.1 shall not be limited by a limitation on amount or type of damages, compensation, or benefits payable by or for the Contractor or a Subcontractor under workers' compensation acts, disability benefit acts, or other employee benefit acts.

## **ARTICLE 4 ARCHITECT**

### **§ 4.1 General**

**§ 4.1.1** The Architect is the person or entity retained by the Owner pursuant to Section 2.3.2 and identified as such in the Agreement.

**§ 4.1.2** Duties, responsibilities, and limitations of authority of the Architect as set forth in the Contract Documents shall not be restricted, modified, or extended without written consent of the Owner, Contractor, and Architect. Consent shall not be unreasonably withheld.

### **§ 4.2 Administration of the Contract**

**§ 4.2.1** The Architect will provide administration of the Contract as described in the Contract Documents and will be an Owner's representative during construction until the date the Architect issues the final Certificate for Payment. The Architect will have authority to act on behalf of the Owner only to the extent provided in the Contract Documents.

**§ 4.2.2** The Architect will visit the site at intervals appropriate to the stage of construction, or as otherwise agreed with the Owner, to become generally familiar with the progress and quality of the portion of the Work completed, and to determine in general if the Work observed is being performed in a manner indicating that the Work, when fully completed, will be in accordance with the Contract Documents. However, the Architect will not be required to make exhaustive or continuous on-site inspections to check the quality or quantity of the Work. The Architect will not have control over, charge of, or responsibility for the construction means, methods, techniques, sequences or procedures, or for the safety precautions and programs in connection with the Work, since these are solely the Contractor's rights and responsibilities under the Contract Documents.

**§ 4.2.3** On the basis of the site visits, the Architect will keep the Owner reasonably informed about the progress and quality of the portion of the Work completed, and promptly report to the Owner (1) known deviations from the

Init.

Contract Documents, (2) known deviations from the most recent construction schedule submitted by the Contractor, and (3) defects and deficiencies observed in the Work. The Architect will not be responsible for the Contractor's failure to perform the Work in accordance with the requirements of the Contract Documents. The Architect will not have control over or charge of, and will not be responsible for acts or omissions of, the Contractor, Subcontractors, or their agents or employees, or any other persons or entities performing portions of the Work.

#### **§ 4.2.4 Communications**

The Owner and Contractor shall include the Architect in all communications that relate to or affect the Architect's services or professional responsibilities. The Owner shall promptly notify the Architect of the substance of any direct communications between the Owner and the Contractor otherwise relating to the Project. Communications by and with the Architect's consultants shall be through the Architect. Communications by and with Subcontractors and suppliers shall be through the Contractor. Communications by and with Separate Contractors shall be through the Owner. The Contract Documents may specify other communication protocols.

**§ 4.2.5** Based on the Architect's evaluations of the Contractor's Applications for Payment, the Architect will review and certify the amounts due the Contractor and will issue Certificates for Payment in such amounts.

**§ 4.2.6** The Architect has authority to reject Work that does not conform to the Contract Documents. Whenever the Architect considers it necessary or advisable, the Architect will have authority to require inspection or testing of the Work in accordance with Sections 13.4.2 and 13.4.3, whether or not the Work is fabricated, installed or completed. However, neither this authority of the Architect nor a decision made in good faith either to exercise or not to exercise such authority shall give rise to a duty or responsibility of the Architect to the Contractor, Subcontractors, suppliers, their agents or employees, or other persons or entities performing portions of the Work.

**§ 4.2.7** The Architect will review and approve, or take other appropriate action upon, the Contractor's submittals such as Shop Drawings, Product Data, and Samples, but only for the limited purpose of checking for conformance with information given and the design concept expressed in the Contract Documents. The Architect's action will be taken in accordance with the submittal schedule approved by the Architect or, in the absence of an approved submittal schedule, with reasonable promptness while allowing sufficient time in the Architect's professional judgment to permit adequate review. Review of such submittals is not conducted for the purpose of determining the accuracy and completeness of other details such as dimensions and quantities, or for substantiating instructions for installation or performance of equipment or systems, all of which remain the responsibility of the Contractor as required by the Contract Documents. The Architect's review of the Contractor's submittals shall not relieve the Contractor of the obligations under Sections 3.3, 3.5, and 3.12. The Architect's review shall not constitute approval of safety precautions or of any construction means, methods, techniques, sequences, or procedures. The Architect's approval of a specific item shall not indicate approval of an assembly of which the item is a component.

**§ 4.2.8** The Architect will prepare Change Orders and Construction Change Directives, and may order minor changes in the Work as provided in Section 7.4. The Architect will investigate and make determinations and recommendations regarding concealed and unknown conditions as provided in Section 3.7.4.

**§ 4.2.9** The Architect will conduct inspections to determine the date or dates of Substantial Completion and the date of final completion; issue Certificates of Substantial Completion pursuant to Section 9.8; receive and forward to the Owner, for the Owner's review and records, written warranties and related documents required by the Contract and assembled by the Contractor pursuant to Section 9.10; and issue a final Certificate for Payment pursuant to Section 9.10.

**§ 4.2.10** If the Owner and Architect agree, the Architect will provide one or more Project representatives to assist in carrying out the Architect's responsibilities at the site. The Owner shall notify the Contractor of any change in the duties, responsibilities and limitations of authority of the Project representatives.

**§ 4.2.11** The Architect will interpret and decide matters concerning performance under, and requirements of, the Contract Documents on written request of either the Owner or Contractor. The Architect's response to such requests will be made in writing within any time limits agreed upon or otherwise with reasonable promptness.

**§ 4.2.12** Interpretations and decisions of the Architect will be consistent with the intent of, and reasonably inferable from, the Contract Documents and will be in writing or in the form of drawings. When making such interpretations

and decisions, the Architect will endeavor to secure faithful performance by both Owner and Contractor, will not show partiality to either, and will not be liable for results of interpretations or decisions rendered in good faith.

**§ 4.2.13** The Architect's decisions on matters relating to aesthetic effect will be final if consistent with the intent expressed in the Contract Documents.

**§ 4.2.14** The Architect will review and respond to requests for information about the Contract Documents. The Architect's response to such requests will be made in writing within any time limits agreed upon or otherwise with reasonable promptness. If appropriate, the Architect will prepare and issue supplemental Drawings and Specifications in response to the requests for information.

## **ARTICLE 5 SUBCONTRACTORS**

### **§ 5.1 Definitions**

**§ 5.1.1** A Subcontractor is a person or entity who has a direct contract with the Contractor to perform a portion of the Work at the site. The term "Subcontractor" is referred to throughout the Contract Documents as if singular in number and means a Subcontractor or an authorized representative of the Subcontractor. The term "Subcontractor" does not include a Separate Contractor or the subcontractors of a Separate Contractor.

**§ 5.1.2** A Sub-subcontractor is a person or entity who has a direct or indirect contract with a Subcontractor to perform a portion of the Work at the site. The term "Sub-subcontractor" is referred to throughout the Contract Documents as if singular in number and means a Sub-subcontractor or an authorized representative of the Sub-subcontractor.

### **§ 5.2 Award of Subcontracts and Other Contracts for Portions of the Work**

**§ 5.2.1** Unless otherwise stated in the Contract Documents, the Contractor, as soon as practicable after award of the Contract, shall notify the Owner and Architect of the persons or entities proposed for each principal portion of the Work, including those who are to furnish materials or equipment fabricated to a special design. Within 14 days of receipt of the information, the Architect may notify the Contractor whether the Owner or the Architect (1) has reasonable objection to any such proposed person or entity or (2) requires additional time for review. Failure of the Architect to provide notice within the 14-day period shall constitute notice of no reasonable objection.

**§ 5.2.2** The Contractor shall not contract with a proposed person or entity to whom the Owner or Architect has made reasonable and timely objection. The Contractor shall not be required to contract with anyone to whom the Contractor has made reasonable objection.

**§ 5.2.3** If the Owner or Architect has reasonable objection to a person or entity proposed by the Contractor, the Contractor shall propose another to whom the Owner or Architect has no reasonable objection. If the proposed but rejected Subcontractor was reasonably capable of performing the Work, the Contract Sum and Contract Time shall be increased or decreased by the difference, if any, occasioned by such change, and an appropriate Change Order shall be issued before commencement of the substitute Subcontractor's Work. However, no increase in the Contract Sum or Contract Time shall be allowed for such change unless the Contractor has acted promptly and responsively in submitting names as required.

**§ 5.2.4** The Contractor shall not substitute a Subcontractor, person, or entity for one previously selected if the Owner or Architect makes reasonable objection to such substitution.

### **§ 5.3 Subcontractual Relations**

By appropriate written agreement, the Contractor shall require each Subcontractor, to the extent of the Work to be performed by the Subcontractor, to be bound to the Contractor by terms of the Contract Documents, and to assume toward the Contractor all the obligations and responsibilities, including the responsibility for safety of the Subcontractor's Work that the Contractor, by these Contract Documents, assumes toward the Owner and Architect. Each subcontract agreement shall preserve and protect the rights of the Owner and Architect under the Contract Documents with respect to the Work to be performed by the Subcontractor so that subcontracting thereof will not prejudice such rights, and shall allow to the Subcontractor, unless specifically provided otherwise in the subcontract agreement, the benefit of all rights, remedies, and redress against the Contractor that the Contractor, by the Contract Documents, has against the Owner. Where appropriate, the Contractor shall require each Subcontractor to enter into similar agreements with Sub-subcontractors. The Contractor shall make available to each proposed Subcontractor,

prior to the execution of the subcontract agreement, copies of the Contract Documents to which the Subcontractor will be bound, and, upon written request of the Subcontractor, identify to the Subcontractor terms and conditions of the proposed subcontract agreement that may be at variance with the Contract Documents. Subcontractors will similarly make copies of applicable portions of such documents available to their respective proposed Subcontractors.

#### **§ 5.4 Contingent Assignment of Subcontracts**

**§ 5.4.1** Each subcontract agreement for a portion of the Work is assigned by the Contractor to the Owner, provided that

- .1 assignment is effective only after termination of the Contract by the Owner for cause pursuant to Section 14.2 and only for those subcontract agreements that the Owner accepts by notifying the Subcontractor and Contractor; and
- .2 assignment is subject to the prior rights of the surety, if any, obligated under bond relating to the Contract.

When the Owner accepts the assignment of a subcontract agreement, the Owner assumes the Contractor's rights and obligations under the subcontract.

**§ 5.4.2** Upon such assignment, if the Work has been suspended for more than 30 days, the Subcontractor's compensation shall be equitably adjusted for increases in cost resulting from the suspension.

**§ 5.4.3** Upon assignment to the Owner under this Section 5.4, the Owner may further assign the subcontract to a successor contractor or other entity. If the Owner assigns the subcontract to a successor contractor or other entity, the Owner shall nevertheless remain legally responsible for all of the successor contractor's obligations under the subcontract.

### **ARTICLE 6 CONSTRUCTION BY OWNER OR BY SEPARATE CONTRACTORS**

#### **§ 6.1 Owner's Right to Perform Construction and to Award Separate Contracts**

**§ 6.1.1** The term "Separate Contractor(s)" shall mean other contractors retained by the Owner under separate agreements. The Owner reserves the right to perform construction or operations related to the Project with the Owner's own forces, and with Separate Contractors retained under Conditions of the Contract substantially similar to those of this Contract, including those provisions of the Conditions of the Contract related to insurance and waiver of subrogation.

**§ 6.1.2** When separate contracts are awarded for different portions of the Project or other construction or operations on the site, the term "Contractor" in the Contract Documents in each case shall mean the Contractor who executes each separate Owner-Contractor Agreement.

**§ 6.1.3** The Owner shall provide for coordination of the activities of the Owner's own forces and of each Separate Contractor with the Work of the Contractor, who shall cooperate with them. The Contractor shall participate with any Separate Contractors and the Owner in reviewing their construction schedules. The Contractor shall make any revisions to its construction schedule deemed necessary after a joint review and mutual agreement. The construction schedules shall then constitute the schedules to be used by the Contractor, Separate Contractors, and the Owner until subsequently revised.

**§ 6.1.4** Unless otherwise provided in the Contract Documents, when the Owner performs construction or operations related to the Project with the Owner's own forces or with Separate Contractors, the Owner or its Separate Contractors shall have the same obligations and rights that the Contractor has under the Conditions of the Contract, including, without excluding others, those stated in Article 3, this Article 6, and Articles 10, 11, and 12.

#### **§ 6.2 Mutual Responsibility**

**§ 6.2.1** The Contractor shall afford the Owner and Separate Contractors reasonable opportunity for introduction and storage of their materials and equipment and performance of their activities, and shall connect and coordinate the Contractor's construction and operations with theirs as required by the Contract Documents.

**§ 6.2.2** If part of the Contractor's Work depends for proper execution or results upon construction or operations by the Owner or a Separate Contractor, the Contractor shall, prior to proceeding with that portion of the Work,



promptly notify the Architect of apparent discrepancies or defects in the construction or operations by the Owner or Separate Contractor that would render it unsuitable for proper execution and results of the Contractor's Work. Failure of the Contractor to notify the Architect of apparent discrepancies or defects prior to proceeding with the Work shall constitute an acknowledgment that the Owner's or Separate Contractor's completed or partially completed construction is fit and proper to receive the Contractor's Work. The Contractor shall not be responsible for discrepancies or defects in the construction or operations by the Owner or Separate Contractor that are not apparent.

**§ 6.2.3** The Contractor shall reimburse the Owner for costs the Owner incurs that are payable to a Separate Contractor because of the Contractor's delays, improperly timed activities or defective construction. The Owner shall be responsible to the Contractor for costs the Contractor incurs because of a Separate Contractor's delays, improperly timed activities, damage to the Work or defective construction.

**§ 6.2.4** The Contractor shall promptly remedy damage that the Contractor wrongfully causes to completed or partially completed construction or to property of the Owner or Separate Contractor as provided in Section 10.2.5.

**§ 6.2.5** The Owner and each Separate Contractor shall have the same responsibilities for cutting and patching as are described for the Contractor in Section 3.14.

### **§ 6.3 Owner's Right to Clean Up**

If a dispute arises among the Contractor, Separate Contractors, and the Owner as to the responsibility under their respective contracts for maintaining the premises and surrounding area free from waste materials and rubbish, the Owner may clean up and the Architect will allocate the cost among those responsible.

## **ARTICLE 7 CHANGES IN THE WORK**

### **§ 7.1 General**

**§ 7.1.1** Changes in the Work may be accomplished after execution of the Contract, and without invalidating the Contract, by Change Order, Construction Change Directive or order for a minor change in the Work, subject to the limitations stated in this Article 7 and elsewhere in the Contract Documents.

**§ 7.1.2** A Change Order shall be based upon agreement among the Owner, Contractor, and Architect. A Construction Change Directive requires agreement by the Owner and Architect and may or may not be agreed to by the Contractor. An order for a minor change in the Work may be issued by the Architect alone.

**§ 7.1.3** Changes in the Work shall be performed under applicable provisions of the Contract Documents. The Contractor shall proceed promptly with changes in the Work, unless otherwise provided in the Change Order, Construction Change Directive, or order for a minor change in the Work.

### **§ 7.2 Change Orders**

**§ 7.2.1** A Change Order is a written instrument prepared by the Architect and signed by the Owner, Contractor, and Architect stating their agreement upon all of the following:

- .1 The change in the Work;
- .2 The amount of the adjustment, if any, in the Contract Sum; and
- .3 The extent of the adjustment, if any, in the Contract Time.

### **§ 7.3 Construction Change Directives**

**§ 7.3.1** A Construction Change Directive is a written order prepared by the Architect and signed by the Owner and Architect, directing a change in the Work prior to agreement on adjustment, if any, in the Contract Sum or Contract Time, or both. The Owner may by Construction Change Directive, without invalidating the Contract, order changes in the Work within the general scope of the Contract consisting of additions, deletions, or other revisions, the Contract Sum and Contract Time being adjusted accordingly.

**§ 7.3.2** A Construction Change Directive shall be used in the absence of total agreement on the terms of a Change Order.

**§ 7.3.3** If the Construction Change Directive provides for an adjustment to the Contract Sum, the adjustment shall be based on one of the following methods:

Init.

- .1 Mutual acceptance of a lump sum properly itemized and supported by sufficient substantiating data to permit evaluation;
- .2 Unit prices stated in the Contract Documents or subsequently agreed upon;
- .3 Cost to be determined in a manner agreed upon by the parties and a mutually acceptable fixed or percentage fee; or
- .4 As provided in Section 7.3.4.

**§ 7.3.4** If the Contractor does not respond promptly or disagrees with the method for adjustment in the Contract Sum, the Architect shall determine the adjustment on the basis of reasonable expenditures and savings of those performing the Work attributable to the change, including, in case of an increase in the Contract Sum, an amount for overhead and profit as set forth in the Agreement, or if no such amount is set forth in the Agreement, a reasonable amount. In such case, and also under Section 7.3.3.3, the Contractor shall keep and present, in such form as the Architect may prescribe, an itemized accounting together with appropriate supporting data. Unless otherwise provided in the Contract Documents, costs for the purposes of this Section 7.3.4 shall be limited to the following:

- .1 Costs of labor, including applicable payroll taxes, fringe benefits required by agreement or custom, workers' compensation insurance, and other employee costs approved by the Architect;
- .2 Costs of materials, supplies, and equipment, including cost of transportation, whether incorporated or consumed;
- .3 Rental costs of machinery and equipment, exclusive of hand tools, whether rented from the Contractor or others;
- .4 Costs of premiums for all bonds and insurance, permit fees, and sales, use, or similar taxes, directly related to the change; and
- .5 Costs of supervision and field office personnel directly attributable to the change.

**§ 7.3.5** If the Contractor disagrees with the adjustment in the Contract Time, the Contractor may make a Claim in accordance with applicable provisions of Article 15.

**§ 7.3.6** Upon receipt of a Construction Change Directive, the Contractor shall promptly proceed with the change in the Work involved and advise the Architect of the Contractor's agreement or disagreement with the method, if any, provided in the Construction Change Directive for determining the proposed adjustment in the Contract Sum or Contract Time.

**§ 7.3.7** A Construction Change Directive signed by the Contractor indicates the Contractor's agreement therewith, including adjustment in Contract Sum and Contract Time or the method for determining them. Such agreement shall be effective immediately and shall be recorded as a Change Order.

**§ 7.3.8** The amount of credit to be allowed by the Contractor to the Owner for a deletion or change that results in a net decrease in the Contract Sum shall be actual net cost as confirmed by the Architect. When both additions and credits covering related Work or substitutions are involved in a change, the allowance for overhead and profit shall be figured on the basis of net increase, if any, with respect to that change.

**§ 7.3.9** Pending final determination of the total cost of a Construction Change Directive to the Owner, the Contractor may request payment for Work completed under the Construction Change Directive in Applications for Payment. The Architect will make an interim determination for purposes of monthly certification for payment for those costs and certify for payment the amount that the Architect determines, in the Architect's professional judgment, to be reasonably justified. The Architect's interim determination of cost shall adjust the Contract Sum on the same basis as a Change Order, subject to the right of either party to disagree and assert a Claim in accordance with Article 15.

**§ 7.3.10** When the Owner and Contractor agree with a determination made by the Architect concerning the adjustments in the Contract Sum and Contract Time, or otherwise reach agreement upon the adjustments, such agreement shall be effective immediately and the Architect will prepare a Change Order. Change Orders may be issued for all or any part of a Construction Change Directive.

#### **§ 7.4 Minor Changes in the Work**

The Architect may order minor changes in the Work that are consistent with the intent of the Contract Documents and do not involve an adjustment in the Contract Sum or an extension of the Contract Time. The Architect's order for minor changes shall be in writing. If the Contractor believes that the proposed minor change in the Work will

affect the Contract Sum or Contract Time, the Contractor shall notify the Architect and shall not proceed to implement the change in the Work. If the Contractor performs the Work set forth in the Architect's order for a minor change without prior notice to the Architect that such change will affect the Contract Sum or Contract Time, the Contractor waives any adjustment to the Contract Sum or extension of the Contract Time.

## **ARTICLE 8 TIME**

### **§ 8.1 Definitions**

**§ 8.1.1** Unless otherwise provided, Contract Time is the period of time, including authorized adjustments, allotted in the Contract Documents for Substantial Completion of the Work.

**§ 8.1.2** The date of commencement of the Work is the date established in the Agreement.

**§ 8.1.3** The date of Substantial Completion is the date certified by the Architect in accordance with Section 9.8.

**§ 8.1.4** The term "day" as used in the Contract Documents shall mean calendar day unless otherwise specifically defined.

### **§ 8.2 Progress and Completion**

**§ 8.2.1** Time limits stated in the Contract Documents are of the essence of the Contract. By executing the Agreement, the Contractor confirms that the Contract Time is a reasonable period for performing the Work.

**§ 8.2.2** The Contractor shall not knowingly, except by agreement or instruction of the Owner in writing, commence the Work prior to the effective date of insurance required to be furnished by the Contractor and Owner.

**§ 8.2.3** The Contractor shall proceed expeditiously with adequate forces and shall achieve Substantial Completion within the Contract Time.

### **§ 8.3 Delays and Extensions of Time**

**§ 8.3.1** If the Contractor is delayed at any time in the commencement or progress of the Work by (1) an act or neglect of the Owner or Architect, of an employee of either, or of a Separate Contractor; (2) by changes ordered in the Work; (3) by labor disputes, fire, unusual delay in deliveries, unavoidable casualties, adverse weather conditions documented in accordance with Section 15.1.6.2, or other causes beyond the Contractor's control; (4) by delay authorized by the Owner pending mediation and binding dispute resolution; or (5) by other causes that the Contractor asserts, and the Architect determines, justify delay, then the Contract Time shall be extended for such reasonable time as the Architect may determine.

**§ 8.3.2** Claims relating to time shall be made in accordance with applicable provisions of Article 15.

**§ 8.3.3** This Section 8.3 does not preclude recovery of damages for delay by either party under other provisions of the Contract Documents.

## **ARTICLE 9 PAYMENTS AND COMPLETION**

### **§ 9.1 Contract Sum**

**§ 9.1.1** The Contract Sum is stated in the Agreement and, including authorized adjustments, is the total amount payable by the Owner to the Contractor for performance of the Work under the Contract Documents.

**§ 9.1.2** If unit prices are stated in the Contract Documents or subsequently agreed upon, and if quantities originally contemplated are materially changed so that application of such unit prices to the actual quantities causes substantial inequity to the Owner or Contractor, the applicable unit prices shall be equitably adjusted.

### **§ 9.2 Schedule of Values**

Where the Contract is based on a stipulated sum or Guaranteed Maximum Price, the Contractor shall submit a schedule of values to the Architect before the first Application for Payment, allocating the entire Contract Sum to the various portions of the Work. The schedule of values shall be prepared in the form, and supported by the data to substantiate its accuracy, required by the Architect. This schedule, unless objected to by the Architect, shall be used as a basis for reviewing the Contractor's Applications for Payment. Any changes to the schedule of values shall be submitted to the Architect and supported by such data to substantiate its accuracy as the Architect may require, and

unless objected to by the Architect, shall be used as a basis for reviewing the Contractor's subsequent Applications for Payment.

### **§ 9.3 Applications for Payment**

**§ 9.3.1** At least ten days before the date established for each progress payment, the Contractor shall submit to the Architect an itemized Application for Payment prepared in accordance with the schedule of values, if required under Section 9.2, for completed portions of the Work. The application shall be notarized, if required, and supported by all data substantiating the Contractor's right to payment that the Owner or Architect require, such as copies of requisitions, and releases and waivers of liens from Subcontractors and suppliers, and shall reflect retainage if provided for in the Contract Documents.

**§ 9.3.1.1** As provided in Section 7.3.9, such applications may include requests for payment on account of changes in the Work that have been properly authorized by Construction Change Directives, or by interim determinations of the Architect, but not yet included in Change Orders.

**§ 9.3.1.2** Applications for Payment shall not include requests for payment for portions of the Work for which the Contractor does not intend to pay a Subcontractor or supplier, unless such Work has been performed by others whom the Contractor intends to pay.

**§ 9.3.2** Unless otherwise provided in the Contract Documents, payments shall be made on account of materials and equipment delivered and suitably stored at the site for subsequent incorporation in the Work. If approved in advance by the Owner, payment may similarly be made for materials and equipment suitably stored off the site at a location agreed upon in writing. Payment for materials and equipment stored on or off the site shall be conditioned upon compliance by the Contractor with procedures satisfactory to the Owner to establish the Owner's title to such materials and equipment or otherwise protect the Owner's interest, and shall include the costs of applicable insurance, storage, and transportation to the site, for such materials and equipment stored off the site.

**§ 9.3.3** The Contractor warrants that title to all Work covered by an Application for Payment will pass to the Owner no later than the time of payment. The Contractor further warrants that upon submittal of an Application for Payment all Work for which Certificates for Payment have been previously issued and payments received from the Owner shall, to the best of the Contractor's knowledge, information, and belief, be free and clear of liens, claims, security interests, or encumbrances, in favor of the Contractor, Subcontractors, suppliers, or other persons or entities that provided labor, materials, and equipment relating to the Work.

### **§ 9.4 Certificates for Payment**

**§ 9.4.1** The Architect will, within seven days after receipt of the Contractor's Application for Payment, either (1) issue to the Owner a Certificate for Payment in the full amount of the Application for Payment, with a copy to the Contractor; or (2) issue to the Owner a Certificate for Payment for such amount as the Architect determines is properly due, and notify the Contractor and Owner of the Architect's reasons for withholding certification in part as provided in Section 9.5.1; or (3) withhold certification of the entire Application for Payment, and notify the Contractor and Owner of the Architect's reason for withholding certification in whole as provided in Section 9.5.1.

**§ 9.4.2** The issuance of a Certificate for Payment will constitute a representation by the Architect to the Owner, based on the Architect's evaluation of the Work and the data in the Application for Payment, that, to the best of the Architect's knowledge, information, and belief, the Work has progressed to the point indicated, the quality of the Work is in accordance with the Contract Documents, and that the Contractor is entitled to payment in the amount certified. The foregoing representations are subject to an evaluation of the Work for conformance with the Contract Documents upon Substantial Completion, to results of subsequent tests and inspections, to correction of minor deviations from the Contract Documents prior to completion, and to specific qualifications expressed by the Architect. However, the issuance of a Certificate for Payment will not be a representation that the Architect has (1) made exhaustive or continuous on-site inspections to check the quality or quantity of the Work; (2) reviewed construction means, methods, techniques, sequences, or procedures; (3) reviewed copies of requisitions received from Subcontractors and suppliers and other data requested by the Owner to substantiate the Contractor's right to payment; or (4) made examination to ascertain how or for what purpose the Contractor has used money previously paid on account of the Contract Sum.



## § 9.5 Decisions to Withhold Certification

§ 9.5.1 The Architect may withhold a Certificate for Payment in whole or in part, to the extent reasonably necessary to protect the Owner, if in the Architect's opinion the representations to the Owner required by Section 9.4.2 cannot be made. If the Architect is unable to certify payment in the amount of the Application, the Architect will notify the Contractor and Owner as provided in Section 9.4.1. If the Contractor and Architect cannot agree on a revised amount, the Architect will promptly issue a Certificate for Payment for the amount for which the Architect is able to make such representations to the Owner. The Architect may also withhold a Certificate for Payment or, because of subsequently discovered evidence, may nullify the whole or a part of a Certificate for Payment previously issued, to such extent as may be necessary in the Architect's opinion to protect the Owner from loss for which the Contractor is responsible, including loss resulting from acts and omissions described in Section 3.3.2, because of

- .1 defective Work not remedied;
- .2 third party claims filed or reasonable evidence indicating probable filing of such claims, unless security acceptable to the Owner is provided by the Contractor;
- .3 failure of the Contractor to make payments properly to Subcontractors or suppliers for labor, materials or equipment;
- .4 reasonable evidence that the Work cannot be completed for the unpaid balance of the Contract Sum;
- .5 damage to the Owner or a Separate Contractor;
- .6 reasonable evidence that the Work will not be completed within the Contract Time, and that the unpaid balance would not be adequate to cover actual or liquidated damages for the anticipated delay; or
- .7 repeated failure to carry out the Work in accordance with the Contract Documents.

§ 9.5.2 When either party disputes the Architect's decision regarding a Certificate for Payment under Section 9.5.1, in whole or in part, that party may submit a Claim in accordance with Article 15.

§ 9.5.3 When the reasons for withholding certification are removed, certification will be made for amounts previously withheld.

§ 9.5.4 If the Architect withholds certification for payment under Section 9.5.1.3, the Owner may, at its sole option, issue joint checks to the Contractor and to any Subcontractor or supplier to whom the Contractor failed to make payment for Work properly performed or material or equipment suitably delivered. If the Owner makes payments by joint check, the Owner shall notify the Architect and the Contractor shall reflect such payment on its next Application for Payment.

## § 9.6 Progress Payments

§ 9.6.1 After the Architect has issued a Certificate for Payment, the Owner shall make payment in the manner and within the time provided in the Contract Documents, and shall so notify the Architect.

§ 9.6.2 The Contractor shall pay each Subcontractor, no later than seven days after receipt of payment from the Owner, the amount to which the Subcontractor is entitled, reflecting percentages actually retained from payments to the Contractor on account of the Subcontractor's portion of the Work. The Contractor shall, by appropriate agreement with each Subcontractor, require each Subcontractor to make payments to Sub-subcontractors in a similar manner.

§ 9.6.3 The Architect will, on request, furnish to a Subcontractor, if practicable, information regarding percentages of completion or amounts applied for by the Contractor and action taken thereon by the Architect and Owner on account of portions of the Work done by such Subcontractor.

§ 9.6.4 The Owner has the right to request written evidence from the Contractor that the Contractor has properly paid Subcontractors and suppliers amounts paid by the Owner to the Contractor for subcontracted Work. If the Contractor fails to furnish such evidence within seven days, the Owner shall have the right to contact Subcontractors and suppliers to ascertain whether they have been properly paid. Neither the Owner nor Architect shall have an obligation to pay, or to see to the payment of money to, a Subcontractor or supplier, except as may otherwise be required by law.

§ 9.6.5 The Contractor's payments to suppliers shall be treated in a manner similar to that provided in Sections 9.6.2, 9.6.3 and 9.6.4.

**§ 9.6.6** A Certificate for Payment, a progress payment, or partial or entire use or occupancy of the Project by the Owner shall not constitute acceptance of Work not in accordance with the Contract Documents.

**§ 9.6.7** Unless the Contractor provides the Owner with a payment bond in the full penal sum of the Contract Sum, payments received by the Contractor for Work properly performed by Subcontractors or provided by suppliers shall be held by the Contractor for those Subcontractors or suppliers who performed Work or furnished materials, or both, under contract with the Contractor for which payment was made by the Owner. Nothing contained herein shall require money to be placed in a separate account and not commingled with money of the Contractor, create any fiduciary liability or tort liability on the part of the Contractor for breach of trust, or entitle any person or entity to an award of punitive damages against the Contractor for breach of the requirements of this provision.

**§ 9.6.8** Provided the Owner has fulfilled its payment obligations under the Contract Documents, the Contractor shall defend and indemnify the Owner from all loss, liability, damage or expense, including reasonable attorney's fees and litigation expenses, arising out of any lien claim or other claim for payment by any Subcontractor or supplier of any tier. Upon receipt of notice of a lien claim or other claim for payment, the Owner shall notify the Contractor. If approved by the applicable court, when required, the Contractor may substitute a surety bond for the property against which the lien or other claim for payment has been asserted.

### **§ 9.7 Failure of Payment**

If the Architect does not issue a Certificate for Payment, through no fault of the Contractor, within seven days after receipt of the Contractor's Application for Payment, or if the Owner does not pay the Contractor within seven days after the date established in the Contract Documents, the amount certified by the Architect or awarded by binding dispute resolution, then the Contractor may, upon seven additional days' notice to the Owner and Architect, stop the Work until payment of the amount owing has been received. The Contract Time shall be extended appropriately and the Contract Sum shall be increased by the amount of the Contractor's reasonable costs of shutdown, delay and start-up, plus interest as provided for in the Contract Documents.

### **§ 9.8 Substantial Completion**

**§ 9.8.1** Substantial Completion is the stage in the progress of the Work when the Work or designated portion thereof is sufficiently complete in accordance with the Contract Documents so that the Owner can occupy or utilize the Work for its intended use.

**§ 9.8.2** When the Contractor considers that the Work, or a portion thereof which the Owner agrees to accept separately, is substantially complete, the Contractor shall prepare and submit to the Architect a comprehensive list of items to be completed or corrected prior to final payment. Failure to include an item on such list does not alter the responsibility of the Contractor to complete all Work in accordance with the Contract Documents.

**§ 9.8.3** Upon receipt of the Contractor's list, the Architect will make an inspection to determine whether the Work or designated portion thereof is substantially complete. If the Architect's inspection discloses any item, whether or not included on the Contractor's list, which is not sufficiently complete in accordance with the Contract Documents so that the Owner can occupy or utilize the Work or designated portion thereof for its intended use, the Contractor shall, before issuance of the Certificate of Substantial Completion, complete or correct such item upon notification by the Architect. In such case, the Contractor shall then submit a request for another inspection by the Architect to determine Substantial Completion.

**§ 9.8.4** When the Work or designated portion thereof is substantially complete, the Architect will prepare a Certificate of Substantial Completion that shall establish the date of Substantial Completion; establish responsibilities of the Owner and Contractor for security, maintenance, heat, utilities, damage to the Work and insurance; and fix the time within which the Contractor shall finish all items on the list accompanying the Certificate. Warranties required by the Contract Documents shall commence on the date of Substantial Completion of the Work or designated portion thereof unless otherwise provided in the Certificate of Substantial Completion.

**§ 9.8.5** The Certificate of Substantial Completion shall be submitted to the Owner and Contractor for their written acceptance of responsibilities assigned to them in the Certificate. Upon such acceptance, and consent of surety if any, the Owner shall make payment of retainage applying to the Work or designated portion thereof. Such payment shall be adjusted for Work that is incomplete or not in accordance with the requirements of the Contract Documents.

## **§ 9.9 Partial Occupancy or Use**

**§ 9.9.1** The Owner may occupy or use any completed or partially completed portion of the Work at any stage when such portion is designated by separate agreement with the Contractor, provided such occupancy or use is consented to by the insurer and authorized by public authorities having jurisdiction over the Project. Such partial occupancy or use may commence whether or not the portion is substantially complete, provided the Owner and Contractor have accepted in writing the responsibilities assigned to each of them for payments, retainage, if any, security, maintenance, heat, utilities, damage to the Work and insurance, and have agreed in writing concerning the period for correction of the Work and commencement of warranties required by the Contract Documents. When the Contractor considers a portion substantially complete, the Contractor shall prepare and submit a list to the Architect as provided under Section 9.8.2. Consent of the Contractor to partial occupancy or use shall not be unreasonably withheld. The stage of the progress of the Work shall be determined by written agreement between the Owner and Contractor or, if no agreement is reached, by decision of the Architect.

**§ 9.9.2** Immediately prior to such partial occupancy or use, the Owner, Contractor, and Architect shall jointly inspect the area to be occupied or portion of the Work to be used in order to determine and record the condition of the Work.

**§ 9.9.3** Unless otherwise agreed upon, partial occupancy or use of a portion or portions of the Work shall not constitute acceptance of Work not complying with the requirements of the Contract Documents.

## **§ 9.10 Final Completion and Final Payment**

**§ 9.10.1** Upon receipt of the Contractor's notice that the Work is ready for final inspection and acceptance and upon receipt of a final Application for Payment, the Architect will promptly make such inspection. When the Architect finds the Work acceptable under the Contract Documents and the Contract fully performed, the Architect will promptly issue a final Certificate for Payment stating that to the best of the Architect's knowledge, information and belief, and on the basis of the Architect's on-site visits and inspections, the Work has been completed in accordance with the Contract Documents and that the entire balance found to be due the Contractor and noted in the final Certificate is due and payable. The Architect's final Certificate for Payment will constitute a further representation that conditions listed in Section 9.10.2 as precedent to the Contractor's being entitled to final payment have been fulfilled.

**§ 9.10.2** Neither final payment nor any remaining retained percentage shall become due until the Contractor submits to the Architect (1) an affidavit that payrolls, bills for materials and equipment, and other indebtedness connected with the Work for which the Owner or the Owner's property might be responsible or encumbered (less amounts withheld by Owner) have been paid or otherwise satisfied, (2) a certificate evidencing that insurance required by the Contract Documents to remain in force after final payment is currently in effect, (3) a written statement that the Contractor knows of no reason that the insurance will not be renewable to cover the period required by the Contract Documents, (4) consent of surety, if any, to final payment, (5) documentation of any special warranties, such as manufacturers' warranties or specific Subcontractor warranties, and (6) if required by the Owner, other data establishing payment or satisfaction of obligations, such as receipts and releases and waivers of liens, claims, security interests, or encumbrances arising out of the Contract, to the extent and in such form as may be designated by the Owner. If a Subcontractor refuses to furnish a release or waiver required by the Owner, the Contractor may furnish a bond satisfactory to the Owner to indemnify the Owner against such lien, claim, security interest, or encumbrance. If a lien, claim, security interest, or encumbrance remains unsatisfied after payments are made, the Contractor shall refund to the Owner all money that the Owner may be compelled to pay in discharging the lien, claim, security interest, or encumbrance, including all costs and reasonable attorneys' fees.

**§ 9.10.3** If, after Substantial Completion of the Work, final completion thereof is materially delayed through no fault of the Contractor or by issuance of Change Orders affecting final completion, and the Architect so confirms, the Owner shall, upon application by the Contractor and certification by the Architect, and without terminating the Contract, make payment of the balance due for that portion of the Work fully completed, corrected, and accepted. If the remaining balance for Work not fully completed or corrected is less than retainage stipulated in the Contract Documents, and if bonds have been furnished, the written consent of the surety to payment of the balance due for that portion of the Work fully completed and accepted shall be submitted by the Contractor to the Architect prior to certification of such payment. Such payment shall be made under terms and conditions governing final payment, except that it shall not constitute a waiver of Claims.

**§ 9.10.4** The making of final payment shall constitute a waiver of Claims by the Owner except those arising from

- .1 liens, Claims, security interests, or encumbrances arising out of the Contract and unsettled;
- .2 failure of the Work to comply with the requirements of the Contract Documents;
- .3 terms of special warranties required by the Contract Documents; or
- .4 audits performed by the Owner, if permitted by the Contract Documents, after final payment.

**§ 9.10.5** Acceptance of final payment by the Contractor, a Subcontractor, or a supplier, shall constitute a waiver of claims by that payee except those previously made in writing and identified by that payee as unsettled at the time of final Application for Payment.

## **ARTICLE 10 PROTECTION OF PERSONS AND PROPERTY**

### **§ 10.1 Safety Precautions and Programs**

The Contractor shall be responsible for initiating, maintaining, and supervising all safety precautions and programs in connection with the performance of the Contract.

### **§ 10.2 Safety of Persons and Property**

**§ 10.2.1** The Contractor shall take reasonable precautions for safety of, and shall provide reasonable protection to prevent damage, injury, or loss to

- .1 employees on the Work and other persons who may be affected thereby;
- .2 the Work and materials and equipment to be incorporated therein, whether in storage on or off the site, under care, custody, or control of the Contractor, a Subcontractor, or a Sub-subcontractor; and
- .3 other property at the site or adjacent thereto, such as trees, shrubs, lawns, walks, pavements, roadways, structures, and utilities not designated for removal, relocation, or replacement in the course of construction.

**§ 10.2.2** The Contractor shall comply with, and give notices required by applicable laws, statutes, ordinances, codes, rules and regulations, and lawful orders of public authorities, bearing on safety of persons or property or their protection from damage, injury, or loss.

**§ 10.2.3** The Contractor shall implement, erect, and maintain, as required by existing conditions and performance of the Contract, reasonable safeguards for safety and protection, including posting danger signs and other warnings against hazards; promulgating safety regulations; and notifying the owners and users of adjacent sites and utilities of the safeguards.

**§ 10.2.4** When use or storage of explosives or other hazardous materials or equipment, or unusual methods are necessary for execution of the Work, the Contractor shall exercise utmost care and carry on such activities under supervision of properly qualified personnel.

**§ 10.2.5** The Contractor shall promptly remedy damage and loss (other than damage or loss insured under property insurance required by the Contract Documents) to property referred to in Sections 10.2.1.2 and 10.2.1.3 caused in whole or in part by the Contractor, a Subcontractor, a Sub-subcontractor, or anyone directly or indirectly employed by any of them, or by anyone for whose acts they may be liable and for which the Contractor is responsible under Sections 10.2.1.2 and 10.2.1.3. The Contractor may make a Claim for the cost to remedy the damage or loss to the extent such damage or loss is attributable to acts or omissions of the Owner or Architect or anyone directly or indirectly employed by either of them, or by anyone for whose acts either of them may be liable, and not attributable to the fault or negligence of the Contractor. The foregoing obligations of the Contractor are in addition to the Contractor's obligations under Section 3.18.

**§ 10.2.6** The Contractor shall designate a responsible member of the Contractor's organization at the site whose duty shall be the prevention of accidents. This person shall be the Contractor's superintendent unless otherwise designated by the Contractor in writing to the Owner and Architect.

**§ 10.2.7** The Contractor shall not permit any part of the construction or site to be loaded so as to cause damage or create an unsafe condition.



### **§ 10.2.8 Injury or Damage to Person or Property**

If either party suffers injury or damage to person or property because of an act or omission of the other party, or of others for whose acts such party is legally responsible, notice of the injury or damage, whether or not insured, shall be given to the other party within a reasonable time not exceeding 21 days after discovery. The notice shall provide sufficient detail to enable the other party to investigate the matter.

### **§ 10.3 Hazardous Materials and Substances**

**§ 10.3.1** The Contractor is responsible for compliance with any requirements included in the Contract Documents regarding hazardous materials or substances. If the Contractor encounters a hazardous material or substance not addressed in the Contract Documents and if reasonable precautions will be inadequate to prevent foreseeable bodily injury or death to persons resulting from a material or substance, including but not limited to asbestos or polychlorinated biphenyl (PCB), encountered on the site by the Contractor, the Contractor shall, upon recognizing the condition, immediately stop Work in the affected area and notify the Owner and Architect of the condition.

**§ 10.3.2** Upon receipt of the Contractor's notice, the Owner shall obtain the services of a licensed laboratory to verify the presence or absence of the material or substance reported by the Contractor and, in the event such material or substance is found to be present, to cause it to be rendered harmless. Unless otherwise required by the Contract Documents, the Owner shall furnish in writing to the Contractor and Architect the names and qualifications of persons or entities who are to perform tests verifying the presence or absence of the material or substance or who are to perform the task of removal or safe containment of the material or substance. The Contractor and the Architect will promptly reply to the Owner in writing stating whether or not either has reasonable objection to the persons or entities proposed by the Owner. If either the Contractor or Architect has an objection to a person or entity proposed by the Owner, the Owner shall propose another to whom the Contractor and the Architect have no reasonable objection. When the material or substance has been rendered harmless, Work in the affected area shall resume upon written agreement of the Owner and Contractor. By Change Order, the Contract Time shall be extended appropriately and the Contract Sum shall be increased by the amount of the Contractor's reasonable additional costs of shutdown, delay, and start-up.

**§ 10.3.3** To the fullest extent permitted by law, the Owner shall indemnify and hold harmless the Contractor, Subcontractors, Architect, Architect's consultants, and agents and employees of any of them from and against claims, damages, losses, and expenses, including but not limited to attorneys' fees, arising out of or resulting from performance of the Work in the affected area if in fact the material or substance presents the risk of bodily injury or death as described in Section 10.3.1 and has not been rendered harmless, provided that such claim, damage, loss, or expense is attributable to bodily injury, sickness, disease or death, or to injury to or destruction of tangible property (other than the Work itself), except to the extent that such damage, loss, or expense is due to the fault or negligence of the party seeking indemnity.

**§ 10.3.4** The Owner shall not be responsible under this Section 10.3 for hazardous materials or substances the Contractor brings to the site unless such materials or substances are required by the Contract Documents. The Owner shall be responsible for hazardous materials or substances required by the Contract Documents, except to the extent of the Contractor's fault or negligence in the use and handling of such materials or substances.

**§ 10.3.5** The Contractor shall reimburse the Owner for the cost and expense the Owner incurs (1) for remediation of hazardous materials or substances the Contractor brings to the site and negligently handles, or (2) where the Contractor fails to perform its obligations under Section 10.3.1, except to the extent that the cost and expense are due to the Owner's fault or negligence.

**§ 10.3.6** If, without negligence on the part of the Contractor, the Contractor is held liable by a government agency for the cost of remediation of a hazardous material or substance solely by reason of performing Work as required by the Contract Documents, the Owner shall reimburse the Contractor for all cost and expense thereby incurred.

### **§ 10.4 Emergencies**

In an emergency affecting safety of persons or property, the Contractor shall act, at the Contractor's discretion, to prevent threatened damage, injury, or loss. Additional compensation or extension of time claimed by the Contractor on account of an emergency shall be determined as provided in Article 15 and Article 7.

## ARTICLE 11 INSURANCE AND BONDS

### § 11.1 Contractor's Insurance and Bonds

§ 11.1.1 The Contractor shall purchase and maintain insurance of the types and limits of liability, containing the endorsements, and subject to the terms and conditions, as described in the Agreement or elsewhere in the Contract Documents. The Contractor shall purchase and maintain the required insurance from an insurance company or insurance companies lawfully authorized to issue insurance in the jurisdiction where the Project is located. The Owner, Architect, and Architect's consultants shall be named as additional insureds under the Contractor's commercial general liability policy or as otherwise described in the Contract Documents.

§ 11.1.2 The Contractor shall provide surety bonds of the types, for such penal sums, and subject to such terms and conditions as required by the Contract Documents. The Contractor shall purchase and maintain the required bonds from a company or companies lawfully authorized to issue surety bonds in the jurisdiction where the Project is located.

§ 11.1.3 Upon the request of any person or entity appearing to be a potential beneficiary of bonds covering payment of obligations arising under the Contract, the Contractor shall promptly furnish a copy of the bonds or shall authorize a copy to be furnished.

§ 11.1.4 **Notice of Cancellation or Expiration of Contractor's Required Insurance.** Within three (3) business days of the date the Contractor becomes aware of an impending or actual cancellation or expiration of any insurance required by the Contract Documents, the Contractor shall provide notice to the Owner of such impending or actual cancellation or expiration. Upon receipt of notice from the Contractor, the Owner shall, unless the lapse in coverage arises from an act or omission of the Owner, have the right to stop the Work until the lapse in coverage has been cured by the procurement of replacement coverage by the Contractor. The furnishing of notice by the Contractor shall not relieve the Contractor of any contractual obligation to provide any required coverage.

### § 11.2 Owner's Insurance

§ 11.2.1 The Owner shall purchase and maintain insurance of the types and limits of liability, containing the endorsements, and subject to the terms and conditions, as described in the Agreement or elsewhere in the Contract Documents. The Owner shall purchase and maintain the required insurance from an insurance company or insurance companies lawfully authorized to issue insurance in the jurisdiction where the Project is located.

§ 11.2.2 **Failure to Purchase Required Property Insurance.** If the Owner fails to purchase and maintain the required property insurance, with all of the coverages and in the amounts described in the Agreement or elsewhere in the Contract Documents, the Owner shall inform the Contractor in writing prior to commencement of the Work. Upon receipt of notice from the Owner, the Contractor may delay commencement of the Work and may obtain insurance that will protect the interests of the Contractor, Subcontractors, and Sub-Subcontractors in the Work. When the failure to provide coverage has been cured or resolved, the Contract Sum and Contract Time shall be equitably adjusted. In the event the Owner fails to procure coverage, the Owner waives all rights against the Contractor, Subcontractors, and Sub-subcontractors to the extent the loss to the Owner would have been covered by the insurance to have been procured by the Owner. The cost of the insurance shall be charged to the Owner by a Change Order. If the Owner does not provide written notice, and the Contractor is damaged by the failure or neglect of the Owner to purchase or maintain the required insurance, the Owner shall reimburse the Contractor for all reasonable costs and damages attributable thereto.

§ 11.2.3 **Notice of Cancellation or Expiration of Owner's Required Property Insurance.** Within three (3) business days of the date the Owner becomes aware of an impending or actual cancellation or expiration of any property insurance required by the Contract Documents, the Owner shall provide notice to the Contractor of such impending or actual cancellation or expiration. Unless the lapse in coverage arises from an act or omission of the Contractor: (1) the Contractor, upon receipt of notice from the Owner, shall have the right to stop the Work until the lapse in coverage has been cured by the procurement of replacement coverage by either the Owner or the Contractor; (2) the Contract Time and Contract Sum shall be equitably adjusted; and (3) the Owner waives all rights against the Contractor, Subcontractors, and Sub-subcontractors to the extent any loss to the Owner would have been covered by the insurance had it not expired or been cancelled. If the Contractor purchases replacement coverage, the cost of the insurance shall be charged to the Owner by an appropriate Change Order. The furnishing of notice by the Owner shall not relieve the Owner of any contractual obligation to provide required insurance.

Init.

### **§ 11.3 Waivers of Subrogation**

**§ 11.3.1** The Owner and Contractor waive all rights against (1) each other and any of their subcontractors, sub-subcontractors, agents, and employees, each of the other; (2) the Architect and Architect's consultants; and (3) Separate Contractors, if any, and any of their subcontractors, sub-subcontractors, agents, and employees, for damages caused by fire, or other causes of loss, to the extent those losses are covered by property insurance required by the Agreement or other property insurance applicable to the Project, except such rights as they have to proceeds of such insurance. The Owner or Contractor, as appropriate, shall require similar written waivers in favor of the individuals and entities identified above from the Architect, Architect's consultants, Separate Contractors, subcontractors, and sub-subcontractors. The policies of insurance purchased and maintained by each person or entity agreeing to waive claims pursuant to this section 11.3.1 shall not prohibit this waiver of subrogation. This waiver of subrogation shall be effective as to a person or entity (1) even though that person or entity would otherwise have a duty of indemnification, contractual or otherwise, (2) even though that person or entity did not pay the insurance premium directly or indirectly, or (3) whether or not the person or entity had an insurable interest in the damaged property.

**§ 11.3.2** If during the Project construction period the Owner insures properties, real or personal or both, at or adjacent to the site by property insurance under policies separate from those insuring the Project, or if after final payment property insurance is to be provided on the completed Project through a policy or policies other than those insuring the Project during the construction period, to the extent permissible by such policies, the Owner waives all rights in accordance with the terms of Section 11.3.1 for damages caused by fire or other causes of loss covered by this separate property insurance.

### **§ 11.4 Loss of Use, Business Interruption, and Delay in Completion Insurance**

The Owner, at the Owner's option, may purchase and maintain insurance that will protect the Owner against loss of use of the Owner's property, or the inability to conduct normal operations, due to fire or other causes of loss. The Owner waives all rights of action against the Contractor and Architect for loss of use of the Owner's property, due to fire or other hazards however caused.

### **§ 11.5 Adjustment and Settlement of Insured Loss**

**§ 11.5.1** A loss insured under the property insurance required by the Agreement shall be adjusted by the Owner as fiduciary and made payable to the Owner as fiduciary for the insureds, as their interests may appear, subject to requirements of any applicable mortgagee clause and of Section 11.5.2. The Owner shall pay the Architect and Contractor their just shares of insurance proceeds received by the Owner, and by appropriate agreements the Architect and Contractor shall make payments to their consultants and Subcontractors in similar manner.

**§ 11.5.2** Prior to settlement of an insured loss, the Owner shall notify the Contractor of the terms of the proposed settlement as well as the proposed allocation of the insurance proceeds. The Contractor shall have 14 days from receipt of notice to object to the proposed settlement or allocation of the proceeds. If the Contractor does not object, the Owner shall settle the loss and the Contractor shall be bound by the settlement and allocation. Upon receipt, the Owner shall deposit the insurance proceeds in a separate account and make the appropriate distributions. Thereafter, if no other agreement is made or the Owner does not terminate the Contract for convenience, the Owner and Contractor shall execute a Change Order for reconstruction of the damaged or destroyed Work in the amount allocated for that purpose. If the Contractor timely objects to either the terms of the proposed settlement or the allocation of the proceeds, the Owner may proceed to settle the insured loss, and any dispute between the Owner and Contractor arising out of the settlement or allocation of the proceeds shall be resolved pursuant to Article 15. Pending resolution of any dispute, the Owner may issue a Construction Change Directive for the reconstruction of the damaged or destroyed Work.

## **ARTICLE 12 UNCOVERING AND CORRECTION OF WORK**

### **§ 12.1 Uncovering of Work**

**§ 12.1.1** If a portion of the Work is covered contrary to the Architect's request or to requirements specifically expressed in the Contract Documents, it must, if requested in writing by the Architect, be uncovered for the Architect's examination and be replaced at the Contractor's expense without change in the Contract Time.

**§ 12.1.2** If a portion of the Work has been covered that the Architect has not specifically requested to examine prior to its being covered, the Architect may request to see such Work and it shall be uncovered by the Contractor. If such Work is in accordance with the Contract Documents, the Contractor shall be entitled to an equitable adjustment to

Init.

the Contract Sum and Contract Time as may be appropriate. If such Work is not in accordance with the Contract Documents, the costs of uncovering the Work, and the cost of correction, shall be at the Contractor's expense.

## **§ 12.2 Correction of Work**

### **§ 12.2.1 Before Substantial Completion**

The Contractor shall promptly correct Work rejected by the Architect or failing to conform to the requirements of the Contract Documents, discovered before Substantial Completion and whether or not fabricated, installed or completed. Costs of correcting such rejected Work, including additional testing and inspections, the cost of uncovering and replacement, and compensation for the Architect's services and expenses made necessary thereby, shall be at the Contractor's expense.

### **§ 12.2.2 After Substantial Completion**

**§ 12.2.2.1** In addition to the Contractor's obligations under Section 3.5, if, within one year after the date of Substantial Completion of the Work or designated portion thereof or after the date for commencement of warranties established under Section 9.9.1, or by terms of any applicable special warranty required by the Contract Documents, any of the Work is found to be not in accordance with the requirements of the Contract Documents, the Contractor shall correct it promptly after receipt of notice from the Owner to do so, unless the Owner has previously given the Contractor a written acceptance of such condition. The Owner shall give such notice promptly after discovery of the condition. During the one-year period for correction of Work, if the Owner fails to notify the Contractor and give the Contractor an opportunity to make the correction, the Owner waives the rights to require correction by the Contractor and to make a claim for breach of warranty. If the Contractor fails to correct nonconforming Work within a reasonable time during that period after receipt of notice from the Owner or Architect, the Owner may correct it in accordance with Section 2.5.

**§ 12.2.2.2** The one-year period for correction of Work shall be extended with respect to portions of Work first performed after Substantial Completion by the period of time between Substantial Completion and the actual completion of that portion of the Work.

**§ 12.2.2.3** The one-year period for correction of Work shall not be extended by corrective Work performed by the Contractor pursuant to this Section 12.2.

**§ 12.2.3** The Contractor shall remove from the site portions of the Work that are not in accordance with the requirements of the Contract Documents and are neither corrected by the Contractor nor accepted by the Owner.

**§ 12.2.4** The Contractor shall bear the cost of correcting destroyed or damaged construction of the Owner or Separate Contractors, whether completed or partially completed, caused by the Contractor's correction or removal of Work that is not in accordance with the requirements of the Contract Documents.

**§ 12.2.5** Nothing contained in this Section 12.2 shall be construed to establish a period of limitation with respect to other obligations the Contractor has under the Contract Documents. Establishment of the one-year period for correction of Work as described in Section 12.2.2 relates only to the specific obligation of the Contractor to correct the Work, and has no relationship to the time within which the obligation to comply with the Contract Documents may be sought to be enforced, nor to the time within which proceedings may be commenced to establish the Contractor's liability with respect to the Contractor's obligations other than specifically to correct the Work.

## **§ 12.3 Acceptance of Nonconforming Work**

If the Owner prefers to accept Work that is not in accordance with the requirements of the Contract Documents, the Owner may do so instead of requiring its removal and correction, in which case the Contract Sum will be reduced as appropriate and equitable. Such adjustment shall be effected whether or not final payment has been made.

## **ARTICLE 13 MISCELLANEOUS PROVISIONS**

### **§ 13.1 Governing Law**

The Contract shall be governed by the law of the place where the Project is located, excluding that jurisdiction's choice of law rules. If the parties have selected arbitration as the method of binding dispute resolution, the Federal Arbitration Act shall govern Section 15.4.



## § 13.2 Successors and Assigns

§ 13.2.1 The Owner and Contractor respectively bind themselves, their partners, successors, assigns, and legal representatives to covenants, agreements, and obligations contained in the Contract Documents. Except as provided in Section 13.2.2, neither party to the Contract shall assign the Contract as a whole without written consent of the other. If either party attempts to make an assignment without such consent, that party shall nevertheless remain legally responsible for all obligations under the Contract.

§ 13.2.2 The Owner may, without consent of the Contractor, assign the Contract to a lender providing construction financing for the Project, if the lender assumes the Owner's rights and obligations under the Contract Documents. The Contractor shall execute all consents reasonably required to facilitate the assignment.

## § 13.3 Rights and Remedies

§ 13.3.1 Duties and obligations imposed by the Contract Documents and rights and remedies available thereunder shall be in addition to and not a limitation of duties, obligations, rights, and remedies otherwise imposed or available by law.

§ 13.3.2 No action or failure to act by the Owner, Architect, or Contractor shall constitute a waiver of a right or duty afforded them under the Contract, nor shall such action or failure to act constitute approval of or acquiescence in a breach thereunder, except as may be specifically agreed upon in writing.

## § 13.4 Tests and Inspections

§ 13.4.1 Tests, inspections, and approvals of portions of the Work shall be made as required by the Contract Documents and by applicable laws, statutes, ordinances, codes, rules, and regulations or lawful orders of public authorities. Unless otherwise provided, the Contractor shall make arrangements for such tests, inspections, and approvals with an independent testing laboratory or entity acceptable to the Owner, or with the appropriate public authority, and shall bear all related costs of tests, inspections, and approvals. The Contractor shall give the Architect timely notice of when and where tests and inspections are to be made so that the Architect may be present for such procedures. The Owner shall bear costs of tests, inspections, or approvals that do not become requirements until after bids are received or negotiations concluded. The Owner shall directly arrange and pay for tests, inspections, or approvals where building codes or applicable laws or regulations so require.

§ 13.4.2 If the Architect, Owner, or public authorities having jurisdiction determine that portions of the Work require additional testing, inspection, or approval not included under Section 13.4.1, the Architect will, upon written authorization from the Owner, instruct the Contractor to make arrangements for such additional testing, inspection, or approval, by an entity acceptable to the Owner, and the Contractor shall give timely notice to the Architect of when and where tests and inspections are to be made so that the Architect may be present for such procedures. Such costs, except as provided in Section 13.4.3, shall be at the Owner's expense.

§ 13.4.3 If procedures for testing, inspection, or approval under Sections 13.4.1 and 13.4.2 reveal failure of the portions of the Work to comply with requirements established by the Contract Documents, all costs made necessary by such failure, including those of repeated procedures and compensation for the Architect's services and expenses, shall be at the Contractor's expense.

§ 13.4.4 Required certificates of testing, inspection, or approval shall, unless otherwise required by the Contract Documents, be secured by the Contractor and promptly delivered to the Architect.

§ 13.4.5 If the Architect is to observe tests, inspections, or approvals required by the Contract Documents, the Architect will do so promptly and, where practicable, at the normal place of testing.

§ 13.4.6 Tests or inspections conducted pursuant to the Contract Documents shall be made promptly to avoid unreasonable delay in the Work.

## § 13.5 Interest

Payments due and unpaid under the Contract Documents shall bear interest from the date payment is due at the rate the parties agree upon in writing or, in the absence thereof, at the legal rate prevailing from time to time at the place where the Project is located.

## ARTICLE 14 TERMINATION OR SUSPENSION OF THE CONTRACT

### § 14.1 Termination by the Contractor

§ 14.1.1 The Contractor may terminate the Contract if the Work is stopped for a period of 30 consecutive days through no act or fault of the Contractor, a Subcontractor, a Sub-subcontractor, their agents or employees, or any other persons or entities performing portions of the Work, for any of the following reasons:

- .1 Issuance of an order of a court or other public authority having jurisdiction that requires all Work to be stopped;
- .2 An act of government, such as a declaration of national emergency, that requires all Work to be stopped;
- .3 Because the Architect has not issued a Certificate for Payment and has not notified the Contractor of the reason for withholding certification as provided in Section 9.4.1, or because the Owner has not made payment on a Certificate for Payment within the time stated in the Contract Documents; or
- .4 The Owner has failed to furnish to the Contractor reasonable evidence as required by Section 2.2.

§ 14.1.2 The Contractor may terminate the Contract if, through no act or fault of the Contractor, a Subcontractor, a Sub-subcontractor, their agents or employees, or any other persons or entities performing portions of the Work, repeated suspensions, delays, or interruptions of the entire Work by the Owner as described in Section 14.3, constitute in the aggregate more than 100 percent of the total number of days scheduled for completion, or 120 days in any 365-day period, whichever is less.

§ 14.1.3 If one of the reasons described in Section 14.1.1 or 14.1.2 exists, the Contractor may, upon seven days' notice to the Owner and Architect, terminate the Contract and recover from the Owner payment for Work executed, as well as reasonable overhead and profit on Work not executed, and costs incurred by reason of such termination.

§ 14.1.4 If the Work is stopped for a period of 60 consecutive days through no act or fault of the Contractor, a Subcontractor, a Sub-subcontractor, or their agents or employees or any other persons or entities performing portions of the Work because the Owner has repeatedly failed to fulfill the Owner's obligations under the Contract Documents with respect to matters important to the progress of the Work, the Contractor may, upon seven additional days' notice to the Owner and the Architect, terminate the Contract and recover from the Owner as provided in Section 14.1.3.

### § 14.2 Termination by the Owner for Cause

§ 14.2.1 The Owner may terminate the Contract if the Contractor

- .1 repeatedly refuses or fails to supply enough properly skilled workers or proper materials;
- .2 fails to make payment to Subcontractors or suppliers in accordance with the respective agreements between the Contractor and the Subcontractors or suppliers;
- .3 repeatedly disregards applicable laws, statutes, ordinances, codes, rules and regulations, or lawful orders of a public authority; or
- .4 otherwise is guilty of substantial breach of a provision of the Contract Documents.

§ 14.2.2 When any of the reasons described in Section 14.2.1 exist, and upon certification by the Architect that sufficient cause exists to justify such action, the Owner may, without prejudice to any other rights or remedies of the Owner and after giving the Contractor and the Contractor's surety, if any, seven days' notice, terminate employment of the Contractor and may, subject to any prior rights of the surety:

- .1 Exclude the Contractor from the site and take possession of all materials, equipment, tools, and construction equipment and machinery thereon owned by the Contractor;
- .2 Accept assignment of subcontracts pursuant to Section 5.4; and
- .3 Finish the Work by whatever reasonable method the Owner may deem expedient. Upon written request of the Contractor, the Owner shall furnish to the Contractor a detailed accounting of the costs incurred by the Owner in finishing the Work.

§ 14.2.3 When the Owner terminates the Contract for one of the reasons stated in Section 14.2.1, the Contractor shall not be entitled to receive further payment until the Work is finished.

§ 14.2.4 If the unpaid balance of the Contract Sum exceeds costs of finishing the Work, including compensation for the Architect's services and expenses made necessary thereby, and other damages incurred by the Owner and not expressly waived, such excess shall be paid to the Contractor. If such costs and damages exceed the unpaid balance,

the Contractor shall pay the difference to the Owner. The amount to be paid to the Contractor or Owner, as the case may be, shall be certified by the Initial Decision Maker, upon application, and this obligation for payment shall survive termination of the Contract.

#### **§ 14.3 Suspension by the Owner for Convenience**

**§ 14.3.1** The Owner may, without cause, order the Contractor in writing to suspend, delay or interrupt the Work, in whole or in part for such period of time as the Owner may determine.

**§ 14.3.2** The Contract Sum and Contract Time shall be adjusted for increases in the cost and time caused by suspension, delay, or interruption under Section 14.3.1. Adjustment of the Contract Sum shall include profit. No adjustment shall be made to the extent

- .1 that performance is, was, or would have been, so suspended, delayed, or interrupted, by another cause for which the Contractor is responsible; or
- .2 that an equitable adjustment is made or denied under another provision of the Contract.

#### **§ 14.4 Termination by the Owner for Convenience**

**§ 14.4.1** The Owner may, at any time, terminate the Contract for the Owner's convenience and without cause.

**§ 14.4.2** Upon receipt of notice from the Owner of such termination for the Owner's convenience, the Contractor shall

- .1 cease operations as directed by the Owner in the notice;
- .2 take actions necessary, or that the Owner may direct, for the protection and preservation of the Work; and
- .3 except for Work directed to be performed prior to the effective date of termination stated in the notice, terminate all existing subcontracts and purchase orders and enter into no further subcontracts and purchase orders.

**§ 14.4.3** In case of such termination for the Owner's convenience, the Owner shall pay the Contractor for Work properly executed; costs incurred by reason of the termination, including costs attributable to termination of Subcontracts; and the termination fee, if any, set forth in the Agreement.

### **ARTICLE 15 CLAIMS AND DISPUTES**

#### **§ 15.1 Claims**

##### **§ 15.1.1 Definition**

A Claim is a demand or assertion by one of the parties seeking, as a matter of right, payment of money, a change in the Contract Time, or other relief with respect to the terms of the Contract. The term "Claim" also includes other disputes and matters in question between the Owner and Contractor arising out of or relating to the Contract. The responsibility to substantiate Claims shall rest with the party making the Claim. This Section 15.1.1 does not require the Owner to file a Claim in order to impose liquidated damages in accordance with the Contract Documents.

##### **§ 15.1.2 Time Limits on Claims**

The Owner and Contractor shall commence all Claims and causes of action against the other and arising out of or related to the Contract, whether in contract, tort, breach of warranty or otherwise, in accordance with the requirements of the binding dispute resolution method selected in the Agreement and within the period specified by applicable law, but in any case not more than 10 years after the date of Substantial Completion of the Work. The Owner and Contractor waive all Claims and causes of action not commenced in accordance with this Section 15.1.2.

##### **§ 15.1.3 Notice of Claims**

**§ 15.1.3.1** Claims by either the Owner or Contractor, where the condition giving rise to the Claim is first discovered prior to expiration of the period for correction of the Work set forth in Section 12.2.2, shall be initiated by notice to the other party and to the Initial Decision Maker with a copy sent to the Architect, if the Architect is not serving as the Initial Decision Maker. Claims by either party under this Section 15.1.3.1 shall be initiated within 21 days after occurrence of the event giving rise to such Claim or within 21 days after the claimant first recognizes the condition giving rise to the Claim, whichever is later.

**§ 15.1.3.2** Claims by either the Owner or Contractor, where the condition giving rise to the Claim is first discovered after expiration of the period for correction of the Work set forth in Section 12.2.2, shall be initiated by notice to the other party. In such event, no decision by the Initial Decision Maker is required.

#### **§ 15.1.4 Continuing Contract Performance**

**§ 15.1.4.1** Pending final resolution of a Claim, except as otherwise agreed in writing or as provided in Section 9.7 and Article 14, the Contractor shall proceed diligently with performance of the Contract and the Owner shall continue to make payments in accordance with the Contract Documents.

**§ 15.1.4.2** The Contract Sum and Contract Time shall be adjusted in accordance with the Initial Decision Maker's decision, subject to the right of either party to proceed in accordance with this Article 15. The Architect will issue Certificates for Payment in accordance with the decision of the Initial Decision Maker.

#### **§ 15.1.5 Claims for Additional Cost**

If the Contractor wishes to make a Claim for an increase in the Contract Sum, notice as provided in Section 15.1.3 shall be given before proceeding to execute the portion of the Work that is the subject of the Claim. Prior notice is not required for Claims relating to an emergency endangering life or property arising under Section 10.4.

#### **§ 15.1.6 Claims for Additional Time**

**§ 15.1.6.1** If the Contractor wishes to make a Claim for an increase in the Contract Time, notice as provided in Section 15.1.3 shall be given. The Contractor's Claim shall include an estimate of cost and of probable effect of delay on progress of the Work. In the case of a continuing delay, only one Claim is necessary.

**§ 15.1.6.2** If adverse weather conditions are the basis for a Claim for additional time, such Claim shall be documented by data substantiating that weather conditions were abnormal for the period of time, could not have been reasonably anticipated, and had an adverse effect on the scheduled construction.

#### **§ 15.1.7 Waiver of Claims for Consequential Damages**

The Contractor and Owner waive Claims against each other for consequential damages arising out of or relating to this Contract. This mutual waiver includes

- .1 damages incurred by the Owner for rental expenses, for losses of use, income, profit, financing, business and reputation, and for loss of management or employee productivity or of the services of such persons; and
- .2 damages incurred by the Contractor for principal office expenses including the compensation of personnel stationed there, for losses of financing, business and reputation, and for loss of profit, except anticipated profit arising directly from the Work.

This mutual waiver is applicable, without limitation, to all consequential damages due to either party's termination in accordance with Article 14. Nothing contained in this Section 15.1.7 shall be deemed to preclude assessment of liquidated damages, when applicable, in accordance with the requirements of the Contract Documents.

#### **§ 15.2 Initial Decision**

**§ 15.2.1** Claims, excluding those where the condition giving rise to the Claim is first discovered after expiration of the period for correction of the Work set forth in Section 12.2.2 or arising under Sections 10.3, 10.4, and 11.5, shall be referred to the Initial Decision Maker for initial decision. The Architect will serve as the Initial Decision Maker, unless otherwise indicated in the Agreement. Except for those Claims excluded by this Section 15.2.1, an initial decision shall be required as a condition precedent to mediation of any Claim. If an initial decision has not been rendered within 30 days after the Claim has been referred to the Initial Decision Maker, the party asserting the Claim may demand mediation and binding dispute resolution without a decision having been rendered. Unless the Initial Decision Maker and all affected parties agree, the Initial Decision Maker will not decide disputes between the Contractor and persons or entities other than the Owner.

**§ 15.2.2** The Initial Decision Maker will review Claims and within ten days of the receipt of a Claim take one or more of the following actions: (1) request additional supporting data from the claimant or a response with supporting data from the other party, (2) reject the Claim in whole or in part, (3) approve the Claim, (4) suggest a compromise, or (5) advise the parties that the Initial Decision Maker is unable to resolve the Claim if the Initial Decision Maker lacks sufficient information to evaluate the merits of the Claim or if the Initial Decision Maker concludes that, in the



Initial Decision Maker's sole discretion, it would be inappropriate for the Initial Decision Maker to resolve the Claim.

**§ 15.2.3** In evaluating Claims, the Initial Decision Maker may, but shall not be obligated to, consult with or seek information from either party or from persons with special knowledge or expertise who may assist the Initial Decision Maker in rendering a decision. The Initial Decision Maker may request the Owner to authorize retention of such persons at the Owner's expense.

**§ 15.2.4** If the Initial Decision Maker requests a party to provide a response to a Claim or to furnish additional supporting data, such party shall respond, within ten days after receipt of the request, and shall either (1) provide a response on the requested supporting data, (2) advise the Initial Decision Maker when the response or supporting data will be furnished, or (3) advise the Initial Decision Maker that no supporting data will be furnished. Upon receipt of the response or supporting data, if any, the Initial Decision Maker will either reject or approve the Claim in whole or in part.

**§ 15.2.5** The Initial Decision Maker will render an initial decision approving or rejecting the Claim, or indicating that the Initial Decision Maker is unable to resolve the Claim. This initial decision shall (1) be in writing; (2) state the reasons therefor; and (3) notify the parties and the Architect, if the Architect is not serving as the Initial Decision Maker, of any change in the Contract Sum or Contract Time or both. The initial decision shall be final and binding on the parties but subject to mediation and, if the parties fail to resolve their dispute through mediation, to binding dispute resolution.

**§ 15.2.6** Either party may file for mediation of an initial decision at any time, subject to the terms of Section 15.2.6.1.

**§ 15.2.6.1** Either party may, within 30 days from the date of receipt of an initial decision, demand in writing that the other party file for mediation. If such a demand is made and the party receiving the demand fails to file for mediation within 30 days after receipt thereof, then both parties waive their rights to mediate or pursue binding dispute resolution proceedings with respect to the initial decision.

**§ 15.2.7** In the event of a Claim against the Contractor, the Owner may, but is not obligated to, notify the surety, if any, of the nature and amount of the Claim. If the Claim relates to a possibility of a Contractor's default, the Owner may, but is not obligated to, notify the surety and request the surety's assistance in resolving the controversy.

**§ 15.2.8** If a Claim relates to or is the subject of a mechanic's lien, the party asserting such Claim may proceed in accordance with applicable law to comply with the lien notice or filing deadlines.

### **§ 15.3 Mediation**

**§ 15.3.1** Claims, disputes, or other matters in controversy arising out of or related to the Contract, except those waived as provided for in Sections 9.10.4, 9.10.5, and 15.1.7, shall be subject to mediation as a condition precedent to binding dispute resolution.

**§ 15.3.2** The parties shall endeavor to resolve their Claims by mediation which, unless the parties mutually agree otherwise, shall be administered by the American Arbitration Association in accordance with its Construction Industry Mediation Procedures in effect on the date of the Agreement. A request for mediation shall be made in writing, delivered to the other party to the Contract, and filed with the person or entity administering the mediation. The request may be made concurrently with the filing of binding dispute resolution proceedings but, in such event, mediation shall proceed in advance of binding dispute resolution proceedings, which shall be stayed pending mediation for a period of 60 days from the date of filing, unless stayed for a longer period by agreement of the parties or court order. If an arbitration is stayed pursuant to this Section 15.3.2, the parties may nonetheless proceed to the selection of the arbitrator(s) and agree upon a schedule for later proceedings.

**§ 15.3.3** Either party may, within 30 days from the date that mediation has been concluded without resolution of the dispute or 60 days after mediation has been demanded without resolution of the dispute, demand in writing that the other party file for binding dispute resolution. If such a demand is made and the party receiving the demand fails to file for binding dispute resolution within 60 days after receipt thereof, then both parties waive their rights to binding dispute resolution proceedings with respect to the initial decision.

§ 15.3.4 The parties shall share the mediator's fee and any filing fees equally. The mediation shall be held in the place where the Project is located, unless another location is mutually agreed upon. Agreements reached in mediation shall be enforceable as settlement agreements in any court having jurisdiction thereof.

#### § 15.4 Arbitration

§ 15.4.1 If the parties have selected arbitration as the method for binding dispute resolution in the Agreement, any Claim subject to, but not resolved by, mediation shall be subject to arbitration which, unless the parties mutually agree otherwise, shall be administered by the American Arbitration Association in accordance with its Construction Industry Arbitration Rules in effect on the date of the Agreement. The Arbitration shall be conducted in the place where the Project is located, unless another location is mutually agreed upon. A demand for arbitration shall be made in writing, delivered to the other party to the Contract, and filed with the person or entity administering the arbitration. The party filing a notice of demand for arbitration must assert in the demand all Claims then known to that party on which arbitration is permitted to be demanded.

§ 15.4.1.1 A demand for arbitration shall be made no earlier than concurrently with the filing of a request for mediation, but in no event shall it be made after the date when the institution of legal or equitable proceedings based on the Claim would be barred by the applicable statute of limitations. For statute of limitations purposes, receipt of a written demand for arbitration by the person or entity administering the arbitration shall constitute the institution of legal or equitable proceedings based on the Claim.

§ 15.4.2 The award rendered by the arbitrator or arbitrators shall be final, and judgment may be entered upon it in accordance with applicable law in any court having jurisdiction thereof.

§ 15.4.3 The foregoing agreement to arbitrate and other agreements to arbitrate with an additional person or entity duly consented to by parties to the Agreement, shall be specifically enforceable under applicable law in any court having jurisdiction thereof.

#### § 15.4.4 Consolidation or Joinder

§ 15.4.4.1 Subject to the rules of the American Arbitration Association or other applicable arbitration rules, either party may consolidate an arbitration conducted under this Agreement with any other arbitration to which it is a party provided that (1) the arbitration agreement governing the other arbitration permits consolidation, (2) the arbitrations to be consolidated substantially involve common questions of law or fact, and (3) the arbitrations employ materially similar procedural rules and methods for selecting arbitrator(s).

§ 15.4.4.2 Subject to the rules of the American Arbitration Association or other applicable arbitration rules, either party may include by joinder persons or entities substantially involved in a common question of law or fact whose presence is required if complete relief is to be accorded in arbitration, provided that the party sought to be joined consents in writing to such joinder. Consent to arbitration involving an additional person or entity shall not constitute consent to arbitration of any claim, dispute or other matter in question not described in the written consent.

§ 15.4.4.3 The Owner and Contractor grant to any person or entity made a party to an arbitration conducted under this Section 15.4, whether by joinder or consolidation, the same rights of joinder and consolidation as those of the Owner and Contractor under this Agreement.

## STANDARD SUPPLEMENTARY CONDITIONS

### 1. GENERAL CONDITIONS

The *General Conditions of the Contract for Construction*, AIA Document A201, 2007 Edition, Articles 1 through 15 inclusive, is a part of this Contract and is incorporated as fully as if herein set forth. For brevity, AIA Document A201 is also referred to in the Contract Documents collectively as the "General Conditions."

### 2. STANDARD SUPPLEMENTARY CONDITIONS

- 2.1 The following supplements modify, delete and/or add to the AIA Document A201, 2007 Edition. Where any portion of the General Conditions is modified or any paragraph, Section or clause thereof is modified or deleted by these Supplementary Conditions, the unaltered provisions of the General Conditions shall remain in effect.
- 2.2 Unless otherwise stated, the terms used in these Standard Supplementary Conditions which are defined in the General Conditions have the meanings assigned to them in the General Conditions.

### 3. MODIFICATIONS TO A201-2007

3.1 *Insert the following at the end of Section 1.1.1:*

Any reference in this document to the Agreement between the Owner and Contractor, AIA Document A101, or some abbreviated reference thereof, shall mean the AIA A101, 2007 Edition. Any reference in this document to the General Conditions of the Contract for Construction, AIA Document A201, or some abbreviated reference thereof, shall mean the AIA A201, 2007 Edition as modified by the Standard Supplementary Conditions.

3.2 Delete the language of Section 1.1.8 and substitute the word "Reserved."

3.3 Add the following Section 1.1.9:

**1.1.9 NOTICE TO PROCEED**

Notice to Proceed is a document issued by the Owner to the Contractor, with a copy to the Architect, directing the Contractor to begin prosecution of the Work in accordance with the requirements of the Contract Documents. The Notice to Proceed shall fix the date on which the Contract Time will commence.

3.4 Insert the following at the end of Section 1.2.1:

In the event of patent ambiguities within or between parts of the Contract Documents, the contractor shall 1) provide the better quality or greater quantity of Work, or 2) comply with the more stringent requirement, either or both in accordance with the Architect's interpretation.

3.5 Delete Section 1.5.1 and substitute the following:

**1.5.1** The Architect and the Architect's consultants shall be deemed the authors and owners of their respective Instruments of Service and will retain all common law, statutory and other reserved rights, including copyrights. The Contractor, Subcontractors, Sub-subcontractors, and material or equipment suppliers shall not own or claim a copyright in the Instruments of Service. Submittal or distribution to meet official regulatory requirements or for other purposes in connection with this Project is not to be construed as a violation of the Architect's or Architect's consultants' reserved rights.

3.6 Delete Section 2.1.1 and substitute the following:

**2.1.1** The Owner is the person or entity identified as such in the Agreement and is referred to throughout the Contract Documents as if singular in number. The Owner shall designate in writing a representative who shall have express authority to bind the Owner with respect to all matters requiring the Owner's approval or authorization, except as provided in Section 7.1.2. Except as otherwise provided in Section 4.2.1, the Architect does not have such authority. The term "Owner" means the Owner or the Owner's Representative. [Reference § 8.2 of the Agreement.]

3.7 Delete Section 2.1.2 and substitute the following:

**2.1.2** The Owner shall furnish to the Contractor within fifteen days after receipt of a written request, information necessary and relevant for the Contractor to post Notice of Project Commencement pursuant to Title 29, Chapter 5, Section 23 of the South Carolina Code of Laws, as amended.

3.8 Delete Section 2.2.3 and substitute the following:

## STANDARD SUPPLEMENTARY CONDITIONS

**2.2.3** The Owner shall furnish surveys describing physical characteristics, legal limitations and utility locations for the site of the Project, and a legal description of the site. Subject to the Contractor's obligations, including those in Section 3.2, the Contractor shall be entitled to rely on the accuracy of information furnished by the Owner pursuant to this Section but shall exercise proper precautions relating to the safe performance of the Work.

**3.9** Replace the period at the end of the last sentence of Section 2.2.4 with a semicolon and insert the following after the inserted semicolon:

"however, the Owner does not warrant the accuracy of any such information requested by the Contractor that is not otherwise required of the Owner by the Contract Documents. Neither the Owner nor the Architect shall be required to conduct investigations or to furnish the Contractor with any information concerning subsurface characteristics or other conditions of the area where the Work is to be performed beyond that which is provide in the Contract Documents."

**3.10** Delete Section 2.2.5 and substitute the following:

**2.2.5** Unless otherwise provided in the Contract Documents, the Owner shall furnish to the Contractor with ten copies of the Contract Documents. The Contractor may make reproductions of the Contract Documents pursuant to Section 1.5.2. All copies of the drawings and specifications, except the Contractor's record set, shall be returned or suitably accounted for to the Owner, on request, upon completion of the Work.

**3.11** Add the following Sections 2.2.6 and 2.2.7:

**2.2.6** The Owner assumes no responsibility for any conclusions or interpretation made by the Contractor based on information made available by the Owner.

**2.2.7** The Owner shall obtain, at its own cost, general building and specialty inspection services as required by the Contract Documents. The Contractor shall be responsible for payment of any charges imposed for reinspections.

**3.12** Delete Section 2.4 and substitute the following:

**2.4** If the Contractor defaults or neglects to carry out the Work in accordance with the Contract Documents and fails within a ten-day period after receipt of written notice from the Owner to commence and continue correction of such default or neglect, including but not limited to providing necessary resources, with diligence and promptness, the Owner may, without prejudice to other remedies the Owner may have, correct such deficiencies. In such case an appropriate Change Directive shall be issued deducting from payments then or thereafter due the Contractor the reasonable cost of correcting such deficiencies, including Owner's expenses and compensation for the Architect's additional services made necessary by such default, neglect or failure. If payments then or thereafter due the Contractor are not sufficient to cover such amounts, the Contractor shall pay the difference to the Owner.

**3.13** Insert the following at the end of Section 3.2.1:

The Contractor acknowledges that it has investigated and satisfied itself as to the general and local conditions which can affect the work or its cost, including but not limited to (1) conditions bearing upon transportation, disposal, handling, and storage of materials; (2) the availability of labor, water, electric power, and roads; (3) uncertainties of weather, river stages, tides, or similar physical conditions at the site; (4) the conformation and conditions of the ground; and (5) the character of equipment and facilities needed preliminary to and during work performance. The Contractor also acknowledges that it has satisfied itself as to the character, quality, and quantity of surface and subsurface materials or obstacles to be encountered insofar as this information is reasonably ascertainable from an inspection of the site, including all exploratory work done by the Owner, as well as from the drawings and specifications made a part of this contract. Any failure of the Contractor to take the actions described and acknowledged in this paragraph will not relieve the Contractor from responsibility for estimating properly the difficulty and cost of successfully performing the work, or for proceeding to successfully perform the work without additional expense to the Owner.

**3.14** In the third sentence of Section 3.2.4, insert the word "latent" before the word "errors."

**3.15** In the last sentence of Section 3.3.1, insert the words "by the Owner in writing" after the word "instructed."

**3.16** Delete the third sentence of Section 3.5 and substitute the following sentences:

## STANDARD SUPPLEMENTARY CONDITIONS

Work, materials, or equipment not conforming to these requirements shall be considered defective. Unless caused by the Contractor or a subcontractor at any tier, the Contractor's warranty excludes remedy for damage or defect caused by abuse, alterations to the Work not executed by the Contractor, improper or insufficient maintenance, improper operation, or normal wear and tear and normal usage.

**3.17** Insert the following at the end of Section 3.6:

The Contractor shall comply with the requirements of Title 12, Chapter 9 of the South Carolina Code of Laws, as amended, regarding withholding tax for nonresidents, employees, contractors and subcontractors.

**3.18** In Section 3.7.1, delete the words "the building permit as well as for other" and insert the following sentence at the end of this section:

Pursuant to Title 10, Chapter 1, Section 180 of the South Carolina Code of Laws, as amended, no local general or specialty building permits are required for state buildings.

**3.19** Delete the last sentence of Section 3.7.5 and substitute the following:

Adjustments in the Contract Sum and Contract Time arising from the existence of such remains or features may be made as provided in Article 7.3.3.

**3.20** Delete the last sentence of Section 3.8.2.3 and substitute the following:

The amount of the Change Order shall reflect the difference between actual costs, as documented by invoices, and the allowances under Section 3.8.2.1.

**3.21** In Section 3.9.1, insert a comma after the word "superintendent" in the first sentence and insert the following after the inserted comma:

acceptable to the Owner,

**3.22** Delete Section 3.9.2 and substitute the following:

**3.9.2** The Contractor, as soon as practicable after award of the Contract, shall furnish in writing to the Owner the name and qualifications of a proposed superintendent. The Owner may reply within 14 days to the Contractor in writing stating (1) whether the Owner has reasonable objection to the proposed superintendent or (2) that the Owner requires additional time to review. Failure of the Owner to reply within the 14-day period shall constitute notice of no reasonable objection.

**3.23** After the first sentence in Section 3.9.3, insert the following sentence:

The Contractor shall notify the Owner, in writing, of any proposed change in the superintendent, including the reason therefore, prior to making such change.

**3.24** Delete Section 3.10.3 and substitute the following:

**3.10.3** Additional requirements, if any, for the constructions schedule are as follows:  
(Check box if applicable to this Contract))

The construction schedule shall be in a detailed precedence-style critical path management (CPM) or primavera-type format satisfactory to the Owner and the Architect that shall also (1) provide a graphic representation of all activities and events that will occur during performance of the work; (2) identify each phase of construction and occupancy; and (3) set forth dates that are critical in ensuring the timely and orderly completion of the Work in accordance with the requirements of the Contract Documents (hereinafter referred to as "Milestone Dates"). Upon review and acceptance by the Owner and the Architect of the Milestone Dates, the construction schedule shall be deemed part of the Contract Documents and attached to the Agreement as Exhibit "A." If not accepted, the construction schedule shall be promptly revised by the Contractor in accordance with the recommendations of the Owner and the Architect and resubmitted for acceptance. The Contractor shall monitor the progress of the Work for conformance with the requirements of the construction schedule and shall promptly advise the Owner of any delays or potential delays. Whenever the approved construction schedule no longer reflects actual conditions and progress of the work or the Contract Time is modified in accordance with the terms of the Contract Documents, the Contractor shall update the accepted construction schedule to reflect such conditions. In the event any progress report indicates any delays, the Contractor shall propose an affirmative plan to correct the delay, including overtime and/or additional labor, if necessary. In no event shall any progress report constitute an adjustment in the Contract Time, any Milestone Date, or the Contract Sum unless any such adjustment is agreed to by the Owner and authorized pursuant to

## STANDARD SUPPLEMENTARY CONDITIONS

Change Order.

**3.25** Add the following Section 3.10.4:

**3.10.4** Owner's review and acceptance of Contractor's schedule is not conducted for the purpose of either determining its accuracy and completeness or approving the construction means, methods, techniques, sequences or procedures. The Owner's approval shall not relieve the Contractor of any obligations. Unless expressly addressed in a Modification, the Owner's approval of a schedule shall not change the Contract Time.

**3.26** Add the following Section 3.12.5.1:

**3.12.5.1** The fire sprinkler shop drawings shall be prepared by a licensed fire sprinkler contractor and shall accurately reflect actual conditions affecting the required layout of the fire sprinkler system. The fire sprinkler contractor shall certify the accuracy of his shop drawings prior to submitting them for review and approval. The fire sprinkler shop drawings shall be reviewed and approved by the Architect's engineer of record who, upon approving the sprinkler shop drawings will submit them to the State Fire Marshal or other authorities having jurisdiction for review and approval. The Architect's engineer of record will submit a copy of the State Fire Marshal's approval letter to the Contractor and Consultant. Unless authorized in writing by Consultant, neither the Contractor nor subcontractor at any tier shall submit the fire sprinkler shop drawings directly to the State Fire Marshal or other authorities having jurisdiction for approval.

**3.27** In the fourth sentence of Section 3.12.10, after the comma following the words "licensed design professional," insert the following:

who shall comply with reasonable requirements of the Owner regarding qualifications and insurance and

**3.28** In Section 3.13, insert the section number "3.13.1" before the opening words "The Contractors shall."

**3.29** Add the following Sections 3.13.2 and 3.13.3:

**3.13.2** Protection of construction materials and equipment stored at the Project site from weather, theft, vandalism, damage, and all other adversity is solely the responsibility of the Contractor. The Contractor shall perform the work in a manner that affords reasonable access, both vehicular and pedestrian, to the site of the Work and all adjacent areas. The Work shall be performed, to the fullest extent reasonably possible, in such a manner that public areas adjacent to the site of the Work shall be free from all debris, building materials, and equipment likely to cause hazardous conditions.

**3.13.3** The Contractor and any entity for which the Contractor is responsible shall not erect any sign on the Project site without the prior written consent of the Owner.

**3.30** In the first sentence of Section 3.18.1, after the parenthetical "other than the Work itself" and before the word "but", insert the following:

including loss of use resulting therefrom,

**3.31** Delete Section 4.1.1 and substitute the following:

**4.1.1** The Architect is that person or entity identified as the Architect in the Agreement and is referred to throughout the Contract Documents as if singular in number.

**3.32** Insert the following at the end of Section 4.2.1:

Any reference in the Contract Documents to the Architect taking action or rendering a decision with a "reasonable time" is understood to mean no more than fourteen days, unless otherwise specified in the Contract Documents or otherwise agreed to by the parties.

**3.33** Delete the first sentence of Section 4.2.2 and substitute the following:

The Architect will visit the site as necessary to fulfill its obligation to the Owner for inspection services, if any, and, at a minimum, to assure conformance with the Architect's design as shown in the Contract Documents and to observe the progress and quality of the various components of the Contractor's Work, and to determine if the Work observed is being performed in a manner indicating that the Work, when fully completed, will be in accordance with the Contract Documents.

**3.34** Delete the first sentence of Section 4.2.3 and substitute the following:

On the basis of the site visits, the Architect will keep the Owner informed about the progress and quality of the

## STANDARD SUPPLEMENTARY CONDITIONS

portion of the Work completed, and report to the Owner (1) deviations from the Contract Documents and from the most recent construction schedule submitted by the Contractor, and (2) defects and deficiencies observed in the Work.

- 3.35** In Section 4.2.5, after the words “evaluations of the” and before the word “Contractor’s,” insert the following:  
Work completed and correlated with the
- 3.36** Delete the first sentence of Section 4.2.11 and substitute the following:  
**4.2.11** The Architect will, in the first instance, interpret and decide matters concerning performance under, and requirements of, the Contract Documents on written request of either the Owner or Contractor. Upon receipt of such request, the Architect will promptly provide the non-requesting party with a copy of the request.
- 3.37** Insert the following at the end of Section 4.2.12:  
If either party disputes the Architects interpretation or decision, that party may proceed as provided in Article 15. The Architect’s interpretations and decisions may be, but need not be, accorded any deference in any review conducted pursuant to law or the Contract Documents.
- 3.38** Delete Section 4.2.14 and substitute the following:  
The Architect will review and respond to requests for information about the Contract Documents so as to avoid delay to the construction of the Project. The Architect’s response to such requests will be made in writing with reasonable promptness. If appropriate, the Architect will prepare and issue supplemental Drawings and Specifications in response to the requests for information. Any response to a request for information must be consistent with the intent of, and reasonably inferable from, the Contract Documents and will be in writing or in the form of drawings. Unless issued pursuant to a Modification, supplemental Drawings or Specifications will not involve an adjustment to the Contract Sum or Contract Time.
- 3.39** Delete Section 5.2.1 and substitute the following:  
**5.2.1** Unless otherwise stated in the Contract Documents or the bidding requirements, the Contractor, within fourteen days after posting of the Notice of Intent to Award the Contract, shall furnish in writing to the Owner through the Architect the names of persons or entities (excluding Listed Subcontractors but including those who are to furnish materials or equipment fabricated to a special design) proposed for each principal portion of the Work. The Owner may reply within 14 days to the Contractor in writing stating (1) whether the Owner has reasonable objection to any such proposed person or entity. Failure of the Owner to reply within the 14 day period shall constitute notice of no reasonable objection.
- 3.40** Delete Section 5.2.2 and substitute the following:  
**5.2.2** The Contractor shall not contract with a proposed person or entity to whom the Owner has made reasonable and timely objection. The Owner shall not direct the Contractor to contract with any specific individual or entity for supplies or services unless such supplies and services are necessary for completion of the Work and the specified individual or entity is the only source of such supply or services.
- 3.41** In the first sentence of Section 5.2.3, delete the words “...or Architect...” in the two places they appear.
- 3.42** Delete the words “...or Architect...” in the in the first sentence of Section 5.2.4 and insert the following sentence at the end of Section 5.2.4:  
The Contractor’s request for substitution must be made to the Owner in writing accompanied by supporting information.
- 3.43** Add the following Section 5.2.5:  
**5.2.5** A Subcontractor identified in the Contractor’s Bid in response the specialty subcontractor listing requirements of Section 7 of the Bid Form (SE-330) may only be substituted in accordance with and as permitted by the provisions of Title 11, Chapter 35, Section 3021 of the South Carolina Code of Laws, as amended. A proposed substitute for a Listed Subcontractor shall be subject to the Owner’s approval as set forth in Section 5.2.3.
- 3.44** Add the following Section 5.2.6:  
**5.2.6** The Iran Divestment Act List is a list published by the State Fiscal Accountability Authority pursuant to Section 11-57-310 that identifies persons engaged in investment activities in Iran. Currently, the list is available

## STANDARD SUPPLEMENTARY CONDITIONS

at the following URL: <http://procurement.sc.gov/PS/PS-iran-divestment.phtm>(.) Consistent with Section 11-57-330(B), the Contractor shall not contract with any person to perform a part of the Work, if, at the time you enter into the subcontract, that person is on the then-current version of the Iran Divestment Act List.

- 3.45** In Section 5.3, delete everything following the heading “SUBCONTRACTUAL RELATIONS” and insert the following Sections 5.3.1, 5.3.2, 5.3.3, and 5.3.4:

**5.3.1** By appropriate written agreement, the Contractor shall require each Subcontractor, to the extent of the Work to be performed by the Subcontractor, to be bound to the Contractor by terms of the Contract Documents, and to assume toward the Contractor all the obligations and responsibilities, including the responsibility for safety of the Subcontractor’s Work, which the Contractor, by these Documents, assumes toward the Owner and Architect. Each subcontract agreement shall preserve and protect the rights of the Owner and Architect under the Contract Documents with respect to the Work to be performed by the Subcontractor so that subcontracting thereof will not prejudice such rights, and shall allow to the Subcontractor, unless specifically provided otherwise herein or in the subcontract agreement, the benefit of all rights, remedies and redress against the Contractor that the Contractor, by the Contract Documents, has against the Owner. Where appropriate, the Contractor shall require each Subcontractor to enter into similar agreements with Sub-subcontractors. The Contractor shall make available to each proposed Subcontractor, prior to the execution of the subcontract agreement, copies of the Contract Documents to which the Subcontractor will be bound, and, upon written request of the Subcontractor, identify to the Subcontractor terms and conditions of the proposed subcontract agreement that may be at variance with the Contract Documents. Subcontractors will similarly make copies of applicable portions of such documents available to their respective proposed Sub-subcontractors.

**5.3.2** Without limitation on the generality of Section 5.3.1, each Subcontract agreement and each Sub-subcontract agreement shall include, and shall be deemed to include, the following Sections of these General Conditions: 3.2, 3.5, 3.18, 5.3, 5.4, 6.2.2, 7.3.3, 7.5, 7.6, 13.1, 13.12, 14.3, 14.4, and 15.1.6.

**5.3.3** Each Subcontract Agreement and each Sub-subcontract agreement shall exclude, and shall be deemed to exclude, Sections 13.2.1 and 13.6 and all of Article 15, except Section 15.1.6, of these General Conditions. In the place of these excluded sections of the General Conditions, each Subcontract Agreement and each Sub-subcontract may include Sections 13.2.1 and 13.6 and all of Article 15, except Section 15.1.6, of AIA Document A201-2007, Conditions of the Contract, as originally issued by the American Institute of Architects.

**5.3.4** The Contractor shall assure the Owner that all agreements between the Contractor and its Subcontractor incorporate the provisions of Subparagraph 5.3.1 as necessary to preserve and protect the rights of the Owner and the Architect under the Contract Documents with respect to the work to be performed by Subcontractors so that the subcontracting thereof will not prejudice such rights. The Contractor’s assurance shall be in the form of an affidavit or in such other form as the Owner may approve. Upon request, the Contractor shall provide the Owner or Architect with copies of any or all subcontracts or purchase orders.

- 3.46** Delete the last sentence of Section 5.4.1.

- 3.47** Add the following Sections 5.4.4, 5.4.5 and 5.4.6:

**5.4.4** Each subcontract shall specifically provide that the Owner shall only be responsible to the subcontractor for those obligations of the Contractor that accrue subsequent to the Owner’s exercise of any rights under this conditional assignment.

**5.4.5** Each subcontract shall specifically provide that the Subcontractor agrees to perform portions of the Work assigned to the Owner in accordance with the Contract Documents.

**5.4.6** Nothing in this Section 5.4 shall act to reduce or discharge the Contractor’s payment bond surety’s obligations to claimants for claims arising prior to the Owner’s exercise of any rights under this conditional assignment.

- 3.48** Delete the language of Section 6.1.4 and substitute the word “Reserved.”

- 3.49** Insert the following at the end of Section 7.1.2:

If the amount of a Modification exceeds the limits of the Owner’s Construction Change Order Certification (reference Section 9.1.7.2 of the Agreement), then the Owner’s agreement is not effective, and Work may not proceed, until approved in writing by the Consultant.

- 3.50** Delete Section 7.2.1 and substitute the following:



## STANDARD SUPPLEMENTARY CONDITIONS

**7.2.1** A Change Order is a written instrument prepared by the Architect (using State Form SE-380 “Construction Change Order”) and signed by the Owner, Contractor and Architect stating their agreement upon all of the following:

- .1 The change in the Work;
- .2 The amount of the adjustment, if any, in the Contract Sum; and
- .3 The extent of the adjustment, if any, in the Contract Time.

**3.51** Add the following Sections 7.2.2, 7.2.3, 7.2.4, and 7.2.5:

**7.2.2** If a Change Order provides for an adjustment to the Contract Sum, the adjustment must be calculated in accordance with Section 7.3.3.

**7.2.3** At the Owner’s request, the Contractor shall prepare a proposal to perform the work of a proposed Change Order setting forth the amount of the proposed adjustment, if any, in the Contract Sum; and the extent of the proposed adjustment, if any, in the Contract Time. Any proposed adjustment in the Contract sum shall be prepared in accordance with Section 7.2.2. The Owner’s request shall include any revisions to the Drawings or Specifications necessary to define any changes in the Work. Within fifteen days of receiving the request, the Contractor shall submit the proposal to the Owner and Architect along with all documentation required by Section 7.6.

**7.2.4** If the Contractor requests a Change Order, the request shall set forth the proposed change in the Work and shall be prepared in accordance with Section 7.2.3. If the Contractor requests a change to the Work that involves a revision to either the Drawings or Specifications, the Contractor shall reimburse the Owner for any expenditure associated with the Architects’ review of the proposed revisions, except to the extent the revisions are accepted by execution of a Change Order.

**7.2.5 Agreement on any Change Order shall constitute a final settlement of all matters relating to the change in the Work that is the subject of the Change Order, including, but not limited to, any adjustments to the Contract Sum or the Contract Time.**

**3.52** Delete 7.3.3 and substitute the following:

### **7.3.3 PRICE ADJUSTMENTS**

**7.3.3.1** If any Modification, including a Construction Change Directive, provides for an adjustment to the Contract Sum, the adjustment shall be based on whichever of the following methods is the most valid approximation of the actual cost to the contractor, with overhead and profit as allowed by Section 7.5:

- .1 Mutual acceptance of a lump sum;
- .2 Unit prices stated in the Contract Documents, except as provided in Section 7.3.4, or subsequently agreed upon;
- .3 Cost attributable to the events or situations under applicable clauses with adjustment of profits or fee, all as specified in the contract, or subsequently agreed upon by the parties, or by some other method as the parties may agree; or
- .4 As provided in Section 7.3.7.

**7.3.3.2** Consistent with Section 7.6, costs must be properly itemized and supported by substantiating data sufficient to permit evaluation before commencement of the pertinent performance or as soon after that as practicable. All costs incurred by the Contractor must be justifiably compared with prevailing industry standards. Except as provided in Section 7.5, all adjustments to the Contract Price shall be limited to job specific costs and shall not include indirect costs, overhead, home office overhead, or profit.

**3.53** Delete Section 7.3.7 and substitute the following:

**7.3.7** If the Contractor does not respond promptly or disagrees with the method for adjustment in the Contract Sum, the Architect shall make an initial determination, consistent with Section 7.3.3, of the method and the adjustment on the basis of reasonable expenditures and savings of those performing the Work attributable to the change, including, in case of an increase in the Contract Sum, an amount for overhead and profit as set forth in Section 7.5. In such case, and also under Section 7.3.3.1.3, the Contractor shall keep and present, in such form as the Architect may prescribe, an itemized accounting together with appropriate supporting data. Unless otherwise provided in the Contract Documents, costs for the purposes of this Section 7.3.7 shall be limited to the following:

## STANDARD SUPPLEMENTARY CONDITIONS

- .1 Costs of labor, including social security, old age and unemployment insurance, fringe benefits required by agreement or custom, and workers' compensation insurance;
- .2 Costs of materials, supplies and equipment, including cost of transportation, whether incorporated or consumed;
- .3 Rental costs of machinery and equipment, exclusive of hand tools, whether rented from the Contractor or others; and
- .4 Costs of premiums for all bonds and insurance, permit fees, and sales, use or similar taxes related to the Work.

**3.54** Delete Section 7.3.8 and substitute the following:

**7.3.8** Using the percentages stated in Section 7.5, any adjustment to the Contract Sum for deleted work shall include any overhead and profit attributable to the cost for the deleted Work.

**3.55** Add the following Sections 7.5 and 7.6:

### **7.5 AGREED OVERHEAD AND PROFIT RATES**

- 7.5.1** For any adjustment to the Contract Sum for which overhead and profit may be recovered, other than those made pursuant to Unit Prices stated in the Contract Documents, the Contractor agrees to charge and accept, as full payment for overhead and profit, the following percentages of costs attributable to the change in the Work. The percentages cited below shall be considered to include all indirect costs including, but not limited to: field and office managers, supervisors and assistants, incidental job burdens, small tools, and general overhead allocations. The allowable percentages for overhead and profit are as follows: .1 To the Contractor for work performed by the Contractor's own forces, 17% of the Contractor's actual costs.
- .2 To each Subcontractor for work performed by the Subcontractor's own forces, 17% of the subcontractor's actual costs.
  - .3 To the Contractor for work performed by a subcontractor, 10% of the subcontractor's actual costs (not including the subcontractor's overhead and profit).

### **7.6 PRICING DATA AND AUDIT**

#### **7.6.1 Cost or Pricing Data.**

Upon request of the Owner or Architect, Contractor shall submit cost or pricing data prior to execution of a Modification which exceeds \$500,000. Contractor shall certify that, to the best of its knowledge and belief, the cost or pricing data submitted is accurate, complete, and current as of a mutually determined specified date prior to the date of pricing the Modification. Contractor's price, including profit, shall be adjusted to exclude any significant sums by which such price was increased because Contractor furnished cost or pricing data that was inaccurate, incomplete, or not current as of the date specified by the parties. Notwithstanding Subparagraph 9.10.4, such adjustments may be made after final payment to the Contractor.

**7.6.2** Cost or pricing data means all facts that, as of the date specified by the parties, prudent buyers and sellers would reasonably expect to affect price negotiations significantly. Cost or pricing data are factual, not judgmental; and are verifiable. While they do not indicate the accuracy of the prospective contractor's judgment about estimated future costs or projections, they do include the data forming the basis for that judgment. Cost or pricing data are more than historical accounting data; they are all the facts that can be reasonably expected to contribute to the soundness of estimates of future costs and to the validity of determinations of costs already incurred.

#### **7.6.3 Records Retention.**

As used in Section 7.6, the term "records" means any books or records that relate to cost or pricing data that Contractor is required to submit pursuant to Section 7.6.1. Contractor shall maintain records for three years from the date of final payment, or longer if requested by the chief procurement officer. The Owner may audit Contractor's records at reasonable times and places.

**3.56** Delete Section 8.2.2 and substitute the following:

**8.2.2** The Contractor shall not knowingly commence operations on the site or elsewhere prior to the effective date of surety bonds and insurance required by Article 11 to be furnished by the Contractor and Owner. The date of commencement of the Work shall not be changed by the effective date of such surety bonds or insurance.

## STANDARD SUPPLEMENTARY CONDITIONS

**3.57** Delete Section 8.3.1 and substitute the following:

**8.3.1** If the Contractor is delayed at any time in the commencement or progress of the Work by an act or neglect of the Owner or Architect, or of an employee of either, or of a separate contractor employed by the Owner; or by changes ordered in the Work; or by labor disputes, fire, unusual delay in deliveries, unavoidable casualties or other causes beyond the control of the Contractor and any subcontractor at any tier; or by delay authorized by the Owner pending dispute resolution; or by other causes that the Architect determines may justify delay, then to the extent such delay will prevent the Contractor from achieving Substantial Completion within the Contract Time and provided the delay (1) is not caused by the fault or negligence of the Contractor or a subcontractor at any tier and (2) is not due to unusual delay in the delivery of supplies, machinery, equipment, or services when such supplies, machinery, equipment, or services were obtainable from other sources in sufficient time for the Contractor to meet the required delivery, the Contract Time shall be extended by Change Order for such reasonable time as the Architect may determine.

**3.58** Insert the following at the end of Section 9.1:

All changes to the Contract Sum shall be adjusted in accordance with Section 7.3.3.

**3.59** Delete Section 9.2 and substitute the following:

**9.2 SCHEDULE OF VALUES**

**9.2.1** The Contractor shall submit to the Architect, within ten days of full execution of the Agreement, a schedule of values allocating the entire Contract Sum to the various portions of the Work and prepared in such form and supported by such data to substantiate its accuracy as the Architect may require. This schedule, unless objected to by the Architect, shall be used as a basis for reviewing the Contractor's Applications for Payment. As requested by the Architect, the Contractor and each Subcontractor shall prepare a trade payment breakdown for the Work for which each is responsible, such breakdown being submitted on a uniform standardized format approved by the Architect and Owner. The breakdown shall be divided in detail, using convenient units, sufficient to accurately determine the value of completed Work during the course of the Project. The Contractor shall update the schedule of values as required by either the Architect or Owner as necessary to reflect:

- .1 the description of Work (listing labor and material separately);
- .2 the total value;
- .3 the percent and value of the Work completed to date;
- .4 the percent and value of previous amounts billed; and
- .5 the current percent completed and amount billed.

**9.2.2** Any schedule of values or trade breakdown that fails to include sufficient detail, is unbalanced, or exhibits "front-loading" of the value of the Work shall be rejected. If a schedule of values or trade breakdown is used as the basis for payment and later determined to be inaccurate, sufficient funds shall be withheld from future Applications for Payment to ensure an adequate reserve (exclusive of normal retainage) to complete the Work.

**3.60** Delete Section 9.3.1 and substitute the following:

Monthly, the Contractor shall submit to the Architect an itemized Application for Payment prepared in accordance with the schedule of values, if required under Section 9.2., for completed portions of the Work. Such application shall be notarized, if required, and supported by such data substantiating the Contractor's right to payment as the Owner or Architect may require (such as copies of requisitions from Subcontractors and material suppliers) and shall reflect retainage and any other adjustments provided in Section 5 of the Agreement. If required by the Owner or Architect, the Application for Payment shall be accompanied by a current construction schedule.

**3.61** In Section 9.3.2, add the following words to the end of the second sentence:

provided such materials or equipment will be subsequently incorporated in the Work

Insert the following at the end of Section 9.3.2:

The Contractor shall 1) protect such materials from diversion, vandalism, theft, destruction, and damage, 2) mark such materials specifically for use on the Project, and 3) segregate such materials from other materials at the storage facility. The Architect and the Owner shall have the right to make inspections of the storage areas at any time.

## STANDARD SUPPLEMENTARY CONDITIONS

- 3.62** In Section 9.4.2, in the first sentence, after the words “Work has progressed to the point indicated,” insert the following:  
in both the Application for Payment and, if required to be submitted by the Contractor, the accompanying current construction schedule  
In the last sentence, delete the third item starting with “(3) reviewed copies” and ending with “Contractor’s right to payment,”
- 3.63** In Section 9.5.1, in the first sentence, delete the word “may” after the opening words “The Architect” and substitute the word “shall.”  
In Section 9.5.1, insert the following sentence after the first sentence:  
The Architect shall withhold a Certificate of Payment if the Application for Payment is not accompanied by the current construction schedule required by Section 3.10.1.
- 3.64** In Section 9.6.2, delete the word “The...” at the beginning of the first sentence and substitute the following:  
Pursuant to Chapter 6 of Title 29 of the South Carolina Code of Laws, as amended, the
- 3.65** Delete Section 9.7 and substitute following:  
**9.7 FAILURE OF PAYMENT**  
If the Architect does not issue a Certificate for Payment to the Owner, through no fault of the Contractor, within seven days after receipt of the Contractor’s Application for Payment, or if the Owner does not pay the Contractor within seven days after the time established in the Contract Documents the amount certified by the Architect or awarded by a final dispute resolution order, then the Contractor may, upon seven additional days’ written notice to the Owner and Architect, stop the Work until payment of the amount owing has been received. The Contract Time shall be extended appropriately and the Contract Sum shall be increased, in accordance with the provisions of Section 7.3.3, by the amount of the Contractor’s reasonable costs of shut-down, delay and start-up, plus interest as provided for in the Contract Documents.
- 3.66** Insert the following words at the end of the sentence in Section 9.8.1:  
and when all required occupancy permits, if any, have been issued and copies have been delivered to the Owner.
- 3.67** In Section 9.8.2, insert the word “written” after the word “comprehensive” and before the word “list.”
- 3.68** Delete Section 9.8.3 and substitute the following:  
**9.8.3.1** Upon receipt of the Contractor’s list, the Architect, with the Owner and any other person the Architect or the Owner choose, will make an inspection on a date and at a time mutually agreeable to the Architect, Owner, and Contractor, to determine whether the Work or designated portion thereof is substantially complete. The Contractor shall furnish access for the inspection and testing as provided in this Contract. The inspection shall include a demonstration by the Contractor that all equipment, systems and operable components of the Work function properly and in accordance with the Contract Documents. If the Architect’s inspection discloses any item, whether or not included on the Contractor’s list, which is not sufficiently complete in accordance with the Contract Documents so that the Owner can occupy or utilize the Work or designated portion thereof for its intended use, the Contractor shall, before issuance of the Certificate of Substantial Completion, complete or correct such item upon notification by the Architect. In such case, the Contractor shall then submit a request for another inspection by the Architect to determine Substantial Completion. If more than one Substantial Completion inspection is required, the Contractor shall reimburse the Owner for all costs of reinspections or, at the Owner’s option, the costs may be deducted from payments due to the Contractor.  
**9.8.3.2** If the Architect and Owner concur in the Contractor’s assessment that the Work or a portion of the Work is safe to occupy, the Owner and Contractor may arrange for a Certificate of Occupancy Inspection by the code official. The Owner, Architect, and Contractor shall be present at the code official’s inspection. Upon verifying that the Work or a portion of the Work is substantially complete and safe to occupy, the code official will issue, as appropriate, a Full or Partial Certificate of Occupancy.
- 3.69** In the second sentence of Section 9.8.5, delete the words “and consent of surety, if any.”
- 3.70** In the first sentence of Section 9.9.1, delete the words “Section 11.3.1.5” and substitute the words “Section 11.3.1.3.”
- 3.71** Delete Section 9.10.1 and substitute the following:

## STANDARD SUPPLEMENTARY CONDITIONS

**9.10.1** Unless the parties agree otherwise in the Certificate of Substantial Completion, the Contractor shall achieve Final Completion no later than thirty days after Substantial Completion. Upon receipt of the Contractor's written notice that the Work is ready for final inspection and acceptance and upon receipt of a final Application for Payment, the Architect, with the Owner and any other person the Architect or the Owner choose, will make an inspection on a date and at a time mutually agreeable to the Architect, Owner, and Contractor, and, when the Architect finds the Work acceptable under the Contract Documents and the Contract fully performed, the Architect will promptly issue a final Certificate for Payment stating that to the best of the Architect's knowledge, information and belief, and on the basis of the Architect's on-site visits and inspections, the Work has been completed in accordance with terms and conditions of the Contract Documents and that the entire balance found to be due the Contractor and noted in the final Certificate is due and payable. The Architect's final Certificate for Payment will constitute a further representation that conditions listed in Section 9.10.2 as precedent to the Contractor's being entitled to final payment have been fulfilled. If more than one Final Completion inspection is required, the Contractor shall reimburse the Owner for all costs of reinspections or, at the Owner's option, the costs may be deducted from payments due to the Contractor. If the Contractor does not achieve final completion within thirty days after Substantial Completion or the timeframe agreed to by the parties in the Certificate of Substantial Completion, whichever is greater, the Contractor shall be responsible for any additional Architectural fees resulting from the delay.

**3.72** Delete the first sentence of Section 9.10.2 and substitute the following:

Neither final payment nor any remaining retained percentage shall become due until the Contractor submits to the Architect (1) an affidavit that payrolls, bills for materials and equipment, and other indebtedness connected with the Work for which the Owner or the Owner's property might be responsible or encumbered (less amounts withheld by Owner) have been paid or otherwise satisfied, (2) a certificate evidencing that insurance required by the Contract Documents to remain in force after final payment is currently in effect and will not be canceled or allowed to expire until at least 30 days' prior written notice has been given to the Owner, (3) a written statement that the Contractor knows of no substantial reason that the insurance will not be renewable to cover the period required by the Contract Documents, (4) consent of surety, if any, to final payment (5), if required by the Owner, other data establishing payment or satisfaction of obligations, such as receipts, releases and waivers of liens, claims, security interests or encumbrances arising out of the Contract, to the extent and in such form as may be designated by the Owner, (6) required Training Manuals, (7) equipment Operations and Maintenance Manuals, (8) any certificates of testing, inspection or approval required by the Contract Documents and not previously provided (9) all warranties and guarantees required under or pursuant to the Contract Documents, and (10) one copy of the Documents required by Section 3.11.

**3.73** Delete the first sentence of Section 9.10.3 and substitute the following:

If, after Substantial Completion of the Work, final completion thereof is delayed 60 days through no fault of the Contractor or by issuance of Change Orders affecting final completion, and the Architect so confirms, the Owner shall, upon application by the Contractor and certification by the Architect, and without terminating the Contract, make payment of the balance due for that portion of the Work fully completed and accepted.

**3.74** Delete Section 9.10.5 and substitute the following:

**9.10.5** Acceptance of final payment by the Contractor, a Subcontractor or material supplier shall constitute a waiver of claims by that payee except those specific claims in stated amounts that have been previously made in writing and identified by that payee as unsettled at the time of final Application for Payment.

**3.75** Add the following Section 9.10.6:

**9.10.6** If the code official has not previously issued a Certificate of Occupancy for the entire Project, the Parties shall arrange for a representative of the code official to participate in the Final Completion Inspection. Representatives of the State Fire Marshal's Office and other authorities having jurisdiction may be present at the Final Completion Inspection or otherwise inspect the completed Work and advise the Owner whether the Work meets their respective requirements for the Project.

**3.76** Delete Section 10.3.1 and substitute the following:

**10.3.1** If the Contractor encounters a hazardous material or substance which was not discoverable as provided in Section 3.2.1 and not required by the Contract Documents, and if reasonable precautions will be inadequate to prevent foreseeable bodily injury or death to persons or serious loss to real or personal property resulting from such material or substance encountered on the site by the Contractor, the Contractor shall, upon

STANDARD SUPPLEMENTARY CONDITIONS

recognizing the condition, immediately stop Work in the affected area and report the condition to the Owner and Architect in writing. Hazardous materials or substances are those hazardous, toxic, or radioactive materials or substances subject to regulations by applicable governmental authorities having jurisdiction, such as, but not limited to, the S.C. Department of Health and Environmental Control, the U.S. Environmental Protection Agency, and the U.S. Nuclear Regulatory Commission.

**3.77** Insert the following at the end of Section 10.3.2:

In the absence of agreement, the Architect will make an interim determination regarding any delay or impact on the Contractor’s additional costs. The Architect’s interim determination of cost shall adjust the Contract Sum on the same basis as a Change Order, subject to the right of either party to disagree and assert a Claim in accordance with Article 15. Any adjustment in the Contract Sum shall be determined in accordance with Section 7.3.3.

**3.78** Delete Section 10.3.3 and substitute the following:

**10.3.3** The Work in the affected area shall be resumed immediately following the occurrence of any one of the following events: (a) the Owner causes remedial work to be performed that results in the absence of hazardous materials or substances; (b) the Owner and the Contractor, by written agreement, decide to resume performance of the Work; or (c) the Work may safely and lawfully proceed, as determined by an appropriate governmental authority or as evidenced by a written report to both the Owner and the Contractor, which is prepared by an environmental engineer reasonably satisfactory to both the Owner and the Contractor.

**3.79** In Section 10.3.5, delete the word “The” at the beginning of the sentence and substitute the following:

In addition to its obligations under Section 3.18, the

**3.80** Delete the language of Section 10.3.6 and substitute the word “Reserved.”

**3.81** Insert the following at the end of Section 10.4:

The Contractor shall immediately give the Architect notice of the emergency. This initial notice may be oral followed within five days by a written notice setting forth the nature and scope of the emergency. Within fourteen days of the start of the emergency, the Contractor shall give the Architect a written estimate of the cost and probable effect of delay on the progress of the Work.

**3.82** Delete 11.1.2 and substitute the following:

**11.1.2** The insurance required by Section 11.1.1 shall be written for not less than limits of liability specified below or required by law, whichever coverage is greater. Coverages shall be written on an occurrence basis and shall be maintained without interruption from the date of commencement of the Work until the date of final payment and termination of any coverage required to be maintained after final payment, and, with respect to the Contractor’s completed operations coverage, until the expiration of the period for correction of Work or for such other period for maintenance of completed operations coverage as specified in the Contract Documents.

**(1) COMMERCIAL GENERAL LIABILITY:**

- (a)** General Aggregate (per project) \_\_\_\_\_ \$2,000,000
- (b)** Products/Completed Operations \_\_\_\_\_ \$2,000,000
- (c)** Personal and Advertising Injury \_\_\_\_\_ \$1,000,000
- (d)** Each Occurrence \_\_\_\_\_ \$1,000,000

**(2) BUSINESS AUTO LIABILITY (including All Owned, Non-owned, and Hired Vehicles):**

Automobile Bodily Injury and Property Damage Liability Insurance shall be carried on all automobiles, trucks, and similar vehicles that will be used in any phase of the Work required under this Contract. The minimum limits of liability required for such insurance are as follows:

- (a)** Combined Single Limit \_\_\_\_\_ \$1,000,000

**(3) WORKER’S COMPENSATION – Statutory – and Employers’ Liability Insurance** that complies with the laws of the State of South Carolina shall be carried on all employees engaged in any and all phases of the Work required under this Contract, with minimum limits as follows:

**(4) WORKER’S COMPENSATION:**

Statutory

- (a)** State Statutory

- (b)** Employers Liability \_\_\_\_\_ \$500,000 Per Acc.

STANDARD SUPPLEMENTARY CONDITIONS

- \_\_\_\_\_ \$500,000 Disease, Policy Limit  
\_\_\_\_\_ \$500,000 Disease, Each Employee
- (5) Excess Umbrella Liability (occurrence Form) with minimum limits as follows:
- (a) Each Occurrence: \_\_\_\_\_ \$2,000,000
  - (b) Aggregate \_\_\_\_\_ \$2,000,000
- (6) Owner's & Contractor's Protective Bodily Injury and Property Damage Liability Insurance must be provided by the Contractor for the benefit of the Owner covering the entire operation involved in the Contract. The minimum limits of liability required for such insurance are as follows:
- (a) Same Limits as General Liability Coverage.
  - (b) Extend policy to include interest of Architects.

**3.83** Delete Section 11.1.3 and substitute the following:

**11.1.3** Prior to commencement of the Work, and thereafter upon replacement of each required policy of insurance, Contractor shall provide to the Owner a written endorsement to the Contractor's general liability insurance policy that:

- (i) names the Owner as an additional insureds for claims caused in whole or in part by the Contractor's negligent acts or omissions during the Contractor's operations;
- (ii) provides that no material alteration, cancellation, non-renewal, or expiration of the coverage contained in such policy shall have effect unless all additional insureds have been given at least ten (10) days prior written notice of cancellation for non-payment of premiums and thirty (30) days prior written notice of cancellation for any other reason; and
- (iii) provides that the Contractor's liability insurance policy shall be primary, with any liability insurance of the Owner as secondary and noncontributory.

Prior to commencement of the Work, and thereafter upon renewal or replacement of each required policy of insurance, Contractor shall provide to the Owner a signed, original certificate of liability insurance (ACORD 25). Consistent with this Section 11.1, the certificate shall identify the types of insurance, state the limits of liability for each type of coverage, name the Owner a Consultants as Certificate Holder, provide that the general aggregate limit applies per project, and provide that coverage is written on an occurrence basis. Both the certificates and the endorsements must be received directly from either the Contractor's insurance agent or the insurance company. An additional certificate evidencing continuation of liability coverage, including coverage for completed operations, naming the Owner as an additional insured for claims made under the Contractor's completed operations, and otherwise meeting the above requirements, shall be submitted with the final Application for Payment as required by Section 9.10.2 and thereafter upon renewal or replacement of such coverage until the expiration of the time required by Section 11.1.2. Information concerning reduction of coverage on account of revised limits or claims paid under the General Aggregate, or both, shall be furnished by the Contractor with reasonable promptness.

**3.84** Delete Section 11.1.4 and substitute the following:

**11.1.4** A failure by the Owner either (i) to demand a certificate of insurance or written endorsement required by Section 11.1, or (ii) to reject a certificate or endorsement on the grounds that it fails to comply with Section 11.1 shall not be considered a waiver of Contractor's obligations to obtain the required insurance.

**3.85** In Section 11.3.1, delete the first sentence and substitute the following:

Unless otherwise provided in the Contract Documents, the Contractor shall purchase and maintain, in a company or companies lawfully authorized to do business in the jurisdiction in which the Project is located, property insurance written on a builder's risk "all-risk" or equivalent policy form in the amount of the initial Contract Sum, plus value of subsequent Contract Modifications and cost of materials supplied or installed by others, comprising total value for the entire Project at the site on a replacement cost basis.

**3.86** Delete the language of Section 11.3.1.2 and substitute the word "Reserved."

**3.87** Delete the language of Section 11.3.1.3 and substitute the word "Reserved."



## STANDARD SUPPLEMENTARY CONDITIONS

**3.88** Delete Section 11.3.2 and substitute the following:

### **11.3.2 BOILER AND MACHINERY INSURANCE**

The Contractor shall purchase and maintain boiler and machinery insurance required by the Contract Documents or by law, which shall specifically cover such insured objects during installation and until final acceptance by the Owner; this insurance shall include interests of the Owner, Contractor, Subcontractors and Sub-subcontractors in the Work, and the Owner and Contractor shall both be named insureds.

**3.89** Delete Section 11.3.3 and substitute the following:

### **11.3.3 LOSS OF USE INSURANCE**

The Owner, at the Owner's option, may purchase and maintain such insurance as will insure the Owner against loss of use of the Owner's property due to fire or other hazards, however caused. To the extent any losses are covered and paid for by such insurance, the Owner waives all rights of action against the Contractor for loss of use of the Owner's property, including consequential losses due to fire or other hazards however caused.

**3.90** Delete Section 11.3.4 and substitute the following:

**11.3.4** If the Owner requests in writing that insurance for risks other than those described herein or other special causes of loss be included in the property insurance policy, the Contractor shall, if possible, include such insurance, and the cost thereof shall be charged to the Owner by appropriate Change Order.

**3.91** Delete the language of Section 11.3.5 and substitute the word "Reserved."

**3.92** Delete Section 11.3.6 and substitute the following:

**11.3.6** Before an exposure to loss may occur, the Contractor shall file with the Owner a copy of each policy that includes insurance coverages required by this Section 11.3. Each policy shall contain all generally applicable conditions, definitions, exclusions and endorsements related to this Project. Each policy shall contain a provision that the policy will not be canceled or allowed to expire, and that its limits will not be reduced, until at least 30 days' prior written notice has been given to the Owner.

**3.93** Delete the first sentence of Section 11.3.7 and substitute the following:

The Owner and Contractor waive all rights against (1) each other and any of their subcontractors, sub-subcontractors, agents and employees, each of the other, and (2) the Architect, Architect's consultants, separate contractors described in Article 6, if any, and any of their subcontractors, sub-subcontractors, agents and employees, for damages caused by fire or other causes of loss to the extent the property insurance provided by the Contractor pursuant to this Section 11.3 covers and pays for the damage, except such rights as they have to proceeds of such insurance held by the Contractor as fiduciary.

**3.94** Delete the first sentence of Section 11.3.8 and substitute the following:

A loss insured under the Contractor's property insurance shall be adjusted by the Contractor as fiduciary and made payable to the Contractor as fiduciary for the insureds, as their interests may appear, subject to requirements of any applicable mortgagee clause and of Section 11.3.10.

**3.95** Delete Section 11.3.9 and substitute the following:

**11.3.9** If required in writing by a party in interest, the Contractor as fiduciary shall, upon occurrence of an insured loss, give bond for proper performance of the Contractor's duties. The cost of required bonds shall be charged against proceeds received as fiduciary. The Contractor shall deposit in a separate account proceeds so received, which the Contractor shall distribute in accordance with such agreement as the parties in interest may reach. If after such loss no other special agreement is made and unless the Owner terminates the Contract for convenience, replacement of damaged property shall be performed by the Contractor.

**3.96** Delete Section 11.3.10 and substitute the following:

**11.3.10** The Contractor as fiduciary shall have power to adjust and settle a loss with insurers unless one of the parties in interest shall object in writing within five days after occurrence of loss to the Contractor's exercise of this power; if such objection is made, the dispute shall be resolved in the manner provided in the contract between the parties in dispute as the method of binding dispute resolution. The Contractor as fiduciary shall make settlement with insurers or, in the case of a dispute over distribution of insurance proceeds, in accordance with a final order or determination issued by the appropriate authority having jurisdiction over the dispute.

**3.97** Delete Section 11.4.1 and substitute the following:

## STANDARD SUPPLEMENTARY CONDITIONS

**11.4.1** Before commencing any services hereunder, the Contractor shall provide the Owner with Performance and Payment Bonds, each in an amount not less than the Contract Price set forth in Article 4 of the Agreement. The Surety shall have, at a minimum, a "Best Rating" of "A" as stated in the most current publication of "Best's Key Rating Guide, Property-Casualty". In addition, the Surety shall have a minimum "Best Financial Strength Category" of "Class V", and in no case less than five (5) times the contract amount. The Performance Bond shall be written on Form SE-355, "Performance Bond" and the Payment Bond shall be written on Form SE-357, "Labor and Material Payment Bond", and both shall be made payable to the Owner.

**3.98** Delete Section 11.4.2 and substitute the following:

**11.4.2** The Performance and Labor and Material Payment Bonds shall:

- .1** be issued by a surety company licensed to do business in South Carolina;
- .2** be accompanied by a current power of attorney and certified by the attorney-in-fact who executes the bond on the behalf of the surety company; and
- .3** remain in effect for a period not less than one (1) year following the date of Substantial Completion or the time required to resolve any items of incomplete Work and the payment of any disputed amounts, whichever time period is longer.

**3.99** Add the following Sections 11.4.3 and 11.4.4:

**11.4.3** Any bonds required by this Contract shall meet the requirements of the South Carolina Code of Laws and Regulations, as amended.

**11.4.4** Upon the request of any person or entity appearing to be a potential beneficiary of bonds covering payment of obligations arising under the Contract, the Contractor shall promptly furnish a copy of the bonds or shall authorize a copy to be furnished.

**3.100** Delete Section 12.1.1 and substitute the following:

**12.1.1** If a portion of the Work is covered contrary to the to requirements specifically expressed in the Contract Documents, including inspections of work-in-progress required by all authorities having jurisdiction over the Project, it must, upon demand of the Architect or authority having jurisdiction, be uncovered for observation and be replaced at the Contractor's expense without change in the Contract Time.

**3.101** In Section 12.2.2.1, delete the words "and to make a claim for breach of warranty" at the end of the third sentence.

**3.102** In Section 12.2.2.3, add the following to the end of the sentence:  
unless otherwise provided in the Contract Documents.

**3.103** Insert the following at the end of Section 12.2.4:

If, prior to the date of Substantial Completion, the Contractor, a Subcontractor, or anyone for whom either is responsible, uses or damages any portion of the Work, including, without limitation, mechanical, electrical, plumbing, and other building systems, machinery, equipment, or other mechanical device, the Contractor shall cause such item to be restored to "like new" condition at no expense to the Owner.

**3.104** Delete Section 13.1 and substitute the following:

### **13.1 GOVERNING LAW**

The Contract, any dispute, claim, or controversy relating to the Contract, and all the rights and obligations of the parties shall, in all respects, be interpreted, construed, enforced and governed by and under the laws of the State of South Carolina, except its choice of law rules.

**3.105** Delete Section 13.2, including its Sub-Sections 13.2.1 and 13.2.2, and substitute the following:

### **13.2 SUCCESSORS AND ASSIGNS**

The Owner and Contractor respectively bind themselves, their partners, successors, assigns and legal representatives to covenants, agreements and obligations contained in the Contract Documents. Neither party to the Contract shall assign the Contract as a whole, or in part, without written consent of the other and then only in accordance with and as permitted by Regulation 19-445.2180 of the South Carolina Code of Regulations, as amended. If either party attempts to make such an assignment without such consent, that party shall nevertheless remain legally responsible for all obligations under the Contract.

**3.106** Delete Section 13.3 and substitute the following:

## STANDARD SUPPLEMENTARY CONDITIONS

### **13.3 WRITTEN NOTICE**

Unless otherwise permitted herein, all notices contemplated by the Contract Documents shall be in writing and shall be deemed given:

- .1 upon actual delivery, if delivery is by hand;
- .2 upon receipt by the transmitting party of confirmation or reply, if delivery is by electronic mail, facsimile, telex or telegram;
- .3 upon receipt, if delivery is by the United States mail.

Notice to Contractor shall be to the address provided in Section 8.3.2 of the Agreement. Notice to Owner shall be to the address provided in Section 8.2.2 of the Agreement. Either party may designate a different address for notice by giving notice in accordance with this paragraph.

**3.107** In Section 13.4.1, insert the following at the beginning of the sentence:

Unless expressly provided otherwise,

**3.108** Add the following Section 13.4.3:

**13.4.3** Notwithstanding Section 9.10.4, the rights and obligations which, by their nature, would continue beyond the termination, cancellation, rejection, or expiration of this contract shall survive such termination, cancellation, rejection, or expiration, including, but not limited to, the rights and obligations created by the following clauses:

- 1.5** Ownership and Use of Drawings, Specifications and Other Instruments of Service;
- 3.5** Warranty
- 3.17** Royalties, Patents and Copyrights
- 3.18** Indemnification
- 7.6** Cost or Pricing Data
- 11.1** Contractor's Liability Insurance
- 11.4** Performance and Payment Bond
- 15.1.6** Claims for Listed Damages
- 15.1.7** Waiver of Claims Against the Architect
- 15.6** Dispute Resolution
- 15.6.5** Service of Process

**3.109** Delete Section 13.6 and substitute the following:

### **13.6 INTEREST**

Payments due to the Contractor and unpaid under the Contract Documents shall bear interest only if and to the extent allowed by Title 29, Chapter 6, Article 1 of the South Carolina Code of Laws. Amounts due to the Owner shall bear interest at the rate of one percent a month or a pro rata fraction thereof on the unpaid balance as may be due.

**3.110** Delete the language of Section 13.7 and substitute the word "Reserved."

**3.111** Add the following Sections 13.8 through 13.16:

### **13.8 PROCUREMENT OF MATERIALS BY OWNER**

The Contractor accepts assignment of all purchase orders and other agreements for procurement of materials and equipment by the Owner that are identified as part of the Contract Documents. The Contractor shall, upon delivery, be responsible for the storage, protection, proper installation, and preservation of such Owner purchased items, if any, as if the Contractor were the original purchaser. The Contract Sum includes, without limitation, all costs and expenses in connection with delivery, storage, insurance, installation, and testing of items covered in any assigned purchase orders or agreements. Unless the Contract Documents specifically provide otherwise, all Contractor warranty of workmanship and correction of the Work obligations under the Contract Documents shall apply to the Contractor's installation of and modifications to any Owner purchased items.

### **13.9 INTERPRETATION OF BUILDING CODES**

As required by Title 10, Chapter 1, Section 180 of the South Carolina Code of Laws, as amended, the code official shall determine the enforcement and interpretation of all building codes and referenced standards on

## STANDARD SUPPLEMENTARY CONDITIONS

state buildings. The Contractor shall refer any questions, comments, or directives from local officials to the Owner and the code official for resolution.

### **13.10 MINORITY BUSINESS ENTERPRISES**

Contractor shall notify Owner of each Minority Business Enterprise (MBE) providing labor, materials, equipment, or supplies to the Project under a contract with the Contractor. Contractor's notification shall be via the first monthly status report submitted to the Owner after execution of the contract with the MBE. For each such MBE, the Contractor shall provide the MBE's name, address, and telephone number, the nature of the work to be performed or materials or equipment to be supplied by the MBE, whether the MBE is certified by the South Carolina Office of Small and Minority Business Assistance, and the value of the contract.

### **13.11 SEVERABILITY**

If any provision or any part of a provision of the Contract Documents shall be finally determined to be superseded, invalid, illegal, or otherwise unenforceable pursuant to any applicable Legal Requirements, such determination shall not impair or otherwise affect the validity, legality, or enforceability of the remaining provision or parts of the provision of the Contract Documents, which shall remain in full force and effect as if the unenforceable provision or part were deleted.

### **13.12 ILLEGAL IMMIGRATION**

Contractor certifies and agrees that it will comply with the applicable requirements of Title 8, Chapter 14 of the South Carolina Code of Laws and agrees to provide to the State upon request any documentation required to establish either: (a) that Title 8, Chapter 14 is inapplicable both to Contractor and its subcontractors or sub-subcontractors; or (b) that Contractor and its subcontractors or sub-subcontractors are in compliance with Title 8, Chapter 14. Pursuant to Section 8-14-60, "A person who knowingly makes or files any false, fictitious, or fraudulent document, statement, or report pursuant to this chapter is guilty of a felony and, upon conviction, must be fined within the discretion of the court or imprisoned for not more than five years, or both." Contractor agrees to include in any contracts with its subcontractors language requiring its subcontractors to (a) comply with the applicable requirements of Title 8, Chapter 14, and (b) include in their contracts with the sub-subcontractors language requiring the sub-subcontractors to comply with the applicable requirements of Title 8, Chapter 14. (An overview is available at [www.procurement.sc.gov](http://www.procurement.sc.gov))

### **13.13 SETOFF**

The Owner shall have all of its common law, equitable, and statutory rights of set-off.

### **13.14 DRUG-FREE WORKPLACE**

The Contractor certifies to the Owner that Contractor will provide a Drug-Free Workplace, as required by Title 44, Chapter 107 of the South Carolina Code of Laws, as amended.

### **13.15 FALSE CLAIMS**

According to the S.C. Code of Laws § 16-13-240, "a person who by false pretense or representation obtains the signature of a person to a written instrument or obtains from another person any chattel, money, valuable security, or other property, real or personal, with intent to cheat and defraud a person of that property is guilty" of a crime.

### **13.16 NON-INDEMNIFICATION:**

Any term or condition is void to the extent it requires the State to indemnify anyone. It is unlawful for a person charged with disbursements of state funds appropriated by the General Assembly to exceed the amounts and purposes stated in the appropriations. (§ 11-9-20) It is unlawful for an authorized public officer to enter into a contract for a purpose in which the sum is in excess of the amount appropriated for that purpose. It is unlawful for an authorized public officer to divert or appropriate the funds arising from any tax levied and collected for any one fiscal year to the payment of an indebtedness contracted or incurred for a previous year. (§ 11-1-40)

### **3.112 Delete Section 14.1.1 and substitute the following:**

**14.1.1** The Contractor may terminate the Contract if the Work is stopped for a period of 45 consecutive days through no act or fault of the Contractor or a Subcontractor, Sub-subcontractor or their agents or employees or any other persons or entities performing portions of the Work under direct or indirect contract with the Contractor, for any of the following reasons:

- .1** Issuance of an order of a court or other public authority having jurisdiction that requires substantially all Work to be stopped; or
- .2** An act of government, such as a declaration of national emergency that requires substantially all Work to be stopped.

## STANDARD SUPPLEMENTARY CONDITIONS

- .3 Because the Architect has not issued a Certificate for Payment and has not notified the Contractor of the reason for withholding certification as provided in Section 9.4.1, or because the Owner has not made payment on a Certificate for Payment within the time stated in the Contract Documents and the Contractor has stopped work in accordance with Section 9.7

**3.113** Insert the following at the end of Section 14.1.3:

Any adjustment to the Contract Sum pursuant to this Section shall be made in accordance with the requirements of Article 7.

**3.114** In Section 14.1.4, replace the word “repeatedly” with the word “persistently.”

**3.115** Delete Section 14.2.1 and substitute the following:

**14.2.1** The Owner may terminate the Contract if the Contractor

- .1 repeatedly refuses or fails to supply enough properly skilled workers or proper materials, or otherwise fails to prosecute the Work, or any separable part of the Work, with the diligence, resources and skill that will ensure its completion within the time specified in the Contract Documents, including any authorized adjustments;
- .2 fails to make payment to Subcontractors for materials or labor in accordance with the Contract Documents and the respective agreements between the Contractor and the Subcontractors;
- .3 repeatedly disregards applicable laws, statutes, ordinances, codes, rules and regulations, or lawful orders of a public authority; or
- .4 otherwise is guilty of substantial breach of a provision of the Contract Documents.

**3.116** In Section 14.2.2, delete the parenthetical statement “, upon certification by the Initial Decision Maker that sufficient cause exists to justify such action,” immediately following the word “Owner” in the first line.

**3.117** In Section 14.2.4, replace the words “Initial Decision Maker” with the word “Architect”

**3.118** Add the following Section 14.2.5:

**14.2.5** If, after termination for cause, it is determined that the Owner lacked justification to terminate under Section 14.2.1, or that the Contractor’s default was excusable, the rights and obligations of the parties shall be the same as if the termination had been issued for the convenience of the Owner under Section 14.4.

**3.119** Delete the second sentence of Section 14.3.2 and substitute the following:

Any adjustment to the Contract Sum made pursuant to this section shall be made in accordance with the requirements of Article 7.3.3.

**3.120** Delete Section 14.4.1 and substitute the following:

**14.4.1** The Owner may, at any time, terminate the Contract, in whole or in part for the Owner’s convenience and without cause. The Owner shall give written notice of the termination to the Contractor specifying the part of the Contract terminated and when termination becomes effective.

**3.121** Delete Section 14.4.2 and substitute the following:

**14.4.2** Upon receipt of written notice from the Owner of such termination for the Owner’s convenience, the Contractor shall

- .1 cease operations as directed by the Owner in the notice;
- .2 take actions necessary, or that the Owner may direct, for the protection and preservation of the Work;
- .3 except for Work directed to be performed prior to the effective date of termination stated in the notice, terminate all existing subcontracts and purchase orders and enter into no further subcontracts and purchase orders; and
- .4 **complete the performance of the Work not terminated, if any.**

**3.122** Delete Section 14.4.3 and substitute the following:

**14.4.3** In case of such termination for the Owner’s convenience, the Contractor shall be entitled to receive payment for Work executed, costs incurred by reason of such termination, and any other adjustments otherwise allowed by the Contract. Any adjustment to the Contract Sum made pursuant to this Section 14.4 shall be made in accordance with the requirements of Article 7.3.3.

## STANDARD SUPPLEMENTARY CONDITIONS

### 3.123 Add the following Sections 14.4.4, 14.4.5, and 14.5:

**14.4.4** Contractor's failure to include an appropriate termination for convenience clause in any subcontract shall not (i) affect the Owner's right to require the termination of a subcontract, or (ii) increase the obligation of the Owner beyond what it would have been if the subcontract had contained an appropriate clause.

**14.4.5** Upon written consent of the Contractor, the Owner may reinstate the terminated portion of this Contract in whole or in part by amending the notice of termination if it has been determined that:

- .1 the termination was due to withdrawal of funding by the General Assembly, Governor, or State Fiscal Accountability Authority or the need to divert project funds to respond to an emergency as defined by Regulation 19-445.2110(B) of the South Carolina Code of Regulations, as amended;
- .2 funding for the reinstated portion of the work has been restored;
- .3 circumstances clearly indicate a requirement for the terminated work; and
- .4 reinstatement of the terminated work is advantageous to the Owner.

### **14.5 CANCELLATION AFTER AWARD BUT PRIOR TO PERFORMANCE**

Pursuant to Title 11, Chapter 35 and Regulation 19-445.2085 of the South Carolina Code of Laws and Regulations, as amended, this contract may be canceled after award but prior to performance.

### 3.124 Insert the following sentence after the second sentence of Section 15.1.1:

A voucher, invoice, payment application or other routine request for payment that is not in dispute when submitted is not a Claim under this definition.

### 3.125 Delete Section 15.1.2 and substitute the following:

#### **15.1.2 NOTICE OF CLAIMS**

Claims by either the Owner or Contractor must be initiated by written notice to the other party and to the Architect. Such notice shall include sufficient information to advise the Architect and other party of the circumstances giving rise to the claim, the specific contractual adjustment or relief requested and the basis of such request. Claims by either party arising prior to the date final payment is due must be initiated within 21 days after occurrence of the event giving rise to such Claim or within 21 days after the claimant first recognizes the condition giving rise to the Claim, whichever is later except as stated for adverse weather days in Section 15.1.5.2.

By failing to give written notice of a Claim within the time required by this Section, a party expressly waives its claim.

### 3.126 Delete Section 15.1.3 and substitute the following:

#### **15.1.3 CONTINUING CONTRACT PERFORMANCE**

Pending final resolution of a Claim, including any administrative review allowed under Section 15.6, except as otherwise agreed in writing or as provided in Section 9.7 and Article 14, the Contractor shall proceed diligently with performance of the Contract and the Owner shall continue to make payments in accordance with the Contract Documents. The Architect will issue Certificates for Payment in accordance with the initial decisions and determinations of the Architect.

### 3.127 Insert the following at the end of Section 15.1.6.1:

Claims for an increase in the Contract Time shall be based on one additional calendar day for each full calendar day that the Contractor is prevented from working.

### 3.128 Insert the following Sub-Sections at the end of Section 15.1.6.2:

- .1 Claims for adverse weather shall be based on actual weather conditions at the job site or other place of performance of the Work, as documented in the Contractor's job site log.
- .2 For the purpose of this Contract, a total of five (5) days per calendar month (non-cumulative) shall be anticipated as "adverse weather" at the job site, and such time will not be considered justification for an extension of time. If, in any month, adverse weather develops a precipitation/water amount of .01" or greater beyond the five (5) days, the Contractor shall be allowed to claim additional days to compensate for the excess weather delays only to the extent of the impact on the approved construction schedule and days the contractor was already scheduled to work. The remedy for this condition is for an extension of time only and is exclusive of all other rights and remedies available under the Contract Documents or imposed or available by law.

## STANDARD SUPPLEMENTARY CONDITIONS

.3 The Contractor shall submit monthly with their pay application all claims for adverse weather conditions that occurred during the previous month. The Architect shall review each monthly submittal in accordance with Section 15.5 and inform the Contractor and the Owner promptly of its evaluation. Approved days shall be included in the next Change Order issued by the Architect. Adverse weather conditions not claimed within the time limits of this Subparagraph shall be considered to be waived by the Contractor. Claims will not be allowed for adverse weather days that occur after the scheduled (original or adjusted) date of Substantial Completion.

**3.129** Delete Section 15.1.6 and substitute the following:

### **15.1.6 CLAIMS FOR LISTED DAMAGES**

Notwithstanding any other provision of the Contract Documents, including Section 1.2.1, but subject to a duty of good faith and fair dealing, the Contractor and Owner waive Claims against each other for listed damages arising out of or relating to this Contract.

**15.1.6.1** For the Owner, listed damages are (i) lost revenue and profit, (ii) losses resulting from injury to business or reputation, (iii) additional or escalated overhead and administration expenses, (iv) additional financing costs, (v) costs suffered by a third party unable to commence work, (vi) attorney's fees, (vii) any interest, except to the extent allowed by Section 13.6 (Interest), (viii) lost revenue and profit for lost use of the property, (ix) costs resulting from lost productivity or efficiency.

**15.1.6.2** For the Contractor, listed damages are (i) lost revenue and profit, (ii) losses resulting from injury to business or reputation, (iii) additional or escalated overhead and administration expenses, (iv) additional financing costs, (v) attorney's fees, (vi) any interest, except to the extent allowed by Section 13.6 (Interest); (vii) unamortized equipment costs; and, (viii) losses incurred by subcontractors for the types of damages the Contractor has waive as against the Owner. Without limitation, this mutual waiver is applicable to all damages due to either party's termination in accordance with Article 14.

**15.1.6.3** Nothing contained in this Section shall be deemed to preclude an award of liquidated damages, when applicable, in accordance with the requirements of the Contract Documents. This mutual waiver is not applicable to amounts due or obligations under Section 3.18 (Indemnification).

**3.130** Add the following Section 15.1.7:

### **15.1.7 WAIVER OF CLAIMS AGAINST THE ARCHITECT**

Notwithstanding any other provision of the Contract Documents, including Section 1.2.1, but subject to a duty of good faith and fair dealing, the Contractor waives all claims against the Architect and any other design professionals who provide design and/or project management services to the Owner, either directly or as independent contractors or subcontractors to the Architect, for listed damages arising out of or relating to this Contract. The listed damages are (i) lost revenue and profit, (ii) losses resulting from injury to business or reputation, (iii) additional or escalated overhead and administration expenses, (iv) additional financing costs, (v) attorney's fees, (vi) any interest; (vii) unamortized equipment costs; and, (viii) losses incurred by subcontractors for the types of damages the Contractor has waive as against the Owner. This mutual waiver is not applicable to amounts due or obligations under Section 3.18 (Indemnification).

**3.131** Delete the language of Sections 15.2, 15.3, and 15.4, including all Sub-Sections, and substitute the word "Reserved" for the deleted language of each Section and Sub-Section.

**3.132** Add the following Sections 15.5 and 15.6 with their sub-sections:

### **15.5 CLAIM AND DISPUTES - DUTY OF COOPERATION, NOTICE, AND ARCHITECTS INITIAL DECISION**

**15.5.1** Contractor and Owner are fully committed to working with each other throughout the Project to avoid or minimize claims. To further this goal, Contractor and Owner agree to communicate regularly with each other and the Architect at all times notifying one another as soon as reasonably possible of any issue that if not addressed may cause loss, delay, and/or disruption of the Work. If claims do arise, Contractor and Owner each commit to resolving such claims in an amicable, professional, and expeditious manner to avoid unnecessary losses, delays, and disruptions to the Work.

**15.5.2** Claims shall first be referred to the Architect for initial decision. An initial decision shall be required as a condition precedent to resolution pursuant to Section 15.6 of any Claim arising



prior to the date of final payment, unless 30 days have passed after the Claim has been referred to the Architect with no decision having been rendered, or after all the Architect's requests for additional supporting data have been answered, whichever is later. The Architect will not address claims between the Contractor and persons or entities other than the Owner.

- 15.5.3** The Architect will review Claims and within ten days of the receipt of a Claim (1) request additional supporting data from the claimant or a response with supporting data from the other party or (2) render an initial decision in accordance with Section 15.5.5.
- 15.5.4** If the Architect requests a party to provide a response to a Claim or to furnish additional supporting data, such party shall respond, within ten days after receipt of such request, and shall either (1) provide a response on the requested supporting data, (2) advise the Architect when the response or supporting data will be furnished or (3) advise the Architect that all supporting data has already been provided. Upon receipt of the response or supporting data, the Architect will render an initial decision in accordance with Section 15.5.5.
- 15.5.5** The Architect will render an initial decision in writing; (1) stating the reasons therefor; and (2) notifying the parties of any change in the Contract Sum or Contract Time or both. The Architect will deliver the initial decision to the parties within two weeks of receipt of any response or supporting data requested pursuant to Section 16.4 or within such longer period as may be mutually agreeable to the parties. If the parties accept the initial decision, the Architect shall prepare a Change Order with appropriate supporting documentation for the review and approval of the parties. If either the Contractor, Owner, or both, disagree with the initial decision, the Contractor and Owner shall proceed with dispute resolution in accordance with the provisions of Section 15.6.
- 15.5.6** In the event of a Claim against the Contractor, the Owner may, but is not obligated to, notify the surety, if any, of the nature and amount of the Claim. If the Claim relates to a possibility of a Contractor's default, the Owner may, but is not obligated to, notify the surety and request the surety's assistance in resolving the controversy.

## **15.6 DISPUTE RESOLUTION**

- 15.6.1** If a claim is not resolved pursuant to Section 15.5 to the satisfaction of either party, both parties shall attempt to resolve the dispute at the field level through discussions between Contractor's Representative and Owner's Representative. If a dispute cannot be resolved through Contractor's Representative and Owner's Representative, then the Contractor's Senior Representative and the Owner's Senior Representative, upon the request of either party, shall meet as soon as conveniently possible, but in no case later than twenty-one days after such a request is made, to attempt to resolve such dispute. Prior to any meetings between the Senior Representatives, the parties will exchange relevant information that will assist the parties in resolving their dispute. The meetings required by this Section are a condition precedent to resolution pursuant to Section 15.6.2.
- 15.6.2** If after meeting in accordance with the provisions of Section 15.6.1, the Senior Representatives determine that the dispute cannot be resolved on terms satisfactory to both the Contractor and the Owner, then either party may submit the dispute by written request to South Carolina's Chief Procurement Officer for Construction (CPOC). **Except as otherwise provided in Article 15, all claims, claims, or controversies relating to the Contract shall be resolved exclusively by the appropriate Chief Procurement Officer in accordance with Title 11, Chapter 35, Article 17 of the South Carolina Code of Laws, or in the absence of jurisdiction, only in the Court of Common Pleas for, or in the absence of jurisdiction a federal court located in, Richland County, State of South Carolina. Contractor agrees that any act by the State regarding the Contract is not a waiver of either the State's sovereign immunity or the State's immunity under the Eleventh Amendment of the United State's Constitution.**
- 15.6.3** If any party seeks resolution to a dispute pursuant to Section 15.6.2, the parties shall participate in non-binding mediation to resolve the claim. If the claim is governed by Title 11, Chapter 35, Article 17 of the South Carolina Code of Laws as amended and the amount in controversy is \$100,000.00 or less, the CPOC shall appoint a mediator, otherwise, the mediation shall be

STANDARD SUPPLEMENTARY CONDITIONS

conducted by an impartial mediator selected by mutual agreement of the parties, or if the parties cannot so agree, a mediator designated by the American Arbitration Association (“AAA”) pursuant to its Construction Industry Mediation Rules. The mediation will be governed by and conducted pursuant to a mediation agreement negotiated by the parties or, if the parties cannot so agree, by procedures established by the mediator.

**15.6.4** Without relieving any party from the other requirements of Sections 15.5 and 15.6, either party may initiate proceedings in the appropriate forum prior to initiating or completing the procedures required by Sections 15.5 and 15.6 if such action is necessary to preserve a claim by avoiding the application of any applicable statutory period of limitation or repose.

**15.6.5 SERVICE OF PROCESS**

Contractor consents that any papers, notices, or process necessary or proper for the initiation or continuation of any claims, claims, or controversies relating to the Contract; for any court action in connection therewith; or for the entry of judgment on any award made, may be served on Contractor by certified mail (return receipt requested) addressed to Contractor at the address provided for the Contractor’s Senior Representative or by personal service or by any other manner that is permitted by law, in or outside South Carolina. Notice by certified mail is deemed duly given upon deposit in the United States mail.

**3.133** Add the following Article 16:

**ARTICLE 16 PROJECT-SPECIFIC REQUIREMENTS AND INFORMATION**

**16.1. Inspection Requirements:** (Indicate the inspection services required by the Contract)

- Special Inspections are required and are not part of the Contract Sum. (see section 014000)
- Building Inspections are required and are not part of the Contract Sum. (see section 014000)

The inspections required for this Work are:

(Indicate which services are required and the provider)

- Civil: \_\_\_\_\_
- Structural: \_\_\_\_\_
- Mechanical: \_\_\_\_\_
- Plumbing: \_\_\_\_\_
- Electrical: \_\_\_\_\_
- Gas: \_\_\_\_\_
- Other (list): Roofing

Remarks: All inspections provided by owner

**16.1.1** Contractor shall schedule and request inspections in an orderly and efficient manner and shall notify the Owner whenever the Contractor schedules an inspection in accordance with the requirements of Section 16.1. Contractor shall be responsible for the cost of inspections scheduled and conducted without the Owner’s knowledge and for any increase in the cost of inspections resulting from the inefficient scheduling of inspections.

DOCUMENT 002513 - PREBID MEETINGS

1.1 PREBID MEETING

A. WM Building Envelope Consultants, LLC will conduct a Prebid meeting as indicated below:

1. Meeting Date: Wednesday, April 21, 2021
2. Meeting Time: 10:00 A.M.
3. Location: McCracken Middle School – 50 Emory Road, Spartanburg, SC

B. Attendance:

1. Attendance at Prebid meeting is **mandatory**.
2. Notice: Bids will only be accepted from bidders represented at the Prebid Meeting and have signed the sign-in sheet.

C. Bidder Questions: Bidders shall submit written questions no later than 12:00 p.m. on Friday, April 23, 2021.

D. Agenda: Prebid meeting agenda will include review of topics that may affect proper preparation and submittal of bids, including the following:

1. Procurement and Contracting Requirements:
  - a. Advertisement for Bids.
  - b. Instructions to Bidders.
  - c. Bidder Qualifications.
  - d. Bonding.
  - e. Insurance.
  - f. Bid Security.
  - g. Bid Form and Attachments.
  - h. Bid Submittal Requirements.
  - i. Bid Submittal Checklist.
  - j. Notice of Award.
2. Communication during Bidding Period:
  - a. Obtaining documents.
  - b. Bidder's Requests for Information.
  - c. Bidder's Substitution Request/Prior Approval Request.
  - d. Addenda.
3. Contracting Requirements:
  - a. Agreement.
  - b. The General Conditions.
  - c. The Supplementary Conditions.
  - d. Other Owner requirements.

4. Construction Documents:
  - a. Scopes of Work.
  - b. Safety Requirements.
  - c. Temporary Facilities.
  - d. Use of Site.
  - e. Work Restrictions.
  - f. Alternates, Allowances, and Unit Prices.
  - g. Substitutions following award.
5. Separate Contracts, if applicable:
  - a. Work by Owner.
  - b. Work of Other Contracts.
6. Schedule:
  - a. Project Schedule.
  - b. Contract Time.
  - c. Liquidated Damages.
  - d. Other Bidder Questions.
7. Site/facility visit or walkthrough.
8. Post-Meeting Addendum.

E. Minutes: Entity responsible for conducting meeting will record and distribute meeting minutes to attendees. Minutes of meeting are issued as Available Information and do not constitute a modification to the Procurement and Contracting Documents. Modifications to the Procurement and Contracting Documents are issued by written Addendum only.

1. Sign-in Sheet: Minutes will include list of meeting attendees.

END OF DOCUMENT 002513



# AIA Document A312™ – 2010

## Performance Bond

**CONTRACTOR:**

*(Name, legal status and address)*

**SURETY:**

*(Name, legal status and principal place of business)*

**OWNER:**

*(Name, legal status and address)*  
Spartanburg School District Seven  
610 Dupre Drive, Spartanburg, SC

**CONSTRUCTION CONTRACT**

Date:

Amount: \$

Description:

*(Name and location)*

Spartanburg School District Seven Multiple School Roof Repair  
Carver Middle School  
Jesse Boyd Elementary School  
McCracken Middle School

**BOND**

Date:

*(Not earlier than Construction Contract Date)*

Amount: \$

Modifications to this Bond:

None

See Section 16

**CONTRACTOR AS PRINCIPAL**

Company: *(Corporate Seal)*

Signature: \_\_\_\_\_

Name and

Title:

*(Any additional signatures appear on the last page of this Performance Bond.)*

**SURETY**

Company: *(Corporate Seal)*

Signature: \_\_\_\_\_

Name and

Title:

*(FOR INFORMATION ONLY — Name, address and telephone)*

**AGENT or BROKER:****OWNER'S REPRESENTATIVE:**

*(Architect, Engineer or other party:)*

**ADDITIONS AND DELETIONS:**

The author of this document has added information needed for its completion. The author may also have revised the text of the original AIA standard form. An *Additions and Deletions Report* that notes added information as well as revisions to the standard form text is available from the author and should be reviewed. A vertical line in the left margin of this document indicates where the author has added necessary information and where the author has added to or deleted from the original AIA text.

This document has important legal consequences. Consultation with an attorney is encouraged with respect to its completion or modification.

Any singular reference to Contractor, Surety, Owner or other party shall be considered plural where applicable.

**§ 1** The Contractor and Surety, jointly and severally, bind themselves, their heirs, executors, administrators, successors and assigns to the Owner for the performance of the Construction Contract, which is incorporated herein by reference.

**§ 2** If the Contractor performs the Construction Contract, the Surety and the Contractor shall have no obligation under this Bond, except when applicable to participate in a conference as provided in Section 3.

**§ 3** If there is no Owner Default under the Construction Contract, the Surety's obligation under this Bond shall arise after

- .1 the Owner first provides notice to the Contractor and the Surety that the Owner is considering declaring a Contractor Default. Such notice shall indicate whether the Owner is requesting a conference among the Owner, Contractor and Surety to discuss the Contractor's performance. If the Owner does not request a conference, the Surety may, within five (5) business days after receipt of the Owner's notice, request such a conference. If the Surety timely requests a conference, the Owner shall attend. Unless the Owner agrees otherwise, any conference requested under this Section 3.1 shall be held within ten (10) business days of the Surety's receipt of the Owner's notice. If the Owner, the Contractor and the Surety agree, the Contractor shall be allowed a reasonable time to perform the Construction Contract, but such an agreement shall not waive the Owner's right, if any, subsequently to declare a Contractor Default;
- .2 the Owner declares a Contractor Default, terminates the Construction Contract and notifies the Surety; and
- .3 the Owner has agreed to pay the Balance of the Contract Price in accordance with the terms of the Construction Contract to the Surety or to a contractor selected to perform the Construction Contract.

**§ 4** Failure on the part of the Owner to comply with the notice requirement in Section 3.1 shall not constitute a failure to comply with a condition precedent to the Surety's obligations, or release the Surety from its obligations, except to the extent the Surety demonstrates actual prejudice.

**§ 5** When the Owner has satisfied the conditions of Section 3, the Surety shall promptly and at the Surety's expense take one of the following actions:

**§ 5.1** Arrange for the Contractor, with the consent of the Owner, to perform and complete the Construction Contract;

**§ 5.2** Undertake to perform and complete the Construction Contract itself, through its agents or independent contractors;

**§ 5.3** Obtain bids or negotiated proposals from qualified contractors acceptable to the Owner for a contract for performance and completion of the Construction Contract, arrange for a contract to be prepared for execution by the Owner and a contractor selected with the Owner's concurrence, to be secured with performance and payment bonds executed by a qualified surety equivalent to the bonds issued on the Construction Contract, and pay to the Owner the amount of damages as described in Section 7 in excess of the Balance of the Contract Price incurred by the Owner as a result of the Contractor Default; or

**§ 5.4** Waive its right to perform and complete, arrange for completion, or obtain a new contractor and with reasonable promptness under the circumstances:

- .1 After investigation, determine the amount for which it may be liable to the Owner and, as soon as practicable after the amount is determined, make payment to the Owner; or
- .2 Deny liability in whole or in part and notify the Owner, citing the reasons for denial.

**§ 6** If the Surety does not proceed as provided in Section 5 with reasonable promptness, the Surety shall be deemed to be in default on this Bond seven days after receipt of an additional written notice from the Owner to the Surety demanding that the Surety perform its obligations under this Bond, and the Owner shall be entitled to enforce any remedy available to the Owner. If the Surety proceeds as provided in Section 5.4, and the Owner refuses the payment or the Surety has denied liability, in whole or in part, without further notice the Owner shall be entitled to enforce any remedy available to the Owner.



§ 7 If the Surety elects to act under Section 5.1, 5.2 or 5.3, then the responsibilities of the Surety to the Owner shall not be greater than those of the Contractor under the Construction Contract, and the responsibilities of the Owner to the Surety shall not be greater than those of the Owner under the Construction Contract. Subject to the commitment by the Owner to pay the Balance of the Contract Price, the Surety is obligated, without duplication, for

- .1 the responsibilities of the Contractor for correction of defective work and completion of the Construction Contract;
- .2 additional legal, design professional and delay costs resulting from the Contractor's Default, and resulting from the actions or failure to act of the Surety under Section 5; and
- .3 liquidated damages, or if no liquidated damages are specified in the Construction Contract, actual damages caused by delayed performance or non-performance of the Contractor.

§ 8 If the Surety elects to act under Section 5.1, 5.3 or 5.4, the Surety's liability is limited to the amount of this Bond.

§ 9 The Surety shall not be liable to the Owner or others for obligations of the Contractor that are unrelated to the Construction Contract, and the Balance of the Contract Price shall not be reduced or set off on account of any such unrelated obligations. No right of action shall accrue on this Bond to any person or entity other than the Owner or its heirs, executors, administrators, successors and assigns.

§ 10 The Surety hereby waives notice of any change, including changes of time, to the Construction Contract or to related subcontracts, purchase orders and other obligations.

§ 11 Any proceeding, legal or equitable, under this Bond may be instituted in any court of competent jurisdiction in the location in which the work or part of the work is located and shall be instituted within two years after a declaration of Contractor Default or within two years after the Contractor ceased working or within two years after the Surety refuses or fails to perform its obligations under this Bond, whichever occurs first. If the provisions of this Paragraph are void or prohibited by law, the minimum period of limitation available to sureties as a defense in the jurisdiction of the suit shall be applicable.

§ 12 Notice to the Surety, the Owner or the Contractor shall be mailed or delivered to the address shown on the page on which their signature appears.

§ 13 When this Bond has been furnished to comply with a statutory or other legal requirement in the location where the construction was to be performed, any provision in this Bond conflicting with said statutory or legal requirement shall be deemed deleted herefrom and provisions conforming to such statutory or other legal requirement shall be deemed incorporated herein. When so furnished, the intent is that this Bond shall be construed as a statutory bond and not as a common law bond.

#### § 14 Definitions

**§ 14.1 Balance of the Contract Price.** The total amount payable by the Owner to the Contractor under the Construction Contract after all proper adjustments have been made, including allowance to the Contractor of any amounts received or to be received by the Owner in settlement of insurance or other claims for damages to which the Contractor is entitled, reduced by all valid and proper payments made to or on behalf of the Contractor under the Construction Contract.

**§ 14.2 Construction Contract.** The agreement between the Owner and Contractor identified on the cover page, including all Contract Documents and changes made to the agreement and the Contract Documents.

**§ 14.3 Contractor Default.** Failure of the Contractor, which has not been remedied or waived, to perform or otherwise to comply with a material term of the Construction Contract.

**§ 14.4 Owner Default.** Failure of the Owner, which has not been remedied or waived, to pay the Contractor as required under the Construction Contract or to perform and complete or comply with the other material terms of the Construction Contract.

**§ 14.5 Contract Documents.** All the documents that comprise the agreement between the Owner and Contractor.

§ 15 If this Bond is issued for an agreement between a Contractor and subcontractor, the term Contractor in this Bond shall be deemed to be Subcontractor and the term Owner shall be deemed to be Contractor.

§ 16 Modifications to this bond are as follows:

*(Space is provided below for additional signatures of added parties, other than those appearing on the cover page.)*

**CONTRACTOR AS PRINCIPAL**

Company: \_\_\_\_\_  
Signature: \_\_\_\_\_  
*(Corporate Seal)*

Name and Title: \_\_\_\_\_  
Address: \_\_\_\_\_

**SURETY**

Company: \_\_\_\_\_  
Signature: \_\_\_\_\_  
*(Corporate Seal)*

Name and Title: \_\_\_\_\_  
Address: \_\_\_\_\_

Init.

/

## Payment Bond

**CONTRACTOR:**

*(Name, legal status and address)*

**SURETY:**

*(Name, legal status and principal place of business)*

**OWNER:**

*(Name, legal status and address)*  
Spartanburg School District Seven  
610 Dupre Drive, Spartanburg, SC

**CONSTRUCTION CONTRACT**

Date:

Amount: \$

Description:

*(Name and location)*

Spartanburg School District Seven Multiple School Roof Repair  
Carver Middle School  
Jesse Boyd Elementary School  
McCracken Middle School

**BOND**

Date:

*(Not earlier than Construction Contract Date)*

Amount: \$

Modifications to this Bond:

None

See Section 18

**CONTRACTOR AS PRINCIPAL**

Company: *(Corporate Seal)*

Signature:

**SURETY**

Company: *(Corporate Seal)*

Signature:

Name and \_\_\_\_\_

Title:

*(Any additional signatures appear on the last page of this Payment Bond.)*

Name and \_\_\_\_\_

Title:

*(FOR INFORMATION ONLY — Name, address and telephone)*

**AGENT or BROKER:**

**OWNER'S REPRESENTATIVE:**

*(Architect, Engineer or other party:)*

**ADDITIONS AND DELETIONS:**

The author of this document has added information needed for its completion. The author may also have revised the text of the original AIA standard form. An *Additions and Deletions Report* that notes added information as well as revisions to the standard form text is available from the author and should be reviewed. A vertical line in the left margin of this document indicates where the author has added necessary information and where the author has added to or deleted from the original AIA text.

This document has important legal consequences. Consultation with an attorney is encouraged with respect to its completion or modification.

Any singular reference to Contractor, Surety, Owner or other party shall be considered plural where applicable.

**§ 1** The Contractor and Surety, jointly and severally, bind themselves, their heirs, executors, administrators, successors and assigns to the Owner to pay for labor, materials and equipment furnished for use in the performance of the Construction Contract, which is incorporated herein by reference, subject to the following terms.

**§ 2** If the Contractor promptly makes payment of all sums due to Claimants, and defends, indemnifies and holds harmless the Owner from claims, demands, liens or suits by any person or entity seeking payment for labor, materials or equipment furnished for use in the performance of the Construction Contract, then the Surety and the Contractor shall have no obligation under this Bond.

**§ 3** If there is no Owner Default under the Construction Contract, the Surety's obligation to the Owner under this Bond shall arise after the Owner has promptly notified the Contractor and the Surety (at the address described in Section 13) of claims, demands, liens or suits against the Owner or the Owner's property by any person or entity seeking payment for labor, materials or equipment furnished for use in the performance of the Construction Contract and tendered defense of such claims, demands, liens or suits to the Contractor and the Surety.

**§ 4** When the Owner has satisfied the conditions in Section 3, the Surety shall promptly and at the Surety's expense defend, indemnify and hold harmless the Owner against a duly tendered claim, demand, lien or suit.

**§ 5** The Surety's obligations to a Claimant under this Bond shall arise after the following:

**§ 5.1** Claimants, who do not have a direct contract with the Contractor,

- .1 have furnished a written notice of non-payment to the Contractor, stating with substantial accuracy the amount claimed and the name of the party to whom the materials were, or equipment was, furnished or supplied or for whom the labor was done or performed, within ninety (90) days after having last performed labor or last furnished materials or equipment included in the Claim; and
- .2 have sent a Claim to the Surety (at the address described in Section 13).

**§ 5.2** Claimants, who are employed by or have a direct contract with the Contractor, have sent a Claim to the Surety (at the address described in Section 13).

**§ 6** If a notice of non-payment required by Section 5.1.1 is given by the Owner to the Contractor, that is sufficient to satisfy a Claimant's obligation to furnish a written notice of non-payment under Section 5.1.1.

**§ 7** When a Claimant has satisfied the conditions of Sections 5.1 or 5.2, whichever is applicable, the Surety shall promptly and at the Surety's expense take the following actions:

**§ 7.1** Send an answer to the Claimant, with a copy to the Owner, within sixty (60) days after receipt of the Claim, stating the amounts that are undisputed and the basis for challenging any amounts that are disputed; and

**§ 7.2** Pay or arrange for payment of any undisputed amounts.

**§ 7.3** The Surety's failure to discharge its obligations under Section 7.1 or Section 7.2 shall not be deemed to constitute a waiver of defenses the Surety or Contractor may have or acquire as to a Claim, except as to undisputed amounts for which the Surety and Claimant have reached agreement. If, however, the Surety fails to discharge its obligations under Section 7.1 or Section 7.2, the Surety shall indemnify the Claimant for the reasonable attorney's fees the Claimant incurs thereafter to recover any sums found to be due and owing to the Claimant.

**§ 8** The Surety's total obligation shall not exceed the amount of this Bond, plus the amount of reasonable attorney's fees provided under Section 7.3, and the amount of this Bond shall be credited for any payments made in good faith by the Surety.

**§ 9** Amounts owed by the Owner to the Contractor under the Construction Contract shall be used for the performance of the Construction Contract and to satisfy claims, if any, under any construction performance bond. By the Contractor furnishing and the Owner accepting this Bond, they agree that all funds earned by the Contractor in the performance of the Construction Contract are dedicated to satisfy obligations of the Contractor and Surety under this Bond, subject to the Owner's priority to use the funds for the completion of the work.

**§ 10** The Surety shall not be liable to the Owner, Claimants or others for obligations of the Contractor that are unrelated to the Construction Contract. The Owner shall not be liable for the payment of any costs or expenses of any Claimant under this Bond, and shall have under this Bond no obligation to make payments to, or give notice on behalf of, Claimants or otherwise have any obligations to Claimants under this Bond.

**§ 11** The Surety hereby waives notice of any change, including changes of time, to the Construction Contract or to related subcontracts, purchase orders and other obligations.

**§ 12** No suit or action shall be commenced by a Claimant under this Bond other than in a court of competent jurisdiction in the state in which the project that is the subject of the Construction Contract is located or after the expiration of one year from the date (1) on which the Claimant sent a Claim to the Surety pursuant to Section 5.1.2 or 5.2, or (2) on which the last labor or service was performed by anyone or the last materials or equipment were furnished by anyone under the Construction Contract, whichever of (1) or (2) first occurs. If the provisions of this Paragraph are void or prohibited by law, the minimum period of limitation available to sureties as a defense in the jurisdiction of the suit shall be applicable.

**§ 13** Notice and Claims to the Surety, the Owner or the Contractor shall be mailed or delivered to the address shown on the page on which their signature appears. Actual receipt of notice or Claims, however accomplished, shall be sufficient compliance as of the date received.

**§ 14** When this Bond has been furnished to comply with a statutory or other legal requirement in the location where the construction was to be performed, any provision in this Bond conflicting with said statutory or legal requirement shall be deemed deleted herefrom and provisions conforming to such statutory or other legal requirement shall be deemed incorporated herein. When so furnished, the intent is that this Bond shall be construed as a statutory bond and not as a common law bond.

**§ 15** Upon request by any person or entity appearing to be a potential beneficiary of this Bond, the Contractor and Owner shall promptly furnish a copy of this Bond or shall permit a copy to be made.

## **§ 16 Definitions**

**§ 16.1 Claim.** A written statement by the Claimant including at a minimum:

- .1 the name of the Claimant;
- .2 the name of the person for whom the labor was done, or materials or equipment furnished;
- .3 a copy of the agreement or purchase order pursuant to which labor, materials or equipment was furnished for use in the performance of the Construction Contract;
- .4 a brief description of the labor, materials or equipment furnished;
- .5 the date on which the Claimant last performed labor or last furnished materials or equipment for use in the performance of the Construction Contract;
- .6 the total amount earned by the Claimant for labor, materials or equipment furnished as of the date of the Claim;
- .7 the total amount of previous payments received by the Claimant; and
- .8 the total amount due and unpaid to the Claimant for labor, materials or equipment furnished as of the date of the Claim.

**§ 16.2 Claimant.** An individual or entity having a direct contract with the Contractor or with a subcontractor of the Contractor to furnish labor, materials or equipment for use in the performance of the Construction Contract. The term Claimant also includes any individual or entity that has rightfully asserted a claim under an applicable mechanic's lien or similar statute against the real property upon which the Project is located. The intent of this Bond shall be to include without limitation in the terms "labor, materials or equipment" that part of water, gas, power, light, heat, oil, gasoline, telephone service or rental equipment used in the Construction Contract, architectural and engineering services required for performance of the work of the Contractor and the Contractor's subcontractors, and all other items for which a mechanic's lien may be asserted in the jurisdiction where the labor, materials or equipment were furnished.

**§ 16.3 Construction Contract.** The agreement between the Owner and Contractor identified on the cover page, including all Contract Documents and all changes made to the agreement and the Contract Documents.

**§ 16.4 Owner Default.** Failure of the Owner, which has not been remedied or waived, to pay the Contractor as required under the Construction Contract or to perform and complete or comply with the other material terms of the Construction Contract.

**§ 16.5 Contract Documents.** All the documents that comprise the agreement between the Owner and Contractor.

**§ 17** If this Bond is issued for an agreement between a Contractor and subcontractor, the term Contractor in this Bond shall be deemed to be Subcontractor and the term Owner shall be deemed to be Contractor.

**§ 18** Modifications to this bond are as follows:

*(Space is provided below for additional signatures of added parties, other than those appearing on the cover page.)*

**CONTRACTOR AS PRINCIPAL**

Company: \_\_\_\_\_  
Signature: \_\_\_\_\_  
*(Corporate Seal)*

Name and Title: \_\_\_\_\_  
Address: \_\_\_\_\_

**SURETY**

Company: \_\_\_\_\_  
Signature: \_\_\_\_\_  
*(Corporate Seal)*

Name and Title: \_\_\_\_\_  
Address: \_\_\_\_\_





# AIA<sup>®</sup> Document G701<sup>™</sup> – 2017

## Change Order

**PROJECT:** *(Name and address)*  
Spartanburg School District Seven  
Multiple School Roof Repair  
Carver MS, Jesse Boyd ES, McCracken MS

**CONTRACT INFORMATION:**  
Contract For: General Construction  
Date:

**CHANGE ORDER INFORMATION:**  
Change Order Number: 001  
Date:

**OWNER:** *(Name and address)*  
Spartanburg School District Seven  
610 Dupre Drive, Spartanburg, SC

**ARCHITECT:** *(Name and address)*  
WM Building Envelope Consultants, LLC  
1501 Chapin Road, Chapin, SC 29036

**CONTRACTOR:** *(Name and address)*

**THE CONTRACT IS CHANGED AS FOLLOWS:**

*(Insert a detailed description of the change and, if applicable, attach or reference specific exhibits. Also include agreed upon adjustments attributable to executed Construction Change Directives.)*

The original Contract Sum was	\$	0.00
The net change by previously authorized Change Orders	\$	0.00
The Contract Sum prior to this Change Order was	\$	0.00
The Contract Sum will be increased by this Change Order in the amount of	\$	0.00
The new Contract Sum including this Change Order will be	\$	0.00

The Contract Time will be increased by Zero (0) days.  
The new date of Substantial Completion will be

**NOTE:** This Change Order does not include adjustments to the Contract Sum or Guaranteed Maximum Price, or the Contract Time, that have been authorized by Construction Change Directive until the cost and time have been agreed upon by both the Owner and Contractor, in which case a Change Order is executed to supersede the Construction Change Directive.

**NOT VALID UNTIL SIGNED BY THE ARCHITECT, CONTRACTOR AND OWNER.**

WM Building Envelope Consultants, LLC  
**ARCHITECT** *(Firm name)*

\_\_\_\_\_  
**CONTRACTOR** *(Firm name)*

Spartanburg School District Seven  
**OWNER** *(Firm name)*

\_\_\_\_\_  
**SIGNATURE**

\_\_\_\_\_  
**SIGNATURE**

\_\_\_\_\_  
**SIGNATURE**

\_\_\_\_\_  
**PRINTED NAME AND TITLE**

\_\_\_\_\_  
**PRINTED NAME AND TITLE**

\_\_\_\_\_  
**PRINTED NAME AND TITLE**

\_\_\_\_\_  
**DATE**

\_\_\_\_\_  
**DATE**

\_\_\_\_\_  
**DATE**

## Application and Certificate for Payment

<b>TO OWNER:</b> Spartanburg School District Seven 610 Dupre Drive, Spartanburg, SC	<b>PROJECT:</b> Spartanburg School District Seven Multiple School Roof Repair Caver MS, Jesse Boyd ES, McCracken MS	<b>APPLICATION NO:</b> 001 <b>PERIOD TO:</b> <b>CONTRACT FOR:</b> General Construction <b>CONTRACT DATE:</b> <b>PROJECT NOS:</b> 2021-25 / / Spartanburg School District 7	<b>Distribution to:</b> OWNER: <input type="checkbox"/> ARCHITECT: <input type="checkbox"/> CONTRACTOR: <input type="checkbox"/> FIELD: <input type="checkbox"/> OTHER: <input type="checkbox"/>
<b>FROM CONTRACTOR:</b>	<b>VIA ARCHITECT:</b>		

### CONTRACTOR'S APPLICATION FOR PAYMENT

Application is made for payment, as shown below, in connection with the Contract. AIA Document G703®, Continuation Sheet, is attached.

1. ORIGINAL CONTRACT SUM .....	\$0.00
2. NET CHANGE BY CHANGE ORDERS .....	\$0.00
3. CONTRACT SUM TO DATE (Line 1 ± 2) .....	\$0.00
4. TOTAL COMPLETED & STORED TO DATE (Column G on G703) .....	\$0.00
<b>5. RETAINAGE:</b>	
a. 0 % of Completed Work (Column D + E on G703)	\$0.00
b. 0 % of Stored Material (Column F on G703)	\$0.00
Total Retainage (Lines 5a + 5b or Total in Column I of G703) .....	\$0.00
6. TOTAL EARNED LESS RETAINAGE .....	\$0.00
(Line 4 Less Line 5 Total)	
7. LESS PREVIOUS CERTIFICATES FOR PAYMENT .....	\$0.00
(Line 6 from prior Certificate)	
8. CURRENT PAYMENT DUE .....	\$0.00
9. BALANCE TO FINISH, INCLUDING RETAINAGE .....	\$0.00
(Line 3 less Line 6)	

CHANGE ORDER SUMMARY	ADDITIONS	DEDUCTIONS
Total changes approved in previous months by Owner	\$0.00	\$0.00
Total approved this Month	\$0.00	\$0.00
<b>TOTALS</b>	<b>\$0.00</b>	<b>\$0.00</b>
<b>NET CHANGES by Change Order</b>		<b>\$0.00</b>

The undersigned Contractor certifies that to the best of the Contractor's knowledge, information and belief the Work covered by this Application for Payment has been completed in accordance with the Contract Documents, that all amounts have been paid by the Contractor for Work for which previous Certificates for Payment were issued and payments received from the Owner, and that current payment shown herein is now due.

### CONTRACTOR:

By: \_\_\_\_\_ Date: \_\_\_\_\_

State of: \_\_\_\_\_

County of: \_\_\_\_\_

Subscribed and sworn to before  
me this \_\_\_\_\_ day of \_\_\_\_\_

Notary Public:

My Commission expires: \_\_\_\_\_

### ARCHITECT'S CERTIFICATE FOR PAYMENT

In accordance with the Contract Documents, based on on-site observations and the data comprising this application, the Architect certifies to the Owner that to the best of the Architect's knowledge, information and belief the Work has progressed as indicated, the quality of the Work is in accordance with the Contract Documents, and the Contractor is entitled to payment of the AMOUNT CERTIFIED.

AMOUNT CERTIFIED ..... \$0.00

*(Attach explanation if amount certified differs from the amount applied. Initial all figures on this Application and on the Continuation Sheet that are changed to conform with the amount certified.)*

### ARCHITECT:

By: \_\_\_\_\_ Date: \_\_\_\_\_

This Certificate is not negotiable. The AMOUNT CERTIFIED is payable only to the Contractor named herein. Issuance, payment and acceptance of payment are without prejudice to any rights of the Owner or Contractor under this Contract.



# AIA Document G703<sup>®</sup> – 1992

## Continuation Sheet

AIA Document G702<sup>®</sup>, Application and Certification for Payment, or G732<sup>™</sup>, Application and Certificate for Payment, Construction Manager as Adviser Edition, containing Contractor's signed certification is attached.  
Use Column I on Contracts where variable retainage for line items may apply.

APPLICATION NO: 001  
APPLICATION DATE:  
PERIOD TO:  
ARCHITECT'S PROJECT NO: 2021-25

A ITEM NO.	B DESCRIPTION OF WORK	C SCHEDULED VALUE	D WORK COMPLETED		F MATERIALS PRESENTLY STORED (NOT IN D OR E)	G TOTAL COMPLETED AND STORED TO DATE (D + E + F)		H BALANCE TO FINISH (C - G)	I RETAINAGE (IF VARIABLE RATE)
			FROM PREVIOUS APPLICATION (D + E)	THIS PERIOD					
		0.00	0.00	0.00	0.00	0.00	0.00%	0.00	0.00
		0.00	0.00	0.00	0.00	0.00	0.00%	0.00	0.00
		0.00	0.00	0.00	0.00	0.00	0.00%	0.00	0.00
		0.00	0.00	0.00	0.00	0.00	0.00%	0.00	0.00
		0.00	0.00	0.00	0.00	0.00	0.00%	0.00	0.00
		0.00	0.00	0.00	0.00	0.00	0.00%	0.00	0.00
		0.00	0.00	0.00	0.00	0.00	0.00%	0.00	0.00
		0.00	0.00	0.00	0.00	0.00	0.00%	0.00	0.00
		0.00	0.00	0.00	0.00	0.00	0.00%	0.00	0.00
		0.00	0.00	0.00	0.00	0.00	0.00%	0.00	0.00
		0.00	0.00	0.00	0.00	0.00	0.00%	0.00	0.00
		0.00	0.00	0.00	0.00	0.00	0.00%	0.00	0.00
		0.00	0.00	0.00	0.00	0.00	0.00%	0.00	0.00
		0.00	0.00	0.00	0.00	0.00	0.00%	0.00	0.00
		0.00	0.00	0.00	0.00	0.00	0.00%	0.00	0.00
		0.00	0.00	0.00	0.00	0.00	0.00%	0.00	0.00
		0.00	0.00	0.00	0.00	0.00	0.00%	0.00	0.00
GRAND TOTAL		\$0.00	\$0.00	\$0.00	\$0.00	\$0.00	0.00%	\$0.00	\$0.00

AIA Document G703<sup>®</sup> – 1992. Copyright © 1963, 1965, 1966, 1967, 1970, 1978, 1983 and 1992 by The American Institute of Architects. All rights reserved. The "American Institute of Architects," "AIA," the AIA Logo, "G703," and "AIA Contract Documents" are registered trademarks and may not be used without permission. This document was produced by AIA software at 11:52:00 ET on 03/26/2021 under Order No.0053318563 which expires on 09/28/2021, is not for resale, is licensed for one-time use only, and may only be used in accordance with the AIA Contract Documents<sup>®</sup> Terms of Service. To report copyright violations, e-mail copyright@aia.org.

User Notes:



# AIA<sup>®</sup> Document G704™ – 2017

## Certificate of Substantial Completion

<b>PROJECT:</b> <i>(name and address)</i> Spartanburg School District Seven Multiple School Roof Repair Carver MS, Jesse Boyd ES, McCracken MS	<b>CONTRACT INFORMATION:</b> Contract For: General Construction  Date:	<b>CERTIFICATE INFORMATION:</b> Certificate Number: 001  Date:
<b>OWNER:</b> <i>(name and address)</i> Spartanburg School District Seven 610 Dupre Drive, Spartanburg SC	<b>ARCHITECT:</b> <i>(name and address)</i> WM Building Envelope Consultants, LLC 1501 Chapin Road, Chapin, SC 29036	<b>CONTRACTOR:</b> <i>(name and address)</i>

The Work identified below has been reviewed and found, to the Architect’s best knowledge, information, and belief, to be substantially complete. Substantial Completion is the stage in the progress of the Work when the Work or designated portion is sufficiently complete in accordance with the Contract Documents so that the Owner can occupy or utilize the Work for its intended use. The date of Substantial Completion of the Project or portion designated below is the date established by this Certificate.  
*(Identify the Work, or portion thereof, that is substantially complete.)*

WM Building Envelope  
Consultants, LLC

ARCHITECT *(Firm Name)*

SIGNATURE

PRINTED NAME AND TITLE

DATE OF SUBSTANTIAL COMPLETION

### WARRANTIES

The date of Substantial Completion of the Project or portion designated above is also the date of commencement of applicable warranties required by the Contract Documents, except as stated below:  
*(Identify warranties that do not commence on the date of Substantial Completion, if any, and indicate their date of commencement.)*

### WORK TO BE COMPLETED OR CORRECTED

A list of items to be completed or corrected is attached hereto, or transmitted as agreed upon by the parties, and identified as follows:  
*(Identify the list of Work to be completed or corrected.)*

The failure to include any items on such list does not alter the responsibility of the Contractor to complete all Work in accordance with the Contract Documents. Unless otherwise agreed to in writing, the date of commencement of warranties for items on the attached list will be the date of issuance of the final Certificate of Payment or the date of final payment, whichever occurs first. The Contractor will complete or correct the Work on the list of items attached hereto within ( ) days from the above date of Substantial Completion.

Cost estimate of Work to be completed or corrected: \$

The responsibilities of the Owner and Contractor for security, maintenance, heat, utilities, damage to the Work, insurance, and other items identified below shall be as follows:  
*(Note: Owner’s and Contractor’s legal and insurance counsel should review insurance requirements and coverage.)*

The Owner and Contractor hereby accept the responsibilities assigned to them in this Certificate of Substantial Completion:

<b>CONTRACTOR</b> <i>(Firm Name)</i> Spartanburg School District Seven	SIGNATURE	PRINTED NAME AND TITLE	DATE
<b>OWNER</b> <i>(Firm Name)</i>	SIGNATURE	PRINTED NAME AND TITLE	DATE

**Asbestos Free Warranty**

Project Identification: Multiple School Roof Repair - Carver MS, Jesse Boyd ES & McCracken MS

Agency: Spartanburg School District Seven

Project Locations:

- A. Carver Middle School - 467 South Church Street Spartanburg, SC
- B. Jesse Boyd Elementary School - 1505 Fernwood-Glendale Road Spartanburg, SC
- C. McCracken Middle School - 50 Emory Road Spartanburg, SC

Project Number: IFB# 20-21-05

I, \_\_\_\_\_, certify that \_\_\_\_\_  
(Company Representative) (Company Name)

to the best of the Contractor's knowledge, did not intentionally or knowingly incorporate any asbestos containing materials (ACM) into this project at any time during the course of construction.

\_\_\_\_\_  
(Name and Title of Company Representative)

State of: \_\_\_\_\_

County of: \_\_\_\_\_

Subscribed and sworn to before \_\_\_\_\_, this \_\_\_\_ day of \_\_\_\_\_, 20\_\_.

Notary Public: \_\_\_\_\_

My Commission Expires: \_\_\_\_\_

## SECTION 011000 - SUMMARY

### PART 1 - GENERAL

#### 1.1 RELATED DOCUMENTS

- A. Drawings and general provisions of the Contract, including General and Supplementary Conditions and other Division 01 Specification Sections, apply to this Section.

#### 1.2 SUMMARY

- A. Section Includes:

- 1. Project information.
- 2. Work covered by Contract Documents.
- 3. Access to site.
- 4. Coordination with occupants.
- 5. Work restrictions.

- B. Related Requirements:

- 1. Division 01 General Requirements: Requirements of Sections in Division 01 apply to the Work of all Sections in the Specifications.

#### 1.3 PROJECT INFORMATION

- A. Project Identification: Multiple School Roof Repair - Carver MS, Jesse Boyd ES & McCracken MS

- 1. Project Location:

- a. Carver Middle School - 467 South Church Street Spartanburg, SC
- b. Jesse Boyd Elementary School - 1505 Fernwood-Glendale Road Spartanburg, SC
- c. McCracken Middle School – 50 Emory Road, Spartanburg, SC

- B. Owner: Spartanburg School District Seven

- 1. Owner's Representative: Mr. Terry Gilmer, 610 Dupre Drive, Spartanburg, SC 29307.

- C. Consultant: Daniel Atwell, WM Building Envelope Consultants, LLC, 1501 Chapin Road, Chapin, SC. Phone: 803-422-7493 or [daniel@wmbeconsultants.com](mailto:daniel@wmbeconsultants.com)

#### 1.4 GENERAL SUMMARY

1. Base Bid scope of work includes miscellaneous selective roof repairs of the low slope roof areas at multiple schools as designated on the drawings. All new sheet metal items associated with the installation of the new repair work are required.
2. Alternate No. 1 scope of work includes roof membrane repair work at McCracken Middle School on Roof Areas U, U1, U2 and V. All other requirements remain unchanged.

#### 1.5 ACCESS TO SITE

- A. General: Contractor shall have limited use of Project site for construction operations. These locations will be determined at the pre-bid conference.
- B. Use of Site: Limit use of project site to areas of work. Do not disturb portions of project site beyond areas in which the Work is indicated.
  1. Limits: Confine construction operations to areas of work.
  2. Driveways, Walkways and Entrances: Keep driveways, loading areas, and entrances serving premises clear and available to Owner, Owner's employees, and emergency vehicles at all times. Do not use these areas for parking or storage of materials.
    - a. Schedule deliveries to minimize use of driveways and entrances by construction operations.
    - b. Schedule deliveries to minimize space and time requirements for storage of materials and equipment on-site.
- C. Condition of Existing Building: Maintain all areas of existing building affected by construction operations in a weathertight condition throughout construction period. Repair damage caused by construction operations.
  - a. Proper temporary protection of the gymnasium floors is required at all times during construction. Temporary protection may be required to be removed, both full or in part, to allow Owner temporary use.

#### 1.6 COORDINATION WITH OCCUPANTS

- A. Full Owner Occupancy: Owner will occupy site and adjacent building(s) during portions of the construction period. Cooperate with Owner during construction operations to minimize conflicts and facilitate Owner usage. Perform the Work so as not to interfere with Owner's day-to-day operations. Maintain existing exits unless otherwise indicated.
  1. Maintain access to existing walkways, corridors, and other adjacent occupied or used facilities. Do not close or obstruct walkways, corridors, or other occupied or used facilities without written permission from Owner and approval of authorities having jurisdiction.



2. Notify Owner not less than 72 hours in advance of activities that will affect Owner's operations.

## 1.7 WORK RESTRICTIONS

- A. Work Restrictions, General: Comply with restrictions on construction operations.
  1. Comply with limitations on use of public streets and with other requirements of authorities having jurisdiction.
  2. Comply with limitations during scheduled exam testing times.
- B. On-Site Work Hours: Monday – Friday (7am – 5pm) Limit work on the existing building to normal business working hours, Monday through Friday, unless otherwise approved by owner.
  1. Weekend Hours: Weekend work must be coordinated and approved by the Owner minimum of 48 hours prior to requested date.
  2. Early Morning Hours: Work occurring during early morning hours must be coordinated and approved by the Owner.
- C. Existing Utility Interruptions: Do not interrupt utilities serving facilities occupied by Owner or others unless permitted under the following conditions and then only after providing temporary utility services according to requirements indicated:
  1. Notify Consultant and Owner not less than 72 hours in advance of proposed utility interruptions.
  2. Obtain Owner's written permission before proceeding with utility interruptions.
- D. Noise, Vibration, and Odors: Coordinate operations that may result in high levels of noise and vibration, odors, or other disruption to Owner occupancy with Owner.
- E. Nonsmoking / tobacco: Smoking / tobacco is not permitted on the campus.
- F. Controlled Substances: Use of tobacco products and other controlled substances is not permitted.
- G. Employee Identification: Provide identification tags for Contractor personnel working on Project site. Require personnel to use identification tags at all times.
- H. Employee Screening: Comply with Owner's requirements for drug and background screening of Contractor personnel working on Project site.
  1. Maintain list of approved screened personnel with Owner's representative.

PART 2 - PRODUCTS (Not Used)

PART 3 - EXECUTION (Not Used)

END OF SECTION 011000

SECTION 012100 - ALLOWANCES

PART 1 - GENERAL

1.1 RELATED DOCUMENTS

- A. Drawings and general provisions of the Contract, including General and Supplementary Conditions and other Division 01 Specification Sections, apply to this Section.

1.2 SUMMARY

- A. Section includes administrative and procedural requirements for allowances.
- B. Related Requirements:
  - 1. Section 012600 "Contract Modification Procedures" for procedures for submitting and handling Change Orders.
  - 2. Section 014000 "Quality Requirements" for general testing and inspecting requirements.

1.3 DEFINITIONS

- A. Allowance is an amount specified and included in the construction documents for a certain item/items of work whose details are not yet determined.
- B. The determined allowance is to be included in the base bid.

PART 2 - PRODUCTS (Not Used)

PART 3 - EXECUTION

3.1 SCHEDULE OF ALLOWANCES

- A. General Lump Sum: \$1,500.00

END OF SECTION 012100

## SECTION 012200 - UNIT PRICES

### PART 1 - GENERAL

#### 1.1 RELATED DOCUMENTS

- A. Drawings and general provisions of the Contract, including General and Supplementary Conditions and other Division 01 Specification Sections, apply to this Section.

#### 1.2 SUMMARY

- A. Section includes administrative and procedural requirements for unit prices.
- B. Related Requirements:
  - 1. Section 012600 "Contract Modification Procedures" for procedures for submitting and handling Change Orders.
  - 2. Section 014000 "Quality Requirements" for general testing and inspecting requirements.

#### 1.3 DEFINITIONS

- A. Quantity/Quantities is a lump sum amount for labor, materials, equipment, and/or services, to be included in the Base Bid.
- B. Unit price is a price per unit of measurement for materials, equipment, or services, or a portion of the Work, added to or deducted from the Contract Sum by appropriate modification, if the scope of Work or estimated quantities of Work required by the Contract Documents are increased or decreased.
- C. The base bid is to include unit price quantities included in the documents.

#### 1.4 PROCEDURES

- A. Unit prices include all necessary material, plus cost for delivery, installation, insurance, applicable taxes, overhead, and profit.
- B. Measurement and Payment: See individual Specification Sections for work that requires establishment of unit prices. Methods of measurement and payment for unit prices are specified in those Sections.
- C. Owner reserves the right to reject Contractor's measurement of work-in-place that involves use of established unit prices and to have this work measured, at Owner's expense, by an independent surveyor acceptable to Contractor.

- D. The Contractor is required to notify the Consultant, in writing, when approximately 75% of unit price quantities have been used.
- E. List of Unit Prices: A schedule of unit prices is included in Part 3. Specification Sections referenced in the schedule contain requirements for materials described under each unit price.

PART 2 - PRODUCTS (Not Used)

PART 3 - EXECUTION

3.1 SCHEDULE OF UNIT PRICE QUANTITIES TO BE INCLUDED IN THE BASE BID

- A. Unit Price No. 1: Roof Membrane Repair
  - 1. 100 SF
- B. Unit Price No. 2: Base Flashing Repair
  - 1. 20 LF
- C. Unit Price No. 3: VTR Repair
  - 1. 4 EA
- D. Unit Price No. 4: Roof Drain Repairs
  - 1. 8 EA
- E. Unit Price No. 5: Roof Drain Replacement
  - 1. 4 EA
- F. Unit Price No. 6: Pitch Pan Repair
  - 1. EA

END OF SECTION 012200

## SECTION 012300 - ALTERNATES

### PART 1 - GENERAL

#### 1.1 RELATED DOCUMENTS

- A. Drawings and general provisions of the Contract, including General and Supplementary Conditions and other Division 01 Specification Sections, apply to this Section.

#### 1.2 SUMMARY

- A. Section includes administrative and procedural requirements for alternates.
- B. Alternate No. 1 – (Add 15 Calendar Days) Scope of work includes roof membrane repair work at McCracken Middle School on Roof Areas U, U1, U2 and V. All other requirements remain unchanged.

#### 1.3 DEFINITIONS

- A. Alternate: An amount proposed by bidders and stated on the Bid Form for certain work defined in the bidding requirements that may be added to or deducted from the base bid amount if Owner decides to accept a corresponding change either in the amount of construction to be completed or in the products, materials, equipment, systems, or installation methods described in the Contract Documents.
  - 1. Alternates described in this Section are part of the Work only if enumerated in the Agreement.
  - 2. The cost or credit for each alternate is the net addition to or deduction from the Contract Sum to incorporate alternate into the Work. No other adjustments are made to the Contract Sum.

#### 1.4 PROCEDURES

- A. The Agency may accept Alternates in any order or combination and must determine the low Bidder based on the sum of the Base Bid and Alternates accepted. An Agency may not subsequently add to a contract by change order and Alternate that the Agency did not accept at the time of award, unless the Contractor would have been low Bidder has the Alternate been include in the award.
- B. Coordination: Revise or adjust affected adjacent work as necessary to completely integrate work of the alternate into Project.
  - 1. Include as part of each alternate, miscellaneous devices, accessory objects, and similar items incidental to or required for a complete installation whether or not indicated as part of alternate.

- C. Notification: Immediately following award of the Contract, notify each party involved, in writing, of the status of each alternate. Indicate if alternates have been accepted, rejected, or deferred for later consideration.
- D. Execute accepted alternates under the same conditions as other work of the Contract.
- E. Schedule: A schedule of alternates is included at the end of this Section. Specification Sections referenced in schedule contain requirements for materials necessary to achieve the work described under each alternate.

PART 2 - PRODUCTS (Not Used)

PART 3 - EXECUTION (Not Used)

END OF SECTION 012300



## SECTION 012500 - SUBSTITUTION PROCEDURES

### PART 1 - GENERAL

#### 1.1 RELATED DOCUMENTS

- A. Drawings and general provisions of the Contract, including General and Supplementary Conditions and other Division 01 Specification Sections, apply to this Section.

#### 1.2 SUMMARY

- A. Section includes administrative and procedural requirements for substitutions.
- B. Related Requirements:
  - 1. Section 016000 "Product Requirements" for requirements for submitting comparable product submittals for products by listed manufacturers.

#### 1.3 DEFINITIONS

- A. Substitutions: Changes in products, materials, equipment, and methods of construction from those required by the Contract Documents and proposed by Contractor.
  - 1. Substitutions for Cause: Changes proposed by Contractor that are required due to changed Project conditions, such as unavailability of product, regulatory changes, or unavailability of required warranty terms.
  - 2. Substitutions for Convenience: Changes proposed by Contractor or Owner that are not required in order to meet other Project requirements but may offer advantage to Contractor or Owner.

#### 1.4 ACTION SUBMITTALS

- A. Substitution Requests: Submit three copies of each request for consideration. Identify product or fabrication or installation method to be replaced. Include Specification Section number and title and Drawing numbers and titles.
  - 1. Substitution Request Form: Use CSI Form 13.1A.
  - 2. Documentation: Show compliance with requirements for substitutions and the following, as applicable:
    - a. Statement indicating why specified product or fabrication or installation cannot be provided, if applicable.
    - b. Coordination information, including a list of changes or revisions needed to other parts of the Work and to construction performed by Owner and separate contractors, that will be necessary to accommodate proposed substitution.

- c. Detailed comparison of significant qualities of proposed substitution with those of the Work specified. Include annotated copy of applicable Specification Section. Significant qualities may include attributes such as performance, weight, size, durability, visual effect, sustainable design characteristics, warranties, and specific features and requirements indicated. Indicate deviations, if any, from the Work specified.
  - d. Product Data, including drawings and descriptions of products and fabrication and installation procedures.
  - e. Samples, where applicable or requested.
  - f. Certificates and qualification data, where applicable or requested.
  - g. List of similar installations for completed projects with project names and addresses and names and addresses of architects and owners.
  - h. Material test reports from a qualified testing agency indicating and interpreting test results for compliance with requirements indicated.
  - i. Research reports evidencing compliance with building code in effect for Project.
  - j. Detailed comparison of Contractor's construction schedule using proposed substitution with products specified for the Work, including effect on the overall Contract Time. If specified product or method of construction cannot be provided within the Contract Time, include letter from manufacturer, on manufacturer's letterhead, stating date of receipt of purchase order, lack of availability, or delays in delivery.
  - k. Cost information, including a proposal of change, if any, in the Contract Sum.
  - l. Contractor's certification that proposed substitution complies with requirements in the Contract Documents except as indicated in substitution request, is compatible with related materials, and is appropriate for applications indicated.
  - m. Contractor's waiver of rights to additional payment or time that may subsequently become necessary because of failure of proposed substitution to produce indicated results.
3. Consultant's Action: If necessary, Consultant will request additional information or documentation for evaluation within 7 days of receipt of a request for substitution. Consultant will notify Contractor of acceptance or rejection of proposed substitution within 15 days of receipt of request, or 7 days of receipt of additional information or documentation, whichever is later.
- a. Forms of Acceptance: Change Order, Construction Change Directive, or Consultant's Supplemental Instructions for minor changes in the Work.
  - b. Use product specified if Consultant does not issue a decision on use of a proposed substitution within time allocated.

## 1.5 QUALITY ASSURANCE

- A. Compatibility of Substitutions: Investigate and document compatibility of proposed substitution with related products and materials. Engage a qualified testing agency to perform compatibility tests recommended by manufacturers.

1.6 PROCEDURES

- A. Coordination: Revise or adjust affected work as necessary to integrate work of the approved substitutions.

PART 2 - PRODUCTS

2.1 SUBSTITUTIONS

- A. Substitutions for Cause: Submit requests for substitution immediately on discovery of need for change, but not later than 15 days prior to time required for preparation and review of related submittals.

- 1. Conditions: Consultant will consider Contractor's request for substitution when the following conditions are satisfied. If the following conditions are not satisfied, Consultant will return requests without action, except to record noncompliance with these requirements:

- a. Requested substitution is consistent with the Contract Documents and will produce indicated results.
- b. Substitution request is fully documented and properly submitted.
- c. Requested substitution will not adversely affect Contractor's construction schedule.
- d. Requested substitution has received necessary approvals of authorities having jurisdiction.
- e. Requested substitution is compatible with other portions of the Work.
- f. Requested substitution has been coordinated with other portions of the Work.
- g. Requested substitution provides specified warranty.
- h. If requested substitution involves more than one contractor, requested substitution has been coordinated with other portions of the Work, is uniform and consistent, is compatible with other products, and is acceptable to all contractors involved.

- B. Substitutions for Convenience: Not allowed unless otherwise indicated.

PART 3 - EXECUTION (Not Used)

END OF SECTION 012500

## SECTION 012600 - CONTRACT MODIFICATION PROCEDURES

### PART 1 - GENERAL

#### 1.1 RELATED DOCUMENTS

- A. Drawings and general provisions of the Contract, including General and Supplementary Conditions and other Division 01 Specification Sections, apply to this Section.

#### 1.2 SUMMARY

- A. Section includes administrative and procedural requirements for handling and processing Contract modifications.
- B. Related Requirements:
  - 1. Section 012500 "Substitution Procedures" for administrative procedures for handling requests for substitutions made after the Contract award.

#### 1.3 MINOR CHANGES IN THE WORK

- A. Consultant will issue supplemental instructions authorizing minor changes in the Work, not involving adjustment to the Contract Sum or the Contract Time.

#### 1.4 PROPOSAL REQUESTS

- A. Owner-Initiated Proposal Requests: Consultant will issue a detailed description of proposed changes in the Work that may require adjustment to the Contract Sum or the Contract Time. If necessary, the description will include supplemental or revised Drawings and Specifications.
  - 1. Work Change Proposal Requests issued by Consultant are not instructions either to stop work in progress or to execute the proposed change.
  - 2. Within 7 after receipt of Proposal Request, submit a quotation estimating cost adjustments to the Contract Sum and the Contract Time necessary to execute the change.
    - a. Include a list of quantities of products required or eliminated and unit costs, with total amount of purchases and credits to be made. If requested, furnish survey data to substantiate quantities.
    - b. Indicate applicable taxes, delivery charges, equipment rental, and amounts of trade discounts.
    - c. Include costs of labor and supervision directly attributable to the change.
    - d. Include an updated Contractor's construction schedule that indicates the effect of the change, including, but not limited to, changes in activity duration, start and finish times, and activity relationship. Use available total float before requesting an extension of the Contract Time.

- B. Contractor-Initiated Proposals: If latent or changed conditions require modifications to the Contract, Contractor may initiate a claim by submitting a request for a change to Consultant.
1. Include a statement outlining reasons for the change and the effect of the change on the Work. Provide a complete description of the proposed change. Indicate the effect of the proposed change on the Contract Sum and the Contract Time.
  2. Include a list of quantities of products required or eliminated and unit costs, with total amount of purchases and credits to be made. If requested, furnish survey data to substantiate quantities.
  3. Indicate applicable taxes, delivery charges, equipment rental, and amounts of trade discounts.
  4. Include costs of labor and supervision directly attributable to the change.
  5. Include an updated Contractor's construction schedule that indicates the effect of the change, including, but not limited to, changes in activity duration, start and finish times, and activity relationship. Use available total float before requesting an extension of the Contract Time.
  6. Comply with requirements in Section 012500 "Substitution Procedures" if the proposed change requires substitution of one product or system for product or system specified.
  7. Proposal Request Form: Use a form acceptable to Consultant.

#### 1.5 ADMINISTRATIVE CHANGE ORDERS

- A. Unit-Price Adjustment: See Section 012200 "Unit Prices" for administrative procedures for preparation of Change Order Proposal for adjusting the Contract Sum to reflect measured scope of unit-price work.

#### 1.6 CHANGE ORDER PROCEDURES

- A. On Owner's approval of a Work Changes Proposal Request, Consultant will issue a Change Order for signatures of Owner and Contractor on SE-380 form included in Project Manual.

PART 2 - PRODUCTS (Not Used)

PART 3 - EXECUTION (Not Used)

END OF SECTION 012600

## SECTION 012900 - PAYMENT PROCEDURES

### PART 1 - GENERAL

#### 1.1 RELATED DOCUMENTS

- A. Drawings and general provisions of the Contract, including General and Supplementary Conditions and other Division 01 Specification Sections, apply to this Section.

#### 1.2 SUMMARY

- A. Section includes administrative and procedural requirements necessary to prepare and process Applications for Payment.
- B. Related Requirements:
  - 1. Section 012200 "Unit Prices" for administrative requirements governing the use of unit prices.
  - 2. Section 012600 "Contract Modification Procedures" for administrative procedures for handling changes to the Contract.
  - 3. Section 013200 "Construction Progress Documentation" for administrative requirements governing the preparation and submittal of the Contractor's construction schedule.

#### 1.3 DEFINITIONS

- A. Schedule of Values: A statement furnished by Contractor allocating portions of the Contract Sum to various portions of the Work and used as the basis for reviewing Contractor's Applications for Payment.

#### 1.4 SCHEDULE OF VALUES

- A. Coordination: Coordinate preparation of the schedule of values with preparation of Contractor's construction schedule.
  - 1. Coordinate line items in the schedule of values with other required administrative forms and schedules, including the following:
    - a. Application for Payment forms with continuation sheets.
    - b. Submittal schedule.
    - c. Items required to be indicated as separate activities in Contractor's construction schedule.
    - d. Unit Prices and Allowances
  - 2. Submit the schedule of values to Consultant at earliest possible date, but no later than 7 days before the date scheduled for submittal of initial Applications for Payment.

- B. Format and Content: Use Project Manual table of contents as a guide to establish line items for the schedule of values. Provide at least one line item for each Specification Section.
1. Identification: Include the following Project identification on the schedule of values:
    - a. Project name and location.
    - b. Name of Consultant.
    - c. Consultant 's project number.
    - d. Contractor's name and address.
    - e. Date of submittal.
  2. Schedule of values to be submitted on the AIA Document G703 form.
  3. Arrange the schedule of values to indicate the following for each item listed:
    - a. Related Specification Section.
    - b. Description of the Work.
    - c. Change Orders (numbers) that affect value.
    - d. Dollar value of the following, as a percentage of the Contract Sum to nearest one-hundredth percent, adjusted to total 100 percent.
      - 1) Labor.
      - 2) Materials.
      - 3) Equipment.
  4. Provide a separate line item in the schedule of values for each part of the Work where Applications for Payment may include materials or equipment purchased or fabricated and stored, but not yet installed.
    - a. Differentiate between items stored on-site and items stored off-site. If required, include evidence of insurance.

#### 1.5 APPLICATIONS FOR PAYMENT

- A. Each Application for Payment following the initial Application for Payment shall be consistent with previous applications and payments as certified by Consultant and paid for by Owner.
1. Initial Application for Payment, Application for Payment at time of Substantial Completion, and final Application for Payment involve additional requirements.
- B. Payment Application Times: The date for each progress payment is indicated in the Agreement between Owner and Contractor. The period of construction work covered by each Application for Payment is the period indicated in the Agreement.
1. Submit draft copy of Application for Payment 7 days prior to due date for review by Architect.
- C. Application for Payment Forms: Use AIA Document G702 and AIA Document G703 as form for Applications for Payment.



- D. **Application Preparation:** Complete every entry on form. Notarize and execute by a person authorized to sign legal documents on behalf of Contractor. Consultant will return incomplete applications without action.
1. Entries shall match data on the schedule of values and Contractor's construction schedule. Use updated schedules if revisions were made.
  2. Include amounts for work completed following previous Application for Payment, whether or not payment has been received. Include only amounts for work completed at time of Application for Payment.
  3. Include amounts of Change Orders and Construction Change Directives issued before last day of construction period covered by application.
  4. Indicate separate amounts for work being carried out under Owner-requested project acceleration.
  5. Indicate amount of Unit Price quantities used from Application for Payment to Application for Payment.
  6. Indicate all days where inclement weather days are being requested and work could not take place.
- E. **Stored Materials:** Include in Application for Payment amounts applied for materials or equipment purchased or fabricated and stored, but not yet installed. Differentiate between items stored on-site and items stored off-site.
1. Provide certificate of insurance, evidence of transfer of title to Owner, and consent of surety to payment, for stored materials.
  2. Provide supporting documentation that verifies amount requested, such as paid invoices. Match amount requested with amounts indicated on documentation; do not include overhead and profit on stored materials.
  3. Provide summary documentation for stored materials indicating the following:
    - a. Value of materials previously stored and remaining stored as of date of previous Applications for Payment.
    - b. Value of previously stored materials put in place after date of previous Application for Payment and on or before date of current Application for Payment.
    - c. Value of materials stored since date of previous Application for Payment and remaining stored as of date of current Application for Payment.
- F. **Transmittal:** Submit three (3) signed and notarized original copies of each Application for Payment to Consultant by a method ensuring receipt within 24 hours. One copy shall include waivers of lien and similar attachments if required.
1. Transmit each copy with a transmittal form listing attachments and recording appropriate information about application.
- G. **Application for Payment at Substantial Completion:** After Architect issues the Certificate of Substantial Completion, submit an Application for Payment showing 100 percent completion for portion of the Work claimed as substantially complete.
1. Include documentation supporting claim that the Work is substantially complete and a statement showing an accounting of changes to the Contract Sum.
  2. This application shall reflect Certificate(s) of Substantial Completion issued previously for Owner occupancy of designated portions of the Work.

H. Final Payment Application: After completing Project closeout requirements, submit final Application for Payment with releases and supporting documentation not previously submitted and accepted, including, but not limited, to the following:

1. Evidence of completion of Project closeout requirements.
2. Insurance certificates for products and completed operations where required and proof that taxes, fees, and similar obligations were paid.
3. Updated final statement, accounting for final changes to the Contract Sum.
4. AIA Document G706, "Contractor's Affidavit of Payment of Debts and Claims."
5. AIA Document G706A, "Contractor's Affidavit of Release of Liens."
6. AIA Document G707, "Consent of Surety to Final Payment."
7. Evidence that claims have been settled.
8. Final liquidated damages settlement statement.

PART 2 - PRODUCTS (Not Used)

PART 3 - EXECUTION (Not Used)

END OF SECTION 012900

## SECTION 013100 - PROJECT MANAGEMENT AND COORDINATION

### PART 1 - GENERAL

#### 1.1 RELATED DOCUMENTS

- A. Drawings and general provisions of the Contract, including General and Supplementary Conditions and other Division 01 Specification Sections, apply to this Section.

#### 1.2 SUMMARY

- A. Section includes administrative provisions for coordinating construction operations on Project including, but not limited to, the following:
  - 1. General coordination procedures.
  - 2. Coordination drawings.
  - 3. Requests for Information (RFIs).
  - 4. Project Web site.
  - 5. Project meetings.
- B. Each contractor shall participate in coordination requirements. Certain areas of responsibility are assigned to a specific contractor.
- C. Related Requirements:
  - 1. Section 013200 "Construction Progress Documentation" for preparing and submitting Contractor's construction schedule.
  - 2. Section 017300 "Execution" for procedures for coordinating general installation and field-engineering services, including establishment of benchmarks and control points.
  - 3. Section 017700 "Closeout Procedures" for coordinating closeout of the Contract.

#### 1.3 DEFINITIONS

- A. RFI: Request from Owner, Consultant, or Contractor seeking information required by or clarifications of the Contract Documents.

#### 1.4 INFORMATIONAL SUBMITTALS

- A. Subcontract List: Prepare a written summary identifying individuals or firms proposed for each portion of the Work, including those who are to furnish products or equipment fabricated to a special design. Include the following information in tabular form:
  - 1. Name, address, and telephone number of entity performing subcontract or supplying products.
  - 2. Number and title of related Specification Section(s) covered by subcontract.
  - 3. Drawing number and detail references, as appropriate, covered by subcontract.

- B. Key Personnel Names: Prior to starting construction operations, submit a list of key personnel assignments, including superintendent and other personnel in attendance at Project site. Identify individuals and their duties and responsibilities; list addresses and telephone numbers, including home, office, and cellular telephone numbers and e-mail addresses. Provide names, addresses, and telephone numbers of individuals assigned as alternates in the absence of individuals assigned to Project.
  - 1. List is to be provided to all applicable parties. Keep list current at all times.

#### 1.5 GENERAL COORDINATION PROCEDURES

- A. Coordination: Coordinate construction operations included in different Sections of the Specifications to ensure efficient and orderly installation of each part of the Work. Coordinate construction operations, included in different Sections that depend on each other for proper installation, connection, and operation.
  - 1. Schedule construction operations in sequence required to obtain the best results where installation of one part of the Work depends on installation of other components, before or after its own installation.
  - 2. Coordinate installation of different components to ensure maximum performance and accessibility for required maintenance, service, and repair.
  - 3. Make adequate provisions to accommodate items scheduled for later installation.
- B. Coordination: Each contractor shall coordinate its construction operations with those of other contractors and entities to ensure efficient and orderly installation of each part of the Work. Each contractor shall coordinate its operations with operations, included in different Sections that depend on each other for proper installation, connection, and operation.
  - 1. Schedule construction operations in sequence required to obtain the best results where installation of one part of the Work depends on installation of other components, before or after its own installation.
  - 2. Coordinate installation of different components with other contractors to ensure maximum performance and accessibility for required maintenance, service, and repair.
  - 3. Make adequate provisions to accommodate items scheduled for later installation.
- C. Prepare memoranda for distribution to each party involved, outlining special procedures required for coordination. Include such items as required notices, reports, and list of attendees at meetings.
  - 1. Prepare similar memoranda for Owner and separate contractors if coordination of their Work is required.
- D. Administrative Procedures: Coordinate scheduling and timing of required administrative procedures with other construction activities to avoid conflicts and to ensure orderly progress of the Work. Such administrative activities include, but are not limited to, the following:
  - 1. Preparation of Contractor's construction schedule.
  - 2. Preparation of the schedule of values.
  - 3. Installation and removal of temporary facilities and controls.
  - 4. Delivery and processing of submittals.

5. Progress meetings.
6. Preinstallation conferences.
7. Project closeout activities.
8. Startup and adjustment of systems.

E. Conservation: Coordinate construction activities to ensure that operations are carried out with consideration given to conservation of energy, water, and materials. Coordinate use of temporary utilities to minimize waste.

1. Salvage materials and equipment involved in performance of, but not actually incorporated into, the Work. See other Sections for disposition of salvaged materials that are designated as Owner's property.

## 1.6 COORDINATION DRAWINGS

A. Coordination Drawings, General: Prepare coordination drawings according to requirements in individual Sections, and additionally where installation is not completely shown on Shop Drawings, where limited space availability necessitates coordination, or if coordination is required to facilitate integration of products and materials fabricated or installed by more than one entity.

1. Content: Project-specific information, drawn accurately to a scale large enough to indicate and resolve conflicts. Do not base coordination drawings on standard printed data. Include the following information, as applicable:
  - a. Use applicable Drawings as a basis for preparation of coordination drawings. Prepare sections, elevations, and details as needed to describe relationship of various systems and components.
  - b. Coordinate the addition of trade-specific information to the coordination drawings by multiple contractors in a sequence that best provides for coordination of the information and resolution of conflicts between installed components before submitting for review.
  - c. Indicate functional and spatial relationships of components of architectural, mechanical, and electrical systems.
  - d. Indicate required installation sequences.
2. Review: Consultant will review coordination drawings to confirm that the Work is being coordinated, but not for the details of the coordination, which are Contractor's responsibility. If Consultant determines that coordination drawings are not being prepared in sufficient scope or detail, or are otherwise deficient, Consultant will so inform Contractor, who shall make changes as directed and resubmit.

## 1.7 REQUESTS FOR INFORMATION (RFIs)

A. General: Immediately on discovery of the need for additional information or interpretation of the Contract Documents, Contractor shall prepare and submit an RFI in the form specified.

1. Consultant will return RFIs submitted to Consultant by other entities controlled by Contractor with no response.

2. Coordinate and submit RFIs in a prompt manner so as to avoid delays in Contractor's work or work of subcontractors.
- B. Content of the RFI: Include a detailed, legible description of item needing information or interpretation and the following:
1. Project name.
  2. Project number.
  3. Date.
  4. Name of Contractor.
  5. Name of Consultant.
  6. RFI number, numbered sequentially.
  7. RFI subject.
  8. Specification Section number and title and related paragraphs, as appropriate.
  9. Drawing number and detail references, as appropriate.
  10. Field dimensions and conditions, as appropriate.
  11. Contractor's suggested resolution. If Contractor's suggested resolution impacts the Contract Time or the Contract Sum, Contractor shall state impact in the RFI.
  12. Contractor's signature.
  13. Attachments: Include sketches, descriptions, measurements, photos, Product Data, Shop Drawings, coordination drawings, and other information necessary to fully describe items needing interpretation.
- C. Consultant's Action: Consultant will review each RFI, determine action required, and respond. Allow 7 working days for Architect's response for each RFI.
1. The following Contractor-generated RFIs will be returned without action:
    - a. Requests for approval of submittals.
    - b. Requests for approval of substitutions.
    - c. Requests for approval of Contractor's means and methods.
    - d. Requests for coordination information already indicated in the Contract Documents.
    - e. Requests for adjustments in the Contract Time or the Contract Sum.
    - f. Requests for interpretation of Consultant's actions on submittals.
    - g. Incomplete RFIs or inaccurately prepared RFIs.
  2. Consultant's action may include a request for additional information, in which case Consultant's time for response will date from time of receipt of additional information.
  3. Consultant's action on RFIs that may result in a change to the Contract Time or the Contract Sum may be eligible for Contractor to submit Change Proposal according to Section 012600 "Contract Modification Procedures."
    - a. If Contractor believes the RFI response warrants change in the Contract Time or the Contract Sum, notify Consultant in writing within 7 days of receipt of the RFI response.
- D. RFI Log: Prepare, maintain, and submit a tabular log of RFIs organized by the RFI number. Submit log at the end of the project with close-out documents. Include the following:
1. Project name.

2. Name and address of Contractor.
3. Name and address of Consultant.
4. RFI number including RFIs that were returned without action or withdrawn.
5. RFI description.
6. Date the RFI was submitted.
7. Date Consultant's response was received.

- E. On receipt of Consultant's action, update the RFI log and immediately distribute the RFI response to affected parties. Review response and notify Consultant within 7 days if Contractor disagrees with response.

## 1.8 PROJECT MEETINGS

- A. General: Schedule and conduct meetings and conferences at Project site unless otherwise indicated.

1. Attendees: Inform participants and others involved, and individuals whose presence is required, of date and time of each meeting. Notify Owner and Consultant of scheduled meeting dates and times.
2. Agenda: Prepare the meeting agenda. Distribute the agenda to all invited attendees.
3. Minutes: Entity responsible for conducting meeting will record significant discussions and agreements achieved. Distribute the meeting minutes to everyone concerned, including Owner and Consultant, within three days of the meeting.

- B. Preconstruction Conference: Schedule and conduct a preconstruction conference before starting construction, at a time convenient to Owner and Architect, but no later than 15 days after execution of the Agreement.

1. Conduct the conference to review responsibilities and personnel assignments.
2. Attendees: Authorized representatives of Owner and Consultant; Contractor and its superintendent; major subcontractors; suppliers; and other concerned parties shall attend the conference. Participants at the conference shall be familiar with Project and authorized to conclude matters relating to the Work.
3. Agenda: Discuss items of significance that could affect progress, including the following:
  - a. Time schedules.
  - b. Use of the premises.
  - c. Work restrictions.
  - d. Working hours.
  - e. Safety Requirements.
  - f. Review of mockups.
  - g. Possible conflicts.
  - h. Compatibility requirements.
  - i. Weather limitations.
  - j. Manufacturer's written instructions.
  - k. Installation procedures.
  - l. Warranty requirements.
  - m. Temporary facilities and controls.
  - n. Space and access limitations.
  - o. Coordination with other work.

- p. Protection of adjacent work.
  - q. Owner's occupancy requirements.
  - r. Procedures for moisture control.
  - s. Procedures for disruptions and shutdowns.
  - t. Construction waste management and recycling.
  - u. Parking availability.
  - v. Material storage areas.
  - w. Equipment deliveries and priorities.
  - x. Security.
  - y. Progress cleaning.
4. Minutes: Entity responsible for conducting meeting will record and distribute meeting minutes.
- C. Progress Meetings: Conduct progress meetings as requested by the Owner.
- 1. Attendees: In addition to representatives of Owner and Consultant, each contractor, subcontractor, supplier, and other entity concerned with current progress or involved in planning, coordination, or performance of future activities shall be represented at these meetings. All participants at the meeting shall be familiar with Project and authorized to conclude matters relating to the Work.
  - 2. Agenda: Review and correct or approve minutes of previous progress meeting. Review other items of significance that could affect progress. Include topics for discussion as appropriate to status of Project.
    - a. Contractor's Construction Schedule: Review progress since the last meeting. Determine whether each activity is on time, ahead of schedule, or behind schedule, in relation to Contractor's construction schedule. Determine how construction behind schedule will be expedited; secure commitments from parties involved to do so. Discuss whether schedule revisions are required to ensure that current and subsequent activities will be completed within the Contract Time.
      - 1) Review schedule for next period.
  - 3. Minutes: Entity responsible for conducting the meeting will record and distribute the meeting minutes to each party present and to parties requiring information.
    - a. Schedule Updating: Revise Contractor's construction schedule after each progress meeting where revisions to the schedule have been made or recognized. Issue revised schedule concurrently with the report of each meeting.

PART 2 - PRODUCTS (Not Used)

PART 3 - EXECUTION (Not Used)

END OF SECTION 013100



## SECTION 013200 - CONSTRUCTION PROGRESS DOCUMENTATION

### PART 1 - GENERAL

#### 1.1 RELATED DOCUMENTS

- A. Drawings and general provisions of the Contract, including General and Supplementary Conditions and other Division 01 Specification Sections, apply to this Section.

#### 1.2 SUMMARY

- A. Section includes administrative and procedural requirements for documenting the progress of construction during performance of the Work, including the following:
  - 1. Startup construction schedule.
  - 2. Contractor's construction schedule.
  - 3. Construction schedule updating reports.
  - 4. Daily construction reports.
  - 5. Material location reports.
  - 6. Site condition reports.
  - 7. Special reports.
- B. Related Requirements:
  - 1. Section 013300 "Submittal Procedures" for submitting schedules and reports.
  - 2. Section 014000 "Quality Requirements" for submitting a schedule of tests and inspections.

#### 1.3 DEFINITIONS

- A. Activity: A discrete part of a project that can be identified for planning, scheduling, monitoring, and controlling the construction project. Activities included in a construction schedule consume time and resources.
  - 1. Critical Activity: An activity on the critical path that must start and finish on the planned early start and finish times.
  - 2. Predecessor Activity: An activity that precedes another activity in the network.
  - 3. Successor Activity: An activity that follows another activity in the network.
- B. Cost Loading: The allocation of the schedule of values for the completion of an activity as scheduled. The sum of costs for all activities must equal the total Contract Sum unless otherwise approved by Consultant.
- C. CPM: Critical path method, which is a method of planning and scheduling a construction project where activities are arranged based on activity relationships. Network calculations determine when activities can be performed and the critical path of Project.

- D. Critical Path: The longest connected chain of interdependent activities through the network schedule that establishes the minimum overall Project duration and contains no float.
- E. Event: The starting or ending point of an activity.
- F. Resource Loading: The allocation of manpower and equipment necessary for the completion of an activity as scheduled.

#### 1.4 INFORMATIONAL SUBMITTALS

- A. Format for Submittals: Submit required submittals in the following format:
  - 1. Working electronic copy of schedule file, where indicated.
  - 2. PDF electronic file.
- B. Startup construction schedule.
  - 1. Approval of cost-loaded, startup construction schedule will not constitute approval of schedule of values for cost-loaded activities.
- C. Startup Network Diagram: Of size required to display entire network for entire construction period. Show logic ties for activities.
- D. Contractor's Construction Schedule: Initial schedule, of size required to display entire schedule for entire construction period.
  - 1. Submit a working electronic copy of schedule, using software indicated, and labeled to comply with requirements for submittals. Include type of schedule (initial or updated) and date on label.
- E. CPM Reports: Concurrent with CPM schedule, submit each of the following reports. Format for each activity in reports shall contain activity number, activity description, cost and resource loading, original duration, remaining duration, early start date, early finish date, late start date, late finish date, and total float in calendar days.
  - 1. Activity Report: List of all activities sorted by activity number and then early start date, or actual start date if known.
  - 2. Logic Report: List of preceding and succeeding activities for all activities, sorted in ascending order by activity number and then early start date, or actual start date if known.
- F. Construction Schedule Updating Reports: Submit with Applications for Payment.
- G. Weekly Construction Reports: Submit at weekly intervals.
- H. Material Location Reports: Submit at weekly intervals.
- I. Site Condition Reports: Submit at time of discovery of differing conditions.
- J. Special Reports: Submit at time of unusual event.
- K. Qualification Data: For scheduling consultant.

## 1.5 QUALITY ASSURANCE

- A. Scheduling: Scheduling will be discussed at the Pre-Construction Conference at the Project site to comply with requirements in Section 013100 "Project Management and Coordination." Review methods and procedures related to the preliminary construction schedule and Contractor's construction schedule, including, but not limited to, the following:
1. Discuss constraints, including work stages, area separations, interim milestones and Owner occupancy.
  2. Review delivery dates for equipment, materials, etc.
  3. Review any outstanding submittal requirements and procedures.
  4. Review and finalize list of construction activities to be included in schedule.
  5. Review procedures for updating schedule.

## 1.6 COORDINATION

- A. Coordinate Contractor's construction schedule with the schedule of values, submittal schedule, progress reports, payment requests, and other required schedules and reports.
1. Secure time commitments for performing critical elements of the Work from entities involved.
  2. Coordinate each construction activity in the network with other activities and schedule them in proper sequence.

## PART 2 - PRODUCTS

### 2.1 CONTRACTOR'S CONSTRUCTION SCHEDULE, GENERAL

- A. Time Frame: Extend schedule from date established for date of commencement to date of Substantial Completion and final completion.
1. Contract completion date shall not be changed by submission of a schedule that shows an early completion date, unless specifically authorized by Change Order.
  2. Schedule shall outline time spent on each roof area during each time allotted as described on Bid Form.
- B. Activities: Treat each story or separate area as a separate numbered activity for each main element of the Work. Comply with the following:
1. Activity Duration: Define activities and length of time needed to complete the activity.
  2. Procurement Activities: Include procurement process activities for the following long lead items and major items, requiring a cycle of more than 60 days, as separate activities in schedule. Procurement cycle activities include, but are not limited to, submittals, approvals, purchasing, fabrication, and delivery.
  3. Submittal Review Time: Include review and resubmittal times indicated in Section 013300 "Submittal Procedures" in schedule. Coordinate submittal review times in Contractor's construction schedule with submittal schedule.

4. Substantial Completion: Indicate completion in advance of date established for Substantial Completion, and allow time for Consultant's administrative procedures necessary for certification of Substantial Completion.
  5. Punch List and Final Completion: Include not more than 30 days for completion of punch list items and final completion.
- C. Constraints: Include constraints and work restrictions indicated in the Contract Documents and as follows in schedule, and show how the sequence of the Work is affected.
1. Phasing: Arrange list of activities on schedule by phase.
  2. Products Ordered in Advance: Include a separate activity for each product. Include delivery date indicated in Section 011000 "Summary." Delivery dates indicated stipulate the earliest possible delivery date.
  3. Work Restrictions: Show the effect of the following items on the schedule:
    - a. Limitations of continued occupancies.
    - b. Uninterruptible services.
    - c. Use of premises restrictions.
  4. Work Stages: Indicate important stages of construction for each major portion of the Work, including, but not limited to, the following:
    - a. Submittals.
    - b. Fabrication.
    - c. Deliveries.
    - d. Installation.
  5. Construction Areas: Identify each major area of construction for each major portion of the Work. Indicate where each construction activity within a major area must be sequenced or integrated with other construction activities to provide for the following:
    - a. Completion of mechanical installation, if any.
    - b. Completion of electrical installation, if any.
    - c. Substantial Completion.
- D. Milestones: Include milestones indicated in the Contract Documents in schedule, including, but not limited to, the Notice to Proceed, Substantial Completion, and final completion.
- E. Recovery Schedule: When periodic update indicates the Work is 7 or more calendar days behind the current approved schedule, submit a separate recovery schedule indicating means by which Contractor intends to regain compliance with the schedule. Indicate changes to working hours, working days, crew sizes, and equipment required to achieve compliance, and date by which recovery will be accomplished.

## 2.2 STARTUP CONSTRUCTION SCHEDULE

- A. Bar-Chart Schedule: Submit startup, horizontal, bar-chart-type construction schedule within 7 days of date established for commencement of the Work.

- B. Preparation: Indicate each significant construction activity separately. Identify first workday of each week with a continuous vertical line. Outline significant construction activities for the duration of the project.

## 2.3 REPORTS

- A. Weekly Construction Reports: Prepare a weekly construction report recording the following information concerning events at Project site:
  1. Approximate count of personnel at Project site.
  2. Material deliveries.
  3. High and low temperatures and general weather conditions, including presence of rain or snow.
  4. Accidents.
  5. Meetings and significant decisions.
  6. Unusual events (see special reports).
  7. Stoppages, delays, shortages, and losses.
  8. Meter readings and similar recordings.
  9. Emergency procedures (if any).
  10. Orders and requests of authorities having jurisdiction (if any).
  11. Change Orders received and implemented.
  12. Services connected and disconnected.
  
- B. Material Location Reports: At weekly intervals, prepare and submit a comprehensive list of materials delivered to and stored at Project site. List shall be cumulative, showing materials previously reported plus items recently delivered. Include with list a statement of progress on and delivery dates for materials or items of equipment fabricated or stored away from Project site. Indicate the following categories for stored materials:
  1. Material stored prior to previous report and remaining in storage.
  2. Material stored prior to previous report and since removed from storage and installed.
  3. Material stored following previous report and remaining in storage.
  
- C. Site Condition Reports: Immediately on discovery of a difference between site conditions and the Contract Documents, prepare and submit a detailed report. Submit with a Request for Information. Include a detailed description of the differing conditions, together with recommendations for changing the Contract Documents.

## 2.4 SPECIAL REPORTS

- A. General: Submit special reports directly to Owner within 24 hours of an occurrence. Distribute copies of report to parties affected by the occurrence.
  
- B. Reporting Unusual Events: When an event of an unusual and significant nature occurs at Project site, whether or not related directly to the Work, prepare and submit a special report. List chain of events, persons participating, response by Contractor's personnel, evaluation of results or effects, and similar pertinent information. Advise Owner in advance when these events are known or predictable.

PART 3 - EXECUTION

3.1 CONTRACTOR'S CONSTRUCTION SCHEDULE

- A. Contractor's Construction Schedule Updating: At monthly intervals, update schedule to reflect actual construction progress and activities.
  - 1. Include a report with updated schedule that indicates every change, including, but not limited to, changes in logic, durations, actual starts and finishes, and activity durations.
  - 2. As the Work progresses, indicate final completion percentage for each activity.
- B. Distribution: Distribute copies of schedule to Consultant, Owner, and other parties identified by Contractor with a need-to-know schedule responsibility.

END OF SECTION 013200

## SECTION 013233 - PHOTOGRAPHIC DOCUMENTATION

### PART 1 - GENERAL

#### 1.1 RELATED DOCUMENTS

- A. Drawings and general provisions of the Contract, including General and Supplementary Conditions and other Division 01 Specification Sections, apply to this Section.

#### 1.2 SUMMARY

- A. Section includes administrative and procedural requirements for the following:
  - 1. Preconstruction photographs or video recordings prior to mobilization.
  - 2. Periodic construction photographs.
  - 3. Final completion construction photographs.
- B. Related Requirements:
  - 1. Section 012200 "Unit Prices" for procedures for unit prices for extra photographs.
  - 2. Section 013300 "Submittal Procedures" for submitting photographic documentation.
  - 3. Section 017700 "Closeout Procedures" for submitting photographic documentation as project record documents at Project closeout.

#### 1.3 INFORMATIONAL SUBMITTALS

- A. Key Plan: Submit key plan of Project site and building with notation of vantage points marked for location and direction of each photograph or video recording. Indicate elevation or story of construction. Include same information as corresponding photographic documentation.
- B. Digital Photographs: Submit image files used for documentation existing conditions with submittal package.
  - 1. Identification: Provide the following information with each image description:
    - a. Name of Project.
    - b. Name of Contractor.
    - c. Date photograph was taken.
    - d. Description of vantage point, indicating location, direction, and elevation or story of construction.
- C. Construction Photographs: Submit digital prints of each view as required to document conditions and/or unit price items.
- D. Video Recordings: Submit video recordings used for documentation existing conditions with submittal package.

## PART 2 - PRODUCTS

### 2.1 PHOTOGRAPHIC MEDIA

- A. Digital Images: Provide images in JPG format, produced by a digital camera.
- B. Digital Video Recordings (if desired in lieu of digital images): Provide high-resolution, digital video disc in format acceptable to Consultant.

## PART 3 - EXECUTION

### 3.1 CONSTRUCTION DOCUMENTATION

- A. Preconstruction Photographs or Video Recording: Before mobilizing on site, record both interior and exterior conditions of the Project site and surrounding properties from different vantage points.
  - 1. Show existing conditions and any damages adjacent to Project site.
  - 2. Show any damages on the inside of the building.
  - 3. Documentation of existing conditions shall be provided to the Consultant prior to the Contractor mobilizing on site.
- B. Periodic Construction Photographs:
  - 1. Show photographs of unit price quantities utilized.
  - 2. Show periodic photographs of project progress.
- C. Final Completion Construction Photographs
  - 1. Show photographs of project at final completion.

END OF SECTION 013233



## SECTION 013300 - SUBMITTAL PROCEDURES

### PART 1 - GENERAL

#### 1.1 RELATED DOCUMENTS

- A. Drawings and general provisions of the Contract, including General and Supplementary Conditions and other Division 01 Specification Sections, apply to this Section.

#### 1.2 SUMMARY

- A. Section includes requirements for the submittal schedule and administrative and procedural requirements for submitting Shop Drawings, Product Data, Samples, and other submittals.
- B. Related Requirements:
  - 1. Section 012900 "Payment Procedures" for submitting Applications for Payment and the schedule of values.
  - 2. Section 013200 "Construction Progress Documentation" for submitting schedules and reports, including Contractor's construction schedule.
  - 3. Section 017839 "Project Record Documents" for submitting record Drawings, record Specifications, and record Product Data.

#### 1.3 DEFINITIONS

- A. Action Submittals: Written and graphic information and physical samples that require Consultant's responsive action. Action submittals are those submittals indicated in individual Specification Sections as "action submittals."
- B. Informational Submittals: Written and graphic information and physical samples that do not require Consultant's responsive action. Submittals may be rejected for not complying with requirements. Informational submittals are those submittals indicated in individual Specification Sections as "informational submittals."
- C. File Transfer Protocol (FTP): Communications protocol that enables transfer of files to and from another computer over a network and that serves as the basis for standard Internet protocols. An FTP site is a portion of a network located outside of network firewalls within which internal and external users are able to access files.
- D. Portable Document Format (PDF): An open standard file format licensed by Adobe Systems used for representing documents in a device-independent and display resolution-independent fixed-layout document format.

#### 1.4 ACTION SUBMITTALS

- A. Submittal Schedule: Submit a schedule of submittals, arranged in chronological order by dates required by construction schedule. Include time required for review, ordering, manufacturing, fabrication, and delivery when establishing dates. Include additional time required for making corrections or revisions to submittals noted by Consultant and additional time for handling and reviewing submittals required by those corrections.
1. Coordinate submittal schedule with list of subcontracts, the schedule of values, and Contractor's construction schedule.
    - a. Submit revised submittal schedule to reflect changes in current status and timing for submittals.
  2. Format: Arrange the following information in a tabular format:
    - a. Specification Section number and title.
    - b. Name of subcontractor.
    - c. Description of the Work covered.
    - d. Scheduled dates for installation.

#### 1.5 SUBMITTAL ADMINISTRATIVE REQUIREMENTS

- A. Coordination: Coordinate preparation and processing of submittals with performance of construction activities.
1. Coordinate each submittal with fabrication, purchasing, testing, delivery, other submittals, and related activities that require sequential activity.
  2. Submit all submittal items required for each Specification Section concurrently unless partial submittals for portions of the Work are indicated on approved submittal schedule.
  3. Submit action submittals and informational submittals required by the same Specification Section as separate packages under separate transmittals.
  4. Coordinate transmittal of different types of submittals for related parts of the Work so processing will not be delayed because of need to review submittals concurrently for coordination.
    - a. Consultant reserves the right to withhold action on a submittal requiring coordination with other submittals until related submittals are received.
- B. Processing Time: Allow time for submittal review, including time for resubmittals, as follows. Time for review shall commence on Consultant's receipt of submittal. No extension of the Contract Time will be authorized because of failure to transmit submittals enough in advance of the Work to permit processing, including resubmittals.
1. Initial Review: Allow 10 days for initial review of each submittal. Allow additional time if coordination with subsequent submittals is required. Consultant will advise Contractor when a submittal being processed must be delayed for coordination.
  2. Intermediate Review: If intermediate submittal is necessary, process it in same manner as initial submittal.
  3. Resubmittal Review: Allow 10 days for review of each resubmittal.

- C. Paper Submittals: Place a permanent label or title block on each submittal item for identification.
1. Include the following information for processing and recording action taken:
    - a. Project name.
    - b. Date.
    - c. Name of Consultant.
    - d. Name of Contractor.
    - e. Name of subcontractor.
    - f. Number and title of appropriate Specification Section.
    - g. Drawing number and detail references, as appropriate.
    - h. Other necessary identification.
  2. Submit three bound copies of submittal to Consultant.
- D. Resubmittals: Make resubmittals in same form and number of copies as initial submittal.
1. Note date and content of previous submittal.
  2. Note date and content of revision in label or title block and clearly indicate extent of revision.
  3. Resubmit submittals until they are marked with approval notation from Consultant's action stamp.
- E. Distribution: Furnish copies of final submittals to subcontractors, suppliers, fabricators, installers, and others as necessary for performance of construction activities. Show distribution on transmittal forms.
- F. Use for Construction: Retain complete copies of submittals on Project site. Use only final action submittals that are marked with approval notation from Consultant's action stamp. Ensure that all submitted items "Not Approved" for use are included in field set and clearly marked "Not Approved for Use."

## PART 2 - PRODUCTS

### 2.1 SUBMITTAL PROCEDURES

- A. General Submittal Procedure Requirements: Prepare and submit submittals required by individual Specification Sections. Types of submittals are indicated in individual Specification Sections.
1. Submit electronic submittals via email as PDF electronic files.
    - a. Consultant will return annotated file. Annotate and retain one copy of file as an electronic Project record document file.
  2. Applications for Payment: Provide three original copies that include the signature of an officer or other individual authorized to sign documents on behalf of that entity and shall be notarized.

- B. Product Data: Collect information into a single submittal for each element of construction and type of product or equipment.
  - 1. If information must be specially prepared for submittal because standard published data are not suitable for use, submit as Shop Drawings, not as Product Data.
  - 2. Mark each copy of each submittal to show which products and options are applicable.
  - 3. Include the following information, as applicable:
    - a. Manufacturer's catalog cuts.
    - b. Manufacturer's product specifications.
    - c. Standard color charts.
    - d. Statement of compliance with specified referenced standards.
    - e. Testing by recognized testing agency.
    - f. Application of testing agency labels and seals.
    - g. Notation of coordination requirements.
    - h. Availability and delivery time information.
  - 4. Submit Product Data with Samples.
- C. Shop Drawings: Prepare Project-specific information. Do not base Shop Drawings on reproductions of the Contract Documents.
  - 1. Preparation: Fully illustrate requirements in the Contract Documents. Include the following information, as applicable:
    - a. Identification of products.
    - b. Compliance with specified standards.
    - c. Notation of coordination requirements.
    - d. Notation of dimensions established by field measurement.
    - e. Relationship and attachment to adjoining construction clearly indicated.
    - f. Seal and signature of professional engineer if specified.
- D. Coordination Drawing Submittals: Comply with requirements specified in Section 013100 "Project Management and Coordination."
- E. Application for Payment and Schedule of Values: Comply with requirements specified in Section 012900 "Payment Procedures."
- F. Test and Inspection Reports and Schedule of Tests and Inspections Submittals: Comply with requirements specified in Section 014000 "Quality Requirements."
- G. Closeout Submittals and Maintenance Material Submittals: Comply with requirements specified in Section 017700 "Closeout Procedures."
- H. Qualification Data: Prepare written information that demonstrates capabilities and experience of firm or person. Include lists of completed projects with project names and addresses, contact information of architects and owners, and other information specified.
- I. Installer Certificates: Submit written statements on manufacturer's letterhead certifying that Installer complies with requirements in the Contract Documents and, where required, is authorized by manufacturer for this specific Project.

- J. Manufacturer Certificates: Submit written statements on manufacturer's letterhead certifying that manufacturer complies with requirements in the Contract Documents. Include evidence of manufacturing experience where required.
- K. Material Certificates: Submit written statements on manufacturer's letterhead certifying that materials comply with requirements in the Contract Documents.
- L. Material Test Reports: Submit reports written by a qualified testing agency, on testing agency's standard form, indicating and interpreting test results of material for compliance with requirements in the Contract Documents.
- M. Product Test Reports: Submit written reports indicating that current product produced by manufacturer complies with requirements in the Contract Documents. Base reports on evaluation of tests performed by manufacturer and witnessed by a qualified testing agency, or on comprehensive tests performed by a qualified testing agency.
- N. Indicate that products and systems comply with performance and design criteria in the Contract Documents. Include list of codes, loads, and other factors used in performing these services.

### PART 3 - EXECUTION

#### 3.1 CONTRACTOR'S REVIEW

- A. Action and Informational Submittals: Review each submittal and check for coordination with other Work of the Contract and for compliance with the Contract Documents.
- B. Project Closeout and Maintenance Material Submittals: See requirements in Section 017700 "Closeout Procedures."

#### 3.2 CONSULTANT'S ACTION

- A. Action Submittals: Consultant will review each submittal, make marks to indicate corrections or revisions required, and return it. Consultant will stamp each submittal with an action stamp and will mark stamp appropriately to indicate action required.
- B. Informational Submittals: Consultant will review each submittal and will not return it, or will return it if it does not comply with requirements. Consultant will forward each submittal to appropriate party.
- C. Incomplete submittals are unacceptable and will be returned for resubmittal without review.
- D. Submittals not required by the Contract Documents may be returned by the Consultant without action.

END OF SECTION 013300

## SECTION 014000 - QUALITY REQUIREMENTS

### PART 1 - GENERAL

#### 1.1 RELATED DOCUMENTS

- A. Drawings and general provisions of the Contract, including General and Supplementary Conditions and other Division 01 Specification Sections, apply to this Section.

#### 1.2 SUMMARY

- A. Section includes administrative and procedural requirements for quality assurance and quality control.

#### 1.3 DEFINITIONS

- A. Quality-Assurance Services: Activities, actions, and procedures performed before and during execution of the Work to guard against defects and deficiencies and substantiate that proposed construction will comply with requirements.
- B. Quality-Control Services: Tests, inspections, procedures, and related actions during and after execution of the Work to evaluate that actual products incorporated into the Work and completed construction comply with requirements. Services do not include contract enforcement activities performed by Consultant.
- C. Mockups: Full-size physical assemblies that are constructed on-site. Mockups are constructed to verify selections made under Sample submittals; to demonstrate aesthetic effects and, where indicated, qualities of materials and execution; to review coordination, testing, or operation; to show interface between dissimilar materials; and to demonstrate compliance with specified installation tolerances. Mockups are not Samples. Unless otherwise indicated, approved mockups establish the standard by which the Work will be judged.
- D. Product Testing: Tests and inspections that are performed by an NRTL, an NVLAP, or a testing agency qualified to conduct product testing and acceptable to authorities having jurisdiction, to establish product performance and compliance with specified requirements.
- E. Source Quality-Control Testing: Tests and inspections that are performed at the source, e.g., plant, mill, factory, or shop.
- F. Field Quality-Control Testing: Tests and inspections that are performed on-site for installation of the Work and for completed Work.
- G. Testing Agency: An entity engaged to perform specific tests, inspections, or both. Testing laboratory shall mean the same as testing agency.

- H. Installer/Applicator/Erector: Contractor or another entity engaged by Contractor as an employee, Subcontractor, or Sub-subcontractor, to perform a particular construction operation, including installation, erection, application, and similar operations.
  - 1. Use of trade-specific terminology in referring to a trade or entity does not require that certain construction activities be performed by accredited or unionized individuals, or that requirements specified apply exclusively to specific trade(s).
- I. Experienced: When used with an entity or individual, "experienced" means having successfully completed a minimum of five previous projects similar in nature, size, and extent to this Project; being familiar with special requirements indicated; and having complied with requirements of authorities having jurisdiction.

#### 1.4 CONFLICTING REQUIREMENTS

- A. Referenced Standards: If compliance with two or more standards is specified and the standards establish different or conflicting requirements for minimum quantities or quality levels, comply with the most stringent requirement. Refer conflicting requirements that are different, but apparently equal, to Consultant for a decision before proceeding.
- B. Minimum Quantity or Quality Levels: The quantity or quality level shown or specified shall be the minimum provided or performed. The actual installation may comply exactly with the minimum quantity or quality specified, or it may exceed the minimum within reasonable limits. To comply with these requirements, indicated numeric values are minimum or maximum, as appropriate, for the context of requirements. Refer uncertainties to Consultant for a decision before proceeding.

#### 1.5 INFORMATIONAL SUBMITTALS

- A. Contractor's Quality-Control Plan: For quality-assurance and quality-control activities and responsibilities.
- B. Qualification Data : For Contractor's quality-control personnel.
- C. Testing Agency Qualifications (If Applicable): For testing agencies specified in "Quality Assurance" Article to demonstrate their capabilities and experience. Include proof of qualifications in the form of a recent report on the inspection of the testing agency by a recognized authority.
- D. Schedule of Tests and Inspections (If Applicable): Prepare in tabular form and include the following:
  - 1. Specification Section number and title.
  - 2. Entity responsible for performing tests and inspections.
  - 3. Description of test and inspection.
  - 4. Identification of applicable standards.
  - 5. Identification of test and inspection methods.
  - 6. Number of tests and inspections required.
  - 7. Time schedule or time span for tests and inspections.

8. Requirements for obtaining samples.
9. Unique characteristics of each quality-control service.

#### 1.6 CONTRACTOR'S QUALITY-CONTROL PLAN

- A. Quality-Control Plan, General: Submit quality-control plan within 10 days of Notice to Proceed, and not less than 5 days prior to preconstruction conference. Submit in format acceptable to Consultant. Identify personnel, procedures, controls, instructions, tests, records, and forms to be used to carry out Contractor's quality-assurance and quality-control responsibilities. Coordinate with Contractor's construction schedule.
- B. Quality-Control Personnel Qualifications: Engage qualified full-time personnel trained and experienced in managing and executing quality-assurance and quality-control procedures similar in nature and extent to those required for Project.
- C. Submittal Procedure: Describe procedures for ensuring compliance with requirements through review and management of submittal process. Indicate qualifications of personnel responsible for submittal review.
- D. Continuous Inspection of Workmanship: Describe process for continuous inspection during construction to identify and correct deficiencies in workmanship in addition to testing and inspection specified. Indicate types of corrective actions to be required to bring work into compliance with standards of workmanship established by Contract requirements and approved mockups.
- E. Monitoring and Documentation: Maintain testing and inspection reports including log of approved and rejected results. Include work Consultant has indicated as nonconforming or defective. Indicate corrective actions taken to bring nonconforming work into compliance with requirements. Comply with requirements of authorities having jurisdiction.

#### 1.7 REPORTS AND DOCUMENTS

- A. Test and Inspection Reports: Prepare and submit certified written reports specified in other Sections (if applicable). Include the following:
  1. Date of issue.
  2. Project title and number.
  3. Name, address, and telephone number of testing agency.
  4. Dates and locations of samples and tests or inspections.
  5. Names of individuals making tests and inspections.
  6. Description of the Work and test and inspection method.
  7. Identification of product and Specification Section.
  8. Complete test or inspection data.
  9. Test and inspection results and an interpretation of test results.
  10. Record of temperature and weather conditions at time of sample taking and testing and inspecting.
  11. Comments or professional opinion on whether tested or inspected Work complies with the Contract Document requirements.
  12. Name and signature of laboratory inspector.



13. Recommendations on retesting and reinspecting.

- B. Manufacturer's Technical Representative's Field Reports: Prepare written information documenting manufacturer's technical representative's tests and inspections specified in other Sections. Include the following:
1. Name, address, and telephone number of technical representative making report.
  2. Statement on condition of substrates and their acceptability for installation of product.
  3. Statement that products at Project site comply with requirements.
  4. Summary of installation procedures being followed, whether they comply with requirements and, if not, what corrective action was taken.
  5. Results of operational and other tests and a statement of whether observed performance complies with requirements.
  6. Statement whether conditions, products, and installation will affect warranty.
  7. Other required items indicated in individual Specification Sections.
- C. Permits, Licenses, and Certificates: For Owner's records, submit copies of permits, licenses, certifications, inspection reports, releases, jurisdictional settlements, notices, receipts for fee payments, judgments, correspondence, records, and similar documents, established for compliance with standards and regulations bearing on performance of the Work.

1.8 QUALITY ASSURANCE

- A. General: Qualifications paragraphs in this article establish the minimum qualification levels required; individual Specification Sections specify additional requirements.
- B. Manufacturer Qualifications: A firm experienced in manufacturing products or systems similar to those indicated for this Project and with a record of successful in-service performance, as well as sufficient production capacity to produce required units.
- C. Installer Qualifications: A firm or individual experienced in installing, erecting, or assembling work similar in material, design, and extent to that indicated for this Project, whose work has resulted in construction with a record of successful in-service performance.
- D. Manufacturer's Technical Representative Qualifications: An authorized representative of manufacturer who is trained and approved by manufacturer to observe and inspect installation of manufacturer's products that are similar in material, design, and extent to those indicated for this Project.
- a. Manufacturer's Technical Representative is to visit the site once every two weeks and provide observation reports throughout the duration of the project.

1.9 QUALITY CONTROL

- A. Owner Responsibilities: Where quality-control services are indicated as Owner's responsibility, Owner will engage a qualified testing agency to perform these services.
1. Costs for retesting and reinspecting will be withheld from the Contractor's pay application.

- B. Contractor Responsibilities: Contractor is not responsible for any testing or inspections. Perform additional quality-control activities required to verify that the Work complies with requirements.
- C. Manufacturer's Technical Services: Engage a manufacturer's technical representative to observe and inspect the Work. Manufacturer's technical representative's services include participation in preinstallation conferences, examination of substrates and conditions, verification of materials, observation of Installer activities, inspection of completed portions of the Work, and submittal of written reports.
  - a. Manufacturer's Technical Representative is to visit the site once every two weeks and provide observation reports throughout the duration of the project.
- D. Retesting/Reinspecting: Regardless of whether original tests or inspections were Contractor's responsibility, provide quality-control services, including retesting and reinspecting, for construction that replaced Work that failed to comply with the Contract Documents.
- E. Testing Agency Responsibilities (If Applicable): Cooperate with Consultant and Contractor in performance of duties. Provide qualified personnel to perform required tests and inspections.
  - 1. Notify Consultant and Contractor promptly of irregularities or deficiencies observed in the Work during performance of its services.
  - 2. Determine the location from which test samples will be taken and in which tests are conducted.
  - 3. Conduct and interpret tests and inspections and state in each report whether tested and inspected work complies with or deviates from requirements.
  - 4. Submit a certified written report, in duplicate, of each test, inspection, and similar quality-control service through Contractor.
  - 5. Do not release, revoke, alter, or increase the Contract Document requirements or approve or accept any portion of the Work.
  - 6. Do not perform any duties of Contractor.
- F. Coordination: Coordinate sequence of activities to accommodate required quality-assurance and -control services with a minimum of delay and to avoid necessity of removing and replacing construction to accommodate testing and inspecting.
  - 1. Schedule times for tests, inspections, obtaining samples, and similar activities.
- G. Schedule of Tests and Inspections: Prepare a schedule of tests, inspections, and similar quality-control services required by the Contract Documents. Coordinate and submit concurrently with Contractor's construction schedule. Update as the Work progresses.

#### 1.10 SPECIAL TESTS AND INSPECTIONS

- A. Special Tests and Inspections: Owner may engage a qualified testing agency or special inspector to conduct special tests and inspections required by authorities having jurisdiction.

PART 2 - PRODUCTS (Not Used)

PART 3 - EXECUTION

3.1 TEST AND INSPECTION LOG

- A. Test and Inspection Log: Prepare a record of tests and inspections. Include the following:
  - 1. Date test or inspection was conducted.
  - 2. Description of the Work tested or inspected.
  - 3. Date test or inspection results were transmitted to Consultant.
  - 4. Identification of testing agency or special inspector conducting test or inspection.
- B. Maintain log at Project site. Post changes and revisions as they occur. Provide access to test and inspection log for Consultant's reference during normal working hours.

3.2 REPAIR AND PROTECTION

- A. General: On completion of testing, inspecting, sample taking, and similar services, repair damaged construction and restore substrates and finishes.
  - 1. Provide materials and comply with installation requirements specified in other Specification Sections or matching existing substrates and finishes. Restore patched areas and extend restoration into adjoining areas with durable seams that are as invisible as possible. Comply with the Contract Document requirements for cutting and patching in Section 017300 "Execution."
- B. Protect construction exposed by or for quality-control service activities.
- C. Repair and protection are Contractor's responsibility, regardless of the assignment of responsibility for quality-control services.

END OF SECTION 014000

## SECTION 015000 - TEMPORARY FACILITIES AND CONTROLS

### PART 1 - GENERAL

#### 1.1 RELATED DOCUMENTS

- A. Drawings and general provisions of the Contract, including General and Supplementary Conditions and other Division 01 Specification Sections, apply to this Section.

#### 1.2 SUMMARY

- A. Section includes requirements for temporary utilities, support facilities, and security and protection facilities.
- B. Related Requirements:
  - 1. Section 011000 "Summary" for work restrictions and limitations on utility interruptions.

#### 1.3 USE CHARGES

- A. General: Installation and removal of and use charges for temporary facilities shall be included in the Contract Sum unless otherwise indicated. Allow other entities to use temporary services and facilities without cost, including, but not limited to Consultant, testing agencies, and authorities having jurisdiction.
- B. Water Service: Owner will pay water-service use charges for water used by all entities for construction operations.
- C. Electric Power Service: Owner will provide electric-power-service used by contractors for construction operations to the extent that the contractor does not interrupt the service of the building. Any upgrades in power are to be provided the Contractor at the Contractor's expense. Contractor is responsible for any damages incurred to the service by their work.
- D. Contractor shall provide connections and extensions needed to services at no cost to the Owner and shall return to original condition when services are no longer needed. At no time shall the services be disrupted by construction operations.

#### 1.4 SUBMITTALS

- A. Site Plan: Show temporary facilities, utility hookups, staging areas, and parking areas for construction personnel.
- B. Fire-Safety Program: Show compliance with requirements of NFPA 241 and authorities having jurisdiction. Indicate Contractor personnel responsible for management of fire-prevention program.

- C. Moisture-Protection Plan: Describe procedures and controls for protecting materials and construction from water absorption and damage.
  - 1. Describe delivery, handling, and storage provisions for materials subject to water absorption or water damage.
  - 2. Indicate procedures for discarding water-damaged materials, protocols for mitigating water intrusion into completed Work, and replacing water-damaged Work.
  - 3. Indicate sequencing of work that requires water and describe plans for dealing with water from these operations. Show procedures for verifying that wet construction has dried sufficiently to permit installation of finish materials.
  
- D. Dust- and HVAC-Control Plan: Submit coordination drawing and narrative that indicates the dust- and HVAC-control measures proposed for use, proposed locations, and proposed time frame for their operation. Identify further options if proposed measures are later determined to be inadequate. Include the following:
  - 1. Locations of dust-control partitions at each phase of work.
  - 2. Air-filtration system needed at intakes.
  - 3. Other dust-control measures.

## 1.5 QUALITY ASSURANCE

- A. Electric Service: Comply with NECA, NEMA, and UL standards and regulations for temporary electric service. Install service to comply with NFPA 70.
- B. Tests and Inspections: Arrange for authorities having jurisdiction to test and inspect each temporary utility before use. Obtain required certifications and permits.
- C. Accessible Temporary Egress: Comply with applicable provisions in the U.S. Architectural & Transportation Barriers Compliance Board's ADA-ABA Accessibility Guidelines and ICC/ANSI A117.1.

## 1.6 PROJECT CONDITIONS

- A. Temporary Use of Permanent Facilities: Engage Installer of each permanent service to assume responsibility for operation, maintenance, and protection of each permanent service during its use as a construction facility before Owner's acceptance, regardless of previously assigned responsibilities.

## PART 2 - PRODUCTS

### 2.1 MATERIALS

- A. Portable Chain-Link Fencing: Minimum 2-inch thick, galvanized-steel, chain-link fabric fencing; minimum 6 feet high with galvanized-steel pipe posts; minimum 2-3/8-inch OD line posts and 2-7/8-inch OD corner and pull posts, with 1-5/8-inch OD top and bottom rails. Provide concrete or galvanized-steel bases for supporting posts.

- B. Safety flagging, safety cones, and signage.

## 2.2 TEMPORARY FACILITIES

- A. Field Offices, General: If needed and approved by the Owner, provided prefabricated or mobile units with serviceable finishes, temperature controls, and foundations adequate for normal loading.
- B. Storage and Fabrication Sheds: Provide sheds sized, furnished, and equipped to accommodate materials and equipment for construction operations.
  - 1. Store combustible materials apart from building.
- C. Portable Restrooms: Portable restrooms are to be cleaned and maintained on a regular basis. Location to be selected by the Owner during the pre-construction conference.

## 2.3 EQUIPMENT

- A. Fire Extinguishers: Portable, UL rated; with class and extinguishing agent as required by locations and classes of fire exposures.
- B. Air-Filters: Provide charcoal filters or other Owner recommended filter at all HVAC intakes for the duration of the work.

## PART 3 - EXECUTION

### 3.1 INSTALLATION, GENERAL

- A. Locate facilities where they will serve Project adequately and result in minimum interference with performance of the Work. Relocate and modify facilities as required by progress of the Work.
  - 1. Locate facilities to limit site disturbance as specified in Section 011000 "Summary."
- B. Provide each facility ready for use when needed to avoid delay. Do not remove until facilities are no longer needed or are replaced by authorized use of completed permanent facilities.

### 3.2 TEMPORARY UTILITY INSTALLATION

- A. General: Install temporary service or connect to existing service.
  - 1. Arrange with utility company, Owner, and existing users for time when service can be interrupted, if necessary, to make connections for temporary services.
- B. Water Service: Connect to Owner's existing water service facilities. Clean and maintain water service facilities in a condition acceptable to Owner. At Substantial Completion, restore these facilities to condition existing before initial use.

- C. Sanitary Facilities: Provide temporary toilets, wash facilities, and drinking water for use of construction personnel. Comply with requirements of authorities having jurisdiction for type, number, location, operation, and maintenance of fixtures and facilities.
  - 1. Toilets: Use of Owner's existing toilet facilities will not be permitted.
- D. Work Areas in Occupied Facilities: Prevent dust, fumes, and odors from entering occupied areas.
  - 1. Prior to commencing work, provide charcoal filters or other Owner recommended filter at all HVAC intakes for the duration of the work.
- E. Electric Power Service: Connect to Owner's existing electric power service. Maintain equipment in a condition acceptable to Owner. If additional power is needed other than what is provided by the Owner, Contractor is to provide electric power service and distribution system of sufficient size, capacity, and power characteristics required for construction operations.
  - 1. Connect temporary service to Owner's existing power source, as directed by Owner.
- F. Telephone Service: Contractor to provide superintendent with cellular telephone or portable two-way radio for use during construction.

### 3.3 SUPPORT FACILITIES INSTALLATION

- A. Traffic Controls: Comply with requirements of the Owner.
  - 1. Protect existing site including curbs, pavement, and utilities.
  - 2. Maintain access for fire-fighting equipment and access to fire hydrants.
- B. Parking: Use areas designated by the Owner for parking of construction vehicles.
- C. Project Signs: Provide Project signs as indicated. Unauthorized signs are not permitted.
  - 1. Temporary Signs: Provide signs informing public/individuals seeking entrance to Project facility.
    - a. Provide temporary, directional signs for construction personnel, building occupants and visitors.
  - 2. Maintain and touchup signs so they are legible at all times.
- D. Waste Disposal Facilities: Provide waste-collection containers in sizes adequate to handle waste from construction operations. Comply with requirements of authorities having jurisdiction. Comply with progress cleaning requirements in Section 017300 "Execution."
- E. Lifts and Hoists: Provide facilities necessary for hoisting materials and personnel.
  - 1. Truck cranes and similar devices used for hoisting materials are considered "tools and equipment" and not temporary facilities.
  - 2. A ground/watch person will be required when equipment is in use.

- F. Temporary Elevator Use: Use of elevators is not permitted.
- G. Temporary Access: Provide temporary exterior scaffolding, stairs or ladders as required to access areas of work.

### 3.4 SECURITY AND PROTECTION FACILITIES INSTALLATION

- A. Protection of Existing Facilities: Protect existing vegetation, equipment, structures, utilities, and other improvements at Project site and on adjacent properties, except those indicated to be removed or altered. Repair damage to existing facilities.
- B. Environmental Protection: Provide protection, operate temporary facilities, and conduct construction as required to comply with environmental regulations and that minimize possible air, waterway, and subsoil contamination or pollution or other undesirable effects.
  - 1. Comply with work restrictions specified in Section 011000 "Summary."
- C. Security Enclosure and Lockup: Install temporary enclosure around partially completed areas of construction. Provide lockable entrances to prevent unauthorized entrance, vandalism, theft, and similar violations of security. Lock entrances at end of each work day.
- D. Barricades, Warning Signs, and Lights: Comply with requirements of authorities having jurisdiction for erecting structurally adequate barricades, including warning signs and lighting.
- E. Temporary Egress: Maintain temporary egress from existing occupied facilities as indicated and as required by authorities having jurisdiction.
- F. Temporary Enclosures: Provide temporary enclosures for protection of construction, in progress and completed, from exposure, foul weather, other construction operations, and similar activities. Provide temporary weathertight enclosure for building exterior.
- G. Temporary Fire Protection: Install and maintain temporary fire-protection facilities of types needed to protect against reasonably predictable and controllable fire losses. Comply with NFPA 241; manage fire-prevention program.
  - 1. Smoking is not permitted on property.
  - 2. Supervise welding operations, combustion-type temporary heating units, and similar sources of fire ignition according to requirements of authorities having jurisdiction.
  - 3. Develop and supervise an overall fire-prevention and -protection program for personnel at Project site. Review needs with local fire department and establish procedures to be followed. Instruct personnel in methods and procedures. Post warnings and information.
  - 4. Provide temporary standpipes and hoses for fire protection. Hang hoses with a warning sign stating that hoses are for fire-protection purposes only and are not to be removed. Match hose size with outlet size and equip with suitable nozzles.

### 3.5 MOISTURE AND MOLD CONTROL

- A. Contractor's Moisture-Protection Plan: Avoid trapping water in finished work. Document visible signs of mold that may appear during construction.



- B. Exposed Construction Phase: Before installation of weather barriers, when materials are subject to wetting and exposure and to airborne mold spores, protect as follows:
  - 1. Protect porous materials from water damage.
  - 2. Protect stored and installed material from flowing or standing water.
  - 3. Keep porous and organic materials from coming into prolonged contact with concrete.
  - 4. Remove standing water from decks.
  - 5. Keep deck openings covered.
  
- C. Construction Phase: During installation of materials and when installed materials are subject to infiltration of moisture, protect as follows:
  - 1. Discard or replace water-damaged material.
  - 2. Do not install material that is wet.
  - 3. Discard and replace material that is or has been wet.

### 3.6 OPERATION, TERMINATION, AND REMOVAL

- A. Supervision: Enforce strict discipline in use of temporary facilities. To minimize waste and abuse, limit availability of temporary facilities to essential and intended uses.
  
- B. Maintenance: Maintain facilities in good operating condition until removal.
  - 1. Maintain operation of temporary enclosures, heating, cooling, humidity control, ventilation, and similar facilities on a 24-hour basis where required to achieve indicated results and to avoid possibility of damage.
  
- C. Termination and Removal: Remove each temporary facility when need for its service has ended, when it has been replaced by authorized use of a permanent facility, or no later than Substantial Completion. Complete or, if necessary, restore permanent construction that may have been delayed because of interference with temporary facility. Repair damaged Work, clean exposed surfaces, and replace construction that cannot be satisfactorily repaired.
  - 1. Materials and facilities that constitute temporary facilities are property of Contractor. Owner reserves right to take possession of Project identification signs.
  - 2. At Substantial Completion, repair, renovate, and clean permanent facilities used during construction period. Comply with final cleaning requirements specified in Section 017700 "Closeout Procedures."

END OF SECTION 015000

## SECTION 016000 - PRODUCT REQUIREMENTS

### PART 1 - GENERAL

#### 1.1 RELATED DOCUMENTS

- A. Drawings and general provisions of the Contract, including General and Supplementary Conditions and other Division 01 Specification Sections, apply to this Section.

#### 1.2 SUMMARY

- A. Section includes administrative and procedural requirements for selection of products for use in Project; product delivery, storage, and handling; manufacturers' standard warranties on products; special warranties; and comparable products.
- B. Related Requirements:
  - 1. Section 012500 "Substitution Procedures" for requests for substitutions.
  - 2. Section 014200 "References" for applicable industry standards for products specified.

#### 1.3 DEFINITIONS

- A. Products: Items obtained for incorporating into the Work, whether purchased for Project or taken from previously purchased stock. The term "product" includes the terms "material," "equipment," "system," and terms of similar intent.
  - 1. Named Products: Items identified by manufacturer's product name, including make or model number or other designation shown or listed in manufacturer's published product literature, that is current as of date of the Contract Documents.
  - 2. New Products: Items that have not previously been incorporated into another project or facility. Products salvaged or recycled from other projects are not considered new products.
  - 3. Comparable Product: Product that is demonstrated and approved through submittal process to have the indicated qualities related to type, function, dimension, in-service performance, physical properties, appearance, and other characteristics that equal or exceed those of specified product.
- B. Basis-of-Design Product Specification: A specification in which a specific manufacturer's product is named and accompanied by the words "basis-of-design product," including make or model number or other designation, to establish the significant qualities related to type, function, dimension, in-service performance, physical properties, appearance, and other characteristics for purposes of evaluating comparable products of additional manufacturers named in the specification.

#### 1.4 ACTION SUBMITTALS

- A. Comparable Product Requests: Submit request for consideration of each comparable product. Identify product or fabrication or installation method to be replaced. Include Specification Section number and title and Drawing numbers and titles.
  - 1. Include data to indicate compliance with the requirements specified in "Comparable Products" Article.
  - 2. Consultant's Action: If necessary, Consultant will request additional information or documentation for evaluation within one week of receipt of a comparable product request. Consultant will notify Contractor of approval or rejection of proposed comparable product request within 7 days of receipt of request, or 7 days of receipt of additional information or documentation, whichever is later.
    - a. Form of Approval: As specified in Section 013300 "Submittal Procedures."
    - b. Use product specified if Consultant does not issue a decision on use of a comparable product request within time allocated.
- B. Basis-of-Design Product Specification Submittal: Comply with requirements in Section 013300 "Submittal Procedures." Show compliance with requirements.

#### 1.5 QUALITY ASSURANCE

- A. Compatibility of Options: If Contractor is given option of selecting between two or more products for use on Project, select product compatible with products previously selected, even if previously selected products were also options.
  - 1. Each contractor is responsible for providing products and construction methods compatible with products and construction methods of other contractors.
  - 2. If a dispute arises between contractors over concurrently selectable but incompatible products, Architect will determine which products shall be used.

#### 1.6 PRODUCT DELIVERY, STORAGE, AND HANDLING

- A. Deliver, store, and handle products using means and methods that will prevent damage, deterioration, and loss, including theft and vandalism. Comply with manufacturer's written instructions.
- B. Delivery and Handling:
  - 1. Schedule delivery to minimize long-term storage at Project site and to prevent overcrowding of construction spaces.
  - 2. Coordinate delivery with installation time to ensure minimum holding time for items that are flammable, hazardous, easily damaged, or sensitive to deterioration, theft, and other losses.
  - 3. Deliver products to Project site in an undamaged condition in manufacturer's original sealed container or other packaging system, complete with labels and instructions for handling, storing, unpacking, protecting, and installing.

4. Inspect products on delivery to determine compliance with the Contract Documents and to determine that products are undamaged and properly protected.

C. Storage:

1. Store products to allow for inspection and measurement of quantity or counting of units.
2. Store materials in a manner that will not endanger Project structure.
3. Store products that are subject to damage by the elements, under cover in a weathertight enclosure above ground, with ventilation adequate to prevent condensation.
4. Protect foam plastic from exposure to sunlight, except to extent necessary for period of installation and concealment.
5. Comply with product manufacturer's written instructions for temperature, humidity, ventilation, and weather-protection requirements for storage.
6. Protect stored products from damage and liquids from freezing.
7. Provide a secure location and enclosure at Project site for storage of materials and equipment by Owner's construction forces. Coordinate location with Owner.

## 1.7 PRODUCT WARRANTIES

- A. Warranties specified in other Sections shall be in addition to, and run concurrent with, other warranties required by the Contract Documents. Manufacturer's disclaimers and limitations on product warranties do not relieve Contractor of obligations under requirements of the Contract Documents.

1. **Manufacturer's Warranty:** Written warranty furnished by individual manufacturer for a particular product and specifically endorsed by manufacturer to Owner.
2. **Special Warranty:** Written warranty required by the Contract Documents to provide specific rights for Owner.

- B. **Special Warranties:** Prepare a written document that contains appropriate terms and identification, ready for execution.

1. **Manufacturer's Standard Form:** Modified to include Project-specific information and properly executed.
2. **Specified Form:** When specified forms are included with the Specifications, prepare a written document using indicated form properly executed.
3. See other Sections for specific content requirements and particular requirements for submitting special warranties.

- C. **Submittal Time:** Comply with requirements in Section 017700 "Closeout Procedures."

## PART 2 - PRODUCTS

### 2.1 PRODUCT SELECTION PROCEDURES

- A. **General Product Requirements:** Provide products that comply with the Contract Documents, are undamaged and, unless otherwise indicated, are new at time of installation.

1. Provide products complete with accessories, trim, finish, fasteners, and other items needed for a complete installation and indicated use and effect.
2. Standard Products: If available, and unless custom products or nonstandard options are specified, provide standard products of types that have been produced and used successfully in similar situations on other projects.
3. Owner reserves the right to limit selection to products with warranties not in conflict with requirements of the Contract Documents.
4. Where products are accompanied by the term "as selected," Architect will make selection.
5. Descriptive, performance, and reference standard requirements in the Specifications establish salient characteristics of products.
6. Or Equal: For products specified by name and accompanied by the term "or equal," or "or approved equal," or "or approved," comply with requirements in "Comparable Products" Article to obtain approval for use of an unnamed product.

B. Product Selection Procedures:

1. Product: Where Specifications name a single manufacturer and product, provide the named product that complies with requirements. Comparable products or substitutions for Contractor's convenience will not be considered.
2. Manufacturer/Source: Where Specifications name a single manufacturer or source, provide a product by the named manufacturer or source that complies with requirements. Comparable products or substitutions for Contractor's convenience will not be considered.
3. Products:
  - a. Restricted List: Where Specifications include a list of names of both manufacturers and products, provide one of the products listed that complies with requirements. Comparable products or substitutions for Contractor's convenience will be considered, unless otherwise indicated.
  - b. Nonrestricted List: Where Specifications include a list of names of both available manufacturers and products, provide one of the products listed, or an unnamed product, that complies with requirements. Comply with requirements in "Comparable Products" Article for consideration of an unnamed product.
4. Manufacturers:
  - a. Restricted List: Where Specifications include a list of manufacturers' names, provide a product by one of the manufacturers listed that complies with requirements. Comparable products or substitutions for Contractor's convenience will be considered, unless otherwise indicated.
  - b. Nonrestricted List: Where Specifications include a list of available manufacturers, provide a product by one of the manufacturers listed, or a product by an unnamed manufacturer, that complies with requirements. Comply with requirements in "Comparable Products" Article for consideration of an unnamed manufacturer's product.
5. Basis-of-Design Product: Where Specifications name a product, or refer to a product indicated on Drawings, and include a list of manufacturers, provide the specified or indicated product or a comparable product by one of the other named manufacturers. Drawings and Specifications indicate sizes, profiles, dimensions, and other characteristics

that are based on the product named. Comply with requirements in "Comparable Products" Article for consideration of an unnamed product by one of the other named manufacturers.

## 2.2 COMPARABLE PRODUCTS

- A. Conditions for Consideration: Architect will consider Contractor's request for comparable product when the following conditions are satisfied. If the following conditions are not satisfied, Architect may return requests without action, except to record noncompliance with these requirements:
1. Evidence that the proposed product does not require revisions to the Contract Documents, that it is consistent with the Contract Documents and will produce the indicated results, and that it is compatible with other portions of the Work.
  2. Detailed comparison of significant qualities of proposed product with those named in the Specifications. Significant qualities include attributes such as performance, weight, size, durability, visual effect, and specific features and requirements indicated.
  3. Evidence that proposed product provides specified warranty.
  4. List of similar installations for completed projects with project names and addresses and names and addresses of architects and owners, if requested.
  5. Samples, if requested.

PART 3 - EXECUTION (Not Used)

END OF SECTION 016000

## SECTION 017300 - EXECUTION

### PART 1 - GENERAL

#### 1.1 RELATED DOCUMENTS

- A. Drawings and general provisions of the Contract, including General and Supplementary Conditions and other Division 01 Specification Sections, apply to this Section.

#### 1.2 SUMMARY

- A. Section includes general administrative and procedural requirements governing execution of the Work including, but not limited to, the following:

1. Installation of the Work.
2. Cutting and patching.
3. Progress cleaning.
4. Preparation.
5. Protection of installed construction.

- B. Related Requirements:

1. Section 011000 "Summary" for limits on use of Project site.
2. Section 013300 "Submittal Procedures" for submitting surveys.
3. Section 017700 "Closeout Procedures" for submitting final property survey with Project Record Documents, recording of Owner-accepted deviations from indicated lines and levels, and final cleaning.
4. Section 024119 "Selective Demolition" for demolition and removal of selected portions of the building.

#### 1.3 DEFINITIONS

- A. Cutting: Removal of in-place construction necessary to permit installation or performance of other work.
- B. Patching: Fitting and repair work required to restore construction to original conditions after installation of other work.

#### 1.4 INFORMATIONAL SUBMITTALS

- A. Cutting and Patching Plan: Submit plan describing procedures at least 7 days prior to the time cutting and patching will be performed. Include the following information:
  1. Extent: Describe reason for and extent of each occurrence of cutting and patching.

2. Changes to In-Place Construction: Describe anticipated results. Include changes to structural elements and operating components as well as changes in building appearance and other significant visual elements.
3. Products: List products to be used for patching and firms or entities that will perform patching work.
4. Dates: Indicate when cutting and patching will be performed.
5. Utilities and Mechanical and Electrical Systems: List services and systems that cutting and patching procedures will disturb or affect. List services and systems that will be relocated and those that will be temporarily out of service. Indicate length of time permanent services and systems will be disrupted.
  - a. Include description of provisions for temporary services and systems during interruption of permanent services and systems.

## 1.5 QUALITY ASSURANCE

- A. Cutting and Patching: Comply with requirements for and limitations on cutting and patching of construction elements.
  1. Structural Elements: When cutting and patching structural elements, notify Consultant of locations and details of cutting and await directions from Consultant before proceeding. Shore, brace, and support structural elements during cutting and patching. Do not cut and patch structural elements in a manner that could change their load-carrying capacity or increase deflection
  2. Operational Elements: Do not cut and patch operating elements and related components in a manner that results in reducing their capacity to perform as intended or that results in increased maintenance or decreased operational life or safety. Operational elements include the following:
    - a. Primary operational systems and equipment.
    - b. Fire separation assemblies.
    - c. Air or smoke barriers.
    - d. Mechanical systems piping and ducts.
    - e. Control systems.
    - f. Communication systems.
    - g. Fire-detection and -alarm systems.
    - h. Electrical wiring systems.
  3. Other Construction Elements: Do not cut and patch other construction elements or components in a manner that could change their load-carrying capacity, that results in reducing their capacity to perform as intended, or that results in increased maintenance or decreased operational life or safety. Other construction elements include but are not limited to the following:
    - a. Water, moisture, or vapor barriers.
    - b. Membranes and flashings.
    - c. Sprayed fire-resistive material.
    - d. Equipment supports.
    - e. Piping, ductwork, and equipment.



- f. Noise- and vibration-control elements and systems.
- 4. Visual Elements: Do not cut and patch construction in a manner that results in visual evidence of cutting and patching. Do not cut and patch exposed construction in a manner that would, in Architect's opinion, reduce the building's aesthetic qualities. Remove and replace construction that has been cut and patched in a visually unsatisfactory manner.
- B. Before proceeding, meet at Project site with parties involved in cutting and patching, including mechanical and electrical trades. Review areas of potential interference and conflict. Coordinate procedures and resolve potential conflicts before proceeding.
- C. Manufacturer's Installation Instructions: Obtain and maintain on-site manufacturer's written recommendations and instructions for installation of products and equipment.

## PART 2 - PRODUCTS

### 2.1 MATERIALS

- A. In-Place Materials: Use materials for patching identical to in-place materials. For exposed surfaces, use materials that visually match in-place adjacent surfaces to the fullest extent possible.
  - 1. If identical materials are unavailable or cannot be used, use materials that, when installed, will provide a match acceptable to Consultant for the visual and functional performance of in-place materials.

## PART 3 - EXECUTION

### 3.1 EXAMINATION

- A. Existing Conditions: Before beginning work, investigate and verify the existence and location of underground utilities, mechanical and electrical systems that could be damaged by construction or construction traffic.
- B. Examination and Acceptance of Conditions: Before proceeding with each component of the Work, examine substrates, areas, and conditions, for compliance with requirements for installation tolerances and other conditions affecting performance.
  - 1. Examine walls and roofs for suitable conditions where products and systems are to be installed.
  - 2. Verify compatibility with and suitability of substrates.
- C. Proceed with installation only after unsatisfactory conditions have been corrected. Proceeding with the Work indicates acceptance of surfaces and conditions.

### 3.2 PREPARATION

- A. Existing Utility Information: Furnish information to Owner that is necessary to adjust, move, or relocate existing utility structures, utility poles, lines, services, or other utility appurtenances located in or affected by construction. Coordinate with authorities having jurisdiction.
- B. Field Measurements: Take field measurements as required to fit the Work properly.
- C. Review of Contract Documents and Field Conditions: Immediately on discovery of the need for clarification of the Contract Documents caused by differing field conditions outside the control of Contractor, submit a request for information to Consultant according to requirements in Section 013100 "Project Management and Coordination."

### 3.3 INSTALLATION

- A. General: Locate the Work and components of the Work accurately, in correct alignment and location, as indicated.
  - 1. Make vertical work plumb and make horizontal work level.
- B. Comply with manufacturer's written instructions and recommendations for installing products in applications indicated.
- C. Install products at the time and under conditions that will ensure the best possible results. Maintain conditions required for product performance until Substantial Completion.
- D. Conduct construction operations so no part of the Work is subjected to damaging operations or loading in excess of that expected during normal conditions of occupancy.
- E. Tools and Equipment: Do not use tools or equipment that produce harmful noise levels.
- F. Attachment: Provide blocking and attachment plates and anchors and fasteners of adequate size and number to securely anchor each component in place, accurately located and aligned with other portions of the Work. Where size and type of attachments are not indicated, verify size and type required for load conditions.
  - 1. Allow for building movement, including thermal expansion and contraction.
  - 2. Coordinate installation of anchorages. Furnish setting drawings, templates, and directions for installing anchorages, including sleeves, concrete inserts, anchor bolts, and items with integral anchors, that are to be embedded in concrete or masonry. Deliver such items to Project site in time for installation.
- G. Penetrations: All penetrations shall be raised to accommodate a minimum base flashing height of eight inches (8").
- H. Joints: Make joints of uniform width. Where joint locations in exposed work are not indicated, arrange joints for the best visual effect. Fit exposed connections together to form hairline joints.
- I. Hazardous Materials: Use products, cleaners, and installation materials that are not considered hazardous.

### 3.4 CUTTING AND PATCHING

- A. Cutting and Patching, General: Employ skilled workers to perform cutting and patching. Proceed with cutting and patching at the earliest feasible time, and complete without delay.
  - 1. Cut in-place construction to provide for installation of other components or performance of other construction, and subsequently patch as required to restore surfaces to their original condition.
- B. Temporary Support: Provide temporary support of work to be cut.
- C. Protection: Protect in-place construction during cutting and patching to prevent damage. Provide protection from adverse weather conditions for portions of Project that might be exposed during cutting and patching operations.
- D. Adjacent Occupied Areas: Where interference with use of adjoining areas or interruption of free passage to adjoining areas is unavoidable, coordinate cutting and patching according to requirements in Section 011000 "Summary."
- E. Cutting: Cut in-place construction by sawing, drilling, breaking, chipping, grinding, and similar operations, including excavation, using methods least likely to damage elements retained or adjoining construction. If possible, review proposed procedures with original Installer; comply with original Installer's written recommendations.
  - 1. In general, use hand or small power tools designed for sawing and grinding, not hammering and chopping. Cut holes and slots neatly to minimum size required, and with minimum disturbance of adjacent surfaces. Temporarily cover openings when not in use.
  - 2. Finished Surfaces: Cut or drill from the exposed or finished side into concealed surfaces.
  - 3. Concrete and Masonry: Cut using a cutting machine, such as an abrasive saw or a diamond-core drill.
  - 4. Mechanical and Electrical Services: Cut off pipe or conduit in walls or partitions to be removed. Cap, valve, or plug and seal remaining portion of pipe or conduit to prevent entrance of moisture or other foreign matter after cutting.
  - 5. Proceed with patching after construction operations requiring cutting are complete.
- F. Patching: Patch construction by filling, repairing, refinishing, closing up, and similar operations following performance of other work. Patch with durable seams that are as invisible as practicable. Provide materials and comply with installation requirements specified in other Sections, where applicable.
  - 1. Inspection: Where feasible, test and inspect patched areas after completion to demonstrate physical integrity of installation.
  - 2. Exposed Finishes: Restore exposed finishes of patched areas and extend finish restoration into retained adjoining construction in a manner that will minimize evidence of patching and refinishing.
  - 3. Exterior Building Enclosure: Patch components in a manner that restores enclosure to a weathertight condition and ensures thermal and moisture integrity of building enclosure.
- G. Cleaning: Clean areas and spaces where cutting and patching are performed. Remove paint, mortar, oils, putty, and similar materials from adjacent finished surfaces.

### 3.5 PROGRESS CLEANING

- A. General: Clean Project site and work areas daily, including common areas. Enforce requirements strictly. Dispose of materials lawfully.
  - 1. Comply with requirements in NFPA 241 for removal of combustible waste materials and debris.
  - 2. Containerize hazardous and unsanitary waste materials separately from other waste. Mark containers appropriately and dispose of legally, according to regulations.
    - a. Use containers intended for holding waste materials of type to be stored.
  - 3. Coordinate progress cleaning for joint-use areas where Contractor and other contractors are working concurrently.
- B. Site: Maintain Project site free of waste materials and debris.
- C. Work Areas: Clean areas where work is in progress to the level of cleanliness necessary for proper execution of the Work.
  - 1. Remove liquid spills promptly.
  - 2. Where dust would impair proper execution of the Work, broom-clean or vacuum the entire work area, as appropriate.
- D. Installed Work: Keep installed work clean. Clean installed surfaces according to written instructions of manufacturer or fabricator of product installed, using only cleaning materials specifically recommended and/or as installed in new condition. If specific cleaning materials are not recommended, use cleaning materials that are not hazardous to health or property and that will not damage exposed surfaces.
- E. Concealed Spaces: Remove debris from concealed spaces before enclosing the space.
- F. During handling and installation, clean and protect construction in progress and adjoining materials already in place. Apply protective covering where required to ensure protection from damage or deterioration at Substantial Completion.
- G. Clean and provide maintenance on completed construction as frequently as necessary through the remainder of the construction period. Adjust and lubricate operable components to ensure operability without damaging effects.
- H. Limiting Exposures: Supervise construction operations to assure that no part of the construction, completed or in progress, is subject to harmful, dangerous, damaging, or otherwise deleterious exposure during the construction period.

### 3.6 PROTECTION OF INSTALLED CONSTRUCTION

- A. Provide final protection and maintain conditions that ensure installed Work is without damage or deterioration at time of Substantial Completion.

END OF SECTION 017300

## SECTION 017700 - CLOSEOUT PROCEDURES

### PART 1 - GENERAL

#### 1.1 RELATED DOCUMENTS

- A. Drawings and general provisions of the Contract, including General and Supplementary Conditions and other Division 01 Specification Sections, apply to this Section.

#### 1.2 SUMMARY

- A. Section includes administrative and procedural requirements for contract closeout, including, but not limited to, the following:
  - 1. Substantial Completion procedures.
  - 2. Final completion procedures.
  - 3. Warranties.
  - 4. Final cleaning.
  - 5. Repair of the Work.
  - 6. Project Close-out Documents
- B. Related Requirements:
  - 1. Section 013233 "Photographic Documentation" for submitting final completion construction photographic documentation.
  - 2. Section 017300 "Execution" for progress cleaning of Project site.

#### 1.3 ACTION SUBMITTALS

- A. Product Data: For cleaning agents.
- B. Contractor's List of Incomplete Items: Initial submittal at Substantial Completion.
- C. Certified List of Incomplete Items: Final submittal at Final Completion.

#### 1.4 CLOSEOUT SUBMITTALS

- A. Certificates of Release: AIA G706 for each Application for Payment submitted for the project.

- B. Certificate of Insurance: AIA G715 from authorized insurance agent certifying project insurance coverage as required by the contract documents.
- C. Document stating continuing insurance coverage of the project.
- D. Consent of surety, to final payment in the form AIA G707.
- E. Field Report: Any reports from Consultant, Architect, and/or Manufacturer of onsite inspections.
- F. As-Built Drawings – redlining any changes from the Construction Documents.
- G. Warranties – Contractor Warranty and Roofing Manufacturer’s Warranty.
- H. Operation and Maintenance Manuals.
- I. Final Application for Payment.

#### 1.5 SUBSTANTIAL COMPLETION PROCEDURES

- A. Contractor's List of Incomplete Items: Prepare and submit a list of items to be completed and corrected (Contractor's punch list), indicating the value of each item on the list and reasons why the Work is incomplete. Formally request for Substantial Completion on SE-550.
- B. Submittals Prior to Substantial Completion: Complete the following a minimum of 10 days prior to requesting inspection for determining date of Substantial Completion. List items below that are incomplete at time of request.
  - 1. Certificates of Release: Obtain and submit releases from authorities having jurisdiction permitting Owner unrestricted use of the Work and access to services and utilities. Include occupancy permits, operating certificates, and similar releases.
  - 2. Submit closeout submittals specified in other Division 01 Sections, including project record documents, operation and maintenance manuals, final completion construction photographic documentation, damage or settlement surveys, and similar final record information.
  - 3. Submit closeout submittals specified in individual Sections, including specific warranties, workmanship bonds, maintenance service agreements, final certifications, and similar documents.
- C. Inspection: Submit a written request for inspection to determine Substantial Completion a minimum of 10 days prior to date the work will be completed and ready for final inspection and tests. On receipt of request, Consultant will either proceed with inspection or notify Contractor of unfulfilled requirements. Consultant will prepare the Certificate of Substantial Completion after inspection or will notify Contractor of items, either on Contractor's list or additional items identified by Consultant, that must be completed or corrected before certificate will be issued.
  - 1. Reinspection: Request reinspection when the Work identified in previous inspections as incomplete is completed or corrected.
  - 2. Results of completed inspection will form the basis of requirements for final completion.

## 1.6 FINAL COMPLETION PROCEDURES

- A. Submittals Prior to Final Completion: Before requesting final inspection for determining final completion, complete the following:
1. Submit a final Application for Payment according to Section 012900 "Payment Procedures."
  2. Certified List of Incomplete Items: Submit certified copy of Consultant's Substantial Completion inspection list of items to be completed or corrected (punch list), endorsed and dated by Consultant. Certified copy of the list shall state that each item has been completed or otherwise resolved for acceptance. Formally request for Final Completion on SE-560.
  3. Certificate of Insurance: Submit evidence of final, continuing insurance coverage complying with insurance requirements.
- B. Inspection: Submit a written request for final inspection to determine acceptance a minimum of 10 days prior to date the work will be completed and ready for final inspection and tests. On receipt of request, Consultant will either proceed with inspection or notify Contractor of unfulfilled requirements. Consultant will prepare a final Certificate for Payment after inspection or will notify Contractor of construction that must be completed or corrected before certificate will be issued.
1. Reinspection: Request reinspection when the Work identified in previous inspections as incomplete is completed or corrected.

## 1.7 SUBMITTAL OF PROJECT WARRANTIES

- A. Time of Submittal: Submit written warranties on request of Consultant for designated portions of the Work where commencement of warranties other than date of Substantial Completion is indicated, or when delay in submittal of warranties might limit Owner's rights under warranty.
- B. Organize warranty documents into an orderly sequence based on the table of contents of Project Manual.
1. Bind warranties and bonds with all other close-out documents in heavy-duty, three-ring, vinyl-covered, loose-leaf binders, thickness as necessary to accommodate contents, and sized to receive 8-1/2-by-11-inch paper.
  2. Provide heavy paper dividers with plastic-covered tabs for each separate warranty. Mark tab to identify the product or installation. Provide a typed description of the product or installation, including the name of the product and the name, address, and telephone number of Installer.
  3. Identify each binder on the front of each tab with the typed or printed title, Project name, and name of Contractor.
  4. Warranty Electronic File: Scan warranties and bonds with all other close-out documents and assemble complete warranty and bond submittal package into a single indexed

electronic PDF file with links enabling navigation to each item. Provide bookmarked table of contents at beginning of document.

## 1.8 MAINTENANCE MATERIAL SUBMITTALS

- A. Schedule of Maintenance Material Items: For maintenance material submittal items specified in other Sections.

## PART 2 - PRODUCTS

### 2.1 MATERIALS

- A. Cleaning Agents: Use cleaning materials and agents recommended by manufacturer or fabricator of the surface to be cleaned. Do not use cleaning agents that are potentially hazardous to health or property or that might damage finished surfaces.
  - 1. Use cleaning products that comply with Green Seal's GS-37, or if GS-37 is not applicable, use products that comply with the California Code of Regulations maximum allowable VOC levels.

## PART 3 - EXECUTION

### 3.1 FINAL CLEANING

- A. General: Perform final cleaning. All construction debris shall be removed from the job site. Conduct cleaning and waste-removal operations to comply with local laws and ordinances and Federal and local environmental and antipollution regulations.
- B. Cleaning: Employ experienced workers or professional cleaners for final cleaning. Clean each surface or unit to condition expected in an average commercial building cleaning and maintenance program. Comply with manufacturer's written instructions.
  - 1. Complete the following cleaning operations before requesting inspection for certification of Substantial Completion for entire Project or for a designated portion of Project:
    - a. Clean Project site, yard, and grounds, in areas disturbed by construction activities, including landscape development areas, of rubbish, waste material, litter, and other foreign substances.
    - b. Sweep paved areas broom clean. Remove petrochemical spills, stains, and other foreign deposits.
    - c. Rake grounds that are neither planted nor paved to a smooth, even-textured surface.
    - d. Remove tools, construction equipment, machinery, and surplus material from Project site.



- e. Clean exposed exterior surfaced finishes to a dirt-free condition, free of stains, films, and similar foreign substances. Avoid disturbing natural weathering of exterior surfaces. Restore reflective surfaces to their original condition.
  - f. Remove debris and surface dust from limited access spaces, including roofs, plenums, attics, and similar spaces.
  - g. Clean transparent materials, including glass in doors and windows. Remove glazing compounds and other noticeable, vision-obscuring materials taking care not to scratch surfaces.
  - h. Remove labels that are not permanent.
  - i. Wipe surfaces of mechanical and electrical equipment and similar equipment. Remove excess lubrication, paint and mortar droppings, and other foreign substances.
- C. Construction Waste Disposal: Comply with waste disposal requirements in Section 015000 "Temporary Facilities and Controls."

### 3.2 REPAIR OF THE WORK

- A. Complete repair and restoration operations before requesting inspection for determination of Substantial Completion.
- B. Repair or remove and replace defective construction. Repairing includes replacing defective parts, refinishing damaged surfaces, touching up with matching materials, and properly adjusting operating equipment. Where damaged or worn items cannot be repaired or restored, provide replacements. Remove and replace operating components that cannot be repaired. Restore damaged construction and permanent facilities used during construction to specified condition.

### 3.3 PROJECT CLOSE-OUT DOCUMENTS

- A. All close-out documents listed below are to be provided upon completion of the project. Documents are to be separated with tab sheets and provided bound with a multi-ring binder with hard covers. All project information is to be listed on the front cover and the spine of the binder.
- B. A complete, combined digital copy is also to be provided with all close-out documents combined with separator sheets identifying each of the following items.
  - 1. Affidavit of Payment of Debts and Claims.
  - 2. Affidavit of Payment of Release of Liens.
  - 3. Consent of Surety to Final Payment.
  - 4. Certificate of Substantial Completion.
  - 5. Copy of WMBE Punchlist (Each item initialed as competed).

6. Certificate of Final Completion.
7. Contractor's Warranty dated the Substantial Completion date or later.
8. Manufacturer's Warranty dated the Substantial Completion date or later.
9. Asbestos Free Warranty
10. List of all materials used per specification section.
11. Copy of all Applications for Payment including Final
12. Copy of all change orders with attachments including Final.
13. Copy of all field observation reports
14. Project As-Built Drawings (See Section 017839, Project Record Documents)

END OF SECTION 017700

## SECTION 017839 - PROJECT RECORD DOCUMENTS

### PART 1 - GENERAL

#### 1.1 RELATED DOCUMENTS

- A. Drawings and general provisions of the Contract, including General and Supplementary Conditions and other Division 01 Specification Sections, apply to this Section.

#### 1.2 SUMMARY

- A. Section includes administrative and procedural requirements for project record documents, including the following:
  - 1. Record Drawings.
  - 2. Record Product Data.
  - 3. Miscellaneous record submittals.
- B. Related Requirements:
  - 1. Section 017300 "Execution".
  - 2. Section 017700 "Closeout Procedures".

#### 1.3 CLOSEOUT SUBMITTALS

- A. Record Drawings: Comply with the following:
  - 1. Submit three paper-copy sets of marked-up record prints.
  - 2. Submit PDF electronic files of scanned record prints.
- B. Miscellaneous Record Submittals: See other Specification Sections for miscellaneous record-keeping requirements and submittals in connection with various construction activities.
- C. Reports: Submit written report indicating items incorporated into project record documents concurrent with progress of the Work, including revisions, concealed conditions, field changes, product selections, and other notations incorporated.

### PART 2 - PRODUCTS

#### 2.1 RECORD DRAWINGS

- A. Record Prints: Maintain one set of marked-up paper copies of the Contract Drawings and Shop Drawings, incorporating new and revised drawings as modifications are issued.
  - 1. Content: Types of items requiring marking include, but are not limited to, the following:

- a. Revisions to details shown on Drawings.
  - b. Changes made by Change Order.
  - c. Details not on the original Contract Drawings.
  - d. Field records for concealed conditions.
2. Mark the Contract Drawings and Shop Drawings completely and accurately.
  3. Mark record sets with red-colored pen or pencil. Use other colors to distinguish between changes for different categories of the Work at same location.
  4. Mark important additional information that was either shown schematically or omitted from original Drawings.
- B. Record Digital Data Files: Immediately before inspection for Certificate of Substantial Completion, review marked-up record prints with Consultant.
- C. Newly Prepared Record Drawings: Prepare new Drawings instead of preparing record Drawings where Consultant determines that neither the original Contract Drawings nor Shop Drawings are suitable to show actual installation.
1. New Drawings may be required when a Change Order is issued as a result of accepting an alternate, substitution, or other modification.

## 2.2 MISCELLANEOUS RECORD SUBMITTALS

- A. Assemble miscellaneous records required by other Specification Sections for miscellaneous record keeping and submittal in connection with actual performance of the Work. Bind or file miscellaneous records and identify each, ready for continued use and reference.
- B. Format: Submit miscellaneous record submittals as PDF electronic file.
1. Include miscellaneous record submittals directory organized by Specification Section number and title, electronically linked to each item of miscellaneous record submittals.

## PART 3 - EXECUTION

### 3.1 RECORDING AND MAINTENANCE

- A. Recording: Maintain one copy of each submittal during the construction period for project record document purposes. Post changes and revisions to project record documents as they occur; do not wait until end of Project.

END OF SECTION 017839

## SECTION 024119 - SELECTIVE DEMOLITION

### PART 1 - GENERAL

#### 1.1 RELATED DOCUMENTS

- A. Drawings and general provisions of the contract, including the General and Supplemental Conditions, as well as other Division 01 Specification Sections, apply to this section.

#### 1.2 SUMMARY

- A. Section Includes:

1. Demolition and removal of existing material / components as required to complete the following.
  - a. Base Bid scope of work includes miscellaneous selective roof repairs of the low slope roof areas at multiple schools as designated on the drawings. All new sheet metal items associated with the installation of the new repair work are required.
  - b. Alternate No. 1 scope of work includes roof membrane repair work on Roof Areas U, U1, U2 and V. All other requirements remain unchanged.
2. Removal of all existing sheet metal and all associated components are to be replaced with new where repair work is taking place.
3. Demolition of existing roof membrane, base flashings, penetration flashings, and roof drains and replacement with new. Minor demolition of the existing roof deck and any damaged / wet insulation as required for the installation of roof drains to be replaced. Insulation thickness to match existing.
4. Proper temporary protection of the interior is required at all times during construction. Temporary protection may be required to be removed, both full and in part, to allow Owner temporary use.

#### 1.3 DEFINITIONS

- A. Remove: Detach items from existing construction and legally dispose of them off-site unless indicated to be removed and salvaged or removed and reinstalled.
- B. Remove and Reinstall: Detach items from existing construction, prepare for reuse, and reinstall where indicated.
- C. Existing to Remain: Existing items of construction that are not to be permanently removed and that are not otherwise indicated to be removed, removed and salvaged, or removed and reinstalled.

1.4 INFORMATIONAL SUBMITTALS

- A. Qualification Data: For refrigerant recovery technician.
- B. Predemolition Photographs or Video: Submit before Work begins.

1.5 FIELD CONDITIONS

- A. Owner will occupy portions of building immediately under and adjacent to selective demolition area. Conduct selective demolition so Owner's operations will not be disrupted.
- B. Conditions existing at time of inspection for bidding purpose will be maintained by Owner as far as practical.
- C. Notify Consultant of discrepancies between existing conditions and Drawings before proceeding with selective demolition.
- D. If any suspected hazardous materials are encountered, do not disturb; immediately notify Consultant and Owner. Hazardous materials will be removed by Owner under a separate contract.
- E. Storage or sale of removed items or materials on-site is not permitted.
- F. Utility Service: Maintain existing utilities indicated to remain in service and protect them against damage during selective demolition operations.
  - 1. Maintain fire-protection facilities in service during selective demolition operations.

PART 2 - PRODUCTS

2.1 PERFORMANCE REQUIREMENTS

- A. Regulatory Requirements: Comply with governing EPA notification regulations before beginning selective demolition. Comply with hauling and disposal regulations of authorities having jurisdiction.
- B. Standards: Comply with ANSI/ASSE A10.6 and NFPA 241.

PART 3 - EXECUTION

3.1 EXAMINATION

- A. Verify that utilities have been disconnected and capped before starting selective demolition operations.
- B. Survey existing conditions and correlate with requirements indicated to determine extent of selective demolition required.

- C. When unanticipated mechanical, electrical, or structural elements that conflict with intended function or design are encountered, investigate and measure the nature and extent of conflict. Promptly submit a written report to Consultant.
- D. Engage a professional engineer (if any structural element will be modified, removed, and/or addressed) to perform an engineering survey of condition of building to determine whether removing any element might result in structural deficiency or unplanned collapse of any portion of structure or adjacent structures during selective building demolition operations.
- E. Survey of Existing Conditions: Record existing conditions by use of preconstruction photographs

### 3.2 UTILITY SERVICES AND MECHANICAL/ELECTRICAL SYSTEMS

- A. Existing Services/Systems to Remain: Maintain services/systems indicated to remain and protect them against damage.
  - 1. Comply with requirements for existing services/systems interruptions specified in Section 011000 "Summary."

### 3.3 PREPARATION

- A. Site Access and Temporary Controls: Conduct selective demolition and debris-removal operations to ensure minimum interference with roads, streets, walks, walkways, and other adjacent occupied and used facilities.
- B. Temporary Facilities: Provide temporary barricades and other protection required to prevent injury to people and damage to adjacent buildings and facilities to remain.
- C. Temporary Shoring: Provide and maintain shoring, bracing, and structural supports as required to preserve stability and prevent movement, settlement, or collapse of construction and finishes to remain, and to prevent unexpected or uncontrolled movement or collapse of construction being demolished.

### 3.4 SELECTIVE DEMOLITION, GENERAL

- A. General: Demolish and remove existing roof system only to the extent required by new roof system and as indicated. Use methods required to complete the Work within limitations of governing regulations and as follows:
  - 1. Neatly cut roof system in straight lines taking in account tie in locations in relation to existing water flow. Use cutting methods least likely to damage construction to remain or adjoining construction. Use hand tools or small power tools designed for sawing or grinding, not hammering and chopping, to minimize disturbance of adjacent surfaces. Temporarily cover openings to remain. Do not cut roof system creating a back lap for sheeting water to drain.
  - 2. Cut or drill from the exposed or finished side into concealed surfaces to avoid marring existing finished surfaces.

3. Remove all existing fasteners utilizing mechanical drills.
4. Do not use cutting torches until work area is cleared of flammable materials. At concealed spaces, such as duct and pipe interiors, verify condition and contents of hidden space before starting flame-cutting operations.
5. Maintain fire watch and portable fire-suppression devices. Fire watch shall be a minimum of 2 hours.
6. Locate selective demolition equipment and remove debris and materials so as not to impose excessive loads on supporting walls, floors, or framing.
7. Remove all demolished items from roof in a manner to not damage exterior of facility and select locations determined by Owner.

B. Removed and Reinstalled Items:

1. Clean and repair items to functional condition adequate for intended reuse.
2. Pack or crate items after cleaning and repairing. Identify contents of containers.
3. Protect items from damage during transport and storage.
4. Reinstall items in locations indicated. Comply with installation requirements for new materials and equipment. Provide connections, supports, and miscellaneous materials necessary to make item functional for use indicated.

C. Existing Items to Remain: Protect construction indicated to remain against damage and soiling during selective demolition. When permitted by Consultant, items may be removed to a suitable, protected storage location during selective demolition and cleaned and reinstalled in their original locations after selective demolition operations are complete.

### 3.5 DISPOSAL OF DEMOLISHED MATERIALS

A. General: Except for items or materials indicated to be recycled, reused, salvaged, reinstalled, or otherwise indicated to remain Owner's property, remove demolished materials from Project site and legally dispose of them in an approved landfill.

1. Do not allow demolished materials to accumulate on-site.
2. Remove and transport debris in a manner that will prevent spillage on adjacent surfaces and areas.
3. Remove debris from elevated portions of building by chute, hoist, or other device that will convey debris to grade level in a controlled descent.

B. Burning: Do not burn demolished materials.

C. Disposal: Transport demolished materials off Owner's property and legally dispose of them.



3.6 CLEANING

- A. Clean adjacent structures and improvements of dust, dirt, and debris caused by selective demolition operations. Return adjacent areas to condition existing before selective demolition operations began.

END OF SECTION 024119

## SECTION 075215 - ROOF MEMBRANE REPAIRS

### PART 1 - GENERAL

#### 1.1 RELATED DOCUMENTS

- A. Drawings and general provisions of the contract, including the General and Special Conditions, as well as other Division 01 Specification Sections, apply to this section.

#### 1.2 SUMMARY

- A. Section Includes:

1. Base Bid scope of work includes miscellaneous selective roof repairs of the low slope roof areas at multiple schools as designated on the drawings. The repair items are listed below and are to be included in the base bid.
  - a. Roof Membrane Repair – 100 SF
  - b. Base Flashing Repair – 20 LF
  - c. Roof Drain Replacement – 4 EA
  - d. Roof Drain Repair – 8 EA
  - e. VTR Repair – 4 EA
  - f. Pitch Pan Repair – None are currently in base bid. Per unit price required for this item.
  - g. Clean all existing roof areas and drainage locations free of debris
2. Sheet metal flashings and associated components as shown in the contract drawing details shall be provided. Sheet metal shall be compatible with the material of that in which it is being applied to. If dissimilar conditions exist, separation is required.
3. Alternate No. 1 scope of work includes removing aggregate from the roof membrane on Roof Areas U, U1, U2 and V, preparation of the membrane and installation of a two-ply modified bitumen roof membrane. All other Contract Document requirements apply.

#### 1.3 DEFINITIONS

- A. Roofing Terminology: Definitions in ASTM D 1079 and glossary of NRCA's "The NRCA Roofing and Waterproofing Manual" apply to work of this Section.

#### 1.4 PREINSTALLATION MEETINGS

- A. Pre-installation Roofing Conference: Conduct conference at Project Site. Mandatory attendance for roofing contractor, material manufacturer's technical representative, all subcontractors, project manager, and project foreman.

1.5 ACTION SUBMITTALS

- A. Product Data: For each type of product.
- B. Shop Drawings: For roofing system. Include plans, sections, details, and attachments to other work, including:

1.6 INFORMATIONAL SUBMITTALS

- A. Research/Evaluation Reports: For components of membrane roofing system, from ICC-ES.
- B. Contractor's Three-year workmanship warranty.

1.7 CLOSEOUT SUBMITTALS

- A. Maintenance Data: For roofing system to include in maintenance manuals.

1.8 QUALITY ASSURANCE

- A. Installer Qualifications: A qualified firm that is approved, authorized, or licensed by roofing system manufacturer to install manufacturer's product and as required to ensure that the manufacturer's warranty is not voided by the work.
- B. A copy of the latest manufacturer's product data and installation guide shall be kept on the roof at all times during installation.

1.9 MATERIAL STORAGE

- A. All materials shall be properly stored in accordance with industry standards and the manufacturer's guidelines.
  - 1. Use good tarps, free of holes and tears. Secure properly.
  - 2. Store roll goods on end on pallets. Salvage edge shall be up.
  - 3. Cover insulation with tarps. Do NOT rely on the manufacturer's plastic wrapping.
  - 4. Store all materials in a manner to prevent condensation.
  - 5. Do not overload the roof. Limit the amount of materials stored on the roof to the next day's operation at a maximum.

1.10 WARRANTY

- A. Contractor's warranty period: Three years from the date of Substantial Completion.

PART 2 - PRODUCTS

2.1 MANUFACTURERS

- A. Obtain components including roof insulation, fasteners, base sheet, interply membrane, cap sheet, adhesives, flashing plies, temporary waterproofing membrane, and sealants all repair materials that shall be approved for use by the Consultant.

2.2 PERFORMANCE REQUIREMENTS

- A. FM Global Listing: Roofing, base flashings, and component materials shall comply with requirements in FM Global 4450 or FM Global 4470 as part of a roofing system, and shall be listed in FM Global's "RoofNav" for Class 1 or noncombustible construction, as applicable. Identify materials with FM Global markings.
- B. Fire-Resistance Ratings: Comply with fire-resistance-rated assembly designs indicated. Identify products with appropriate markings of applicable testing agency.

2.3 ROOFING SHEET MATERIALS

- A. Roofing Membrane Base Sheet: ASTM D 6163, Grade S, Type I, SBS-modified asphalt sheet (reinforced with glass fibers) smooth surfaced; suitable for application method specified.

- 1. Modified Base Ply, Stripping Ply, and Flashing Reinforcement Sheet shall meet the following:

- a. Thickness (avg.): 91 mils with a minimum of 87 mils
- b. Weight (avg per square): 60 lbs.
- c. Elastomeric Blend filler content: Less than 35% by weight
- d. Low temperature flexibility @ 13F: Pass ASTM D 5147
- e. Breaking Load @ 73F: 30 lbf/inch
- f. Breaking Load @ 0F: 70 lbf/inch
- g. Ultimate Elongation @ 73F: 50%
- h. Dimensional Stability: 0.5%
- i. Compound Stability: 250F
- j. UL Listed, FM Approved. Products shall bear seals of approval

- B. Granule-Surfaced Roofing Cap Sheet: ASTM D 6162, Grade G, Type I, SBS-modified asphalt sheet; granule surfaced; suitable for application method specified, and as follows:

- 1. Modified Bitumen Finish Ply shall meet the following:

- a. Thickness (avg.): 130 mils
- b. Weight (avg per square): 90 lbs.
- c. Elastomeric Blend filler content: Less than 35% by weight
- d. Low temperature flexibility @ -13F: Pass ASTM D 5147
- e. Breaking Load @ 73F: 30 lbf/inch
- f. Breaking Load @ 0F: 70 lbf/inch

- g. Ultimate Elongation @ 73F: 55%
- h. Dimensional Stability: 0.5%
- i. Compound Stability: 250F
- j. UL Listed, FM Approved. Products shall bear seals of approval
- k. Granule embedment: 1.5 grams per sample

#### 2.4 BASE FLASHING SHEET MATERIALS

- A. Same materials as installed in roof system unless Roof Manufacturer's requirements require differing sheets to be provided for the base flashing (ie. Polyester base flashing cap sheet ply).
  - 1. Installation in strict accordance with the manufacturer's written installation instructions.

#### 2.5 AUXILIARY ROOFING MATERIALS

- A. General: Auxiliary materials recommended by roofing system manufacturer for intended use and compatible with roofing.
  - 1. Liquid-type auxiliary materials shall comply with VOC limits of authorities having jurisdiction.
- B. Liquid Applied Flashing: Manufacturer's recommended liquid applied flashing with reinforcement.
- C. Asphalt Primer: ASTM D 41/D 41M.
- D. Cold-Applied Adhesive: Roofing system manufacturer's standard asphalt-based, one- or two-part, asbestos-free, cold-applied adhesive specially formulated for compatibility and use with roofing membrane and base flashings.
- E. Asphalt Roofing Cement: ASTM D 4586, asbestos free, of consistency required by roofing system manufacturer for application.
- F. Fasteners (if applicable): Factory-coated steel fasteners and metal or plastic plates complying with corrosion-resistance provisions in FM Global 4470, designed for fastening roofing components to substrate; tested by manufacturer for required pullout strength, and acceptable to roofing system manufacturer.
- G. Roofing Granules: Ceramic-coated roofing granules, No. 11 screen size with 100 percent passing No. 8 sieve and 98 percent of mass retained on No. 40 sieve, color to match roofing.

#### 2.6 ROOF INSULATION

- A. If needed, roof insulation system shall match that of existing in type and thickness.
- B. Polyisocyanurate Board Insulation: ASTM C 1289, Type II, Class 1, Grade 2 felt or glass-fiber mat facer on both major surfaces.

- C. Tapered Insulation: Provide factory-tapered insulation boards fabricated to slope of 1/4 inch per 12 inches at the crickets.
- D. Perlite Board Insulation: ASTM C 728, Type I.
- E. If any other conditions exist, adhere to the requirements of the manufacturer.

## PART 3 - EXECUTION

### 3.1 INSTALLATION, GENERAL

- A. Comply with roofing system manufacturer's written instructions.
- B. If any clarifications are needed, please refer to NRCA Low Slope Roof Repair Manual.

### 3.2 ROOFING INSTALLATION

- A. Install roofing system according to roofing manufacturer's written instructions and applicable recommendations in ARMA/NRCA's "Quality Control Guidelines for the Application of Polymer Modified Bitumen Roofing".

### 3.3 ROOF DRAIN REPAIR

- A. Down to existing base sheet
  1. Remove the drain clamping ring. Provide existing bolts back into holes until flashing is completed.
  2. Cutback and remove the existing membrane flashing.
  3. Remove the existing lead sheet.
  4. Set a new sheet lead, 30"x30" - 4 pounds per square foot, in compatible roof cement and carefully conform it into drain bowl with a rubber mallet.
  5. Apply a thin, continuous film of asphalt primer to the surfaces and allow to dry.
  6. Flash modified bitumen base sheet, extending 6 inches onto adjacent roofing membrane and flashing (by torch or cold adhesive). If cold adhesive is utilized, heat welding all side and end laps are required.
  7. Flash modified bitumen cap sheet, extending 6 beyond the base sheet previously installed. It shall be adhered utilizing torch or cold adhesive. If cold adhesive is utilized, heat welding all side and end laps are required.
  8. Apply moderate pressure to the patch to assure adhesion to the existing flashing. Warm the surface of the membrane uniformly to aid in forming a completion seal when the clamping ring is installed.

9. Provide a cast iron clamping ring, provide stainless steel bolts and provide cast iron strainer.

### 3.4 BASE FLASHING REPLACEMENT/REPAIR

#### A. Base Flashing Replacement:

1. Remove existing counterflashing or coping as necessary to access the top of the base flashing.
2. Cut out flashing materials that are unadhered until reaching adhered material.
3. Inspect the flashing for possible moisture infiltration.
4. If moisture infiltration is suspected, cut open the flashing and inspect the underlaying interplies and substrate. Replace any wet or damaged materials. Notify WM immediately if moisture is discovered in any location where not indicated on plans.
5. To promote thorough adhesion of a patch, it is essential to begin by preparing the surface. Remove debris, contaminants, surfacing from the surface of the membrane flashing to be repaired. The area to be prepared should extend beyond the perimeter of the patch to provide an ample clean work area on which to install the patch.
6. Clean the surface of the membrane.
7. Prime the surface of the membrane asphalt primer and allow to dry. Primer contains solvents and is used to enhance adhesion; however, overuse of primer can harm the membrane.
8. Cut a patch of like material 8 inches larger in all dimension than the location to be prepared. Round the corners of the patch to prevent peeling of square corners. If corners of the base flashing are included, flash the corners in accordance with Manufactures printed instructions.
9. Install the patch in cold adhesive or by torch extending approximately 8 inches beyond in all directions. When torching, work gradually, applying heat only sufficient to achieve adhesion without damaging the membrane reinforcement or scorching surrounding membrane.
10. Apply moderate pressure to the patch to assure adhesion to the existing membrane.
11. Attach the new base flashing at the top minimum 8" O.C. 3 course the top lap of the base flashing over the fasteners.
12. Reinstall the counterflashing or coping with new fasteners.

#### B. Base Flashing Repair:

1. Remove existing counterflashing or coping as necessary to access the top of the base flashing.

2. Cut out flashing materials that are unadhered until reaching adhered material.
3. Inspect the flashing for possible moisture infiltration.
4. If moisture infiltration is suspected, cut open the flashing and inspect the underlaying inter-plies and substrate. Replace any wet or damaged materials. Notify WM immediately if moisture is discovered in any location where not indicated on plans.
5. To promote thorough adhesion of a patch, it is essential to begin by preparing the surface. Remove debris, contaminants, surfacing from the surface of the membrane flashing to be repaired. The area to be prepared should extend beyond the perimeter of the patch to provide an ample clean work area on which to install the patch.
6. Clean the surface of the membrane.
7. Prime the surface of the membrane asphalt primer and allow to dry. Primer contains solvents and is used to enhance adhesion; however, overuse of primer can harm the membrane.
8. Cut a patch of like material 8 inches larger in all dimension than the location to be prepared. Round the corners of the patch to prevent peeling of square corners. If corners of the base flashing are included, flash the corners in accordance with Manufactures printed instructions.
9. Install the patch (cap sheet) in cold adhesive or by torch extending approximately 8 inches beyond in all directions. When torching, work gradually, applying heat only sufficient to achieve adhesion without damaging the membrane reinforcement or scorching surrounding membrane.
10. Apply moderate pressure to the patch to assure adhesion to the existing membrane.
11. Reinstall the counterflashing or coping with new fasteners.

### 3.5 ROOF MEMBRANE REPAIR

#### A. Repair:

1. Carefully cut back the membrane until good adhesion is reached.
2. Inspect the membrane for possible moisture infiltration.
3. If moisture infiltration is suspected, cut open the flashing and inspect the underlaying inter-plies and substrate. Replace any wet or damaged materials. Notify WM immediately if moisture is discovered in any location where not indicated on plans.
4. To promote thorough adhesion of a patch, it is essential to begin by preparing the surface. Remove debris, contaminants, surfacing from the surface of the membrane flashing to be repaired. The area to be prepared should extend beyond the perimeter of the patch to provide an ample clean work area on which to install the patch.



5. Clean the surface of the membrane.
6. Prime the surface of the membrane asphalt primer and allow to dry. Primer contains solvents and is used to enhance adhesion; however, overuse of primer can harm the membrane.
7. Cut a patch of like material 8 inches larger in all dimension than the location to be prepared. Round the corners of the patch to prevent peeling of square corners. If corners of the base flashing are included, flash the corners in accordance with Manufactures printed instructions.
8. Install the patch (cap sheet) in cold adhesive or by torch extending approximately 8 inches beyond in all directions. When torching, work gradually, applying heat only sufficient to achieve adhesion without damaging the membrane reinforcement or scorching surrounding membrane.
9. Apply moderate pressure to the patch to assure adhesion to the existing membrane.
10. Extend flashing up walls or parapets a minimum of 8 inches above roofing membrane and 6 inches onto field of roofing membrane.
11. Mechanically fasten top of flashing system securely at terminations and perimeter of roofing a minimum of 8" on center using appropriate fasteners for substrate material. Use washers where necessary.

### 3.6 ROOF MEMBRANE OVARLAY

- A. Install all roof membrane repairs using the materials below in accordance with the NRCA Low Sloped Roof Repair Manual or as recommended by the roof system manufacturer.
- B. Remove all existing aggregate from surface of the existing roof membrane.
- C. Clean and prime exposed roof membrane as required to receive new two ply modified bitumen roof membrane.
- D. Modified Bitumen Base Sheet Installation:
  1. Roll out sheet and allow to relax as per manufacturer's instructions.
  2. Starting at low points and working upward, embed in manufacturer's recommended adhesive at the rate of 1.5 gallons per 100 square feet. Use notched squeegees and ensure a solid bed of adhesive free of lumps and excess.
  3. Roll membrane into adhesive free of voids, fish mouths, mole runs, etc. Ensure solid embedment of membrane.
  4. Run modified bitumen base sheet up and over the top of cant. Seal to penetrations.
  5. Lap side laps a minimum of 3" an end laps a minimum of 6". Stagger end laps at least 24". Install modified bitumen base sheet so that the laps do not line up with joints in insulation.

6. Seal all laps and verify solid lap adhesion at the end of each working day. Make repairs as necessary to ensure a watertight assembly.

E. Modified Bitumen Cap Sheet Installation:

1. Clean base sheet of any dust, moisture, and debris.
2. Roll out the modified bitumen cap sheet and allow to relax as per manufacturer's instructions.
3. Starting at low points and working upward, embed modified bitumen cap sheet in manufacturer's recommended adhesive at the rate of 1.5 gallons per 100 square feet. Use notched squeegees and ensure a solid bed of adhesive free of lumps and excess.
4. Roll membrane into adhesive free of voids, fish mouths, mole runs, etc. Ensure solid embedment of membrane.
5. Lap side laps a minimum of 3" and end laps a minimum of 6". Stagger end laps at ½ of roll length where available but no more than 30" together. Install modified bitumen cap sheet so that the laps do not line up with the laps of the modified bitumen base sheet.
6. Stagger laps in drain/valley areas to prevent "backwards" laps.
7. Seal all laps and verify solid lap adhesion at the end of each working day. Make repairs as necessary to ensure a watertight assembly.
8. Check lap integrity each day and repair any loose areas. Embed granules where necessary to dress up finished roof assembly.

3.7 WARRANTY:

- A. Provide three-year contractor's workmanship warranty.

3.8 CLOSE-OUTS:

- A. Clean finished roof of all materials, equipment, debris, markings, etc.

END OF SECTION 075215

## SECTION 076200 - SHEET METAL FLASHING AND TRIM

### PART 1 - GENERAL

#### 1.1 RELATED DOCUMENTS

- A. Drawings and general provisions of the Contract, including General and Supplementary Conditions and Division 01 Specification Sections, apply to this Section.

#### 1.2 SUMMARY

- A. Section Includes:

- 1. Sheet Metal Components to be provided are as follows:
  - a. Penetration flashings
  - b. Roof Drains
  - c. Umbrellas
  - d. Raised metal edge (Alternate No.1)
  - e. Other Sheet Metal Components

- B. Related Requirements:

- 1. Section 024119 "Selective Demolition".
- 2. Section 075215 "Roof Membrane Repairs".

#### 1.3 COORDINATION

- A. Coordinate sheet metal flashing and trim layout and seams with sizes and locations of penetrations to be flashed, and joints and seams in adjacent materials.
- B. Coordinate sheet metal flashing and trim installation with adjoining roofing and wall materials, joints, and seams to provide leak-proof, secure, and noncorrosive installation.

#### 1.4 ACTION SUBMITTALS

- A. Product Data: For each type of product.

- 1. Include construction details, material descriptions, dimensions of individual components and profiles, and finishes for each manufactured product and accessory.

- B. Shop Drawings: For sheet metal flashing and trim.
  - 1. Include identification of material, thickness, weight, and finish for each item and location in Project.
- C. Samples for Initial Selection: For each type of sheet metal and accessory indicated with factory-applied finishes.
- D. Samples for Verification: For each type of exposed finish.

#### 1.5 INFORMATIONAL SUBMITTALS

- A. Qualification Data: For fabricator.
- B. Product Certificates: For each type of coping and roof edge flashing that is SPRI ES-1 tested to withstand minimum wind uplift requirements.
- C. Sample Warranty: For special warranty.

#### 1.6 CLOSEOUT SUBMITTALS

- A. Maintenance Data: For sheet metal flashing and trim, and its accessories, to include in maintenance manuals.

#### 1.7 QUALITY ASSURANCE

- A. Fabricator Qualifications: Employs skilled workers who custom fabricate sheet metal flashing and trim similar to that required for this Project and whose products have a record of successful in-service performance.

#### 1.8 DELIVERY, STORAGE, AND HANDLING

- A. Do not store sheet metal flashing and trim materials in contact with other materials that might cause staining, denting, or other surface damage. Store sheet metal flashing and trim materials away from uncured concrete and masonry.
- B. Protect strippable protective covering on sheet metal flashing and trim from exposure to sunlight and high humidity, except to extent necessary for period of sheet metal flashing and trim installation.

#### 1.9 WARRANTY

- A. Special Warranty on Finishes: Manufacturer agrees to repair finish or replace sheet metal flashing and trim that shows evidence of deterioration of factory-applied finishes within specified warranty period.
  - 1. Exposed Finish: Deterioration includes, but is not limited to, the following:

- a. Color fading more than 5 Hunter units when tested according to ASTM D 2244.
  - b. Chalking in excess of a No. 8 rating when tested according to ASTM D 4214.
  - c. Cracking, checking, peeling, or failure of paint to adhere to bare metal.
2. Finish Warranty Period: 20 years from date of Substantial Completion.

## PART 2 - PRODUCTS

### 2.1 PERFORMANCE REQUIREMENTS

- A. General: Sheet metal flashing and trim assemblies shall withstand wind loads, structural movement, thermally induced movement, and exposure to weather without failure due to defective manufacture, fabrication, installation, or other defects in construction. Completed sheet metal flashing and trim shall not rattle, leak, or loosen, and shall remain watertight.
- B. Sheet Metal Standard for Flashing and Trim: Comply with NRCA's "The NRCA Roofing Manual" and SMACNA's "Architectural Sheet Metal Manual" requirements for dimensions and profiles shown unless more stringent requirements are indicated.
- C. SPRI Wind Design Standard: Manufacture and install roof edge flashings and copings tested according to SPRI ES-1 and capable of resisting the following design pressure:
- D. Thermal Movements: Allow for thermal movements from ambient and surface temperature changes to prevent buckling, opening of joints, overstressing of components, failure of joint sealants, failure of connections, and other detrimental effects. Base calculations on surface temperatures of materials due to both solar heat gain and nighttime-sky heat loss.

### 2.2 SHEET METALS

- A. General: Protect mechanical and other finishes on exposed surfaces from damage by applying strippable, temporary protective film before shipping.
- B. Aluminum Sheet: ASTM B 209, alloy as standard with manufacturer for finish required, with temper as required to suit forming operations and performance required; with smooth, flat surface. Minimum Thickness 0.040 inches.
  1. Exposed Coil-Coated Finish:
    - a. Two-Coat Fluoropolymer: AAMA 620. Fluoropolymer finish containing not less than 70 percent PVDF resin by weight in color coat. Prepare, pretreat, and apply coating to exposed metal surfaces to comply with coating and resin manufacturers' written instructions.
  2. Color: As selected by Owner from manufacturer's full range.

3. Concealed Finish: Pretreat with manufacturer's standard white or light-colored acrylic or polyester backer finish, consisting of prime coat and wash coat with minimum total dry film thickness of 0.5 mil.
- C. Metallic-Coated Steel Sheet: Provide aluminum-zinc alloy-coated steel (galvalume) sheet according to ASTM A 792/A 792M, Class AZ50 coating designation, prepainted by coil-coating process to comply with ASTM A 755/A 755M.
1. Surface: Smooth, flat and with manufacturer's standard clear acrylic coating on both sides.
  2. Exposed Coil-Coated Finish:
    - a. Two-Coat Fluoropolymer: AAMA 621. Fluoropolymer finish containing not less than 70 percent PVDF resin by weight in color coat. Prepare, pretreat, and apply coating to exposed metal surfaces to comply with coating and resin manufacturers' written instructions.
  3. Color: As selected by Owner from manufacturer's full range.
  4. Concealed Finish: Pretreat with manufacturer's standard white or light-colored acrylic or polyester backer finish, consisting of prime coat and wash coat with minimum total dry film thickness of 0.5 mil.
- D. Stainless-Steel Sheet: ASTM A 240/A 240M **or** ASTM A 666, Type 304, dead soft, fully annealed; with smooth, flat surface. Minimum Thickness 24 gauge.
- E. Lead Flashing: Minimum 4.0 lb./sf., ASTM B749-03 & QQ-L-201f, Grade C.

## 2.3 UNDERLAYMENT MATERIALS

- A. Self-Adhering, High-Temperature Sheet: Minimum 40 mils thick, consisting of a slip-resistant polyethylene- or polypropylene-film top surface laminated to a layer of butyl- or SBS-modified asphalt adhesive, with release-paper backing; specifically designed to withstand high metal temperatures beneath metal roofing. Provide primer according to written recommendations of underlayment manufacturer.
1. Thermal Stability: ASTM D 1970; stable after testing at 240 deg F or higher.
  2. Low-Temperature Flexibility: ASTM D 1970; passes after testing at minus 20 deg F or lower.
  3. Slip Sheet: Rosin-sized building paper, 3 lb/100 sq. ft. minimum.

## 2.4 MISCELLANEOUS MATERIALS

- A. General: Provide materials and types of fasteners, solder, protective coatings, sealants, and other miscellaneous items as required for complete sheet metal flashing and trim installation and as recommended by manufacturer of primary sheet metal unless otherwise indicated.

- B. Fasteners: Wood screws, annular threaded nails, self-tapping screws, self-locking rivets and bolts, and other suitable fasteners designed to withstand design loads and recommended by manufacturer of primary sheet metal.
  - 1. General: Blind fasteners or self-drilling screws, gasketed, with hex-washer head.
    - a. Exposed Fasteners: Heads matching color of sheet metal using plastic caps or factory-applied coating. Provide metal-backed EPDM or PVC sealing washers under heads of exposed fasteners bearing on weather side of metal.
    - b. Blind Fasteners: High-strength aluminum or stainless-steel rivets suitable for metal being fastened.
  - 2. Fasteners for Aluminum Sheet: Aluminum or Series 300 stainless steel.
  - 3. Fasteners for Stainless-Steel Sheet: Series 300 stainless steel.
- C. Sealant Tape: Pressure-sensitive, 100 percent solids, polyisobutylene compound sealant tape with release-paper backing. Provide permanently elastic, nonsag, nontoxic, nonstaining tape 1/2 inch wide and 1/8 inch thick.
- D. Elastomeric Sealant: ASTM C 920, elastomeric polyurethane polymer sealant; of type, grade, class, and use classifications required to seal joints in sheet metal flashing and trim and remain watertight.
- E. Butyl Sealant: ASTM C 1311, single-component, solvent-release butyl rubber sealant; polyisobutylene plasticized; heavy bodied for hooked-type expansion joints with limited movement.

## 2.5 FABRICATION, GENERAL

- A. General: Custom fabricate sheet metal flashing and trim to comply with details shown and recommendations in cited sheet metal standard that apply to design, dimensions, geometry, metal thickness, and other characteristics of item required. Fabricate sheet metal flashing and trim in shop to greatest extent possible.
  - 1. Obtain field measurements for accurate fit before shop fabrication.
  - 2. Form sheet metal flashing and trim to fit substrates without excessive oil canning, buckling, and tool marks; true to line, levels, and slopes; and with exposed edges folded back to form hems.
  - 3. Conceal fasteners and expansion provisions where possible. Do not use exposed fasteners on faces exposed to view.
- B. Expansion Provisions: Form metal for thermal expansion of exposed flashing and trim.
  - 1. Form expansion joints of intermeshing hooked flanges, not less than 1 inch deep, filled with butyl sealant concealed within joints.
  - 2. Use lapped joints unless otherwise indicated.

- C. Sealant Joints: Where movable, non-expansion-type joints are required, form metal to provide for proper installation of elastomeric sealant according to cited sheet metal standard.
- D. Fabricate cleats and attachment devices from same material as accessory being anchored or from compatible, noncorrosive metal. Cleats shall be 1 gauge/increment thicker than sheet metal used.
- E. Fabricate cleats and attachment devices of sizes as recommended by cited sheet metal standard for application, but not less than thickness of metal being secured.
- F. Seams: Fabricate nonmoving seams with flat-lock seams.
- G. Seams: Fabricate nonmoving seams with flat-lock seams. Form seams and seal with elastomeric sealant unless otherwise recommended by sealant manufacturer for intended use. Rivet joints where necessary for strength.
- H. Seams for Aluminum: Fabricate nonmoving seams with flat-lock seams. Form seams and seal with epoxy seam sealer. Rivet joints where necessary for strength.

## 2.6 LOW-SLOPE ROOF SHEET METAL FABRICATIONS

- A. Copings: Fabricate in sections not exceeding 10-feet. Use standing seams at all joint locations. Furnish with continuous cleats to support edge of external leg and fabricated from 22 gauge/0.050 inch stock. Miter corners. Fasten inside leg with 1 ½” neoprene gasketed fasteners at 12” on center. External leg shall extend below bottom edge of wood nailer and the top of wall a minimum of 2”.

## PART 3 - EXECUTION

### 3.1 UNDERLAYMENT INSTALLATION

- A. Self-Adhering Sheet Underlayment: Install self-adhering sheet underlayment, wrinkle free. Prime substrate if recommended by underlayment manufacturer. Comply with temperature restrictions of underlayment manufacturer for installation; use primer for installing underlayment at low temperatures. Apply in shingle fashion to shed water, with end laps of not less than 6 inches staggered between courses. Overlap side edges not less than 3-1/2 inches. Roll laps and edges with roller. Cover underlayment within 14 days.

### 3.2 INSTALLATION, GENERAL

- A. General: Anchor sheet metal flashing and trim and other components of the Work securely in place, with provisions for thermal and structural movement. Use fasteners, solder, protective coatings, separators, sealants, and other miscellaneous items as required to complete sheet metal flashing and trim system.
  - 1. Install sheet metal flashing and trim true to line, levels, and slopes. Provide uniform, neat seams with minimum exposure of solder, welds, and sealant.



2. Install sheet metal flashing and trim to fit substrates and to result in watertight performance. Verify shapes and dimensions of surfaces to be covered before fabricating sheet metal.
  3. Install exposed sheet metal flashing and trim with limited oil canning, and free of buckling and tool marks.
  4. Torch cutting of sheet metal flashing and trim is not permitted.
- B. Metal Protection: Where dissimilar metals contact each other, or where metal contacts pressure-treated wood or other corrosive substrates, protect against galvanic action or corrosion by painting contact surfaces with bituminous coating or by other permanent separation as recommended by sheet metal manufacturer or cited sheet metal standard.
1. Underlayment: Where installing sheet metal flashing and trim directly on wood substrates, install underlayment and cover with slip sheet.
- C. Expansion Provisions: Provide for thermal expansion of exposed flashing and trim. Space movement joints at maximum of 10 feet with no joints within 24 inches of corner or intersection.
1. Form expansion joints of intermeshing hooked flanges, not less than 1 inch deep, filled with sealant concealed within joints.
  2. Use standing seam expansion joints only.
- D. Fasteners: Use fastener sizes that penetrate wood blocking or sheathing not less than 1-1/4 inches for nails and not less than 1-1/4 inches for wood screws.
- E. Conceal fasteners and expansion provisions where possible in exposed work and locate to minimize possibility of leakage. Cover and seal fasteners and anchors as required for a tight installation.

### 3.3 ROOF-DRAINAGE SYSTEM INSTALLATION

- A. General: Install sheet metal roof-drainage items to produce complete roof-drainage system according to cited sheet metal standard unless otherwise indicated.

### 3.4 ROOF FLASHING INSTALLATION

- A. General: Install sheet metal flashing and trim to comply with performance requirements and cited sheet metal standard. Provide concealed fasteners where possible, and set units true to line, levels, and slopes. Install work with laps, joints, and seams that are permanently watertight and weather resistant.
- B. Roof Edge Flashing: Anchor to resist uplift and outward forces according to recommendations in cited sheet metal standard unless otherwise indicated. Interlock bottom edge of roof edge flashing with continuous cleat anchored to substrate.

- C. Pipe or Post Counterflashing: Install counterflashing umbrella with close-fitting collar with top edge flared for elastomeric sealant, extending minimum of 3 inches over base flashing. Install stainless-steel draw band and tighten.
- D. Counterflashing: Coordinate installation of counterflashing with installation of base flashing. Insert counterflashing in reglets or receivers and fit tightly to base flashing. Extend counterflashing 4 inches over base flashing. Lap counterflashing joints minimum of 4 inches.
- E. Roof-Penetration Flashing: Coordinate installation of roof-penetration flashing with installation of roofing and other items penetrating roof. Seal with sealant and clamp flashing to pipes that penetrate roof.

### 3.5 CLEANING AND PROTECTION

- A. Clean exposed metal surfaces of substances that interfere with uniform oxidation and weathering.
- B. Clean off excess sealants.
- C. Remove temporary protective coverings and strippable films as sheet metal flashing and trim are installed unless otherwise indicated in manufacturers written installation instructions.

END OF SECTION 076200

# SPARTANBURG SCHOOL DISTRICT 7

## MULTIPLE SCHOOL SELECTIVE ROOF REPAIR

JESSE BOYD E.S., CARVER M.S., AND McCRACKEN M.S.

WMBE PROJECT NUMBER: 2021-25

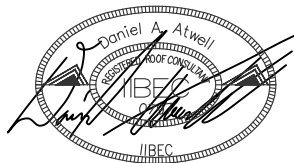

DESIGNED: DA

















SPARTANBURG SCHOOL DISTRICT SEVEN  
MULTIPLE SCHOOL ROOF REPAIR

STATE PROJECT NO.: 20-21-05

### DRAWING LEGEND

### SITE LOCATIONS

### CODE/INDUSTRY STANDARD REFERENCES

-  EQUIPMENT SUPPORT CURBS
-  CONCRETE SUPPORT
-  VENTILATOR
-  VENT THROUGH ROOF
-  STACK
-  PITCH PAN WITH CONDUIT/WIRES
-  PITCH PAN
-  ROOF DRAIN
-  UNIT ON WOODEN SLEEPERS
-  LIGHTNING ARRESTER SYSTEM
-  ELECTRICAL CONDUIT
-  CAMERA MOUNTED TO WALL
-  EXPANSION JOINT
-  OVERFLOW DRAIN
-  ROOF VENT
-  STACKS
-  OVERFLOW SCUPPER



**CARVER MIDDLE SCHOOL**  
ADDRESS: 467 CHURCH ST, SPARTAINBURG, SC 29307



**McCRACKEN MIDDLE SCHOOL**  
ADDRESS: 50 EMORY RD, SPARTAINBURG, SC 29307



**JESSE BOYD ELEMENTARY**  
ADDRESS: 1505 FERNWOOD GLENDALE RD, SPARTAINBURG, SC 29307

2018 IBC  
2018 IEBC  
2009 IECC  
NRCA - LATEST EDITION  
SMACNA - LATEST EDITION

### DRAWING SHEETS

- R-1.0 COVER PAGE
- R-1.1 JESSE BOYD E.S. OVERALL ROOF PLAN
- R-1.2 JESSE BOYD E.S. REPAIR ROOF PLAN (BASE BID)
- R-1.3 CARVER M.S. OVERALL ROOF PLAN
- R-1.4 CARVER M.S. REPAIR ROOF PLAN (BASE BID)
- R-1.5 McCRACKEN M.S. OVERALL ROOF PLAN
- R-1.6 McCRACKEN M.S. REPAIR ROOF PLAN (BASE BID)
- R-1.7 McCRACKEN M.S. ROOF PLAN ALTERNATE 1
- D-1.1 DETAILS
- D-1.2 DETAILS
- D-1.3 DETAILS

### ABBREVIATIONS

- |        |   |
|--------|---|
| MIN    | MINIMUM   |
| MAX    | MAXIMUM   |
| NRCA   | NATIONAL ROOFING CONTRACTORS ASSOCIATION                          |
| O.C.   | ON CENTER   |
| SMACNA | SHEET METAL AND AIR CONDITIONING CONTRACTORS NATIONAL ASSOCIATION |

### JOB CONTACTS

WMBE DANIEL ATWELL  
803-422-7493  
DANIEL@WMBECONSULTANTS.COM



COLUMBIA AREA OFFICE

1501 CHAPIN ROAD  
CHAPIN, SOUTH CAROLINA  
EMAIL: CHRIS@WMBECONSULTANTS.COM  
EMAIL: DANIEL@WMBECONSULTANTS.COM

CHARLESTON AREA OFFICE

3049 OLD U.S. 52, SUITE A-106  
MONCK'S CORNER, SOUTH CAROLINA  
EMAIL: JOE@WMBECONSULTANTS.COM

THESE DRAWINGS ARE THE PROPERTY OF:

WM BUILDING ENVELOPE CONSULTANTS, LLC

THE REPRODUCTION, COPYING OR OTHER USE OF THESE DRAWINGS WITHOUT THEIR WRITTEN CONSENT IS PROHIBITED AND MAY BE SUBJECT TO LEGAL ACTION.

NORTH



PROJECT NUMBER: 2021-25

CONSTRUCTION DOCUMENTS

DATE: 04-02-2021

COVER PAGE

PAGE:

R-1.0

**NOTE:**

1. ROOF AREAS WHERE SELECTIVE REPAIRS SHALL BE COMPLETED INCLUDE ROOF AREAS T, Z, EE AND GG.

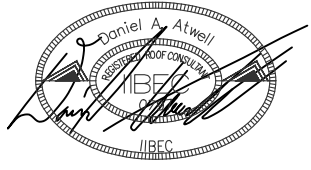

DESIGNED: DA

SPARTANBURG SCHOOL DISTRICT SEVEN  
MULTIPLE SCHOOL ROOF REPAIR

STATE PROJECT NO.: 20-21-05



BUILDING ENVELOPE CONSULTANTS, LLC

COLUMBIA AREA OFFICE

1501 CHAPIN ROAD  
CHAPIN, SOUTH CAROLINA  
EMAIL: CHRIS@WMBECONSULTANTS.COM  
EMAIL: DANIEL@WMBECONSULTANTS.COM

CHARLESTON AREA OFFICE

3049 OLD U.S. 52, SUITE A-106  
MONCK'S CORNER, SOUTH CAROLINA  
EMAIL: JOE@WMBECONSULTANTS.COM

THESE DRAWINGS ARE THE PROPERTY OF:

WM BUILDING ENVELOPE CONSULTANTS, LLC

THE REPRODUCTION, COPYING OR OTHER USE OF THESE DRAWINGS WITHOUT THEIR WRITTEN CONSENT IS PROHIBITED AND MAY BE SUBJECT TO LEGAL ACTION.

NORTH



PROJECT NUMBER: 2021-25

CONSTRUCTION DOCUMENTS

DATE: 04-02-2021

JESSE BOYD OVERALL  
ROOF PLAN

PAGE:

R-1.1

SHEET 2 OF 11

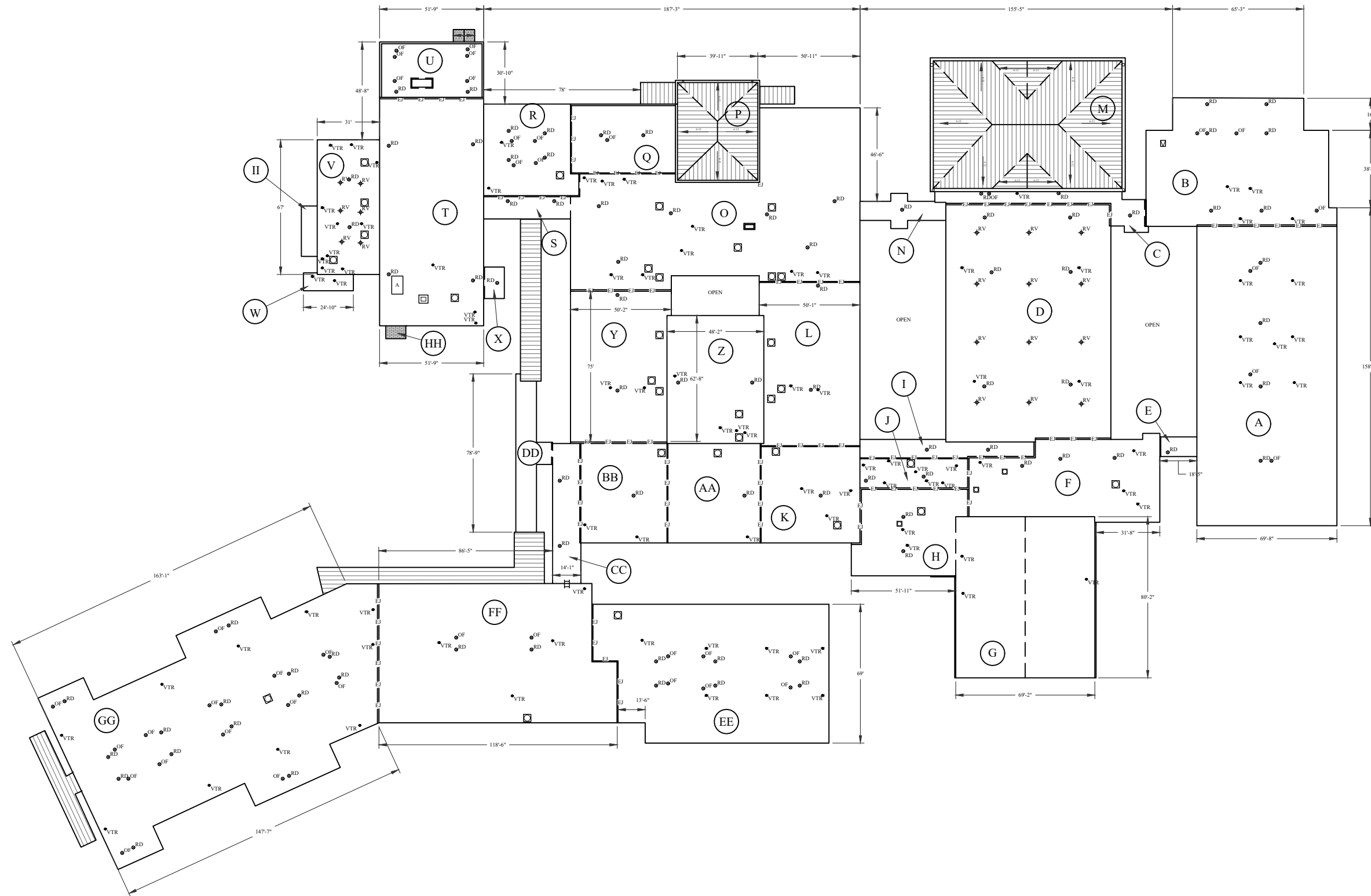

**JESSE BOYD ELEMENTARY  
OVERALL ROOF PLAN**

**NOT TO SCALE**

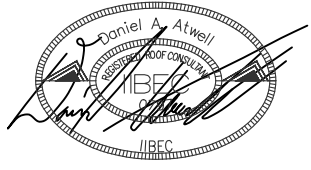

DESIGNED: DA

SPARTANBURG SCHOOL DISTRICT SEVEN  
MULTIPLE SCHOOL ROOF REPAIR

STATE PROJECT NO.: 20-21-05



BUILDING ENVELOPE  
CONSULTANTS, LLC

COLUMBIA AREA OFFICE

1501 CHAPIN ROAD  
CHAPIN, SOUTH CAROLINA  
EMAIL: CHRIS@WMBECONSULTANTS.COM  
EMAIL: DANIEL@WMBECONSULTANTS.COM

CHARLESTON AREA OFFICE

3049 OLD U.S. 52, SUITE A-106  
MONCK'S CORNER, SOUTH CAROLINA  
EMAIL: JOE@WMBECONSULTANTS.COM

THESE DRAWINGS ARE THE PROPERTY OF:

WM BUILDING ENVELOPE  
CONSULTANTS, LLC

THE REPRODUCTION, COPYING OR OTHER  
USE OF THESE DRAWINGS WITHOUT THEIR  
WRITTEN CONSENT IS PROHIBITED AND  
MAY BE SUBJECT TO LEGAL ACTION.

NORTH



PROJECT NUMBER: 2021-25

CONSTRUCTION DOCUMENTS

DATE: 04-02-2021

JESSE BOYD REPAIR  
ROOF PLAN

PAGE:

R-1.2

SHEET 3 OF 11

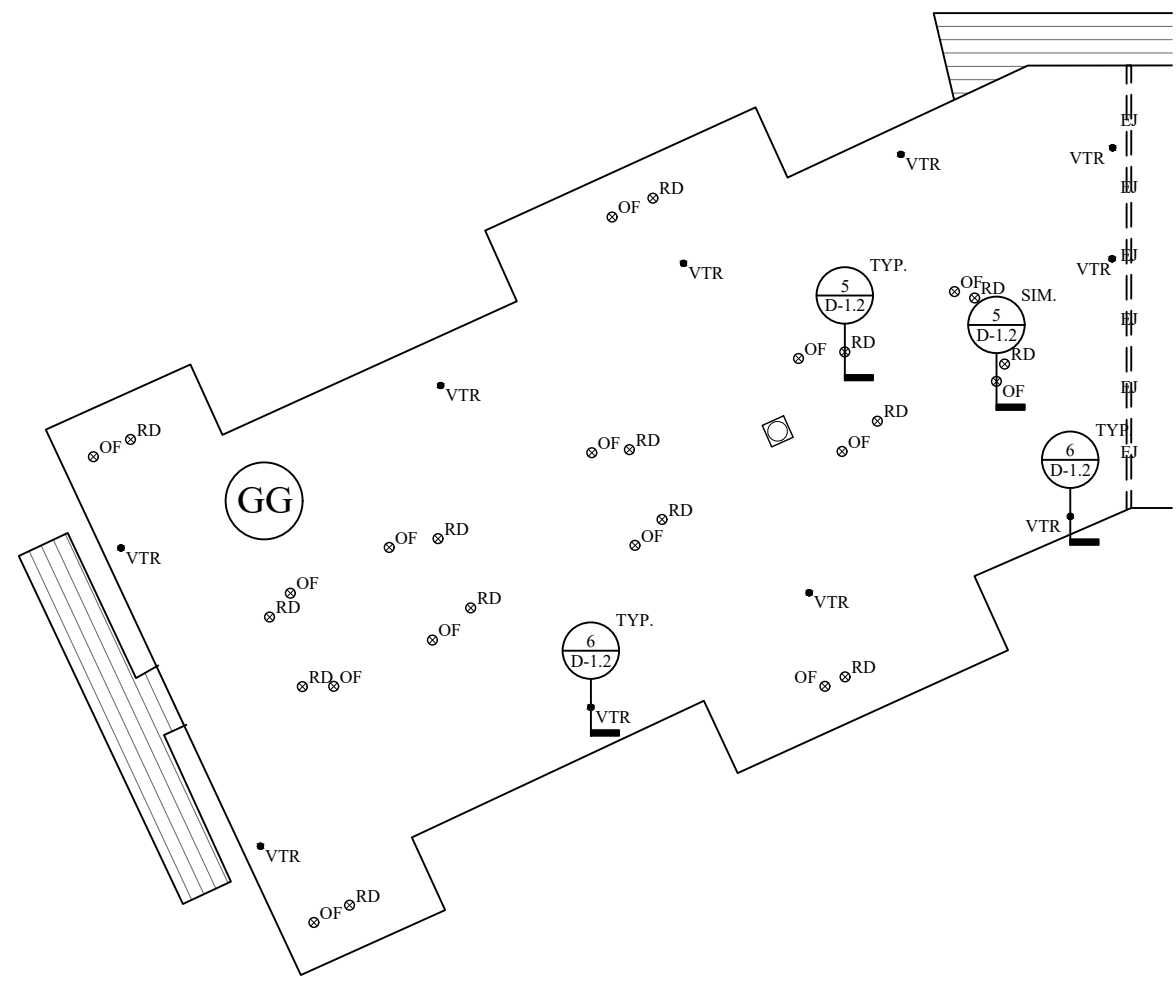

ROOF AREA GG

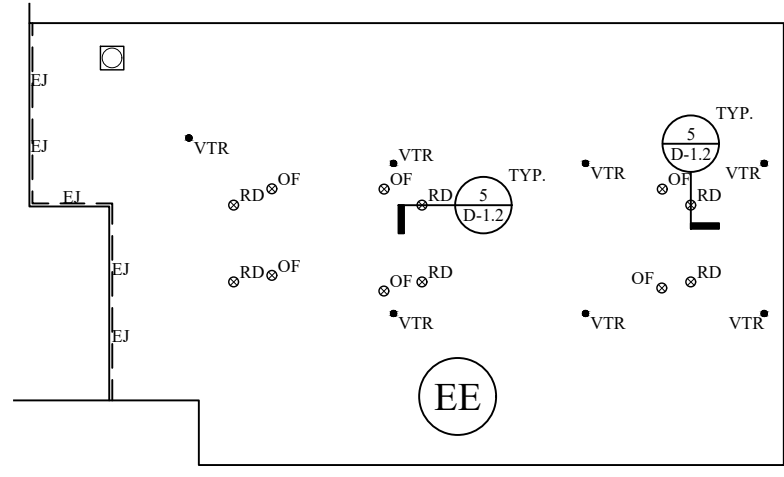

ROOF AREA EE

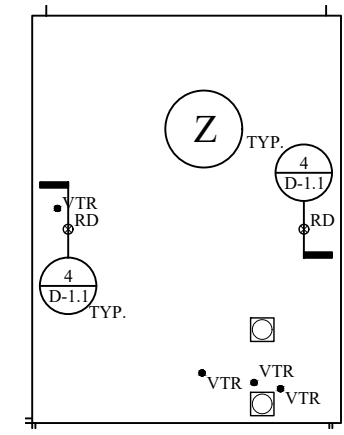

ROOF AREA Z

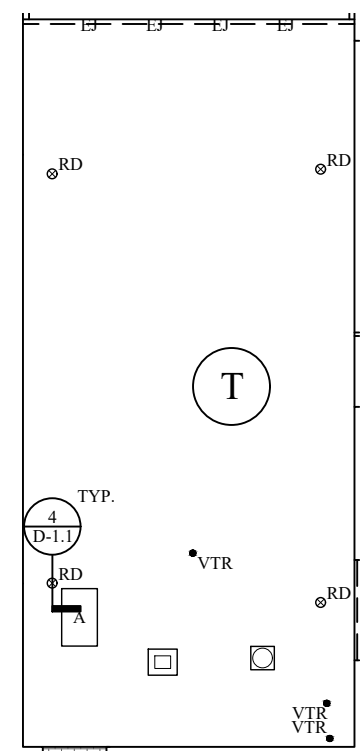

ROOF AREA T

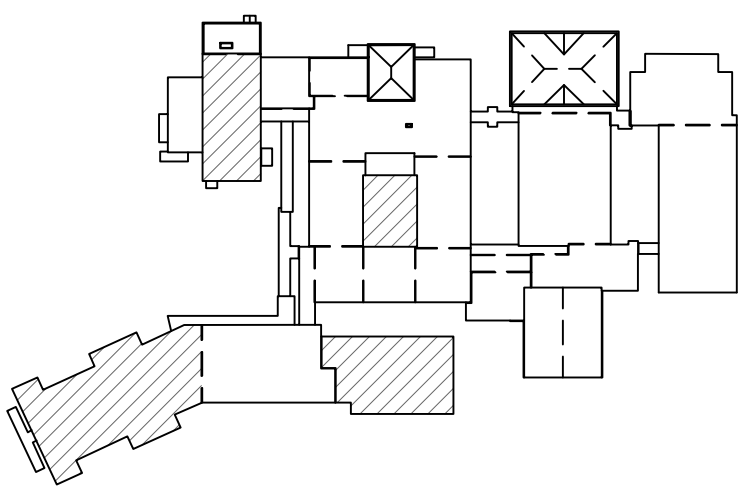

JESSE BOYD ELEMENTARY  
REPAIR ROOF PLAN (BASE BID)



GRAPHIC SCALE



**NOTE:**

1. ROOF AREAS WHERE REPAIRS SHALL BE COMPLETED INCLUDE ROOF AREAS D, E, AND G.

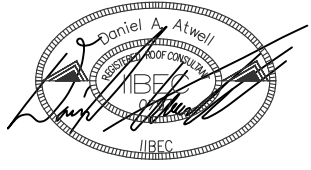

DESIGNED: DA

SPARTANBURG SCHOOL DISTRICT SEVEN  
MULTIPLE SCHOOL ROOF REPAIR

STATE PROJECT NO.: 20-21-05



BUILDING ENVELOPE CONSULTANTS, LLC

COLUMBIA AREA OFFICE

1501 CHAPIN ROAD  
CHAPIN, SOUTH CAROLINA  
EMAIL: CHRIS@WMBECONSULTANTS.COM  
EMAIL: DANIEL@WMBECONSULTANTS.COM

CHARLESTON AREA OFFICE

3049 OLD U.S. 52, SUITE A-106  
MONCK'S CORNER, SOUTH CAROLINA  
EMAIL: JOE@WMBECONSULTANTS.COM

THESE DRAWINGS ARE THE PROPERTY OF:

WM BUILDING ENVELOPE CONSULTANTS, LLC

THE REPRODUCTION, COPYING OR OTHER USE OF THESE DRAWINGS WITHOUT THEIR WRITTEN CONSENT IS PROHIBITED AND MAY BE SUBJECT TO LEGAL ACTION.

NORTH



PROJECT NUMBER: 2021-25

CONSTRUCTION DOCUMENTS

DATE: 04-02-2021

CARVER OVERALL ROOF PLAN

PAGE:

R-1.3

SHEET 4 OF 11

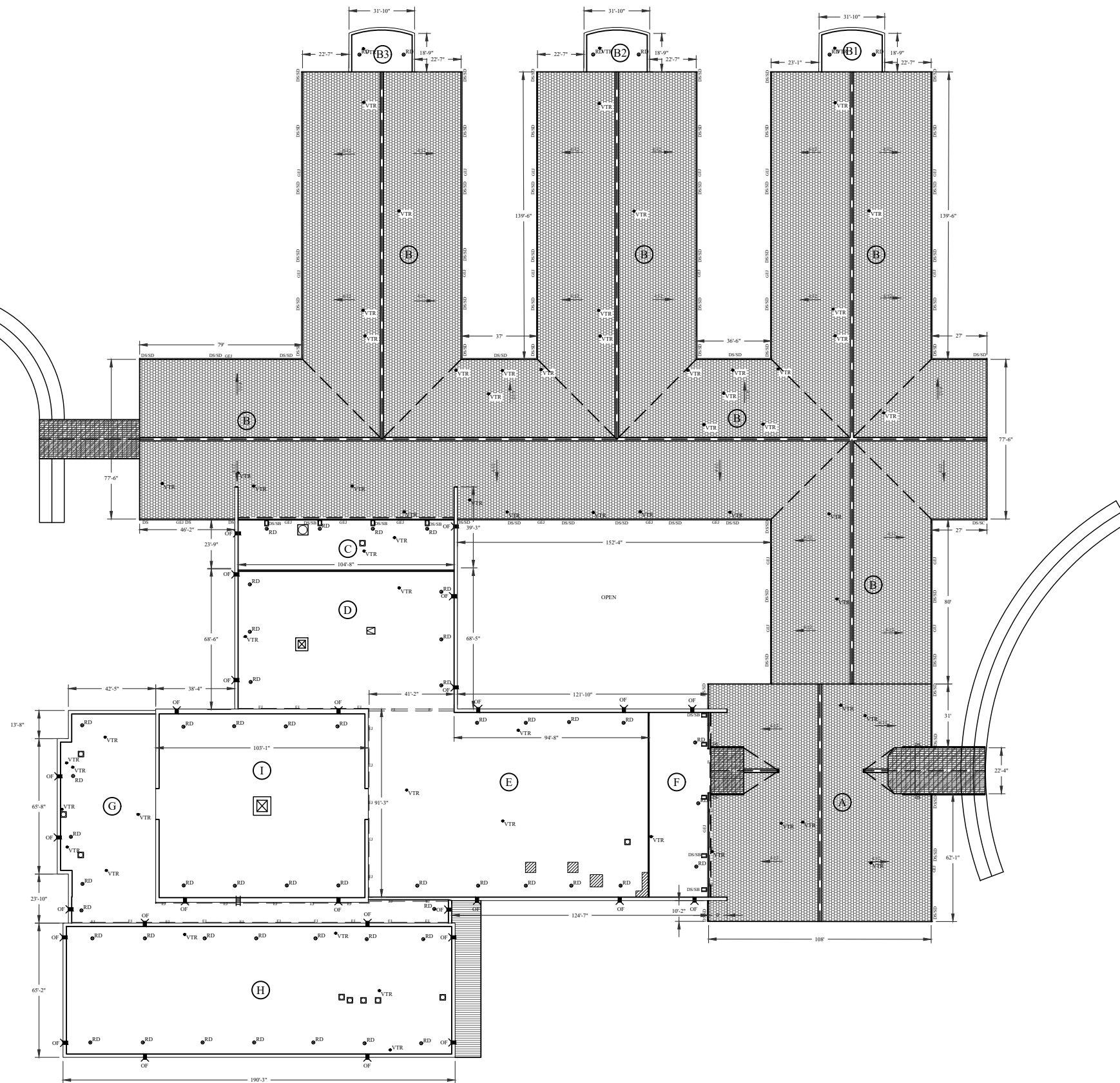

**CARVER MIDDLE SCHOOL  
OVERALL ROOF PLAN**

**NOT TO SCALE**

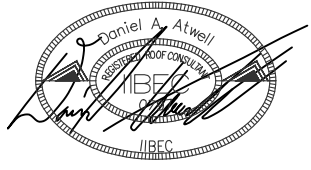

DESIGNED: DA

SPARTANBURG SCHOOL DISTRICT SEVEN  
MULTIPLE SCHOOL ROOF REPAIR

STATE PROJECT NO.: 20-21-05



BUILDING ENVELOPE CONSULTANTS, LLC

COLUMBIA AREA OFFICE

1501 CHAPIN ROAD  
CHAPIN, SOUTH CAROLINA  
EMAIL: CHRIS@WMBECONSULTANTS.COM  
EMAIL: DANIEL@WMBECONSULTANTS.COM

CHARLESTON AREA OFFICE

3049 OLD U.S. 52, SUITE A-106  
MONCK'S CORNER, SOUTH CAROLINA  
EMAIL: JOE@WMBECONSULTANTS.COM

THESE DRAWINGS ARE THE PROPERTY OF:

WM BUILDING ENVELOPE CONSULTANTS, LLC

THE REPRODUCTION, COPYING OR OTHER USE OF THESE DRAWINGS WITHOUT THEIR WRITTEN CONSENT IS PROHIBITED AND MAY BE SUBJECT TO LEGAL ACTION.

NORTH



PROJECT NUMBER: 2021-25

CONSTRUCTION DOCUMENTS

DATE: 04-02-2021

CARVER OVERALL ROOF PLAN

PAGE:

R-1.4

SHEET 5 OF 11

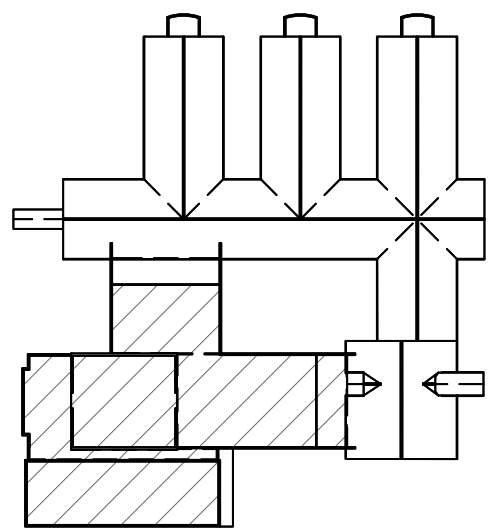
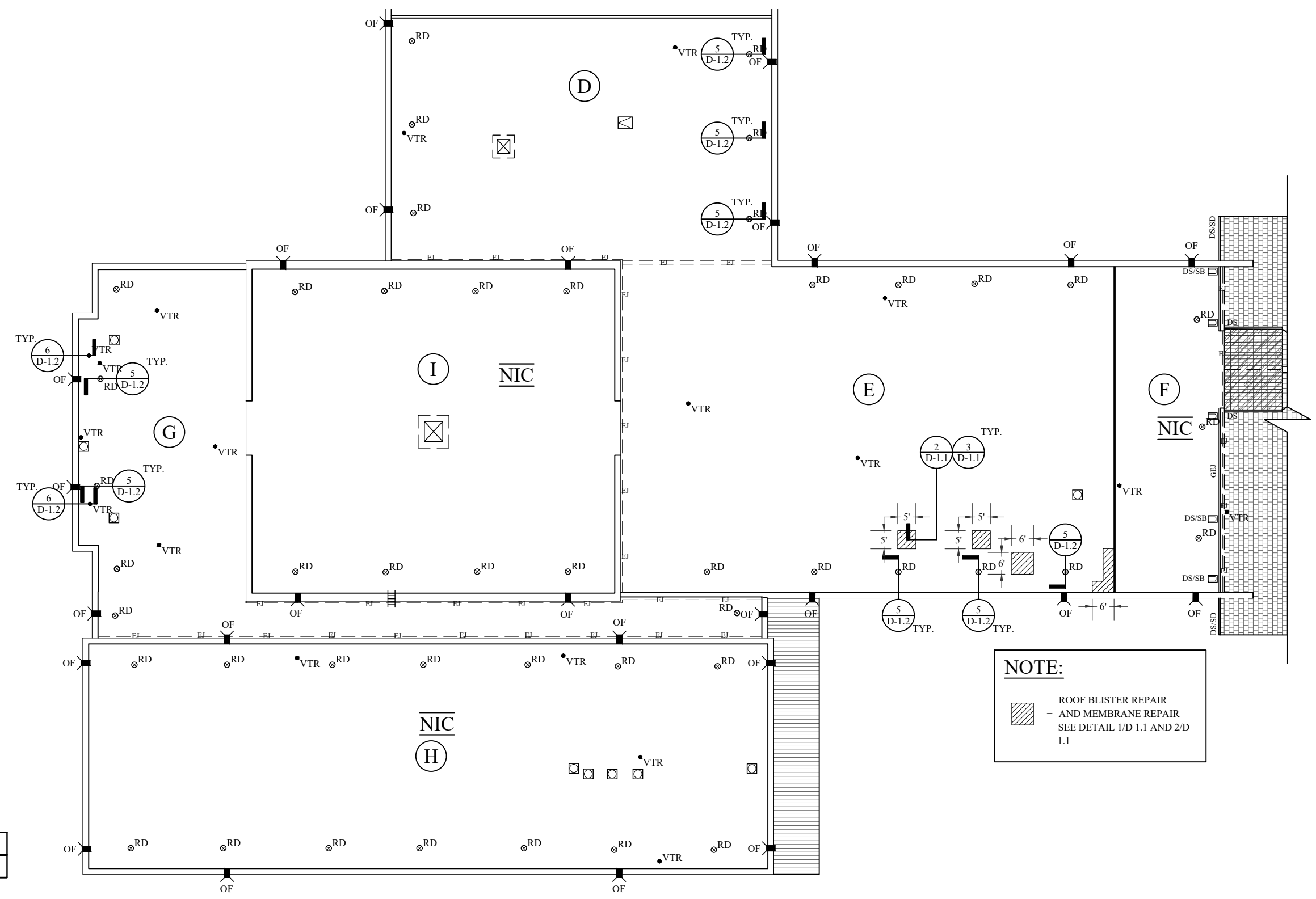

**NOTE:**  
[Hatched Box] = ROOF BLISTER REPAIR AND MEMBRANE REPAIR  
SEE DETAIL 1/D 1.1 AND 2/D 1.1



CARVER MIDDLE SCHOOL REPAIR  
ROOF PLAN (BASE BID)

**NOTE:**

- 1. ROOF AREAS WHERE REPAIRS SHALL BE COMPLETED INCLUDE ROOF AREA I.

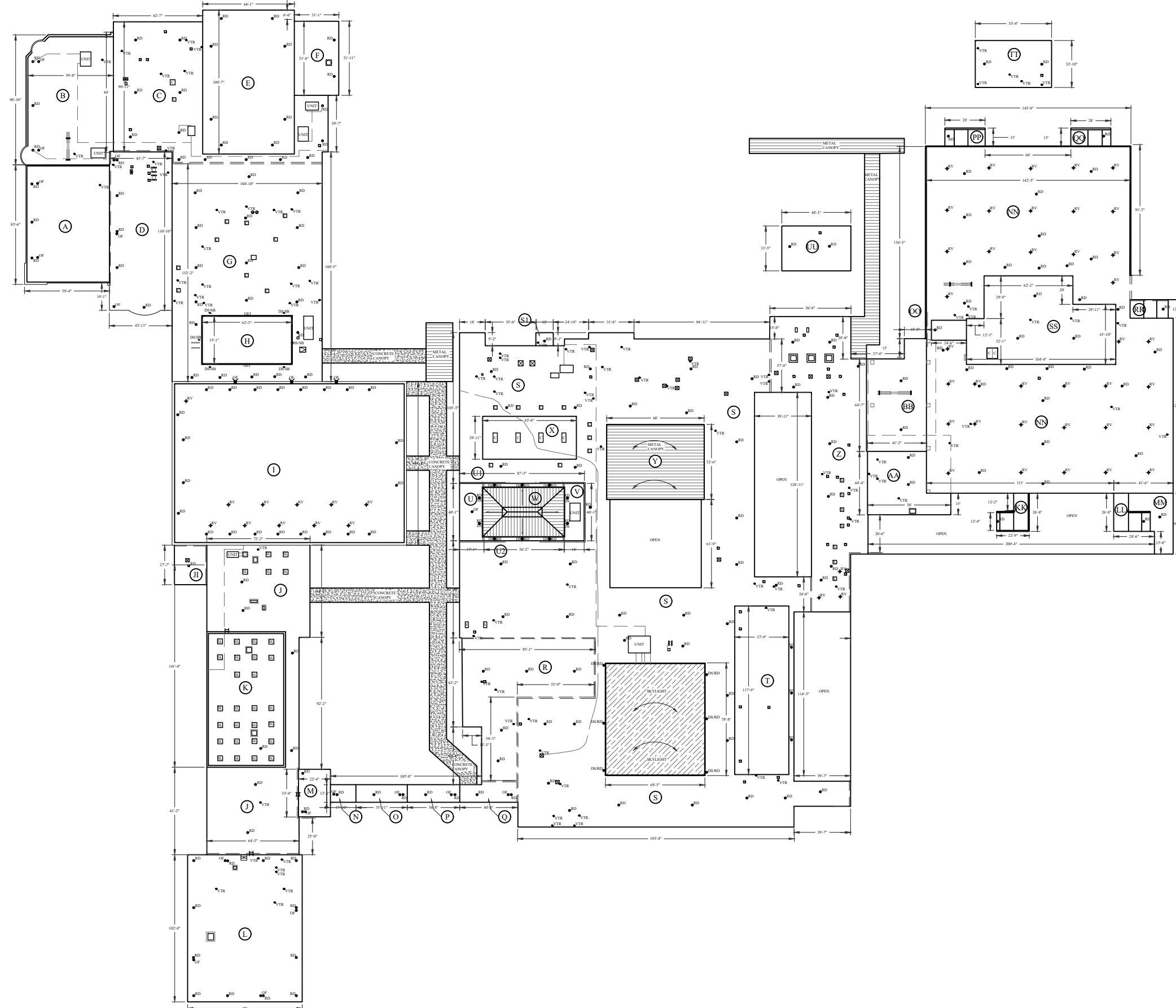

McCRACKEN MIDDLE SCHOOL  
OVERALL ROOF PLAN

NOT TO SCALE

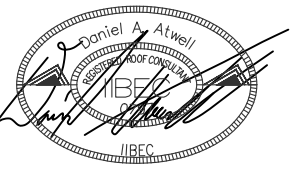

DESIGNED: DA

SPARTANBURG SCHOOL DISTRICT SEVEN  
MULTIPLE SCHOOL ROOF REPAIR

STATE PROJECT NO.: 20-21-05



BUILDING ENVELOPE  
CONSULTANTS, LLC

COLUMBIA AREA OFFICE

1501 CHAPIN ROAD  
CHAPIN, SOUTH CAROLINA  
EMAIL: CHRIS@WMBECONSULTANTS.COM  
EMAIL: DANIEL@WMBECONSULTANTS.COM

CHARLESTON AREA OFFICE

3049 OLD U.S. 52, SUITE A-106  
MONCK'S CORNER, SOUTH CAROLINA  
EMAIL: JOE@WMBECONSULTANTS.COM

THESE DRAWINGS ARE THE PROPERTY OF:

WM BUILDING ENVELOPE  
CONSULTANTS, LLC

THE REPRODUCTION, COPYING OR OTHER  
USE OF THESE DRAWINGS WITHOUT THEIR  
WRITTEN CONSENT IS PROHIBITED AND  
MAY BE SUBJECT TO LEGAL ACTION.

NORTH



PROJECT NUMBER: 2021-25

CONSTRUCTION DOCUMENTS

DATE: 04-02-2021

McCRACKEN OVERALL  
ROOF PLAN

PAGE:

R-1.5

SHEET 6 OF 11



**NOTE:**

1. INTERIOR ACCESS SHALL BE PROVIDED VIA LIFT W/ PROPER PROTECTION PROVIDED FOR EXISTING WOOD GYM FLOORING.
2. NEW ROOF DRAIN BOWL AND ALL ASSOCIATED ROOF DRAIN FLASHINGS TO BE PROVIDED AT REPAIR LOCATION.
3. NEW "HEAVY DUTY" NO HUB CONNECTORS TO BE INSTALLED AT NE ROOF DRAIN BOWL AND ELBOW LOCATION W/ NEW PIPE INSULATION INSTALLED.

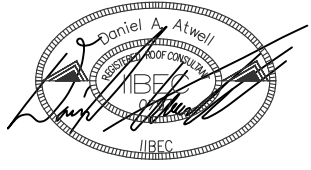

DESIGNED: DA

SPARTANBURG SCHOOL DISTRICT SEVEN  
MULTIPLE SCHOOL ROOF REPAIR

STATE PROJECT NO.: 20-21-05



BUILDING ENVELOPE  
CONSULTANTS, LLC

COLUMBIA AREA OFFICE

1501 CHAPIN ROAD  
CHAPIN, SOUTH CAROLINA  
EMAIL: CHRIS@WMBECONSULTANTS.COM  
EMAIL: DANIEL@WMBECONSULTANTS.COM

CHARLESTON AREA OFFICE

3049 OLD U.S. 52, SUITE A-106  
MONCK'S CORNER, SOUTH CAROLINA  
EMAIL: JOE@WMBECONSULTANTS.COM

THESE DRAWINGS ARE THE PROPERTY OF:

WM BUILDING ENVELOPE  
CONSULTANTS, LLC

THE REPRODUCTION, COPYING OR OTHER  
USE OF THESE DRAWINGS WITHOUT THEIR  
WRITTEN CONSENT IS PROHIBITED AND  
MAY BE SUBJECT TO LEGAL ACTION.

NORTH



PROJECT NUMBER: 2021-25

CONSTRUCTION DOCUMENTS

DATE: 04-02-2021

McCRACKEN PARTIAL  
ROOF PLAN

PAGE:

R-1.6

SHEET 7 OF 11

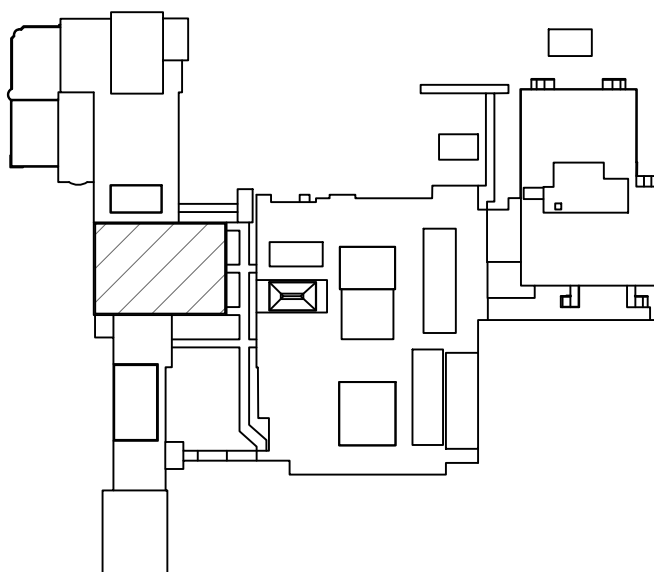
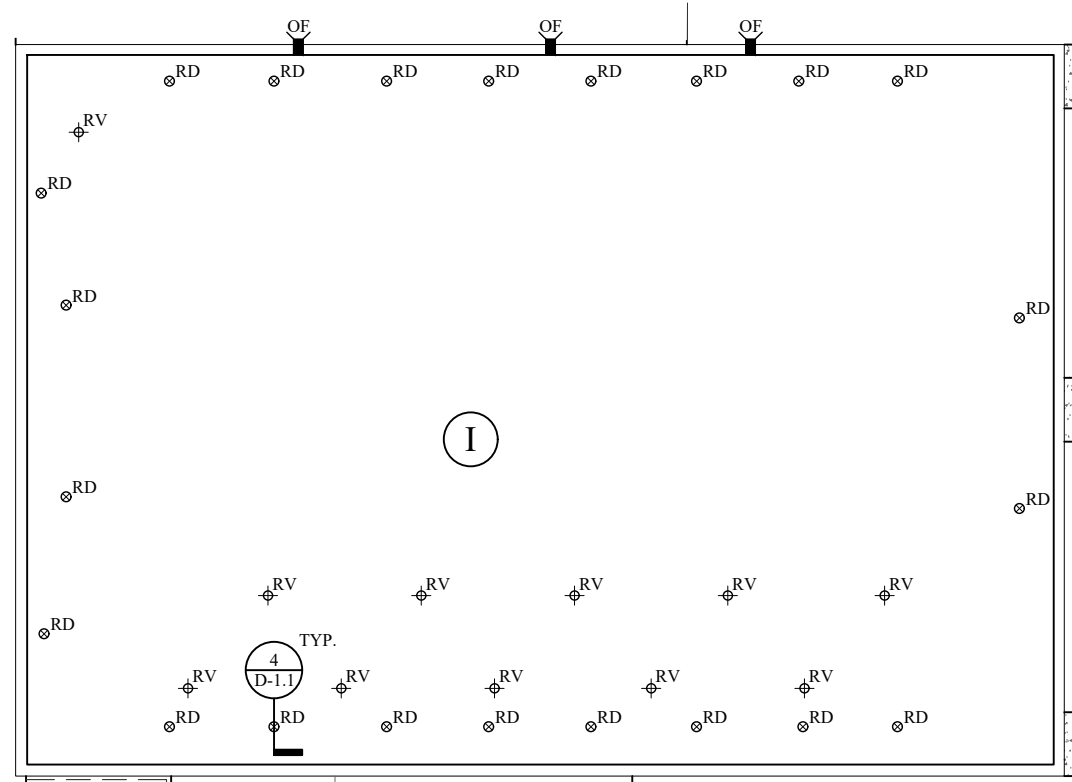

McCRACKEN MIDDLE SCHOOL  
REPAIR ROOF PLAN (BASE BID)



GRAPHIC SCALE

**NOTE:**

1. ROOF REPAIR SHALL BE COMPLETED WITH REMOVAL OF THE EXISTING AGGREGATE, SURFACE PREPARATION, PRIMING OF THE EXISTING SURFACE, AND INSTALLATION OF TWO-PLY ROOF MEMBRANE REPAIR.

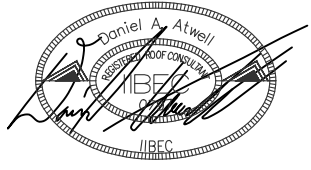

DESIGNED: DA

SPARTANBURG SCHOOL DISTRICT SEVEN  
MULTIPLE SCHOOL ROOF REPAIR

STATE PROJECT NO.: 20-21-05



BUILDING ENVELOPE CONSULTANTS, LLC

COLUMBIA AREA OFFICE

1501 CHAPIN ROAD  
CHAPIN, SOUTH CAROLINA  
EMAIL: CHRIS@WMBECONSULTANTS.COM  
EMAIL: DANIEL@WMBECONSULTANTS.COM

CHARLESTON AREA OFFICE

3049 OLD U.S. 52, SUITE A-106  
MONCK'S CORNER, SOUTH CAROLINA  
EMAIL: JOE@WMBECONSULTANTS.COM

THESE DRAWINGS ARE THE PROPERTY OF:

WM BUILDING ENVELOPE CONSULTANTS, LLC

THE REPRODUCTION, COPYING OR OTHER USE OF THESE DRAWINGS WITHOUT THEIR WRITTEN CONSENT IS PROHIBITED AND MAY BE SUBJECT TO LEGAL ACTION.

NORTH



PROJECT NUMBER: 2021-25

CONSTRUCTION DOCUMENTS

DATE: 04-02-2021

McCRACKEN ALTERNATE 1 ROOF PLAN

PAGE:

R-1.7

SHEET 8 OF 11

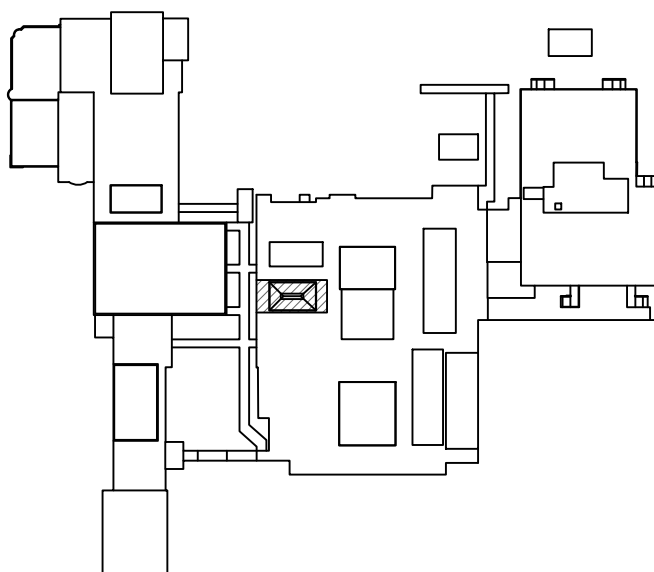
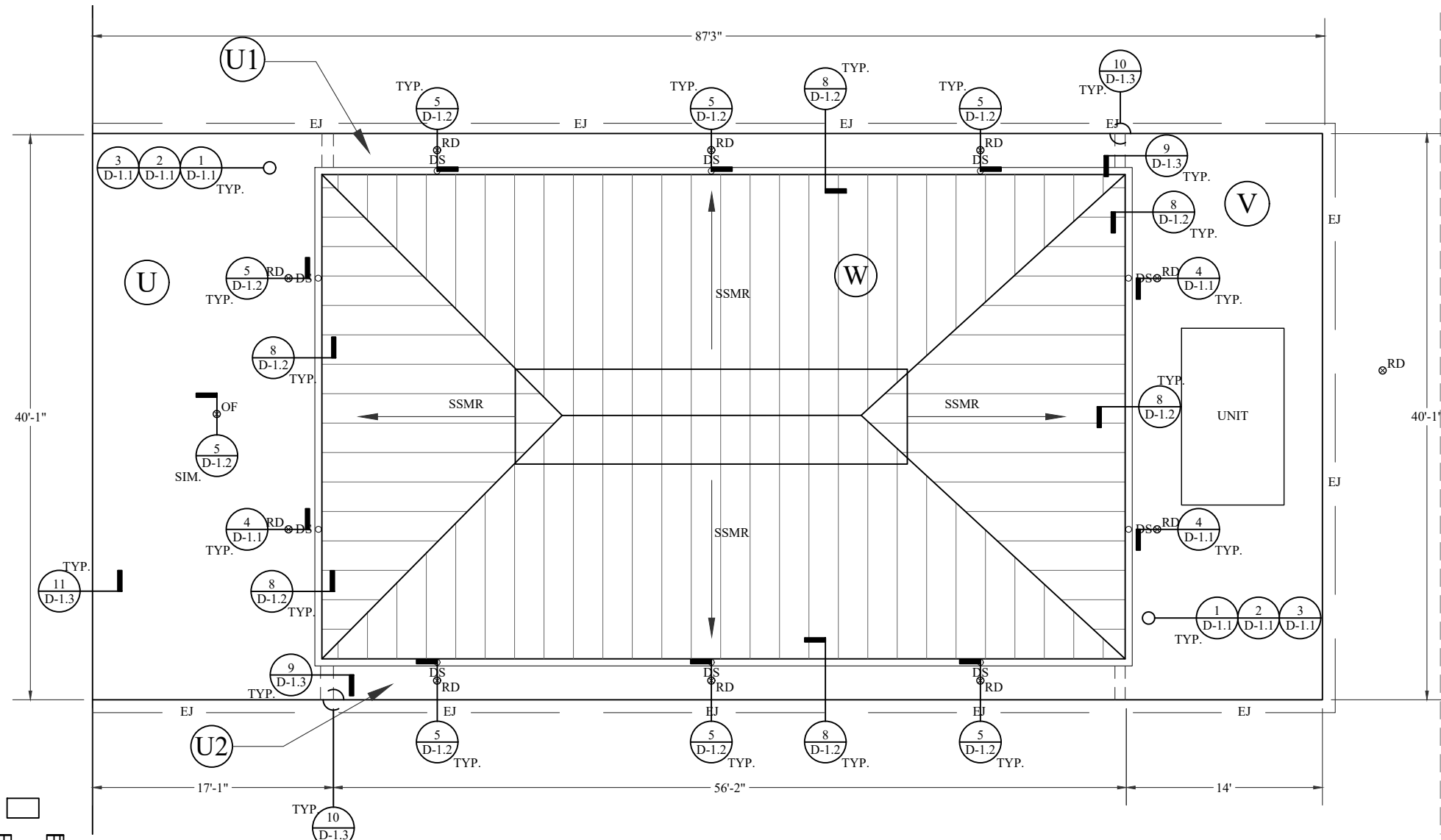

McCRACKEN MIDDLE SCHOOL  
ALTERNATE 1: AREAS U, U1, U2,  
AND V



GRAPHIC SCALE