

PROJECT MANUAL  
FOR  
WOODBIDGE DRAINAGE IMPROVEMENTS

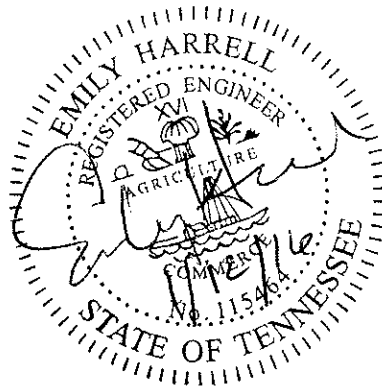

City of Lakeland  
January 2017

# TABLE OF CONTENTS

## **SECTION I:            **BID DOCUMENTS, CONTRACTS, FORMS, AND CONDITIONS OF THE CONTRACT****

Advertisement for Bid	AB-1 -- AB-2
Instruction to Bidders	IB-1 -- IB-9
Bid Form	BF-1 -- BF-4
Bid Schedule	BS-1 -- BS-2
Standard Bid Bond	BB-1 -- BB-2
Standard Agreement Between Owner and Contractor	SFA-1 -- SFA-6
Standard Performance Bond	C-610-1 -- C-610-3
Standard Payment Bond	C-615(A)-1 -- C-615(A)-3
Drug-Free Workplace Affidavit	DA-1
Standard General Conditions	C700-1 -- C700-65
Standard Supplementary Conditions	SSC-1 -- SSC-13

## **SECTION II:            **BIDDING AND TECHNICAL SPECIFICATIONS****

### GENERAL REQUIREMENTS

Summary of Work	01010
General Construction Requirements	01100
Project Coordination	01200
Submittals	01340
Temporary Facilities	01505
Measurement and Payment Procedures	01650
Contract Closeout	01750

### SPECIAL PROVISIONS

Special Provisions	01810
--------------------	-------

### TECHNICAL SPECIFICATIONS

Temporary Traffic Control	01551
Erosion and Sediment Control	02115
Storm Sewers and Culverts	02632
Asphaltic Concrete Pavements	02741
Concrete Curb and Gutter, Valley Gutters, Sidewalk and Driveways	02770
Seeding and Lawn Restoration	02835
Portland Cement Concrete	03050
Standard Details	Appendix A

STANDARD  
ADVERTISEMENT FOR BIDS  
FOR  
WOODBIDGE DRAINAGE IMPROVEMENTS  
FOR  
CITY OF LAKELAND  
LAKELAND, TENNESSEE

Notice is hereby given, pursuant to Tennessee Statute Section 16-19-104, the City of Lakeland, Tennessee, will receive sealed bids until 2:00 p.m., Local Time, January 26, 2017, for the following:

WOODBIDGE DRAINAGE IMPROVEMENTS

Bids must be in one sealed envelope with statement thereon "BID ENCLOSED, WOODBRIDGE DRAINAGE IMPROVEMENTS" and be submitted to the receptionist at the City of Lakeland, Tennessee 10001 U.S. Highway 70, at or before the above stated time. Bids will be opened publicly, read aloud, and tabulated by the City Manager, or his or her Designee, at the above stated time and place, unless an alternative site is designated in writing prior to the time of Bid Opening. No bid may be withdrawn for a period of thirty (30) days after the date set for opening thereof. The City of Lakeland, Tennessee reserves the right to reject any or all bids and to waive any informalities or technicalities in the bidding; provided, however, that any bid received after the time specified or without accompanying Bid Guaranty, as stated below, will not be considered.

Bidding Documents, including specifications, are currently available from the City of Lakeland Tennessee, 10001 U.S. Highway No. 70, Lakeland Tennessee or [www.lakelandtn.gov](http://www.lakelandtn.gov).

A Bid Guaranty in the form of a properly executed Bid Bond payable to the City in the amount of not less than 5% of the total base bid amount must accompany each bid. Pursuant to T.S. 12-4-201, in lieu of a Bid Bond, the following securities or cash may be substituted at the percentage rate required for such bond: United States treasury bond or general obligation bond or certificates of deposit irrevocably pledged from a state or national bank having its principle office in Tennessee or a state or federal saving and loan association having its principal office in Tennessee, or any state or national banks or state or federal savings and loans associations that has its principal office located outside of Tennessee and that maintains a branch in this state, or a letter of credit or cash. The successful Bidder will be required to execute an Agreement with the City, in the form supplied in the bidding documents, within thirty (30) days after Notice of Award is issued. The Notice of Award shall serve as notice that the Agreement is ready for execution. The Bid Guaranty shall be forfeited as liquidated damages if the Bidder fails to execute the Agreement within thirty (30) days after such Notice is issued, or fails to provide proper Bond or other form of Guaranty, as approved. The Bid Guaranty, if a Bid Bond, shall be executed by a surety or guarantee company authorized to do business in Tennessee. The Attorney-in-Fact who executes the Bond on behalf of the surety shall

affix a certified and current copy of its Power of Attorney from the surety. No other type of Bid Guaranty will be accepted. The City may proceed against a Bid Guaranty unless either: a) the Agreement has been executed by Contractor and Performance, and Labor and Material Payment Bonds have been furnished, as required; or, b) the specified time has elapsed so that Bids may be withdrawn; or, c) the Bid has been rejected.

Notice is hereby given that preference will be granted to Tennessee contractors, subcontractors, laborers, and materials, supplies, equipment, machinery, and provisions produced, manufactured, supplied, or grown in Tennessee, as required by Tennessee Statute Section 12-4-121 et seq.

A Pre-Bid Conference will be held at 2:00 p.m., Local Time, January 19, 2017, at Lakeland City Hall. A site tour may be held to review the Project following this conference. Contact for this Project is Emily Harrell, P.E. at (901) 867-2718.

Attendance in the Pre-Bid Conference is not mandatory for Contractors who wish to be considered qualified and/or responsible.

---

Jim Atkinson  
City Manager

Publish:        January 12, 2017  
                      January 18, 2017

STANDARD  
INSTRUCTIONS TO BIDDERS

1. DEFINED TERMS.

1.1 Terms used in these Instructions to Bidders have the meanings assigned to them in the Standard General Conditions, as modified by the Supplementary Conditions unless otherwise stated herein.

1.2 Certain additional terms used in these Instructions to Bidders have the meanings indicated below which are applicable to both the singular and plural thereof.

A. Bidder: One who submits a bid directly to the City.

B. Successful Bidder and/or Contractor: This term means the qualified, responsible, and responsive Bidder, as determined by the City, who has submitted the lowest bid, and to whom the City has awarded the Contract.

C. Bid Documents: Prior to award of the contract, all documents in the Bid Package are considered "Bid Documents." This includes the Advertisement for Bid, Instructions to Bidders, Bid Forms, Bond Forms, Sample Agreement, Standard General Conditions, Supplementary Conditions, Technical Specifications, drawings, etc. Bid Documents also include any addenda issued prior to the opening of the bids.

D. Contract Documents: Following the award of the contract, contract documents shall include those documents listed above in "C." -- with the exception of the Advertisement for Bid, Bid Bond and the Instructions to Bidders; the executed performance and payment bonds; change orders; and, all written agreements and/or written documents executed between the City and Contractor.

2. COPIES OF BIDDING DOCUMENTS.

2.1 Complete sets of Bidding Documents, which include the Advertisement for Bids, these Instructions to Bidders, Bid Form, Bid Bond, Contract Documents, and Addenda, may be obtained from the City of Lakeland, Engineering Office, 10001, U.S. Highway 70, Lakeland, Tennessee 38002.

2.2 Complete sets of Bidding Documents must be used in preparing Bids; the City assumes no responsibility to Bidders for errors or misinterpretations, including those resulting from the use of incomplete sets of Bidding Documents.

2.3 The City, and/or its agent, in making copies of Bidding Documents available on the above terms, does so only for the purpose of obtaining Bids on the Work and does not confer a license or grant for any other use.

### 3. QUALIFICATIONS OF BIDDERS.

3.1 Pre-qualification Requirements: Attendance at the Pre-Bid Conference may be considered by the City in determining a Bidder's qualifications. Consult Section 5 below.

3.2 Post Bid Qualifications: To demonstrate qualifications to perform the Work, each Bidder must be prepared to submit within five (5) days of Owner's request written evidence demonstrating Bidder's responsibility, including, but not limited to, matters such as financial data and previous experience. Each Bid will be considered a warrant of Bidder's qualification to do business in this state. Proof of such qualifications may be required upon five (5) days notice.

3.3 Bidding Preferences: Pursuant to T.S. 12-4-802 whenever the lowest responsible and responsive bidder on a public construction project in this state is a resident of another state which is contiguous to Tennessee and which allows a preference to a resident contractor of that state, a like reciprocal preference is allowed to the lowest responsible and responsive bidder on such project who is either a resident of this state or is a resident of another state which does not allow for a preference to a resident contractor of that state.

3.4 Responsible and Responsive Bidders: Pursuant to TS 12-4-801, a responsible bidder means a person who has the capacity in all respects to perform fully the contract requirements, and the integrity and reliability which will assure good faith performance and; and Responsive Bidder means a person who has submitted a bid which confirms in all material respects to all document, whether attached or incorporate by reference, utilized for soliciting bids.

### 4. PRE-BID CONFERENCE.

A Pre-bid Conference will be held at the time and place stated in the "Advertisement for Bid." Attendance at the Pre-bid Conference is not mandatory.

The purpose of the Conference is to review project requirements and provide bidders an opportunity to visit the project site to make their own determination of existing conditions.

Minutes will be taken of the Pre-bid Conference, and thereafter consulted as a bidding document.

### 5. EXAMINATION OF CONTRACT DOCUMENTS AND SITE.

5.1 Before submitting a Bid, each Bidder must do at least the following:

- A. Examine the Bidding Documents thoroughly;
- B. Visit the site to become familiar with local conditions that may in any manner affect cost progress, or performance of the Work;
- C. Become familiar with federal, state, and local laws, ordinances, rules, and regulations that may in any manner affect cost, progress, or performance of the work; and
- D. Study and carefully correlate Bidder's observations with the Bidding Documents.

5.2 Reference is made to the Supplementary Conditions, for the identification of those reports of investigations and tests of subsurface and latent physical conditions at the site or otherwise affecting cost, progress, or performance of the work which has/have been relied upon by Engineer in preparing the Drawings and Specifications. The City will provide copies of such reports for review to any Bidder requesting them (if applicable). These reports are not guaranteed as to accuracy or completeness. Before submitting a Bid each Bidder will, at its own expense, make such additional investigations and tests as the Bidder may deem necessary to determine the time, price, and other terms and conditions of the Contract Documents.

5.3 On request the City will provide each Bidder access to the site to conduct such investigations and tests as each Bidder deems necessary for submission of his Bid. The City may require any Bidder desiring access to execute an appropriate release form.

5.4 The lands upon which the work is to be performed, right-of-way for access thereto and other lands designated for use by Contractor in performing the work are identified in the Supplementary Conditions, Special Provisions, and/or Drawings.

5.5 The submission of a Bid will constitute an incontrovertible representation by the Bidder that: Bidder has read and understands the Bidding Documents and the Bid is made in accordance therewith; Bidder has visited the site and become familiar with the local conditions under which the work is to be performed; Bidder assumes responsibility for estimating properly the difficulties and costs of successfully performing the work; Bidder has complied with every requirement of these instructions; and that the Bidding Documents are sufficient in scope and detail to indicate and convey an understanding of all terms and conditions for performance of the Work.

## 6. AVAILABILITY OF LANDS.

6.1 Access to private property required by Contractor for staging areas, temporary facilities or other uses in addition to those identified in the Bidding or Contract Documents shall be obtained and paid for by Contractor. Such costs are to be considered incidental to the Contract and merged with Bid Items described and are to be provided without additional compensation to Contractor.

7. INTERPRETATIONS.

All questions about the meaning or intent of the Bidding Documents shall be submitted to Engineer in writing. Replies will be issued by Addenda mailed or delivered to all parties recorded by Engineer as having received the Bidding Documents. Questions received less than ten (10) days prior to the date for opening the Bids will not be answered. Only questions answered by formal written Addenda will be binding. Oral interpretations, clarifications, or comments are not binding upon the City, and do not serve to amend, modify, or in any way change the basic Bidding Documents, and shall be relied upon by Bidder at his own risk.

8. BID GUARANTY.

8.1 A Bid Guaranty in the form of a properly executed Bid Bond payable to the City in the amount of not less than 5% of the total base bid amount must accompany each bid. Pursuant to T.S. 12-4-201, in lieu of a Bid Bond, the following securities or cash may be substituted at the percentage rate required for such bond: United States treasury bond or general obligation bond or certificates of deposit irrevocably pledged from a state or national bank having its principle office in Tennessee or a state or federal saving and loan association having its principal office in Tennessee, or any state or national banks or state or federal savings and loans associations that has its principal office located outside of Tennessee and that maintains a branch in this state, or a letter of credit or cash. The successful Bidder will be required to execute an Agreement with the City, in the form supplied in the bidding documents, within thirty (30) days after Notice of Award is issued. The Notice of Award shall serve as notice that the Agreement is ready for execution. The Bid Guaranty shall be forfeited as liquidated damages if the Bidder fails to execute the Agreement within thirty (30) days after such Notice is issued, or fails to provide proper Bond or other form of Guaranty, as approved. The Bid Guaranty, if a Bid Bond, shall be executed by a surety or guarantee company authorized to do business in Tennessee. The Attorney-in-Fact who executes the Bond on behalf of the surety shall affix a certified and current copy of its Power of Attorney from the surety. No other type of Bid Guaranty will be accepted. The City may proceed against a Bid Guaranty unless either: a) the Agreement has been executed by Contractor and Performance, and Labor and Material Payment Bonds have been furnished, as required; or, b) the specified time has elapsed so that Bids may be withdrawn; or, c) the Bid has been rejected. .

8.2 The Bid Guaranty of the Successful Bidder will not be released unless and until such Bidder has executed the Agreement and furnished the required contract Bond(s). If the successful Bidder fails to execute and deliver the Agreement and furnish the required Contract Bonds within thirty (30) days of the Notice of Award, or fails to proceed with the performance of the Contract, the City may annul the Notice of Award and the Bid Guaranty of that Bidder will be forfeited as liquidated damages, it being agreed that exact damages are difficult or impossible to calculate, and the Bid Guaranty amount is the best estimate.

9. CONTRACT TIME.



The number of days within which, or the date by which, the Work is to be completed (the Contract Time) is set forth in the Bid Form and will be included in the Agreement.

10. LIQUIDATED DAMAGES.

Provisions for liquidated damages are to be set forth in the Agreement.

11. MATERIAL AND EQUIPMENT.

11.1 The materials, products, and equipment described in the Bidding Documents establish a standard or required function, dimension, appearance, and quality to be met by any proposed substitution.

11.2 Materials containing asbestos will not be accepted.

11.3 No substitution will be considered unless written request for approval has been submitted by the Bidder on an appropriate form, and has been received by the Engineer or the City's designated agent at least TEN (10) DAYS prior to the date for receipt of bids. Each such request shall include the name of the material or equipment for which it is to be substituted and a complete description of the proposed substitute including drawings, cuts, performance and test data, and any other information necessary for an evaluation. A statement setting forth any changes in other materials, equipment, or work that incorporation of the substitute would require, shall be included. The burden of proof of the merit and adequacy of a proposed substitute is upon the Bidder. The decision of approval or disapproval of a proposed substitution by the Engineer or the City's designated agent will be final.

If any proposed substitution is approved, such approval will be described in an addendum. Bidders shall not rely upon approvals made in any other manner.

11.4 When generic parameters for performance and/or appearance are specified, those materials which comply with specifics as delineated do not require a written request for approval. They must be capable of withstanding specification comparison, however, at the time of product data and shop drawing submittal.

12.5 Pursuant to T.S. 12-4-121, "Preference is hereby given to materials, supplies, equipment, machinery, and provisions produced, manufactured, supplied or grown in Tennessee, quality being equal to articles offered by the competitors outside of the State."

12. SUBCONTRACTORS, ETC.

12.1 If required by the City, the identity of certain Subcontractors and other persons and organizations shall be submitted to the City in advance of the Notice of Award. The apparent Successful Bidder, and any other Bidder so requested by the City, will within seven (7) days after the day of the Bid opening, submit to the City a list of names and addresses of all Subcontractors and

other persons and organizations whom Bidder proposes will furnish material and/or equipment for the Work. Such list shall be accompanied by an experience statement with pertinent information as to similar projects and other evidence of qualification for each Subcontractor, person, and organization if requested by the City. If the City or Engineer after due investigation has reasonable objection to any proposed Subcontractor, or other person, or organization, the City may, before giving the Notice of Award, request the apparent Successful Bidder to submit an acceptable substitute without an increase in Bid price. If the apparent Successful Bidder declines to make any such substitution and the Agreement is not awarded to such Bidder for that reason, the Bidder's refusal will not constitute grounds for forfeiting the Bid Guaranty. Any Subcontractor, other person, or organization so listed and to whom the City or Engineer does not make written objections prior to giving of the Notice of Award will be deemed acceptable to the Owner and Engineer.

### 13. BID FORM

13.1 The Bid Form is included with the Bidding Documents. Bidders shall bid all schedules and alternates (if any) as set forth in the Bid Form.

13.2 Bid Forms must be completed in ink or by typewriter. Corrections must be initialed by the Bidder. The Bid price of each item on the form must be stated in words and numerals; in case of a conflict, words will take precedence.

13.3 Bids by corporations or limited liability companies must be executed in the business entity's name by the president or a vice-president (or other officer or member accompanied by evidence of authority to sign), and the signature attested to by an authorized officer or member. The business entity's address and state of incorporation shall be shown below the signature.

13.4 Bids by partnerships must be executed in the partnership name and signed by a partner, whose title must appear under the signature. The official address of the partnership must be shown below the signature.

13.5 All names must be typed or printed below the signature.

13.6 The bid shall contain an acknowledgment of receipt of all Addenda (the numbers of which shall be filled in on the Bid Form). Failure to acknowledge receipt of Addenda shall not constitute an adjustment of the Contract Price provided on the Bid Form.

13.7 The address to which communications regarding the Bid are to be directed must be shown.

13.8 All items which are not specifically referred to in the Bid Form but are included in the plans or specifications are to be considered incidental to the performance of the major work described and shall be constructed as indicated on the plans or called for in the specifications without additional remuneration.

14. SUBMISSION OF BIDS.

14.1 Bids shall be submitted not later than the time and at the place indicated in the Advertisement for Bids and shall be included in an opaque sealed envelope, marked with the Project title and name and address of the Bidder and accompanied by the Bid Guaranty and other required documents. If the Bid is sent through the mail or other delivery system, the sealed envelope shall be enclosed in a separate envelope with the notation "BID ENCLOSED" on the face thereof. All bidding information shall be included in the sealed envelope.

**14.2 Contractors' Licenses, Bids** Contractors and electrical, plumbing, and HVAC subcontractors who do jobs costing \$25,000 or more must be licensed by the state (T.C.A. § 62-6-102, T.C.A. § 62-6-111). Officials issuing a permit or work order to an unlicensed contractor are guilty of a Class A misdemeanor (T.C.A. § 62-6-120). The name, license number, license expiration date, and classification of contractors applying to bid on jobs must appear on the bid envelope when the bid is more than \$25,000. If the bid is less than \$25,000, only the name of the contractor must appear on the outside of the envelope. Upon opening the envelope, if the bid exceeds \$25,000, the bid is automatically disqualified (T.C.A. § 62-6-119(b)). The name of a prime contractor who does electrical, plumbing, heating, ventilation, and air conditioning must appear on the outside of the envelope. Failure of a bidder to comply voids the bid, and it may not be opened. It is a Class A misdemeanor for any person to disregard the above requirements. Municipalities may not impose additional licensing requirements on state-licensed contractors (T.C.A. § 62-6-111(i)(2)(c)). T.C.A. § 62-6-137, however, allows municipalities to require a permit bond for contractors to ensure that the contractor complies with applicable laws and ordinances. Approving the permit bond program requires a two-thirds vote of the governing body.

15. MODIFICATION AND WITHDRAWAL OF BIDS.

15.1 Bids may be modified or withdrawn by an appropriate document duly executed (in the same manner that a Bid must be executed) and delivered to the place where Bids are to be submitted at any time prior to the opening of Bids.

15.2 If, within twenty-four (24) hours after Bids are opened, any bidder files a duly signed written notice with the City and promptly thereafter demonstrates to the satisfaction of the City that there was a material and substantial mistake in the preparation of his Bid, that Bidder may withdraw its Bid and the Bid Guaranty will be returned. Thereafter, that Bidder will be disqualified from further bidding on the Work.

16. OPENING OF BIDS.

Bids will be opened publicly and read aloud. An abstract of the bid schedule will be made available after the opening of Bids.

17. BIDS TO REMAIN EFFECTIVE.

All Bids not modified or withdrawn as provided in Section 16, shall remain effective for thirty (30) days after the day of the Bid opening, but the Owner may, in its sole discretion, release any Bid and return the Bid Guaranty prior to that date.

18. AWARD OF CONTRACT.

18.1 The City reserves the right to reject any and all Bids; to waive any and all irregularities or informalities; to negotiate specific contract terms not inconsistent with the Advertisement for Bids, with the Successful Bidder; and to disregard all nonconforming, nonresponsive, unbalanced, or conditional Bids. Discrepancies between words and numerals will be resolved in favor of words. Discrepancies between the indicated sum of any column of numerals and the correct sum thereof will be resolved in favor of the correct sum.

18.2 A Bidder shall bid all schedules and alternates (if any) as set forth in the Bid Form. The City reserves the right in awarding the Agreement to consider the competency, responsibility, and suitability of the Bidder, as well as the amounts of the various bids. The Work, therefore, may not necessarily be awarded to the low bidder.

18.3 In evaluating Bids, the Owner reserves the right to limit the scope of the project to the monies available for the project.

18.4 The Owner may consider, among other things, the qualifications and experience of Subcontractors and other persons and organizations who are proposed to furnish material or equipment for the Work; operating costs; maintenance considerations; performance data; and guarantees of materials and equipment.

18.5 The Owner may conduct such investigations as it deems necessary to assist in the evaluation of any Bid and to establish the responsibility, qualification, and financial ability of the Bidders, proposed Subcontractors, and other persons and organizations proposed to do the Work in accordance with the Bidding Documents.

18.6 If the Agreement is to be awarded, it will be to the lowest Bidder who is determined qualified and responsible in the sole discretion and best interest of the City. The low bid shall be determined based upon an evaluation of the Total Base Bid. The City reserves the right to accept or reject alternates in any order or combination; and to accept or reject any schedule or all schedules.

If the low bid is to be awarded in any other manner, applicable laws must be consulted and the above paragraphs must be modified.

18.7 If the Agreement is to be awarded, the Owner will give the Successful Bidder a Notice of Award within thirty (30) Days after the day of the Bid opening.

19. PERFORMANCE AND PAYMENT BONDS AND INSURANCE CERTIFICATES.

The General and Supplementary Conditions set forth the City's requirements as to Performance and Payment Bonds and Insurance Certificate(s). When the Successful Bidder delivers the executed Agreement to the Owner, it shall be accompanied by the required Bonds and Insurance Certificate(s).

19.1 Pursuant to T.S. 12-4-201, no contract shall be let for any public work in this state, by any city, county or state authority, until the contractor shall have first executed a good and solvent bond to the effect that the contractor will pay for all the labors and materials used by the contractor, or any immediate or remote subcontractor under the contractor, in such contract, in lawful money of the United States. The bond to be so given shall be for twenty-five (25%) of the contract price on all contracts in excess of one hundred thousand dollars (\$100,000). Where advertisement is made, the condition of the bond shall be stated in advertisement; provided that T.S. 12-4-201 shall not apply to contracts of one hundred thousand dollars (\$100,000) or less.

20. SIGNING OF AGREEMENT.

When the City gives a Notice of Award to the Successful Bidder, it will be accompanied by one (1) unsigned counterpart of the Agreement and the Performance and Payment Bonds. Within thirty (30) days thereafter, Contractor shall comply with the conditions precedent in the Notice of Award. Within ten (10) days thereafter, the City will deliver one (1) fully signed counterpart to Contractor. The City will deliver one signed copy of the Agreement within the project manual.

Notes:

Revised 10.11.09 paragraph 14.1 and 14.2

EXHIBIT "A"  
STANDARD  
BID FORM

PROJECT IDENTIFICATION:      City of Lakeland, Tennessee  
Project Description: Woodbridge Drainage Improvements

THIS BID SUBMITTED TO:      City of Lakeland, Tennessee  
10001 U.S. Highway 70  
Lakeland, Tennessee 38002

1. The undersigned Bidder proposes and agrees, if this Bid is accepted, to enter into an Agreement with the City in the form included in the Bidding Documents and to complete all Work as specified or indicated in the Bidding Documents for the Contract Price by June 23, 2017, and completed and ready for final payment not later than June 30, 2017, in accordance with the Bidding Documents.
2. Bidder accepts all of the terms and conditions of the Advertisement for Bids and Instructions to Bidders, including without limitation those dealing with the disposition of Bid Guaranty. This Bid will remain effective for thirty (30) days after the day of Bid opening. Bidder will sign the Agreement and submit the Bonds and other documents required by the Bidding Documents within thirty (30) days after the date of the City's Notice of Award.
3. Notice that preferences will be granted pursuant to Tennessee Statutes is hereby acknowledged.
4. In submitting this Bid, Bidder represents, as more fully set forth in the Bidding Documents, that:
  - A. Bidder has examined copies of all the Bidding Documents and of the following addenda (receipt of all which is hereby acknowledged):  

Addendum No. _____	Dated _____
Addendum No. _____	Dated _____
  - B. Bidder has examined the site and locality where the work is to be performed, the federal, state, and local Laws and Regulations, and the conditions affecting cost, progress, or performance of the work and has made such independent investigations as Bidder deems necessary;

- C. This Bid is genuine and not made in the interest of or on behalf of any undisclosed person, firm, corporation, or other business entity. Bidder has not directly or indirectly induced or solicited any other Bidder to submit a false or sham Bid. Bidder has not solicited or induced any person, firm, or a corporation to refrain from bidding. Bidder has not sought by collusion to obtain for itself any advantage over any other Bidder or against the City.
- D. Each bidder and each person signing on behalf of any bidder certifies, and in the case of a joint bid each party thereto certifies as to its organization, under penalty of perjury, that to the best of its knowledge and belief that each bidder is not on the list created pursuant to Tennessee Statute 12-12-106

5. Bidder is bidding all schedules, alternates, if any, and will complete the Work for unit price(s) stated on the attached bid schedule based on materials actually furnished and installed and services actually provided. The Bid is summarized below on the basis of estimated quantities:

TOTAL BASE BID, IN NUMERALS: \$\_\_\_\_\_

TOTAL BASE BID, IN WORDS: \_\_\_\_\_  
 \_\_\_\_\_ DOLLARS.

- 7. Bidder agrees that the work for the City will be as provided above.
- 8. Bidder accepts the provisions of the Bidding Documents as to liquidated damages in the event of failure to complete the work on time, unless otherwise stated as provided below. Bidder agrees that such liquidated damages are not a penalty and that the amount provided is as close an estimate as possible to actual damages. Any exceptions or objections to this provision are stated in writing and attached hereto by Bidder.
- 9. The following documents are attached to and made a condition of this Bid:
  - A. Required Bid Guaranty in the form of a Bid Bond. (Unless otherwise provided by the City.)
  - B. Itemized Bid Schedule.
- 10. Communications concerning this Bid shall be addressed to:

Address of Bidder: \_\_\_\_\_  
 \_\_\_\_\_  
 \_\_\_\_\_

11. The terms used in this Bid are defined in and have the meanings assigned to them in the General Conditions, except as provided in the Supplementary Conditions and Bidding Documents.

Submitted on \_\_\_\_\_, 2017.

Bidder is bidding as a \_\_\_\_\_ (Insert Resident or Non-Resident)

IF BIDDER IS:

AN INDIVIDUAL

By: \_\_\_\_\_ (seal)  
(Individual's Name)

doing business as: \_\_\_\_\_

Business Address: \_\_\_\_\_  
\_\_\_\_\_  
\_\_\_\_\_

Phone Number: \_\_\_\_\_

A PARTNERSHIP

By: \_\_\_\_\_ (seal)  
(Firm's Name)

\_\_\_\_\_  
(General Partner)

Business Address: \_\_\_\_\_  
\_\_\_\_\_  
\_\_\_\_\_

Phone Number: \_\_\_\_\_



A CORPORATION OR LIMITED LIABILITY COMPANY

By: \_\_\_\_\_ (seal)  
(Corporation's or Limited Liability Company's Name)

\_\_\_\_\_  
(State of Incorporation or Organization)

By: \_\_\_\_\_ (seal)

(Title)

(Seal)

Attest: \_\_\_\_\_

Business Address: \_\_\_\_\_  
\_\_\_\_\_  
\_\_\_\_\_

Phone Number: \_\_\_\_\_

A JOINT VENTURE

By: \_\_\_\_\_ (seal)  
(Name)

\_\_\_\_\_  
(Address)

By: \_\_\_\_\_ (seal)  
(Name)

\_\_\_\_\_  
(Address)

(Each joint venturer must sign. The manner of signing for each individual, partnership, and corporation that is a party to the joint venture should be in the manner indicated above.)

## Bid Schedule Woodbridge Drainage Improvements

BID DATE: \_\_\_\_\_  
 COMPANY NAME: \_\_\_\_\_  
 ADDRESS: \_\_\_\_\_

Contractor shall furnish and install items as shown on the Drawings or called for in the Specifications. All costs not included in the schedule that are necessary to provide a complete, functional project as depicted in the Drawings and Specifications are to be considered incidental and merged with costs of other related bid items.

LS = Lump Sum    R&R = Remove and Replace    LF = Linear Feet    F&I = Furnish and Install    SYI = Square Yard Inch  
 SY = Square Yard    FA = Force Account    CY = Cubic Yard    EA = Each    Ton = Ton

### Schedule A -

ITEM	DESCRIPTION	UNIT	QUANTITY	UNIT COST	TOTAL COST
1	Clearing and Grubbing	LS	1		
2	Earthwork	LS	1		
3	F&I 15" Reinforced Concrete Pipe (Class III)	LF	598		
4	F&I 3070 Inlet	EA	7		
5	F&I 3x3 Inlet	EA	2		
6	F&I Granular Foundation (No. 57)	CY	3		
7	F&I Select Backfill (Sand)	CY	200		
8	R&R Concrete Sidewalk	LF	20		
9	R&R Asphalt Pavement	SF	100		
10	F&I Granular Base (LA610)	CY	10		
11	R&R Concrete Curb and Gutter	LF	20		
12	R&R Fencing	LF	200		
13	F&I Bermuda Sod	SY	700		
14	F&I Zoysia Sod	SY	50		
15	F&I Temporary Construction Exit	EA	2		
16	F&I Inlet Protection	EA	10		
17	F&I Type C Silt Fence	LF	1200		
18	F&I Temporary Traffic Control	LS	1		
19	Construction Survey and Staking	LS	1		
Total Bid Schedule A					

Total Base Bid : \_\_\_\_\_  
 \_\_\_\_\_ Dollars (\$ \_\_\_\_\_).

STANDARD  
BID BOND

KNOW ALL MEN BY THESE PRESENTS, that we, the undersigned, \_\_\_\_\_ as Principal, and \_\_\_\_\_ as Surety, are hereby held and firmly bound, unto the City of Lakeland, Tennessee a Municipal Corporation as OWNER, in the penal sum of \_\_\_\_\_ Dollar(s) (\$ \_\_\_\_\_) for the payment of which, well and truly to be made, we hereby jointly and severally bind ourselves, successors and assigns, which represents five percent (5%) of the Principal's Total Base Bid.

The Condition of the above obligation is such that whereas the Principal has submitted to the City of Lakeland, Tennessee a certain BID, whereby it has offered to enter into an Agreement in writing with OWNER, for Woodbridge Drainage Improvements

NOW, THEREFORE,

A. If said BID shall be rejected; or,

B. If said BID shall be accepted and the Principal shall execute and deliver the Agreement to OWNER within thirty (30) days after Notice of Award (which shall constitute presentation of the Agreement to the Principal for the purpose of execution) and shall furnish Guarantors as provided in the Bidding Documents for this Project for Principal's faithful performance of said Agreement and for the payment of all persons performing labor or furnishing materials in connection therewith, and shall otherwise proceed with the performance of said Agreement, then this obligation shall be void, otherwise the same shall remain in full force and effect and OWNER may proceed against the BOND. It is expressly understood and agreed, however, that the liability of Surety for any and all claims hereunder shall, in no event, exceed the penal amount of this obligation as herein stated.

The Surety, for value received, hereby stipulates and agrees that the obligations of said Surety and its BOND shall be in no way impaired or affected by an extension of the time within which the OWNER may accept such BID, to a maximum of ninety (90) days after its submission to OWNER; and said Surety does hereby waive notice of any such extension.

IN WITNESS WHEREOF, the Principal and the Surety have hereunto set their hands and seals, and such of them as are corporations have caused their corporate seals to be hereto affixed and these presents to be signed by their proper officers, this \_\_\_\_ day of \_\_\_\_\_, 2017.



STANDARD FORM OF  
AGREEMENT BETWEEN OWNER AND CONTRACTOR

THIS AGREEMENT is made between the City of Lakeland, hereinafter referred to as the "Owner," and \_\_\_\_\_, hereinafter referred to as the "Contractor."

WHEREAS, the City of Lakeland is desirous of drainage improvements in Woodbridge Subdivision; and,

WHEREAS, \_\_\_\_\_, is able and willing to provide those services to the City of Lakeland, Tennessee.

NOW, THEREFORE, it is hereby agreed as follows:

ARTICLE 1. WORK.

Contractor shall perform all the work required by the Contract documents for Woodbridge Drainage Improvements, Lakeland, Tennessee.

ARTICLE 2. ENGINEER.

The Project has been designed by the City of Lakeland Engineering Office, 10001 U.S. Highway 70, Lakeland, Tennessee, who is hereinafter referred to as the "Engineer" and who is to act as Owner's representative, assume all duties and responsibilities and have the rights and authority assigned to Engineer in the Contract documents in connection with completion of the Work in accordance with the Contract documents.

ARTICLE 3. CONTRACT TIME.

- 3.1 The Work will be substantially completed by June 23, 2017, and completed and ready for final payment in accordance with Paragraph 15.06 of the General Conditions by June 30, 2017.
- 3.2 Liquidated Damages. Owner and Contractor recognize that time is of the essence of this Agreement and that Owner will suffer financial loss if the Work is not substantially completed by the time specified in Paragraph 3.1 above, plus any extension thereof allowed in accordance with Article 15 of the General Conditions. They also recognize the delays, expense, and difficulties involved in proving in a legal or arbitration proceeding, the actual loss suffered by Owner if the Work is not substantially completed on time. Accordingly, instead of requiring any such proof, Owner and Contractor agree that as liquidated damages for delay (but not as a penalty) Contractor shall pay Owner one Hundred Dollars (\$100.00) for each day that expires after the time specified in Paragraph 3.1 for substantial completion. After Substantial Completion, if the Contractor shall neglect, refuse, or fail to complete the remaining work within the time specified in paragraph 3.1

for completion and readiness for final payment or any proper extension thereof granted by Owner, Contractor shall pay Owner One Hundred Dollars (\$100.00) for each day that expires after the time specified in paragraph 3.1 for completion and readiness for final payment. It is further agreed that such liquidated damages are not a penalty, but represent the parties' best estimate of actual damages.

#### ARTICLE 4. CONTRACT PRICE.

In Consideration of the performance of the work in accordance with the Contract documents for this Unit Price Contract, Owner shall pay Contractor in current funds a not-to-exceed total contract price of \_\_\_\_\_ Dollars (\$ \_\_\_\_\_), subject to additions and deductions by Change Order approved by the Owner. The contract fee shall be based on materials actually furnished and installed and services actually provided based on the unit prices contained in the Bid Form and Itemized Bid Schedule, included as Exhibit "A" (pages BF-1 -- BS-1) and by this reference made a part of this Agreement.

#### ARTICLE 5. PAYMENT PROCEDURES.

Contractor shall submit Applications for Payment in accordance with Article 15 of the General Conditions. Applications for Payment will be processed through the Engineer as provided in the General Conditions.

- 5.1 Progress Payments. Owner shall make progress payments on the basis of Contractor's Applications for Payment as recommended by Engineer, on or about the 25th day of each month during construction as provided below. All progress payments will be on the basis of the progress of the Work measured by the Schedule of Values provided for in Paragraph 15 of the General Conditions, subject to the cutoff and submittal dates provided in the General Provisions.
  - 5.1.1 During the course of the Contract progress payments will be made in an amount equal to 95% of the Work completed, less in each case the aggregate of payments previously made.
  - 5.1.2 In the event the Contractor makes only one application for payment upon substantially completing the Work, progress payment will be made in an amount equal to 95% of the Work completed. Owner shall withhold five percent (5%) of the work completed as retainage, said retainage to be paid in accordance with the provisions of Paragraph 5.2, Final Payment.
- 5.2 Final Payment. Upon final completion and acceptance of the Work in accordance with Paragraph 15.06 of the General Conditions, Engineer shall recommend payment and present Contractor's Final Application for Payment to the City in accordance with Tennessee Statutes 54-5-122. Before final acceptance of the project as having been finally completed, the contractor shall furnish evidence of payment in full for materials and labor to the City in accordance with Tennessee 54-5-122. When this is done, full settlement may be made with the contractor, but not until thirty (30) day's notice is some newspaper published in the county where the work is done, if there is a

newspaper there, and if not, in a newspaper in an adjoining county that settlement is about to be made and notifying all claimants to file notice of their claims with the officials and the period for filing shall not be less than thirty (30) days after the last published notice. In the event claims are filed, the officials shall withhold a sufficient sum to pay the claims in the same way and manner as is provided for claimants making claims against contractors dealing with the Department of Transportation in accordance with Statutes 54-5-123, and claimants may bring suits against contractors in the way and manner provided in 54-5-124, as suits are brought against contractors dealing with the department. Where claims are allowed by the Courts, Statutes 54-5-125 and 54-5-127 shall be applicable.

#### ARTICLE 6. WITHHELD FUNDS.

Pursuant to Tennessee Statutes Section 66-11-104 et seq., withheld percentages for Contracts exceeding \$500,000.00 will be retained in an account in the name of the Contractor (except when specifically waived in writing by Contractor) which has been assigned to the Owner until the Contract is completely, satisfactorily, and finally accepted by the Owner. Unless a depository is designated by the Contractor in a written attachment hereto, the Contractor's signature hereon shall act as authority for the Owner to designate a retainage depository on behalf of the Contractor, for the purposes specified in Tennessee Statutes Section 66-11-104. The Contractor's signature hereon shall act as an assignment of the depository account to the Owner, as provided by Tennessee Statutes Section 66-11-104 et seq., whether the depository is designated by the Contractor or by the Owner.

#### ARTICLE 7. CONTRACTOR'S REPRESENTATIONS.

In order to induce Owner to enter into this Agreement, Contractor makes the following representations:

- 7.1 Contractor has familiarized himself with the nature and extent of the Contract documents, Work, locality, and with all local conditions and federal, state, and local Laws and Regulations that in any manner may affect cost, progress, or performance of the Work.
- 7.2 Contractor has studied carefully all reports of investigations and test of subsurface and latent physical conditions at the site or otherwise affecting cost, progress, or performance of the Work which were relied upon by Engineer in the preparation of the Drawings and Specifications and which have been identified in the Supplementary Conditions.
- 7.3 Contractor has made or caused to be made examinations, investigations, and test and studies as he deems necessary for the performance of the Work at the Contract price, within the Contract Time, and in accordance with the other terms and conditions of the Contract documents; and no additional examinations, investigations, tests, reports, or similar data are or will be required by Contractor for such purposes.

- 7.4 Contractor has correlated the results of all such observations, examinations, investigations, tests, reports, and data with the terms and conditions of the Contract documents.
- 7.5 Contractor has given Engineer written notice of all conflicts, errors, or discrepancies that he has discovered in the Contract documents and the written resolution thereof by Engineer is acceptable to Contractor.

#### ARTICLE 8. CONTRACT DOCUMENTS.

The Contract documents which comprise the entire agreement between Owner and Contractor are attached to this Agreement, made a part hereof and consist of the following:

- 8.1 This Agreement (Pages SFA-1 to SFA-5, inclusive).
- 8.2 Joint Account Agreement or Letter of Forfeiture waiving same (if applicable)
- 8.3 Exhibit "A" - Bid Form and Bid Schedule.
- 8.4 Affidavit of Drug Free Work Program
- 8.5 Addenda
- 8.6 Performance Bond
- 8.7 Certificates of Insurance, of Workers' Compensation Coverage, and of Unemployment Insurance Coverage.
- 8.8 2013 Standard General Conditions of the Construction Contract (Pages i to 62, inclusive).
- 8.8 Standard Supplementary Conditions (Pages SSC-1 to SSC-16, inclusive).
- 8.9 General Requirements, consisting of seven (7) sections
- 8.10 Special Provisions (Section 01810)
- 8.11 Technical Specifications consisting of seven (7) sections
- 8.12 Notice of Award.
- 8.13 Notice to Proceed.
- 8.14 Minutes of the Pre-Bid Conference, if any.



- 8.15 Shop Drawings and other Submittals furnished by Contractor during performance of the Work and accepted by the Owner.
- 8.16 Any modifications, amendments, and supplements, including Change Orders, issued pursuant to Article 11 of the General Conditions, on or after the effective date of this Agreement.
- 8.17 Notice of Substantial Completion.

**ARTICLE 9. MISCELLANEOUS PROVISIONS.**

9.1 The CONTRACTOR hereby agrees, warrants, and assures compliance with the provisions of Title VI and VII of the Civil Rights Act of 1964 and all other federal statutory laws which provide in whole or in part that no person shall be excluded from participation or be denied benefits of or be otherwise subjected to discrimination in the performance of this Contract or in the employment practices of the CONTRACTOR on the grounds of handicap and/or disability, age, race, color, religion, sex, national origin, or any other classification protected by federal, Tennessee State Constitutional or statutory law. The CONTRACTOR shall upon request show proof of such non-discrimination and shall post in conspicuous places available to all employees and applicants notices of non-discrimination.

Terms used in this Agreement, which are defined in the General Conditions, shall have the meanings designated in those conditions.

IN WITNESS WHEREOF, the parties hereto have caused this Agreement to be executed in one (1) original copy on the day and year first above written.

APPROVED AS TO FORM:

(PROJECT: \_\_\_\_\_ )

DATED this \_\_\_\_\_ day of \_\_\_\_\_, 2017

ATTEST:

CONTRACTOR:

\_\_\_\_\_  
 \_\_\_\_\_  
 \_\_\_\_\_

By: \_\_\_\_\_

By: \_\_\_\_\_

Title: \_\_\_\_\_

Title: \_\_\_\_\_

ATTEST:

By: \_\_\_\_\_  
Jessica Millspaugh  
Title: City Recorder

OWNER:  
CITY OF LAKELAND, TENNESSEE  
A Municipal Corporation

By: \_\_\_\_\_  
Wyatt Bunker  
Title: Mayor

## PERFORMANCE BOND

CONTRACTOR *(name and address):*

SURETY *(name and address of principal place of business):*

OWNER *(name and address):*

City of Lakeland  
10001 Highway 70, Lakeland, TN 38002

### CONSTRUCTION CONTRACT

Effective Date of the Agreement:

Amount:

Description *(name and location):* Woodbridge Drainage Improvements

### BOND

Bond Number:

Date *(not earlier than the Effective Date of the Agreement of the Construction Contract):*

Amount:

Modifications to this Bond Form:  None  See Paragraph 16

Surety and Contractor, intending to be legally bound hereby, subject to the terms set forth below, do each cause this Performance Bond to be duly executed by an authorized officer, agent, or representative.

### CONTRACTOR AS PRINCIPAL

### SURETY

\_\_\_\_\_  
Contractor's Name and Corporate Seal *(seal)*

\_\_\_\_\_  
Surety's Name and Corporate Seal *(seal)*

By: \_\_\_\_\_  
Signature

By: \_\_\_\_\_  
Signature *(attach power of attorney)*

\_\_\_\_\_  
Print Name

\_\_\_\_\_  
Print Name

\_\_\_\_\_  
Title

\_\_\_\_\_  
Title

Attest: \_\_\_\_\_  
Signature

Attest: \_\_\_\_\_  
Signature

\_\_\_\_\_  
Title

\_\_\_\_\_  
Title

**Notes: (1) Provide supplemental execution by any additional parties, such as joint venturers. (2) Any singular reference to Contractor, Surety, Owner, or other party shall be considered plural where applicable.**

1. The Contractor and Surety, jointly and severally, bind themselves, their heirs, executors, administrators, successors, and assigns to the Owner for the performance of the Construction Contract, which is incorporated herein by reference.

2. If the Contractor performs the Construction Contract, the Surety and the Contractor shall have no obligation under this Bond, except when applicable to participate in a conference as provided in Paragraph 3.

3. If there is no Owner Default under the Construction Contract, the Surety's obligation under this Bond shall arise after:

3.1 The Owner first provides notice to the Contractor and the Surety that the Owner is considering declaring a Contractor Default. Such notice shall indicate whether the Owner is requesting a conference among the Owner, Contractor, and Surety to discuss the Contractor's performance. If the Owner does not request a conference, the Surety may, within five (5) business days after receipt of the Owner's notice, request such a conference. If the Surety timely requests a conference, the Owner shall attend. Unless the Owner agrees otherwise, any conference requested under this Paragraph 3.1 shall be held within ten (10) business days of the Surety's receipt of the Owner's notice. If the Owner, the Contractor, and the Surety agree, the Contractor shall be allowed a reasonable time to perform the Construction Contract, but such an agreement shall not waive the Owner's right, if any, subsequently to declare a Contractor Default;

3.2 The Owner declares a Contractor Default, terminates the Construction Contract and notifies the Surety; and

3.3 The Owner has agreed to pay the Balance of the Contract Price in accordance with the terms of the Construction Contract to the Surety or to a contractor selected to perform the Construction Contract.

4. Failure on the part of the Owner to comply with the notice requirement in Paragraph 3.1 shall not constitute a failure to comply with a condition precedent to the Surety's obligations, or release the Surety from its obligations, except to the extent the Surety demonstrates actual prejudice.

5. When the Owner has satisfied the conditions of Paragraph 3, the Surety shall promptly and at the Surety's expense take one of the following actions:

5.1 Arrange for the Contractor, with the consent of the Owner, to perform and complete the Construction Contract;

5.2 Undertake to perform and complete the Construction Contract itself, through its agents or independent contractors;

5.3 Obtain bids or negotiated proposals from qualified contractors acceptable to the Owner for a contract for performance and completion of the Construction Contract, arrange for a contract to be prepared for execution by the Owner and a contractor selected with the Owners concurrence,

to be secured with performance and payment bonds executed by a qualified surety equivalent to the bonds issued on the Construction Contract, and pay to the Owner the amount of damages as described in Paragraph 7 in excess of the Balance of the Contract Price incurred by the Owner as a result of the Contractor Default; or

5.4 Waive its right to perform and complete, arrange for completion, or obtain a new contractor, and with reasonable promptness under the circumstances:

5.4.1 After investigation, determine the amount for which it may be liable to the Owner and, as soon as practicable after the amount is determined, make payment to the Owner; or

5.4.2 Deny liability in whole or in part and notify the Owner, citing the reasons for denial.

6. If the Surety does not proceed as provided in Paragraph 5 with reasonable promptness, the Surety shall be deemed to be in default on this Bond seven days after receipt of an additional written notice from the Owner to the Surety demanding that the Surety perform its obligations under this Bond, and the Owner shall be entitled to enforce any remedy available to the Owner. If the Surety proceeds as provided in Paragraph 5.4, and the Owner refuses the payment or the Surety has denied liability, in whole or in part, without further notice the Owner shall be entitled to enforce any remedy available to the Owner.

7. If the Surety elects to act under Paragraph 5.1, 5.2, or 5.3, then the responsibilities of the Surety to the Owner shall not be greater than those of the Contractor under the Construction Contract, and the responsibilities of the Owner to the Surety shall not be greater than those of the Owner under the Construction Contract. Subject to the commitment by the Owner to pay the Balance of the Contract Price, the Surety is obligated, without duplication for:

7.1 the responsibilities of the Contractor for correction of defective work and completion of the Construction Contract;

7.2 additional legal, design professional, and delay costs resulting from the Contractor's Default, and resulting from the actions or failure to act of the Surety under Paragraph 5; and

7.3 liquidated damages, or if no liquidated damages are specified in the Construction Contract, actual damages caused by delayed performance or non-performance of the Contractor.

8. If the Surety elects to act under Paragraph 5.1, 5.3, or 5.4, the Surety's liability is limited to the amount of this Bond.

9. The Surety shall not be liable to the Owner or others for obligations of the Contractor that are unrelated to the Construction Contract, and the Balance of the Contract Price shall not be reduced or set off on account of any such unrelated obligations. No right of action shall accrue on this Bond to any person or entity other than the Owner or its heirs, executors, administrators, successors, and assigns.

10. The Surety hereby waives notice of any change, including changes of time, to the Construction Contract or to related subcontracts, purchase orders, and other obligations.

11. Any proceeding, legal or equitable, under this Bond may be instituted in any court of competent jurisdiction in the location in which the work or part of the work is located and shall be instituted within two years after a declaration of Contractor Default or within two years after the Contractor ceased working or within two years after the Surety refuses or fails to perform its obligations under this Bond, whichever occurs first. If the provisions of this paragraph are void or prohibited by law, the minimum periods of limitations available to sureties as a defense in the jurisdiction of the suit shall be applicable.

12. Notice to the Surety, the Owner, or the Contractor shall be mailed or delivered to the address shown on the page on which their signature appears.

13. When this Bond has been furnished to comply with a statutory or other legal requirement in the location where the construction was to be performed, any provision in this Bond conflicting with said statutory or legal requirement shall be deemed deleted herefrom and provisions conforming to such statutory or other legal requirement shall be deemed incorporated herein. When so furnished, the intent is that this Bond shall be construed as a statutory bond and not as a common law bond.

#### 14. Definitions

14.1 Balance of the Contract Price: The total amount payable by the Owner to the Contractor under the Construction Contract after all proper adjustments have been made including allowance for the Contractor for any amounts received or to be received by the Owner in settlement of insurance or other claims

for damages to which the Contractor is entitled, reduced by all valid and proper payments made to or on behalf of the Contractor under the Construction Contract.

14.2 Construction Contract: The agreement between the Owner and Contractor identified on the cover page, including all Contract Documents and changes made to the agreement and the Contract Documents.

14.3 Contractor Default: Failure of the Contractor, which has not been remedied or waived, to perform or otherwise to comply with a material term of the Construction Contract.

14.4 Owner Default: Failure of the Owner, which has not been remedied or waived, to pay the Contractor as required under the Construction Contract or to perform and complete or comply with the other material terms of the Construction Contract.

14.5 Contract Documents: All the documents that comprise the agreement between the Owner and Contractor.

15. If this Bond is issued for an agreement between a contractor and subcontractor, the term Contractor in this Bond shall be deemed to be Subcontractor and the term Owner shall be deemed to be Contractor.

16. Modifications to this Bond are as follows:

# PAYMENT BOND

Any singular reference to Contractor, Surety, Owner, or other party shall be considered plural where applicable.

CONTRACTOR (*Name and Address*):

SURETY (*Name, and Address of Principal Place of Business*):

OWNER (*Name and Address*):

## CONTRACT

Effective Date of Agreement:

Amount:

Description (*Name and Location*):

## BOND

Bond Number:

Date (*Not earlier than Effective Date of Agreement*):

Amount:

Modifications to this Bond Form:

Surety and Contractor, intending to be legally bound hereby, subject to the terms set forth below, do each cause this Payment Bond to be duly executed by an authorized officer, agent, or representative.

## CONTRACTOR AS PRINCIPAL

## SURETY

\_\_\_\_\_  
Contractor's Name and Corporate Seal (Seal)

\_\_\_\_\_  
Surety's Name and Corporate Seal (Seal)

By: \_\_\_\_\_  
Signature

By: \_\_\_\_\_  
Signature (Attach Power of Attorney)

\_\_\_\_\_  
Print Name

\_\_\_\_\_  
Print Name

\_\_\_\_\_  
Title

\_\_\_\_\_  
Title

Attest: \_\_\_\_\_  
Signature

Attest: \_\_\_\_\_  
Signature

\_\_\_\_\_  
Title

\_\_\_\_\_  
Title

*Note: Provide execution by additional parties, such as joint venturers, if necessary.*

1. Contractor and Surety, jointly and severally, bind themselves, their heirs, executors, administrators, successors, and assigns to Owner to pay for labor, materials, and equipment furnished by Claimants for use in the performance of the Contract, which is incorporated herein by reference.
2. With respect to Owner, this obligation shall be null and void if Contractor:
  - 2.1 Promptly makes payment, directly or indirectly, for all sums due Claimants, and
  - 2.2 Defends, indemnifies, and holds harmless Owner from all claims, demands, liens, or suits alleging non-payment by Contractor by any person or entity who furnished labor, materials, or equipment for use in the performance of the Contract, provided Owner has promptly notified Contractor and Surety (at the addresses described in Paragraph 12) of any claims, demands, liens, or suits and tendered defense of such claims, demands, liens, or suits to Contractor and Surety, and provided there is no Owner Default.
3. With respect to Claimants, this obligation shall be null and void if Contractor promptly makes payment, directly or indirectly, for all sums due.
4. Surety shall have no obligation to Claimants under this Bond until:
  - 4.1 Claimants who are employed by or have a direct contract with Contractor have given notice to Surety (at the address described in Paragraph 12) and sent a copy, or notice thereof, to Owner, stating that a claim is being made under this Bond and, with substantial accuracy, the amount of the claim.
  - 4.2 Claimants who do not have a direct contract with Contractor:
    1. Have furnished written notice to Contractor and sent a copy, or notice thereof, to Owner, within 90 days after having last performed labor or last furnished materials or equipment included in the claim stating, with substantial accuracy, the amount of the claim and the name of the party to whom the materials or equipment were furnished or supplied, or for whom the labor was done or performed; and
    2. Have either received a rejection in whole or in part from Contractor, or not received within 30 days of furnishing the above notice any communication from Contractor by which Contractor had indicated the claim will be paid directly or indirectly; and
    3. Not having been paid within the above 30 days, have sent a written notice to Surety (at the address described in Paragraph 12) and sent a copy, or notice thereof, to Owner, stating that a claim is being made under this Bond and enclosing a copy of the previous written notice furnished to Contractor.
5. If a notice by a Claimant required by Paragraph 4 is provided by Owner to Contractor or to Surety, that is sufficient compliance.
6. Reserved.
7. Surety's total obligation shall not exceed the amount of this Bond, and the amount of this Bond shall be credited for any payments made in good faith by Surety.
8. Amounts owed by Owner to Contractor under the Contract shall be used for the performance of the Contract and to satisfy claims, if any, under any performance bond. By Contractor furnishing and Owner accepting this Bond, they agree that all funds earned by Contractor in the performance of the Contract are dedicated to satisfy obligations of Contractor and Surety under this Bond, subject to Owner's priority to use the funds for the completion of the Work.
9. Surety shall not be liable to Owner, Claimants, or others for obligations of Contractor that are unrelated to the Contract. Owner shall not be liable for payment of any costs or expenses of any Claimant under this Bond, and shall have under this Bond no obligations to make payments to, give notices on behalf of, or otherwise have obligations to Claimants under this Bond.

10. Surety hereby waives notice of any change, including changes of time, to the Contract or to related subcontracts, purchase orders, and other obligations.

11. No suit or action shall be commenced by a Claimant under this Bond other than in a court of competent jurisdiction in the location in which the Work or part of the Work is located or after the expiration of one year from the date (1) on which the Claimant gave the notice required by Paragraph 4.1 or Paragraph 4.2.3, or (2) on which the last labor or service was performed by anyone or the last materials or equipment were furnished by anyone under the Contract, whichever of (1) or (2) first occurs. If the provisions of this paragraph are void or prohibited by law, the minimum period of limitation available to sureties as a defense in the jurisdiction of the suit shall be applicable.

12. Notice to Surety, Owner, or Contractor shall be mailed or delivered to the addresses shown on the signature page. Actual receipt of notice by Surety, Owner, or Contractor, however accomplished, shall be sufficient compliance as of the date received at the address shown on the signature page.

13. When this Bond has been furnished to comply with a statutory requirement in the location where the Contract was to be performed, any provision in this Bond conflicting with said statutory requirement shall be deemed deleted herefrom and provisions conforming to such statutory requirement shall be deemed incorporated herein. The intent is that this Bond shall be construed as a statutory Bond and not as a common law bond.

14. Upon request of any person or entity appearing to be a potential beneficiary of this Bond, Contractor shall promptly furnish a copy of this Bond or shall permit a copy to be made.

#### 15. Definitions

15.1 Claimant: An individual or entity having a direct contract with Contractor, or with a first-tier subcontractor of Contractor, to furnish labor, materials, or equipment for use in the performance of the Contract. The intent of this Bond shall be to include without limitation in the terms "labor, materials or equipment" that part of water, gas, power, light, heat, oil, gasoline, telephone service, or rental equipment used in the Contract, architectural and engineering services required for performance of the Work of Contractor and Contractor's subcontractors, and all other items for which a mechanic's lien may be asserted in the jurisdiction where the labor, materials, or equipment were furnished.

15.2 Contract: The agreement between Owner and Contractor identified on the signature page, including all Contract Documents and changes thereto.

15.3 Owner Default: Failure of Owner, which has neither been remedied nor waived, to pay Contractor as required by the Contract, or to perform and complete or otherwise comply with the other terms thereof.

FOR INFORMATION ONLY – *(Name, Address, and Telephone)*

Surety Agency or Broker:

Owner's Representative *(Engineer or other)*:



**DRUG-FREE WORKPLACE AFFIDAVIT**

STATE OF \_\_\_\_\_

COUNTY OF \_\_\_\_\_

The undersigned, principal officer of \_\_\_\_\_, an employer of five (5) or more employees contracting with \_\_\_\_\_ County government to provide construction services, hereby states under oath as follows:

1. The undersigned is a principal officer of \_\_\_\_\_ (hereinafter referred to as the "Company"), and is duly authorized to execute this Affidavit on behalf of the Company.
2. The Company submits this Affidavit pursuant to T.C.A. § 50-9-113, which requires each employer with no less than five (5) employees receiving pay who contracts with the state or any local government to provide construction services to submit an affidavit stating that such employer has a drug-free workplace program that complies with Title 50, Chapter 9, of the *Tennessee Code Annotated*.
3. The Company is in compliance with T.C.A. § 50-9-113.

Further affiant saith not.

\_\_\_\_\_  
Principal Officer

STATE OF \_\_\_\_\_

COUNTY OF \_\_\_\_\_

Before me personally appeared \_\_\_\_\_, with whom I am personally acquainted (or proved to me on the basis of satisfactory evidence), and who acknowledged that such person executed the foregoing affidavit for the purposes therein contained.

Witness my hand and seal at office this \_\_\_\_\_ day of \_\_\_\_\_, 20\_\_\_\_\_.

\_\_\_\_\_  
Notary Public

My commission expires: \_\_\_\_\_

## SECTION 01010

### SUMMARY OF WORK

A. Project Identification:

**Woodbridge Drainage Improvements**

B. Project Summary:

This project consists of drainage improvements within Woodbridge Subdivision. Work includes the installation of 3070 inlets and 3x3 inlets as indicated on the Construction Plans.

Temporary traffic control measures shall be used during all phases of construction. All attempts shall be made to keep at least one lane of roadway open. In the event of a road closure, the Owner shall be notified within 48 hours in order to inform the residents of the impeding work. Access to private residences shall be provided throughout the project.

The contractor is responsible for all utility locates in the area of work and for those that may be affected by the construction. Coordination with utility company will be required. The location and depth of all utilities shown on the Construction Plans is estimated. Contractor should use caution when excavating in these areas.

All construction material shall be removed and properly disposed of in accordance with State and local regulations within the time limits of the project. Removal and hauling away of all construction debris including unsuitable soils shall be the responsibility of the Contractor.

A general description of the work includes the following; however this is not an exhaustive list:

- Furnish and install approximately 600 linear feet of 15 inch reinforced concrete pipe.
- Furnish and install 7 - 3070 inlets and 2 - 3x3 inlets as shown on the plans. All inlets shall be precast concrete according to City of Lakeland Specifications.
- Grade areas as shown on plans to ensure proper drainage toward newly installed inlets.
- Erosion control measures shall be installed and approved prior to commencing construction. Silt fence shall be used along clearing limits and along tree protection areas.
- Remove and replace concrete sidewalk damaged during construction. Sidewalk shall be replaced in full sections.
- Remove and replace concrete curb and gutter that is damaged during construction. Curb and gutter shall be replaced in ten (10) foot sections.

- Asphalt pavement shall be three inches (3”) Mix No.1 TDOT 411.E surface course hot mix asphalt placed on eight inches (8”) of a granular base (LA610). Asphalt shall be installed according to City of Lakeland and TDOT Specifications.
- All disturbed areas shall be graded and stabilized with sod upon completion of construction. These areas shall be returned to a condition equal to that prior to construction.

C. Particular project requirements.

1. Apply for, obtain, and pay for permits when required to perform the work.
2. Field-verify dimensions indicated on drawings (when applicable) before fabricating or ordering materials. Do not scale drawings.
3. Notify Owner of existing conditions differing from those indicated on the drawings. Verify the existence and location of underground utilities along the route of proposed work. Omission from, or inclusion of, locations on the drawings, is not to be considered as the nonexistence of, or the definite location of, existing underground utilities. Do not remove or alter existing utilities without prior written approval.
6. The Contract Documents are intended to provide the basis for proper completion of the work suitable for the intended use of the Owner. Anything not expressly set forth but which is reasonably implied or necessary for proper performance of the project shall be included.
7. The Provisions are written in the imperative mode. Except where specifically intended otherwise, the subject of all imperative statements is the Contractor. For example, "furnish..." means "Contractor shall furnish..."

END OF SECTION

## SECTION 01100

### GENERAL CONSTRUCTION REQUIREMENTS

#### **PART 1 - Description.**

To establish uniform requirements for construction of water distribution facilities, sanitary sewerage collection facilities, storm sewer collection systems, streets, and associated appurtenances which will enable the construction to be performed in accordance with Local, State, and Federal laws.

#### **1.01 Definitions.**

- A. For the purposes of these specifications, the words and phrases set out in the following articles shall have the meanings as follows:
1. "City" means the governing body of the city of Lakeland, TN.
  2. "Contractor" means the individual, partnership, firm, or corporation contracting with the developer or the City which will be performing the work, or which will be performing the construction activities.
  3. "Developer" means partnership, firm, or corporation developing property where construction will be performed.
  4. "Engineer" means the consultant or City Engineer.
  5. "Owner" means the individual, partnership, firm or corporation being the owner of record of property where construction will be performed.
  6. "Underground facility" means any item of personal or public property buried or placed below ground for use in connection with the storage or conveyance of electronic, water, sewage, telephonic or telegraphic communications, cable television, electric energy, oil, gas, hazardous liquids, or other substances and including, but not limited to pipes, sewers, water, storm water, conduits, cables, valves, lines, wires, manholes, and attachments.
- B. The following abbreviations shall have the designated meanings:
1. "APWA" means the American Public Works Association.
  2. "ASTM" means the American Society for Testing and Materials.
  3. "AWWA" means the American Water Works Association.

4. "AASHTO" means the American Association of State Highway & Transportation Officials.
- C. Reference to a specific specification, i.e., AWWA C900, means the latest Edition of that specification.

### **PART 3 Execution**

#### **3.01 Scheduling and Construction Progress.**

- A. Prior to the start of any work, the Contractor shall submit in writing to the Engineer for review, a progress schedule that shall be followed as closely as possible. Progress scheduling using critical path method is approved and encouraged. Once work has started on a street, it must be pursued continuously until all work on that street is finished.
  1. The Contractor shall schedule a preconstruction conference prior to the start of work. Persons attending shall include representatives of the Contractor, subcontractors, owner, developer, Engineer, and affected utilities.
- B. Each successive phase of work will follow the preceding phase as closely as possible so that the time any one street is under construction is kept to a minimum.
- C. In the event that the work is not being accomplished expeditiously or in accordance with the time period set forth in the progress schedule, or if the work on an excavation has ceased or is abandoned without due cause, the Engineer may give written notice to the Contractor and/or the surety company for the project.

#### **3.02 Notification of Landowners, Residents, and Businesses**

- A. At least one (1) week prior to beginning construction operations Contractor shall notify in writing, all those directly affected by the Work, including the Fire, Ambulance, Police Departments, and the Engineer's Office. The notification shall include the following as a minimum:
  1. Name, address, telephone number, and contact person for Developer, Developer's Contractor, Owner, and Engineer.
  2. A brief description of the proposed Work.
  3. Name and telephone number of Contractor's person to contact in emergency.
  4. A map showing the Work area, the traffic control plan, and the planned access to be provided to the affected properties. The map should also show the property or business owners' access during construction, and access in case of an emergency for fire, ambulance, police, or other emergency service agency vehicles.

5. A schedule for start up and completion of the Work. Schedules shall be updated as needed as the work progresses.
6. Contractor shall notify property owner and occupant 24 hours in advance of any disruption of service or access.

### **3.03 Available Maintenance Personnel**

The Contractor shall have personnel available to maintain the Work as required, 24 hours per day every day. Accordingly, the Contractor shall furnish the City, the Owner, the Engineer, and the Shelby County Sheriff's Office with the names, addresses, and telephone numbers of local employees or representatives who will be available to maintain the Contractor's work during non-working periods, evenings, nights, weekends, and holidays.

### **3.04 Utility Locates**

- A. It is the responsibility of the Contractor to obtain locates for buried facilities within the project area prior to the start of work as necessary and as required by law. The Contractor is responsible for any damage to buried utilities or damage or injury to persons or property resulting from Contractor's work in the vicinity of the utilities.
- B. It is the responsibility of the Contractor to provide advance notice to all utility notification centers serving that area. The Contractor shall request the notification center to provide the nature, location, and elevation of the utility at each location and at whatever interval is necessary for the work. If the utility company cannot or will not provide the information, the Contractor shall obtain the information by whatever means are necessary. For each location that the utility is exposed, the Contractor shall locate the utility by tying it both horizontally and vertically by coordinates, to the datum established by the City.
- C. At all utility crossings the Contractor shall locate the utility at a minimum of one point directly over the proposed line or appurtenance. When existing utilities that parallel the proposed line or appurtenance are exposed by excavation, the Contractor shall locate the utility by tying it both horizontally and vertically to the datum and include the information on the record drawings. At a minimum, the utility shall be tied horizontally and vertically at 300-foot (90 m) intervals.
- D. If during the field location of the utilities, additional unforeseen utilities are discovered, the Contractor shall immediately notify the Engineer and proceed in accordance with approval of the Engineer. The utility must be located by the Contractor as specified above and include the information on the record drawings.
- E. The Contractor must protect all existing utilities and improvements, public or private, located on the right-of-way, and other work areas, during the entire period of his work. Special care must be taken in backfilling and compacting under and around

such improvements. Any breakage or damage to underground facilities caused by trenching, backfilling, resurfacing, or any other activity associated with the work shall be the responsibility of the Contractor.

- F. Whenever utility mains or services are crossed, the utility owner shall be notified and the crossing shall be constructed in accordance with the utility owner's requirements.
- G. Before the Contractor begins his grading operations, he shall confer with the owners of any underground or overhead utilities which may be in or in close proximity to the grading areas, and shall arrange for the necessary disconnection of these utilities in accordance with the regulations of the utility companies concerned. The Contractor shall take such measures as the Engineer may direct in protecting these utilities properly throughout the period his grading operations are in progress. The party or parties owning or operating overhead or underground utilities shall perform the actual work of moving, repairing, reconditioning, or revising the utilities, except as otherwise specified in this Section. Whenever and wherever such operations are undertaken by the owners of utilities, the Contractor shall cooperate to the extent that ample protection of their work will be provided so that the entire work as contemplated may be expedited to the best interests of all concerned, as judged by the Engineer.
- H. Protect and safeguard existing service lines and utilities structures, the locations of which have been made known to the Contractor by the owners of the utilities or by others, prior to excavation or construction of fills or embankments, from damage during grading operations. Any damage to such lines or structures shall be repaired at the Contractor's expense. The above provisions are applicable to all service lines or utilities structures, all or any portion of which protrude above the original ground or street surfaces, or lie beneath such surfaces in any grading area or any other area upon which the Contractor has encroached.

### **3.05 Protection of Existing Buildings and Structures**

For collapse of adjacent buildings, sidewalks, structures, and underground or above ground utilities, the Contractor shall repair damage done to the owner's property or any other property, on or off the premises, by reason of his operations. The Contractor shall adequately brace walls during backfilling and compacting operations.

### **3.06 Construction Stakes – Alignment and Grades**

- A. All work shall be constructed in accordance with lines and grades shown on the drawings and as designated by the Engineer. These lines and grades may be modified by the Engineer as provided in the General Conditions.
- B. The Contractor shall provide experienced personnel, materials, and equipment necessary to complete all survey, layout, and measurement work. The Contractor shall keep the Engineer informed a reasonable time in advance, of the times and places he wishes to do work so that initial control points may be designated.

### **3.07 Restoration of Street Surface, Street Signs, Curbs, Driveways, Sidewalks, Irrigation and Landscaping**

- A. Wherever existing improvements are removed, damaged or otherwise disturbed by Contractor's activities, Contractor shall replace or repair the improvements to conditions equal to or better than the condition prior to the start of work. Any crushed rock, sod, or natural vegetation disturbed by the Contractor shall be replaced, rebuilt or restored to conditions equal to or better than the condition prior to the start of work.

### **3.08 Temporary Utilities, Public Access and Safety**

- A. Contractor shall provide temporary water and sewer service to properties when permanent facilities will be out of service for eight (8) hours or longer, or when other circumstances make it necessary. Where service cannot be interrupted, such as sewer mains, Contractor shall provide plant and equipment to pump around the sections which are out of service.
- B. Where the Engineer deems necessary, the Contractor shall provide access wherever possible to public and private property to prevent serious inconvenience to pedestrian and vehicular traffic. This shall not be construed to require the Contractor to provide such access at the times and locations where it will interfere with his construction progress. The Contractor shall furnish, place, and maintain sufficient flags, flares, barricades, signs, etc., along the location of his work in accordance with the Federal Highway Administration, "Manual on Uniform Traffic Control Devices." Flag persons shall be utilized if necessary to maintain safe traffic flow.

### **3.09 Erosion and Sediment Control**

- A. Erosion and sediment control shall be performed in accordance with rules and regulations adopted by the City of Lakeland and the Tennessee Department of Environment and Conservation.

### **3.10 City Permits**

- A. All necessary permits shall be obtained prior to the beginning of any construction project. Those permits may include: City of Lakeland/TDEC Permit to Construct, Street Cut Permits, Traffic Control Permits, Bonds, and Erosion and Sediment Control Permit, as well as any other appropriate permits required for the project by the City.

### **3.11 Punchlist and Final Closeout**

- A. Initial City Punchlist



1. The Contractor, Owner, Engineer, and City personnel will conduct an initial walkthrough and develop a list of deficiencies that will be presented to the Contractor by the Engineer.
2. The Contractor, Owner, and Engineer will conduct a walkthrough identifying items to be corrected. A final punch list will be developed by the Contractor and Engineer. The punch list will contain dates for completion of the various identified items.
3. All items on the list will be completed to the satisfaction of the City prior to acceptance of the project and start of the one-year warranty period.

### **3.12 Submittals**

The Contractor shall submit for approval by the Engineer a minimum of five (5) copies of data required by specific sections of this specification.

### **3.13 Workmanship and Cleanup**

- A. All debris and rubbish caused by the operations of the Contractor shall be removed, and the areas occupied during his operations shall be left in a neat and presentable condition satisfactory to the Engineer. Construction cleanup and all backfill operations shall immediately follow installation of underground facilities. Cleanup shall be completed to allow local traffic on the street and access to driveways, parking lots, etc. During construction, all existing gutters, storm drains, runoff channels, etc. shall be kept clean of dirt, rubble, or debris which would impede the flow of storm sewer.
- B. Excess, unsuitable, and waste materials from the project (including that from trench excavation, pavement removal, curbwalk removal, and grading operations), shall be suitably disposed of, offsite, by Contractor.
- C. Excess material resulting from parkway and shoulder finishing and other final operations shall not be permitted to accumulate on the pavement surface and shall be removed concurrently with the finishing operations. Care shall be taken to prevent the entrance of this material into drainage structures or other waterways during the construction period. It shall be the responsibility of the Contractor to properly dispose of all excess material.

### **3.14 Design Mixes, Testing and Quality Assurance**

- A. The testing requirements and cost responsibilities of design mixes, testing requirements, and quality assurance testing are listed in each specific section of these specifications.
- B. Unless specified by the contract documents, or addressed specifically within these

Standard Specifications, the Owner will be responsible for moisture/density/compaction testing only. If the initial moisture/density/compaction test fails to meet the minimum standards as established by these specifications, the Contractor shall pay for any and all additional tests until a moisture/density/compaction test meeting the minimum standards is obtained.

**END OF SECTION**

## **SECTION 01200**

### **PROJECT COORDINATION**

#### **PART 1 – Description**

##### **1.01 SUMMARY**

- A. Contractor shall schedule a preconstruction conference (if required) to be held within twenty (20) days of the Notice of Award. Contractor's assigned supervisory personnel and subcontractors shall attend this conference. Contractor shall provide a work schedule at or prior to this meeting for review by all parties. A corrected schedule shall be provided within seven (7) days following the meetings.
- B. Conduct all construction activities between the hours of 7:00 a.m. and 6:00 p.m., Monday through Friday, except in cases of emergencies. No work will be allowed on Saturdays without the Owner's permission, and no work, except for emergencies, will be allowed on Sundays or City of Lakeland Holidays. All pavement subgrade excavation shall be observed by the Owner Representative. The Owner's Representative shall determine the depth of the subgrade excavation prior to backfill.
- C. Contractor shall obtain water for use during construction at his expense. If Contractor elects to obtain water from the public water utility, he will make all the arrangements, comply with their regulations, and pay all fees and charges.

##### **1.02 COORDINATION WITH PUBLIC AND PRIVATE AGENCIES**

- A. If utility companies elect to repair or replace their lines in the project area, their crews will be permitted access to the area to accomplish their work.
- B. Contractor is responsible for locating and protecting existing underground improvements. Contact all utility companies for location of their facilities. To contact all utility companies call the local underground number at least 48 hours prior to excavation for field locates.
- C. Contractor shall have personnel available to maintain his work as required 24 hours per day every day. Contractor is responsible for housekeeping, dust and erosion control, and shall provide all equipment and personnel necessary to meet the requirements of this responsibility. Contractor shall provide Engineer with the name(s) and telephone number(s) of the person(s) designated to be available for after-hours contact. If this person cannot be contacted, Owner may use its equipment to correct problems. In this case, Contractor shall pay all costs incurred by Owner.
- D. Do not utilize private property for any purpose without written permission from the property owner.

### **1.03 COORDINATION WITH OWNER AND ENGINEER**

- A. Construct all work in accordance with the lines and grades shown on the Drawings, and as designated by Engineer (when applicable). Engineer may modify these lines and grades as provided in the General Conditions. Where the Contract Documents specify survey work to be provided by Engineer, give Engineer a minimum of 24 hours notice.
- B. Owner shall employ and pay for the services for an independent testing agency to perform tests as required by the Contract Documents. Notify Engineer a minimum of 24 hours in advance to request testing. Contractor shall be responsible for cost of re-tests required if the results of the original tests do not meet the minimum requirements.
- C. Coordinate on-site staging areas, access and temporary facilities with Owner.
- D. For additional information, contact Emily Harrell, PE, Lakeland City Engineer at 867-5418.

### **1.04 COORDINATION OF CONSTRUCTION**

- A. Contractor is responsible for coordinating work of all trades by preparation of schedules and progress reports, coordination of drawings and other work as necessary.
- B. Schedule work to produce orderly, continuous progress and avoid delays due to lack of materials, subcontractor schedule, lack of available manpower, etc.
- F. Contractor is responsible for ensuring that installed and/or completed work is complete and satisfactory prior to enclosing or covering. Call for required inspections in a timely manner and do not cover work that requires inspection.

**END OF SECTION**

## **SECTION 01340**

### **SUBMITTALS**

#### **PART 1 - Description**

##### **1.01 Summary**

- A. Comply with Submittal format requirements as specified in the Contract Documents.
- B. Provide, in a timely manner, the number of copies and types of submittals listed in individual sections of the Contract Documents. If not specified elsewhere, provide the following as a minimum:
  - 1. Mix designs and certifications of compliance for Portland Cement Concrete, Cement Treated Base, Aggregate Base Course, Asphaltic paving material, and any other material or product used as part of this project as required in the Standard Specifications.
  - 2. Closeout submittals.
- C. Provide required resubmittals in the appropriate quantities if original submittals are not approved.
- D. Samples and shop drawings shall be prepared specifically for this project. Shop drawings shall include dimensions and details, including adjacent construction and related work. Note any special coordination required. Note any deviations from requirements of the Contract Documents. Submittal data shall be properly labeled indicating specific service for which material or equipment is to be used, section and article number of specifications, project name, Contractor, etc. Data of a general nature will not be accepted.
- E. Failure of Contractor to submit shop drawings in ample time for checking shall not entitle him to an extension of contract time.

**END OF SECTION**

## **SECTION 01505**

### **TEMPORARY FACILITIES**

#### **PART 1 - Description**

##### **1.01 Summary**

A. Provide temporary services and utilities, including utility costs:

1. Potable and non-potable water.
2. Lighting and power.
3. Toilet facilities.
4. Materials storage.
5. Heating.

B. Provide construction facilities, including utility costs;

1. Construction equipment.
2. Dewatering and pumping.

C. Provide security and protection requirements:

1. Fire extinguishers.
2. Site enclosure fence, barricades, warning signs, and lights.
3. Snow and ice removal, if applicable.

D. Provide personnel support facilities:

1. Sanitary facilities.
2. Drinking water.
3. Cleaning and trash removal.
4. First aid and Emergency Medical Services.
5. Trash removal.

**END OF SECTION**

**SECTION 01650**

**MEASUREMENT AND PAYMENT PROCEDURES**

**PART 1 – Description.**

All work completed under this Contract will be measured by the Engineering according to the bid items and to the construction drawings. Units of measurement and dimensions will be shown in these specifications.

**1.01 Payment**

A. Progress payments will be processed in accordance with the following schedule.

<u>Cut-Off Date</u>	<u>Date of Submittal</u>
January 20, 2017	January 27, 2017
February 17, 2017	February 24, 2017
March 24, 2017	March 31, 2017
April 21, 2017	April 28, 2017
May 19, 2017	May 26, 2017
June 23, 2017	June 30, 2017

Submit pay requests to the City by the dates of submittal listed above.

- B. Owner will make progress payments as defined in Article 5 of the Agreement, on the forms provided by the Engineer.
- C. If the Contractor elects to enter into a joint account agreement, two (2) pay requests and vouchers must be submitted. One pay request and voucher for the appropriate progress payment amount, the other for the retained amount.

**1.02 Measurement of Quantities**

Quantities shown on the bid schedule are estimated and are to be considered approximate. Actual constructed quantities will vary. The Contractor will be compensated only for those items and materials actually installed and approved as part of the project. No additional pay will be granted for items or materials not installed.

- A. Payment will be made for the work completed and stored materials less retained amounts in accordance with provisions of the contract documents.
- B. Payment amounts will be based on the scheduled values and mutually agreed upon percentage of completion for each item.

### **1.03 Bid Item Descriptions**

The cost of all material and labor required to complete this project as specified and shown on the drawings, but not specifically included as a pay item, shall be included in the bid price of its related bid item. No extra pay shall be granted for items that are reasonably foreseen as necessary for the proper installation of an item.

### **PART 3 Execution**

#### **3.01 Measurement and Payment of Bid Items**

##### **A. Clearing and Grubbing**

1. Measurement of this item shall be paid by lump sum (LS) for clearing and grubbing. This item shall include completing clearing and grubbing and disposal of all debris resulting from clearing and grubbing as outlined in Plans and Specifications. Payment shall be made by the contract unit price per Lump Sum (LS).

##### **B. Earthwork**

1. Measurement of this item shall be paid by lump sum (LS) for earthwork. This item shall include completing earthwork and grading as outlined in Plans and Specifications. Payment shall be made by the contract unit price per Lump Sum (LS).

##### **C. Furnish and Install 15" Reinforced Concrete Pipe (Class III)**

1. Measurement of this item shall be paid by lineal foot (LF) of each size Class III reinforced concrete pipe furnished and installed in place and approved. This item shall include reinforced concrete pipe, excavation, backfill, compaction, bedding material, materials used in making joints and connections to other structures, and all other incidentals necessary to complete the work. Payment shall be made by the contract unit price per Lineal Foot (LF) in place.

##### **D. Furnish and Install 3070 Inlet**

1. Measurement of this item shall be made for each (EA) 3070 inlet furnished, installed in place and approved. This item shall include grate, pre-cast catch basin, excavation, preparation of base, setting of new structure, castings, backfilling, compacting, grading, and diversion of water. Payment shall be by the contract unit price per Each (EA) in place.

##### **E. Furnish and Install 3x3 Inlet**

1. Measurement of this item shall be made for each (EA) 3x3 inlet furnished, installed in place and approved. This item shall include grate, pre-cast catch basin, excavation, preparation of base, setting of new structure, castings, backfilling, compacting, grading, and diversion of water. Payment shall be by the contract unit price per Each (EA) in place.



F. Furnish and Install Granular Foundation (No. 57)

1. Measurement of this item shall be paid by cubic yard (CY) of foundation material furnished and installed in place and approved. This item shall include removal and disposal of unsuitable material, furnishing and installing foundation material, furnishing and installing separation fabric, and compaction of foundation material. Payment shall be made by the contract unit price per Cubic Yard (CY) in place.

G. Furnish and Install Select Backfill (Sand)

1. Measurement of this item shall be by the number of cubic yards (CY) of select backfill placed in an excavated trench measured from the vertical lines extending to twelve inches (12") of the surface equaling the width of the granular encasement and compacted in place. No payment will be made for select backfill beyond the vertical lines as described previously. This item includes furnishing, placement, compaction, removal and hauling away of unsuitable soils. Payment shall be by the contract unit price per Cubic Yard (CY) in place.

H. Remove and Replace Concrete Sidewalk

1. Measurement of this item shall be paid by linear foot (LF) of concrete sidewalk in place and approved. Measurement shall be made on the surface of the new concrete from the lines formed by the junction of the new concrete and old concrete. This item shall include excavation, forming, concrete, and all other materials needed to perform work. Payment shall be made by the contract unit price per Linear Foot (LF) in place and approved.

I. Remove and Replace Asphalt Pavement

1. Measurement of this item shall be by the number of square feet (SF) of hot-mix asphaltic concrete furnished and installed in place and approved. Measurements shall be made from the lines formed by the junction of new asphalt and old asphalt. This item shall include furnishing and application of prime coat, furnishing and placement of new hot mix asphalt, and compaction. New asphalt pavement shall have a compacted thickness of no less than three inches (3") of hot mix asphalt pavement after compaction. Payment shall be by the contract unit price per Square Feet (SF) in place.

J. Furnish and Install Granular Base (LA610)

1. Measurement of this item shall be by the number of cubic yards (CY) of granular base furnished and installed in place and approved. Quantities shall be verified and paid by haul ticket. This item includes excavation, removal and disposal of existing base, furnishing and installing granular base, and compaction. Payment shall be by the contract unit price per Cubic Yards (CY) in place.

K. Remove and Replace Concrete Curb and Gutter

1. Measurement of this item shall be paid by lineal foot (LF) of concrete curb and gutter constructed in place and approved. Measurement shall be made on the surface of the new curb and gutter from the lines formed by the junction of the new concrete and old concrete. This item shall include excavation, forming, concrete, and all other materials needed to perform work. Payment shall be made by the contract unit price per Lineal Foot (LF) in place and approved.

L. Remove and Replace Fencing

1. Measurement of this item shall be paid by the linear foot (LF) of fence in place and approved. This item shall include removal of fence and posts, temporary fencing, installation of fence and posts, concrete, hardware, and all other material needed to complete the work. The existing fence material may be reused if possible. Payment shall be made by the contract unit price per Linear Foot (LF) in place and approved.

M. Furnish and Install Bermuda Sod

1. Measurement of this item shall be paid by square yard (SY) of Bermuda sod furnished and installed in place and approved. This item shall include topsoil, fine grading, furnishing and placing sod, fertilizer and watering. Payment shall be made by the contract unit price per Square Yard (SY) in place.

N. Furnish and Install Zoysia Sod

1. Measurement of this item shall be paid by square yard (SY) of Zoysia sod furnished and installed in place and approved. This item shall include topsoil, fine grading, furnishing and placing sod, fertilizer and watering. Payment shall be made by the contract unit price per Square Yard (SY) in place.

O. Furnish and Install Temporary Construction Exit

1. Measurement of this item shall be paid by each (EA) construction exit furnished and installed in place and approved. This item shall include clearing, excavation, furnishing and placement of geotextile and granular material, and maintenance. Payment shall be made by the contract unit price per Each (EA) in place.

P. Furnish and Install Inlet Protection

1. Measurement of this item shall be paid by each (EA) inlet protection furnished and installed in place and approved. This item shall include clearing, excavation, furnishing and placement of geotextile and granular material, and maintenance. Payment shall be made by the contract unit price per EA (EA) in place.

Q. Furnish and Install Type C Silt Fencing

1. Measurement of this item shall be paid by lineal foot (LF) of silt fencing furnished and installed in place and approved. This item shall include silt fence, stakes and installation. Payment shall be made by the contract unit price per Lineal Foot (LF) in place.

R. Furnish and Install Temporary Traffic Control

1. Measurement of this item shall be paid by lump sum (LS) for temporary traffic control furnished and installed. Payment shall be consistent with the percentage of work completed at the time of the request for payment. The lump sum payment shall cover all of the Contractor's activities in meeting traffic control requirements for the project. Flagging, replacement of traffic control devices damaged or destroyed from any cause whatsoever, furnishing and installing cones, wands, portable flashers, any barricades and channelizing devices will be incidental to Traffic Control and no separate payment will be made for any item or activity necessary to comply with this specification. Payment shall be made by the contract unit price per Lump Sum (LS) of work completed.

S. Construction Survey and Staking

1. Measurement of this item shall be paid by lump sum(LS) for construction survey and staking. Contractor performing survey and staking shall be approved by the Owner prior to performing work. This item includes surveying and staking site according to plans. Payment shall be made by Lump Sum(LS).

**END OF SECTION**

## **SECTION 01750**

### **CONTRACT CLOSEOUT**

#### **PART I Description**

##### **1.01 Summary**

- A. Provide prerequisites to substantial completion.
  - 1. Punch list.
  - 2. Supporting documentation.
  - 3. Warranties.
  - 4. Certifications.
  
- B. Provide prerequisites to final acceptance.
  - 1. Final payment request with supporting affidavits.
  - 2. Completed punch list.
  - 3. Submit record documents: One set of drawings and project manual with all changes noted in red and Project Manual changes flagged with page tabs.
  - 4. Final clean-up.
  - 5. Removal of temporary facilities.

**END OF SECTION**

## SECTION 01810

### SPECIAL PROVISIONS

#### PART 1 Description

##### 1.01 SUMMARY

- A. These "Special Provisions" supplement, clarify, or modify provisions of Specifications as they apply to this project.
- B. Requirements of Special Provisions, General and Supplemental Conditions apply to work performed under all sections of this project.
- C. Work of this contract shall include all work required to construct the entire Project as shown on the drawings and defined by the Specifications and other contract documents, unless specific exceptions are stated therein.
- D. DISCREPANCY BETWEEN SPECIAL PROVISIONS, SPECIFICATIONS, AND PLANS. In the event of discrepancy between Special Provisions and other sections of the Specifications, the Special Provisions will take precedence over the Specifications, the General Conditions, and the Supplemental Conditions. The Specifications will take precedence over the Plans.

##### 1.02 LABOR PRACTICES

###### A. EIGHT-HOUR WORK DAY

The Contractor's attention is directed to, Limitation on work hours; overtime; exceptions. a) No person shall require laborers, workmen, or mechanics to work more than eight hours in any one calendar day or forty hours in any one week upon any public works of the state, or any of its political subdivisions, except as hereafter authorized. An employee may agree to work more than eight hours per day or more than forty hours in any week provided the employee shall be paid at the rate of one and one-half times the regularly established hourly rate for all work in excess of forty hours in any one week.

##### 1.03 BACKFILL OBSERVATION

No work shall be covered before the Project Representative or Engineer has approved the work. If any piping or appurtenance is covered without the approval of the Engineer or Project Representative, at the discretion of the Engineer, the Contractor will be required to

re-excavate to expose the covered materials. The cost of exposing those materials and then backfilling and compaction will be at the Contractor's expense, regardless of the condition of the pipe and/or the materials under question.

#### 1.04 CONSTRUCTION WATER

The Contractor is responsible for supplying water for construction purposes. If the Contractor wishes to use existing fire hydrants for water, he shall make the proper arrangements with the owner of the hydrant. The Contractor will be responsible for compliance with that owner's requirements as well as the payment of any fees for its use. Construction water is considered incidental to this project and no separate payment will be made to the Contractor for this item. If the Contractor wishes to use water from a resident, he shall obtain written permission from that resident to do so.

#### 1.05 SAFETY

In accordance with generally accepted construction practices, the Contractor will be solely and completely responsible for safety conditions at and adjacent to the job site, including the safety of all persons and property during the performance of the work. The Contractor shall comply with all federal, state, and local safety laws and regulations. This requirement shall apply continuously, and shall not be limited to normal working operations. The Engineer's construction review of the Contractor's performance is not intended to include review of the adequacy of the Contractor's safety measures, in, on, or near the construction site. This paragraph shall be applicable to the Contractor and all of the Contractor's subcontractors.

In addition, the Contractor shall provide barriers, fences, signs, lights, etc. as necessary to control access to the site.

Contractor shall provide Owner a written copy of their confined spaced program, proof of record-keeping protocol and inventory of appropriate equipment such as monitors for atmospheric hazards and rescue equipment. These documents shall be submitted at the preconstruction conference.

#### 1.07 DUST CONTROL

The Contractor shall be responsible for dust and erosion control, and for minimizing dust and erosion to the Owner's satisfaction. Dust and erosion control shall be deemed to be incidental and shall not be a pay item.

#### 1.08 DISPOSAL OF WASTE MATERIALS

Excess, unsuitable, and waste materials from this project (including that from trench

excavation, pavement removal, piping removal, and grading operations), shall be disposed of, offsite, by Contractor. Such disposal shall be considered incidental, and shall not be a pay item.

1.09 CODES AND STANDARDS

All materials and the completed installation shall comply with applicable standards promulgated pursuant to the State of Tennessee and City of Lakeland.

1.10 OPEN EXCAVATIONS

The Contractor shall completely backfill all excavations before stopping work for the day. No excavation (fenced or unfenced) shall be left open overnight, over a weekend, nor any period in which no work at that location is underway. The cost of reopening or re-excavation due to this provision will be borne by the Contractor.

1.11 CONSTRUCTION SURVEYING AND STAKING

In this project, lines and grades of replaced appurtenances shall match those existing. When new appurtenances such as drain lines, catch basins, curb, sidewalks, and new roadway crowns are to be installed, the Contractor will provide construction surveying and staking, unless otherwise noted.

1.12 CLEANING AND FINISHING

After completion of all work all debris and foreign material will be removed by the contractor. The project area, including staging areas, shall be clean and functional. This will include the restoration of any disturbed landscaping in the work area.

1.13 TRAFFIC CONTROL

A traffic control plan is required for repairs in areas affecting traffic. The Contractor is responsible for furnishing a traffic control plan to the City Engineer at least one week prior to the start of construction. Excavations which traverse a street shall be limited to one-half the width of the street at any one time, unless an emergency situation exists which requires the entire width of the street be excavated. The City Engineer's approval is required prior to traversing an entire street. The closure should not exceed forty-eight (48) hours and proper signage shall be installed detouring traffic and warning of construction.

**END OF SECTION**

## SECTION 01551

### TEMPORARY TRAFFIC CONTROLS

#### PART 1. Description

To establish uniform requirements for detours, signs and barricades, and traffic control plans associated with construction activities performed on or affecting City of Lakeland streets. The work in this article shall consist of furnishing, erecting, maintaining, relocating, and removing temporary traffic control devices at the locations specified on the drawings and as directed by the Engineer. All traffic control devices shall conform to the provision for construction signing as set forth in the Manual on Uniform Traffic Control Devices for Streets and Highways (MUTCD) latest edition.

#### PART 2 MATERIALS

##### 2.01 Traffic Control Products

###### A. Sign Panels

1. Sign panels will be constructed of  $\frac{3}{4}$ " plywood conforming to plywood sign panels and barricades of the standard specification for road and bridge construction; or 6061-T6 or 5052-H38 aluminum alloy sheeting conforming to ASTM B209.
2. Wood sign panels will be backed with metal backing angles; except that backing is not required for those sign panels 48" x 60" or smaller.
3. Aluminum sign panels will be 0.125" thick and backed with metal backing angles; except that those sign panels 48" x 60" or smaller may be:
  - i. 0.080" thick and backed with metal backing angles or 2 x 4 lumber; or,
  - ii. Unbacked, 0.125" thick.
4. Special signs which are unique to the project, i.e., signs not shown on the plans or included in part VI of the MUTCD, and signs shown on the plans which contain a message that is unique to the project, will be furnished by the contractor, as specified on the plans, and erected by the Contractor. Posts and hardware for fixed special sign installations, and all equipment for portable special sign installations will be furnished by the contractor. Post lengths will be specified by the Engineer. Upon removal, the special sign panels, posts, hardware, and portable installation equipment will remain the property of the Contractor.



- i. Special signs will be erected on fixed mountings unless portable mountings are authorized by the Engineer.
- B. Barrels will be plastic conforming to the MUTCD, with 6" wide reflective stripes.
- C. Temporary markings
  1. Temporary reflective pavement markings will be paint, preformed tape, or raised pavement markers, and will be suitable for use on either Portland cement concrete or asphalt pavements. Minimum acceptable standards are as follows:
    - i. Paint used for temporary markings will be commercially manufactured highway striping paint. The paint will be applied without dilution.
    - ii. All painted stripes will be 4" wide, and will be reflectorized by dropping or spraying glass beads onto the wet paint.
    - iii. The reflective beads will conform to AASHTO Specification M247, Type 1.
  2. Temporary reflective pavement striping tape will be 4" wide, pressure-sensitive tape manufactured for use as pavement striping.
    - i. Striping tape applied to finished pavement surfaces which will be returned to normal traffic use will be a removable type.
    - ii. Striping tape applied to temporary pavement surfaces which will be obliterated may be a non-removable type.
    - iii. Striping tape applied to the surface of intermediate lifts of asphalt pavement may be non-removable type, and may be let in place. If a removable type is used, it will be removed before placing the next lift.
  3. Temporary retro-reflective raised pavement markers manufactured by Astro Optics of Schaumburg, Illinois, Model No. TPM, or Stimsonite Products of Niles, Illinois, Model No. 66, or an approved equal will be acceptable.
  4. Temporary retro-reflective motorist guidance markers manufactured by Davidson Plastic Company of Ken, Washington, Model NO. TRPM, or TOM, or an approved equal will be acceptable.

## **PART 3 EXECUTION**

### **3.01 Traffic Control Plans**

- A. A complete traffic control plan shall be submitted to the Engineer and the Lakeland City Engineering office at least one week prior to the start of construction.
1. Traffic will be permitted to use the street at all times, unless a detour is specifically permitted on the drawings or by the Engineer. Access to all abutting residences and properties shall be maintained to the maximum extent possible.
  2. The Contractor shall construct and maintain temporary crossings, complete with flagmen, whenever necessary to expedite the work or to maintain traffic. The Contractor shall furnish not less than two flagmen at each location where loading or depositing of material requires the turning of the trucks on any highway or street and where the operation of construction equipment endangers traffic. Temporary crossings shall be of ample size to safely carry the load which comes upon them.
    - i. The Contractor shall maintain the streets in a passable condition. The work shall be conducted so as to create a minimum of inconvenience to traffic.
    - ii. Excavations which traverse a street shall be limited to one-half the width of the street at any one time, unless an emergency situation exists which requires that the entire width of the street be excavated. City Engineer's office approval is required prior to excavation traversing an entire street.
  3. The Contractor shall furnish sufficient signs and barricades to facilitate the directing of traffic. Unless directed otherwise by the Engineer, all signs and barricades shall conform to:
    - i. Within the "Manual on Uniform Traffic Control Devices (MUTCD), " latest edition.
  4. The Contractor shall have a sufficient number of barricades and signs on hand prior to the start of the construction
    - i. Each detour sign shall be reflectorized and shall be illuminated with two battery-powered blinkers with six-inch (6") amber lenses.
    - ii. All barricades shall have blinker lights on each end.
    - iii. It shall be the Contractor's responsibility to make necessary checks and inspections of all lights and barricades every day, including Sundays and holidays.
  5. Temporary suspension of work does not relieve the Contractor of the responsibility outlined in the above requirements.

### **3.02 Permits**

- A. The Contractor shall obtain all necessary permits from the City Engineer's office for any closure of any street or portion thereof, as provided in the Lakeland Municipal Code. Along with the permit application, the Contractor shall provide a sketch showing traffic routing and traffic control devices to be used. The construction traffic control sketch shall be approved by the City Engineer's office before the permit is issued.

### **3.03 Street Closure**

- A. The City Engineer may permit the closing of streets to all traffic for a period of time prescribed by the office if, in the City Engineer's Opinion, it is necessary.

**END OF SECTION**

## SECTION 02115

### EROSION AND SEDIMENT CONTROL

#### PART 1 - Description

This work shall consist of providing erosion and sediment control during and upon completion of construction as specified herein and as shown on the Construction Drawings.

#### 1.01 General

- A. The Contractor shall provide the Engineer a copy of the Storm Water Pollution Prevention Plan (SWPPP) as submitted to the Tennessee Department of Environment and Conservation.
- B. All erosion and sediment control plans shall be developed as per regulations outlined by the Tennessee Department of Environment and Conservation.
- C. All erosion and sediment control plans as outlined in the SWPPP shall be installed prior to any grading and land disturbance.
- D. All control measures shall be checked, and repaired as necessary, twice weekly in dry periods and within 24 hours after any rainfall of 0.5 inches (minimum). During prolonged rainfall daily checking and repairing is necessary. Maintain records of checks and repairs.
- E. A specific individual who is certified by a TDEC Certification Program or its equivalent shall be designated to be responsible for erosion and sediment control.

#### 1.02 Related Sections

Section 02230 Clearing and Grubbing

Section 02315 Excavation, Embankment and Fill

Section 02335 Roadway Earthwork

Section 02340 Geotextiles

Section 02370 Storm Drain Outfall Protection

Section 02835 Topsoil, Seeding and Lawn Restoration

## **PART 2 – Materials**

- A. The Contractor shall submit the following to the Engineer for inspection and acceptance all materials used for this Section.
- B. Silt Fence Materials shall be as follows:
  - 1. Silt Fence-See Section 02340 Geotextiles.
  - 2. Fence Post (for fabricated units): Steel posts will be a standard “T” and “U” sections weighting not less than 1.33 pounds per lineal foot with a minimum length 42 inches.
  - 3. Wire Fence (for fabricated units): Wire fencing shall be minimum 14-1/4 gage welded wire fabric with a maximum six inch mesh opening or as approved by the Owner.
- C. Stabilized Construction Entrance Materials shall be as follows:
  - 1. Aggregate shall be in accordance with Tennessee Department of Transportation (TDOT) #1 or #2 stone specifications (1.5 to 3.5 inch stone), washed and well graded. Refer to Tennessee Department of Environment and Conservation (TDEC) specification Riprap for aggregate size tables.
  - 2. Geotextile fabric shall meet the requirements of Section 02340 Geotextiles.

## **PART 3 - Execution**

### **3.01 Silt Fencing**

- A. Silt fence shall be constructed by securely fastening silt fence fabric and wire reinforcement to steel posts using wire ties. The silt fence fabric panels shall be installed loosely with adjacent panels overlapped a minimum of 12 inches. The top edge of the fabric shall be reinforced or shall have a one inch tuck.
- B. Accumulated silt and debris shall be removed by the Contractor behind the face of the silt fence when the silt deposits reach approximately one half the height of the fence. Clogged or damaged silt fence fabric or wire reinforcement shall be immediately replaced at no additional expense to the Owner.
- C. Refer to Silt Fence details on the construction drawing for additional details and general notes.

### **3.02 Erosion Control During Construction**

- A. The Contractor shall take sufficient precautions during construction to minimize the run-off of polluting substances such as silt, clay, wastes, fuels, oils, bitumens, and calcium chloride into the water supplies and surface waters of the State. Special precautions shall be taken in the use of construction equipment to prevent operations which promote erosion.
- B. Disposal of drainage shall be in an area approved by the Owner. The Contractor shall prevent the flow or seepage of drainage back into the drainage areas. Drainage shall not be disposed of until silt and other sedimentary materials have been removed. Particular care shall be taken to prevent the discharge of unsuitable drainage to a water supply or surface water body.
- C. As a minimum, the following shall apply:
  - 1. Approved silt fencing shall be provided as points where drainage from the worksite leaves the site, to reduce the sediment content of the water.
  - 2. Drainage leaving the site shall flow to water courses in such a manner to prevent erosion.
- D. Measures for control of erosion must be adequate to assure that turbidity in receiving water will not be increased more than 10 standard turbidity units (s.t.u.) or as otherwise required by the State or other controlling body, in waters used for public water supply or fish unless limits have been established for the particular water. In surface water used for other purposes, the turbidity increases must not exceed 25 s.t.u. unless otherwise permitted.

### **3.03 Stabilized Construction Entrance**

- A. Contractor shall install stabilized construction entrances in at least one main entry point to the construction site. Additional entrances shall be stabilized depending on the project size and use of entry points to the construction sites. Construct stabilized construction entrance as per dimensions shown on the construction.
- B. Geotextile Engineering fabric shall be installed prior to placement of aggregate. Fabric shall not be required for work on single family residential lot.
- C. Maintenance of stabilized construction entrance shall include periodic top dressing of entrance with additional stones as conditions demand to prevent tracking or flow of sediment onto public rights of way.

**END OF SECTION**

## SECTION 02632

### STORM SEWERS AND CULVERTS

#### **PART 1 - Description**

This section covers storm sewer and culvert materials, excavation, trenching, and backfilling for storm sewers and appurtenances. Work shall consist of removal of all material of whatever description that may be encountered; removal and disposal of debris; handling and storage of materials; all necessary bracing, shoring, and protection; pumping and dewatering as necessary; all backfill preparation of subgrades; and final grading, dressing, and surface restoration cleanup of the site.

#### **PART 2 - Materials**

##### **2.01 Submittals**

Before the fabrication of the pipe and manholes is started, the contractor shall submit for review, drawings showing the pipe lengths, complete laying schedule, joint details, special sections, and other additional details, such as fittings. All pipe and manholes furnished shall be fabricated in accordance with the reviewed drawings. Manufacturer's certificates of compliance and installation recommendations shall be provided to the City prior to construction.

##### **2.02 Materials**

The materials furnished for the storm sewer pipe and culverts shall be equal to or shall exceed the following requirements.

#### **A. Storm Sewer Pipe and Culverts**

The materials furnished for the storm sewer pipe and culverts shall be equal to or shall exceed the following requirements.

##### **1. Reinforced Concrete Pipe (RCP)**

a. All reinforced concrete pipe shall conform to the requirements of ASTM Standards for the specified diameter and strength class as follows:

1. Circular Pipe – ASTM C76
2. Horizontal and Vertical Elliptical Pipe – ASTM C507
3. Arch Pipe – ASTM C506

b. Minimum wall thickness shall be "Wall B" in referenced specifications C76 and C14 of ASTM.

- c. Strength class or classes shall be as required by the Plans or Contract Documents but in no case shall pipe of less than strength Class III be used. Portland Cement used in manufacturing reinforced concrete pipe shall be Type II, ASTM C150.
- d. Lifting holes will not be permitted in any of the pipe, except elliptical pipe and box sections.
- e. Joints for the reinforced concrete pipe shall be either tongue and groove or bell and spigot. Except for special pieces, each joint shall be at least seven and one-half feet (7'6") (2.3m) in length. Unless deleted elsewhere in the specifications, joints in reinforced concrete pipe shall conform to one of the following types:

Rubber Trapped "O" Ring Gasket type – ASTM C 443  
Flexible Plastic Rope Gasket type – AASHTO M 198 – Type B  
Flexible Butyl Rope Gasket type – AASHTO M 198 – Type A  
Portland Cement Mortar Joint type

- f. Type D, Portland Cement Mortar Joint, may only be used on radial, elliptical, and arch pipe. The shape, dimensions, and tolerance of the bell and spigot or tongue and groove ends of the pipe shall be compatible with the type of joint used and shall conform to the above referenced specifications.
  - g. Reinforced concrete pipe shall be manufactured in a plant that is certified by the American Concrete Pipe Association.
  - h. In addition to the certifications and bearing test results, the contractor shall furnish the Owner with mill test reports for all cement used to manufacture proposed pipe. The owner reserves the right to sample and test any pipe after delivery and to reject all pipe represented by any sample which fails to comply with the specified requirements.
2. Polyvinyl Chloride Pipe (PVC)
- a. Polyvinyl chloride pipe (PVC) shall conform to ASTM D3034, SDR 26, for four inch (4") (100mm) through fifteen inch (15") (375mm) diameter and ASTM F679 for eighteen inch (18") (450mm) through thirty six inch (36") (914 mm) diameter. The pipe shall have bell and spigot joints with an approved gasketed joint.
  - b. When special fittings such as wyes, tees, etc., are required, they shall be manufactured from the same material as the pipe and shall be made for use with PVC pipe. Connections to manholes and catch basins shall be made using O-ring gaskets whenever ground water is present; otherwise, catch basins and manholes may be grouted. Other suitable elastomeric boots may be used.
3. Corrugated Steel Pipe (CSP)



- a. Corrugated steel pipe, band couplers, and fittings, shall be manufactured in accordance with AASHTO M-36, latest edition, as revised in these specifications. All seams shall be joined in a manner that develops the full strength of the pipe and shall not affect the shape or nominal diameter of the pipe. The wall thickness of the steel shall be specified in the Special Provisions. Corrugated Steel pipe shall not be used unless shown on the construction drawings.
- b. The materials used to coat the steel sheets shall be specified in the Special Provisions and may be one or more of the following types:
  - i Zinc-coated (galvanized) steel sheets for annular pipe shall be coated in accordance with AASHTO M-218.
  - ii Aluminized coated (Type 2) steel sheets shall be coated by the hot dip process in accordance with AASHTO M-274, M-36, and M-274.
  - iii Precoated (Polymeric) galvanized steel sheets shall be coated in accordance with AASHTO M-246 and M-245. The precoated sheets shall be Type C with a polymeric coating in a thickness of 0.010 inch (3mm) minimum on each side and edge of the sheets.
- c. After the fabrication of the pipe, the manufacturer will coat the cut ends of each section of pipe with the specified coating before shipping. Exposed uncoated metal at the ends of the pipe may be reason for rejection of the pipe.
- d. The CSP shall be joined together with coupling bands manufactured in accordance with AASHTO M-36. If coatings of the CSP are specified, the couplings shall be coated with the same materials. Unless otherwise specified, the couplings shall make a watertight joint.
- e. All pipe shall be inspected when delivered to the job site and prior to the unloading of the pipe. Any pipe damaged during shipping and/or handling will be rejected and will not be installed. If the exterior bituminous coating is damaged during installation, the contractor shall repair the coating using approved methods and materials. If the concrete lining is damaged during installation, the contractor shall remove and replace the damaged pipe at no expense to the owner.
- f. The pipe supplier shall prepare and supply the contractor with a pipe-laying schedule, and the Contractor's supervisor and superintendent and the owner's representative shall have these laying schedules available on the job site.
- g. Connections for the laterals and catch basin leads may be shop fabricated or made in the field. In some instances, field connections shall be required. All field connections shall be saw cut using a saber type saw and templates made for such use. Flame cutting shall not be

allowed. After field cuts have been made, the exposed metal shall be coated with the specified coating. Coating materials shall be supplied by the pipe manufacturer. The connection shall be completed according to the manufacturer's recommendations.

- h. Installation of corrugated steel pipe is considered to be a flexible conduit and, therefore, special care must be taken during the bedding and backfilling operations. Installation and backfilling operations shall be in accordance with the recommended practices set forth in the "Handbook of Steel Drainage and Highway Construction Projects", published by the American Iron and Steel Institute.
  - i All pipe shall be bedded with an approved granular bedding material. The pipe shall be bedded true to line and grade with uniform and continuous support from a firm base. Blocking shall not be used to bring the pipe to grade.
  - ii The bedding material shall be placed evenly on both sides of the pipe to a point twelve inches (12") above the top of the pipe. Special care shall be taken to insure that all voids are filled beneath the pipe haunch and that the bedding material is properly placed and compacted to provide lateral restraint. The trench sidewall shall be adequately braced, shored, or sheeted as necessary to stabilize the trench walls. The trench shall not be any wider than necessary for proper installation, and pipe jointing. The bedding material shall be placed under haunches and around the pipe alternately in 6-inch layers on both sides of the pipe to permit thorough consolidation of the bedding material. This material is placed alternately to keep it at the same elevation on both sides of the pipe at all times.
  - iii Extreme care shall be taken in the removal of cribbing, shoring, sheeting, etc., so as not to disturb previously constructed foundation, bedding and initial backfill. If it was necessary to place or drive sheeting or other trench protection below the top of the pipe, the sheeting, shoring, etc., shall be cut off at a point one foot (1') above the pipe and the remaining material shall be left in place. Removal of this portion could seriously jeopardize the side support necessary for "flexible conduits" and create excessive lateral soils pressures and pipe deflections.
  - iv Excessive concentrated loads or heavy equipment on top of or along side of the pipe shall be avoided. Maximum supporting strength in flexible conduits does not develop until the fill consolidates.

#### 4. Corrugated PVC Drainage Pipe

- a. Corrugated Polyvinyl Chloride (PVC) pipe shall conform to ASTM F794 and F949 for twelve inch (12") through thirty-six inch (36") diameter. Joints shall be an integral bell-gasketed joint. When the joint is assembled, it shall prevent misalignment of adjacent pipes and form either a soil tight joint (2psi) hydrostatic test per AASHTO Standard Specification for Highway Bridges, Section 26.4.2.4 or a watertight joint (10.8) psi test per

ASTM D3212.

- b. When special fittings such as wyes, tees, etc., are required, they shall be manufactured from the same material as the pipe and shall be made for use with Corrugated PVC Drainage pipe. Connections to manholes and catch basins shall be made using O-ring gaskets whenever ground water is present; otherwise, catch basins and manholes may be grouted. Other suitable elastomeric boots may be used.

5. Reinforced Concrete Box Culverts

- a. Reinforced box culverts shall be precast or cast in place
- b. Precast concrete box culverts shall conform to the requirements of ASTM C1433, latest revision. Concrete box culverts shall be manufactured in a plant that is certified by the American Concrete Pipe Association.

B. Manholes

1. All manholes and other precast items shall be manufactured in a plant that is certified by the National Precast Concrete Association. Manufacturer's certificates of compliance and installation recommendations shall be provided to the Engineer and City prior to construction.
  - a. All manholes shall be constructed with concentric precast sections without steps unless otherwise approved. Precast concrete manhole sections shall be manufactured to standards at least equal to or greater than the requirements of the standard specifications for precast reinforced concrete manhole sections, ASTM designation C478. The minimum internal diameter for storm manholes shall be forty-eight inches (48") (1.2m) unless shown otherwise. Manholes shall conform to all requirements as shown on the detail drawings. Precast manhole joints shall be made water-tight with RAM-NEK material, or approved rubber gasket at each joint. The RAM-NEK and primer must be used in accordance with the manufacturer's instructions. Rubber gaskets used for precast manhole joints shall be designed in accordance with ASTM designation C443. All lifting holes must be grouted. All Portland cement for manholes shall be Type II.
  - b. The concrete base shall be cast-in-place or precast concrete of the size and depth shown on the drawings. Concrete used for bases shall have a twenty-eight (28) day compressive strength of at least four thousand pounds per square inch (4,000psi) (27,600 kPa). Approved precast concrete bases will be allowed if provided with an integral groove for barrel placement. Precast concrete bases shall conform to ASTM C478. Manholes with a monolithically poured base with bottom barrel are also acceptable and preferred.
  - c. Precast manhole inverts shall be constructed using a secondary invert forming system designed to provide a finished invert that aligns precisely with the incoming pipelines, incorporating a finished flow depth of 0.8 to 1.0 diameter of the largest pipe. The

completed precast invert shall include an alignment bench for each pipe, and provide for uniform horizontal and vertical transition through the manhole in accordance with drawings. Provide 0.1' (30mm) minimum fall between inlet and outlet. After the installation of the pipelines into the manhole, the interior annular space around the outside of the pipe shall be sealed with grout. The acceptable tolerances for manhole inverts are one-quarter inch (1/4") (6.25mm) in any dimension and within 2 degrees for alignment. The invert forming system shall be "a-lok tru contour", or approved equal.

- d. The manhole ring and cover shall be centered over the connection at the centerline of flow.
- e. For manholes with depths of six feet (6') (1.8m) or less, all of the precast manhole sections shall be of the specified diameter and shall have a flat, precast concrete top.
- f. For sewer manholes four (4) to six (6) feet in diameter and less than twenty (20) feet deep, precast reinforced manhole base sections shall be a minimum of 8 inches thick. For sewer manholes greater than six (6) feet in diameter or more than twenty (20) feet deep, precast reinforced concrete manhole base sections shall be a minimum of 12 inches thick. All precast manhole base sections shall be reinforced with #4 steel reinforcement bars placed 6 inches on center each way and at mid depth of the slab, unless shown otherwise on the plans.

#### C. Catch Basins.

1. All catch basins, inlet boxes, and other precast items shall be manufactured in a plant that is certified by the National Precast Concrete Association. Catch basins (storm inlets) shall be cast-in-place or precast concrete with dimensions as shown on the drawings or standard details.
  - a. Precast concrete catch basins shall comply with all the requirements of ASTM C858 and C857. Cast-in-place concrete basins shall be constructed of materials in accordance with Section 03050, Portland Cement Concrete.
  - b. The Contractor may elect to install pre-cast or cast-in-place catch basins.

#### D. Castings

1. Manhole frames and covers, and catch basins frames and grates shall meet the requirements of this Section unless specified otherwise in the Special Provisions or drawings.
2. Manhole frames and covers shall be heavy duty Neenah R 1643 or approved equal. Heavy-duty manhole ring and cover shall have a minimum depth of seven and half inches 1.5 inch thick cover, and an inside clearance of 24 inches in diameter.
3. Acceptable grates shall be determined by the design, hydraulic efficiency, and placement

required. Additionally, grates must be suitable for use in areas where it is possible for handicap persons and pedestrians to be present. The adoption of the Americans with Disabilities Act (ADA), the prominence of narrow-tired bicycles and concern for pedestrian safety dictates the design considerations of storm water installations.

Grate selection criteria should include a combination of capacity, and functionality for the specific location. Directional and/or vane grates are not recommended at the low points of vertical curves, and shall be used only when approved by the Engineer.

Catch basin frames and curb box shall be Neenah R-3067, D&L Supply I-3517, or equivalent. I-3516 is recommended for use in the lowpoint of vertical curves.

Grates shall be certified by the manufacturer as bicycle friendly, and the certification shall be submitted to the City prior to installation.

4. Cover and frame seat shall be machine finished to prevent any rocking of cover in its associated frame. Cover shall have the word "storm sewer" clearly cast on its surface.

When required, self-sealing, waterproof frames and covers meeting Neenah R-1916-F, or approved equal shall be used.

5. Flared end sections for culverts shall be manufactured of the same material as the culvert. End sections shall be fitted for a trash rack on both upstream and downstream ends, or as directed by the Engineer.

#### E. Granular Materials

1. Granular materials furnished for foundation, bedding, encasement or other purposes as may be specified, shall consist of any material or synthetic mineral aggregate such as sand, gravel, crushed rock, crushed stone or slag, that shall be so graded as to meet the gradation requirements specified herein for each particular use.
2. Granular materials furnished for use in foundation, bedding, or encasement recommended for use in construction are:

#### MATERIAL USE DESIGNATION

Sieve Size	Percent Passing	
	Foundation AASHTO M43 (No.57)	Bedding & Encasement AASHTO M43 (No. 67)
1 inch (25mm)	95-100	100
3/4 inch (20mm)	-	90-100
1/2 inch	25-60	-
3/8 inch (9.5mm)	-	20-55

No. 4 (4.75mm)	0-10	0-10
No. 8 (0.075mm)	0-5	0-5

3. Other approved material for bedding and encasement shall consist of sand, sandy gravel, or fine gravel having a maximum size of three-quarter inch (3/4") (20mm), uniformly graded and a maximum plasticity of 6 as determined by AASHO T-89 and T-90. Other gradations may be used if written approved is obtained from the City.
4. Certified copies of all sieve analysis and plasticity analysis for the above materials shall be submitted to the City Engineer and approved before construction starts. Other sieve or plasticity analysis may be required during construction as directed by the City Engineer.
5. Granular materials provided for Foundation, Bedding, or Encasement use, shall be classified as to use in accordance with the following:
  - a. Granular Foundation: placed below and to the midpoint of the pipe as replacement for unsuitable or unstable soils, to achieve better foundation support.
  - b. Granular Bedding: placed from four inches (4") (100mm) to six inches (6")(150mm) below the pipe to the pipe midpoint, to facilitate proper shaping and achieve uniform pipe support. When foundation material is required, the granular bedding shall be of foundation material gradation.
  - c. Granular Encasement: placed below an elevation one foot (1') (300mm) above the top of pipe, after pipe installation, for protection of the pipe and to assure proper filling of voids or thorough consolidation of backfill. Granular encasement shall be provided for all flexible piping.
6. Granular encasement and bedding material shall meet the gradation requirements listed in herein. Other gradations may be used if written approval is obtained from the City Engineer. Gradations should meet the requirements of ASTM 2321. Guidelines for the maximum particle size for encasement material in relation to pipe type and diameter are shown below:

<u>Pipe Type</u>	<u>Nominal Diameter Inches (mm)</u>	<u>Maximum Particle Size Inches (mm)</u>
PVC, Other Plastic	15" and greater	3/4 (20)
PVC, Other Plastic	Less than 15"	1/2 (12.5)
Concrete	6.1 - 12.0 (155 - 300)	1 (25)
Concrete	12.1 (307) and greater	1 (25)
CMP	6.1 - 12.0 (155 - 300)	1 (25)
CMP	12.1 (307) and greater	1 (25)

## 7. Select Backfill

Job excavated and imported select backfill material shall be free from debris, organic material, and stones larger than three inches (3") (75mm) in diameter. Contractor shall be responsible, at his expense, for separating debris, organic material and stones larger than three inches (3") (75mm) in diameter. Select material that the Engineer directs to be used shall be the same gradation as the bedding and encasement material. No asphalt chunks or concrete may be used as select backfill.

## 8. Structural Fill Material

Structural fill shall consist of excavated or imported material, free of organic or deleterious material and particles larger than three inches (3") (75mm) in maximum dimension. Structural fill shall be well graded from coarse gravel to fine sand with less than 10% passing the No. 200 sieve. Structural fill material shall be within +2% of optimum moisture content when placed as determined by Proctor, and shall not exhibit pumping (horizontal or vertical displacement) after completion.

## 9. Groundwater Barriers

Low permeability ground water barriers may be used in areas designated by the City Engineer. Barrier material shall meet soil classification GC, SC, or CL per the Unified Soil Classification System and shall have a liquid limit less than 50. The barrier material shall be compacted to 95 percent of maximum density. Job excavated material meeting one of the above soil classifications and free from stones, organic matter and debris may be used.

10. Portland Cement Concrete shall be of the class and dimensions as shown on the Plans or as directed by the Owner. The classes of concrete for drainage facility construction are referred to as Class AS and Class C. Class AS concrete is intended principally for concrete structures designed for high strength. Class C concrete is intended principally for low strength concrete used primarily for foundation stabilization, pipe cradles and encasement and other general purposes. All Portland Cement Concrete shall meet the requirements of Division 3 of these specifications.

## **Part 3 - Execution.**

### **3.01 Excavation for Pipe and Related Structures (General)**

1. Complete all excavation regardless of the material encountered. If structures, utilities, or other objects are encountered that may be necessary for continued facility operation or may need preservation, immediately notify the Engineer and protect said object.
2. When cutting into existing roads, streets, alleys, or other public rights-of-way, the Contractor,

shall obtain the proper licenses, cut permits, etc., from the appropriate authority.

- a. Where trench excavation requires the removal of curb and gutter, concrete sidewalks, or asphaltic or concrete pavement, the pavement or concrete shall be cut in a straight line parallel to the edge of the excavation by use of a concrete saw, or similar approved equipment to obtain a straight, square, clean break. Cuts shall be located at standard joint locations, when possible.
3. When crossing existing or prospective cultivated areas, gravel streets or other developed surfaces, the Contractor shall strip the cover material to full depth of the existing surfacing. This surfacing shall be stockpiled and placed back over the trench after backfilling to the extent that it is acceptable and usable for that purpose. New material shall be provided as necessary. Topsoil shall be removed to full depth of the topsoil, or to a maximum depth of twelve inches (12") (300mm), whichever is less.
  4. The disturbed area from construction shall be confined within the construction limits.
    - a. The trench shall be dug only as far in advance of the pipeline as work can be reasonably completed that day. The sides of the trench shall be sloped and/or braced in accordance with the current OSHA Standards and the trench drained so that workers can work safely and efficiently. It is essential that the discharge of pumps when required, be laid to approved natural drainage channels or storm sewers
  5. Pipe crossings under sidewalks or curbs may be made by tunneling only if approved by the Engineer. If the Contractor elects to remove a portion of the sidewalk or curb, he must use a concrete saw for making neat joints corresponding to existing joints, compact the backfill as specified, and pour a new concrete sidewalk or curb section in accordance with the applicable sections of these specifications.
  6. During excavation, materials suitable for backfilling shall be piled in an orderly manner a sufficient distance from the banks of the trench to avoid overloading and to prevent slides or cave-ins. All excavated materials shall be stored and retained at least two feet (2') (600mm) or more from the edge of the trench in accordance with Occupational Health and Safety Rules and Regulations for Construction. Excavated material must not be piled over nearby existing parallel trench lines unless adequate precautions are taken by the Contractor to prevent sidewall failure. Ready access to existing fire alarm boxes, fire hydrants, valves, manholes, and other appurtenances must be maintained.
    - a. When making excavations, the various materials excavated shall be piled separately. All concrete and bituminous materials, any soils, which cannot be properly compacted, and all other deleterious materials shall be immediately removed from the construction site and properly disposed of in accordance with applicable laws.
    - b. All excavated material shall be piled within the construction limits or in a location obtained



by the Contractor and accepted by the Engineer in a manner that will not endanger the work and that will avoid obstructing sidewalks, driveways, and fire hydrants.

7. Surface drainage of adjoining areas shall be unobstructed. Grading shall be done as may be necessary to prevent surface water from flowing into excavations, and any other water accumulating therein shall be promptly removed. Under no circumstances shall water be permitted to rise in unbackfilled trenches until after the pipe has been placed, tested, and covered with backfill. Any pipe having its alignment or grade changed as a result of a flooded trench shall be reinstalled.
  - a. Gutters shall be kept clear or other satisfactory provisions made for street drainage at all times.
8. The bottom of the trenches shall be accurately graded to the line and grade shown on the drawings. Bedding material shall be added (four inches (4") (100mm) minimum) to provide uniform bearing and support for each section of pipe at every point along its length. Care must be taken to avoid over excavation. Unauthorized over-depths shall be backfilled with approved bedding material at the Contractor's expense. All bedding material added shall be moistened and compacted to the satisfaction of the City Engineer. The finished trench bedding beneath the pipe shall be prepared accurately by means of hand tools.
  - a. The bottom of all excavations shall be neat and clean, containing no abrupt changes in grade except as shown and shall be free from all slough. Suitable methods shall be used to produce an excavated surface without disturbance to the underlying material by compacting soil material to at least 95% Standard Proctor, ASTM D698.
  - b. If in its natural state the material at the bottom of the trench is soft and, in the opinion of the City Engineer, cannot support the pipe, a further depth and/or width shall be excavated as directed by the City Engineer and refilled with foundation material to the midpoint of the pipe. Other approved methods may be used to assure a firm foundation.
  - c. Foundation material used to dewater the trench or to replace a wet material shall be considered incidental to construction.
9. Blasting the excavation to remove rock, clay, or hardpan will not proceed until the Contractor has notified the City Engineer of the necessity to do so and obtained written approval. This notification shall in no manner relieve the Contractor of the hazard and liability contingent on blasting operations. The City Engineer shall fix the hours of blasting. The Contractor at his expense shall repair any damage caused by blasting. The Contractor's methods of procedure relative to blasting shall conform to local and state laws and municipal ordinances, and the necessary permits shall be obtained.
10. The width of the trench shall be such to provide adequate working room for workers to install the pipe in the specified manner. The trench in the pipe zone and to one foot (1') (300mm)

above the pipe zone shall be adequate in width to allow for proper compaction but shall in no case be less than one and half times the outside pipe diameter plus one foot (1') (300mm).

11. Where the trench is not located near existing utilities, buildings, or other structures, and where water and other conditions permit, the Contractor may omit sheeting and bracing of the excavation. In this event, sides of the trench shall be sloped to protect the workers working within them in accordance with Occupational Health and Safety Rules and Regulations for Construction. However, the trench must stay within the construction limits.
12. The Contractor shall provide safety boxes or sheeting and bracing necessary to confine his work within the construction limits, to provide safe working conditions, to prevent damage and delay to the work, and to prevent the disturbing or settlement of adjacent road surfaces, foundations, structures, utility lines or railroad tracks. The Contractor shall be responsible for the strength and sufficiency of all sheeting and bracing.
13. Any damage to the work under this contract or to adjacent structures or property caused by settlement, water or earth pressures, slides, cave-ins, or other reasons due to failure or lack of sheeting and bracing, or improper bracing, or through negligence or fault of the Contractor in any manner, shall be repaired by the Contractor without delay and at his expense.
14. Bracing shall be so arranged as to provide ample working space, so as not to interfere with the work, and so as not to place any strain on the structures being constructed, until such structures are of sufficient strength to withstand such strain. No sheeting and bracing shall be removed until the construction has proceeded far enough to provide ample strength for its safe removal.
  - a. Sheeting or bracing may be left in place in the trench at the discretion of the City Engineer. Any sheeting or bracing left in place shall be cut off approximately three feet (3') (900mm) above the top of the pipe or two feet (2') (.6m) below finish grade, whichever is lower, and the cut-off portion removed. All sheeting or bracing left in place shall be accurately located and shown on the "Record Drawings"
15. The Contractor shall be responsible for enforcing safety and maintaining safe working conditions in all trenching, shoring, and blasting operations to conform to OSHA regulations.
16. Trenching and tunneling standards near and around trees.
  - a. Trenches should be routed outside the tree protection zone or critical root zone (CRZ). For trees less than 6" diameter at breast height (DBH), defined as 4.5 feet about average ground level, that are to be retained, no trenching should occur within the dripline or tree protection/critical root zone as defined by the City of Lakeland Tree Management Ordinance. For trees 6" DBH and less than 20" DBH no trenching should occur within an area equal to 1' radius for every inch of DBH or within the tree protection/critical root zone as defined by the City of Lakeland Tree Management Ordinance. For trees 20" DBH and greater, no trenching should occur within an area equal to 1.5' of radius for

every inch of DBH or within the tree protection/critical root zone as defined by the City of Lakeland Tree Management Ordinance.

- b. Soil removed from the trenches should be placed on the side away from the trees and replaced as soon as possible. The width of the trench should be minimized. The use of trench walls should be considered rather than sloping sides when working around trees.
  - c. Trenches should be backfilled with quality or native soil when inside of a tree protection zone or critical root zone. Gravel, slurry, stone, and concrete are not appropriate fill material within a tree protection zone, unless used as bedding material.
  - d. If placement of utilities or other infrastructure is unavoidable within the tree protection zone or critical root zone then specific measures should be applied to minimize root damage. Tunneling is recommended as soon as roots 1 inch diameter and greater are encountered. Minimum tunnel depth should be 24 inches. Launch and recovery pits should be located outside of tree protection zones and critical root zones. If tunneling is impossible due to specific soil restrictions, the trenching should be done by hand within the tree protection zone or critical root zone. If this required trenching will sever more than 25% of the tree protection/critical root zone then the trench should be re-directed at the center of the tree with the final section dug under the base of the tree.
  - e. Changes to the approved construction plans or methods for trenching and tunneling must be submitted to and receive approval by the City's Representative before proceeding.
17. Dewatering, if required by site conditions, shall be provided by the Contractor. The contractor shall provide and maintain adequate dewatering equipment to remove and dispose of all surface water and groundwater entering the excavations, trenches, or other parts of the work.
18. All trench excavations which extend down to or below groundwater shall be dewatered by lowering and keeping the groundwater level beneath such excavations twelve inches (12") (300mm) or more below the bottom of the excavation.
19. Surface water shall be diverted or otherwise prevented from entering excavated areas or trenches to the greatest extent practicable without causing damage to adjacent property.
20. The Contractor shall be responsible for the conditions of any pipe or conduit which he may use for drainage purposes, and all such pipes or conduits shall be left clean and free of sediment.
21. In areas where dewatering is required, the Contractor will comply with the following requirements.
- a. All discharges from dewatering systems, including well points, dewatering wells, pumps

in the bottoms of the trenches, etc. will require a permit from the Tennessee Department of Environment and Conservation (TDEC). Before starting any construction, the Contractor shall submit an application to discharge to the TDEC along with this proposed dewatering plan for review.

- b. One copy of the initial application, dewatering plan, and of the permit authorizing the discharge must be provided to the City Engineering office with the application for an excavation permit. Copies of any revisions to the dewatering plan shall be immediately provided to the City Engineering office.

### **3.02 Disposal of Excess Material**

1. Except as otherwise permitted, dispose of excess excavated materials in a legal manner.
2. When making excavations, the various materials excavated shall be piled separately. All concrete and bituminous materials, any soils which cannot be properly compacted, and all other deleterious materials shall be immediately removed from the construction site and properly disposed of in accordance with applicable laws.

### **3.03 Pipe and Structure Installation**

1. The Contractor shall use laser beam equipment, surveying instruments, or other proven techniques to maintain accurate alignment and grade. Reasonable care shall be exercised in handling and laying the pipe and fittings. The interior of all pipe and fitting shall be kept free from dirt and foreign matter at all times, and cleaned out thoroughly before being lowered into the trench. Under no circumstances shall materials be dropped or thrown into the trench.
2. Materials shall be placed where they will not be subject to injury from vehicles or equipment. The contractor's facilities for lowering the pipe into the trench shall be such that neither the pipe nor trench will be damaged or disturbed. Pipe shall be lowered into the trench with rope slings, gin poles, dragline, or trench in such manner as to lay the pipe carefully into place and shall be lowered and laid with the bell end up. Holes shall be dug under the bells so that pipe is unsupported at the pipe connection. The laying of pipe in the finished trench shall be started at the lowest point and laid up. The Contractor shall clean and remove all sand, gravel, concrete, and cement grout that has entered the lines in the process of construction.
3. Any pipe which is broken, cracked, or otherwise unsuitable, as determined by the Engineer, shall be removed and replaced by the contractor at no additional cost to the owner. Any damage to pipe coatings shall be repaired with the same materials used for the original coating before laying the pipe.
4. The Contractor shall keep the pipe, manholes, catch basins, and other structures free from deposits of mud, sand, gravel, or other foreign matter, and in good working condition until the construction is completed and accepted. Upon completion of each line between manholes, a

clear and unobstructed view of the whole bore of a pipe shall be obtained between manholes by use of a light or subreflector. If such view is not apparent an air-filled rubber ball, approved by the Engineer, having a diameter one-inch (1") (25mm) less than the tile to be tested, shall be flushed through the line between manholes. Any obstruction found in any line shall be removed by the contractor without cost to the owner. Any methods used by the contractor to remove deposits of mud, sand, gravel, or other foreign matter from the line shall be approved by the Engineer. Unless specified in the Special Provisions, a leakage test will not be required. However, this does not preclude the fact that obvious and concentrated leaks (such as open joints, pinched gaskets, cracked barrels or bells, etc.) will not be allowed.

5. Pipe shall not be laid on frozen ground, or when trench conditions are unsuitable for such work.
6. The upgrade end of pipelines not terminating in a structure shall be plugged with a cap or plug approved by the Engineer.
7. Fine grading to the bottom of the barrel shall proceed ahead of the pipe laying and, should any over-excavation exceeding two inches (2") (50mm) be encountered, the material added shall be moistened (95% of Standard Proctor) and compacted to the density of the existing subgrade or foundation material shall be added at the Contractor's expense.
8. Bell holes shall be dug for the pipe bells or couplings and the materials placed along the preceding pipe laid. The pipe shall be supported for the bottom 60 degrees and throughout its length (except for the minimum distance necessary at the bell holes). Bell holes shall be adequate to make the joint, but no larger than necessary so that maximum support on undisturbed ground or pipe zone material will be provided for the pipe. The remainder of the pipe shall be surrounded to at least its midpoint by granular bedding material, compacted in maximum six inch (6") (150mm) layers to completely fill all space under and adjacent to pipe.
9. Pipe laying should proceed upgrade with the spigot ends pointed in the direction of flow. No pipe shall be laid in water or when the trench conditions are unsuitable for such work, except by written permission of the Engineer. The Contractor shall make all connections of pipe to the manholes which have previously been constructed.
10. The Contractor shall connect all existing storm inlets and sewers to the new storm sewer as shown on the drawings. These connections shall be made as the storm sewer construction progresses which will require that each section of the new sewer be fully completed and ready for operation as the construction advances.
11. Open excavation shall be satisfactorily protected at all times. At the end of each day's work, the open ends of all pipes shall be protected against the entrance of animals, children, earth, or debris, by bulkheads or stoppers. The bulkheads or stoppers shall be perforated to allow passage of water into the installed pipeline to prevent flotation of the pipeline. Any earth or other material that may find entrance into the main sewer or into any lateral sewer through any

such open end of unplugged branch must be removed at the Contractor's expense.

12. Curved alignments shall be constructed with precast, beveled end concrete radius pipe which meet the same requirements as for straight pipe. Concrete radius pipe less than or equal to 36 inch diameter shall have a minimum centerline radius of 20 feet and all radius pipe greater than 36 inch diameter and less than 72 inch diameter shall have a minimum centerline radius of 30 feet.

### **3.04 Installation of Manholes**

1. Excavation shall be to a depth and size to provide for construction of the manhole. Concrete bases shall be poured on undisturbed ground. Precast concrete bases shall be carefully lowered onto one of the following:
  - a. Six inches (6") (150mm) minimum layer of well-compacted granular material accurately laid to a smooth level surface using a straight edge and hand level.
  - b. Three inches (3") (75 mm) of concrete poured on undisturbed soil.
2. Walls shall be of precast concrete as shown in the standard drawings and shall be constructed to form a complete watertight structure.
3. The Contractor shall provide a minimum of two inches (2") (50mm) and a maximum of twelve inches (12") (300mm) in two-inch (2") (50mm) layers of precast reinforced concrete adjusting rings between the cast iron frame and the manhole top section. Each ring shall be set on a full bed of mortar and shall be made watertight in accordance to Drawing 602-2. Wood will not be allowed as spacers. Adjusting rings shall conform to the size and shape of the casting frame. Frames and covers shall be set to the designated elevation in a full mortar bed.
  - a. The minimum two-inch (2") (50 mm) concrete ring for grade is not needed if grade can be met with a six-inch (6") (150mm) flange on top of the cone section of the manhole.
  - b. If the number of adjusting rings exceeds the maximum twelve inches (12") (300) mm), the manhole shall be reexcavated and a manhole barrel section installed.
4. Manholes shall be set as shown on drawing details. All lifting holes must be grouted in after placement.
5. When manholes are to be constructed in new streets, manhole rings shall be set to the final grade before the street-wearing course is placed. Riser rings shall not be used to make adjustments for new construction. In gravel or unpaved roads, the manhole ring shall be kept four to six inches (4"-6") (100mm-150mm) below the road surface.

6. The invert of all manholes shall be smoothly shaped so as to allow a free, uninterrupted flow of storm water. The invert forming system shall be "A-Lok Tru Contour", or approved equal. Floor troughs shall be furnished for all storm sewers entering manholes. Inverts shall be U-shaped to the 1.0 diameter point before sloping at a 1 to 12 slope to the manhole walls.

### **3.05 Trench Backfilling.**

#### **A. Trench Backfilling**

1. All excavation in trenches shall be backfilled to the original ground surface or to such grades as specified or as shown on the drawings. The backfill shall begin as soon as practical after the pipe has been placed and shall thereafter be carried on as rapidly as the protection of the balance of the work shall permit.
2. No pipe shall be covered before the Project Representative or the Engineer has observed and approved the pipe. If any piping or appurtenance is covered without the approval of the Engineer or Resident Project Representative, at the discretion of the Engineer, the Contractor shall be required to re-excavate to expose the covered materials. The cost of exposing those materials and then backfilling and recompacting will be at the Contractor's expense regardless of the condition of the pipe and/or the materials under question.
3. The Contractor shall completely backfill all excavations before stopping work at the end each day. Open excavations (fenced or unfenced) shall not be allowed overnight or on weekends at any site after work has stopped for the day unless approved by the City.
4. Complete cleanup shall proceed directly behind the backfilling operation to accommodate the return to normal conditions. Should the Contractor, in the City's opinion, fail to pursue diligently the backfilling and cleanup, the amount of work on which complete cleanup has not been accomplished shall be limited to one thousand lineal feet (1,000') (300m) for the entire job. The Contractor shall have sufficient equipment on the job to assure timely backfill and cleanup at all times.

#### **B. Pipe Bedding.**

1. **Class A - Concrete Cradle**  
Class A bedding for storm sewers and culverts shall consist of a continuous concrete cradle up to springline constructed in conformity with the details shown on the Plans or as directed by the Engineer.
2. **Class B - Granular Encasement Bedding**  
Class B bedding shall consist of a bed of granular material having a thickness of at least 150 mm (6 inches) below the bottom of the conduit. For conduits other than precast reinforced concrete box sections and corrugated aluminum and steel box culverts, the bedding shall extend up around the pipe for a depth of not less than 12 inches above the

top of the pipe.

3. Class C - Granular Bedding

Class C bedding shall be constructed by bedding the drainage pipe on a bed of granular material shaped by a template to fit the lower part of the pipe exterior for at least 10 percent of its overall height (Minimum of 4 inches below the bell of the pipe). After pipe installation granular encasement material shall then be rammed and tamped in layers not over 6 inches in loose thickness around the pipe to the springline.

4. Class B bedding shall be provided for all piping unless otherwise shown on the drawings and authorized by the City Engineer.

5. Bedding material shall be placed as shown on the typical trench detail and described above. Spread bedding material to provide continuous and uniform support beneath pipe at all points between bell holes or pipe joints. Particular attention shall be given to the area from the base of the pipe or culvert to the centerline to ensure firm, uniform, and continuous support is obtained and to prevent any lateral movement upon subsequent backfilling or under service conditions. Bedding material shall be placed, prepared, and compacted simultaneously on both sides and lateral movement shall be prevented. Bedding material shall be moisture conditioned to +2% to -4% of optimum and compacted to 90% maximum density, as determined by ASTM D698. Class C bedding material shall be placed manually with shovels, and tamped in maximum 6" lifts and evenly placing the material on both sides of the pipe. Bedding material shall not exhibit pumping (horizontal or vertical displacement) after compaction. Encasement material will then be placed around and over the top of the pipe, but need not be hand placed. During conditions where flexible piping shall be buried in excess of 20 feet in depth, all bedding material shall be moisture conditioned to +2% to -4% of optimum and compacted to 95% maximum density, as determined by ASTM D698.

6. Trench Backfill above the Encasement Zone. Trench backfill above the encasement zone may consist of excavated material or select backfill material. Excavated material shall be used unless the minimum density requirements cannot be met. Select backfill material such as pit run shall be substituted for excavated material to meet compaction requirements. Backfill material shall be pushed onto the slope of the excavated trench and allowed to slide down into the trench. Backfill material shall not be permitted to free fall into the trench until at least one foot (1') (254mm) of cover is over the pipe or culvert. Moisture conditioning may be provided by water trucks or hoses. Excavated or select backfill material shall not exhibit pumping (horizontal or vertical displacement) after compaction.

7. Backfilling shall be done in lifts of uniform layers which will produce the required compaction. Each lift shall be completely compacted over the full width of the excavated area. Compacting shall continue until the specified relative compaction has been attained or until no more settlement occurs. Water jetting of backfill shall not be permitted.

8. In-place densities of compacted backfill material shall be determined by the Engineer using



either ASTM standard test method D1556-82 (Sandcone) or ASTM standard test method D2922-81 (nuclear). The minimum and maximum dry density for non-cohesive materials such as clean sands and gravel shall be determined by ASTM D4253 and D4254. The maximum dry density for cohesive backfill materials, such as clays, silts, etc., shall be determined by ASTM D698.

- a. Backfill above the encasement zone shall be compacted to the minimum densities and moisture conditions listed below. The densities listed below may only be modified through a geotechnical report.

<u>Area</u>	<u>Cohesive</u>
Streets, highway, alleys	95%, $\pm 2\%$
Sidewalks, curbs, and driveway	95%, $\pm 2\%$
Lawns and cultivated areas	90%, $\pm 2\%$

9. Care of Utilities

- a. In excavating and backfilling for pipelines or structures, extreme care must be taken so as to not mar or injure any gas, telephone, sewer, water, power, or television lines. The utility owner shall be notified that the relocation is necessary and shall be given adequate time to provide for the relocation.
10. When the trench excavation for the sewer main and appurtenances is within the rights-of way of state or county highways, the backfilling of the trench, compaction of materials, subgrade preparation and surfacing shall be done in strict accordance with the requirements and specifications of the authority having jurisdiction or as required by these specifications, whichever is more stringent.
  11. In all cases, the Contractor shall blade and compact the roadway after the trench has been backfilled, so that it shall be passable to traffic at all times. The Contractor shall maintain the roadway in a condition acceptable to the City at all times until final acceptance of the entire work by the City.
  12. The Contractor shall also blade and maintain all detours and bypasses. All maintenance work shall be done at no additional compensation. In addition to the blading and maintenance requirements specified, the Contractor shall provide at least one tank truck with pressurized spray bars for spraying water on the streets to control the dust. Dust control shall be required as necessary on all streets after compacting and grading and on all detours and bypasses.
  13. The Contractor is responsible for the complete maintenance of his work at all times. If he fails to provide proper maintenance, and safety or nuisance conditions arise, it is expressly understood that City crews may be directed by the City to provide essential maintenance, and that such work will be done at the expense of the Contractor.

14. The Contractor shall remedy at his own expense any defects that appear in the backfill following completion and during the warranty period.

C. Storm Sewers and Culverts Placed on Fill

1. Fill material placed in areas over which storm sewer or culverts will be constructed shall be select earth material from the elevation of suitable subgrade to the bottom elevation for bedding or foundation of the drainage facility.
2. Placement and Compaction. If storm sewer or culverts are constructed on filled areas, the fill material shall be placed in 6 inch loose layers and compacted to 95 percent of maximum density at plus or minus 2 percent of optimum moisture content as determined by Laboratory Standard Proctor Test (ASTM D 698) up to a point at least 2 feet above the outside top of the pipe or to the foundation of manholes, inlets, special structures, box culverts, concrete channel lining and concrete ditch paving. If compaction standards for storm sewer pipe exceed that of the adjoining fill, the width of compaction for the storm drain shall be not less than the outside diameter of pipe plus 10 feet. If compaction standards for the manhole, inlets, special structure, box culverts, concrete channel lining and concrete ditch paving exceed that of adjoining fill, the limits of compaction for the facility shall be not less than 5 feet outside of the facility base slab.

**3.06 Installation of Structures.**

1. Structures shall be set on a six-inch (6") (150mm) layer of foundation material when directed by the Engineer. The surface shall be accurately graded to provide uniform bearing for the structure.
2. Catch basins shall be constructed at the locations shown on the drawings and approved by the Engineer. The size and type of catch basins shall be shown on the drawings or in the Standard Details of the Specifications. Catch basin frames shall be set accurately to grade. Concrete grout shall then be placed around and beneath the frame to hold the grate securely in place.
3. Manhole castings shall be installed one-fourth inch (1/4") (6.25mm) to one-half inch (1/2") (12.5mm) below the surface of the existing pavement. Where the structure is in unpaved streets, the manhole casting shall be set to the future street elevation. The casting shall be constructed as shown in the Standard Details. The contractor shall provide a minimum of two inches (2") (50mm) and a maximum of twelve inches (12") (300mm) in two inch (2") (50mm) layers of precast reinforced concrete adjusting rings between the cast iron frame and the manhole top section. Each ring shall be set on a full bed of mortar and shall be made watertight. The bearing surface around the perimeter of the frame shall be grouted to a height within two inches (2") (50mm) from the existing street surface, and to a width of twelve inches (12") (300mm) greater than the manhole ring, and a depth of six inches (6") (150mm) below the bottom adjusting rings or one foot (1') (300MM), whichever is greater. The manhole frame

shall then be tacked and asphaltic concrete pavement shall be placed for the final two inches (2") (50mm).

### **3.07 Structure Backfilling.**

- A. Structure backfilling shall cover manholes, catch basins, junction boxes, and any other structure encountered during the course of the work. Fill around structures shall consist of trench backfill meeting the requirements of structural fill material or select backfill material. Fill material shall be spread and compacted to provide continuous and uniform support around the structure. Special attention shall be given to the compaction operation around structures to ensure uniform compaction.
- B.. Do not place fill when the surface to be filled is frozen. Do not place frozen fill.
- C.. Fill around concrete structures shall commence only after concrete has attained 80% of the ultimate compressive strength specified. Remove all form materials, concrete spills, and trash from around the structures before placing fill. Where backfilling on both sides or around the perimeter of a structure is required, place the backfill and compact simultaneously at the same elevation on opposite sides or around the perimeter in lifts.
- D. Place fill material in eight inch (8") (200mm) maximum lifts and compact to at least 95% density for cohesive soils. The moisture content shall be +2% to -2% of optimum.

### **3.08 Cleanup**

- A. Construction cleanup and all backfill operations shall directly follow the storm sewer installation. Cleanup shall be completed to allow local traffic on the street and access to driveways, parking lots, etc.
- B. During construction, all existing gutters, storm drains, runoff channels, etc., shall be kept clean of dirt, rubble, or debris which would impede the flow of storm sewer.

### **3.09 Quality Control**

#### **1. Light Test**

- a. After the trench has been backfilled, a light test shall be made between manholes to check alignment and grade for displacement of pipe. Except for curved alignments shown on the plans, the completed pipeline shall be such that a true circle of light can be seen from one manhole to the next. If alignment or grade is other than specified and displacement of pipe is found, the Contractor shall remedy such defects at his own expense.

#### **2. Leakage Test**

- a. Unless specified in the Special Provisions, a leakage test will not be required. However, this does not preclude the fact that obvious and concentrated leaks (such as open joints, pinched gaskets, cracked barrels, or bells, etc.) will not be allowed.

### 3. Gradation Test

- a. Bedding Material

- i One initial gradation test for each type of material plus one additional test for each one thousand cubic yards (1000 yd<sup>3</sup>) (750m<sup>3</sup>) placed of each material.

- b. Foundation Material

- i One initial gradation test for each type of material plus one additional test for each one thousand cubic yards (1000 yd<sup>3</sup>) (750m<sup>3</sup>) placed of each material.

- c. Structural Fill Material

- i One initial gradation test for each type of material plus one additional test for each one thousand cubic yards (1000 yd<sup>3</sup>) (750m<sup>3</sup>) placed of each material.

- d. Select Backfill Material

- i One initial gradation test for each type of material plus one additional test for each one thousand cubic yards (1000 yd<sup>3</sup>) (750m<sup>3</sup>) placed of each material.

- e. Encasement Backfill Material

- i One initial gradation test for each type of material plus one additional test for each one thousand cubic yards (1000 yd<sup>3</sup>) (750m<sup>3</sup>) placed of each material.

- f. All gradation tests shall be the responsibility of the Contractor using a certified approved testing laboratory acceptable to the Owner and Engineer. The Contractor shall be responsible for all costs associated with gradation testing.

### 4. Density Test

- a. Encasement Zone Material

- i One test for each five hundred lineal feet (500') (150m) pipe installed.

- b. Bedding Zone Material

- i One test for each five hundred lineal feet (500') (150m) pipe installed.

- c. Trench, Select Backfill Material, and/or Structural Fill Material
  - i One standard proctor test ASTM D698 or one relative density test, (ASTM D4253 and D4254) for each type of material for every two foot (2') (600mm) of trench depth above the pipe zone per every three hundred lineal feet (300') (30m) pipe installed. The Engineer may elect to take one test for each one thousand cubic yards (1000yd<sup>3</sup>) (750m<sup>3</sup>) or a portion thereof.
- d. Unless otherwise indicated in the Contract Documents, density and moisture tests shall be the responsibility of the Owner/Engineer. The Contractor shall cooperate with the Engineer or testing agency. If the initial moisture/density tests fail, the Contractor will be responsible for all costs associated with retests, until a passing moisture/density test is completed.

#### 5. Deflection Test

- a. Mandrel or deflection testing for flexible conduit shall be conducted as directed by the City Engineer. Testing shall be conducted using a mandrel with a diameter equal to 95 percent of the inside diameter of the pipe. The test shall be performed without mechanical pulling devices. The mandrel go/no-go, device shall be cylindrical in shape and constructed with either 9 or 16 evenly spaced arms or prongs. Mandrels with few arms will be rejected. Contact length of mandrel's arms shall equal or exceed nominal inside diameter of pipe to be inspected. Critical mandrel dimensions shall carry tolerance of 0.01 inch maximum. Contractor shall provide mandrel and necessary equipment for mandrel test. Mandrel shall be hand-pulled through flexible pipe lines prior to end of warranty period. Sections of pipe not passing mandrel shall be uncovered and rebudded, rerounded, or replaced to the satisfaction of the owner. Repaired section shall be retested. It is also recommended that the contractor perform a mandrel test prior to placing paving surfaces.

### 3.10 Final Acceptance and Record Drawings

A. "Record Drawings" shall be submitted to the City prior to preliminary acceptance of the construction project. "Record Drawings" shall include, in addition to construction drawings and details, "as built" information where it differs from construction drawings and locate information including horizontal and vertical coordinates in the datum established by the City for the Geographical Information System.

#### B. Final Acceptance

1. Final acceptance will not take place until preliminary acceptance is obtained and all paving and curbwalk is completed.
2. Before final acceptance of any storm sewer, the following inspections shall be made:

- a. All lines clean and flushed
  - b. Manholes up to proper grade in a proper condition
3. All punch list items must be completed prior to final acceptance.

**END OF SECTION**

## SECTION 02741

### ASPHALTIC CONCRETE PAVEMENT

#### **PART 1 – Description**

This work shall consist of an asphaltic concrete pavement constructed in one or more layers for surface course(s) and binder course(s). The binder course may also be used as a leveling or bushing course. Binder course shall consist of a hot mixture of aggregate and asphalt prepared in a hot bituminous mixing plant. The binder course shall be constructed on a prepared subgrade, subbase, or base conforming to the lines, grades, thicknesses, and cross-sections shown on the Plans or as directed by the Engineer. The surface course shall consist of an asphaltic concrete pavement composed of a mixture of coarse aggregate, fine aggregate, mineral filler, and asphalt cement, constructed on a prepared roadbed in conformity with the lines, grades, thicknesses, and cross-sections shown on the Plans or directed by the Owner.

#### **PART 2 – Materials And Equipment**

##### 2.01 MATERIALS

- A. Asphalt Cement. Asphalt cement shall conform to the requirements of ASSHTO M 226, Table 2, for the grade specified. Unless otherwise directed, asphalt shall be Viscosity Grade AC-20, PG64-22, or PG 64-28. The type and grade of bituminous material may be changed one step by the Engineer during construction, at now change in unit price.
- B. Course Aggregate. Course aggregate (aggregate retained on the No. 4 sieve) shall be crushed stone meeting the quality requirements of ASTM D 692 with the following exceptions:
  - 1. Crushed limestone shall have a sodium sulfate soundness loss not exceeding 9 percent.
  - 2. For Mix No. 1, material retained on the No. 4 sieve shall have a maximum of 20 percent elongated pieces (length greater than five times the average thicknesses).
  - 3. For Mix No. 2, the aggregate shall contain no more than 5 percent soft or nondurable particles.
  - 4. For Mix No. 3, the aggregate shall contain no more than 5 percent soft or nondurable particles.
- C. Fine Aggregate. The fine aggregate shall consist of natural sand consisting of hard, clean, tough grains which will have a maximum loss of 12 percent when subjected to the sodium sulfate soundness test.
- D. Composition of Mixtures

1. Asphaltic Concrete Surface, Mix No. 1, shall be laid in one course to the thickness shown on the Plans.
2. Asphaltic Concrete Binder, Mix No. 2, shall be laid in one or more courses to the thicknesses shown on the Plans. Mix No. 2 may also be used as a leveling course or bushing course.
3. Asphaltic Concrete Binder, Mix No. 3 shall be laid in one or more courses to the thickness shown on the plans.
4. The composition of the mixes shall be as follows:

Sieve Size	Total Percent Passing by Weight		
	Mix No. 1	Mix No. 2	Mix No. 3
2"	100	100	100
1-1/2"	100	100	90 - 100
3/4"	100	100	65 - 90
3/8"	76 - 96	65 - 95	-----
No. 4	51 - 76	45 - 70	30 - 55
No. 8	36 - 60	25 - 50	20 - 45
No. 30	16 - 40	12 - 30	8 - 25
No. 100	3 - 12	2 - 12	2 - 12
No. 200	2 - 8	1 - 6	1 - 6

5. The proportions of the total mixture, in percent by weight, shall be as follows:

Courses	Combined Mineral Asphalt	Aggregate Cement
Mix No. 1, Surface(Limestone)	92.0 - 96.0	4.0 - 8.0
Mix No. 2, Binder	93.0 - 97.5	2.5 - 7.0
Mix No. 3, Binder	93.0 - 97.5	2.5 - 7.0

6. It is the intent of this Section of the Specifications that the above described mixes shall conform to the following mixtures specified in the Tennessee Department of Transportation Standard Specifications for Road and Bridge construction.

Mix No. 1 - Section 411, Asphaltic Concrete Surface (Hot Mix), Aggregate Grading E.  
 Mix No. 2 - Section 307, Bituminous Plant Mix Base (Hot Mix), Aggregate Grading C.



Mix No. 3 – Section 307, Bituminous Plant Mix Base (Hot Mix),  
Aggregate Grading B.

7. For multiple layer construction, succeeding layers shall not be laid until the previous layer has cooled sufficiently to support the construction equipment
8. When Mix No. 1 is to be used as a surface for traffic lanes, the mineral aggregate shall be composed of not less than 50 percent nor more than 80 percent crushed limestone and not more than 50 percent nor less than 20 percent natural sand. When Mix No. 1 is used for surfacing of shoulders or other non-traffic lane construction, the mineral aggregate may be composed entirely of limestone, including screening and manufactured sand, but in no case shall the mineral aggregate for this construction consist of less than 50 percent limestone. The natural sand shall be so graded that not more than 5 percent will be retained on the No. 4 sieve.

## 2.02 EQUIPMENT

- A. All equipment necessary for the satisfactory performance of this construction shall be on the Project and approved of before work will be permitted to begin. The equipment shall meet the requirements of Specification Section 02710.

## **PART 3 – Execution**

### 3.01 General

- A. The general construction requirements for surface and binder courses shall be as prescribed in the applicable portions of Specification Section 02710

### 3.02 Preparation of Base or Existing Surface

- A. The designated surface upon which asphalt concrete courses are to be placed shall meet the applicable requirements of Specification 02710 and be thoroughly cleaned of all dirt and other foreign or loose matter prior to the application of the Tack Coat or Prime Coat, as specified in TDOT Specification Sections 402 and 403.

### 3.03 Thickness And Surface Requirements

- A. Thickness shall be controlled during the spreading operations by frequent measurements taken of freshly spread mixture to establish a relationship between the un-compacted and compacted material. This thickness shall remain in conformity with that specified on the Plans. The surface of all courses shall meet the requirements specified under Specification Section 02710 and when tested in

accordance with the provisions of Specification Section 02710 the deviation of the surfaces from the testing edge of the straightedge shall not exceed 1/4 inch for Mix No. 1 or 3/8 inch for Mix No. 2 and Mix No. 3.

### 3.04 Manhole Adjustments

- A. Drainage and sanitary sewer manholes owned by the City shall be adjusted and set at final grade by the Contractor as necessary for compliance with the Plans. Adjustments of City owned manholes shall be as specified in Section 02530 or 02632 of these Specifications. Manholes, valve boxes, and other utility structures not owned by the City but within the right-of-way of the project shall be adjusted as necessary by the owner of such facilities. The Contractor shall be responsible for notifying other owners of any required adjustments and for the accomplishment of that work by the owner of such facilities according to the project schedule.

### 3.05 Traffic And Maintenance

- A. The Owner will determine when the surface course has sufficient compaction and has cured sufficiently to allow construction equipment, slow moving local traffic, or normal traffic to use the completed surface.

**END OF SECTION**

## SECTION 02770

### CONCRETE CURB, CURB AND GUTTER, VALLEY GUTTERS, SIDEWALK, AND DRIVEWAYS

#### **PART 1 - Description**

The work covered by this section consists of furnishing all equipment, labor, and materials necessary for constructing concrete curb, curb and gutter, valley gutters, sidewalks, and driveways on natural or prepared subgrades and bases, completed in accordance with the following specifications and dimensions shown on the plans.

#### **PART 2 – Materials**

##### **2.01 Materials**

##### **A. Portland Cement Concrete**

1. Portland Cement Concrete shall conform to the requirements specified under Section 03050 Portland Cement Concrete

##### **B. Reinforcing Steel and Fibers**

1. Reinforcing steel for concrete reinforcement shall meet the requirements of ASTM A615, Grade 60.
2. Welded wire fabric for concrete reinforcement shall meet the requirement as ASTM A185. Mesh shall be welded plain cold-drawn steel wire fabric.
3. Reinforcing Fibers
  - a. Concrete reinforcing fibers shall be polypropylene collated, fibrillated fibers designed and engineered specifically for use as secondary reinforcement for concrete, shall be three-quarter inch (3/4") (20mm) to one inch (1") (25mm) in length and be manufactured by Fibermesh Company, Forta Corporation, or approved equal.

##### **C. Preformed Expansion Joint Material**

1. Preformed joint material shall comply with the requirement of ASTM D994, ASTM D1751, or ASTM D1752.

##### **D. Leveling Base Course**

1. Base course materials, if specified, shall conform to the requirements of sand with less than 10% passing No. 200 sieve.

#### E. Forms

1. Concrete forms shall be wood, steel, or other suitable material of size and strength to resist movement during concrete placement and to retain horizontal and vertical alignment until removal.
2. Forms shall be coated with a non-staining agent that will not discolor or deface surface of concrete.

#### F. Curing Compound

1. Curing compound shall be poly-alpha-methyl-styrene (PAMS) meeting AASHTO 148 Class B, or engineer approved equivalent.

#### G. Foundation Material

1. Refer to Section 02632 for Foundation Material

#### H. Aggregates

1. Course and fine Aggregates shall meet the requirements of ASTM C33 Article 2. Concrete mix under this Section shall meet one and one half inch (1½") (37.5 mm) sieve size, as specified in Division 300, Section 301.

### 2.03 Subgrade and Base

#### A. Natural Subgrades.

1. Subgrade shall be cut to the grade to accommodate concrete improvement being specified. The upper eight inches (8") (200mm) of the subgrade shall be compacted to a dry density of at least 95% of maximum dry density as determined by ASTM D698 at a moisture content of  $\pm 2\%$  of optimum. The finished surface of the subgrade shall be smooth, free from surface irregularities, and true to line and grade as established by grade hubs or pins.
2. Compaction tests shall be performed a minimum of every one hundred fifty feet (150') (45m) of curb walk or side walk, once for each valley gutter, and once for each driveway not part of a section of curb walk being tested. This testing requirement is only applicable for new subdivision construction.

- B. Trenches crossing curbwalk, valley gutters, or other concrete paving within the City right-of-way shall be compacted the full depth of the trench and shall be compacted to a dry density of at least 95% of maximum dry density as determined by ASTM D698 at a moisture content of  $\pm 2\%$  of optimum. This applies to all trenches installed for any purpose. Prepared Subgrades with

## Foundation Material

1. Where spongy, organic, or otherwise unsuitable material is encountered, which, in the opinion of the Engineer is unsuitable for subgrade, such unsuitable material shall be removed to a minimum of twelve inches (12") (300mm) below the four inch (4") (100mm) thick leveling base course, and replaced with foundation material. The Engineer may direct the Contractor to excavate deeper than the specified twelve inches (12") (300mm).
2. All foundation material shall be compacted to 95% of maximum dry density, as determined by ASTM D698 at a moisture content of  $\pm 2\%$  of optimum. Tree roots shall be removed at least one foot (1') (300mm) laterally and twelve inches (12") (300mm) vertically below all prepared subgrades.

## C. Proof Rolling

1. Subgrades shall be proof rolled after compaction testing requirements have been passed and prior to placement of the leveling base course.
2. Proof rolling shall be performed in the presence of the Engineer and a representative of the City Engineer's office.

## D. Leveling Base Course.

1. Just prior to placement of concrete, the four inch (4") (100mm) thick leveling base course shall be accurately graded to conform to the grade of the forms, and sprinkled if necessary until the moisture content is at or near optimum moisture content. Optimum moisture content shall be determined by the Engineer in accordance with ASTM D698. In no case shall concrete be placed on a saturated base or if free water is standing on the base. This paragraph applies in areas where spot concrete improvements are scheduled such as short runs of new curb and gutter and in areas where valley gutters are removed and replaced and or where concrete is placed manually in lieu of machine placement.

## 2.04 Forms

- A. When using forms, they shall be of wood or metal, straight, free from warp, and of sufficient strength when staked to resist the pressure of the concrete without springing, and the upper edge shall form a true line. Outside forms for the curbwalk shall be of a depth equal to the full depth of the sidewalk, and the inside forms shall be of the depth of the gutter and shall be so designed as to permit secure fastening to the outside form. All forms shall be cleaned thoroughly and greased or oiled before concrete is placed against them. Forms that have become worn, bent, or broken shall not be used. Forms shall be securely set true to line and grade.
- B. On short radii curves, steel plates, which can be readily formed to the desired radii, shall be used. Face forms, if used, shall be preshaped to the proper radii. Care shall be exercised to insure the maintenance of the required cross-section around the entire radius.

- C. The Contractor shall provide an approved metal straight edge, ten feet (10') (3m) in length for use in checking the alignment of the forms prior to placing the concrete and also to check the concrete surface during the finishing operation. Forms and the final product shall not deviate more than one-quarter inch (1/4") (6.25mm) from a straight edge ten feet (10') (250mm) in length and shall be sloped to achieve complete drainage without "bird baths."
- D. Forms shall remain in place at least twelve (12) hours after concrete has been placed against them or for a longer period if so directed by the Engineer. Crowbars or other heavy tools shall not be used against green concrete in removing the forms. Forms shall be well cleaned before reoiling and reuse.
- E. Screed guide templates shall be pulled prior to the concrete taking initial set. In those cases where initial set takes place prior to pulling of the templates, the joint shall be sealed with an asphaltic sealing compound approved by the Engineer.

## **2.05 Protection**

- A. Protect fresh concrete from deleterious effects of weather and from traffic until adequately cured.
- B. Concrete shall not be placed on frozen subgrade or when weather is stormy, dusty, or otherwise inclement to the point that it precludes good workmanship. Air temperature shall be a minimum of 40° F (4°C) and rising when the pour is started. Adequate measures shall be employed to protect the concrete from freezing for a period of at least seventy-two (72) hours after it is poured.

## **2.06 Joint Construction**

### **A. Expansion Joints**

- 1. All expansion joints shall be constructed straight, plumb, and shall extend through the full width and depth of the section. Expansion joint material shall be flush with the finished surface to three-quarters inch (3/4") (20 mm) below the finished surface. Edges adjacent to expansion joint material shall be tooled.
- 2. Expansion joints shall be constructed at the intersection with any existing curbwalk or curb and gutter, at the tangent point of curb radii, at alley returns, adjacent to inlet structures and at intermediate intervals of not more than sixty feet (60') (18m) or at such lesser spacing as may be determined by the Engineer.

### **B. Contraction Joints**

- 1. Transverse weakened-plane contraction joints shall be constructed at right angles to the curb line at intervals of ten feet (10') (3.1m). Joint depth shall average at least one-fourth (1/4) of the cross-section of the concrete.
- 2. Contraction joints may be sawed, hand formed, or made by one-eighth inch (1/8") (3mm) thick

division plates in the formwork. Sawing shall be done early after the concrete has set to prevent the formation of uncontrolled cracking. The joints may be hand formed either by 1) using a narrow or triangular jointing tool or a thin metal blade to impress a plane of weakness into the plastic concrete; or, 2) inserting one-eighth inch (1/8") (3mm) thick steel strips into the plastic concrete temporarily. Steel strips shall be withdrawn before final finishing of the concrete.

3. After removal of templates and finishing, contraction joints shall be reopened with a mason's trowel to a depth of one-fourth (1/4) the thickness of the section, the line of cut coinciding with and extending into the joint formed by the template. The joints shall be finished with a jointer.

#### C. Construction Joints

1. At end of day's run, or in case of an interruption which would result in cold joint, construction joints shall be made at right angles to the longitudinal axis of the curbwalk and shall be located at the regular five foot (5') (1.5m) spacing designated for contraction joints unless otherwise specifically permitted by the Engineer. In no case shall any length of curbwalk be less than five feet (5') (1.5m) between joints.
2. Construction joints shall be formed by use of a bulkhead or divider which shall be removed before continuing with the next run. Edges of construction joints shall be edge tooled to form a recess for sealing compound.

### **2.07 Concrete Placement**

A. Concrete shall be placed either by an approved slipform/extrusion machine, by the formed method, or by a combination of these methods. Concrete shall not be placed until base courses and forms have been checked for depth and alignment. The method used shall adequately vibrate and compact the concrete to achieve a homogeneous dense concrete free from honeycomb and pockets of segregated aggregate.

#### B. Machine Placement

1. The slipform/extrusion machine approved shall be so designed as to place, spread, consolidate, screed, and finish the concrete in one complete pass in such a manner that a minimum of hand finishing will be necessary to provide a dense and homogeneous concrete section.
2. The machine shall shape, vibrate, and/or extrude the concrete for the full width and depth of the concrete section being placed. It shall be operated with as nearly a continuous forward movement as possible.
3. All operations of mixing, delivery, and spreading concrete shall be so coordinated as to provide uniform progress, with stopping and starting of the machine held to a minimum.

#### C. Formed Method

1. Construct forms to the shape, lines, grades, and dimensions called for in the Drawings. Set wood or steel forms securely in place, true to line and grade. Forms shall be braced to prevent change of shape or movement in any direction resulting from the weight of the concrete during placement. Tops of forms shall not depart from grade line more than one-fourth inch (1/4") (6.25mm) when checked with a ten-foot (10') (3m) straightedge. Alignment of straight sections shall not vary more than one-fourth inch (1/4") (6.25mm) in ten feet (10') (3m).

## **2.08 Finishing**

- A. Finishing shall be done with a metal screed or mule designed to give proper shape to the section as detailed. Particular care shall be used to finish the gutter flow line to a true, uniform grade that will drain completely without "bird baths". The back of the curbwalk and toe of the gutter shall be edge tooled. Traffic surfaces shall be broom finished at 90° to the direction of traffic. All honeycombed areas or small defects shall be patched with 1:2 mix mortar.
- B. After stripping forms, exposed concrete surfaces shall be finished smooth and even by means of a moist wood float or a moist brick.
- C. Sides of concrete exposed by the removal of forms shall be protected immediately to provide continuance of curing and preventing injury to the edge and the underlying subgrade. After the forms have been removed, suitable fill material shall be placed along the edge of the walk and tamped by either hand or mechanical tampers to a density at least equal to that of the adjacent ground. The finish grade and section shall be as indicated on the drawings and to the satisfaction of the Engineer.
- D. Protection And Repairs
  1. Protection: Immediately after placement, protect concrete from premature drying, excessively hot or cold temperatures, and mechanical injury.
  2. Maintain concrete with minimum moisture loss at relatively constant temperature for period necessary for hydration of cement and hardening of concrete.
  3. Random Cracks in Pavement Slabs on Grade: When cracks occur within 2 feet (0.61 meters) of expansion or construction joints, remove and repair, otherwise grout with epoxy adhesive grout. Use saw cuts and dowels in all cut planes.
  4. Random Cracks in Curb and Gutter: When concrete cracks larger than hairline cracks appear in curb and gutter and are the width of a penny standing on edge, Engineer shall direct Contractor to remove and replace concrete curb and gutter sections. Sections to be replaced shall be a minimum of five feet in length. When cracks are hairline in width, repair with epoxy adhesive grout.



## **2.09 Curing**

- A. Concrete shall be sprayed uniformly with curing compound immediately after finishing of the surface and before the set of the concrete has taken place. Curing compound shall be applied at the manufacturer's recommended rate.
- B. Curing compound shall also be applied immediately to the exposed concrete once forms have been removed.
- C. See section 2.02 F for approved curing compounds.

## **2.05 Jointing New and Existing Curb Sections**

Where the new concrete sections will join existing concrete sections with a different cross-section, five foot (5') (1.5m) long minimum transition section shall be constructed.

## **2.11 Fiber Reinforced Concrete**

- A. Where specified or approved by the Engineer, provide polypropylene fibers added to the concrete mix to control shrinkage cracks.
- B. Polypropylene fibers shall be added at the rate of three pounds (3#) (1.4 kg) of fiber per cubic yard of concrete. Fibers shall be added to the concrete in accordance with the manufacturer's recommendations.

## **2.13 Cutting and Patching of Asphalt Paving.**

- A. When curb cuts, or other concrete structures are installed adjacent to existing asphaltic concrete paving, the asphalt paving shall be saw cut parallel to and a minimum of eighteen inches (18") (450mm) away from the edge of the concrete.
- B. The excavation between the concrete and the asphalt paving shall be backfilled with a minimum of two and one-half inches (2.5 inches) of asphalt over a specified base course. Base course and asphaltic concrete paving shall comply with City of Lakeland standard specification.
- C. Where the existing pavement and base course sections exceed the minimums specified above, the replacement thickness shall match the existing.

**END OF SECTION**

**SECTION 02835**  
**SEEDING AND LAWN RESTORATION**

**PART 1 - DESCRIPTION**

**1.01 General**

The work covered in this article includes the furnishing of all materials, labor, tools and equipment for seeding and lawn restoration as described in the specifications.

**PART 2 - MATERIALS**

**2.01 Materials**

A. Type A – Native Seed

1. Priority should be given to native species in any mixture due to the level of damage that non-native species are currently exhibiting within the City as noted by the Natural Resources Inventory. Suggested native seed mixes are shown below but can be modified to include a variety of native warm season grasses and native forbs. Suggested native warm season grasses include:
  - (a) Big bluestem (*Andropogon gerardii*)
  - (b) Little bluestem (*Schizachyrium scoparium*)
  - (c) Indiangrass (*Sorghastrum nutans*)
  - (d) Broomsedge bluestem (*Andropogon virginicus*)
  - (e) Sideoats grama (*Bouteloua curtipendula*)
  - (f) Switchgrass (*Panicum virgatum*)
  - (g) Eastern gamagrass (*Tripsacum dactyloides*)
  
2. Any native warm season grass mixture should contain no more than 30% of one species. Native forbs may be included in the seed mixture including but not limited to:
  - (a) partridge pea (*Chamaecrista fasciculata*)
  - (b) Illinois bundleflower (*Desmanthus illinoensis*)
  - (c) roundhead lespedeza (*Lespedeza capitata*)
  - (d) perennial sunflowers (*Helianthus salicifolius*)
  - (e) purple prairieclover (*Dalea purpurea* var. *purpurea*)
  - (f) purple coneflower (*Echinacea purpurea*)
  - (g) Tennessee Coneflower (*Echinacea tennesseensis*)
  - (h) black-eyed susan (*Rudbeckia hirta*)
  - (i) blazing star (*Liatris spicata* / *Liatris squarrulosa*)
  - (j) lance-leaved coreopsis (*Coreopsis lanceolata*)
  - (k) joe pyeweed (*Eupatorium purpureum* var. *purpureum*)
  - (l) evening primrose (*Oenothera biennis*)

- (m) New England aster (*Symphyotrichum novae-angliae*)  
 (n) Indian blanket (*Gaillardia pulchella* var. *pulchella*)

Suggested Type A Seed Mixes With Planting Dates

Native Grass Mixture	Little Bluestem Indian Grass Side Oats Grama Big Bluestem Switchgrass (native) ( <i>Panicum virgatum</i> )	April 1 – June 30
Southeast Native Mixture	Indiangrass Little Bluestem Switchgrass Big Bluestem Lovegrass (Native only)	March 1 – June 15
Songbird Native Grass /Wildflower Mixture (Useful near conservation easements or natural areas for establishment of wildlife habitat)	Side Oats Grama Little Bluestem Indian Blanket Lance-leaved Coreopsis Purple Coneflower Goldenrod Joe Pyeweed Evening Primrose New England Aster Black-Eyed Susan	April 1 – June 15  August 15 – October 15
Wetland Mixture	Red Top (Native only) Virginia Wild Rye Fox Sedge Woolgrass Soft Rush Lurid Sedge Joe Pyeweed	March 15 – June 15  August 15 – October 15
Native Rough Mixture (Fescue mix may not be appropriate in all locations due to invasive nature)	Hard Fescue Little Bluestem Chewings Fescue Blue Fescue	March 15 - June 1 August 15 – October

- Some of the above mixtures may not be appropriate near natural areas due to the inclusion of non-natives and plants that are invasive by nature. Mowing should only be done in late October and late February to early March. Other forms of maintenance (that closely resemble natural disturbance) may be needed to exclude undesirables and to further promote the growth and spread of the native grasses.
- Type A seed mix should be sown at approximate rates of 4-8 pounds pure live seed (PLS) per acre. Seed purity should be no less than 50% PLS.

B. Type B – Lawn Seed

1. Bermuda, Zoysia, and Fescue shall be used in areas where frequent mowing occurs. An established mowing schedule shall be in place in order to prevent species from becoming invasive.

- C. Grass seed mixtures under brand names may be acceptable if they approach the above specifications and if accepted by the City Engineer. All seed types shall meet the requirements of the Tennessee Department of Agriculture and no Below Standard seed will be accepted. Grass seed furnished under these specifications shall be packed in new bags or bags that are sound and not mended. The vendor shall furnish the Engineer a certified laboratory report from an accredited commercial seed laboratory or from a State seed laboratory showing the analysis of the seed to be furnished.

D. Tackifiers

1. Tackifiers shall be a synthetic polyacrylamide tackifier. The tackifier shall water soluble and anionic in nature. Cationic tackifiers shall not be permitted. Organic tackifiers such as starch based compounds may be substituted upon approval of the engineer.

E. Mulch

1. Hay or straw mulch materials shall be air dried and reasonable free of noxious weeds and weed seeds or other materials detrimental to plant growth. Hay shall be stalks of approved grasses, sedges or legumes seasoned before bailing or loading. Straw shall be stalks of rye, oats, wheat, or other approved grain crops. Both hay and straw shall be suitable for spreading with standard mulch blower equipment.
2. Wood fiber mulch shall be in accordance with Section 02925.

**PART 3 - EXECUTION**

**3.01 Restoration of Lawn and Grassed Areas.**

- A. Any sod which is disturbed during the project or its appurtenances shall be replaced with similar sod including necessary topsoil, by the Contractor.
1. Top soil shall be replaced to a thickness equal to that removed up to a maximum of six inches (6") (150mm). No sod or seed shall be laid on less than four inches (4") (100mm) of topsoil. Topsoil shall be light friable loam containing a liberal amount of humus and shall be free from heavy clay, coarse sand, stones, plants, roots, sticks, and other foreign materials.

2. Sod shall be rolled within 24 hours after its placement with a roller that leaves the sod smooth and the joints properly closed. The new sod shall be trimmed neatly to match old sod, curbs, and walks. In all sod areas, the Contractor shall be responsible for ensuring adequate moisture until the new sod has properly established itself.
- B. In other areas, the Contractor shall reseed as specified in the City's Standard Specifications.
1. In general, Type A seeding shall be used in undeveloped areas having a "native" grass vegetation. After the disturbed area has been backfilled as specified, the Contractor shall place four inches (4") inches (100mm) of topsoil over the disturbed area, prior to Type A, seeding. The area to be seeded shall be made smooth and uniform and shall conform with the finished grade. Type B seeding shall be used in developed areas where the disturbed vegetation would not be classified as sod. For temporary seeding of disturbed areas, Type A seed shall be used.
  2. The seedbed, if not loose, shall be loosened to a depth of from 1 to 2 inches (25-50mm) below finished grade. Seeds and fertilizers can be sown with standard agricultural drills, or other approved methods. Grass seeds may be sown broadcast or with a special seeder attachment on agricultural drills, but shall not be covered with more than ½-inch (12mm) of soil, whether drilled or raked in. If not covered by the drill, all uncovered seed shall, immediately after sowing, be slightly raked or harrowed to cover the seed. No seed shall be broadcast during high wind.
  3. Seeding shall be done in accordance with the manufacturers recommendation and approved of by the City Engineer. During other periods, the time of sowing shall be determined by the Engineer, whose decisions will be based on the moisture content of the soil and weather conditions.

### **3.02 Fertilization, Mulching and Tackifier**

- A. Fertilizer shall be applied in accordance to the soils analysis recommendation. Cellulose hydromulch shall be applied according to manufacturer's recommendation.

### **3.03 Warranty**

- A. Weed control in planted areas shall be the responsibility of the Contractor. Watering schedules of City-owned property shall be the responsibility of the Contractor during the warranty period.

**END OF SECTION**

## SECTION 03050

### PORTLAND CEMENT CONCRETE

#### Part 1-Description.

The work covered in this section includes the classification, materials, proportioning of materials, equipment, mixing requirements, and testing for Portland Cement Concrete to be used for curbs, curb and gutter, and sidewalks, streets, bridges, and miscellaneous structures.

#### Part 2 - Materials

2.01. Classes of Portland Cement Concrete. Portland cement concrete used for construction of the various items specified elsewhere in these Specifications shall be classified by usage as follows:

A. Class A.

Class A concrete shall be used as specified for such items as directed by the Engineer and other uses as noted in the Special Provisions.

B. Class AS.

Class AS concrete shall be used for storm and sanitary structures, concrete curb, curb and gutter, valley gutters, sidewalks, ditch paving, and similar structures unless otherwise noted in the Special Provisions.

C. Class B.

Class B concrete shall be used for roadway base, soil cement, and pavement.

D. Class C.

Class C concrete shall be used as specified for such items as concrete cradles, encasements, embankment slope paving at bridge abutments, and other low strength applications.

E. Class P.

Class P concrete shall be used for cast-in-place box culverts and precast and precast-prestressed concrete structures or structural members. High-early-strength concrete shall be as specified in Specification Section 03050 Paragraph 6.05.

2.02 Materials.

A. Portland Cement.

1. Type I or Type I-SM cement shall be used unless otherwise specified. Different types of cement shall not be mixed. Portland Cement shall conform to all requirements of the "Standard Specifications for Portland Cement," AASHTO M 85. M. Specification C150 for Class Type I, except that for high early strength concrete, Type III cement may be used.

B. Fine Aggregate.

1. Fine aggregate for concrete shall consist of sand and shall conform to the following ASSHTO M6 with the following exceptions.

i. General Composition. Concrete sand shall be composed of clean (washed), hard, durable, uncoated grains, free from injurious amounts of clay, dust, soft flaky particles, loam, shale, alkali, organic matter, or other deleterious matter. Fine aggregate shall not contain appreciable materials which have unsatisfactory expansive properties when combined with Portland Cement and water.

ii. Sieve Analysis. Fine aggregate shall be graded within the following limits:

Sieve	% Passing by Weight	
	Min.	Max.
3/8" (9.5mm)	100	---
No. 4 (4.75mm)	95	100
No. 8 (2.36mm)	80	100
No. 16 (1.18mm)	50	90
No. 50 (330um)	5-30	
No. 100 (150um)	0	10
No. 200 (75um)	0	3

Deleterious Substances. The fine aggregate shall not contain more than the following maximum amounts of deleterious substances:

	<u>Max. % of Weight</u>
Clay lumps.	0.5
Coal, lignite, or shale.	0.5
Material passing the No. 200 Sieve.	3.0
Other deleterious substances such as Shale, alkali, mica, coated/grains soft and flaky particles.	3.0

If the fine aggregate is manufactured from limestone or dolomite and if the material finer than the No. 200 sieve consists of dust of fracture, essentially free from clay or shale, this limit may be increased from 3% to 5%

iv. Organic Impurities. Fine aggregate subjected to the colorimetric test as per ASTM C40 for organic impurities and producing a color darker than the standard shall be rejected unless it passes the mortar strength test as specified herein, Organic Impurities ASTM C40.

C. Coarse Aggregate. Coarse aggregate for concrete shall consist of crushed stone or gravel or crushed or uncrushed gravel and shall conform to the following requirements:

1. Coarse aggregate for Class A, Class B, or Class C concrete shall be furnished in two sizes: Size No. 4 and Size No. 67 as shown hereinafter in the attached Table Coarse

Aggregate Gradation Table.

2. The two sizes shall be manufactured, within the specified limits, to produce Size No. 467 when combined in the proper proportions at the batching plant. If the supplier provides a proper stockpile to prevent segregation, then a combined Size No. 467 can be used in lieu of blending Size No. 4 and Size No. 67.

3. Coarse aggregate for Class AS concrete shall be Size No. 57. Only limestone coarse aggregate will be used for Class AS concrete; gravel coarse aggregate will not be permitted.

4. Coarse aggregate for Class P concrete shall be size No. 57 or Size No. 67 as may be specified or directed. Only limestone coarse aggregate shall be used for Class P concrete; gravel coarse aggregate will not be permitted.

5. Coarse aggregate for concrete curbing placed by machine extrusion methods shall be Size No. 57 or Size No. 67.

6. The coarse aggregates shall otherwise conform to the requirements of AASHTO M 80 and ASTM C 33 with the following exceptions and stipulations:

a. Deleterious Substances. The coarse aggregate shall not contain more than the following maximum amounts of deleterious substances:

	<u>Max. % of Weight</u>
Clay lumps	0.25
Material passing No. 200 sieve	1.0
Coal or Lignite	1.0
Other deleterious substances such as friable, thin, elongated, or laminated pieces	10.00
Other Local deleterious substances	1.00
Soft or nondurable fragments (fragments which Are structurally weak such as shale, soft Sandstone, limonite concretions, gypsum, Weathered schist, or cemented gravel.	3.0

7. The sum of the above, excepting thin or elongated pieces, shall not exceed 5% by weight.

8. Soundness. When subjected to 5 cycles of the soundness test, as set forth in ASTM C88, the loss in weight of coarse aggregate weighted in accordance with the grading of a sample complying with the grading requirements specified, shall not exceed nine (9) percent for sodium sulfate.

9. Abrasion. The coarse aggregate shall not have an abrasive loss greater than 40% as determined by AASHTO T96.

10. In the case of crushed aggregate, if all the material finer than the 200 mesh sieve consists of the dust of fracture essentially free of clay or shale, Item 4, Maximum Per Cent by Weight, may be increased to 1.5.



**COARSE AGGREGATE GRADATION TABLE**  
 Amounts Finer than Each Lab. Sieve (Sq. Opening), %By Weight

SIZE NO.	2"	1-1/2"	1"	3/4"	1/2"	3/8"	NO. 4	NO. 8
4	100	90-100	20-55	0-15	-----	0-5	-----	-----
467	100	95-100	-----	35-70	-----	10-30	0-5	-----
57	-----	100	95-100	-----	25-60	-----	0-10	0-5
67	-----	-----	100	90--100	-----	20-55	0-10	0-5

- D. Water for Concrete. The water shall be clean and free from objectionable amounts of oil, acid, alkali, organic matter, or other deleterious materials and shall not be used until the source of supply has been approved. If at any time the water from an approved source becomes of unsatisfactory quality or insufficient quantity, the Contractor will be required to provide satisfactory water from another source. Water of questionable quality shall be subject to the acceptance criteria of Table I, as specified in ASHTO T26.
- E. Air-Entraining Admixture. The Contractor shall use a regular Portland Cement with the addition of an air-entraining admixture meeting requirements of AASHTO M 154. Air-entraining admixtures to be used in air-entrained concrete shall be Darex AEA, Neutralized Vinsol Resin, and Protex, or any other air-entraining agent meeting the approval of the Engineer. Air-entraining admixtures shall contain no chlorides. The air-entraining characteristics of the admixture, in suitable proportions in combination with Portland Cement, fine aggregate and water, within the limits of the proportion specified, shall be such that the resulting concrete will have a satisfactory workability, and the total air content shall be as provided below in the following table.

Nominal Max Size of Coarse Aggregate	Total Air Content Percentage by Volume Concrete
3/8 inch	6 to 10
1/2 inch	5 to 9
3/4 inch	4 to 8
1 inch	3 1/2 to 6 1/2
1 1/2 inch	3 to 6
2 inch	2 1/2 to 5 1/2
3inch	1 1/2 to 4 1/2

- F. Chemical Admixtures. Chemical admixtures shall conform to ASTM C494, except TYPE C accelerating admixtures shall contain no chlorides, shall be non-toxic after thirty (30) days, and shall be compatible with air-entraining admixtures. The amount of admixture added to the concrete shall be in accordance with the manufacturer's recommendations.
- G. Pozzolan Admixture. Pozzolan admixture shall conform to the requirements of ASTM C311 and ASTM C618-85 (including Table IA) for either Class C or Class F. Class C fly ash may be used as a replacement for Portland cement if approved in writing by the Owner. The maximum amount of cement being replaced by fly ash shall not exceed 15 percent. When a specific air content has been required and fly ash is being used, the air content shall be tested on each truck load of concrete at the batch plant and the tested value shall be indicated on the ticket.
- H. Fiber-Reinforced Concrete shall conform to ASTM C1116 material requirements and classifications. Concrete containing fibers (steel, glass fibers, or synthetic fibers) shall conform to the manufacturers addition rate and shall be included in the mix design approved by the Engineer. Glass Fiber and synthetic fiber reinforced concrete shall not be used to replace structural reinforcement, and shall be added at the batch plant.

### **PART 3 – Execution**

#### **3.01 Sampling and Testing and Storage of Materials.**

- A. Cement. Cement may be accepted on the basis of mill tests and the manufacturer's certification of compliance with the specifications, provided the cement is the product of a mill with a record for production of high quality cement. Certificates of compliance shall be furnished the Engineer by the Contractor, for each lot of cement furnished prior to use of cement in the work. This requirement is applicable to cement for job-mixed, ready-mixed, or transit-mixed concrete. Cement proposed for use where no certificate of compliance is furnished, or where, in the opinion of the Engineer, the cement furnished under certificate of compliance may have become damaged in transit or deteriorated because of age or improper storage, will be sampled at the mixing site and tested for conformance to the specifications.
  - 1. Cement will be approved for use if it satisfactorily passes the fineness, soundness, and time of set test requirements specified, provided the general run of materials has been satisfactorily meeting the 28-day strength requirements. Any approved cement failing to pass the 28-day strength requirements, if unused, shall be rejected. If, in the judgement of the Engineer, it is considered necessary, other lots of shipments from the same mill may be held for the results of tests before being used.
  - 2. If cement is supplied from a new source or from a source of unknown quality, it may be held for the results of strength test before being approved.
- B. Fine and Coarse Aggregate. At least two (2) weeks in advance of the beginning of concrete work the Contractor shall submit to an approved materials testing laboratory approximately five hundred pound (500#) (225kg) samples of each concrete aggregate proposed for use unless otherwise waived by the Engineer in writing. All tests which are necessary to determine the

compliance of the concrete materials with these specifications shall be performed on these samples. These samples shall also be used by the laboratory as the basis for a concrete mix design. The results of all tests and the concrete mix design shall be submitted to and approved by the City Engineer prior to the start of any concrete work. Standards shall conform to the latest applicable codes. The sampling and testing shall conform to the following standard procedures:

- C. **Cement.** The Contractor shall provide adequate protection for the cement against dampness. No cement shall be used that has become caked or lumpy. Accepted cement which has been held in storage more than 90 days after shipment from the mill shall be retested, and if failing to meet the requirements specified herein shall be rejected.
  - 1. Accepted cement which has been stored in approved sealed bins at the mill for not more than six (6) months may be used without further testing unless a retest is specifically requested by the Engineer.
  
- D. **Aggregate.** Aggregates shall be handled and stored in separate piles at the site in such manner as to avoid a separation of the coarse and fine particles and contamination by foreign materials. Sites for stockpiles shall be prepared and maintained in such a manner as to prevent the mixing of deleterious materials with the aggregate. The Contractor shall deposit material in stockpiles at the batching plant site until the moisture content becomes uniform. Stockpiles shall be built in layers not to exceed three feet (3') (1m) in height, and each layer shall be completed before beginning the next one.
  - 1. Coning or building up stockpiles by depositing the materials in one place will not be permitted. The storing of aggregates in stockpiles, or otherwise, upon the subgrade or shoulders will not be permitted.

### **3.02 Concrete Mixture Requirements.**

- A. The concrete shall meet the following requirements as outlined in the Concrete Classification Table attached to the end of this Section.
  - 1. If it is found impossible to produce concrete having the required air content with the materials and mixing procedures that are being used, the Contractor shall make such changes in the materials or mixing procedures, or both, as may be necessary to insure full compliance with the requirements of air content in the concrete.
  - 2. The total weight of aggregates per sack of cement and the relative proportions of coarse and fine aggregate shall be determined by yield tests made during the progress of the work. The Engineer may, at his discretion, adjust the laboratory mix design to obtain the proper yield, and consistency of concrete.
  - 3. The Contractor shall receive written permission from the Engineer prior to adding Pozzolan admixture to Portland Cement Concrete.

4. Any combination of aggregates which requires the use of more than six and one-half gallons (6.5g) (25l) of water per sack of cement to produce a workable mixture, with the brand of cement used will be considered as being unsatisfactory, and all such combinations of aggregate will be rejected.
5. Concrete shall be uniformly plastic, cohesive, and workable. Workable concrete is defined as concrete which can be placed without honeycomb and without voids in the surface. Workability shall be obtained without producing a condition such that free water appears on the surface when finished. The consistency of the mixture shall be that required for the specified conditions and methods of placement; however, the previously determined maximum water cement ratio shall not be exceeded.

### **3.03 Proportioning of Materials.**

All materials shall be separately and accurately measured by weight, and each batch shall be uniform. The coarse and fine aggregates shall be weighed separately. A sack of cement shall weigh ninety-four pounds (94#) (43kg). When bulk cement is used, ninety-four pounds (94#) (43kg) shall be considered as one sack. The Contractor shall furnish and use approved weighing devices, which, in operation, will give the exact quantity of materials required for the class of concrete. When the cement is in contact with the aggregate, it shall not remain more than forty-five (45) minutes before being deposited into the mixer.

### **3.04 Measurement of Aggregate.**

- A. Where sack cement is used, the quantities of aggregate for each batch shall be exactly sufficient for one or more sacks of cement. No batch requiring a fraction of a sack of cement will be permitted. All measurements shall be by weight, upon approved weighing scales and shall be such as will insure separate and uniform proportions. Scales shall be of either beam or springless dial types, and shall be suitable for supporting the hopper or hoppers. They shall be set accurately in substantial mountings which will insure a permanent spacing of the knife edges under all conditions of loading and use. They shall be so designed and maintained that they will at all times be accurate to within one-half (1/2) of one (1) percent throughout the entire weight range. Clearance shall be provided between the scale parts and the hopper or the bin structure to prevent displacement of the scale parts due to vibrations, accumulations, or any other cause. The value of the minimum gradations on any scale shall not be greater than five pounds (5#) (2.3kg). The weighing beam or dial shall be so placed that it will be in full view of the operator during the operation of the gate which delivers the material to the hopper. Scales shall be protected from air currents that may affect the accuracy of weighing.
- B. Separate hoppers shall be provided for weighing fine and coarse aggregate. They shall be of suitable size and tight enough to hold the aggregate without leakage, and shall be supported entirely upon the scales. Suitable provisions shall be made for removal of overload from the hopper by the operator while he operates the bin gates.
- C. The Contractor shall provide a sufficient number of fifty-pound (50#) (23kg) standard test weights for calibrating the weighing equipment.

- D. The volume of concrete mixed per batch shall not exceed the manufacturer's guaranteed capacity of the mixer.
- E. When the aggregates are delivered to the mixer in trucks, each batch shall be in a separate compartment of the capacity required by the Engineer. Suitable covers shall be provided for the batch compartments of the trucks to protect the cement from the wind. All trucks, truck bodies, bulkheads, and compartments used in proportioning and transporting to the mixer of concrete materials shall be so designed and operated to insure the charging of the mixer, batch by batch, with the proper amounts of each material without overspillage, intermixing of batches or wastage. Any units which, in the opinion of the Engineer, do not operate satisfactorily, shall be removed from the work until properly rebuilt and corrected.

### **3.05 Mixing Concrete.**

- A. Consistency. The quantity of water to be used shall be determined by the Engineer and shall not be varied without his consent. The Contractor shall furnish and use with the mixer an approved adjustable, water measuring device which will prevent excess water flowing into the mixer, in order that the consistency may be under positive control and that all batches may be of the same consistency.
  - 1. In general, the minimum amount of water shall be used which will produce the required workability. The mortar shall cling to the coarse aggregate and shall show no free water when removed from the mixer.
- B. Mixer. The mixing machine used shall be of an approved type known as a batch mixer, and of a design having a suitable device attached for automatically measuring the proper amount of water accurate to one percent (1%) and for automatically timing each batch of concrete so that all materials will be mixed together for the minimum time required. Such device shall be easily regulated and controlled to meet the variable conditions encountered. If the time device becomes broken or fails to operate, the Contractor will be permitted to continue the balance of the day without the timing device while the same is being repaired, provided that each batch of concrete is mixed two (2) minutes.
  - 1. The normal mixing time for each batch shall be one (1) minute, and the measuring of this period shall begin after all the materials are in the drum. During this mixing period, the drum shall revolve at the speed for which the mixer is designed, but shall make not less than fourteen (14) nor more than twenty (20) revolutions per minute.
  - 2. No materials for a batch of concrete shall be placed in the drum of the mixer until all of the previous batch has been discharged therefrom. The discharge of water into the drum shall commence with the flow of the aggregates, but shall not be started before the entrance into the drum of part of the aggregates. The discharge of all of the mixing water for any batch shall be completed within ten (10) seconds after all of the aggregates are in the drum. The inside of the drum shall be kept free from hardened concrete.
  - 3. The use of mixers having a chute delivery will not be permitted except by permission of

the Engineer. In all such cases the arrangement of chutes, baffle plates, etc., shall be such as will insure the placing of fresh concrete without segregation.

4. Ready-mixed concrete from a central mixing plant delivered at the work ready for use, will be permitted, provided the mixture is transported to the job site in an agitating truck having the concrete contained in a revolving drum and provided there is no segregation of the mixture at the point of placing. Ready-mixed concrete from a central batching plant and mixed in transit will be permitted; however, the mixing and transporting equipment will be subject to the special approval of the Engineer. Any ready-mixed concrete shall comply with all of the requirements of these specifications.
5. The time elapsing from the time the water is added to the mix until the concrete is deposited in place at the site of the Work shall not exceed 30 minutes when hauled in non-agitating trucks, not 60 minutes when hauled in truck mixers or truck agitators. In addition, the total revolutions at mixing speed shall not be less than 70 nor more than 100. When truck mixers are used on hauls in excess of 1 hour, the cement shall be added at the site of the work. The concrete must be of workable consistency when placed. No mixer which has a capacity of less than a two-sack batch shall be used.
  - i. Hand mixing will not be permitted except with the permission of the Engineer and then only in very small quantities or in case of an emergency.
6. Retempering concrete by adding water or by other means will not be permitted; however, a portion of the mixing water may be withheld from transit mixers and added at the work site provided the delivery ticket indicates the amount withheld. The batch shall be mixed for 30 revolutions at mixing speed after adding the water. Water cannot be added to a partial load of concrete mix. Concrete that is not within the specified slump limits at time of placement shall not be used.
7. In using air-entraining admixtures, the mixer shall be equipped with a suitable automatic dispensing device which will proportion the air entraining admixture accurately to each batch of concrete. The device shall be calibrated and adjusted to deliver to each batch of concrete the quantity of admixture required to produce the specified air content in the concrete.
8. The manufacturer of the concrete shall furnish to the purchaser with each batch of concrete before unloading at the site, a delivery ticket. The purchaser shall provide the Engineer with one (1) copy of each delivery ticket.

### **3.06 Forms.**

- A. Forms shall be made of wood or metal. Forms shall be provided with adequate devices for secure setting so that when in place they will withstand, without visible spring or settlement, the impact and vibration of the consolidating and finishing equipment. The top and face of forms shall be cleaned and oiled prior to the placing of concrete.

### 3.07 Placing Concrete.

- A. The concrete shall be unloaded into an approved spreading device, or deposited on the base, and spread in such a manner as to prevent segregation of the materials. As deposited, the mixture shall be placed where it will require as little rehandling as possible. No concrete shall be placed on frozen grade.
- B. Necessary hand spreading shall be done with shovels or other approved tools. Workmen shall not be allowed to walk in the freshly mixed concrete with boots or shoes coated in earthen or other foreign substances.
- C. Concrete shall be thoroughly consolidated against and along the faces of all forms and along the full length and on both sides of all joint assemblies, by means of vibrators inserted in the concrete. Vibrators shall not be permitted to come in contact with a joint assembly, the grade, or a side form. In no case shall the vibrator be operated longer than 5 seconds in any one location.

### 3.08 Protection.

- A. It shall be the responsibility of the Contractor to protect from damage all freshly poured concrete regardless of the location or type of structure for a minimum period of seven (7) days or for such longer period as the Engineer may direct. Any concrete which is damaged shall be repaired to the satisfaction of the Engineer prior to acceptance of the completed work.

### 3.09 Quality Control Testing.

- A. The Owner or Consultant will employ a testing laboratory to perform test and submit test reports. Test reports will be reported in writing to Consultant, Owner, and Contractor as soon as possible upon completion of tests.
  - 1. Compressive Strength Tests. Concrete test cylinders will be made by a qualified technician from a certified material testing laboratory.
  - 2. The cylinders shall be made and tested in accordance with ASTM C39.
  - 2. Tests may be required for each day's run or according to the following schedule:

<u>Total Cubic Yards of Concrete Placed (m<sup>3</sup>)</u>	<u>Minimum Number of Tests*</u> <u>(3 cylinders each)</u>
0 – 100(0-75)	One for 7 days, two at 28 days
100 – 1000 (75 -750)	One for each 50 cu. Yds. (38m <sup>3</sup> )
1000 – 2000 (750 – 1500)	One for each 125 cu. Yds. (100m <sup>3</sup> )
2000 and Over (1500)	One for each 175 cu. Yds. (125 m <sup>3</sup> ) One for each 250 cu. Yds. (200 m <sup>3</sup> )

\*One test per pour minimum.

- iii. Results of all tests shall be furnished to the Engineer as soon as they are available.
- 2. Slump. Slump test shall be conducted in accordance with ASTM C172. A test shall be performed for each day's pour of each type of concrete and for each set of compressive strength test.
- 2. Air Content. Air content shall be tested in accordance with ASTM C143 or ASTM C231. Air content test shall be performed for each set of compressive strength tests of each type of air-entrained concrete.



## CONCRETE CLASSIFICATION TABLE

Class of Concrete	Min. 28 day Compressive Strength (psi)	Slump in Inches	Min Cement-Sacks//CY (3)		Min Cement-#/CY (3)		Net Water Max. Gal/CY (3)		Net Water Max-#/CY (3)	
			Gravel Course Aggregate	Limestone Course Aggregate	Gravel Course Aggregate	Limestone Course Aggregate	Gravel Course Aggregate	Limestone Course Aggregate	Gravel Course Aggregate	Limestone Course Aggregate
A	3000	3-5	6.0	5.5	564	517	36	33	300	275
AS	4000	3-5	(2)	6.2	(2)	583	(2)	(2)	(2)	310
B	3500(1)	1-2.5	6.2	5.8	583	545	34.1	31.9	284	266
C	2500	2-4	5.0	4.5	470	423	34	30.6	283	255
P	5000	1-3	(2)	7.0	(2)	658	(2)	35	(2)	292

**Notes:**

- (1) Minimum compressive strength at 14 days. Minimum flexural strength at 14 days of 550 psi per AASHTO T 22
- (2) Gravel Coarse Aggregate not permitted.
- (3) Tabulated values are for Type I cement conforming to the requirement of AASHTO M 85 only.

**END OF SECTION**

# APPENDIX A

FINISHED GRADE. SEE GRADING PLANS.

SEE NOTE 4

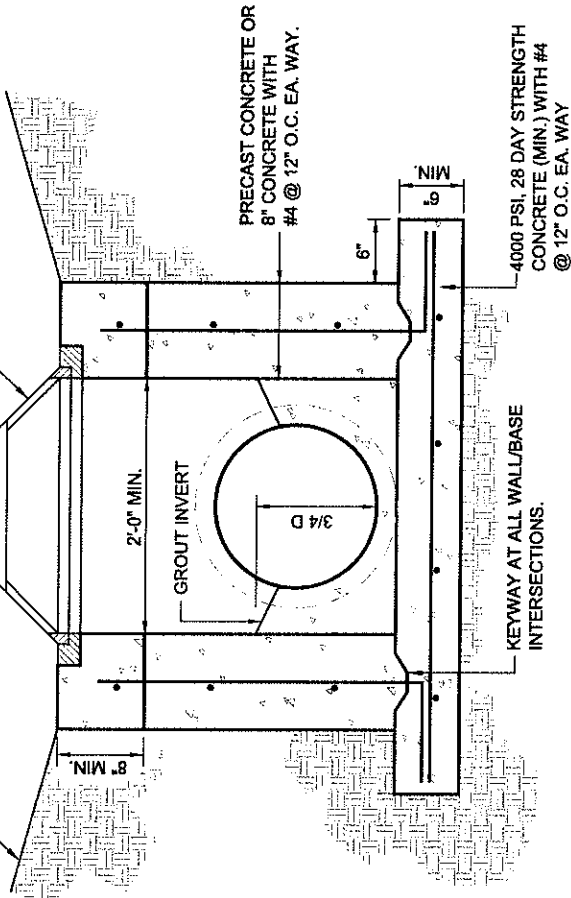

CROSS SECTION

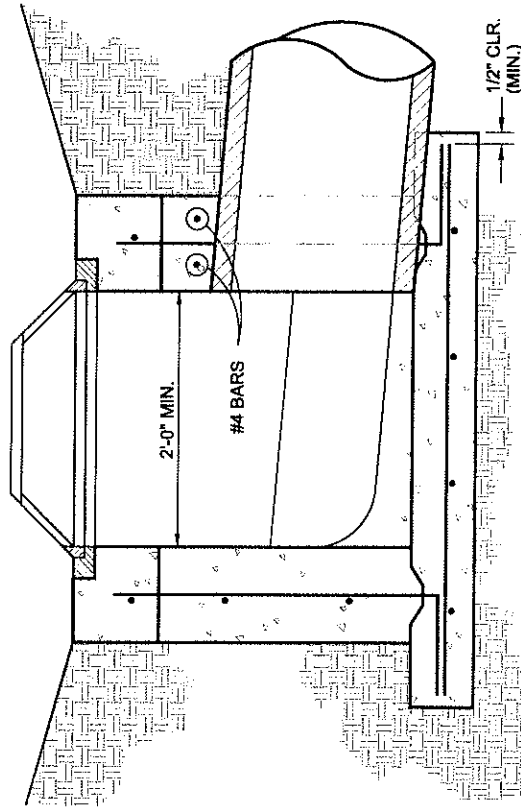

LONGITUDINAL SECTION

**STANDARD  
4470 INLET**

NOT TO SCALE

NOTES:

1. INLET TO BE SET ON SUBGRADE COMPACTED TO 95% OF STANDARD PROCTOR (ASTM D-698)
2. PIPE DIAMETER, DEPTH AND DIRECTION SHALL BE DICTATED BY THE PROJECT GRADING AND DRAINAGE PLAN.
3. PRECAST TOPS MUST BE SET IN PLACE USING A FULL BED OF MORTAR.
4. INLET SHALL BE EQUIPPED WITH A DEETER FOUNDRY, INC. NO. 4470 GRATE AND NO. 2410 FRAME.
5. ALL CONCRETE SHALL BE CLASS "AS", 4000 PSI 28 DAY STRENGTH, MINIMUM.

INLET SIZE	WALL THICK. (IN.)	FLATTOP THICK. (IN.)	BOTTOM THICK. (IN.)
2'X4'	6	8	6
32"X32"	8	8	8
3'X3'	6	8	6
3'X4'	6	8	6
3'X5'	6	8	6
4'X4'	6	8	6
4'X4'	8	8	6
5'X5'	6	9	6
62"X62"	8	9	8
7'X7'	8	10	8
3'X8'	6	8	6
4'X8'	8	8	8

CITY OF LAKELAND  
ENGINEERING DIVISION

**STANDARD  
4470 INLET**

REV.	DESCRIPTION	DATE
1	ORIGINAL ISSUE	8/2008
2	DIMENSION TABLE	1/2011

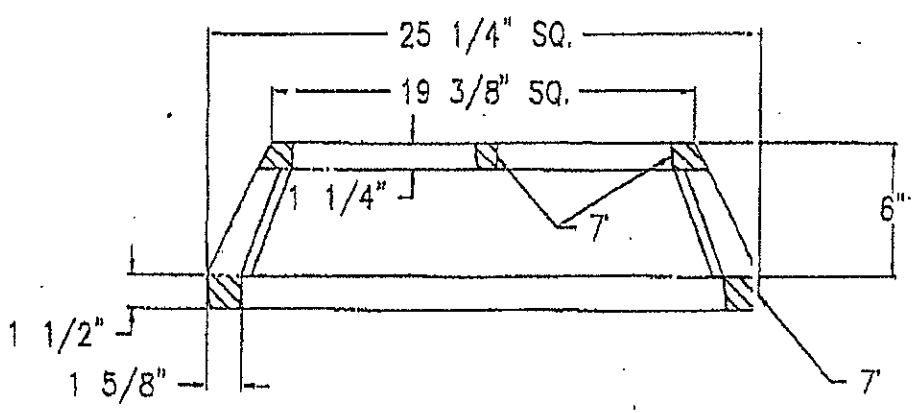
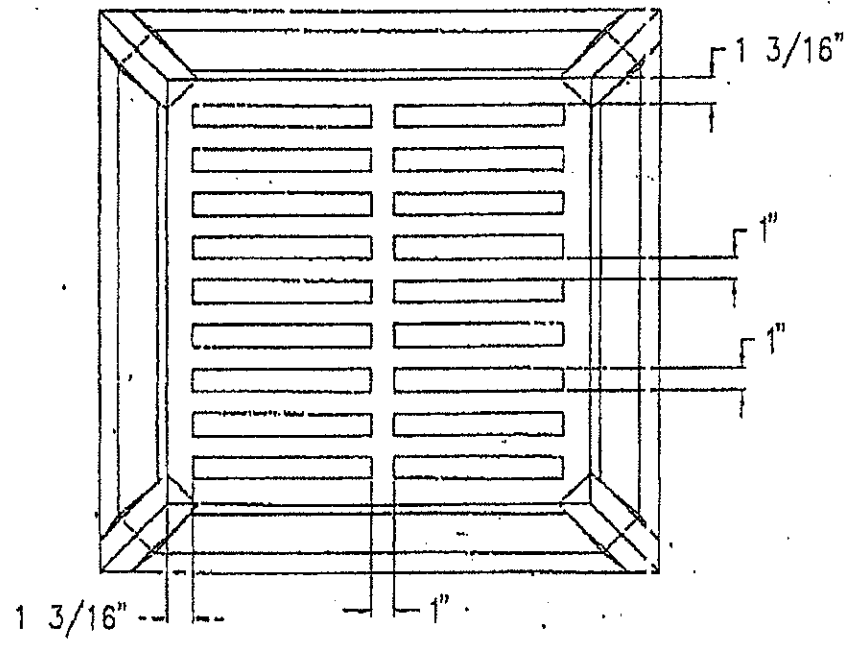

00 DSC REF 3070-REV A (REV) ALL SCALE 1:1

	<b>Deeter Foundry, Inc.</b>		
	5045 NORTH 70th STREET LINCOLN, NEBRASKA 68529		
# 3070		SQUARE "BEEHIVE" GRATE	
Date	29 JUN 93	Drawn by	KRH
Scale		Stock	1/8
DRAWING NO.	98-3070-X3	App. used by	Date

MATERIAL: CAST GRAY IRON ASTM A-48, CLASS 35B
FINISH: NO PAINT
WEIGHT: 156 LBS.

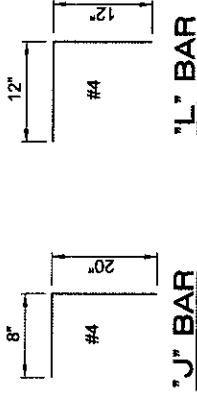

**NOTES:**

1. INLET TO BE SET ON SUBGRADE COMPACTED TO 95% OF STANDARD PROCTOR (ASTM D-698)
2. PIPE DIAMETER, DEPTH AND DIRECTION SHALL BE DICTATED BY THE PROJECT GRADING AND DRAINAGE PLAN.
3. PRECAST TOPS MUST BE SET IN PLACE USING A FULL BED OF MORTAR.
4. INLET SHALL BE EQUIPPED WITH A CITY OF LAKELAND MANHOLE RIM AND COVER.
5. ALL CONCRETE SHALL BE CLASS "AS", 4000 PSI 28 DAY STRENGTH, MINIMUM.

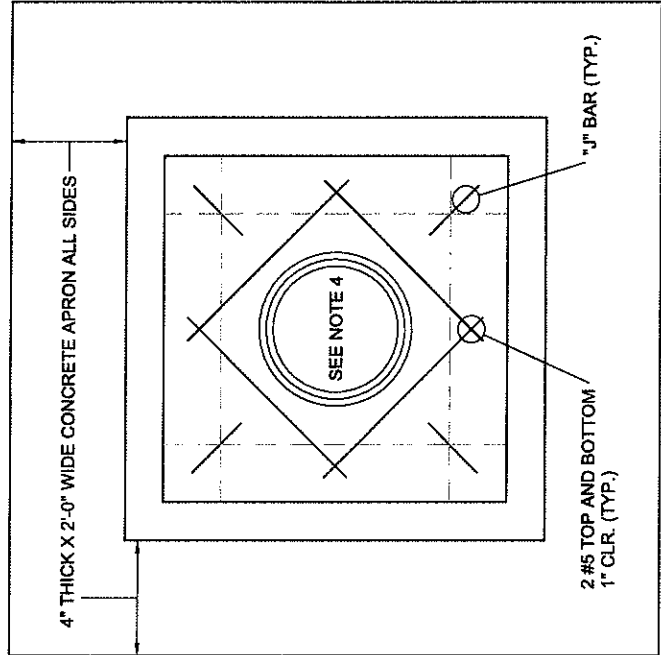

**PLAN VIEW**

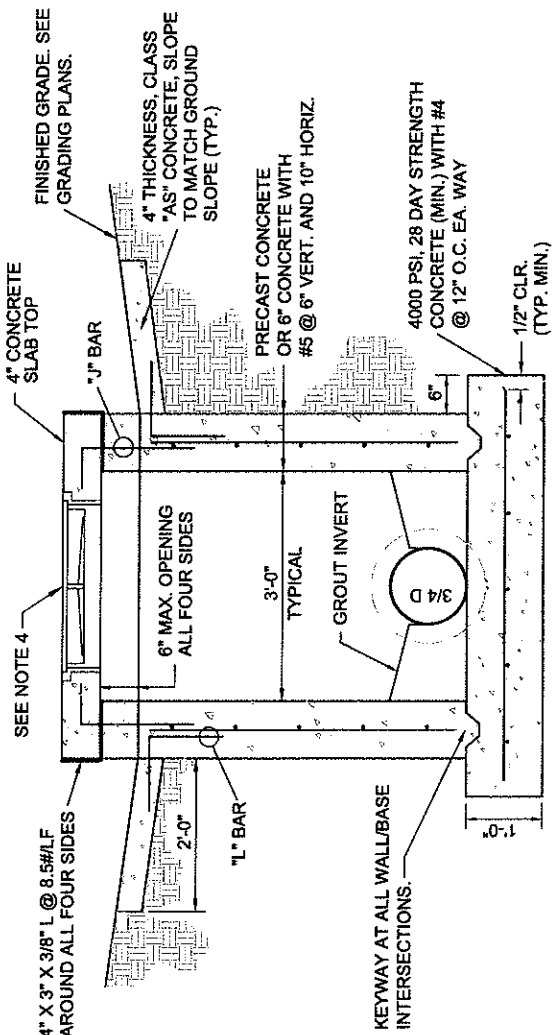

**SECTION**

**STANDARD  
3' X 3' INLET**

NOT TO SCALE

CITY OF LAKELAND  
ENGINEERING DIVISION

**STANDARD  
3' X 3' INLET**

REV.	DESCRIPTION	DATE
1	ORIGINAL ISSUE	8/2008

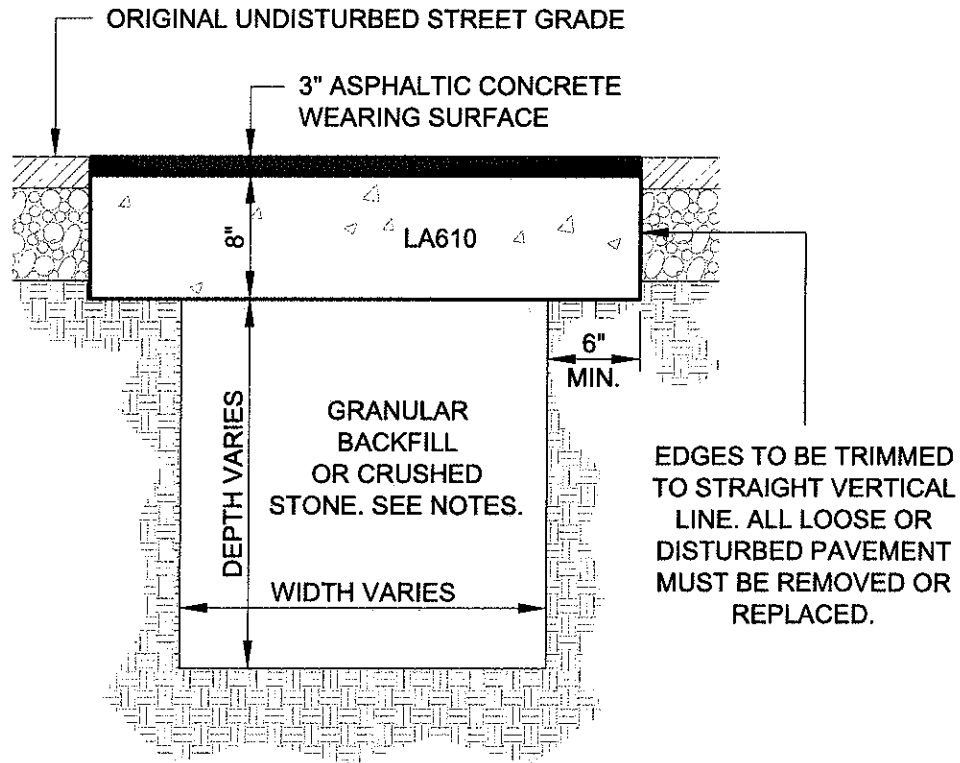

**NOTES:**

1. SAND MAY BE USED AS BACKFILL MATERIAL IN TRENCHES 6' DEEP OR LESS.
2. ANY TRENCH GREATER THAN 6' IN DEPTH SHALL BE REQUIRED TO BE BACKFILLED WITH CR610 CRUSHED STONE OR AS DIRECTED BY THE CITY ENGINEER.
3. GRANULAR BACKFILL MATERIAL SHALL BE COMPACTED TO 95% MAXIMUM DRY DENSITY.

**TYPICAL PAVEMENT REPAIR DETAIL**

NOT TO SCALE

<i>CITY OF LAKELAND ENGINEERING DIVISION</i>		
<b>TYPICAL PAVEMENT REPAIR DETAIL</b>		
REV.	DESCRIPTION	DATE
1	ORIGINAL ISSUE	8/2008
2	LA610 ADDED	1/2011

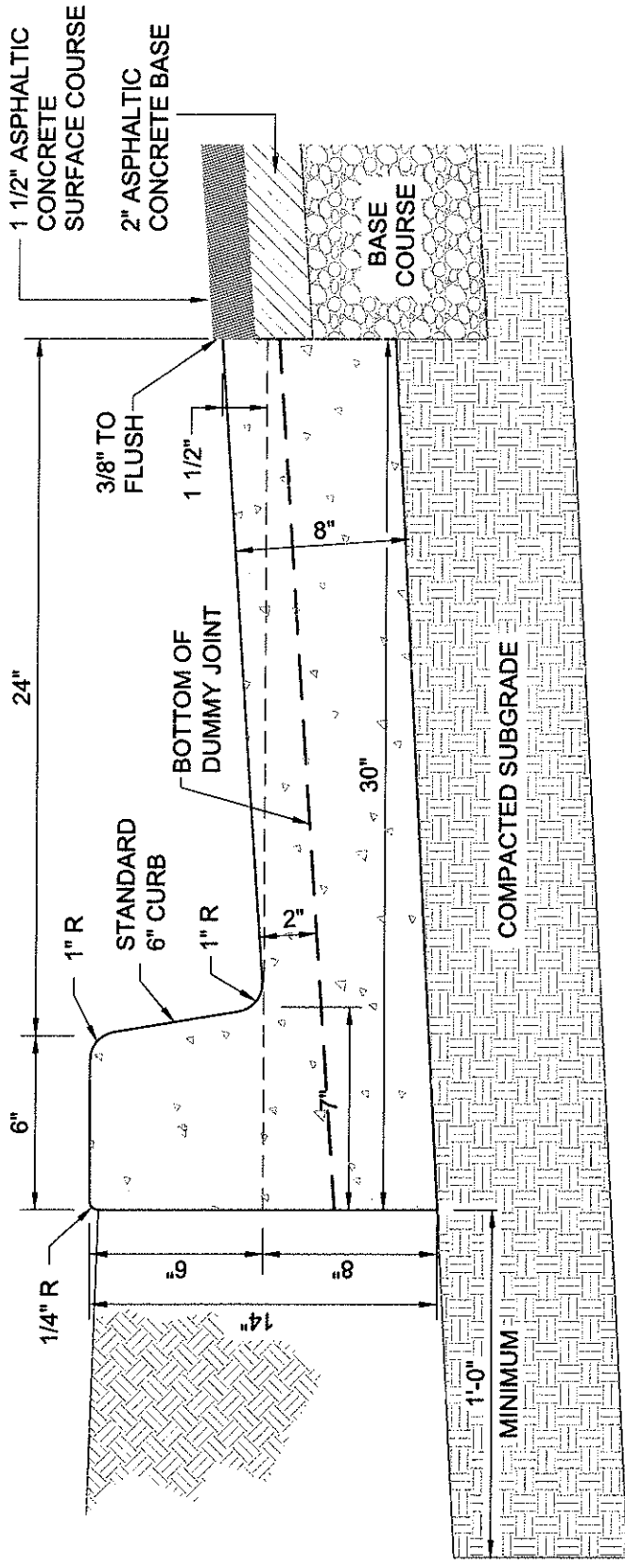

**CONSTRUCTION NOTES:**

1. PRECUT EXPANSION JOINT MATERIAL WILL BE USED IN ALL EXPANSION JOINTS.
2. DUMMY JOINTS WILL BE INSTALLED AT 10' MAXIMUM INTERVALS.
3. EXPANSION JOINTS WILL BE INSTALLED AT 40' O.C. MAX.
4. EXPANSION JOINTS WILL BE INSTALLED AT ENDS OF RADII.
5. EXPANSION JOINTS WILL BE LOCATED ADJACENT TO INLET STRUCTURES.
6. CONCRETE WILL BE CLASS "AS" CONCRETE, 4000 PSI.
7. SEE DETAIL FOR EXPANSION JOINTS.

<i>CITY OF LAKELAND ENGINEERING DIVISION</i>	
<b>6-30 CURB AND GUTTER</b>	
REV.	DESCRIPTION
1	ORIGINAL ISSUE
	DATE
	8/2008

**6-30 CURB  
AND GUTTER**

NOT TO SCALE

NOTE:  
 IN LIEU OF KEYED CONSTRUCTION  
 JOINT CONTRACTOR MAY INSTALL  
 LOAD TRANSFER SLIP DOWELS.

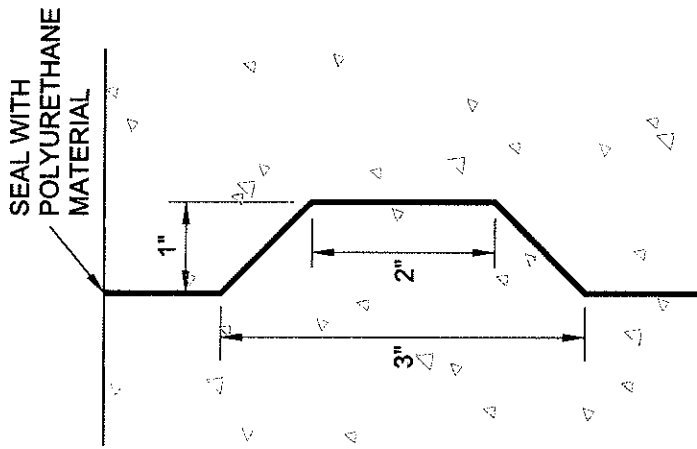

**CONSTRUCTION JOINT**

N.T.S.

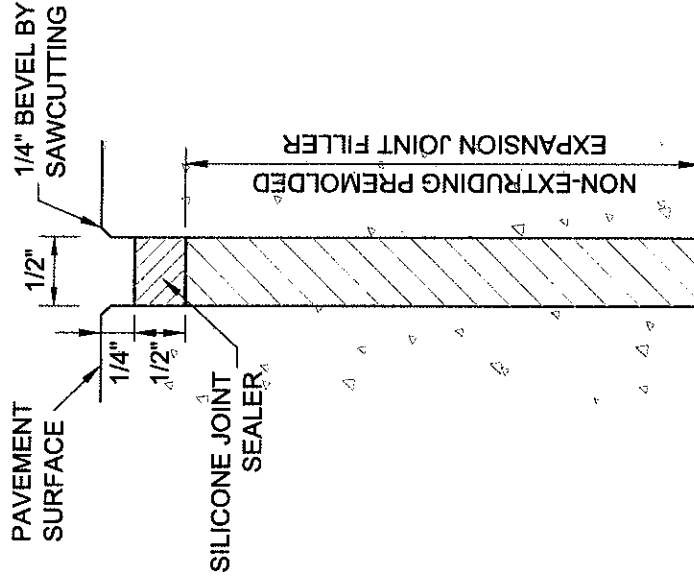

**EXPANSION JOINT**

N.T.S.

CITY OF LAKELAND  
 ENGINEERING DIVISION

**CONCRETE  
 JOINT DETAILS**

REV.	DESCRIPTION	DATE
1	ORIGINAL ISSUE	8/2008

**CONCRETE  
 JOINT DETAILS**

NOT TO SCALE



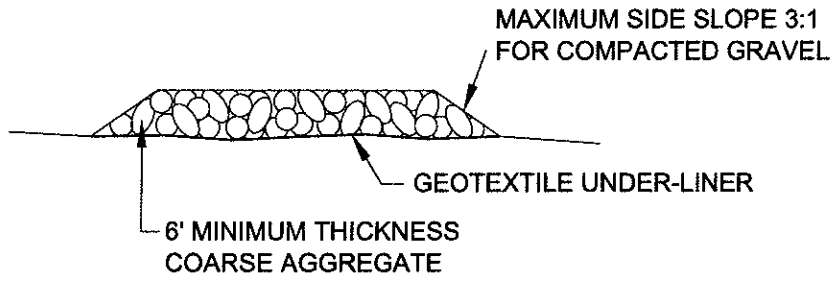

## SECTION A-A

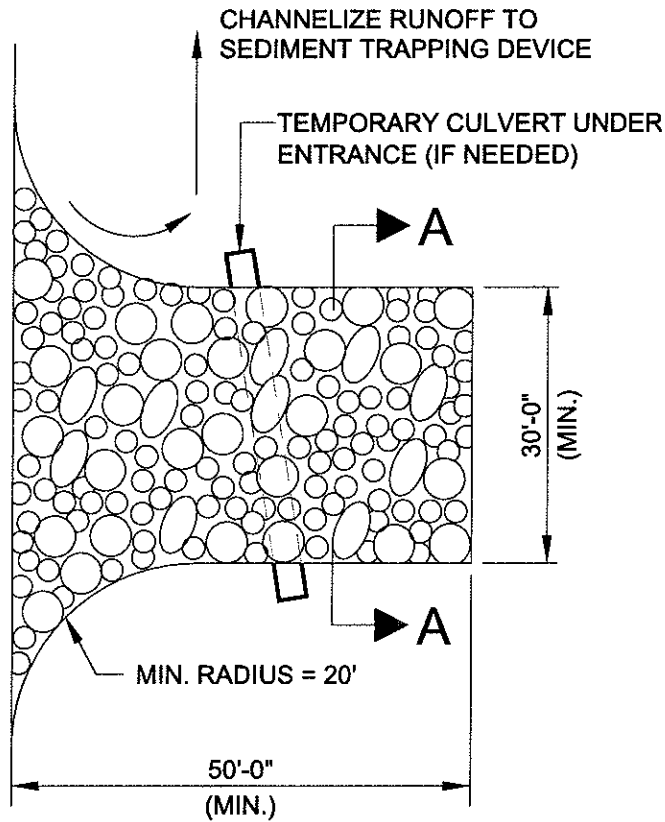

## **CONSTRUCTION EXIT DETAIL**

NOT TO SCALE

<i>CITY OF LAKELAND ENGINEERING DIVISION</i>		
<b>CONSTRUCTION EXIT DETAIL</b>		
REV.	DESCRIPTION	DATE
1	ORIGINAL ISSUE	8/2008

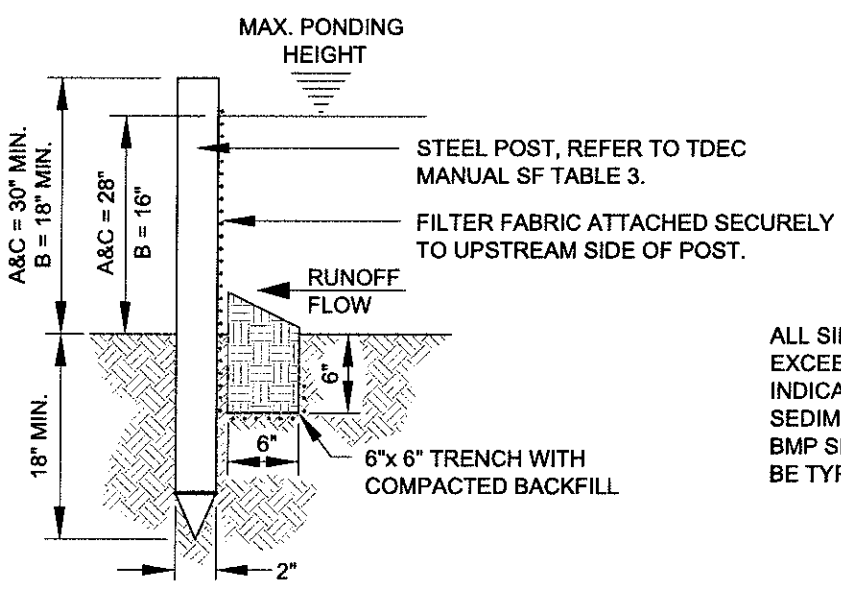
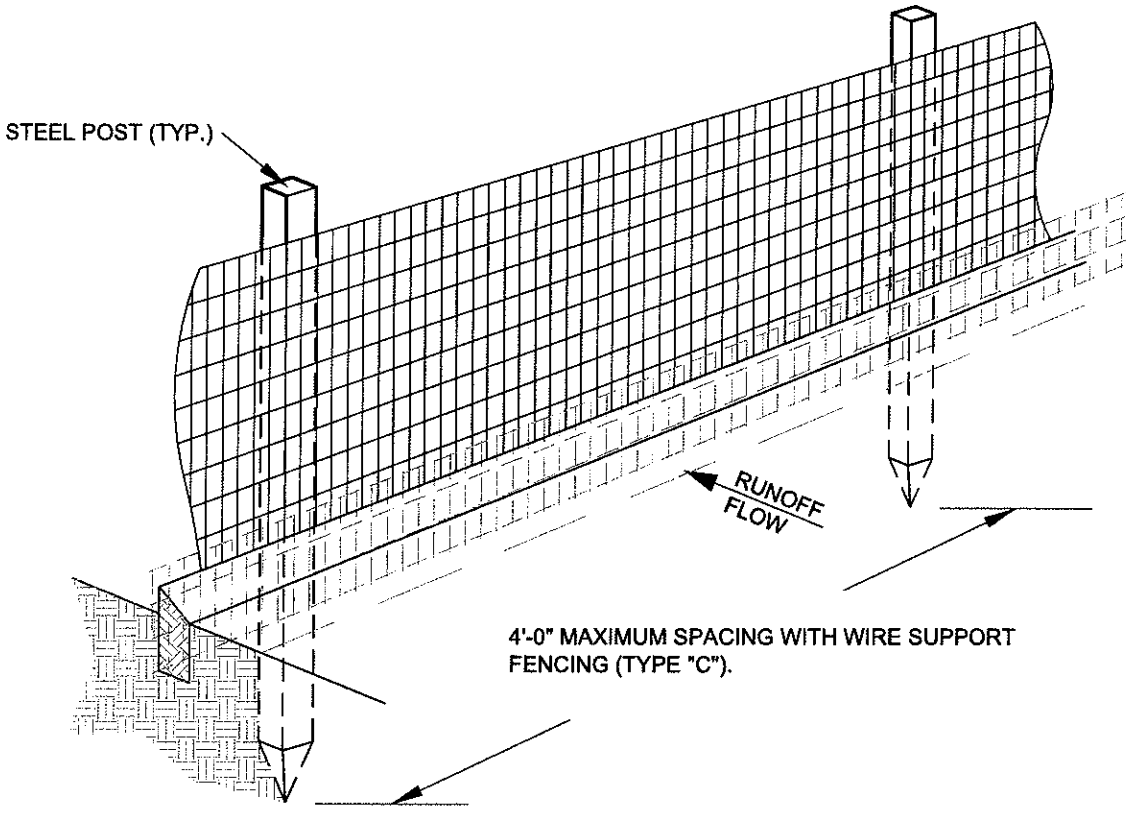

ALL SILT FENCING TO MEET OR EXCEED APPLICABLE REQUIREMENTS INDICATED IN T.D.E.C. EROSION AND SEDIMENT CONTROL HANDBOOK, BMP SF. ALL SILT FENCING TO BE TYPE "C".

**SILT FENCE DETAIL**  
NOT TO SCALE

CITY OF LAKELAND ENGINEERING DIVISION		
SILT FENCE DETAIL		
REV.	DESCRIPTION	DATE
1	ORIGINAL ISSUE	8/2008

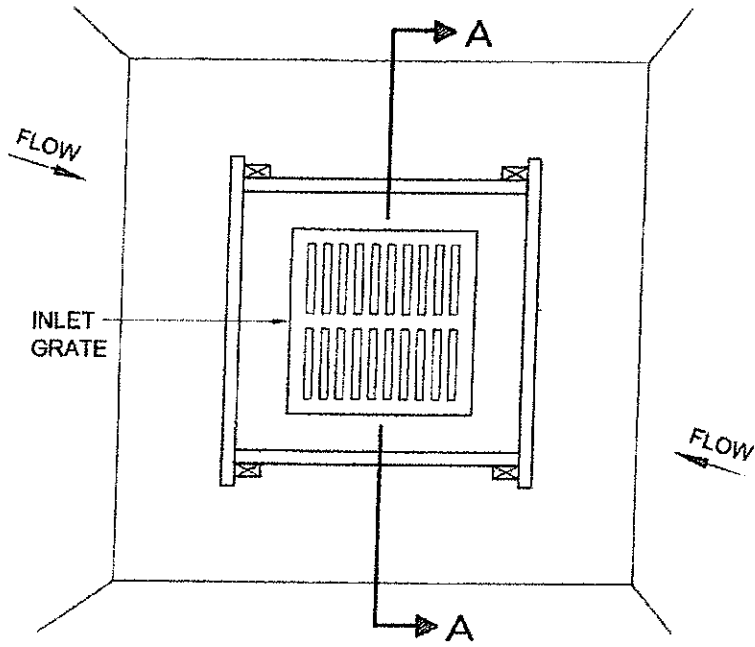

**PLAN**

ATTACH FILTER FABRIC  
SECURELY TO 2"X4" WOOD  
FRAME, OVERLAPPING  
FABRIC TO NEXT STAKE.

TOP FRAME NECESSARY  
FOR STABILITY

MAX. PONDING HEIGHT

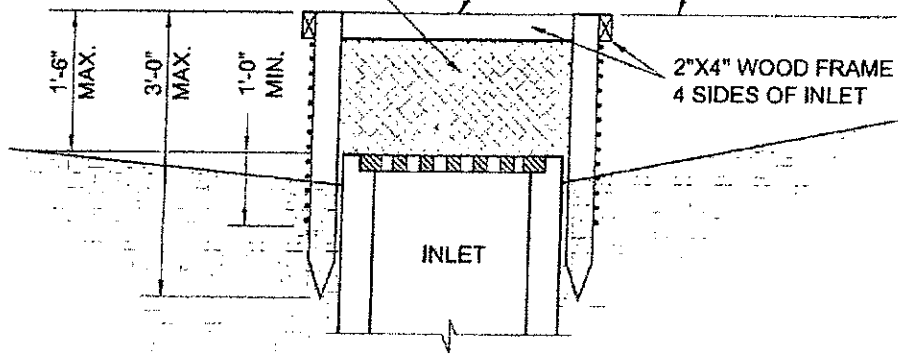

**SECTION A-A**

**SILTATION CONTROL  
AT INLET - TYPE "B"**

NOT TO SCALE

*CITY OF LAKELAND  
ENGINEERING DIVISION*

**SILTATION CONTROL  
AT INLET - TYPE "B"**

REV.	DESCRIPTION	DATE
1.	ORIGINAL ISSUE	4/2008