



**CITY OF LEESBURG
FLORIDA**

INVITATION FOR BID (IFB)

IFB TITLE: REMODEL – CANAL STREET OPERATIONS BUILDING

IFB Number:	<u>180401</u>	Contracting Buyer:	<u>Lisa Wolfkill</u>
Bid Due Date:	<u>June 12, 2018</u>	Pre-Bid Meeting:	<u>May 29, 2018</u>
Bid Due Time:	<u>2:00 P.M.</u>	Issue Date:	<u>May 21, 2018</u>

Estimate of Project Magnitude: \$30,000.00 to \$40,000.00

Brief Description / Purpose

**INVITATION FOR BID
No. 180401
City of Leesburg, Florida**

The City of Leesburg, Florida invites interested and qualified contractors to submit sealed bids for providing all necessary labor, materials, equipment and supervision for a post abatement remodel of the City's Operation Building at Canal Street. Details and specifications are provided within this Invitation for Bid document.

Sealed bids will be received at the Purchasing Office located at 204 N. 5th Street, Leesburg, Florida 34748. Bidders may also submit a response to this IFB Electronically at www.vendorregistry.com no later than the appointed due date and time or as revised by any addenda.

Registered vendors may obtain a copy of the IFB online at www.vendorregistry.com. A copy may also be obtained by e-mailing a request to purch@leesburgflorida.gov or by calling (352)728-9880.

Publish: Vendor Registry

Bid Package Distribution

The City of Leesburg utilizes Vendor Registry (www.vendorregistry.com) as the ONLY official on-line bid management system to distribute solicitations, addenda and answers to questions. Solicitation information obtained from other sources may not be current or accurate and should not be relied on for submitting a response to a solicitation.

There is no charge to vendors/contractors to register and participate in the solicitation, nor will any fees be charged to the awarded vendor. Refer to www.leesburgflorida.gov/purchasing/bids.aspx for further information.

Vendors are strongly encouraged to register (at no cost) with Vendor Registry to download solicitation documents. Should time not permit you to complete the registration process please contact the Purchasing Division at (352)728-9880 or by email at purch@leesburgflorida.gov to obtain a solicitation document(s).

SECTION 1 – SPECIAL TERMS & CONDITIONS

ST-1. **PURPOSE**

This project consists of a post abatement remodel of the City's Operation Building at Canal Street Wastewater Treatment Facility. Work includes installing a new HVAC system, replacing drywall in the abatement area, reinstalling ceiling fixtures and removing existing carpet to furnish and install new carpet.

ST-2. **PROJECT LOCATION**

Operations Building is located at 608 North Canal Street, Leesburg, FL 34748.

ST-3. **QUESTIONS, INFORMATION or CLARIFICATION**

ALL questions regarding this solicitation, including technical specifications or scope of work, shall be submitted in writing to the Designated Procurement Representative. To ensure fair consideration for all parties, the City prohibits communication to or with any department, division, employee, or city representative from the date of issuance of this solicitation until final City action.

- a. Bidders are encouraged to use the question/answer feature of Vendor Registry for the submission of questions and requests for information. Should that not be possible, questions relative to interpretation of specifications, scope of services or the submittal process shall be addressed in writing to the Designated Procurement Representative at purch@leesburgflorida.gov.
- b. The deadline for questions is seven (7) calendar days prior to the solicitation due date. Does not include the day the solicitations are due.
- c. Any interpretation made to Bidders shall be expressed in the form of a written Addendum to the solicitation. Which, if issued, will be made available to all prospective Bidders no later than the three (3) business days immediately before the solicitation due date. Does not include the day the solicitations are due.
- d. Inquiries received after the deadline for questions may not be given any consideration at the discretion of the Purchasing Manager.
- e. It will be the responsibility of the Bidders to contact the Purchasing Division prior to submitting bids to ascertain if any addenda have been issued, to obtain all such addenda, incorporate addenda in their bid response and acknowledge said addenda on the appropriate form.

ST-4. **DESIGNATED PROCUREMENT REPRESENTATIVE**

ALL communication regarding this solicitation shall be directed in writing [e-mail accepted] to the below named individual who shall be the official point of contact for this solicitation.

Lisa Wolfkill, Purchasing Representative
City of Leesburg | Purchasing Department
204 N. 5th Street, Leesburg, FL 34748

Phone: 352-728-9880 | E-mail: purch@leesburgflorida.gov

No answers given in response to questions submitted shall be binding upon this solicitation unless released in writing as an addendum to the solicitation by the Purchasing Division for the City of Leesburg.

ST-5. PRE-BID CONFERENCE/SITE VISIT

A “**MANDATORY**” pre-bid meeting/site visit will be held on:

Date/Time: Tuesday, May 29, 2018 at 9:00 AM.

Location: Canal Street Wastewater Treatment Facility
Operations Building
608 North Canal Street
Leesburg, Florida 34748

This is the only scheduled time contractors and their subcontractors can visit, inspect conditions, and take measurements. Additional contractor visits must be scheduled through the Procurement Division.

Bidders are advised to bring this solicitation document to the conference, as additional copies may not be available. Also, attendees should have equipment needed for measuring, as this may be their only opportunity.

Prior to submitting a bid, it is advisable the vendor visit the site(s) of the projected work and become familiar with any conditions which may in any manner affect the work to be done or affect the equipment, materials and labor required. The vendor is also advised to examine carefully the specifications and to become thoroughly aware regarding any and all conditions and requirements that may in any manner affect the work to be performed under the contract. No additional allowances will be made because of lack of knowledge of these conditions. For any additional information regarding the specifications and requirements of this bid contact the designated procurement representative.

ST-6. ELIGIBILITY

To be eligible to respond to this IFB, bidding firms must demonstrate they, or the principals assigned to the project, have successfully completed projects similar to those specified in the Scope of Services section of the IFB, to at least three municipal entities.

Bidders/Contractors must have a minimum of five (5) years experience in performing the same or similar work required on this project. Bidders shall provide a minimum of three (3) reference projects completed within the last three (3) year related to similar contracts of similar scope and size. References shall be given on the forms provided.

ST-7. LICENSES

The vendor submitting a bid must hold at least one of the following licenses:

- State of Florida Certified GENERAL CONTRACTOR (CGC), or
- Registered* GENERAL CONTRACTOR (RG)
- State of Florida Certified BUILDING CONTRACTOR (CBC), or
- Registered* BUILDING CONTRACTOR (BC)

*Lake County Building Services, Lake County Florida is the registering authority for work performed by registered contractors with the City of Leesburg.

The vendor shall obtain and pay for all licenses required for this project and shall comply with all laws, ordinances, regulations and building code requirements applicable to the work contemplated herein. Damages, penalties and/or fines imposed on the City or the vendor for failure to obtain required licenses shall be borne by the vendor.

The contractor and subcontractors must hold the necessary valid license for the type of work to be performed for the full duration of the project. Allowing the license to lapse at any time during the project will be cause for the contract to be terminated for cause. The license must be effective at the time their bid is submitted.

Licenses will be verified through the Florida Department of Professional Regulation website (myfloridalicense.com).

ST-8. RESTRICTED DISCUSSIONS

From the date of issuance of this solicitation until final City action, vendors should NOT discuss the solicitation or any part thereof with any employee, agent, or any other representative of the City except as expressly authorized by the designated procurement representative. The only communications that shall be considered pertinent to this solicitation are appropriately signed written documents from the vendor to the designated procurement representative and any relevant written document promulgated by the designated procurement representative.

ST-9. METHOD OF SOLICITATION RESPONSE

The Procurement Division shall receive responses to this solicitation by the methods listed here no later than the due date and time established within the solicitation. Responses will not be accepted by any other means.

a. ELECTRONIC SUBMISSIONS

Upload completed submissions as a single electronic file using the City's online bid management system powered by Vendor Registry. **Vendors must have an established account in advance of uploading bid submissions.**

b. PHYSICALLY DELIVERED SUBMISSIONS

Deliver physical hardcopy submissions to:

City of Leesburg
Procurement Division
204 N. 5th Street
Leesburg, Florida 34748

ST-10. COMPLETION REQUIREMENTS FOR INVITATION FOR BID

Complete all forms and Item Bid Schedule. One (1) original of all forms and Item Bid Schedule must be returned submitted by the vendor shall be sealed and delivered to the Purchasing Division no later than the official bid opening date and time. Any bid received after this time will not be considered and will be returned unopened to the submitter. The City is not liable or responsible for any costs incurred by any Bidder in

responding to this IFB including, without limitation, costs for product and/or service demonstrations if requested.

When you submit your bid, you are making a binding offer to the City and are agreeing to all of the terms and conditions in this Invitation for Bid. Use only the form(s) provided in this document. If you make any change to the content or format of any form, the City may disqualify your offer. All information shall be legible and either written in ink or typewritten. If you make a correction or change on any document, the person signing the bid or proposal must initial the change. The bid shall be manually signed by an official authorized to legally bind the Bidder to its provisions.

Specific Completion Directions - Pricing shall be completed using the provided Schedule of Bid Items in the Forms Section of this solicitation.

ST-11. **BID RESPONSE GUARANTEE** – Not Applicable

ST-12. **RETURN OF BID RESPONSE GUARANTEES** – Not Applicable

ST-13. **GUARANTY OF FAITHFUL PERFORMANCE AND PAYMENT** – Not Applicable

ST-14. **POWER OF ATTORNEY** – Not Applicable

ST-15. **BID OPENING**

This project is considered a Construction Project. All bids that have been received in a timely manner will be opened in a Public Meeting in accordance with Chapter 255.0518 Florida Statute. The names of the bidders submitting bids will be read aloud and recorded with the bid amounts for each of the base bid items. The bids will be available for inspection in the Purchasing Division during normal business hours.

ST-16. **LOCAL VENDOR PREFERENCE**

(Applicable to projects whose cost is \$25,000 or greater.)

The City of Leesburg applies a Local Vendor Preference (LVP) for the purchase of personal property, general services, and professional services where the total purchase cost is \$25,000 and greater by means of competitive bid, request for proposals, qualifications or other submittals and competitive negotiation and selection. Except where federal or state law/requirements mandate to the contrary, preference shall be given to Local Vendors in the following manner:

- a. **“Tier I Local Vendor”** shall be defined as the primary Business Office or a Full Time Sales Office of the vendor being located within the City of Leesburg or the vendor receiving one or more Utility Services from the City of Leesburg.
 - i. **Tier I Local Vendor** - Under a Competitive Solicitation, the City may give a preference to a Tier I Local Vendor in the amount of five percent (5%) of the bid price or \$25,000, whichever is less.
- b. **“Tier II Local Vendor”** shall be defined as the primary Business Office or a Full Time Sales Office of the vendor not meeting the definition of a Tier I Local Vendor but nonetheless being located within the 20-Mile Radius as defined in this policy.

- i. **Tier II Local Vendor** - Under a Competitive Solicitation, the City may give a preference to a Tier II Local Vendor in the amount of two percent (2%) of the bid price or \$10,000, whichever is less.

The Local Vendor preference will be applied only to the items/amount used for purposes of bid evaluation and determining award.

Bidders wanting a copy of the entire policy can receive one by making a request by e-mail to purch@leesburgflorida.gov or by calling the purchasing office at (352) 728-9880.

ST-17. METHOD OF AWARD

To a single vendor in the aggregate. Recommendation of Award will be to the responsible bidder submitting the lowest responsive bid and holding the necessary licenses, certifications and experience. Determination of low bid amount will be made using the total bid for the Base Bid Items only and will not consider additional contract items. Local Vendor Preference will be considered when applicable in determining the low bid amount.

ST-18. QUANTITIES

Measurements and quantities which may be given are estimates only, given for informational purposes. Bidders are encouraged to visit the sites to verify measurements and quantities.

The City reserves the right to alter the quantities of work to be performed at any time when necessary and the Contractor shall perform the work as altered, increased or decreased. Payment for such altered increased or decreased quantity will result in an Equitable Adjustment for changed work. Equitable Adjustments can result in price increases for the Contractor for increased work, or price reductions for the City for reduced work. No allowance will be made for any change in anticipated profits nor shall such changes be considered as waiving or invalidating any conditions or provisions of the Contract and Bond.

ST-19. CONTRACT

The City intends to execute a Firm-Fixed Price Construction Services Agreement prepared by the City with the awarded company as a result of this solicitation.

ST-20. TERM OF CONTRACT

The performance period under this contract shall commence upon the date of the Notice To Proceed and shall remain in effect until such time as the commodities, equipment and/or services acquired in conjunction with this solicitation and resulting contract have been delivered and/or completed, and accepted by the City's authorized representative, and will then remain in effect until completion of the expressed and/or implied warranty periods.

ST-21. START AND COMPLETION OF WORK

Work performed under the resulting agreement shall commence upon issuance of a Notice to Proceed and City purchase order. Notice to Proceed shall state the completion date of the ordered work.

All work shall be performed in accordance with good commercial practice. The work schedule and completion dates shall be adhered to by the vendor(s); except in such cases

where the completion date will be delayed due to acts of God, strikes, or other causes beyond the control of the vendor. In these cases, the vendor shall notify the City of the delays in advance of the original completion so that a revised delivery schedule can be appropriately considered by the City.

Should the vendor(s) to whom contract(s) is/are awarded fail to complete the work within the number of days stated in its bid, or the "not-to-exceed timeframe cited above, it is hereby agreed and understood that the City reserves the authority to terminate the contract with the vendor and to secure the services of another vendor to complete the work. If the City exercises this authority, the City shall be responsible for reimbursing the vendor for work which was completed and found acceptable to the City in accordance with the contract specifications. The City may, at its option, demand payment from the vendor, through an invoice or credit memo, for any additional costs over and beyond the original contract price which were incurred by the City as a result of having to secure the services of another vendor. If the incumbent vendor fails to honor this invoice or credit memo, the City may terminate the contract for default.

ST-22. METHOD OF PAYMENT

- i. All invoices shall contain the purchase order number, date and location of delivery or service, and confirmation of acceptance of the goods or services by the appropriate City representative.
- ii. Failure to submit invoices in the prescribed manner will delay payment.
- iii. The project is considered a construction project and retainage may be withheld according to State of Florida Statute.

ST-23. PERMITS

The vendor shall obtain and pay for all permits and inspection fees required for this project and shall comply with all laws, ordinances, regulations and building code requirements applicable to the work contemplated herein. Damages, penalties and/or fines imposed on the City or the vendor for failure to obtain required permits, inspection fees, or inspections shall be borne by the vendor.

- i. Permits – The only known permits are as follows:
 - a. Commercial Building Alterations/Renovations Permit = \$180.00 minimum
 - b. Electrical Permit = \$120.00 minimum
 - c. Mechanical Systems Permit = \$120.00 minimum
- ii. Total Costs
 - a. Permit Fees = \$420.00 + State and Surcharge Fees
 - b. Plan Review Fee (50% of Permit Cost) = \$210.00 + State and Surcharge Fees
- iii. All permits will be obtained by and paid for the Contractor. Permits will be applied for through the City of Leesburg Building Department.
- iv. If any additional permits or costs higher than those stated here Contractor will be reimbursed at actual cost of additional permit costs by the City.
- v. The awarded Contractor shall be required to register with the City of Leesburg Building Services Department if they are not already registered with the City. The cost of registration is \$20.00. Registration does not have to be completed until after contractor award but before permits can be pulled.

ST-24. ACCEPTANCE OF GOODS OR SERVICES

The goods delivered as a result of an award from this solicitation shall remain the property of the Contractor, and services rendered under the contract will not be deemed complete, until a physical inspection and actual usage of the product(s) and/or service(s) is (are) accepted by the City and shall be in compliance with the terms herein, fully in accord with the specifications and of the highest quality.

Any goods and/or services purchased as a result of this solicitation and/or contract may be tested and/or inspected for compliance with specifications. In the event that any aspect of the goods or services provided is found to be defective or does not conform to the specifications, the City reserves the right to terminate the contract or initiate corrective action on the part of the vendor, to include return of any non-compliant goods to the vendor at the vendor's expense, requiring the vendor to either provide a direct replacement for the item, or a full credit for the returned item. The vendor shall not assess any additional charge(s) for any conforming action taken by the City under this clause. The City will not be responsible to pay for any product or service that does not conform to the contract specifications.

In addition, any defective product or service or any product or service not delivered or performed by the date specified in the purchase order or contract, may be procured by the City on the open market, and any increase in cost may be charged against the awarded Contractor. Any cost incurred by the City in any re-procurement plus any increased product or service cost shall be withheld from any monies owed to the Contractor by the City for any contract or financial obligation.

This project will be inspected by an authorized representative of the City. This inspection shall be performed to determine acceptance of work, appropriate invoicing, and warranty conditions.

ST-25. ACCIDENT PREVENTION AND BARRICADES

Precautions shall be exercised at all times for the protection of persons and property. All vendors performing services under this contract shall conform to all relevant OSHA, State, County, and City regulations during the course of such effort. Any fines levied by the above mentioned authorities for failure to comply with these requirements shall be borne solely by the responsible vendor. Barricades shall be provided by the vendor when work is performed in areas traversed by persons, or when deemed necessary by the City's Project Manager.

ST-26. LABOR, MATERIALS, AND EQUIPMENT SHALL BE SUPPLIED BY THE VENDOR

Unless otherwise stated in this solicitation the vendor shall furnish all labor, material and equipment necessary for satisfactory contract performance. When not specifically identified in the technical specifications, such materials and equipment shall be of a suitable type and grade for the purpose. All material, workmanship, and equipment shall be subject to the inspection and approval of the City's Project Manager.

ST-27. CLAIMS FOR EXTRA COST

If the Contractor claims that any instructions by drawings or otherwise involve extra cost under this contract, he shall give the Project Representative written notice thereof within ten

(10) days after the receipt of such instructions, and in any event before proceeding to execute the work, except in emergency endangering life or property, the procedure shall then be as provided for changes in the work. No such claim will be valid unless so made.

ST-28. CONTRACTORS ACCEPTANCE OF CONDITIONS

The Contractor hereby agrees that he has carefully examined the surface of the site and surrounding areas to fully satisfy himself that such site is a correct and suitable one for this work and he assumes full responsibility therefore. The provisions of this contract shall control any inconsistent provisions contained in the specifications. All Drawings and Specifications have been read and carefully considered by the Contractor, who understands the same, and agrees to their sufficiency for the work to be done. It is expressly agreed that under no circumstances, conditions or situations shall this contract be more strongly construed against the City than against the Contractor and his Surety.

Any ambiguity or uncertainty in the Drawings or specifications shall be interpreted and constructed by the Engineer of Record and his decision shall be final and binding upon all parties.

It is distinctly understood and agreed that the passing, approval and/or acceptance of any part of the work or material by the City, the Engineer of Record, or by any agent or representative as in compliance with the terms of this contract and/or of the Drawings and Specifications covering said work, shall not operate as a waiver by the City of strict compliance with the terms of this Contract, and/or the Drawings and Specifications covering said work; and the City may require the Contractor and/or his surety to repair, replace, restore and/or make to comply strictly and in all things with this Contract and the Drawings and Specifications any and all of said work and/or materials which within a period of one (1) year from and after the date of the passing, approval, and/or acceptance of such work or material, are found to be defective or to fail in any way to comply with this contract or with the Drawings and Specifications. This provision shall not apply to materials or equipment normally expected to deteriorate or wear out and become subject to normal repair and replacement before the condition is discovered. The Contractor shall not be required to do normal maintenance work under the guarantee provisions. Failure on the part of the Contractor and/or his surety, immediately after notice to either, repair or replace any such defective materials and workmanship shall entitle the City, if it sees fit, to replace or repair the same and recover the reasonable cost of such replacement and/or repair from the Contractor and/or his surety, who shall in any event be jointly and severally liable to the City for all damage. Loss and expenses caused to the City by Reason for the Contractor's breach of this contract and/ or his failure to comply strictly and in all things with this Contract and with the Drawings and Specifications.

ST-29. FAILURE TO COMPLETE THE WORK ON TIME/LIQUIDATED DAMAGES

The Contractor shall take into account all contingent work which has to be done by other parties arising from any cause whatsoever, and shall not plead his need of knowledge of said contingent work as an excuse for delay in his work or for non-performance.

If the work is not completed in full by the deadline specified, then for each day thereafter on which the work has not been completed, Contractor shall pay to the Owner liquidated

damages in the amount of One Hundred Twenty Five (\$125.00) per calendar day, which Owner is hereby authorized to deduct from the final draw before paying any remaining amount to Contractor. The parties agree that it would be impossible or extremely difficult to compute the actual damages suffered by the Owner due to late completion of the work, that it is therefore appropriate to provide for liquidated damages in this Contract, and that the amount of liquidated damages specified is reasonable and bears a substantial relationship to the probable amount of actual damages the Owner would suffer, and therefore does not constitute a penalty or forfeiture. Contractor acknowledges that this provision is material to the Owner and that the Owner would not have entered into this Contract but for this provision and that as a result of the Owner's reliance on this provision, the Contractor shall be stopped to deny or dispute the validity or enforceability of this liquidated damage clause.

Nothing shall be construed as limiting the right of the Owner to declare the Contract forfeited, or to take over the work, or to claim damages for the failure of the Contractor to abide by each and every one of the terms of the Contract Documents. The completion date shall be construed as being the date on which the work is fully accepted by the Owner.

ST-30. WARRANTY

Contractors material and workmanship is warranted for a period of One (1) year from acceptance by the City. City shall notify Contractor of any defects in material or workmanship. Contractor shall coordinate with City any warranted repairs.

ST-31. MATERIAL STORAGE

Contractor is responsible for coordinating material and equipment storage for the duration of the project.

ST-32. RISK OF LOSS

The vendor assumes the risk of loss of damage to the City's property during possession of such property by the vendor, and until delivery to, and acceptance of, that property to the City. The vendor shall immediately repair, replace or make good on the loss or damage without cost to the City, whether the loss or damage results from acts or omissions (negligent or not) of the vendor or a third party.

The vendor shall indemnify and hold the City harmless from any and all claims, liability, losses and causes of action which may arise out of the fulfillment of any subsequent contract. The vendor shall pay all claims and losses of any nature whatsoever in connection therewith, and shall defend all suits, in the name of the City when applicable, and shall pay all costs and judgments which may issue thereon.

ST-33. INSURANCE AND INDEMNITY REQUIREMENTS

- a) **Scope of Insurance** - The Contractor shall procure and maintain at its own expense, the following minimum insurance coverage, unless otherwise specified in the agreement, contract or lease.
 - i. All required insurance shall be provided by insurers acceptable to the City with an A.M. Best rating of at least A: VII.

- ii. The Contractor shall require, and shall be responsible for assuring that any and all of its subcontractors secure and maintain such insurance that are required by law to be provided on behalf of their employees and others until the completion of that subcontractors work.
 - iii. The required insurance shall be secured and maintained for not less than the limits required by the City, or as required by law, whichever is greater.
 - iv. The required insurance shall not limit the liability of the Contractor. The City does not represent these coverages or amounts to be adequate or sufficient to protect the Contractor's interests or liabilities, but are merely required minimums.
 - v. The provisions of the required insurance are subject to the approval of the City's Risk Manager, and upon request, the Contractor shall make available certified copies of the various policies for inspection.
 - vi. All liability insurance, except professional liability, shall be written on an occurrence basis.
 - vii. The Contractor waives its right of recovery against the City to the extent permitted by its insurance policies.
 - viii. Insurance required of the Contractor, or any other insurance of the Contractor shall be considered primary, and insurance of the City, if any, shall be considered excess as applicable to any claims which arise out of the agreement, contract or lease.
- b) **Indemnification** - The Contractor shall indemnify and hold harmless the City and its officers and employees, from liabilities, damages, attorneys' losses, and costs, including, but not limited to, reasonable fees, to the extent caused by the negligence, recklessness, or intentionally wrongful conduct of the Contractor and other persons employed or utilized by the Contractor in the performance of the contract.
- c) **Certificate of Insurance** - The Contractor shall provide evidence of required minimum insurance by providing the City an ACORD or other Certificate of Insurance in forms acceptable to the Risk Manager for the City, before any work under the agreement, contract or lease begins.
- i. Except for workers' compensation and professional liability, the Contractor's insurance policies shall be endorsed to name the City of Leesburg as additional insured to the extent of the agreement, contract or lease.
 - ii. The Certificate(s) of Insurance shall designate the City as certificate holder as follows: City of Leesburg, Attn: Purchasing Manager, P.O. Box 490630, Leesburg, Florida 34749-0630.
 - iii. The Certificate(s) of Insurance shall include a reference to the project and/or purchase order number.
 - iv. The Certificate(s) of Insurance shall indicate that the City shall be notified at least thirty (30) days in advance of cancellation.
 - v. The Certificate(s) of Insurance shall include all deductibles and/or self-insurance retentions for each line of insurance coverage.
 - vi. The Contractor, at the discretion of the Risk Manager for the City, shall provide information regarding the amount of claims payments or reserves chargeable to the aggregate amount of the Contractor's liability coverage(s).

- d) **Comprehensive General Liability** - The Contractor shall purchase and maintain Commercial General Liability coverage on forms no more restrictive than the latest editions of the Commercial General Liability policies of the Insurance Services Office (ISO). The Commercial General Liability policy shall provide minimum limits of \$1,000,000 per occurrence combined single limit that includes coverage for bodily and personal injury and property damage liability for premises, operations, products and completed operations*, independent contractors, contractual liability covering the agreement, contract or lease, broad form property damage coverage, and property damage resulting from explosion, collapse or underground exposures (x, c, u).
- i. For remodeling and construction projects, the Contractor shall purchase and maintain products and completed operations coverage for a minimum of three (3) years beyond the City's acceptance of the project.
- e) **Business Automobile Liability** - The Contractor shall purchase and maintain Business Automobile Liability coverage on forms no more restrictive than the latest editions of the Business Automobile Liability policies of the Insurance Services Office (ISO). The Business Automobile Liability policy shall provide minimum limits of \$1,000,000 per occurrence combined single limit that includes coverage for claims for bodily injury and property damage arising from the use of motor vehicles, including on-site and off-site operations, and owned, non-owned and hired vehicles, and employee non-ownership use.
- f) **Workers' Compensation** - The Contractor shall purchase and maintain Workers' Compensation insurance for all workers' compensation obligations imposed by state law and with employers liability limits of at least \$100,000 each accident and \$100,000 each employee with \$500,000 policy limit for disease.

Contractors exempt from maintaining Workers' Compensation insurance must provide a valid certificate of exemption issued by the State of Florida.

[END OF SECTION]

SECTION 2 – SCOPE OF WORK

SW-1. BACKGROUND

Mold remediation and abatement work was done at the Canal Street Operation Building in November 2017. The purpose of this project is to remodel building's interior to install a new HVAC system, replace drywall, reinstall ceiling fixtures, paint walls and replace existing carpet to install new.

SW-2. SCOPE OF WORK

Scope of Work for this project is detailed in the plans and specifications located in Section 6. Bidders shall refer to Drawings titled "CANAL STREET OPERATION BUILDING IMPROVEMENTS" consisting of eight (8) drawing sheets.

The Scope of Work will generally be in accordance with the drawings and specification include, but not to be limited to:

- Construct a foam attic space for air tightness
- Construct drywall, tape, finish and paint
- Construct carpet and trim clean
- Construct a laboratory control switch for manual control of one (1) exhaust fan.
- Demolish, remove and dispose of flexible air ducting and diffuser boxes.
- Construct air diffusers
- Re-install existing light fixtures and device plates
- Removal and disposal of all construction materials, wash and vacuum clean.

SW-3. SITE SECURITY

The Contractor is responsible for securing all tools and materials on the jobsite against any losses. City employees will be occupying the building during construction, Contractor shall not take any action that will compromise security of the building during or after project.

SW-4. WORKING HOURS

Prior to construction of the new wall working hours will be 7:00 AM to 4:30 PM. Work outside of these hours will require ADVANCE approval and coordination with the City Project Representative.

SW-5. AIR QUALITY & CONSTRUCTION DEBRIS

Contractor shall provide a barrier between the area of construction and the occupied work areas within the building. Such barrier shall prevent any dust or debris from entering the occupied workspace. The City shall be the sole judge of whether the barrier is adequate to contain the construction debris.

[END OF SECTION]

SECTION 3 - GENERAL TERMS & CONDITIONS (IFB)

GT-1. DEFINITIONS

- 1.1. **Addendum:** A written change to a Solicitation.
- 1.2. **Bid, Offer, or Response:** Shall refer to any bid, offer, or response submitted in regard to this Invitation for Bid that if accepted would bind the Contractor to perform the resultant contract.
- 1.3. **Bidder:** A general reference to any entity responding to this solicitation and must be the party entering into the Agreement with the City; also includes bidder, contractor, company, respondent, vendor, etc.
- 1.4. **Contract:** The Agreement to provide the goods or perform the services set forth in this solicitation.
 - 1.4.1. **Purchase of Goods -** The contract will be comprised of the solicitation document signed by the vendor with any addenda and other attachments specifically incorporated and a City purchase order.
 - 1.4.2. **Performance of Services –** The contract will be comprised of the Agreement between the City and the vendor, the solicitation document, any addenda, and other attachments incorporated into the agreement.
- 1.5. **Contractor:** The vendor to whom award has been made.
- 1.6. **City:** Shall refer to City of Leesburg, Florida.
- 1.7. **In Writing –** Unless otherwise designated 'In Writing' includes submitting documents or questions through the electronic bid system, *Vendor Registry*, currently used by the City.
- 1.8. **Invitation for Bid (IFB):** Shall mean this solicitation document, including any Addenda, used to communicate City requirements to prospective bidders and to solicit bid responses from them.
- 1.9. **Language:** The City has established for purposes of this solicitation that the words "shall", "must", or "will" are equivalent in this solicitation and indicate a mandatory requirement or condition, the material deviation from which shall not be waived by the City. A deviation is material if, in the City's sole discretion, the deficient response is not in substantial accord with this IFB's mandatory requirements. The words "should" or "may" are equivalent in this solicitation and indicate very desirable conditions or requirements, but are permissive in nature. The masculine pronoun shall include the feminine and neuter and the singular shall include the plural.
- 1.10. **Official Purchasing Time:** The Official Purchasing Time shall be that time reflected on the digital clock located in the Purchasing Office and labeled 'Official Purchasing Time'. This clock shall be used for all time deadlines related to City purchasing solicitations.
- 1.11. **Owner:** Shall refer to City of Leesburg, Florida.
- 1.12. **Responsible:** Refers to a vendor that has the capacity and capability to perform the work required under a Solicitation and is otherwise eligible for award.
- 1.13. **Responsive:** Refers to a Bidder that has taken no exception or deviation from the terms, conditions, and specifications set forth in an IFB. Their bid, offer or response conforms to the instructions and format specified in the solicitation document.
- 1.14. **Solicitation:** The written document detailing the solicitation requirements and requesting bids, offers or submittals from Bidders.

GT-2. INSTRUCTIONS TO BIDDERS

- 2.1. **Addenda –** The Purchasing Division may issue an addendum in response to any inquiry received, prior to the deadline for questions which changes, adds to, or clarifies the terms, provisions, or requirements of the solicitation. The Bidder should not rely on any representation, statement or explanation whether written or verbal, regardless of the source, other than those made in this solicitation document or in any addenda issued. Where there appears to be a conflict between this solicitation and any addenda, the last addendum issued shall prevail.
 - 2.1.1. **Bidders Responsibility -** It is the Bidders responsibility to ensure receipt of all addenda and any accompanying documentation. The Bidder is required to Acknowledge receipt of the addenda issued on the appropriate bid form. Failure to acknowledge each addendum may cause the bid to be deemed non-responsive and not be considered for award.
- 2.2. **Contents of Solicitation and Bidders Responsibilities –** It is the responsibility of the Bidder to become thoroughly familiar with the requirements, terms, and conditions of this solicitation. Pleas of ignorance of these matters by the Bidder will not be accepted as a basis for varying the requirements of the City of the amount to be paid to the vendor.
- 2.3. **Request for Additional Information/Questions -** Any communication or inquiries, except for clarification of process or procedure already contained in the solicitation, are to be made in writing to the attention of the Procurement Representative identified in Section 1 of the solicitation no later than **SEVEN (7) DAYS** prior to the bid opening date. Oral answers given by anyone shall not be authoritative.

Vendors are encouraged to submit their questions electronically through *Vendor Registry*. If this is not possible questions may be submitted via e-mail at purch@leesburgflorida.gov. You must reference the solicitation number in the subject line. All requests for information or questions should be clearly marked and must be received no later than the cutoff for questions.

- GT-3. **Award** – Award may be made to the Bidder which offers the best value to the City. The City reserves the right to reject any and all offers, to waive non-material irregularities or technicalities and to re-advertise for all or any part of this solicitation as deemed in its best interest. The City shall be the sole judge of its best interest.
- GT-4. **Assignment** – The Contractor shall not assign or transfer any contract resulting from this solicitation, including any rights title or interest therein, or its power to execute such contract to any person, company or corporation without the prior written consent of the City.
- GT-5. **Basis for Bidding** - The total amount bid shall be based on quantities, unit prices and/or lump sum(s) according to the Schedule of Bid Items form provided. Any quantities shown in the Schedule of Bid Items Form are estimates for the purpose of arriving at a total bid price for comparison of Bid Responses.

A Bidders bid prices shall be firm for ninety (90) calendar days after the solicitation opening date, unless stated differently in the Special Terms and Conditions. In the case of a discrepancy between the unit cost and extended cost the unit cost quoted will take precedence and the Purchasing Division shall make and note the correction on the Final Bid Tabulation.

- GT-6. **Bidder Eligibility** – It is the policy of the City to encourage full and open competition among all available qualified vendors. All vendors regularly engaged in the type of work specified in the solicitation are encouraged to submit bids. Eligibility requirements for contract award are:
- 6.1. Have NO delinquent indebtedness to the City of Leesburg or other federal, state, or municipal agencies;
 - 6.2. Shall be regularly and consistently engaged in providing services the same or similar to those being requested in the solicitation;
 - 6.3. Have adequate financial resources, or the ability to obtain such resources as required during performance of the contract;
 - 6.4. Be able to comply with the required or proposed delivery or performance schedule;
 - 6.5. Have a satisfactory record of performance. Vendors who are or have been deficient in current or recent contract performance (when the number of contracts and the extent of the deficiency of each are considered, in the absence of evidence to the contrary or circumstances properly beyond the control of the contractor) shall be presumed unable to meet this requirement. Past unsatisfactory performance will ordinarily be sufficient to justify a finding of non-responsibility;
 - 6.6. Vendors performing work for the City at the time responses to this solicitation are received may be deemed non-responsible and not considered for award of this solicitation should their current performance be rated as less than satisfactory by the City's designated representative. Previous award of work does not guarantee future award(s). The Vendor must perform satisfactorily and professionally on all City work undertaken;
 - 6.7. Have a satisfactory record of integrity and business ethics;
 - 6.8. Be properly licensed by the appropriate regulatory agency for the work to be performed;
 - 6.9. Not have any previous or current investigations, regardless of disposition or outcome, by the regulatory agency responsible for licensing Contractors; and
 - 6.10. Be otherwise qualified and eligible to receive an award under applicable laws and regulations.
- GT-7. **Cancellation of Solicitation** – The City reserves the right to cancel, in whole or in part, any solicitation when it is in the best interest of the City. Availability of all information related to a cancelled solicitation is subject to Chapter 119, Florida Statutes.
- GT-8. **Changing of Forms** – If the City discovers any bid forms submitted by a bidder in response to this solicitation have been altered the City may, at its discretion, disqualify the Bidder and not consider their bid for award.
- GT-9. **City is Tax Exempt** - The City is generally exempt from Federal Excise Taxes and all State of Florida sales and use taxes. The City will provide a tax exemption certificate upon request. Contractors doing business with the City are not exempt from paying sales tax to their suppliers for materials to fulfill contractual obligations with the City, nor shall any contractor be authorized to use any of the City's Tax Exemptions in securing such materials.

- GT-10. Collusion Among Firms** - Where two (2) or more related parties, as defined herein, each submit a bid for the same contract, such bids shall be presumed to be collusive. The foregoing presumption may be rebutted by the presentation of evidence as to the extent of ownership, control and management of such related parties in preparation of such submittals. Related parties shall mean an interested party or the principals thereof which have a direct or indirect ownership interest in another interested party for the same contract or in which a parent company or the principals thereof of one interested party have a direct or indirect ownership interest in another interested party for the same contract. Furthermore, any prior understanding, agreement, or connection between two (2) or more corporations, firms, or persons submitting a response for the same materials, supplies, services, or equipment shall also be presumed to be collusive. The relationship of manufacturer or their representative(s) providing pricing to distributors while each party submits a bid for the same materials, supplies, services, or equipment shall be presumed to be collusive. Responses found to be collusive shall be rejected. Respondents which have been found to have engaged in collusion may be considered non-responsible, and may be suspended or debarred, and any contract resulting from collusive actions may be terminated for default.
- GT-11. Conflict of Interest** - The award hereunder is subject to Chapter 112, Florida Statutes. All respondents must disclose with their response the name of any officer, director, or agent who is also an employee of the City of Leesburg. Further, all respondents must disclose the name of any City of Leesburg employee who owns, directly or indirectly, an interest of five percent (5%) or more of the Bidders firm or any of its branches.
- GT-12. Conflicts within the Solicitation** – Where there appears to be a conflict between the General Terms and Conditions, Special Terms and Conditions, the Supplemental Terms & Conditions the Statement of Work, the Schedule of Bid Items, or any addendum issued, the order of precedence shall be the last addendum issued, the Schedule of Bid Items, the Statement of Work, the Special Terms & Conditions, the Supplemental Terms & Conditions and then the General Terms & Conditions. In addition, in the case of a conflict between any term or provision contained in contract documents which cannot be resolved by the order of precedence set forth previously, the term or condition that is more stringent and/or specific shall govern and apply.
- GT-13. Continuation of Work** – Any work that commences prior to and will extend beyond the expiration date of the current contract period shall, unless terminated by mutual written agreement between the City and the vendor, continue until completion without change to the then current prices, terms and conditions.
- GT-14. Contract Documents** – Following City Commission approval of the execution of a Construction Services Agreement, the Contract Documents shall consist of the following:
- 14.1. The Construction Services Agreement;
 - 14.2. This Solicitation issued by the City;
 - 14.3. Any Addendum to the Solicitation issued by the City;
 - 14.4. Applicable Engineer Drawings, Design and Specifications;
 - 14.5. The Contractors Bid Response;
 - 14.6. The Notice to Proceed issued by the City and acknowledged by the Contractor.
- GT-15. Contingent Fees Prohibited** - The CONTRACTOR warrants that he or she has not employed or retained any company or person, other than a bona fide employee working solely for the CONTRACTOR, to solicit or secure this Agreement and that he or she has not paid or agreed to pay any person, company, corporation, individual, or firm, other than a bona fide employee working solely for the Bidder any fee, commission, percentage, gift, or other consideration contingent upon or resulting from the award or making of this Agreement. In the event of a breach of this provision, the CITY shall have the right to terminate this Agreement without further liability and at its discretion, deduct from the contract price, or otherwise recover, the full amount of any such fee, commission, percentage, gift or consideration paid in breach of this Agreement.
- GT-16. Copeland "Anti-Kickback" Act** - The Contractor must comply with the Copeland "Anti-Kickback" Act, 18 USC 874 as supplemented in Department of Labor regulations, 29 CFR Part 3, prohibiting employers from inducing any person employed to give up any part of the compensation to which he or she is otherwise entitled.
- GT-17. Cost of Preparing Bid Response** - All costs incurred by the Bidder for proposal preparation and participation in this competitive procurement will be the sole responsibility of the Bidder. The City of Leesburg shall not reimburse any Bidder for any such costs.
- GT-18. Disputes** - In case of any doubt or differences of opinion as to the items to be furnished hereunder, the decision of the City of Leesburg Purchasing Manager shall be final and binding on both parties.

GT-19. **Execution of Contract** – The Contractor to whom the City intends to award a Contract will be required to execute an Agreement within **ten (10) days** from the date of the Notice of Recommendation for Award, and deliver these executed instruments as instructed to the City of Leesburg Purchasing Division.

GT-20. **Governing Law/Jurisdiction** – The interpretation, effect, and validity of any contract(s) resulting from this solicitation shall be governed by the laws and regulations of the State of Florida. Venue of any court action shall be in Lake County, Florida. In the event that a suit is brought for the enforcement of any term of the contract(s).

GT-21. **Interpretation of Contract Documents** - Each Bidder shall thoroughly examine the Forms Response Form, and all other papers comprising the Contract Documents. He shall also examine and judge for himself all matters relating to the location and the character of the proposed work. If the Bidder should be of the opinion that the meaning of any part of the specifications is doubtful or obscure, or that they contain errors or reflect omissions, he should report such opinion or opinions in writing for an interpretation to the Purchasing Division at 204 N. 5th Street Leesburg, Florida 34748 or by electronic mail to: purch@leesburgflorida.gov. Such notification should be done immediately, but in no case no later than **seven (7) business days** before the due date and time of Bid Responses.

The City shall not be responsible for oral interpretation given by any City representative, the issuance of a written addendum being the only official method whereby such an interpretation will be given. The failure of the Bidder to direct the attention of the Purchasing Representative to errors or discrepancies will not relieve the Bidder, should he be awarded the contract, of responsibility of performing the work to the satisfaction of the City of Leesburg in accordance with the specifications.

GT-22. **Liability** - The Contractor shall hold and save the City of Leesburg, its officers, agents, and employees harmless from liability of any kind in the performance of or fulfilling the requirements of a Contract resulting from this solicitation.

GT-23. **Notice to Proceed** – Following contract award the City shall schedule with Contractor a pre-construction meeting. At that meeting the parties will mutually agree on a projects start date which will be used as the Notice to Proceed date. The City shall provide the Notice to Proceed (NTP) to the Contractor. Contractor shall sign NTP acknowledging receipt and agreeing to the dates. The performance period will be defined in the NTP using the NTP date with the days stated in the Time of Completion paragraph of the Contract Documents.

GT-24. **Price Bid** - The unit prices, lump sum(s) and total price bid for the work shall be stated in figures in the appropriate places on the prescribed form(s), and shall be firm for ninety (90) calendar days after the solicitation opening date, unless stated differently in the Special Terms and Conditions. In the case of a discrepancy between the unit cost and extended cost the unit cost quoted will take precedence.

GT-25. **Protests** – Protests can only be made by Interested Parties. Protests must be submitted in writing to the Purchasing Manager at 204 N. 5th Street, Leesburg, FL 32748, no later than three (3) business days after the day the Notice of Recommendation to Award is posted to Vendor Registry, the City's official on-line bid management and vendor notification system. The written protest must specifically state the reason for the protest and exactly what is being protested. Protests received after the deadline will not be considered. The Purchasing Manager will respond to protests no later than seven (7) business days from the day it is received. In case of a protest the determination and decision of the City of Leesburg Purchasing Manager shall be final.

GT-26. **Public Entity Crimes** – Pursuant to Section 287.133(12)(a) of the Florida Statutes, a person or affiliate who has been placed on the convicted vendor list following a conviction for a public entity crime may not submit a Bid Response on a contract to provide any goods or services to a public entity, may not submit a bond on a contract with a public entity for the construction or repair of a public building or public work, may not submit Bid Responses on leases of real property to a public entity may not be awarded or perform work as a contractor, supplier, subcontractor, or consultant under a contract with any public entity, and may not transact business with any public entity in excess of the threshold amount provided in Section 287.017 for Category Two (\$25,000) for a period of 36 months from the date of being placed on the convicted vendor list."

GT-27. **Public Records Law** – The State of Florida has a very broad public records law. Florida Statute Chapter 119 will apply to all bid responses.

- GT-28. Qualifications of Respondents** - The City of Leesburg reserves the right before awarding the contract, to require the Bidder to submit such evidence of his qualifications and experience as it may deem necessary, and may consider any evidence available to it of the financial, technical and other qualifications and abilities of a respondent.
- 28.1. The Bidder is assumed to be familiar with all Federal, State or local laws, codes, ordinances, rules and regulations that in any manner affect the work, and to abide thereby if awarded the Contract. Ignorance of legal requirements on the part of the Bidder will in no way relieve him of responsibility.
 - 28.2. Any Bidder may be required to show to the complete satisfaction of the City of Leesburg that he has the necessary personnel, facilities, abilities, and financial resources to perform the work in a satisfactory manner and within the time specified.
 - 28.3. Bidder must possess any and all required licenses to perform and complete the work necessary in this project. The Bidder must be licensed at the time of submitting their bid and the license must be in effect for the entire period of the project.
- GT-29. Quantities** – The City reserves the right to adjust quantities stated in this solicitation. Available funding versus prices bid may affect actual quantities ordered. The City may choose to increase or decrease quantities stated in the documents depending on the circumstance. The City is not obligated to place any order for a given amount subsequent to the award of this Solicitation. The City may use any stated estimated quantities in the award evaluation process. Estimated quantities do not contemplate or include possible additional quantities that may be ordered by other government, quasi-governmental or non-profit entities utilizing this contract. In no event shall the City be liable for payments in excess of the amount due for quantities of goods or services actually ordered.
- GT-30. Registration** – Any vendor being recommended for an award or purchase from this solicitation is required to register with the City's on-line vendor management system. That on-line system is powered by Vendor Registry and can be accessed by navigating to www.leesburgflorida.gov/purchasing and select the Vendor Registry icon. There is no cost to register. Following issuance of the Notice of Recommendation for Award (NORA), the recommended vendor will be provided instructions on how to register with Vendor Registry. Registration must be completed prior to any work or purchases be made under the Contract.
- GT-31. Responsibility of Respondent to Inform Himself as to All Conditions Relating To Project** - The respondent, by and through the submission of his bid response, agrees that he shall be held responsible for having theretofore examined the site, the location and/or route of all proposed work and for having satisfied himself as to the character of such location and/or route of surface and underground obstructions, the nature of the ground and water table conditions and all other physical characteristics of the job, in order that he may include in the prices which he proposes, all costs pertaining to the work and thereby provide for the satisfactory completion thereof, including the removal, relocation or replacement of any objects or obstructions which will be encountered in doing the proposed work.
- GT-32. Responsiveness (Bids/Proposals)** – Responses shall conform in all material respects to the solicitation in order to be considered for award. Any response which fails to conform to the solicitation's essential requirements may be rejected.
- 32.1. An effective bid/proposal will be formatted to the solicitation specifically with particular attention paid to providing the information necessary to meet the evaluation factors in detail. The bid/proposal must demonstrate to the City that the respondent is highly qualified with regard to each requirement in the solicitation.
- GT-33. Right to Accept or Reject Submittals** – Submittals which are incomplete, unbalanced, conditional, obscure or which contain additions not required, or irregularities of any kind, or which do not comply in every respect with the solicitation, and the Contract Documents, may be rejected at the option of the City of Leesburg (also see the solicitation Definitions).
- 33.1. The City of Leesburg does not bind itself to accept the lowest price for the minimum specifications stated herein, but reserves the right to accept any response which in the judgment of the City will best serve the needs and interests of the City of Leesburg.
 - 33.2. If, at the time this contract is to be awarded, the lowest Cost Response submitted by a responsible Bidder having acceptable qualifications and abilities to perform the work, does not exceed the amount of funds then estimated by the City as available to fund the work under the contract; the contract may be awarded to that Bidder.
 - 33.3. If such lowest Cost exceeds the available funding for the work, the City may reject all Bids or may award the contract to the lowest Cost Bid less such deductible alternates or schedules of work which are listed in the Bid, as produces a net amount which is within the available funds.

- GT-34. **Rules, Regulations and Licenses** – The Contractor shall comply with all federal, state, county, and local laws ordinances, rules and regulations applicable to the provision of the services specified in this solicitation. Lack of knowledge by the Bidder will in no way be relief from responsibility.
- GT-35. **Signature of Bidder** - The Bidder shall sign the Bidders Certification Form in the space provided for the signature. If the vendor is an individual, the words, "Doing Business As (business name)", or "Sole Owner" shall appear beneath his signature. In the case of partnership, the signature of at least one of the partners shall follow the firm name and the words, "Member of Firm", should be written beneath such signature. If the vendor is a corporation, the title of the office signing the Response in behalf of the corporation shall be stated and evidence of his authority to sign the Response shall be submitted.
- GT-36. **State Registration Requirements** – Any corporation submitting a bid in response to this Solicitation shall either be registered or have applied for registration with the Florida Department of State in accordance with the provisions of Chapter 607, Florida Statutes. A copy of the registration/application may be required prior to award of a contract. Any partnership submitting a response to this Solicitation shall have complied with the applicable provisions of Chapter 620, Florida Statutes. For additional information on these requirements, please contact the Florida Secretary of State's Office, Division of Corporations, (800) 755-5111 (<http://www.dos.state.fl.us>).
- GT-37. **State Professional Licenses** – The Bidder shall hold all required Professional Licenses as issued by the State of Florida Department of Business and Professional Regulation at the time their bid is submitted and maintain said licenses for the duration of the Contract.
- GT-38. **Subcontracting** – Unless otherwise specified in this solicitation or Contract Documents, the Contractor shall not change subcontractors from those listed on their Subcontractor Listing form provided in advance of the Notice to Proceed being issued. Changes to Subcontractors may only be made following Contractor submitting a revised Subcontractor Listing and written approval by the City of the requested change in the subcontractor(s).
- GT-39. **Time Allowed** – Contractor will start and complete the work in an expeditious manner which meets the mutually agreed upon schedule and Performance Period as set in the Contract Documents.
- GT-40. **Warranty** - All warranties express and implied, shall be made available to the City for goods and services covered by this solicitation. All goods furnished shall be fully guaranteed by the vendor against factory defects and workmanship. At no expense to the City, the vendor shall correct any and all apparent and latent defects that may occur within the manufacturer's standard warranty period. The special conditions of the solicitation may supersede the manufacturer's standard warranty. This paragraph does not apply to Solicitations for professional services covered by Chapter 287.055, Florida Statutes.
- GT-41. **Withdrawal of Bids** - Any response to this solicitation may be withdrawn **prior** to the due date and time specified in the solicitation document or as revised by an addenda.

[END OF SECTION]

SECTION 4 - SUPPLEMENTAL CONDITIONS – CONSTRUCTION

- SC-1. **DEFINITIONS** - The following definitions shall apply. Whenever the following terms (or pronouns in place of them) are used in the Contract Documents, the intent and meaning of such terms shall be interpreted as follows:
- 1.1. **City Project Representative:** There shall be authorized representative(s) of the City assigned to make all necessary inspections of the work performed by the Contractor and for such other purposes as outlined in the Contract Documents.
 - 1.2. **City Technical Representative:** There may be a designated Project Representative assigned by the City to inspect the technical aspects of the project. To insure the project is being constructed as designed.
 - 1.3. **Engineer of Record:** The Engineer of Record designated by the City following Contract Execution.
 - 1.4. **Engineer:** The design professional (engineer, architect, landscape architect or surveyor) designated by the City to serve as the design professional representing the City.
 - 1.5. **Notice to Proceed (NTP):** The official Notice from the City to the Contractor providing the date work may begin and the date the performance period begins. The NTP date will be mutually agreed to at or following the pre-construction meeting. Contractor shall sign the acknowledgement section of the NTP and return to the Purchasing Division. The NTP shall become a part of the Contract Documents.
 - 1.6. **Subcontractor:** Includes only those having a direct contract with the Contractor and it includes one who furnished material worked to a special design according to the plans or specifications of this work, but does not include one who merely furnishes material not so worked.
 - 1.7. **Work:** The entire completed construction or the various separately identifiable parts thereof required to be furnished under the Contract Documents. Work is the result of performing services, furnishing labor and furnishing and incorporating materials and equipment into the construction, all as required by the Contract Documents.
 - 1.8. **Manual(s):** Equipment documentation meant for the end user/consumer of the equipment. Contractor shall provide all Manuals to the City upon substantial completion. Retainage may not be released until the City has received all Manuals relevant to the equipment incorporated into the project.
 - 1.9. **Surety:** The corporate body which is bound with and for the contractor which is primarily liable and which guarantees the faithful performance of the bid and/or agreement.
 - 1.10. **Plans, Drawings and/or Sketches:** Graphic representations of the work to be performed or reproductions thereof.
 - 1.11. **Specifications:** Broadly defined, the specifications include all data bound together herein or referenced on the plans, including, but not limited to, General Conditions, Technical Specifications, Special Conditions, Geotechnical Investigation, Supplemental Conditions (if any), other detailed technical specifications, exhibits and all addenda.
 - 1.12. **Defective:** An adjective which when modifying the word Work refers to Work that is unsatisfactory, faulty or deficient, or does not conform to the Contract Documents, or does not meet the requirements of any inspection, reference standard, test or approval referred to in the Contract Documents, or has been damaged prior to Engineer's recommendation of final payment (unless responsibility for the protection thereof has been assumed by City at Substantial Completion or City has taken beneficial use of completed portions).

- 1.13. **Shop Drawings:** All drawings, diagrams, illustrations, schedules and other data which are specifically prepared by or for Contractor to illustrate some portion of the Work and all illustrations, brochures, standard schedules, performance charts, instructions, diagrams and other information prepared by a Supplier and submitted by Contractor to illustrate material or equipment for some portion of the Work.
- 1.14. **Substantial Completion:** The Work (or a specified part thereof) has progressed to the point where, in the opinion of Engineer as evidenced by Engineer's definitive certificate of Substantial Completion, it is sufficiently complete, in accordance with the Contract Documents, so that the Work (or specified part) can be utilized for the purposes for which it is intended; or if there be no such certificate issued, when final payment is due. The terms "substantially complete" and "substantially completed" as applied to any Work refer to Substantial Completion thereof.
- 1.15. **Underground Facilities:** All pipelines, conduits, ducts, cables, wires, manholes, vaults, tanks, tunnels or other such facilities or attachments, and any encasements containing such facilities which have been installed underground to furnish any of the following services or materials: electricCity, gases, steam, liquid petroleum products, telephone or other communications, cable television, sewage and drainage removal, traffic or other control systems or water.

SC-2. **INSPECTION OF WORK** - The Project Representative and his representatives shall, at all times, have access to the work whenever it is in preparation or progress and the Contractor shall provide proper facilities for such access and for inspection. The work will be conducted under the general direction of the Project Representative of the City and is subject to inspection by his appointed inspectors to insure compliance with the terms of the contract. No inspector is authorized to change any provisions of the specifications without written authorization of the City, nor shall the presence or absence of an inspector relieve the Contractor from any requirements of the contract.

If the specifications, the Project Representative's instructions, laws, ordinances or any public authority require any work to be specifically tested or approved, the Contractor shall give the City timely notice of its readiness for inspection, and if the inspection is by another authority than the Project Representative, of the date fixed for such inspection. Inspections by the Project Representative will be promptly made, and where practicable at the source of supply. If any work should be covered up without approval or consent of the City, it shall, if required by the Project Representative, be uncovered for examination at the Contractor's expense.

Re-examination of questioned work may be ordered by the Project Representative and, if so ordered, the work shall be uncovered by the Contractor. If such work is found in accordance with the contract documents, the City will pay the cost of re-examination and replacement. If such work is found not in accordance with the contract documents, the Contractor shall pay such cost.

SC-3. **TESTS** - The Project Representative will have the right to require all materials to be submitted to test prior to incorporation in the work. In some instances, it may be expedient to make these tests at the source of supply and for this reason it is requested that the Contractor furnish the source before incorporating material in the work. This does not in any way obligate the Project Representative to perform tests for acceptance of material and does not relieve the Contractor of his responsibility to furnish satisfactory material. The Contractor shall furnish two copies of

manufacturer's certificate of compliance with these specifications covering manufactured items incorporated in the work.

All field tests for compaction of earthwork and of material incorporated in the sub grade and base will be performed by technicians of a materials testing laboratory approved by the City. All tests performed by the laboratory to ascertain that the material, as placed, meets the required specification will be at the expense of the Contractor and should be included in the bid items as such.

- SC-4. **TOOLS, PLANT AND EQUIPMENT** - If any time before the commencement or during the progress of the work, tools, plant or equipment appears to the Project Representative to be insufficient, inefficient or inappropriate to secure the quality of work required, or the proper rate of progress, the Project Representative will notify the City of such conditions. The Engineer will provide written notification to the Contractor of City's quality and/or schedule concerns. The Contractor will respond in writing within 5 business days of receiving the City's notice and will propose remedial actions to address the quality and/or schedule concerns.
- SC-5. **COLLECTION AND DISPOSAL OF WASTE** - The Contractor shall collect waste from construction areas and elsewhere; handle hazardous, dangerous, or unsanitary waste materials separately from other waste by containerizing properly; dispose of material in a lawful manner. The Contractor shall be responsible for the transportation and disposal costs of all waste construction materials.
- SC-6. **BURNING OF DEBRIS** - For any areas where the burning of debris is permitted, the Contractor will be required to request a permit therefore, from the fire authority having jurisdiction in the area in due advance time, and if such permission is granted he shall rigidly abide by all provisions and requirements of such permit. In no case will burning be permitted until the fire authorities have adequately checked the size of the pile to be burned, the weather conditions and any other factors which might affect the proper control of the burning operation.
- SC-7. **MAINTENANCE OF TRAFFIC** - Where construction is located in public right of ways, traveled streets and roads, the Contractor shall exercise extreme care in seeing that sufficient area is provided and kept open for police, fire, ambulance, mail and private vehicular traffic.

The Contractor shall ensure that each person supervising the selection, placement and maintenance of Traffic Control Devices in the FDOT Work Zone shall be certified by attending an FDOT approved MOT training course. A copy of these certifications shall be submitted to the City of Leesburg upon request.

- SC-8. **PROTECTION AGAINST POLLUTION** - The Contractor shall comply with all legal regulations pertaining to pollution as are applicable to the site and he shall take all measures necessary to assure that no pollution, temporary or permanent, occurs to any lakes or other water areas as a result of runoff from the areas within which he is working.

This shall include the installation of temporary construction turbidity screens or hay bales along the edge of existing wetlands prior to the start of construction. These areas shall be as shown on the plans.

Contractor shall maintain the fuel storage area in accordance with local, state and federal regulations. Refueling vehicles and refueling techniques shall also comply with all applicable regulations. Clean-up of the fuel storage area shall be as required by the regulations and in accordance with these regulations.

SC-9. **TEMPORARY FENCING AND BARRICADES** - The Contractor shall at his cost erect barricades sufficient to prevent injury to persons or damage to property, including the Contractor's personal property and materials. The City shall not be held responsible for the loss, theft, or vandalism of the Contractor's equipment or other personal property, including construction materials and supplies. Fences shall be constructed to prevent entry of unauthorized persons; cover trenches and holes when not in use; erect barriers at sharp changes in plane more than four (4) feet high. Should construction operations temporarily obstruct road passage, the Contractor shall at his cost provide suitable flagmen to control vehicular traffic on the road. Permits to use construction equipment on Florida Department of Transportation Right-of-Way shall be secured by the Contractor prior to actual beginning of work. The Contractor shall, at his cost, remove all temporary protection from the work site upon completion of the work.

SC-10. **WORKMANSHIP, MATERIALS, APPLIANCES, AND EMPLOYEES** - All work will be done in a competent and workmanlike manner. All materials, equipment and supplies furnished by the Contractor for permanent incorporation in the work shall be new and of quality standards specified. Workmanship shall be first class and the finished product equal to the best-accepted standards of the trade for the category of work performed. It is the City's intent to obtain a high quality job that will operate and function with least maintenance costs. The Contractor shall, if requested by City, furnish satisfactory evidence as to the kind and quality of materials.

Unless otherwise stipulated, the Contractor shall provide and pay for all materials, labor, water, tools, equipment, light, power, transportation and other facilities necessary for the execution and completion of the work.

The Contractor shall, at all times, enforce strict discipline and good order among his employees and shall not employ on the work any unfit person or anyone not skilled in the work assigned to him.

Neither party shall employ or hire any employees of the other party without his consent.

SC-11. **GENERAL QUALITY AND STANDARDS** - To facilitate rapid examination, detailed specifications concerning basic requirements for labor, materials, equipment and/or incidentals to be used on the project are included under the various divisions in as brief a form as is consistent with clarity. The primary concern of the detailed specifications is for standards of performance expected for the finished work.

When in the detailed specifications reference is made to a particular code or specification, the latest edition of said code or specification shall apply.

The interests of the City, the Contractor and others concerned with the work require the inclusion of certain general governing requirements and standards, as a precaution against contingency and to provide for the conditions under which the construction and the administration of the work will be carried out.

General requirements for the quality of the work, when not otherwise covered in more specific detail in the specifications, will be governed by acceptable standards of the trade.

These specifications consider the project as a whole and assume it's completion under a general contract. Further, the scope of subcontracts and the quantities of materials and labor supplied to the Contractor by others are assumed to be matters governed by agreement between the Contractor and his Subcontractors and suppliers and not by agreement between the City and any Subcontractor or suppliers.

Various sections of the construction specifications are intended to govern only the quality of work and/or materials incidental to the particular branch of work mentioned in the section title. Sections are not intended as itemizations of the work materials to be furnished or to limit or define the scope of any subcontract or agreement to furnish material and labor.

The furnishing of all items of material, labor, equipment and/or incidentals necessary to the completion of the work as a whole will be expected when such items are called for on the drawings by diagram, note or schedule, are listed in the specifications, or are reasonably inferred by either or a combination of both.

During the construction operations under this contract, the City may elect to contract other work for the project. The Contractor shall coordinate his operations with those of any other such Contractors as well as any work of constructing or adjusting utilities by any other authorities, to the end that the least practical handicap to the work of all such Contractors or authorities will result.

- SC-12. **PROJECT COORDINATION** - The Contractor shall coordinate construction operations that are dependent upon each other for proper installation, connection and operation. The Contractor shall make adequate provisions to accommodate items scheduled for later installation.

The Contractor shall inspect both the substrate and conditions under which the work is to be performed. The Contractor shall not proceed until unsatisfactory conditions have been corrected in an acceptable manner.

The Contractor shall inspect materials or equipment immediately upon delivery and again prior to installation. The Contractor shall reject damaged and defective items.

The Contractor shall supervise construction activities to ensure that no part of the construction is subject to deleterious exposure during the construction period. Where applicable, such exposures include, but are not limited to, the following: Unprotected storage, Improper shipping and handling, Theft, Vandalism.

- SC-13. **COORDINATION WITH UTILITY COMPANIES** - Contractor shall coordinate with all utility installations. Contractor shall notify the appropriate utility companies, in writing, adequately in advance of the time frame set aside for such utility installation. The utility companies referred to herein shall include, but not be limited to, Power, Gas, Telephone, and Cable Television. Contractor shall coordinate the installation of “sleeves” for the utility companies as may be required.

Contractor shall supply the City with copies of all correspondence notifying the utility companies of his intended schedule of construction and the expected date for their respective utility installations. Written notices shall be sent to the utility companies at sixty (60) days, thirty (30) days and two (2) weeks prior to the time at which the utility installation should begin.

- SC-14. **SUPERVISION** - Contractor shall supervise and direct the Work competently and efficiently, devoting such attention thereto and applying such skills and expertise as may be necessary to perform the Work in accordance with the Contract Documents. Contractor shall be solely responsible for the means, methods, techniques, sequences and procedures of construction. Contractor shall be responsible to see that the finished Work complies accurately with the Contract Documents.

If the Contractor, in the course of the work, finds any discrepancy between the drawings and the physical conditions of the locality, or any errors or omissions in the drawing or in layout as given by points and instructions, it shall be his duty to immediately inform the Project Representative, in writing, and the Project Representative will promptly verify the same. Any work done after such discovery, until authorized, will be done at the Contractors' risk.

- SC-15. **CONSTRUCTION SUPERINTENDENT** - Contractor shall employ a Construction Superintendent who shall be present on-site or available throughout the duration of the project and shall remain associated with the project until completion unless otherwise requested to be replaced by the City. The superintendent shall be experienced in the work required and perform all coordination activities generally conducted by project superintendents including, but not limited to, subcontractor coordination, utility installations, inspections, testing, material deliveries, etc. The superintendent shall be present at the pre-construction meeting and shall remain on the project until completion. The owner reserves the right to request a resume of experience for the superintendent including, but not limited to, requesting references from recent projects. Substitution of superintendents after the start of the work shall be approved by the owner in advance. All communications given to the superintendent shall be as binding as if given to Contractor.

- SC-16. **WAGE RATES/EQUAL EMPLOYMENT OPPORTUNITY** - Wage rates for laborers, mechanics and apprentices shall not be less than those established by the Florida Department of Labor and Employment Security and/or the United States Department of Labor for this work, as may be attached hereto. The Contractor must insure Equal Employment Opportunity as part of the awarded contract and also subcontracts awarded by the contractor.

- SC-17. **SUBCONTRACTS** - The Contractor shall, as soon as practicable after signing the contract, notify the Project Representative in writing of any changes in the names of subcontractors proposed for the work as listed on the bid form. The Contractor shall not employ subcontractors, unless they are approved by the Project Representative.

The Contractor agrees that he is as fully responsible to the City for the acts and omissions of his subcontractors and of persons, either directly or indirectly, employed by them, as he is for the acts and omissions of persons directly employed by him.

Nothing contained in the contract documents shall create any contractual relation between any subcontractors and the City.

- SC-18. **PRE-CONSTRUCTION MEETING** - The City shall schedule a meeting after the Notice of Award. The Project Representative, Engineer, and Contractor shall attend this mandatory meeting. The following items shall be completed:
- 18.1. Submission of list of Subcontractors, Schedule of Values and Progress Schedule.
 - 18.2. Designation of Personnel representing the parties in Contract, and the Engineer.
 - 18.3. Use of premises by City and the Contractor.
 - 18.4. Survey layout and scheduling.
 - 18.5. Security and housekeeping procedures.
 - 18.6. Requirements for start-up of equipment.
 - 18.7. Inspection and acceptance of equipment put into service during construction period.

At least ten (10) days before submission of the first Application for Payment a conference attended by Contractor, Engineer and others as appropriate will be held to finalize the schedules submitted by Contractor. The finalized progress schedule will be acceptable to Engineer as providing an orderly progression of the Work to completion within the Contract Time, but such acceptance will neither impose on Engineer responsibility for the progress or scheduling of the Work nor relieve Contractor from full responsibility thereto. The finalized schedule of Shop Drawing submissions will be acceptable to Engineer as providing a workable arrangement for processing the submissions. The finalized schedule of values will be acceptable to Engineer as to form and substance.

- SC-19. **ORDER OF COMPLETION** - The Contractor shall submit at such times as may be requested by the Project Representative, schedules which shall show the order in which the Contractor proposes to carry on the work with dates on which the Contractor will start the several parts of the work and estimated dates of completion of the several parts. The City retains the right to dictate to the Contractor the order of completion of the work.

- SC-20. **MATERIALS AND EQUIPMENT SCHEDULES** - As soon as practicable and within ten (10) days after the date of award of contract and before any material or equipment is purchased, the Contractor will submit to the City for approval a complete list, in triplicate, of materials to be incorporated in the work and samples of each listed material. The list shall include catalog numbers, cuts, diagrams; drawings and such other descriptive data as may be required. No consideration will be given to partial lists submitted from time to time. Approval of materials will be based on manufacturers' published ratings. Any materials listed that are not in accordance with the specification requirements may be rejected.

When one or more manufacturer's items are specified, it shall be understood that the item(s) so specified are hereby approved as to suitability and no substitutions will be permitted unless followed by such qualifying phrases as equal "approval equal" or "as approved" in which case the approval of the City for items not specified shall be obtained before they may be used.

- SC-21. **CONTRACTOR'S REQUESTS FOR INTERPRETATION (RFIs)** – Should Contractor be unable to determine from the Contract Documents the exact material, process, or system to be installed; or when the elements of construction are required to occupy the same space (interference); or when an item of Work is described differently at more than one place in the Contract Documents; the Contractor shall request that the Architect/Engineer (AE), or City Representative, make an interpretation of the requirements of the Contract Documents to resolve such matters. Contractor shall comply with procedures specified herein to make Requests for Interpretation (RFIs).

- 21.1. Submission of RFIs: RFIs shall be prepared and submitted on a form provided by the City.
 - 21.1.1. Forms shall be completely filled in, and if prepared by hand, shall be fully legible after copying by xerographic process.
 - 21.1.2. Each RFI shall be given a discrete, consecutive number.
 - 21.1.3. Each page of the RFI and each attachments to the RFI shall bear the City's project name, project number, date, RFI number and a descriptive title.
 - 21.1.4. Contractor shall sign all RFIs attesting to good faith effort to determine from the Contract Documents the information requested for interpretation. Frivolous RFIs shall be subject to reimbursement from Contractor to City for fees charged by A/E, A/E consultants and other design professionals engaged by the City.
- 21.2. Subcontractor-Initiated and Supplier-Initiated RFIs: RFIs from subcontractors and material suppliers shall be submitted through, be reviewed by and be attached to an RFI prepared, signed and submitted by Contractor. RFIs submitted directly by subcontractors or material suppliers will be returned unanswered to the Contractor.
 - 21.2.1. Contractor shall review all subcontractor- and supplier-initiated RFIs and take actions to resolve issues of coordination, sequencing and layout of the Work.
 - 21.2.2. RFIs submitted to request clarification of issues related to means, methods, techniques and sequences of construction or for establishing trade jurisdictions and scopes of subcontracts will be returned without interpretation. Such issues are solely the Contractor's responsibility.
 - 21.2.3. Contractor shall be responsible for delays resulting from the necessity to resubmit an RFI due to insufficient or incorrect information presented in the RFI.
- 21.3. Requested Information: Contractor shall carefully study the Contract Documents to ensure that information sufficient for interpretation of requirements of the Contract Documents is not included. RFIs that request interpretation of requirements clearly indicated in the Contract Documents will be returned without interpretation.
 - 21.3.1. In all cases in which RFIs are issued to request clarification of issues related to means, methods, techniques and sequences of construction, for example, pipe and duct routing, clearances, specific locations of Work shown diagrammatically, apparent interferences and similar items, the Contractor shall furnish all information required for the A/E or City's Representative to analyze and/or understand the circumstances causing the RFI and prepare a clarification or direction as to how the Contractor shall proceed.
 - 21.3.2. If information included with this type RFI by the Contractor is insufficient, the RFI will be returned unanswered.
- 21.4. Unacceptable Uses for RFIs: RFIs shall not be used to request the following:
 - 21.4.1. Approval of submittals
 - 21.4.2. Approval of substitutions
 - 21.4.3. Changes that entail change in Contract Time and Contract Sum
 - 21.4.4. Different methods of performing Work than those indicated in the Contract Drawings and Specifications
- 21.5. Disputed Requirements: In the event the Contractor believes that a clarification by the City's A/E, or Representative, results in additional cost or time, Contractor shall comply with the method for requesting a Change Order.
- 21.6. RFI Log: Contractor shall prepare and maintain a log of RFIs, and at any time requested by the City's Representative, the Contractor shall furnish copies of the log showing all outstanding RFIs.

21.7. Review Time: Architect/Engineer or City Representative (City) shall return RFIs to Contractor and within five (5) calendar days of receipt. RFIs received after 12:00 noon shall be considered received on the next regular working day for the purpose of establishing the start of the five-calendar day response period.

SC-22. **SUBMITTAL REQUIREMENTS OF CONTRACTOR** - After checking and verifying all field measurements and after complying with applicable procedures specified in the General Requirements, Contractor shall submit to Engineer for review in accordance with the accepted schedule of Shop Drawing submissions, or for other appropriate action if so indicated in the Special Conditions, five copies (unless otherwise specified in the General Requirements) of all Shop Drawings, which will bear a stamp or specific written indication that Contractor has satisfied Contractor's responsibilities under the Contract Documents with respect to the review of the submission. All submissions will be identified as Engineer may require. The data shown on the Shop Drawings will be complete with respect to quantities, dimensions, specified performance and design criteria, materials and similar data to enable Engineer to review the information as required.

Contractor shall also submit to Engineer for review with such promptness as to cause no delay in Work, all samples required by the Contract Documents. All samples will have been checked by and accompanied by a specific written indication that Contractor has satisfied Contractor's responsibilities under the Contract Documents with respect to the review of the submission and will be identified clearly as to material, Supplier, pertinent data such as catalog numbers and the use for which intended.

Before submission of each Shop Drawing or sample Contractor shall have determined and verified all quantities, dimensions, specified performance criteria, installation requirements, materials, catalog numbers and similar data with respect thereto and reviewed or coordinated each Shop Drawing or sample with other Shop Drawings and samples and with the requirements of the Work and the Contract Documents.

At the time of each submission, Contractor shall give Engineer specific written notice of each variation that the Shop Drawings or samples may have from the requirements of the Contract Documents, and in addition, shall cause a specific notation to be made on each Shop Drawing submitted to Engineer for review of each such variation.

Engineer will review with reasonable promptness Shop Drawings and samples, but Engineer's review will be only for conformance with the design concept of the Project and for compliance with the information given in the Contract Documents and shall not extend to means, methods, techniques, sequences or procedures of construction (except where a specific means, method, technique, sequence or procedure of construction is indicated in or required by the Contract Documents) or to safety precautions or programs incident thereto. The review of a separate item as such will not indicate review of the assembly in which the item functions. Contractor shall make corrections required by Engineer, and shall return the required number of corrected copies of Shop Drawings and submit as required new samples for review. Contractor shall direct specific attention in writing to revisions other than the corrections called for by Engineer on previous submittals.

Engineer's review of Shop Drawings or samples shall not relieve Contractor from responsibility for any variation from the requirements of the Contract Documents unless Contractor has in

writing called Engineer's attention to each such variation at the time of submission as required by this Article and Engineer has given written review each such variation by a specific written notation thereof incorporated in or accompanying the Shop Drawing or sample review; nor will any review by Engineer relieve Contractor from responsibility for errors or omissions in the Shop Drawings or from responsibility for having complied with the provisions herein.

Where a Shop Drawing or sample is required by the Specifications, any related Work performed prior to Engineer's review of the pertinent submission will be the sole expense and responsibility of Contractor.

- SC-23. **CHANGES IN THE WORK** - Any Change in the Work will be documented in writing and approved by the City in writing. Changes that increase the cost of the work may need to be approved by City Commission depending on the dollar value of the increase change order. No work may be performed prior to the change being approved by City.

The Contract Price constitutes the total compensation payable to the Contractor for performing the work. All duties, responsibilities and obligations assigned to or undertaken by the Contractor shall be at his expense without change in the Contract Price.

The Contract Price may only be changed by a Change Order. Any claim for an increase in the Contract Price, shall be delivered in writing to the City and the Engineer within fifteen days of the occurrence of the event giving rise to the claim. Notice of the amount of the claim with supporting data shall be delivered within forty-five days of such occurrence unless the Engineer allows an additional period of time to ascertain accurate cost data. All claims for adjustments in the Contract Price shall be determined by the Engineer if the City and Contractor cannot otherwise agree on the amount involved. The Engineer(s) decision shall be final and binding. Any change in the Contract Price resulting from any such claim shall be incorporated in a Change Order.

The value of any work covered by a Change Order or of any claim for an increase or decrease in the Contract Price shall be determined in one of the following ways:

- i. where the work involved is covered by unit prices contained in the Contract Documents, by application of unit prices to the quantities of the items involved, or
- ii. by mutual acceptance of a lump sum, or
- iii. on the basis of the cost of the work plus a Contractor's fee for overhead and profit.

- SC-24. **DETAIL DRAWINGS AND INSTRUCTIONS** - The City will furnish, with reasonable promptness, additional instructions by means of drawings or otherwise, necessary for the proper execution of the work. All such drawings and instructions will be consistent with the contract documents, true developments thereof and reasonably inferable therefrom.

- SC-25. **OWNERSHIP OF DRAWINGS** - All drawings, specifications and copies thereof furnished by the City are the property of the City. They are not to be used on other work and, with the exception of the signed contract set, are to be returned to the City, at the request of the City upon the completion of the work.

- SC-26. **SURVEYS, PERMITS AND REGULATIONS** - The City will furnish horizontal and vertical control necessary to layout the work in an orderly and workmanlike manner.

Horizontal Control furnished by the City shall consist of adequately marked property corners or offset corners, with dimensions as shown on the drawings. Vertical Control will consist of benchmarks established within the immediate area of the work.

It shall be the responsibility of the Contractor to furnish all construction layout of the work, including, but not limited to, layout and elevations for the construction and final grade of the site.

The Contractor shall maintain and preserve all stakes and marks established by the City and should such stakes or marks be carelessly or willfully destroyed or damaged by the Contractor, said stakes or marks shall be replaced by the City at the expense of the Contractor.

The Contractor will set the horizontal and vertical control only at the beginning of the job as specified above. Interim staking during the job and all staking and layout work not furnished by the City as specified above shall be the responsibility of the Contractor.

The City will furnish all personnel and equipment and materials to make such surveys as are necessary to determine the quantities of work performed.

The City will furnish environmental permits unless otherwise specified. The Contractor shall obtain any and all required permits from all appropriate government agencies.

Work permits and licenses necessary for the prosecution of the work shall be secured and paid for by the Contractor. Easements for permanent structures or permanent changes in existing facilities will be secured and paid for by the City unless otherwise specified. The Contractor shall give all notices and comply with all laws, ordinances, rules and regulations bearing on the conduct of the work as drawn and specified. If the Contractor observes that the drawings and specifications are at variance therewith, he shall promptly notify the City in writing and any necessary changes shall be adjusted as provided in the contract for changes in the work. If the Contractor performs work knowing it to be contrary to such laws, ordinances, rules and regulations and without such notice to the City, he shall bear all cost arising there from.

SC-27. **ROYALTIES AND PATENTS** - There may be a design, device, material or process included in these plans and specifications which may be covered by letters, patent or copyright. Prior to use of any design, device, material or process, or its incorporation into the construction, the Contractor shall secure indemnity from his subcontractors or material suppliers that will protect and save harmless the City from all loss on account thereof.

The Contractor shall pay all royalties and license fees. He shall defend all suits or claims for infringement of any patent rights and shall save the City harmless from loss on account thereof, except that the City shall be responsible for all such loss when a particular process or the product of a particular manufacturer or manufacturers is specified, but if the Contractor has information that the process or article specified is an infringement of a patent, he shall be responsible for such loss unless he promptly gives such information to the City.

SC-28. **PROTECTION OF WORK AND PROPERTY** - The Contractor shall continuously maintain adequate protection of all his work from damage and shall protect the City's property from injury or loss arising in connection with this contract. The Contractor shall at all times protect all public and privately owned property, structures, utilities, and work of any kind against

damage or interruption of service which may result from the operations of the Contractor. Damage or interruption to service resulting from failure to do so shall be repaired or restored by or at the expense of the Contractor except such as may be directly due to errors in the contract documents or caused by the agents or employees of the City.

SC-29. **DEDUCTIONS FOR UNCORRECTED WORK** - If the Project Representative deems it inexpedient to correct work injured or done, not in accordance with the contract, an equitable deduction from the contract price will be made therefore.

SC-30. **DELAYS AND EXTENSION OF TIME** - If the Contractor be delayed at any time, in the progress of the work by an act of neglect of the City or of his employees, or by any other contractor employed by the City or by Changes ordered in the work or by strikes, lockouts, fire, unusual delay in transportation, unavoidable casualties or any causes beyond the Contractor's control, or by delay authorized by the Project Representative, or by any cause which the Project Representative may decide to justify the delay, then the time of completion will be extended for any such reasonable time as the Project Representative may decide.

No such extension will be made for delay occurring more than seven (7) days before claim therefore is made in writing to the City. In the case of a continuing cause or delay, only one claim is necessary.

If no schedule or agreement stating the dates upon which drawings shall be furnished is made, then no claim for delay will be allowed on account of failure to furnish drawings until two weeks after demand for such drawings and not then unless such claims be reasonable.

SC-31. **CORRECTION OF WORK BEFORE FINAL PAYMENTS** - The Contractor shall promptly remove from the premises all materials condemned by the Project Representative as failing to conform to the contract, whether incorporated in the work or not, and the Contractor shall promptly replace and re-execute his own work in accordance with the contract and without expense to the City and shall bear the expense of making good all work of other contractors destroyed or damaged by such removal or replacement.

If the Contractor does not correct such condemned work and material within a reasonable time fixed by written notice, the City may correct it at the expense of the Contractor. If the Contractor does not pay the expense of such correction within three (3) days thereafter, the City may, upon three (3) days written notice, deduct all the cost and expenses that should have been borne by the Contractor.

SC-32. **THE CITY'S RIGHT TO DO WORK** - If the Contractor should neglect to prosecute the work properly or fail to perform any provision of this contract, the City after three (3) days written notice to the Contractor, may, without prejudice to any other remedy he may have, make good such deficiencies at the Contractor's expense.

SC-33. **SUSPENSION OF WORK** - The City may at any time suspend the work or any part thereof by giving five (5) days notice to the Contractor in writing. The work shall be resumed by the Contractor within ten (10) days after the date fixed in a written notice to resume work from the City to the Contractor. The City will reimburse the Contractor for expense incurred by the Contractor in connection with the work under this contract as a result of such suspension unless

the suspension was recommended to the City by the Project Representative to enforce the contract or for any violation of the contract.

- SC-34. **THE CITY'S RIGHT TO TERMINATE FOR CAUSE OR CONVENIENCE** - Any Agreement executed as a result of his solicitation may be terminated in whole or in part in writing by either party in the event of substantial failure by the other party to fulfill its obligations under the Agreement through no fault of the terminating party, provided that no termination may be effected unless the other party is given:
- i. not less than ten (10) calendar days written notice (delivered by certified mail, return receipt requested) of intent to terminate; and
 - ii. an opportunity for consultation with the terminating party prior to termination.

The Agreement may be terminated in whole or in part in writing by the City for its convenience, provided the other party is afforded the same notice and consultation opportunity specified.

If termination for default is effected by the City, an equitable adjustment in the price for this contract shall be made, but no amount shall be allowed for anticipated profit on unperformed services or other work, and any payment due to the Contractor at the time of termination may be adjusted to cover any additional costs to the City because of the contractor's default.

If termination for convenience is effected by the City, the equitable adjustment shall include a reasonable profit for services or other work performed for which profit has not already been included in an invoice.

For any termination, the equitable adjustment shall provide for payment to the contractor for services rendered and expenses incurred prior to receipt of the notice of intent to terminate, in addition to termination settlement costs reasonably incurred by the contractor relating to commitments (e.g., suppliers, subcontractors) which had become firm prior to receipt of the notice of intent to terminate.

Upon receipt of a termination action under the paragraphs above, the Contractor shall (1) promptly discontinue all affected work (unless the notice directs otherwise) and (2) deliver or otherwise make available to the City all data, drawings, reports specifications, summaries and other such information, as may have been accumulated by the Contractor in performing this contract, whether completed or in process.

Upon termination, the City may take over the work and may award another party a contract to complete the work described in the Agreement.

If, after termination for failure of the Contractor to fulfill contractual obligations, it is determined that the Contractor had not failed to fulfill contractual obligations, the termination shall be deemed to have been for the convenience of the City. In such event, adjustment of the contract price shall be made as provided above.

- SC-35. **CITY'S RIGHT TO TERMINATE FOR DEFAULT** - If, through any cause, the Contract shall fail to fulfill in a timely and proper manner its obligations under this Agreement, other than for the instances listed below due to "Force Majeure," the City shall thereupon have the right to terminate this Agreement by providing a written notice (show cause notice) to the Contractor requiring a written response due within five (5) calendar days from receipt of the written notice

as to why the Agreement should not be terminated for default. The City's show cause notice shall include an Agreement termination date at least seven (7) calendar days subsequent to the due date for the Contractor's response. Should the Contractor fail to respond to such show cause notice, or if the City determines that the reasons provided by the Contractor for failure of the Contractor to fulfill its contractual obligations do not justify continuation of the contractual relationship, the Agreement shall be considered to have been terminated for default on the date indicated in the show cause notice. Should the City determine that the Contractor provided adequate justification that a termination for default is not appropriate under the circumstances; the City shall have a unilateral option to either continue the Agreement according to the original contract provisions or to terminate the contract for convenience. In the event that the City terminates the contract for default, all finished or unfinished deliverable items under this contract prepared by the Contractor shall, at the option of the City, become City property, and the Contractor shall be entitled to receive just and equitable compensation for any satisfactory work completed on such materials. Notwithstanding this compensation, the Contractor shall not be relieved of liability to the City for damages sustained by the City by virtue of any breach of this Agreement, and the City may withhold any payment due the Contractor for the purpose of set-off until such time as the exact amount of damages due the City from such breach can be determined.

In case of default by the Contractor, the City may procure the services from other sources and hold the Contractor responsible for any excess cost occasioned thereby. The City reserves the right to require a performance bond or other acceptable alternative performance guarantees from the successor Contractor without expense to the City.

In addition, in the event of default by the Contractor under this Agreement, the City may immediately cease doing business with the Contractor, immediately terminate for cause all existing Agreements the City has with the Contractor, and debar the Contractor from doing future business with the City.

Upon the Contractor filing a petition for bankruptcy or the entering of a judgment of bankruptcy by or against the Contractor, the City may immediately terminate, for cause, this Agreement and all other existing agreements the Contractor has with the City, and debar the Contractor from doing future business with the City.

The City may terminate this Agreement for cause without penalty or further obligation at any time following Agreement execution, if any person significantly involved in initiating, negotiating, securing, drafting, or creating the Agreement on behalf of the City is at any time while the Agreement or any extension thereof is in effect, an employee or agent of any other party to the Agreement in any capacity or consultant to any other party of the Agreement with respect to the subject matter of the Agreement. Additionally, the City may recoup any fee or commission paid or due to any person significantly involved in initiating, negotiating, securing, drafting or creating the Agreement on behalf of the City from any other party to the Agreement.

SC-36. **REMOVAL OF EQUIPMENT** - In the case of annulment of this contract before completion, from any cause whatever, the Contractor, if notified to do so by the City, shall promptly remove any part or all of his equipment and supplies from the property of the City, failing which, the City will have the right to remove such equipment and supplies at the expense of the Contractor.

- SC-37. **USE OF COMPLETED PORTIONS** - Use by City of any finished part of the Work, which has specifically been identified in the Contract Documents, or which City, Engineer and Contractor agree constitutes a separately functioning and useable part of the Work that can be used by City without significant interference with Contractor's performance of the remainder of the Work, may be accomplished prior to Substantial Completion of all the Work subject to the following:

City at any time may request Contractor in writing to permit City to use any such part of the Work which City believes to be ready for its intended use and substantially complete. If Contractor agrees, Contractor will certify to City and Engineer that said part of the Work is substantially complete and request Engineer to issue a certificate of Substantial Completion for that part of the Work. Contractor at any time may notify City and Engineer in writing that Contractor considers any such part of the Work ready for its intended use and substantially complete and request Engineer to issue a certificate of Substantial Completion for that part of the Work. Within a reasonable time after either such request, City, Contractor and Engineer shall make an inspection of that part of the Work to determine its status of completion. If Engineer does not consider that part of the Work to be substantially complete, Engineer will notify City and Contractor in writing giving the reasons therefore. If Engineer considers that part of the Work to be substantially complete, the provisions of Substantial Completion will apply with respect to certification of that part of the Work and the division of responsibility in respect thereof and access thereto.

City may at any time request Contractor in writing to permit City to take over operation of any such part of the Work although it is not substantially complete. A copy of such request will be sent to Engineer and within a reasonable time thereafter City, Contractor and Engineer shall make an inspection of that part of the Work to determine its status of completion and will prepare a list of the items remaining to be completed or corrected thereon before final payment. If Contractor does not object in writing to City and Engineer that such part of the Work is not ready for separate operation by City, Engineer will finalize the list of items to be completed or corrected and will deliver such list to City and Contractor together, with a written recommendation as to the division of responsibilities pending final payment between City and Contractor with respect to security, operation, safety, maintenance, utilities, insurance, warranties and guarantees for that part of the Work, which will become binding upon City and Contractor at the time when City takes over such operation (unless they shall have otherwise agreed in writing and so informed Engineer). During such operation and prior to Substantial Completion of such part of the Work, City shall allow Contractor reasonable access to complete or correct items on said list and to complete other related Work.

If City finds it necessary to occupy or use a portion or portions of the Work prior to Substantial Completion of all the Work, such use or occupancy may be accomplished in accordance with this Article; provided that no such use or occupancy shall commence before the insurers providing the property insurance have acknowledged notice thereof and in writing effected the changes in coverage necessitated thereby. The insurers providing the property insurance shall consent by endorsement on the policy or policies, but the property insurance shall not be cancelled or lapse on account of any such partial use or occupancy.

- SC-38. **PROMPT PAYMENT** - It is the policy of the City that payment for all purchases by the City shall be made in a timely manner and that interest payments will be made on late payments in

accordance with Part VII, Chapter 218, Florida Statutes, known as the Florida Prompt Payment Act.

- SC-39. **APPLICATION FOR PAYMENT** - The Contractor shall submit to the City, at least 20 days before the date established for each progress payment (but not more often than once a month), an Application for Payment filled out and signed by Contractor covering the work completed as of the date of the Application. Upon review and approval by the City and Engineer (if applicable).

The retained percentage (retainage) amount with respect to the progress payments shall initially be 10% unless stated otherwise in the Construction Services Agreement. Retainage amounts and retainage process shall be governed by Florida Statute 255.078 – Public Construction Retainage.

Contractor shall, before any draw is issued, provide a sworn statement to City attesting that all services, materials and labor, furnished to the project to the date of the draw request have been paid for in full, or listing the amounts due for such services, materials and labor, and if any amounts are listed as being due, the City shall have the right to pay those amounts directly to the persons to whom they are due, with the balance of the draw amount to be paid to Contractor, and if the draw is insufficient to pay the amounts then due for services, materials and labor, the City shall pay those to whom such amounts are due on a pro rata basis until the draw is exhausted, and any remaining amounts due others shall be paid first out the next draw due.

The City shall not be required to issue progress payments pursuant to the draw schedule until the City has verified, by on-site inspection, that construction has in fact progressed to the stage at which a draw is required and that the work done and materials furnished are in compliance with the Contract Documents, and all applicable technical codes. The final draw due upon “completion” shall not be payable until the City, its Project Representative or Engineer of Record has determined the work has been completed in accordance with the Contract Documents and a Certificate of Completion has been issued by the City.

- SC-40. **PAYMENTS WITHHELD** - The City may withhold or, on account of subsequently discovered evidence, recover the whole or part of any payment to such an extent as may be necessary to protect the City from loss on account of—
- i. Defective work not remedied.
 - ii. Claims filed or reasonable evidence indicating probable filing of claims.
 - iii. Failure of the Contractor to make payments properly to subcontractors or for materials or labor.
 - iv. The Project Representative's opinion that the contract cannot be completed for the balance then unpaid.
 - v. Damage to another contractor.
 - vi. Failure to maintain adequate progress.
 - vii. Damage to the building resulting from the negligence of the Contractor.

When the above grounds are removed, payment will be made for amounts withheld because of them.

SC-41. **FINAL PAYMENT APPLICATION** - Administrative actions and submittals that must precede or coincide with submittal of the final payment Application for Payment include the following:

- i. Completion of Project closeout requirements.
- ii. Completion of items specified for completion after Substantial Completion.
- iii. Assurance that unsettled claims will be settled.
- iv. Transmittal of required project construction records to City.
- v. Final Clean Up as outlined in these General Conditions

Upon written notice from Contractor that the entire Work or an agreed portion thereof is complete, Engineer will make a final inspection with City and Contractor and will notify Contractor in writing of all particulars in which this inspection reveals that the Work is incomplete or *defective*. Contractor shall immediately take such measures as are necessary to remedy such deficiencies.

After Contractor has completed all such corrections to the satisfaction of Engineer and delivered all maintenance and operating instructions, schedules, guarantees, bonds, certificates of inspection, marked-up record documents and other documents--all as required by the Contract Documents, and after Engineer has indicated that the Work is acceptable (subject to the provisions under Waiver of Claims), Contractor may make application for final payment following the procedure for progress payments. The final Application for Payment shall be accompanied by all documentation called for in the Contract Documents, together with complete and legally effective releases or waivers (satisfactory to City) of all Liens arising out of or filed in connection with the Work. In lieu thereof and as approved by City, Contractor may furnish receipts or releases in full; an affidavit of Contractor that the releases and receipts include all labor, services, material and equipment for which a Lien could be filed, and that all payrolls, material and equipment bills, and other indebtedness connected with the Work for which City or City's property might in any way be responsible, have been paid or otherwise satisfied; and consent of the surety, if any, to final payment. If any Subcontractor or Supplier fails to furnish a release or receipt in full, Contractor may furnish a Bond or other collateral satisfactory to City to indemnify City against any Lien.

If, on the basis of Engineer's observation of the Work during construction and final inspection, and Engineer's review of the final Application for Payment and accompanying documentation--all as required by the Contract Documents, Engineer is satisfied that the Work has been completed and Contractor's other obligations under the Contract Documents have been fulfilled, Engineer will, within ten days after receipt of the final Application for Payment, indicate in writing Engineer's recommendation of payment and present the Application to City for payment. Thereupon Engineer will give written notice to City and Contractor that the Work is acceptable subject to the provisions found under "Waiver of Claims". Otherwise, Engineer will return the Application to Contractor, indicating in writing the reasons for refusing to recommend final payment, in which case Contractor shall make the necessary corrections and resubmit the Application. Thirty days after presentation to City of the Application and accompanying documentation, in appropriate form and substance, and with Engineer's recommendation and notice of acceptability, the amount recommended by Engineer will become due and will be paid by City to Contractor.

If, through no fault of Contractor, final completion of the Work is significantly delayed and if Engineer so confirms, City shall, upon receipt of Contractor's final Application for Payment and

recommendation of Engineer, and without terminating the Agreement, make payment of the balance due for that portion of the Work fully completed and accepted. If the remaining balance to be held by City for Work not fully completed or corrected is less than the retainage stipulated in the Agreement, and if Bonds have been furnished as required, the written consent of the surety to the payment of the balance due for that portion of the Work fully completed and accepted shall be submitted by Contractor to Engineer with the Application for such payment. Such payment shall be made under the terms and conditions governing final payment, except that it shall not constitute a waiver of claims.

- SC-42. **CONTRACTOR'S CONTINUING OBLIGATION** - Contractor's obligation to perform and complete the Work in accordance with the Contract Documents shall be absolute. Neither recommendation of any progress or final payment by Engineer, nor the issuance of a certificate of Substantial Completion, nor any payment by City to Contractor under the Contract Documents, nor any use or occupancy of the Work or any part thereof by City, nor any act of acceptance by City nor any failure to do so, nor any review and approval of a Shop Drawing or sample submission, nor the issuance of a notice of acceptability by Engineer, nor any correction of *defective* Work by City will constitute an acceptance of Work not in accordance with the Contract Documents or a release of Contractor's obligation to perform the Work in accordance with the Contract Documents (except as provided under Waiver of Claims)
- SC-43. **DAMAGES** - Any claim for damage arising under a resulting Agreement shall be made in writing to the party liable within ten (10) days after the first observance of such damage and not later than the time of final payment, except as expressly stipulated otherwise in the case of faulty work or materials.
- SC-44. **EQUIPMENT STARTUP** - Equipment startup shall be in accordance of the manufacturer's recommendations, and as required to demonstrate performance to the Engineer and City in accordance with the specifications. The Contractor shall provide 30-days notice to the Engineer and City of the date on which all equipment and systems will be ready for startup. The startup date shall be arranged as required by the City's operational schedule with consideration of the schedule needs of the Engineer and Contractor.
- SC-45. **COMPLETION OF WORK** - The Contractor shall be considered "substantially complete" when the equipment and systems have been used without failure for seven (7) continuous days, and in the opinion of the City, its Project Representative or Engineer of Record, all work has been completed in general accordance with the plans and specifications and all test reports, inspections, etc. have been completed and delivered to the Engineer. Substantial completion shall also mean that degree of completion which allows the City to occupy and use the facilities. When the Engineer deems the work to be "substantially complete" he shall indicate this to the City in writing with copies to the Contractor. The date of contract completion shall be the same date at which the Contractor is considered substantially complete by the Engineer.
- SC-46. **ACCEPTANCE OF FINISHED WORK** - The City shall make final acceptance inspection of the Project covered by this Contract when the Project is completed and finished in all respects in accordance with the Contract Documents. Contractor shall furnish to the Engineer or City Representative a complete set of As-Built drawings. These drawings shall be prepared by a licensed Surveyor in the State of Florida and shall be submitted to the Engineer within five (5) days following the completion of the work.

- SC-47. **FINAL CLEAN UP** - The Contractor shall complete all cleaning operations before requesting final inspection.

The Contractor shall, as directed by the Project Representative, remove from the City's property and from all public and private property, at his own expense, all temporary structures, rubbish, and waste materials resulting from his operation.

The Contractor shall remove temporary protection and facilities installed for protection of the work during construction.

The Contractor shall comply with all regulations of authorities having jurisdiction and safety standards for cleaning. The Contractor shall not burn waste materials. The Contractor will not discharge volatile, harmful or dangerous materials into drainage systems. The Contractor will remove all waste materials from the site and dispose of in a lawful manner. Materials of value remaining after completion of associated work will become the owner's property. The Contractor will arrange for the disposition of these materials as directed by the City.

The Contractor shall rake the grounds that are neither paved nor planted to a smooth, even-textured surface.

- SC-48. **TREES** - It shall be the responsibility of the Contractor to protect all trees within the limits of the work and as designated by the Project Representative.

- SC-49. **GUARANTY** - Contractor warrants and guarantees to City that all Work will be in accordance with the Contract Documents and will not be *defective*. Prompt notice of all defects shall be given to Contractor. All *defective* Work, whether or not in place, may be rejected, corrected or accepted as provided in the paragraph in this section labeled 'Inspections, Correction, Removal Of Defective Work'.

All equipment, materials and installation and workmanship furnished by the Contractor under the terms of the Contract, shall be guaranteed by the Contractor against defective workmanship, mechanical and physical defects, leakage, breakage and other damages and failure, under normal operation for a period of two (2) years or as otherwise specified in the Technical Specifications and after the date of acceptance thereof by the City, and each item of equipment or materials and installation proving to be defective within the specified period of guaranty shall be replaced, without cost to the City, by the Contractor or by the Surety. The period of guaranty of such replacement shall be from and after the date of final acceptance of the Project by the City, provided however, that where any item or equipment or material comes with a manufacturer's warranty of two (2) years or longer, that warranty shall take precedence over the warranty of Contractor hereunder.

- SC-50. **INDEMNITY** - The Contractor agrees to make payment of all proper charges for labor required in the aforementioned work and defend, indemnify, and save harmless the City and Engineer or any of their officers, agents, or servants and each and every one of them against and from all claims, suits, and costs of every kind and description, including attorney's fees, and from all damages to which the City and Engineer or any of their officers, agents, or servants may be put by reason of injury to the persons or property of others resulting from the performance of Contractor's duties under the Contract, or through the negligence of the Contractor in the

performance of its duties under this Contract, or through any act or omission on the part of the Contractor, his agents, employees, or servants or subcontractors.

Provided, however, if this Contract is deemed, by a court of competent jurisdiction, to be a construction contract for the purposes of Section 725.06, Florida Statutes, any obligation of the Contractor to defend, indemnify or hold harmless an City and Engineer shall be limited to an obligation to indemnify and hold harmless the City and Engineer, and its officers and employees, from liabilities, damages, losses, and costs, including, but not limited to, reasonable attorneys' fees, to the extent caused by the negligence, recklessness, or intentionally wrongful conduct of the Contractor and persons employed or utilized by the Contractor in the performance of this Contract.

- SC-51. **ASSIGNMENT** - Neither party to the contract shall assign the contract or sublet it as a whole without the written consent of the other, nor shall the Contractor assign any moneys due, or to become due to him hereunder, without the previous written consent of the Project Representative.
- SC-52. **RIGHTS OF VARIOUS INTERESTS** - Wherever work being done by the City's forces, or by the other contractors, is contiguous to work covered by this contract, the respective rights of the various interests involved will be established by the Project Representative, to secure the completion of the various portions of the work in general harmony.
- SC-53. **SEPARATE CONTRACTS** - The City reserves the right to let other contracts in connection with this work. The Contractor shall afford other contractors reasonable opportunity for the introduction and storage of their materials and the execution of their work, and shall properly conduct and coordinate his work with theirs.

If any part of the Contractor's work depends, for proper execution or results upon the work of any other contractor, the Contractor shall inspect and promptly report to the Project Representative any defects in such work that render it unsuitable for such proper execution and results. His failure to so inspect and report shall constitute an acceptance of the other contractor's work as fit and proper for the reception of his work, except as to defects which may develop in the other contractor's work after the execution of the work.

To insure the proper execution of his subsequent work, the Contractor shall measure work already in place and shall at once report to the Project Representative any discrepancy between the executed work and the drawings.

- SC-54. **LANDS FOR WORK** - The City will provide the lands upon which the work under this contract is to be done, except that the Contractor shall provide land required for the erection of temporary construction facilities and storage of his material, together with right of access to same.
- SC-55. **ACCESS TO RECORDS** - The City, the Florida Department of State, or any of their duly authorized representatives shall have access to any books, documents, papers or any other records prepared by the Contractor that are directly pertinent to the work produced under this Agreement for making audit, examination, excerpts and transcription. Such records will be maintained for five (5) years after the completion of the work and until claims or audit findings have been resolved which were initiated prior to the expiration of the five (5) year period.

SC-56. **EXECUTION, CORRELATION AND INTENT OF DOCUMENTS** - The Agreement shall be signed in quadruplicate by the City and the Contractor. The Contract Documents comprise the entire agreement between City and Contractor concerning the Work. The Contract Documents are complementary; what is called for by one is as binding as if called for by all. The Contract Documents will be construed in accordance with the law of the place of the Project.

It is the intent of the Contract Documents to describe a functionally complete Project (or part thereof) to be constructed in accordance with the Contract Documents. Any Work, materials or equipment that may reasonably be inferred from the Contract Documents as being required to produce the intended result will be supplied whether or not specifically called for. When words which have a well-known technical or trade meaning are used to describe Work, materials or equipment, such words shall be interpreted in accordance with that meaning. Reference to standard specifications, manuals or codes of any technical society, organization or association, or to the Laws or Regulations of any governmental authority, whether such reference be specific or by implication, shall mean the latest standard specification, manual, code or Laws or Regulations in effect at the time of opening of Bids (or, on the Effective Date of the Agreement if there were no Bids), except as may be otherwise specifically stated. However, no provision of any referenced standard specification, manual or code (whether or not specifically incorporated by reference in the Contract Documents) shall be effective to change the duties and responsibilities of City, Contractor or Engineer, or any of their consultants, agents or employees from those set forth in the Contract Documents, nor shall it be effective to assign to Engineer, or any of Engineer's consultants, agents or employees, any duty or authority to supervise or direct the furnishing or performance of the Work or any duty or authority to undertake responsibility contrary to the provisions of these Supplemental Conditions. Clarifications and interpretations of the Contract Documents shall be issued by Engineer.

If, during the performance of the Work, Contractor finds a conflict, error or discrepancy in the Contract Documents, Contractor shall so report to Engineer in writing at once and before proceeding with the Work affected thereby shall obtain a written interpretation or clarification from Engineer; however, Contractor shall not be liable to City or Engineer for failure to report any conflict, error or discrepancy in the Contract Documents unless Contractor had actual knowledge thereof or should reasonably have known thereof.

SC-57. **CONTRACTOR'S UNDERSTANDING** - Contractor has visited the site, has called for utility locates and has familiarized itself with the local conditions under which the work is to be performed, both underground and above ground and both on and off premises and has correlated these observations with the requirements of the proposed contract documents; all as considered necessary or pertinent to the work, and any failure to thus make all such prior investigations and studies shall in no way act as a waiver of any of the terms of the contract. No verbal agreement or conversation with any officer, agent or employee of the City, either before or after the execution of this contract, shall affect or modify any of the terms or obligations herein contained

SC-58. **FAMILIARITY WITH LAWS** - The Contractor is required to be familiar with all Federal, State and Local laws, ordinances, rules and regulations that in any manner affect the work. Ignorance on the part of the Contractor will in no way relieve him from responsibility.

SC-59. **SALES TAX** - The Contractor is required to pay Florida sales and use taxes on all materials purchased for this project unless otherwise specified in the document. All Florida sales and use taxes will be included in the submitted bid price(s).

SC-60. **CLARIFICATIONS AND INTERPRETATIONS OF CONTRACT DOCUMENTS** - It is the duty of the Contractor to notify the Engineer, in writing, in the event of any doubt or question as to the true meaning of any provision in the Contract Documents. The Engineer's decision thereon shall be final. Annotated dimensions on drawings shall govern and work not dimensioned shall be as clarified by the Engineer. Work not particularly shown or specified shall be the same as similar parts that are shown or specified. Materials or work described in words which have a well-known technical or trade meaning shall be deemed to refer to such recognized standard.

Engineer will issue with reasonable promptness such written clarifications or interpretations of the requirements of the Contract Documents (in the form of Drawings or otherwise) as Engineer may determine necessary, which shall be consistent with or reasonably inferable from the overall intent of the Contract Documents. If Contractor believes that a written clarification or interpretation justifies an increase in the Contract Price or an extension of the Contract Time then Contractor shall notify City in accordance with the Agreement.

Engineer will be the initial interpreter of the requirements of the Contract Documents and judge of the acceptability of the Work there under. Claims, disputes and other matters relating to the acceptability of the Work or the interpretation of the requirements of the Contract Documents pertaining to the performance and furnishing of the Work and claims in respect of changes in the Contract Price or Contract Time will be referred initially to Engineer in writing with a request for a formal decision in accordance with this paragraph, which Engineer will render writing within a reasonable time. Written notice of each such claim, dispute and other matters will be delivered by the claimant to Engineer and the other party to the Agreement promptly (but in no event later than thirty days) after the occurrence of the event giving rise thereto, and written supporting data will be submitted to Engineer and the other party within sixty days after such occurrence unless Engineer allows an additional period of time to ascertain more accurate data in support of the claim.

When functioning as interpreter and judge under this Article, Engineer will not show partiality to City or Contractor and will not be liable in connection with any interpretation or decision rendered in good faith in such capacity. The rendering of a decision by Engineer pursuant this Article with respect to any such claim, dispute or other matter (except any which have been waived by the making or acceptance of final payment as permitted by the Agreement.) will be a condition precedent to any exercise by City or Contractor of such rights or remedies as either may otherwise have under the Contract Documents or by Laws or Regulations in respect of any such claim, dispute or other matter.

SC-61. **LIMITATIONS ON ENGINEER'S RESPONSIBILITIES** - Neither Engineer's authority to act nor any decision made by Engineer in good faith either to exercise or not exercise such authority shall give rise to any duty or responsibility of Engineer to Contractor, any Subcontractor, any Supplier, or any other person or organization performing any of the Work, or to any surety for any of them.

Whenever in the Contract Documents the terms "as ordered", "as directed", "as required", "as allowed", "as approved" or terms of like effect or import are used, or the adjectives "reasonable", "suitable", "acceptable", "proper" or "satisfactory" or adjectives of like effect or import are used to describe a requirement, direction, review or judgment of Engineer as to the Work, it is intended that such requirement, direction, review or judgment will be solely to evaluate the Work for compliance with the Contract Documents (unless there is a specific statement indicating other-wise). The use of any such term or adjective shall not be effective to assign to Engineer any duty or authority to supervise or direct the furnishing or performance of the Work or any duty or authority to undertake responsibility contrary to the provisions of this Article.

Engineer will not be responsible for Contractor's means, methods, techniques, sequences or procedures of construction, or the safety precautions and programs incident thereto, and Engineer will not be responsible for Contractor's failure to perform or furnish the Work in accordance with the Contract Documents.

Engineer will not be responsible for the acts or omissions of Contractor or of any Subcontractor, any Supplier, or of any other person or organization performing or furnishing any of the Work.

- SC-62. **SAFETY AND PRECAUTION** - Contractor shall be responsible for initiating, maintaining and supervising all safety precautions and programs in connection with the Work. Contractor shall take all necessary precautions for the safety of, and shall provide the necessary protection to prevent damage, injury or loss to:
- i. all employees on the Work and other persons and organizations who may be affected thereby;
 - ii. all the Work and materials and equipment to be incorporated therein, whether in storage on or off the site; and
 - iii. other property at the site or adjacent thereto, including trees, shrubs, lawns, walks, pavements, roadways, structures, utilities and Underground Facilities not designated for removal, relocation or replacement in the course of construction.

Contractor shall comply with all applicable Laws and Regulations of any public body having jurisdiction for the safety of persons or property or to protect them from damage, injury or loss; and shall erect and maintain all necessary safeguards for such safety and protection. Contractor shall notify owners of adjacent property and of Underground Facilities and utility owners when prosecution of the Work may affect them, and shall cooperate with them in the protection, removal, relocation and replacement of their property. All damage, injury or loss to any property referred to in paragraph caused, directly or in this Article directly, in whole or in part, by Contractor, any Subcontractor, Supplier or any other person or organization directly or indirectly employed by any of them to perform or furnish any of the Work or anyone for whose acts any of them may be liable, shall be remedied by Contractor (except damage or loss attributable to the fault of Drawings or Specifications or to the acts or omissions of City or Engineer or anyone employed by either of them or anyone for whose acts either of them may be liable, and not attributable, directly or indirectly, in whole or in part, to the fault or negligence of Contractor). Contractor's duties and responsibilities for the safety and protection of the Work shall continue until such time as all the Work is completed and Engineer has issued a notice to City and Contractor that the Work is acceptable (except as otherwise expressly provided in connection with Substantial Completion).

Contractor shall designate a responsible representative at the site whose duty shall be the prevention of accidents. This person shall be Contractor's superintendent unless otherwise designated in writing by Contractor to City.

In emergencies affecting the safety or protection of persons or the Work or property at the site or adjacent thereto, Contractor, without special instruction or authorization from Engineer or City, is obligated to act to prevent threatened damage, injury or loss. Contractor shall give Engineer prompt written notice that any significant changes in the Work or variations from the Contract Documents have been caused thereby. If Engineer determines that a change in the Contract Documents is required because of the action taken in response to an emergency, a Work Directive Change or Change Order will be issued to document the consequences of the changes or variations.

- SC-63. **RECORD DOCUMENTS** - Contractor shall maintain in a safe place at the site one record copy of all Drawings, Specifications, Addenda, Written Amendments, reviewed Shop Drawings, Change Orders, Work Directive Changes, Field Orders and written interpretations and clarifications in good order and annotated to show all changes made during construction. These record documents together with all reviewed samples and a counterpart of all reviewed Shop Drawings will be available to Engineer for reference. Upon completion of the Work, these record documents or as-builts, samples and Shop Drawings will be delivered to Engineer for City. Upon delivery of such documents to Engineer, the Contractor shall provide a written certification, signed and dated, that all documents accurately and completely reflect all deviations from or changes in the original Contract Documents made during construction of the project.

Record documents shall be up-to-date and available for review by the resident project representative prior to each application for progress payment. Payment will not be made for construction of items not shown on the record documents.

These requirements also supplement those of Item 68. Not less than two percent (2%) of the contract price shall be retained until correct record drawings, specifications, addenda, modifications and shop drawings are delivered to and reviewed by the Engineer.

- SC-64. **PHYSICAL CONDITIONS-UNDERGROUND FACILITIES** - *Shown or Indicated:* The information and data shown or indicated in the Contract Documents with respect to existing Underground Facilities at or contiguous to the site are based on information and data furnished to City or Engineer by the owners of such Underground Facilities or by others. Unless it is otherwise expressly provided in the Supplementary Conditions:

- i. City and Engineer shall not be responsible for the accuracy or completeness of any such information or data; and
- ii. Contractor shall have full responsibility for reviewing and checking all such information and data, for locating all Underground Facilities shown or indicated in the Contract Documents, for coordination of the Work with the owners of such Underground Facilities during construction, for the safety and protection thereof and repairing any damage thereto resulting from the Work, the cost of all of which will be considered as having been included in the Contract Price.

The word facility as used in this subsection titled "Utilities" includes any pipe conveying gases or liquids and appurtenances attached thereto; cables, conduits, wires, ducts and appurtenances; poles and appurtenances; any of which may be buried below grade or installed at or above grade

level. A facility excludes irrigation pipes, service connections and traffic signal wiring. A service connection is a pipe (excluding irrigation pipes), cable, wire, duct or conduit that is intended to connect a facility with a user. The word Utility as used in this subsection titled "Utilities" refers to the entity having legal owner-ship of the facility, service connection, irrigation pipe, or traffic signal wiring.

The Engineer has endeavored to determine the existence of underground facilities at the site of the work from the records of the utilities with known facilities in the vicinity of the work. The position of these facilities as derived from such records is shown on the plans. Service connections, irrigation pipes, and traffic signal wiring may not be shown on the plans. The Contractor shall make his own investigations, including exploratory excavations and contact with Utilities, to determine the exact locations and type of existing facilities, service connections, irrigation pipes, and traffic signal wiring prior to commencing work in the area and shall be responsible for any damage thereto.

Damage, injury, or loss resulting in whole or in part from the Contractor's failure to locate and preserve a facility, service connection, irrigation pipe, or traffic signal wiring shall under no circumstances be deemed attributable to the fault of the Drawings or Specifications or to the acts or omissions of the City or Engineer or anyone employed by either of them or anyone for whose acts either of them may be liable.

With respect to underground facilities, no claim for a change in the contract price may be allowed unless the Contractor discovers an underground facility which is not indicated or referred to in the Contract Documents or which is in a position differing materially and significantly from that indicated or referred to in the Contract Documents. If such discovery is made, the Contractor shall promptly notify in writing the City, Engineer and the Utility. The City may make changes in the alignment and grade of the work.

At no additional cost to the City, the Contractor shall replace, remove, relocate, protect, or temporarily maintain a facility which is not in a position differing materially and significantly from that indicated or referred to in the Contract Documents. At no additional cost to the City, the Contractor shall adjust the top elevation of all valve boxes and manholes to match the finish grade or pavement surface and shall replace, remove, relocate, protect, or temporarily maintain all service connections, irrigation pipes, and traffic signal wiring. The work on the facility, service connection, irrigation pipe or traffic signal wiring shall be done in a manner satisfactory to the Utility, it being understood that the Utility has the option of doing such work with his own forces, or permitting the work to be done by the Contractor.

SC-65. **PHYSICAL CONDITIONS**

65.1. Exploration and Reports: Reference is made in the Special Conditions to those reports of exploration and tests of subsurface conditions at the site that have been utilized by Engineer in preparation of the Contract Documents. Such reports are not guaranteed as to accuracy or completeness and are not part of the Contract Documents.

65.2. Unforeseen Conditions: Contractor shall promptly notify City and Engineer in writing of any subsurface or latent physical conditions at the site or in an existing structure differing materially from those indicated or referred to in the Contract Documents.

Engineer will promptly review those conditions and advise City in writing if further investigation or tests are necessary.

Promptly thereafter, City shall obtain the necessary additional investigations and tests and furnish copies to Engineer and Contractor. If Engineer finds that the results of such investigations or tests indicate that there are subsurface or latent physical conditions which differ materially from those intended in the Contract Documents, and which could not reasonably have been anticipated by Contractor, a Change Order shall be issued incorporating the necessary revisions.

SC-66. **REVIEW OF APPLICATION FOR PROGRESS PAYMENT** - Engineer will, within ten days after receipt of each Application for Payment, to either indicate in writing a recommendation of payment and present the Application to City, or return the Application to Contractor indicating in writing Engineer's reasons for refusing to recommend payment. In the latter case, Contractor may make the necessary corrections and resubmit the Application. Ten (10) days after presentation of the Application for Payment with Engineer's recommendation, the amount recommended will become due and when due will be paid by City to Contractor.

Engineer's recommendation of any payment requested in an Application for Payment will constitute a representation by Engineer to City, based on Engineer's on-site observations of the Work in progress as an experienced and qualified design professional and on Engineer's review of the Application for Payment and the accompanying data and schedules that the Work has progressed to the point indicated; that, to the best of Engineer's knowledge, information and belief, the quality of the Work is in accordance with the Contract Documents (subject to an evaluation of the Work as a functioning whole prior to or upon Substantial Completion, to the results of any subsequent tests called for in the Contract Documents, to a final determination of quantities and classifications for Unit Price Work, and to any other qualifications stated in the recommendation); and that Contractor is entitled to payment of the amount recommended. However, by recommending any such payment Engineer will not thereby be deemed to have represented that exhaustive or continuous on-site inspections have been made to check the quality or the quantity of the Work beyond the responsibilities specifically assigned to Engineer in the Contract Documents or that there may not be other matters or issues between the parties that might entitle Contractor to be paid additionally by City or City to withhold payment to Contractor.

Engineer's recommendation of final payment will constitute an additional representation by Engineer to City that the conditions precedent to Contractor's being entitled to final payment have been fulfilled.

Engineer may refuse to recommend the whole or any part of any payment if, in Engineer's opinion, it would be incorrect to make such representations to City. Engineer may also refuse to recommend any such payment, or, because of subsequently discovered evidence or the results of subsequent inspections or test, nullify any such payment previously recommended; to such extent as may be necessary in Engineer's opinion to protect City from loss.

City may refuse to make payment of the full amount recommended by Engineer because claims have been made against City on account of Contractor's performance or furnishing of the Work or Liens have been filed in connection with the Work or there are other items entitling City to a

set-off against the amount recommended, but City must give Contractor immediate written notice (with a copy to Engineer) stating the reasons for such action.

- SC-67. **SUBSTANTIAL COMPLETION** - When Contractor considers the entire Work ready for its intended use, Contractor shall notify City and Engineer in writing that the entire Work is substantially complete (except for items specifically listed by Contractor as incomplete) and request that Engineer issue a certificate of Substantial Completion. Within a reasonable time thereafter, City, Contractor and Engineer shall make an inspection of the Work to determine the status of completion. If Engineer does not consider the Work substantially complete, Engineer will notify Contractor in writing giving the reasons therefore. If Engineer considers the Work substantially complete, Engineer will prepare and deliver to City a tentative certificate of Substantial Completion which shall fix the date of Substantial Completion. There shall be attached to the certificate a tentative list of items to be completed or corrected before final payment. City shall have seven days after receipt of the tentative certificate during which to make written objection to Engineer as to any provisions of the certificate or attached list. If, after considering such objections, Engineer concludes that the Work is not substantially complete, Engineer will within fourteen days after submission of the tentative certificate to City notify Contractor in writing, stating the reasons therefore. If, after consideration of City's objections, Engineer considers the Work substantially complete, Engineer will within said fourteen days execute and deliver to City and Contractor a definitive certificate of Substantial Completion (with a revised tentative list of items to be completed or corrected) reflecting such changes from the tentative certificate as Engineer believes justified after consideration of any objections from City. At the time of delivery of the tentative certificate of Substantial Completion, Engineer will deliver to City and Contractor a written recommendation as to division of responsibilities pending final payment between City and Contractor with respect to security, operation, safety, maintenance, heat, utilities, insurance and warranties. Unless City and Contractor agree otherwise in writing and so inform Engineer prior to Engineer's issuing the definitive certificate of Substantial Completion, Engineer's aforesaid recommendations will be binding on City and Contractor until final payment.

City shall have the right to exclude Contractor from the Work after the date of Substantial Completion, but City shall allow Contractor reasonable access to complete or correct items on the tentative list.

- SC-68. **INSPECTIONS, CORRECTION, REMOVAL OF DEFECTIVE WORK** - Engineer and Engineer's representatives, other representatives of City, testing agencies and governmental agencies with jurisdictional interests will have access to the Work at reasonable times for their observation, inspecting and testing. Contractor shall provide proper and safe conditions for such access.

Contractor shall give Engineer timely notice of readiness of the Work for all required inspections or tests.

If Laws or Regulations of any public body having jurisdiction require any Work (or part thereof) to specifically be inspected, tested or approved, Contractor shall assume full responsibility therefore, pay all costs in connection therewith and furnish Engineer the required certificates of inspection, testing or approval. Contractor shall also be responsible for and shall pay all costs in connection with any inspection or testing required in connection with City's or Engineer's acceptance of a Supplier of materials or equipment proposed to be incorporated in the Work, or of materials or equipment submitted for approval prior to Contractor's purchase thereof for

incorporation in the Work. The cost of all inspections, tests and approvals in addition to the above which are required by the Contract Documents shall be paid by City (unless otherwise specified).

All inspections, tests or approvals other than those required by Laws or Regulations of any public body having jurisdiction shall be performed by organizations acceptable to City and Contractor (or by Engineer if so specified).

If any Work (including the work of others) that is to be inspected, tested or approved is covered without written concurrence of Engineer, it must, if requested by Engineer, be uncovered for observation. Such uncovering shall be at Contractor's expense unless Contractor has given Engineer timely notice of Contractor's intention to cover the same and Engineer has not acted with reasonable promptness in response to such notice.

Neither observations by Engineer nor inspections, tests or approvals by others shall relieve Contractor from Contractor's obligations to perform the Work in accordance with the Contract Documents.

If any Work is covered contrary to the written request of Engineer, it must, if requested by Engineer, be uncovered for Engineer's observation and replaced at Contractor's expense.

If Engineer considers it necessary or advisable that covered Work be observed by Engineer or inspected or tested by others, Contractor, at Engineer's request, shall uncover, expose or otherwise make available for observation, inspection or testing as Engineer may require, that portion of the Work in question, furnishing all necessary labor, material and equipment. If it is found that such Work is *defective*, Contractor shall bear all direct, indirect and consequential costs of such uncovering, exposure, observation, inspection and testing and of satisfactory reconstruction, (including but not limited to fees and charges of engineers, architects, attorneys and other professionals), and City shall be entitled to an appropriate decrease in the Contract Price, and, if the parties are unable to agree as to the amount thereof, may make a claim therefore as provided in Special Conditions. If, however, such Work is not found to be *defective*, Contractor shall be allowed an increase in the Contract Price or an extension of the Contract Time, or both, directly attributable to such uncovering, exposure, observation, inspection, testing and reconstruction; and, if the parties are unable to agree as to the amount or extent thereof, Contractor may make a claim therefore as provided in Special Conditions.

If the Work is *defective*, or Contractor fails to supply sufficient skilled workers or suitable materials or equipment, or fails to furnish or perform the Work in such a way that the completed Work will conform to the Contract Documents, City may order Contractor to stop the Work, or any portion thereof, until the cause for such order has been eliminated; however, this right of City to stop the Work shall not give rise to any duty on the part of City to exercise this right for the benefit of Contractor or any other party.

If required by Engineer, Contractor shall promptly either correct all *defective* Work, whether or not fabricated, installed or completed, or, if the Work has been rejected by Engineer, remove it from the site and replace it with *non-defective* Work. Contractor shall bear all direct, indirect and consequential costs of such correction or removal (including but not limited to fees and charges of engineers, architects, attorneys and other professionals) made necessary thereby.

SC-69. **ACCEPTANCE OF DEFECTIVE WORK; CORRECTION OF DEFECTIVE WORK BY THE City** - If, instead of requiring correction or removal and replacement of *defective* Work, City (and, prior to Engineer's recommendation of final payment) prefers to accept it, City may do so. Contractor shall bear all direct, indirect and consequential costs attributable to City's evaluation of and determination to accept such *defective* Work (such costs to be approved by Engineer as to reasonableness and to include but not be limited to fees and charges of engineers, architects, attorneys and other professionals). If any such acceptance occurs prior to Engineer's recommendation of final payment, a Change Order will be issued incorporating the necessary revisions in the Contract Documents with respect to the Work; and City shall be entitled to an appropriate decrease in the Contract Price, and, if the parties are unable to agree as to the amount thereof, City may make a claim. If the acceptance occurs after such recommendation, an appropriate amount will be paid by Contractor to City.

If Contractor fails within a reasonable time after written notice of Engineer to proceed to correct and to correct *defective* Work or to remove and replace rejected Work as required by Engineer, or if Contractor fails to perform the Work in accordance with the Contract Documents, or if Contractor fails to comply with any other provision of the Contract Documents, City may, after seven days' written notice to Contractor, correct and remedy any such deficiency. In exercising the rights and remedies under this paragraph City shall proceed expeditiously. To the extent necessary to complete corrective and remedial action, City may exclude Contractor from all or part of the site, take possession of all or part of the Work, and suspend Contractor's services related thereto, take possession of Contractor's tools, appliances, construction equipment and machinery at the site and incorporate in the Work all materials and equipment stored at the site or for which City has paid Contractor but which are stored elsewhere. Contractor shall allow City, City's representatives, agents and employees such access to the site as may be necessary to enable City to exercise the rights and remedies under this paragraph. All direct, indirect and consequential costs of City in exercising such rights and remedies will be charged against Contractor in an amount approved as to reasonableness by Engineer, and a Change Order will be issued incorporating the necessary revisions in the Contract Documents with respect to the Work; and City shall be entitled to an appropriate decrease in the Contract Price, and, if the parties are unable to agree as to the amount thereof, City may make a claim. Such direct, indirect and consequential costs will include but not be limited to fees and charges of engineers, architects, attorneys and other professionals, all court and arbitration costs and all costs of repair and replacement of work of others destroyed or damaged by correction, removal or replacement of Contractor's *defective* Work. Contractor shall not be allowed an extension of the Contract Time because of any delay in performance of the Work attributable to the exercise by City of City's rights and remedies hereunder.

SC-70. **ARBITRATION** - Before bringing any action in any court of competent jurisdiction pertaining to any claim, dispute or other matter in question arising out of or relating to the Contract Documents or the breach thereof, in an amount less than \$25,000, except for claims which have been waived by the making and acceptance of final payment, the claimant/objector (Party A) shall first offer to arbitrate the question(s) with the other party to the contract (Party B) by notifying him in writing and setting forth in such notice the question(s) to be arbitrated.

Party B can select to arbitrate or not. If Party B agrees to arbitrate he shall so advise Party A in writing within ten days after receipt of Party A's notice. Notice by Party B that he does not wish to arbitrate or failure of Party B to notify Party A within the ten-day period will give Party A the right to institute a court action.

If Party B agrees to arbitrate, the arbitration shall be in accordance with the Construction Industry Arbitration Rules of the American Arbitration Association except as modified herein. In such event, the agreement to arbitrate shall be specifically enforceable under the provisions of the Florida Arbitration Code, S682, Fla. Stat., as it may be from time to time amended. The award rendered by the arbitrators shall be final, and judgment may be entered upon it in any court having jurisdiction thereof.

If Party B agrees to arbitrate, then Party A shall file its notice of demand for arbitration in writing with Party B and with the American Arbitration Association, and a copy shall be filed with the Engineer. Notice of demand for arbitration shall be served on the parties referred to herein no later than thirty days from the date Party B agrees to arbitrate the issues in question. Failure to serve the notice of demand for arbitration shall constitute a waiver and abandonment of the claims for which arbitration is sought. Notice of demand for arbitration shall in no event be made on any claim, dispute or other matter in questions which would be barred by the applicable statute of limitations.

If the dollar amount of the claim exceeds \$25,000, arbitration may only be utilized if both Party A and party B agree to arbitrate.

The Contractor shall carry on the Work and maintain the progress schedule during any arbitration proceedings, unless otherwise mutually agreed in writing.

The Florida Rules of Civil Procedure pertaining to discovery shall apply to both parties during arbitration, and, at the City's sole option, any and all arbitration arising out of or relating to any of the Contract Documents or any breach thereof shall include by consolidation, joinder, or joint filing any additional person or entity not a party to this Agreement to the extent necessary for the final resolution of the matter in controversy.

At least one of the members of the arbitration panel must be an attorney licensed to practice law in the State of Florida.

The surety shall be bound by the arbitration award to the same extent as the Contractor is bound.

The arbitration panel shall submit a written opinion with findings of fact and conclusions of law stating the basis for the decision made, and including an award of arbitration that may be confirmed by a court of competent jurisdiction.

Unless City agrees to the contrary, the location of any and all arbitration proceedings shall be in Lake County, Florida.

[END OF SECTION]

Complete ALL the forms in this section and submit them in a sealed envelope as your bid response.

General Vendor Information			
Company Name:			
Physical Address:			
Mailing Address:			
Phone No.:		FEIN No.:	
Email Address:			
Financial Status: <input type="checkbox"/> Poor <input type="checkbox"/> Good <input type="checkbox"/> Excellent	No. of Years in Business:		
No. of Personnel Currently Employed:		No. of Personnel Available for this Project:	
Principal Name	Title		
Describe the type of work normally performed by your company:			

Provide information regarding who may be contacted regarding this bid response.

Primary Contact	
Name:	_____
Title:	_____
Address:	_____
Phone No.:	_____
	Mobile Phone No.: _____
Email Address:	

ITB 180401

SCHEDULE OF BID ITEMS

Your Bid MUST BE submitted on this form. Double check the Bid prices.
Amounts cannot be changed following the Bid due date and time.

Submitting Vendor Name: _____

BASE BID

ITEM NO.	ITEM DESCRIPTION	QTY	UNIT	UNIT PRICE
1	GENERAL CONDITIONS (Administration, Mobilization, Permits, etc.)	1	LS	\$
2	NEW HVAC SYSTEM Furnish & install all equipment and services as detailed in the Solicitation Package.	1	LS	\$
3	DRYWALL REPLACEMENT Furnish & install all drywall in designated area as detailed in the Solicitation Package.	1	LS	\$
4	CEILING FIXTURES INSTALLATION Furnish & install all light fixtures, smoke detectors and exhaust fan(s) as detailed in the Solicitation Package.	1	LS	\$
5	CARPET & MOLDING REPLACEMENT Remove existing carpet, install new carpet, install 6-inch vinyl cove base in areas of carpet and install 6-inch wood base molding in non-carpet areas as designated area as detailed in the Solicitation Package.	1	LS	\$
TOTAL BASE BID:				\$

TIME FOR COMPLETION

My company can mobilize and **START WORK** _____ calendar days after issuance of Notice to Proceed (NTP). My company will **COMPLETE THE PROJECT** _____ calendar days.

Bidders State of Florida Contractor License Number:

BIDDER'S CERTIFICATION

- I have carefully examined the Invitation to Bid, Instructions to Bidders, General and/or Special Conditions, Specifications, the Bid submitted and any other documents accompanying or made a part of this invitation.
- I hereby promise to furnish the goods or services specified in the Invitation to Bid at the prices or rates set forth in my bid. I agree that my bid will remain firm for the period established in the bid document in order to allow the City adequate time to evaluate the bids and make award. Furthermore, I agree to abide by all conditions of the bid.
- I certify that all information contained in this bid is truthful to the best of my knowledge and belief. I further certify that I am duly authorized to submit this bid on behalf of the vendor / contractor as its act and deed and that the vendor / contractor is ready, willing and able to perform if awarded the bid.
- I further certify that this bid is made without prior understanding, agreement, connection, discussion, or collusion with any person, firm or corporation submitting a bid for the same product or service; no officer, employee or agent of the City of Leesburg or of any other bidder interested in said bid; and that the undersigned executed this Bidder's Certification with full knowledge and understanding of the matters therein contained and was duly authorized to do so.
- I further certify that having read and examined the specifications and documents for the designated services and understanding the general conditions for contract under which services will be performed, does hereby propose to furnish all labor, equipment, and material to provide the services set forth in the Solicitation.
- I hereby declare that the following listing states any clarifications, any and all variations from and exceptions to the requirements of the specifications and documents. The undersigned further declares that the "work" will be performed in strict accordance with such requirements, and understands that any exceptions to the requirements of the specifications and documents may render the bidder's submission non-responsive.

NO EXCEPTIONS WILL BE ALLOWED AFTER THE BID IS SUBMITTED.

Please check one:

I take NO exceptions

I take the exceptions listed here:

(If more space is needed, please indicate exceptions here and attach additional pages as needed)

ADDENDUM ACKNOWLEDGMENT

No Addendum were issued.

The undersigned acknowledges receipt of the following addenda to the Invitation to Bid (indicate number and date of each):

Addendum No.	Dated:	Addendum No.	Dated:
Addendum No.	Dated:	Addendum No.	Dated:

FAILURE TO SUBMIT ACKNOWLEDGEMENT OF ANY ADDENDUM THAT AFFECTS THE BID PRICES IS CONSIDERED A MAJOR IRREGULARITY AND MAY BE CAUSE FOR REJECTION OF THE BID.

LOCAL VENDOR STATUS DECLARATION

The responding firm and firm that will enter into an agreement with the City, if selected, declares the following selected Local Vendor status.

Provide Physical Address of Business Office or Full Time Sales Office:
--

- My Firm Qualifies as a Tier I - Local Vendor for this solicitation**
 “Tier I Local Vendor” shall be defined as the primary Business Office or a Full Time Sales Office of the vendor being located within the City of Leesburg or the vendor receiving one or more Utility Services (excluding communications/Internet) from the City of Leesburg.
- My Firm Qualifies as a Tier II - Local Vendor for this solicitation**
 “Tier II Local Vendor” shall be defined as the primary Business Office or a Full Time Sales Office of the vendor not meeting the definition of a Tier I Local Vendor but nonetheless being located within the 20-Mile Radius as defined in this policy.
- My Firm does not qualify as a local vendor**

BID CERTIFICATION SIGNATURES
 (this section must be signed and completed.)

 Name of Business

 Telephone Number

By: _____
 Signature

 e-mail Address

 Printed Name

 Mailing Address

 Title

 City, State, Zip Code

STATEMENT OF EXPERIENCE - “SIMILAR” PROJECTS

List all SIMILAR projects your firm has completed. Copy this sheet if additional pages are needed. You must use this form. Attaching a separate listing may cause your bid to be deemed non-responsive and rejected.

<i>Project Name/Location:</i>		
<i>Project Owner:</i>		Date Completed:
<i>Project Description and Specific Scope: Be Descriptive. Use additional pages.</i>		
Contract Amounts:	Original \$	At Completion \$
Briefly Explain Any Variance:		
Contact Person:		
Contact e-mail:		
Phone Number:		
Project Name/Location:		
<i>Project Owner:</i>		Date Completed:
<i>Project Description and Specific Scope: Be Descriptive. Use additional pages.</i>		
Contract Amounts:	Original \$	At Completion \$
Briefly Explain Any Variance:		
Contact Person:		
Contact e-mail:		
Phone Number:		
Project Name/Location:		
<i>Project Owner:</i>		Date Completed:
<i>Project Description and Specific Scope: Be Descriptive. Use additional pages.</i>		
Contract Amounts:	Original \$	At Completion \$
Briefly Explain Any Variance:		
Contact Person:		
Contact e-mail:		
Phone Number:		

ATTACHMENTS

ENGINEERS DRAWINGS



EXISTING VENTED ATTIC TO BE MADE AIRTIGHT W/ OPEN CELL FOAM, R19

PHOTO-SOUTH ELEVATION

- RENOVATION NOTES**
1. FURNISH AND INSTALL 474 SQ. FT OF 5/8" FIRE RATED SHEET ROCK ON CEILING.
 2. FURNISH AND INSTALL 890 SQ. FT OF 5/8" FIRE RATED SHEET ROCK ON WALLS.
 3. CONSTRUCT ORANGE 890 SQ. FT OF PEEL WALL TEXTURE.
 4. CONSTRUCT PAINT AND PRIMER FOR 1240 SQ. FT.
 5. RE-INSTALL (7)-4' LIGHTING FIXTURE, (1) EXIT LIGHT STORED ON SITE
 6. CONSTRUCT NEW (5)-FOUR WAY OUTLET COVERS.
 7. CONSTRUCT (1) LIGHT SWITCH COVER.
 8. RE-INSTALL (3) SMOKE DETECTOR, STORED ON SITE.
 9. REMOVE OLD CARPET AND CONSTRUCT 2330 SQ. FT OF 2X2 CARPET SQUARES, OFFICES, CONFERENCE, HALLWAYS
 10. CONSTRUCT 235 LFT OF VINYL COVE BASE.
 11. CONSTRUCT 56 LFT OF 6" WOOD COVE BASE
 12. CONSTRUCT FOUR (4) CARPET TRANSITION STRIPS
 13. PROVIDED ONE CARTON OF CARPET SQUARE FOR ATTIC STOCK
 14. FOAMING OF ATTIC SPACE AIR TIGHT
 15. CONSTRUCT WALL SWITCH IN LABORATORY FOR EXHAUST FAN (SEE R-2 FOR LOCATION)



SEAL ALL VENTING AND FOAM AIRTIGHT (TYP.)

REPLACE DIFFUSER BOXES AND ADD NEW FLEX. (TYPICAL)

PHOTO-ATTIC 1

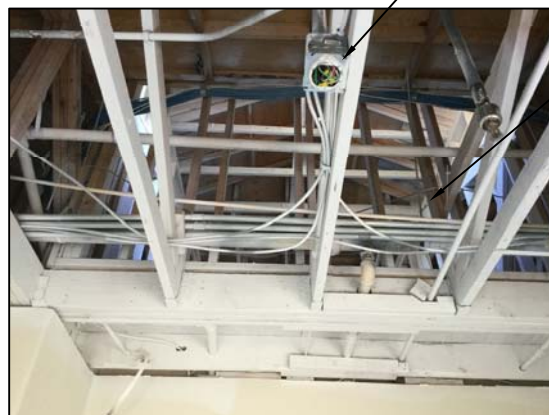

RE-INSTALL LIGHTS

ADD NEW DRYWALL

PHOTO-ATTIC 2



REPLACE CARPET

REPLACE VINYL COVING

PHOTO-FIRST FLOOR

REVISIONS	NO.	DESIGN WCH	DRAWN JPH	DATE	3/27/18	SEAL	ACCOUNT: 1787
EMI WILLARD C. HOANSHILT, P.E. FLORIDA P.E. NO. 42593 COB: 6160							GENERAL
CITY OF LEESBURG CANAL STREET OPERATION BUILDING IMPROVEMENTS							
DRAWING FILE R-1							
DRAWING R-1							
SHEET 1 OF 4							

A/C ZONE #4
(750 SQ FT, 100 CFM O/A)

A/C ZONE #3
(800 SQ FT, 275 CFM O/A)

A/C ZONE #5
(800 SQ FT, 240 CFM O/A)

A/C ZONE #1
(500 SQ FT, 250 CFM O/A)

A/C ZONE #2
(800 SQ FT, 265 CFM O/A)

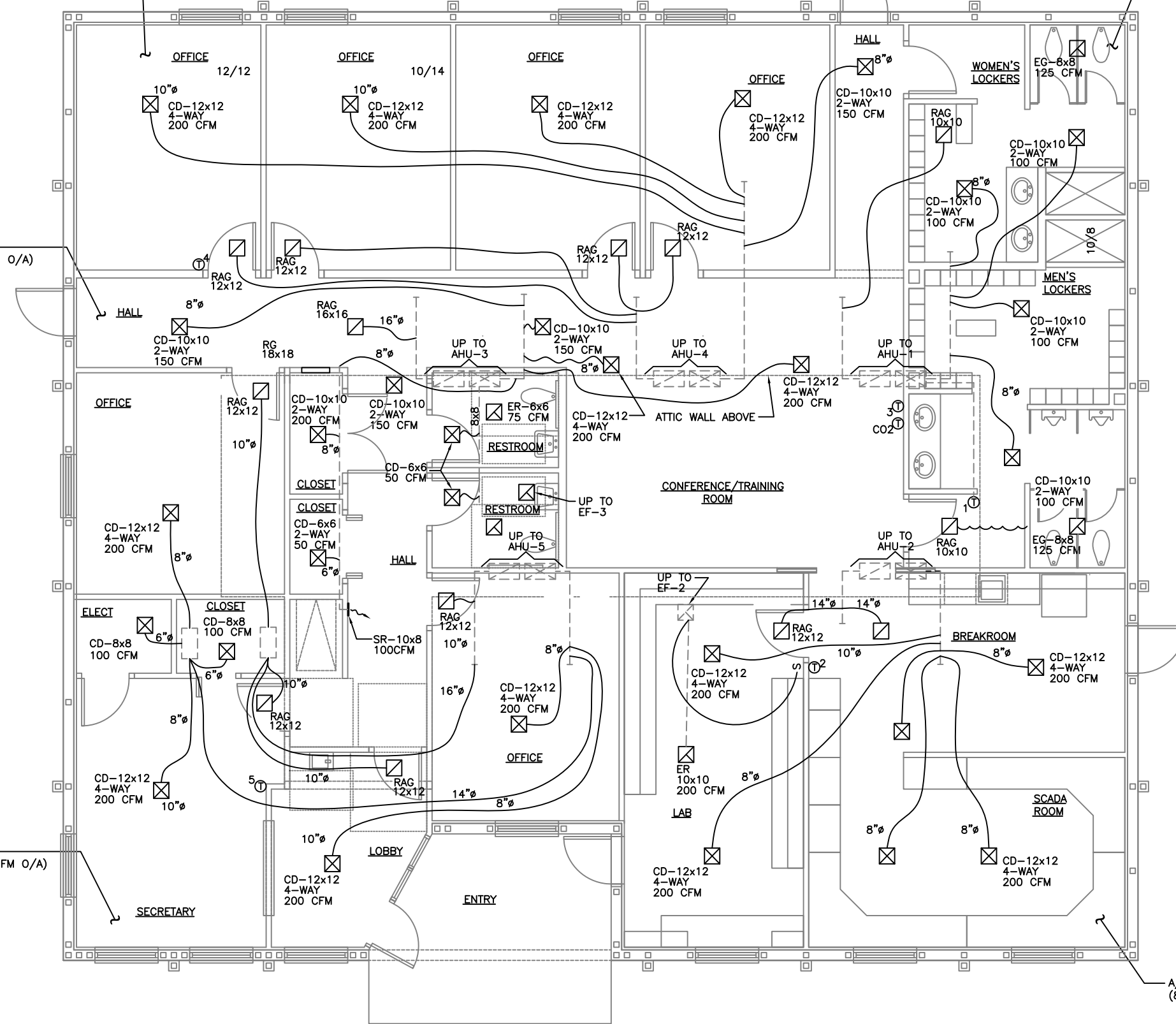
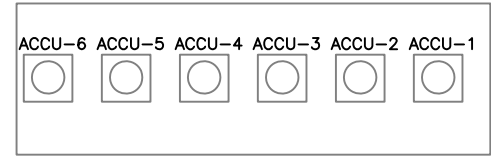

- LEGEND**
- EXISTING DUCTS
 - ~ FLEXIBLE DUCTS
 - ☒ EXHAUST AIR
 - ☒ SUPPLY AIR
 - ☒ RETURN AIR

- NOTES**
1. REPLACE ALL FLEX. DUCT
 2. REPLACE ALL DIFFUSERS, SUPPLY & R/A GRILLES & RELATED SQ TO ROUND CAN BOXES
 3. PROVIDE A FULL TEST AND BALANCE REPORT BY CERTIFIED CONTRACTOR
 4. ADD ONE TOGGLE SW., BOX & DEVICE PLATE FOR EF-2 IN LAB

AIR DEVICE SCHEDULE	
SYMBOL	DESCRIPTION
☐ CD	CEILING DIFFUSER, SQUARE, ADJUSTABLE, 24X24 MODULE SIZE DAMPERS, TITUS MODEL TDCA-AA WITH INSULATED TAP BOX
☒ PDR	PERFORATED CEILING MOUNTED, LAY-IN, DROP FACE, RETURN, TITUS MODEL PXP-AA
SR1	SIDEWALL SUPPLY REGISTER, 316 STAINLESS STEEL, TITUS 300 RL-SS/RS-SS WITH 316 OPPOSED BLADE DAMPER.
SR2	SIDEWALL SUPPLY REGISTER, ALUMINUM, TITUS IL-150-L WITH OPPOSED BLADE DAMPER.
SR3	SIDEWALL SUPPLY REGISTER, ALUMINUM, TITUS 300FL WITH DAMPER.
EG	EXHAUST GRILLE, 316 STAINLESS STEEL, TITUS 355RL-SS
ER	EXHAUST REGISTER, ALUMINUM, TITUS 50F & 50F-NT STANDARD CORE
CD1	CEILING DIFFUSER, ALUMINUM, TITUS MCD
RAG	RETURN AIR GRILLE, TITUS 355 ZRL-HD
◇	COMBINATION FIRE & SMOKE DAMPER, SMOKE DETECTOR, 120VAC, RUSKIN FSD36 OR EQUAL
◆	FIRE DAMPER, UL555, STYLE B, 1 1/2 HOUR

REVISIONS	NO.	DESIGN	WCH	DRAWN	JPH	DATE	3/27/18
SEAL							
ACCOUNT: 1787							
WILLARD C. HOANSHILT, P.E. FLORIDA P.E. NO. 42593 COB: 6160							
VENTILATION							
CITY OF LEESBURG CANAL STREET OPERATION BUILDING IMPROVEMENTS							
DRAWING FILE R-2							
DRAWING R-2							
SHEET 2 OF 4							

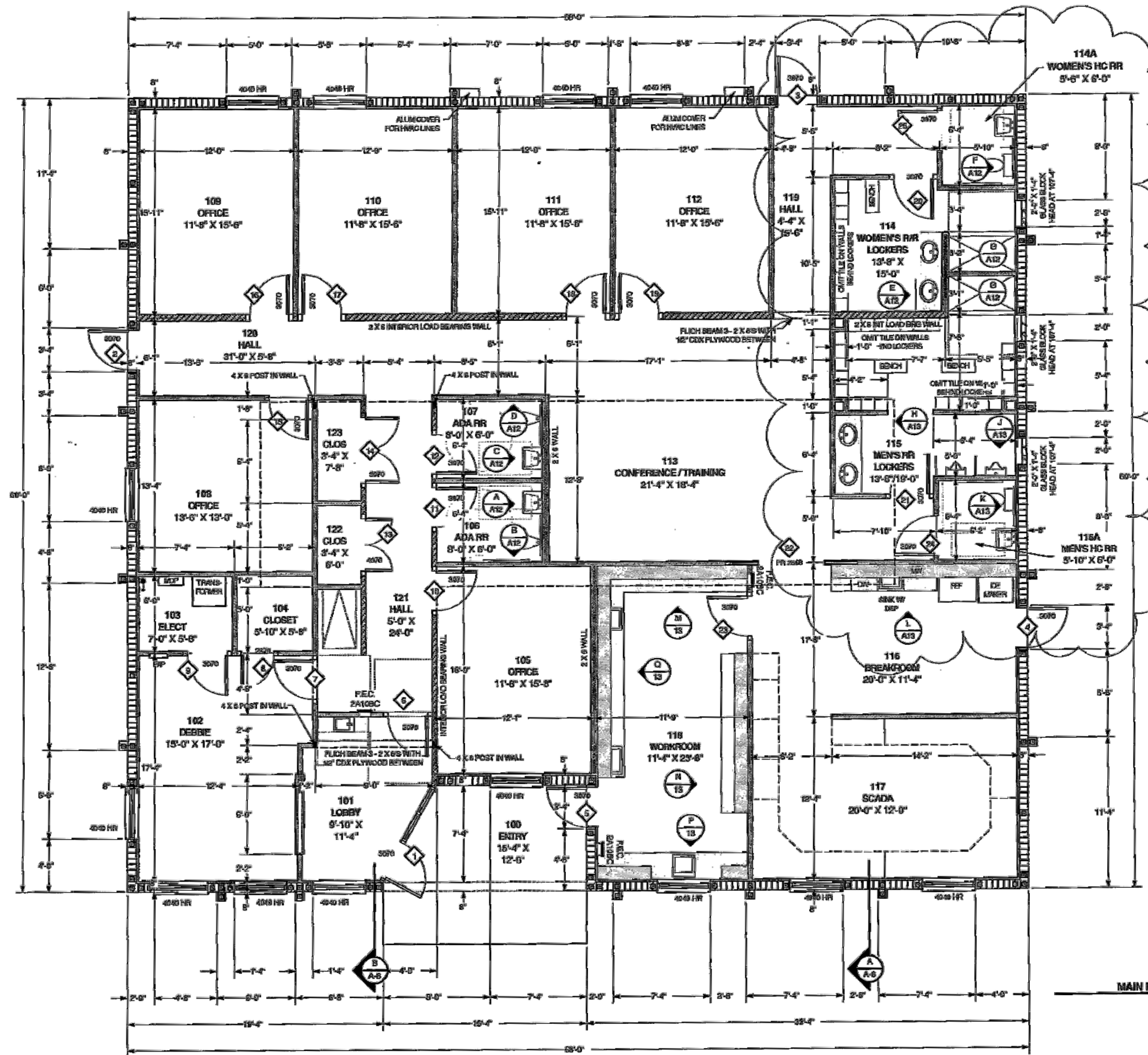

- 3,972 MAIN FLOOR ENCLD
- 108 ENTRY
- 4,080 MAIN FLOOR TUR
- 765 ATTIC (WAC)
- 4,757 TOTAL LIVING AREA
- 4,085 TOTAL TUR

MAIN FLOOR PLAN
Scale: 1/4" = 1'-0"

DESIGN		DRAWN		DATE	
NO.	WCH	JPH			
					3/27/18
SEAL					
EMI WILLARD C. HOANSHOLT, P.E. FLORIDA P.E. NO. 42593 COB: 6160					
FIRST FLOOR PLAN					
CITY OF LEEBSBURG CANAL STREET OPERATION BUILDING IMPROVEMENTS					
DRAWING FILE					
R-3					
DRAWING					
R-3					
SHEET 3 OF 4					

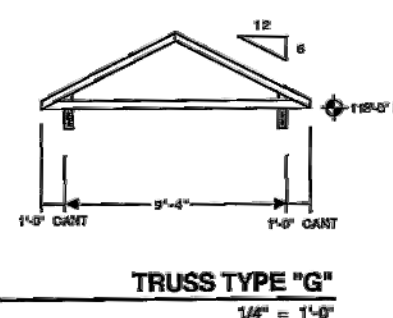
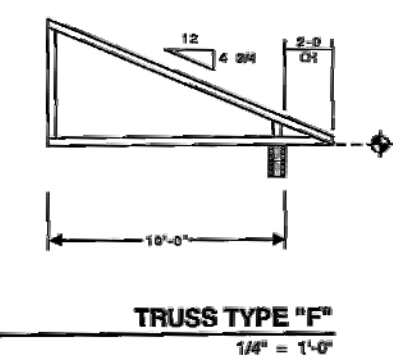
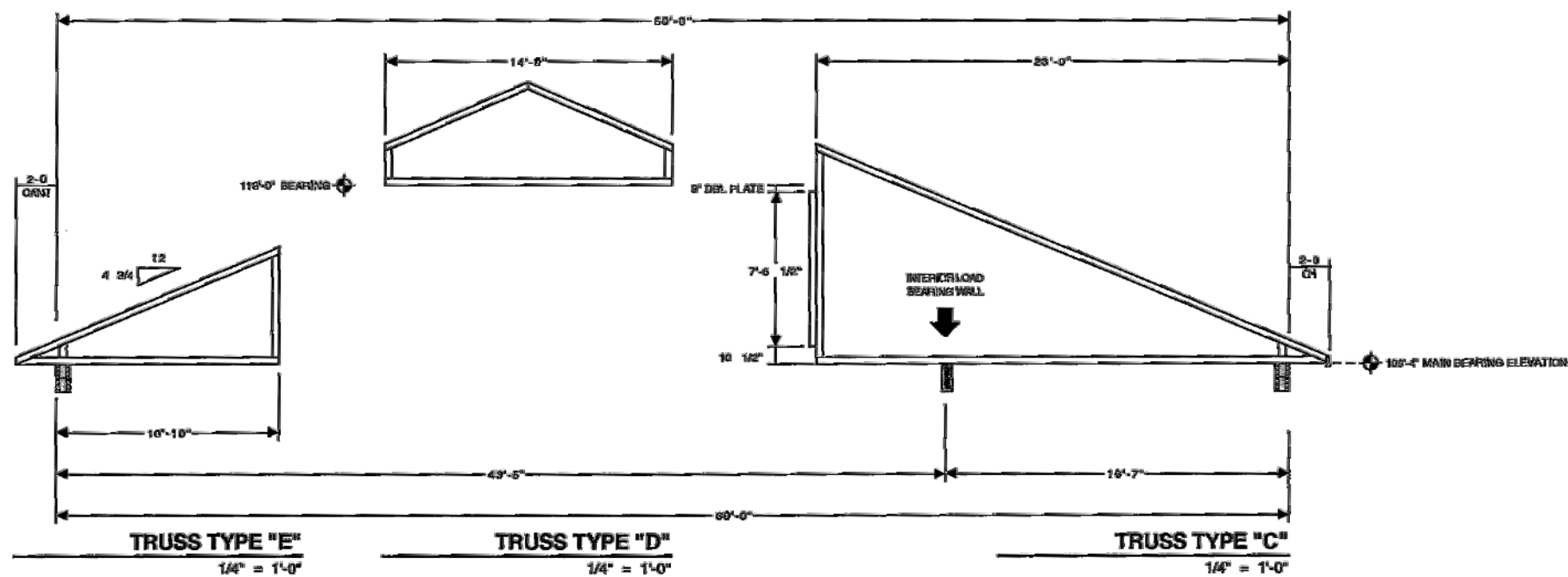
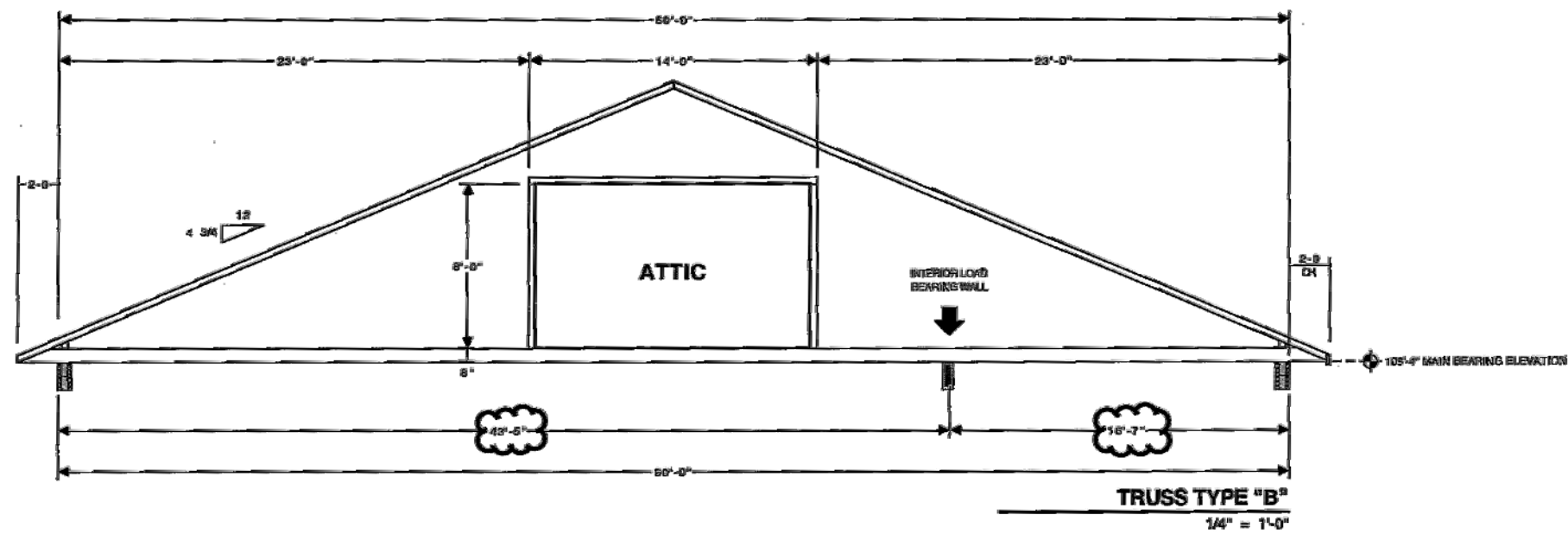
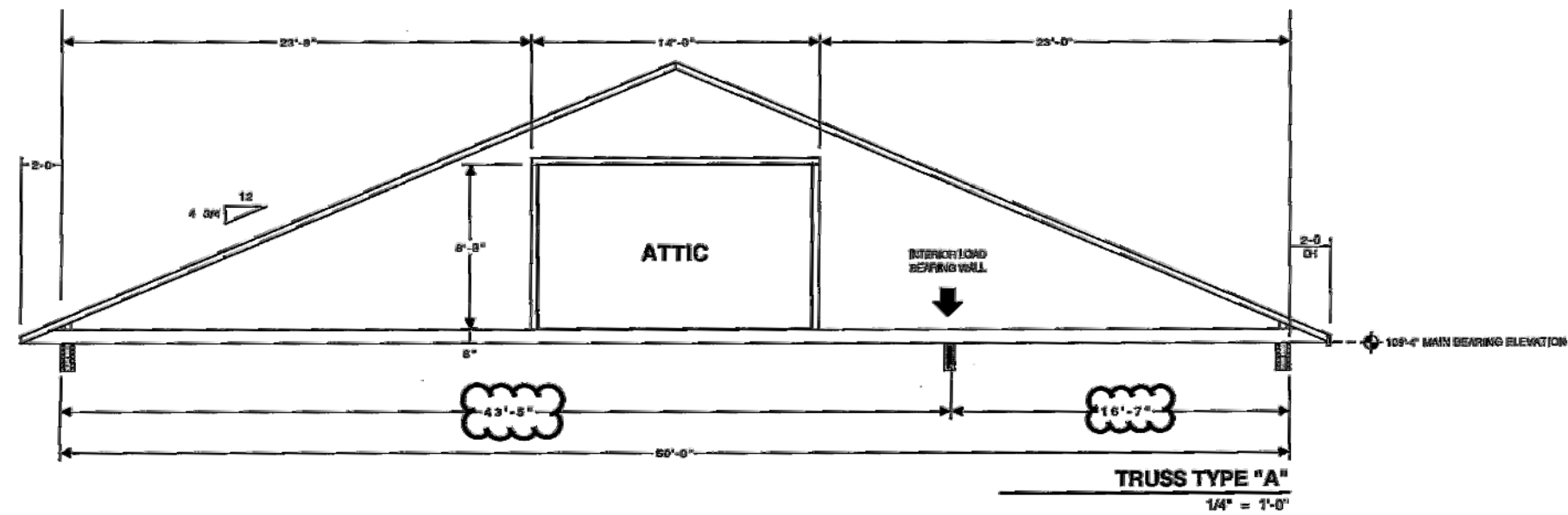

DESIGN		DRAWN		DATE	
NO.	WCH	JPH	DATE	NO.	REVISIONS
			3/27/18		
SEAL			ACCOUNT: 1787		
EMI WILLARD C. HOANSHOLT, P.E. FLORIDA P.E. NO. 42583 COB: 6160			BUILDING SECTIONS		
DRAWING FILE			DRAWING		
R-4			R-4		
SHEET 4			OF 4		