

**SIERRA COUNTY
STATE OF NEW MEXICO**

**REQUEST FOR PROPOSALS (RFP)
CONSTRUCTION SERVICES
CUCHILLO NEGRO ARROYO BANK STABILIZATION**



RFP #2019-05-009

**SIERRA COUNTY PROCUREMENT
855 VAN PATTEN
TRUTH OR CONSEQUENCES, NM 87901**

**Issue Date: December 20, 2019
Pre-proposal Conference: January 7, 2020 @ 11:00 AM
Question Deadline: January 16, 2020 @ 2:00 PM MDT
Due Date: January 30, 2020 @ 2:00 PM MDT**

OTHER INFORMATION:

NET 30

COMMODITY CODE REF: NIGP: 98826, 91223, 906, 925

INVITATION: Sierra County (hereinafter called County) invites you to submit an offer for the material(s) and/or services identified and described within this Request for Proposal (RFP). Please read carefully all instructions, specifications, and requirements, scope of work, terms and conditions. Failure to comply with the instructions, terms and conditions and specifications of this Request For Proposals may result in your offer being classified as unresponsive and disqualified. Offers must be submitted to the delivery location and mailing address indicated below no later than the time and date specified above. New Mexico criminal law prohibits bribes, gratuities and kickbacks.

OFFER SUBMITTAL:

All information must be entered in ink or typed and corrections must be initialed. **Offerors are required to submit, five (5) printed and one (1) electronic copies of their offer.** Offers are to be submitted in a sealed envelope or package, clearly marked with the Request for Proposal Number and Opening Date (see Offer Due By date above) in the lower left hand Corner. Failure to mark your sealed Offer Submission Envelope or package may result in your Offer being opened early or your offer not being included in the Request for Proposal Opening.

SUBMITTAL LOCATION:

Delivery Location and Mailing Address:

Sierra County
Attn: Jocelyn Holguin, Procurement Department
855 Van Patten
Truth or Consequences, NM 87901

SIERRA COUNTY CONTACT INFORMATION:

Jocelyn Holguin, Chief Procurement Officer

Telephone: 575-894-6215

E-mail: jholguin@sierraco.org

APPENDIX:

A - ACKNOWLEDGEMENT OF RECEIPT FORM

B - ACKNOWLEDGEMENT OF ADDENDA

C - CONFLICT OF INTEREST/DEBARMENT CERTIFICATION FORM

D - CAMPAIGN CONTRIBUTION DISCLOSURE FORM

E- FEDERAL FLOW-DOWN CERTIFICATION FORM

F - GENERAL CONDITIONS OF THE CONTRACT FOR CONSTRUCTION AIA 201 - 2007
TO INCLUDE SUPPLEMENTARY CONDITIONS

EXHIBITS:

A -- LETTER OF TRANSMITTAL FORM

B -- RFP QUESTION SUBMITTAL FORM

C -- REQUEST FOR COST FORM

D - SUB CONTRACTOR LISTING

E – INSURANCE REQUIREMENTS

CONT.

EXHIBIT LISTING- E-H1 AND H2 PAGE 71

F -- WAGE RATES (STATE OF NM PUBLIC WORKS)

G -- DAVIS BACON (FEDERAL WAGE RATES- REQUIRED WHEN FEDERAL FUNDS ARE INVOLVED)

H – PETTIGREW & ASSOCIATES PA BRIEF/ H1 ENGINEERING PLANS

OTHER INFORMATION:

Freight Terms: FOB Destination

Payment Terms: NET 30

INSTRUCTIONS TO OFFERORS

- 1. SUBMISSION OF PROPOSAL: OFFEROR PROPOSALS MUST BE RECEIVED FOR REVIEW AND EVALUATION BY THE CHIEF PROCUREMENT OFFICER OR DESIGNEE NO LATER THAN THE DATE INDICATED IN THE COVER SHEET. PROPOSALS RECEIVED AFTER THIS DEADLINE FOR ANY REASON WILL NOT BE ACCEPTED OR CONSIDERED.** The date and time of receipt will be recorded on each proposal. Proposals must be addressed and delivered to the Chief Procurement Officer at the delivery address listed. Proposals must be sealed and labeled on the outside of the package to clearly indicate that they are in response to the “Sierra County Flood Control- Cuchillo Negro” Request For Proposals and should reference “RFP #2019-05-009”. Proposals submitted by facsimile or other electronic means **WILL NOT BE ACCEPTED.** A public log will be kept of the names of all Offerors submitting proposals. Pursuant to Section 13-1-116 NMSA 1978, the contents of any proposal shall not be disclosed to competing Offerors prior to contract award.
- 2. ACKNOWLEDGEMENT OF ADDENDA:** Offerors shall acknowledge receipt of any addenda of this RFP by identifying the addendums number and date in the space provided on the offer form.
- 3. ALTERNATE OFFERS:** Alternate offers will be accepted and considered provided they are “equal to” and meet all specifications of this RFP which may include all specifications of the Brand used to identify the quality of the goods and/or services requested. The County reserves the right to make the final determination as to whether or not an alternate offer is equal. It is the Offeror’s responsibility to provide, as part of the offer, descriptive literature, specifications and information on all alternate products and services offered. References of current users should be included. If the item(s) or service(s) offered are not clearly identified as alternate item(s) or services, it is understood that the offer is for item(s) and service exactly as specified in this RFP.

4. **AWARD INFORMATION:** Award information will be posted electronically on the County's Procurement Department web site: <http://www.sierraco.org- Vendor Registry>
5. **AWARDS – MULTIPLE.** The County reserves the right to make multiple awards for projects in support of the Sierra County Flood Commission and Sierra County projects.
6. **SITE VISIT AND MANDATORY PRE-PROPOSAL CONFERENCE: JANUARY 7, 2020@ 11:00 AM- LOCATION: NM-51, MP 1- CUCHILLO NEGRO ARROYO, TRUTH OR CONSEQUENCES, NM 87901**
7. **DEADLINE TO SUBMIT WRITTEN QUESTIONS:** Potential Offerors may submit written questions as to the intent or clarity of this RFP until 2:00 PM MST on or before **January 16, 2020**. All written questions must be sent by e-mail to the Chief Procurement Officer or designated representative.
8. **RESPONSE TO WRITTEN QUESTIONS/RFP AMENDMENTS:** Written responses to written questions and any RFP amendments will be posted to the County Purchasing Office web site link: <http://www.sierraco.org- Vendor Registry>
9. **CANCELLATION:** The County reserves the right to cancel without penalty, this RFP, any resultant Purchase Order/Agreement, or any portion thereof for convenience, unsatisfactory performance, or unavailability of funds.
10. **CASH DISCOUNTS:** The County will take advantage of cash discounts offered whenever possible; however, cash discounts will not be used as a means to determine the lowest cost.
11. **CLARIFICATIONS:** Any clarification of instructions, terms and conditions, insurance, bonds, or offer preparation shall be made only by the CPO stated on the cover sheet of this RFP. Technical clarifications should be addressed to the individual identified on the cover sheet. Clarifications must be in writing and submitted as an addendum to be considered and relied upon as a part of this RFP solicitation.
12. **COPIES OF OFFER:** If submitting by hard copy or on CD, please submit the number of hard/CD copies of your offer as stated on the cover sheet along with all supporting documents. Proposal submitted on a CD must be in PDF format.
13. **LATE SUBMISSIONS:** Late submissions of offers will not be accepted or considered unless it is determined by County that the late receipt was due solely to mishandling by the County or the offer is the only offer received. Late submissions will be returned unopened.
14. **MODIFICATIONS:** Only modifications received prior to the date and time specified for the closing will be accepted. No modifications will be accepted after the opening. Technical

clarifications of the offer may be requested by the Chief Procurement Officer following the opening.

15. **OFFEROR CLARIFICATION:** The Offeror should include with their proposal a local or toll-free number and e-mail address for offer clarifications. Failure to do so may result in the Offer being deemed non-responsive.
16. **PERIOD FOR OFFER ACCEPTANCE:** Offeror agrees that any offer made submitted will be good for a period of ninety (120) calendar days; an additional time period may be requested in the RFP Scope of Work.
17. **PUBLIC INFORMATION:** All information, except that classified as confidential, will become public information at the time that the RFP is awarded. Confidential information must be marked "CONFIDENTIAL" in red letters in the upper right hand corner of the pages containing the confidential information. Price and information concerning the specifications cannot be considered confidential.
18. **REJECTION OF OFFERS:** The County reserves the right to make an award based on the evaluation criteria contained herein, to reject any and all offers or any part thereof, and to accept the offer that is in the best interest of the County.
19. **SUBMISSIONS OF DRAWINGS/LITERATURE:** The submission of samples, drawings and literature to be used in the evaluation of the offer, must be submitted by the designated closing date and time in order to be considered. All submissions shall be made at no expense to the County. Returns shall only be made at the Offers request and expense. Submissions provided on a CD shall be in PDF format.
20. **TAXES:** The County is exempt from Federal Excise Taxes and from New Mexico Gross Receipts Taxes on materials. Services are not exempt. Taxes on services should be included as a separate line item and not included in the base price offer. Applicable taxes are excluded from the RFP evaluation. A non-taxable transaction certificate can be made available by the County to the awarded firm.
21. **WITHDRAWAL OF OFFERS:** Offers may be withdrawn by written notice, electronically (email) or in person by an Offeror or an authorized representative at any time prior to the submittal due date and time. Offerors requiring bid security will result in forfeiture of the bid security if the offer is withdrawn following the opening.
22. **NOTIFICATION OF FINALISTS:** The Evaluation Committee may select finalists to be invited to participate in the subsequent steps of the procurement. The Evaluation Committee

reserves the right not to utilize the finalist process if they deem it in the best interest of the County.

23. **BEST AND FINAL OFFERS:** Finalists may be asked to submit revisions to their proposals for the purpose of obtaining best and final offers on the date to be determined.
24. **ORAL PRESENTATIONS:** Finalists may be required to attend and participate in an oral presentation (date(s) to be determined).
25. **ACCEPTANCE OF CONDITIONS GOVERNING THE PROCUREMENT:** Offerors must indicate their acceptance of the Conditions Governing the Procurement in the letter of transmittal form (see Appendix B). Submission of a proposal constitutes acceptance of the Evaluation Factors contained in Section II of this RFP.
26. **INCURRING COST:** Any cost incurred by the Offeror in preparation, transmittal, presentation of any proposal or material or negotiation associated with their response to this RFP shall be borne solely by the Offeror.
27. **PRIME CONTRACTOR RESPONSIBILITY:** Any contract that may result from this RFP shall specify that the prime contractor is solely responsible for fulfillment of the contract with the County. The County will only make contract payments to the prime contractor.
28. **SUBCONTRACTORS:** Use of subcontractors must be clearly explained in the proposal and each must be identified by name. The prime contractor shall be wholly responsible for contract performance whether or not subcontractors are used. Substitution of subcontractors, after contract award, must receive prior written approval of the County Purchasing Office.
29. **AMENDED PROPOSALS:** An Offeror may submit an amended proposal before the deadline for receipt of proposals. Such amended proposals must be complete replacements for a previously submitted proposal and must be clearly identified as such in the transmittal letter. County personnel will not merge, collate, or assemble proposal materials.
30. **OFFERORS RIGHT TO WITHDRAW PROPOSAL:** Offerors will be allowed to withdraw their proposals at any time prior to the deadline for receipt of proposals. The Offeror must submit a written withdrawal request signed by the Offeror's duly authorized representative addressed to the Chief Procurement Officer. The approval or denial of withdrawal requests received after the deadline for receipt of the proposals is governed by the applicable procurement regulations.
31. **PROPOSAL OFFER FIRM:** Responses to this RFP, including proposal prices, will be considered firm for one hundred twenty (120) days after the due date for receipt of proposals or ninety (90) days after the due date for the receipt of a best and final offer, if one is solicited.

32. DISCLOSURE OF PROPOSAL CONTENTS: The proposals will be kept confidential until a contract is awarded by the awarding authority. At that time, all proposals and documents pertaining to the proposals will be open to the public, except for material which is proprietary or confidential. The Chief Procurement Officer will not disclose or make public any pages of a proposal on which the Offeror has stamped or imprinted "proprietary" or "confidential" subject to the following requirements.

Proprietary or confidential data shall be readily separable from the proposal in order to facilitate eventual public inspection of the remaining portions of the proposal. Confidential data is normally restricted to confidential financial information concerning the Offeror's organization and data that qualifies as a trade secret in accordance with the Uniform Trade Secrets Act, 57-3A-1 to 57-3A-7 NMSA 1978. The price of products offered or the cost of services proposed shall not be designated as proprietary or confidential information.

If a request is received for disclosure of data for which an Offeror has made a written request for confidentiality, the Purchasing Agent shall examine the Offeror's request and make a written determination that specifies which portions of the proposal should be disclosed. Unless the Offeror takes legal action to prevent the disclosure, the proposal will be so disclosed. The proposal shall be open to public inspection subject to any continued prohibition on the disclosure of confidential data.

- 33. NO OBLIGATION:** This procurement in no manner obligates Sierra County or any of its departments or other subdivisions to the eventual lease, purchase, etc., of any tangible personal property offered or services proposed until a valid written contract is approved by the Chief Procurement Officer and other required approval authorities.
- 34. TERMINATION:** This RFP may be canceled at any time and any and all proposals may be rejected in whole or in part when the County determines such action to be in the best interest of the County.
- 35. SUFFICIENT APPROPRIATION:** Any contract awarded as a result of this RFP process may be terminated if sufficient appropriations or authorizations do not exist. Such termination will be effected by sending written notice to the contractor. The County's decision as to whether sufficient appropriations and authorizations are available will be accepted by the contractor as final.
- 36. LEGAL REVIEW:** The County requires that all Offerors agree to be bound by the General Requirements contained in this RFP. Any Offeror concerns must be promptly brought to the attention of the Chief Procurement Officer.
- 37. GOVERNING LAW:** This procurement and any agreement with Offerors that may result shall be governed by the laws of the State of New Mexico and Federal Government.

- 38. BASIS FOR PROPOSAL:** Only information supplied by the County in writing through the Chief Procurement Officer or in this RFP should be used as the basis for the preparation of Offeror proposals.
- 39. OFFEROR QUALIFICATIONS:** The Evaluation Committee may make such investigations as necessary to determine the ability of the Offeror to adhere to the requirements specified within this RFP. The Evaluation Committee will reject the proposal of any Offeror who is not a responsible Offeror or fails to submit a responsive offer as defined in Sections 13-1-83 and 13-1-85 NMSA 1978.
- 40. RIGHT TO WAIVE MINOR IRREGULARITIES:** The Evaluation Committee reserves the right to waive minor irregularities. The Evaluation Committee also reserves the right to waive mandatory requirements provided that all of the otherwise responsive proposals failed to meet the same mandatory requirements or doing so does not otherwise materially affect the procurement. This right is at the sole discretion of the Evaluation Committee.
- 41. CHANGE IN CONTRACTOR REPRESENTATIVES:** The County reserves the right to require a change in contractor representatives if the assigned representatives are not, in the opinion of the County, meeting its needs adequately.
- 42. NOTICE:** The Procurement Code, Sections 13-1-28 through 13-1-199 NMSA 1978, imposes civil and misdemeanor criminal penalties for its violation. The State of New Mexico criminal statutes also impose felony penalties for bribes, gratuities and kick-backs.
- 43. COUNTY RIGHTS:** The County reserves the right to accept all or a portion of an Offeror's proposal.
- 44. RIGHT TO PUBLISH:** Throughout the duration of this procurement process and contract term, potential Offeror's and contractors must secure from the County written approval prior to the release of any information that pertains to the potential work or activities covered by this procurement or the subsequent contract. Failure to adhere to this requirement may result in disqualification of the Offeror's proposal or termination of the contract.
- 45. OWNERSHIP OF PROPOSALS:** All documents submitted in response to the RFP shall become the property of the County. However any technical or user documentation submitted with the proposals of non-selected Offerors may be returned after the expiration of the protest period, by request, at the expense of the Offeror.
- 46. AMBIGUITY, INCONSISTENCY OR ERRORS IN RFP:** Offerors shall promptly notify the Chief Procurement Officer, in writing, of any ambiguity, inconsistency or error which they discover upon examination of the RFP.

- 47. COMPETITION:** By submitting a proposal, Offeror certifies that they have not, either directly or indirectly, entered into any action in restraint of full competition in connection with the proposal submitted to the County.
- 48. CONFIDENTIALITY:** Any confidential information provided to, or developed by, the contractor in the performance of any agreement resulting from this RFP shall be kept confidential and shall not be made available to any individual or organization by the contractor without the prior written approval of the County of Sierra.
- 49. ELECTRONIC MAIL ADDRESS REQUESTED:** A large part of the communication regarding this procurement will be conducted by electronic mail (e-mail). Offeror must have a valid e-mail address to receive this correspondence.
- 50. USE OF ELECTRONIC VERSIONS OF THIS RFP:** This RFP is being made available by electronic means. If accepted by such means, the Offeror acknowledges and accepts full responsibility to insure that no changes are made to the RFP. In the event of conflict between a version of the RFP in the Offeror's possession and the version maintained by the County, the version maintained by the County shall govern.
- 51. BACKGROUND INVESTIGATIONS:** Sierra County is committed to the safety of its employees, contractors and the community it serves. To that end, any firm awarded a contract shall be required to assure that the personnel assigned to the project do not possess criminal records that would violate the standards for employment. The successful Offeror(s) must certify that the company and its' employees are or will be in compliance with those standards for the project awarded.

REQUEST FOR PROPOSAL (RFP) STANDARD TERMS AND CONDITIONS

The purchases of materials and/or services awarded under this RFP shall be subject to the County's "Standard Terms and Conditions" and all information and statements contained in this Request for Proposal. Offerors may submit alternate terms and conditions; however, County reserves the right to reject the language if it is determined not to be in the best interest of County.

The following General Terms and Conditions are an equal and integral part of this Request For Proposal (RFP). The terms, conditions and specifications contained in this RFP along with any attachments and the Offerors' response may be incorporated into any Purchase Order/ Agreement issued as a result of this RFP, including any addenda. The County reserves the right to negotiate with a successful Offeror (Contractor) provisions in addition to those stipulated in this RFP. The contents of this RFP, as revised and/or supplemented, and the successful Offerors' proposal may be incorporated into the Contract. Should an Offeror object to any of the County's Standard Terms and Conditions the Offeror must propose specific alternative language that would be acceptable to the County. General references to the Offerors' terms and conditions or attempts at complete substitutions are not acceptable to the County and will result in disqualification of the

Offerors' proposal. Offerors' must provide a brief statement of the purpose and impact, if any, of each proposed change; followed by the specific proposed alternate wording.

Any proposed changes to the terms and conditions attached to this RFP must be stated in Offerors' proposal in a Section marked "STANDARD TERMS AND CONDITIONS". Offerors are cautioned that any changes to the terms and conditions that are NOT stated in the RFP response will not be entertained by the County at a later date. Any provisions in any proposal, quotation, acknowledgment or other forms or contract documents applicable to the services that are inconsistent, or in conflict, with any provisions of this RFP or the resultant contract will be ineffective and inapplicable.

The County reserves the right to reject a proposal on the basis the compromising language cannot be accepted by the County. Any additional terms and conditions which may be the subject of negotiation will be discussed only between the County and the successful Offeror and shall not be deemed an opportunity to amend the Offeror's proposal.

An Awardee of a Price Agreement established with the County has the opportunity to market the resultant Price Agreement to other local public bodies and state agencies under the State of New Mexico Public Purchases and Property Act, NMSA 1978, Article 1, Procurement, Section 13-1-129, "Procurement under existing contracts."

- 1. ACCEPTANCE AND REJECTION:** If prior to final acceptance, any goods or services are found to be defective or not as specified, or if the County is entitled to revoke acceptance of them the County may reject or revoke acceptance, require Contractor to correct without charge within a reasonable time, or require delivery at an equitable reduction in price, at the County's option. Contractor shall reimburse the County for all incidental and consequential costs related to unaccepted goods or services. Notwithstanding final acceptance and payment, Contractor shall be liable for latent defects, fraud, or such gross mistakes as amount to fraud. Acceptance of goods or services shall not waive the right to claim damages for breach of contract.
- 2. APPROPRIATIONS:** The terms of this Agreement are contingent upon sufficient appropriations and authorization being made by the Board of County Commissioners for the performance of each task order assigned under this Agreement. If sufficient appropriations and authorization are not made by the Board of County Commissioners, this Agreement shall terminate immediately upon written notice being given by the County to the Contractor. The County's decision as to whether sufficient appropriations are available shall be accepted by the Contractor and shall be final. If the County proposes an amendment to the Agreement to unilaterally reduce funding, the Contractor shall have the option to terminate the Agreement or to agree to the reduced funding, within thirty (30) days of receipt of the proposed amendment.

3. **ASSIGNMENT:** Any resultant Purchase Order/Agreement may be assignable by the County. Except as to any payment due hereunder, any resultant Purchase Order/Agreement shall not be assignable by Contractor without written approval from the County.
4. **AUTHORITY:** If Contractor is other than a natural person, the individual(s) signing this Agreement on behalf of Contractor represents and warrants that he or she has the power and authority to bind Contractor, and that no further action, resolution, or approval from Contractor is necessary to enter into a binding contract.
5. **CHANGES:** The County may make changes within the general scope of any resultant Purchase Order/Agreement by giving notice to Contractor and subsequently confirming such changes in writing. If such changes affect the cost of, or the time required for performance of a resultant Purchase Order/Agreement, an appropriate equitable adjustment shall be made. No change by Contractor shall be recognized without written approval of the County. Any claim of Contractor for an adjustment under this Paragraph must be made in writing within thirty (30) days from the date of receipt by Contractor of notification of such change. Nothing in this Paragraph shall excuse Contractor from proceeding with the performance of the Purchase Order/Agreement as changed hereunder.
6. **COMPENSATION:**
 - A. The County shall pay to the Contractor in full payment for services satisfactorily performed under the individual Task Orders based on the schedule of payments contained in the individual task order. In no event will the Contractor be paid any amount in excess of the specified total amount payable in the individual task order without the task order being amended in writing.
 - B. Payment is subject to availability of funds pursuant to the Appropriations Paragraph set forth below and to any negotiations between the parties from year to year pursuant to Article 1, Scope of Work.
 - C. Contractor must submit a detailed statement accounting for all services performed, as specified in the individual task order. If the County finds that the services are not acceptable, within thirty days after the date of receipt of written notice from the Contractor that payment is requested, it shall provide the Contractor a letter of exception explaining the defect or objection to the services, and outlining steps the Contractor may take to provide remedial action. The County will continue to pay Contractor for any undisputed amounts pursuant to Article 6 (A). Upon certification by the County that the services have been received and accepted, payment shall be tendered to the Contractor within thirty days after the date of acceptance. If payment is made by mail, the payment shall be deemed tendered on the date it is postmarked. However, the County shall not incur late charges, interest, or penalties for failure to make payment within the time specified herein.

- D. The payment of taxes due for any money received under this Agreement shall be the Contractor's sole responsibility and shall be reported under the Contractor's Federal and State tax identification number(s).
7. **CONFIDENTIALITY:** Any confidential information provided to or developed by the Contractor in the performance of this Agreement shall be kept confidential and shall not be made available to any individual or organization by the Contractor without the prior written approval of the County.
8. **CONTRACTOR'S EMPLOYEES AND AGENTS:** Contractor shall have complete charge and responsibility for persons employed by Contractor and engaged in the performance of the specified work. The Contractor, its agents and employees state that they are independent contractors and not employees of the County. Contractor, its agents and employees shall not accrue leave, retirement, insurance, bonding or any other benefit afforded to employees of the County as a result of any resultant Purchase Order/Agreement.
9. **DISCLAIMER AND HOLD HARMLESS:** Sierra County shall not be liable to the Contractor, or the Contractor's successors, heirs, administrators, or assigns, for any loss, damage, or injury, whether to Contractor's person or property, occurring in connection with Contractor's performance of Contractor's duties according to this Agreement. Contractor shall hold Sierra County harmless from all loss, damage, and injury, including court costs and attorney fees, incurred by Sierra County in connection with the performance by Contractor of Contractor's duties according to this Agreement.
10. **DISCOUNTS:** If prompt payment discounts apply to any resultant Purchase Order/Agreement, any discount time will not begin until the materials, supplies, or services have been received and accepted and a correct invoice has been received by the County's Accounts Payable Department. In the event testing is required prior to acceptance, the discount time shall begin upon completion of the tests and acceptance.
11. **ENFORCEMENT OF AGREEMENT:** A party's failure to require strict performance of any provision of this Agreement shall not waive or diminish that party's right thereafter to demand strict compliance with that or any other provision. No waiver by a party of any of its rights under this Agreement shall be effective unless expressed in writing, and no effective waiver by a party of any of its rights shall be effective to waive any other rights.
12. **ELIGIBILITY FOR PARTICIPATION IN GOVERNMENT PROGRAMS:** Each party represents that neither it nor any of its management or any other employees or independent contractors who will have any involvement in the services or products supplied under a resultant Purchase Order/Agreement, have been excluded from participation in any government healthcare program, debarred from or under any other

federal program (including but not limited to debarment under the Generic Drug Enforcement Act), or convicted of any offense defined in 42 U.S.C. Section 1320a-7, and that each party, its employees and independent contractors are not otherwise ineligible for participation in federal healthcare programs. Further, each party represents that it is not aware of any such pending action(s) (including criminal actions) against each party or its employees or independent contractors. Each party shall notify the other immediately upon becoming aware of any pending or final action in any of these areas.

- 13. EQUAL OPPORTUNITY AND AFFIRMATIVE ACTION:** In performing or providing the services and goods required under a resultant Purchase Order/Agreement, each party shall be an equal opportunity employer and shall conform to all affirmative action and other applicable requirements; accordingly, each party shall neither discriminate nor permit discrimination in its operations or employment practices against any person or group of persons on the basis of race, age, religion, color, national origin, ancestry, sex, physical or mental handicap or medical condition, sexual preference, prior military involvement or any other manner prohibited by law.
- 14. FEDERAL GOVERNMENT SUBCONTRACT PROVISIONS:** The clauses contained in the referenced paragraphs of the Federal Acquisition Regulations (FAR) are hereby incorporated by reference. In the event of any conflict between the terms and conditions of these Federal Acquisition Regulations and any other provisions of this Agreement, the terms and conditions of these Federal Acquisition Regulations shall prevail. For the purposes of Sierra County, in all of the following clauses, the terms "contract" shall mean the resultant Agreement, and the term "contractor" shall mean "seller." The term "Government" shall mean "Sierra County" and the terms "contracting officer" shall mean the "Chief Procurement Officer," except in those clauses with an "*" in the third column (Contract Grant). In the clauses marked with an "*", "Government" shall mean "United States Government."
- A. 52.222-6 Davis Bacon Act (\$2,000 or greater)**
- (1) All laborers and mechanics employed or working upon the site of the work will be paid unconditionally and not less often than once a week, and without subsequent deduction or rebate on any account (except such payroll deductions as are permitted by regulations issued by the Secretary of Labor under the Copeland Act (29 CFR part 3)), the full amount of wages and bona fide fringe benefits (or cash equivalents thereof) due at time of payment computed at rates not less than those contained in the wage determination of the Secretary of Labor which is attached hereto and made a part hereof, or as may be incorporated for a secondary site of the work, regardless of any contractual relationship which may be alleged to exist between the Contractor and such laborers and mechanics. Any wage determination incorporated for a secondary site of the work shall be effective from the first day on which work under the contract was performed at that site and shall be incorporated without any adjustment in contract price or estimated cost. Laborers employed by the construction Contractor or

construction subcontractor that are transporting portions of the building or work between the secondary site of the work and the primary site of the work shall be paid in accordance with the wage determination applicable to the primary site of the work.

- (2) Contributions made or costs reasonably anticipated for bona fide fringe benefits under section 1(b)(2) of the Construction Wage Rate Requirements statute on behalf of laborers or mechanics are considered wages paid to such laborers or mechanics, subject to the provisions of paragraph (e) of this clause; also, regular contributions made or costs incurred for more than a weekly period (but not less often than quarterly) under plans, funds, or programs which cover the particular weekly period, are deemed to be constructively made or incurred during such period.
- (3) Such laborers and mechanics shall be paid not less than the appropriate wage rate and fringe benefits in the wage determination for the classification of work actually performed, without regard to skill, except as provided in the clause entitled Apprentices and Trainees. Laborers or mechanics performing work in more than one classification may be compensated at the rate specified for each classification for the time actually worked therein; provided that the employer's payroll records accurately set forth the time spent in each classification in which work is performed.
- (4) The wage determination (including any additional classifications and wage rates conformed under paragraph (c) of this clause) and the Construction Wage Rate Requirements (Davis-Bacon Act) poster (WH-1321) shall be posted at all times by the Contractor and its subcontractors at the primary site of the work and the secondary site of the work, if any, in a prominent and accessible place where it can be easily seen by the workers.
 - (c)(1) The Contracting Officer shall require that any class of laborers or mechanics which is not listed in the wage determination and which is to be employed under the contract shall be classified in conformance with the wage determination. The Contracting Officer shall approve an additional classification and wage rate and fringe benefits therefor only when all the following criteria have been met:
 - (i) The work to be performed by the classification requested is not performed by a classification in the wage determination.
 - (ii) The classification is utilized in the area by the construction industry.
 - (iii) The proposed wage rate, including any bona fide fringe benefits, bears a reasonable relationship to the wage rates contained in the wage determination.

B. 52-203-7 Kickbacks, prohibits any person from:

- (1) Providing or attempting to provide or offering to provide any kickback;
- (2) Soliciting, accepting, or attempting to accept any kickback; or

- (3) Including, directly or indirectly, the amount of any kickback in the contract price charged by a prime Contractor to the United States or in the contract price charged by a subcontractor to a prime Contractor or higher tier subcontractor.

**C. 52.222-4 CONTRACT WORK HOURS AND SAFETY STANDARDS ACT--
OVERTIME COMPENSATION (MAY 2014)**

a) *Overtime requirements.* No Contractor or subcontractor employing laborers or mechanics (see Federal Acquisition Regulation 22.300) shall require or permit them to work over 40 hours in any workweek unless they are paid at least 1 and 1/2 times the basic rate of pay for each hour worked over 40 hours.

(b) *Violation; liability for unpaid wages; liquidated damages.* The responsible Contractor and subcontractor are liable for unpaid wages if they violate the terms in paragraph (a) of this clause. In addition, the Contractor and subcontractor are liable for liquidated damages payable to the Government. The Contracting Officer will assess liquidated damages at the rate of \$10 per affected employee for each calendar day on which the employer required or permitted the employee to work in excess of the standard workweek of 40 hours without payment of the overtime wages required by the Contract Work Hours and Safety Standards statute (found at 40 U.S.C. chapter 37).

(c) *Withholding for unpaid wages and liquidated damages.* The Contracting Officer will withhold from payments due under the contract sufficient funds required to satisfy any Contractor or subcontractor liabilities for unpaid wages and liquidated damages. If amounts withheld under the contract are insufficient to satisfy Contractor or subcontractor liabilities, the Contracting Officer will withhold payments from other Federal or Federally assisted contracts held by the same Contractor that are subject to the Contract Work Hours and Safety Standards statute.

(d) *Payrolls and basic records.*

(1) The Contractor and its subcontractors shall maintain payrolls and basic payroll records for all laborers and mechanics working on the contract during the contract and shall make them available to the Government until 3 years after contract completion. The records shall contain the name and address of each employee, social security number, labor classifications, hourly rates of wages paid, daily and weekly number of hours worked, deductions made, and actual wages paid. The records need not duplicate those required for construction work by Department of Labor regulations at 29 CFR 5.5(a)(3) implementing the Construction Wage Rate Requirements statute.

(2) The Contractor and its subcontractors shall allow authorized representatives of the Contracting Officer or the Department of Labor to inspect, copy, or transcribe records maintained under paragraph (d)(1) of this clause. The Contractor or subcontractor also

shall allow authorized representatives of the Contracting Officer or Department of Labor to interview employees in the workplace during working hours.

(e) *Subcontracts*. The Contractor shall insert the provisions set forth in paragraphs (a) through (d) of this clause in subcontracts may require or involve the employment of laborers and mechanics and require subcontractors to include these provisions in any such lower-tier subcontracts. The Contractor shall be responsible for compliance by any subcontractor or lower-tier subcontractor with the provisions set forth in paragraphs (a) through (d) of this clause.

15. F.O.B: Unless stated otherwise, the price for goods is F.O.B. the place of destination, and the place of destination is the County's designated campus address.

16. GOVERNING LAW: In any action, suit or legal dispute arising from this Agreement, the Contractor agrees that the laws of the State of New Mexico shall govern and that venue will lie in the Seventh Judicial District Court in Sierra County. By execution of this Agreement, Contractor acknowledges and agrees to the jurisdiction of the courts of the State of New Mexico over any and all lawsuits arising under or out of any term of this Agreement.

17. INDEMNIFICATION AND INSURANCE: Contractor assumes the entire responsibility and liability for losses, expenses, damages, demands and claims in connection with or arising out of any actual or alleged personal injury (including death) and/or damage or destruction to property sustained or alleged to have been sustained in connection with or arising out of the goods delivered by Contractor or the performance of the work by Contractor its agents, employees, sub-contractors or consultants, except to the extent of liability arising out of the negligent performance of the work by or willful misconduct of the County. Contractor shall indemnify, defend and hold harmless the County, its officers, agents, and employees from any and all liability for such losses, expenses, damages, demands, and claims and shall defend any suit or action brought against any or all of them based on any actual or alleged personal injury or damages and shall pay any damage costs and expenses including attorneys' fees, in connection with or resulting from such suit or action. Contractor will also indemnify, defend and hold harmless the County against any joint and several liabilities imposed against the County with respect to strict products liability claims attributable to the fault of the Contractor.

Contractor agrees that it and its sub-contractors will maintain general liability, product liability and property damage insurance in reasonable amounts (at least equal to the New Mexico Tort Claims Act limits) covering the above obligation and will maintain workers' compensation coverage covering all employees performing under a resultant Purchase Order/Agreement on premises occupied by or under the control of the County. The liability of the County will be subject is all cases to the immunities and limitations of the New Mexico Tort Claims Act, Sections 41-4-1 et seq. NMSA 1978, as amended."

18. INDEPENDENT BUSINESS: Neither Contractor nor any of its agents shall be treated as an employee of the County for any purpose whatsoever. Contractor declares that Contractor is engaged in an independent business and has complied with all federal, state and local laws regarding business permits and licenses of any kind that may be required to carry out the said business and the tasks to be performed under any resultant Purchase Order/Agreement. Contractor further declares that it is engaged in the same or similar activities for other clients and that the County is not Contractor's sole or only client or customer.

19. INSPECTION: The County may inspect, at any reasonable time, any part of Contractor's plant or place of business, which is related to performance of any resultant Purchase Order/Agreement. Final Inspection will be made at the destination upon completion of delivery of goods and services. Acceptance of delivery shall not be considered acceptance of the goods and/or services furnished. Final inspection shall include any testing or Inspection procedures required by the Specifications.

20. INSTRUMENTALITIES: Contractor shall supply all equipment, tools, materials and supplies required for the performance of the designated tasks or requirements set forth in any resultant Purchase Order/Agreement or its attachments.

21. INVALID TERM OR CONDITION: If any term or condition of this Agreement shall be held invalid or unenforceable, the remainder of this Agreement shall not be affected and shall be valid and enforceable.

22. MERGER: The contract shall incorporate all the agreements, covenants, and understandings between the parties thereto concerning the subject matter thereof. No prior agreements or understandings, verbal or otherwise, of the parties or their agents shall be valid or enforceable unless embodied in the contract.

23. STATE OF NEW MEXICO MINIMUM WAGE RATES AND PAYROLL SUBMITTALS (State and County Funded Projects): Jobs with an estimate cost >\$60,000 done under this RFP will be subject to the Public Works Minimum Wage Act (13-4-11 through 13-4-17, NMSA, 1978 as amended) and per exhibit labeled "Wage Act." Minimum wages will be supplied at time of award or may be obtained from the State of New Mexico Labor & Industrial Commission, 1596 Pacheco Street, Santa FE, NM 87501.

For all federally funded construction projects greater than \$2,000 the contractor and all subcontractors and their tiers shall deliver or mail legible copies of the certified weekly payrolls for all costs/services invoiced for the project awarded resulting from this RFP to the appropriate oversight agency and the County's Chief Procurement Officer or designated representative in accordance with 29 CFR 3.4. The Contractor shall certify that all payrolls submitted meet or exceed the applicable wage determination as shown in this RFP. See Federal Flow-Down Terms and Conditions and Certification Requirements

Contractor shall be responsible for the collection and submittal of all certified payrolls and shall retain a copy of all payrolls for a period of 3 years from the completion of the project. A copy of all certified payrolls shall be sent weekly to the County's Chief Procurement Officer or designated representative. The Contractor shall be responsible for labeling each submittal with the project name; payroll period; and contractor and/or subcontractor name; each employee's full name and social security number, address and zip code, birth date, sex and occupation, time and day of when employees work week begins, hours worked each day, total hours worked each workweek, basis on which employees wages are paid, regular hourly pay rate, total daily or weekly straight-time earnings, total overtime earnings for the workweek, all additions to or deductions from the employee's wages, date of payment and the pay period covered by the payment the County'

24. OTHER APPLICABLE LAWS: Any provision required to be included in a resultant Purchase Order/Agreement by any applicable and valid executive order, federal, state or local law, ordinance, rule or regulation shall be deemed to be incorporated herein.

25. OWNERSHIP: Ownership of Documents - All documents which are prepared by the Contractor or any member of the consulting team that form a part of its services under a resultant Purchase Order//Agreement are the sole property of the County and such works may not be reproduced nor distributed without the express written consent of the County and shall be delivered to the County upon termination and or completion of this Purchase Order/Agreement if the County so requests. The Contractor shall be responsible for the protection and/or replacement of any original documents in its possession. The County shall receive all original drawings and the Contractor shall retain a reproducible copy.

a. *Work Made for Hire* - For the consideration payable under a resultant Purchase Order/Agreement, the work product required by the Purchase Order/Agreement shall be considered a work made for hire within the meaning of that term under the copyright laws of the United States, applicable common law and corresponding laws of other countries. The County shall have the sole right and authority to seek statutory copyright protection and to enjoy the benefits of ownership of the work. The party performing the work hereby assigns all rights, title and interest in and to the work to the County and shall require all members of the consulting team to agree in writing that they assign all right, title and interest in work product required by the Purchase Order/Agreement to the County.

b. *Inventions*. For the consideration payable under a resultant Purchase Order/Agreement, the Contractor agrees to report any invention arising out of the Work required by the Purchase Order/Agreement with the County. The County shall have sole right and authority to seek statutory patent protection under United States and foreign patent laws and to enjoy the benefits of ownership of the invention, whether or not the invention was required of the Contractor or member of the consulting team as part of the performance of Work. The Contractor hereby assigns all right, title and interest in and to inventions made in the course of

the Work to the County and agrees to execute and deliver all documents and do any and all things necessary and proper to effect such assignment. Contractor shall require all members of the Consulting Team to agree in writing that they will execute and deliver all documents and do any and all things necessary and proper to effect assignment of inventions arising out of the Work required by the Purchase Order/Agreement with the County.

c. *Survival of Provision.* This provision shall survive expiration and termination of the Purchase Order/Agreement.

26. PATENT AND COPYRIGHT INDEMNITY: Contractor shall indemnify, defend and hold harmless the County against all losses, liabilities, lawsuits, claims, expenses (including attorneys' fees), costs, and judgments incurred through third party claims of infringement of any copyright, patent, trademark or other intellectual property rights.

27. PAYMENT TERMS: Upon written request from Contractor for payment, the County shall, within 30 days, issue a written certification of complete or partial acceptance or rejection, with payment to follow within 30 days after certificate of acceptance.

28. PAYROLL OR EMPLOYMENT TAXES: No federal, state, or local income, payroll or employment taxes of any kind shall be withheld or paid by the County with respect to payments to Contractor or on behalf of Contractor its agents or employees. Contractor shall withhold and pay any such taxes on behalf of its employees as required by law. The payroll or employment taxes that are the subject to this paragraph include but are not limited to FICA, FUTA, federal personal income tax, state personal income tax, state disability insurance tax, and state unemployment insurance tax. If Contractor is not a corporation, Contractor further understands that Contractor may be liable for self-employment (Social Security) tax, to be paid by Contractor according to law.

29. PENALTIES: The Procurement Code, Section 13-1-28 at seq. NMSA 1978, as amended imposes civil and criminal penalties for its violation. In addition, the New Mexico criminal statutes impose criminal penalties for bribes, gratuities and kickbacks.

30. PUBLIC WORKS PERFORMANCE AND PAYMENT BONDS: A performance bond and a payment bond, covering materials and labor, each in the amount of 100% of the contract cost may be required. The bond must be executed by the bidder with a surety company authorized to do business in New Mexico or other sureties approved by the State Board of Finance. The performance and payment bonds must be received by the Buyer issuing the award within five (5) days of the award and must reference this RFP Number on the face of the documents. All performance and payment bonds must meet the requirements of 13-4-18 NMSA, 1978, as amended

31. PURCHASE ORDER/AGREEMENT: Any resultant Purchase Order/Agreement shall be the sole and entire Purchase Order/Agreement between the parties; any documents

incorporated into the Purchase Order/Agreement are listed explicitly on the front side of the Purchase Order/Agreement, or are incorporated by implication by the terms of any resultant Purchase Order/Agreement. Any terms inconsistent with or in addition to any resultant Purchase Order/Agreement proposed by Contractor are deemed rejected unless agreed to in writing by an appropriate County official.

32. RELEASE THE COUNTY COMMISSIONERS: The Contractor shall, upon final payment of the amount due under the contract, release the County Commissioners of the Sierra County, their officers and employees and the State of New Mexico from liabilities, claims and obligations whatsoever arising from the contract. The Contractor agrees not to purport to bind the Sierra County of New Mexico or the State of New Mexico to any obligation not assumed in the contract by the County Commissioners of Sierra County of New Mexico or the State of New Mexico unless the Contractor has express, written authority to do so, and then only within the strict limits of that authority.

33. RETENTION OF RECORDS: Contractor will maintain detailed records indicating the date, time and nature of services provided under any resultant Agreement for a period of at least five years after termination of the Agreement, and will allow access for inspection by the County of New Mexico, the Secretary for Health and Human Services, the Comptroller General and the Inspector General to such records for the purpose of verifying costs associated with provisions of services under the Agreement. The Contractor shall provide all materials and labor necessary to comply with the rules, regulations and ordinances

34. STATUS OF CONTRACTOR: Subcontractor or Sub-Subcontractors: Work performed in the performance of any resultant Agreement by the Contractor, Subcontractor or Sub-Subcontractors and its agents and employees are independent performing services for the County and are not employees of the County of Sierra. The Contractor, Subcontractor or Sub-Subcontractors and its agents and employees shall not accrue leave, retirement, insurance, bonding, use of county vehicles, or any other benefits afforded to employees of the County of Sierra as a result of this Agreement. The Contractor, Subcontractor or Sub-Subcontractors acknowledges that all sums received hereunder are reportable by the Contractor, Subcontractor or Sub-Subcontractors for tax purposes, including without limitation, self-employment and business income tax. The Contractor, Subcontractor or Sub-Subcontractors agrees not to purport to bind the County of Sierra unless the Contractor, Subcontractor or Sub-Subcontractors has express written authority to do so, and then only within the strict limits of that authority.

35. SUBCONTRACTING: The Contractor shall not subcontract any portion of the delivery of goods or services to be performed under this Agreement without the prior written approval

of the County. Subcontractors listed in an approved task order constitute approval of the County. No such subcontract shall relieve the Contractor from its obligations and liabilities under this Agreement, nor shall any subcontract obligate direct payment from the County. In all cases, the Contractor is solely responsible for fulfillment of this Agreement.

36. TERM: This Agreement is for one (1) year from the date of approval by the Sierra County Board of County Commissioners. This Contract will automatically renew on an annual basis, for up to three (3) additional one (1) year terms unless terminated pursuant to Article 37 (Termination for Convenience), Article 38 (Termination for Cause), or Article 2 (Appropriations). In accordance with Section 13-1-150 NMSA 1978, no term for a professional services contract, including extensions and renewals, shall exceed four years, except as set forth in Section 13-1-150 NMSA 1978.

37. TERMINATION FOR CONVENIENCE:

A. Termination. This Agreement may be terminated by either of the parties hereto upon written notice delivered to the other party at least thirty (30) days prior to the intended date of termination. Except as otherwise allowed or provided under this Agreement, the County's sole liability upon such termination shall be to pay for acceptable work ordered and performed prior to the Contractor's receipt of the notice of termination, if the County is the terminating party, or the Contractor's sending of the notice of termination, if the Contractor is the terminating party; provided, however, that a notice of termination shall not nullify or otherwise affect either party's liability for pre-termination defaults under or breaches of this Agreement. The Contractor shall submit an invoice for such work within thirty (30) days of receiving or sending the notice of termination. Notwithstanding the foregoing, this Agreement may be terminated immediately upon written notice to the Contractor if the Contractor becomes unable to perform the services contracted for, as determined by the County or if, during the term of this Agreement, the Contractor or any of its officers, employees or agents is indicted for fraud, embezzlement or other crime due to misuse of government funds or due to the Appropriations paragraph herein.

THIS PROVISION IS NOT EXCLUSIVE AND DOES NOT WAIVE THE COUNTY'S OTHER LEGAL RIGHTS AND REMEDIES CAUSED BY THE CONTRACTOR'S DEFAULT/BREACH OF THIS AGREEMENT.

B. Termination Management. Immediately upon receipt by either the County or the Contractor of notice of termination of this Agreement, the Contractor shall: 1) not incur any further obligations for salaries, services or any other expenditure of funds under this Agreement without written approval of the County; 2) comply with all directives issued by the County in the notice of termination as to the performance of work under this Agreement; and 3) take such action as the County shall direct for the protection, preservation, retention or transfer of all property titled to the County and records

generated under this Agreement. Any non-expendable personal property or equipment provided to or purchased by the Contractor with contract funds shall become property of the County upon termination and shall be submitted to the County as soon as practicable.

38. TERMINATION FOR CAUSE:

A. County may by written notice terminate this Agreement in whole or in part for Contractor's default if the Contractor fails to comply with the provisions of this Agreement or fails to make progress so as to endanger performance and does not cure such failure within a reasonable period of time. In such event, County may otherwise secure the materials, supplies or services ordered, and Contractor shall be liable for damages suffered by County thereby, including incidental and consequential damages. If after notice of termination, County determines Contractor was not in default, or if Contractor's default is due to failure of County, termination shall be deemed for the convenience of County. The rights and remedies of County provided in this paragraph shall not be exclusive and are in addition to any other rights and remedies provided by law or under this Agreement as used in this paragraph, the word "Contractor" includes Contractor's sub-suppliers at any tier.

THIS PROVISION IS NOT EXCLUSIVE AND DOES NOT WAIVE THE COUNTY'S OTHER LEGAL RIGHTS AND REMEDIES CAUSED BY THE CONTRACTOR'S DEFAULT/BREACH OF THIS AGREEMENT.

B. In the event a termination for cause notice is issued by the County, the Contractor shall: 1) not incur any further obligations for salaries, services or any other expenditure of funds under this Agreement without written approval of the County; 2) comply with all directives issued by the County in the notice of termination as to the performance of work under this Agreement; and 3) take such action as the County shall direct for the protection, preservation, retention or transfer of all property titled to the County and records generated under this Agreement. Any non-expendable personal property or equipment provided to or purchased by the Contractor with contract funds shall become property of the County upon termination and shall be submitted to the County as soon as practicable.

39. TITLE AND DELIVERY: Title to the materials and supplies passed hereunder shall pass to the County upon acceptance at the FOB point specified, subject to the right of the County to reject. For any exception to the delivery date specified, Contractor shall give prior notification and obtain approval thereto from the County's Purchasing Department. Time is of the essence and the Purchase Order/Agreement is subject to termination for failure to deliver on time.

40. WAIVER: The Contract shall contain a provision that states that no waiver of any breach of the Contract or any terms or conditions thereof shall be held to be a waiver of any other

or subsequent breach; nor shall any waiver be valid, alleged or binding unless the same shall be in writing and signed by the party to have granted the waiver.

41. **WARRANTIES:** Contractor warrants the goods and/or services furnished to be exactly as specified in any resultant Purchase Order/Agreement, free from defects in Contractor's design, labor, materials and manufacture, and to be in compliance with any drawings or specifications incorporated herein and with any samples furnished by Contractor. All applicable UCC warranties express and implied are incorporated herein.
42. **WORKERS COMPENSATION:** No workers compensation insurance has been or will be obtained by THE COUNTY on account of Contractor or its employees or agents. Contractor shall comply with the workers compensation laws with respect to Contractor and Contractor's employees and agents.
43. **WORKMANSHIP/COOPERATION:** All work shall be done in a neat, workman-like manner using acceptable equipment and methods consistent with that level of care and skill ordinarily exercised by members of the profession/trade and in accordance with sound professional/trade standards and ethical practice. The Contractor will cooperate with the County and other contractors and coordinate their work involving other contractors through the County's authorized representative.

I. INTRODUCTION

A. PURPOSE OF THIS REQUEST FOR PROPOSALS

During the monsoon seasons Sierra County was hit with catastrophic flood events that caused comprehensive infrastructure damage throughout the County. The County's pre-existing levees were damaged and destroyed. The floods have placed Cuchillo Negro Arroyo as a high risk area and the Board of County Commissioners determined that there was a risk and threat to public health, welfare, safety and property and appealed to FEMA and the State of New Mexico for emergency relief funds to remedy the situation and was successful in obtaining such funds.

Sierra County now seeks to hire a contractor for Flood Control Construction to perform flood control improvement, repair and remediation construction services for Cuchillo Negro Arroyo Bank Stabilization, location: Northeast River Bank of Cuchillo Negro Arroyo, located on the Northeast side of NM-51 approximately MP-1 in Truth or Consequences, NM.

The County has procured Pettigrew & Associates for engineering services and they have established a Technical Project Plan. The awarded contractor for this project, will work closely with Pettigrew, through the duration and completion of the development.

NOTE: See **EXHIBIT H1**- for project descriptive-(**All questions shall be directed to the Chief Procurement Officer**) - Engineering plans may be obtained directly from Pettigrew & Associates, through:

Dañid Roybal, P.E. Engineer Manager- DRoybal@pettigrew.us
Or Teo Cano- TCano@pettigrew.us
Contact Number: 575-393-9872

It is anticipated that funding for such improvement, repair and remediation work will be funded by a number of oversight agencies including, but not necessarily limited to, FEMA, the State of New Mexico and Sierra County. Construction Project awarded as a result of this RFP will primarily include repairs and construction to County that have been identified by FEMA and Sierra County and Pettigrew as needing emergency repairs.

Selection of the Contractor shall be based on qualifications, experience and record of performance repairing damaged infrastructure as described above. The form of agreement shall be as identified in Appendix F.

Relationship of County ("Owner") and the successful Contractor - The successful Contractor accept a relationship of trust and confidence between itself and Sierra County. The Contractor shall agree to furnish his/her/its' best skill and best judgment and to cooperate with County, FEMA, any and all regulatory agencies, and any design professionals associated with the

oversight and funding of each project to be awarded as a result of this Request For Proposal solicitation. The successful Contractor shall furnish efficient Contractor reviews, business administration, field supervision and shall use his/her/its' best efforts to perform the work in the best and most expeditious, economical manner consistent with the interests of the County, and in strict conformity with FEMA funding requirements, State, Federal and local rules, laws and regulations.

This RFP contains specific requests for information. In responding to this RFP, Offerors are encouraged to provide additional information if Offeror believes that information is to be relevant.

B. SUMMARY SCOPE OF WORK

The duties and responsibilities of the successful contractors include, but may not be limited to performing the following services:

The work consists of construction services, based on an emergency and planned basis for the Sierra County Flood Commission or at the direction of Sierra County.

The assignment will include a written or oral scope of work and anticipate time frame for completion. The work will have engineered drawings. The project will consist of sheet pilings in four major sections of the bank. All work will be paid base on the Contractor's fixed price quote. All possible occurrences should be taken into consideration when providing the cost for services.

Generally, the work is earthwork in hazardous flood prone area of flowing or dry streambeds and in the Cuchillo Negro Arroyo and may include the construction/reconstruction of banks, levies, stream channels, placement of rip-rap, opening/reconstruction of driveways and roads, and other work under the guidance and direction of the Sierra County Flood Commission or Sierra County. The work is project specific and only a qualified contractor will be awarded for this task.

Environmental

No permits required, any permitting has been addressed with Pettigrew & Associates. Working directly from the creek bed and above- placing sheet metal-see: **EXHIBIT H1 AND H2**

Transportation

The Contractor's bid shall include any and all delivery costs for equipment delivered to the awarded project. Includes any and all heavy machinery and supplies.

Wage Rates

The following wage rates apply for projects awarded resulting from this RFP. Labor Rates to be paid to all laborers shall include the wage and fringe benefits of the applicable wage rate decisions. **(SEE EXHIBIT F- WAGE RATES)** *New Mexico Local Public Works Exhibit F* (Projects equal to or greater than \$60,000) are subject to the requirements of 13-4-13.1

Equipment

It is anticipated that not all equipment quoted will be new current year models. All equipment shall be in good operating condition, with all safety devices intact and fully functional. For full excavations and blading.

Note: the Flood Commission or Sierra County reserves the right to suspend or terminate any work being performed by any machine that in his/her opinion is not adequately maintained or operated. Cost of removal and replacement of such equipment shall be at the sole expense of the contractor.

Personnel

Contractor shall employ only competent, trained professional heavy equipment operators capable of working in a safe manner. Contractor shall be responsible for adequate supervision and communicate the work directly to his respective employees. The Flood Commission- Director will not directly supervise the contractor's employees. The Flood Commission- Director at his sole discretion may order the contractor to remove any employee, that the Flood Commission- Director deems un-safe or generally unable to complete the desired work at a reasonable time frame.

Work Areas

Much of the work performed by the Sierra County Flood Commission- Director is performed on private lands. All available efforts will be made to protect damage to private property during ingress and egress of equipment to work areas. The contractor shall not do any work outside the authorized limits of construction ordered by the Flood Commissioner. Any trespass or damage to property done by the contractor outside the limits of construction shall be immediately addressed and or repaired by the contractor at the contractor's expense.

Funding and Invoicing

Funding may be from Federal, State or Sierra County, or other funding sources. Contractor shall keep accurate records of all work performed and hours worked for each individual machine and location. All statements shall reflect the work order number for tracking. Contractor records shall be available for review by the Flood Commission- Director daily.

Insurance General Liability

The contractor shall maintain a General Liability insurance policy in the amount of \$1,000,000.00 per occurrence naming the Sierra County Flood Commission and Sierra County as an additional insured.

Workers Compensation

The contractor shall maintain Workers Compensation insurance for all employees.

Surety Bonds

Note, a 100 percent, Performance and Labor and Materials Payment Bonds shall be required for each construction project in excess of \$25,000.

Photographs

The contractor will take before, daily progress, and after digital photographs of the work assigned. The photographs will be identified by date, location, and a description of the work. Photographs will be provided to the contract administrator on a weekly basis.

C. CHIEF PROCUREMENT OFFICER

The County has designated a Chief Procurement Officer who is responsible for this procurement and whose name, address, and telephone number are listed below. Any inquiries or requests regarding this procurement should be submitted to the Chief Procurement Officer (“CPO”) in writing. Offerors may contact ONLY the CPO regarding the procurement. Other County employees do not have the authority to respond on behalf of the County of Sierra.

**Chief Procurement Officer
Jocelyn Holguin
Sierra County Purchasing**

<u>Delivery Address (Including proposal delivery):</u> 855 Van Patten/ Truth or Consequences, NM 87901	<u>Mailing Address:</u> Same
---	---------------------------------

Phone: (575) 894-6215
Fax: (575) 894-9548
E-mail: jholguin@sierraco.org

NOTE: All deliveries via express carrier (INCLUDING PROPOSAL DELIVERY) should be addressed to Jocelyn Holguin’s Delivery Address, above:

D. DEFINITION OF TERMINOLOGY

This section contains definitions that are used throughout this procurement document, including appropriate abbreviations.

"Board of County Commissioners" (also "BCC") means the elected board in whom all powers of the municipality are vested and who are responsible for the proper and efficient administration of the municipal government.

"Chief Procurement Officer" (also "CPO") means the person or designee authorized by the County to manage or administer a procurement requiring the evaluation of competitive sealed proposals.

"Close of Business" means 5:00 P.M. Mountain Standard Time (MST) or Mountain Daylight Time (MDT), whichever is in effect on the date specified.

"Contract" or "Agreement" means a written agreement for the procurement of items of tangible personal property or services.

"Contractor" means a successful Offeror who enters into a binding contract.

"County" means the County of Sierra, State of New Mexico.

"Determination" means the written documentation of a decision of the Chief Procurement Officer including findings of fact required to support a decision. A determination becomes part of the procurement file to which it pertains.

"Desirable" refers to the terms "may", "can", "should", "preferably" or "prefers" which identify a desirable or discretionary item or factor (as opposed to a "mandatory" item or factor).

"Evaluation Committee" means a body appointed by County management to perform the evaluation of Offeror proposals.

"Evaluation Committee Report" means a report prepared by the Chief Procurement Officer and the Evaluation Committee for submission to appropriate approval authorities for contract award that contains all written determinations resulting from the conduct of a procurement requiring the evaluation of competitive sealed proposals.

"Finalist" is defined as an Offeror who meets all the mandatory specifications of this Request for Proposal and whose score on evaluation factors is sufficiently high to merit further consideration by the Evaluation Committee.

"Mandatory" refers to the terms "must", "shall", "will", "is required" or "are required" which identify a mandatory item or factor (as opposed to a "desirable" item or factor). Failure to meet a mandatory item or factor will result in the rejection of the Offeror's proposal.

"Offeror" is any person, corporation, or partnership who chooses to submit a proposal.

"Page" means one (1) side of an 8 ½ X 11 inch sheet of paper. One (1) 8 ½ X 11 inch sheet of paper printed on both sides constitutes two (2) pages. (See, however, Section III.C for the one exception to the 8 ½ X 11 inch page size limitation.)

"Procuring agency of the County" means the department or other subdivision of the County of Sierra that is requesting the procurement of services or items of tangible personal property.

"Purchase Order" or "PO" means the document which directs a contractor to deliver items of tangible personal property or services pursuant to an existing, valid contract.

"Purchasing" means the County of Sierra Purchasing Office or the Sierra County Chief Procurement Officer.

"Purchasing Agent" or "PA" means the Chief Procurement Officer for the County of Sierra.

"Request for Proposals" or "RFP" means all documents, including those attached or incorporated by reference, used for soliciting proposals.

"Responsible Offeror" means an Offeror who submits a responsive proposal and who has furnished required information and data to prove that their financial resources, production or service facilities, personnel, service reputation and experience are adequate to make satisfactory delivery of the services or items of tangible personal property called for in this proposal.

"Responsive Offer" or "Responsive Proposal" means an offer or proposal which conforms in all material respects to the requirements set forth in the request for proposals. Material respects of a request for proposals include, but are not limited to, price, quality, quantity and delivery requirements.

"Statement of Compliance" and "Statement of Concurrence" mean an express, affirmative statement by the Offeror in their proposal, that they agree with or agree to the stated requirement(s). Possible examples of acceptable responses include; *"The [NAME HERE] Company agrees to comply with this requirement."*, *"The [NAME HERE] Company concurs with this requirement."* and *The [NAME HERE] Company agrees to participate as required."*

E. PROCUREMENT LIBRARY

The Procurement Library consists of the following documents which may be accessed by their associated Internet links:

Sierra county Purchasing department Website

[http://www.sierraco.org- Vendor Registry](http://www.sierraco.org-Vendor Registry)

New Mexico Procurement Code

<http://www.conwaygreene.com/nmsu/lpext.dll?f=templates&fn=main-h.htm&2.0>

II. CONDITIONS GOVERNING THE PROCUREMENT

This section of the RFP contains the schedule for the procurement, describes the major procurement events and contains the general requirements governing the procurement.

A. SEQUENCE OF EVENTS

The Chief Procurement Officer will make every effort to adhere to the following schedule:

ACTION	RESPONSIBILITY	DATE
1. Issue RFP	Chief Procurement Officer (CPO)	December 20, 2019
2. Return of "Acknowledgment of Receipt" Form for Distribution List	Potential Offerors (PO)	January 24, 2020
3. Mandatory Pre-Proposal Conference	CPO, PO and VC Staff	January 07, 2020
4. Deadline to Submit Questions	PO	January 16, 2020
5. Response to Written Questions/ RFP Amendments	CPO	To Be Determined
6. Submission of Proposal	Offerors	January 30, 2020
7. Proposal Evaluation	Evaluation Committee (EC)	To Be Determined
8. Notification of Finalists (If desired)	CPO	To Be Determined
9. Best & Final Offer (If requested)	Offerors	To Be Determined
10. Oral Presentations (If requested)	Offerors	To Be Determined
11. Contract Negotiations (If needed)	Tentative winner/County	To Be Determined
12. Contract Award*	Chief Procurement Officer/BCC*	February 18, 2020
13. Protest Deadline	Offerors	15 Days of Notice of Award
Start of Performance	CPO	TBD

*Contract award is subject to approval of the Board of County Commissioners.

B. EXPLANATION OF EVENTS

The following paragraphs further detail the activities listed in the sequence of events shown in Section II, Paragraph A.

1. Issue RFP

This RFP is being issued by the County Chief Procurement Officer on behalf of Sierra County Flood Commission-Director.

2. Return of “Acknowledgment of Receipt” Form for Distribution List

Potential Offerors should hand deliver or return by facsimile or e-mail or registered or certified mail the “Acknowledgment of Receipt” form that accompanies this document (See Appendix A) to have their organization placed on the procurement distribution list. The form should be signed by an authorized representative of the organization, dated and returned to the attention of Jocelyn Holguin, Chief Procurement Officer, by the close of business on the date indicated in Section II.A (Sequence of Events), above.

The procurement distribution list will be used to notify those that submitted the form of any written responses to questions and any RFP amendments. Failure to return this form shall constitute a presumption of receipt and rejection of the RFP, and the potential Offeror's organization name shall not appear on the distribution list.

3. Site Visit and Mandatory Pre-Proposal Conference – January 7, 2020 @ 11:00 AM

4. Deadline to submit written questions

Potential Offerors may submit written questions as to the intent or clarity of this RFP until 2:00 PM MST on the date indicated in Section II.A (Sequence of Events), above. All written questions must be sent by e-mail to the Chief Procurement Officer (See Section I, Paragraph C.)

5. Response to written questions/RFP Amendments

Written responses to written questions and any RFP amendments will be posted to the County Purchasing Office web site link: <http://www.sierraco.org-Vendor Registry> Notification of such posting shall be provided to all potential Offerors that have returned the “Acknowledgment of Receipt” Form found at Appendix A. The “Acknowledgment of Receipt” Form will accompany the posted distribution package. The form should be signed by the Offeror's representative, dated, and hand-delivered or returned by facsimile or e-mail or by registered or certified mail by the date indicated thereon. Failure to return this form shall constitute a presumption of receipt and withdrawal from the procurement

process. The Chief Procurement Officer will determine if an offeror is accepted should the form be completed and part of the packet.

6. Submission of Proposal

OFFEROR PROPOSALS MUST BE RECEIVED FOR REVIEW AND EVALUATION BY THE CHIEF PROCUREMENT OFFICER OR DESIGNEE NO LATER THAN 2:00 PM MST ON THE DATE INDICATED IN SECTION II. PARAGRAPH A (SEQUENCE OF EVENTS), ABOVE. **PROPOSALS RECEIVED AFTER THIS DEADLINE FOR ANY REASON WILL NOT BE ACCEPTED OR CONSIDERED.**

The date and time of receipt will be recorded on each proposal. Proposals must be addressed and delivered to the Chief Procurement Officer at the delivery address listed in Section I, Paragraph C. Proposals must be sealed and labeled on the outside of the package to clearly indicate that they are in response to the “Sierra County Construction Services-Cuchillo Negro Arroyo Bank Stabilization” Request For Proposals and should reference “RFP #2019-05-009”. Proposals submitted by facsimile or other electronic means **WILL NOT BE ACCEPTED.**

A public log will be kept of the names of all Offerors submitting proposals. Pursuant to Section 13-1-116 NMSA 1978, the contents of any proposal shall not be disclosed to competing Offerors prior to contract award.

7. Proposal Evaluation

The evaluation of proposals will be performed by an Evaluation Committee appointed by County management. The Chief Procurement Officer may at her option initiate discussions with Offerors who submit responsive or potentially responsive proposals for the purpose of clarifying aspects of the proposals; please note proposals may be accepted and evaluated without such discussion. **Discussions SHALL NOT be initiated by the Offerors.**

8. Notification of Finalists

The Evaluation Committee may select finalists to be invited to participate in the subsequent steps of the procurement. The Evaluation Committee reserves the right not to utilize the finalist process if they deem it in the best interest of the County.

9. Best and Final Offers

Finalists may be asked to submit revisions to their proposals for the purpose of obtaining best and final offers on the date indicated in Section II.A (Sequence of Events), above.

10. Oral Presentations

Finalists may be required to attend and participate in an oral presentation (date(s) to be determined). Only by request. Potential offerors will be contacted directly by the Chief Procurement Officer.

11. Contract Negotiations

If necessary, contract negotiations shall commence with the most advantageous Offeror(s) no later than the date indicated in Section II.A (Sequence of Events), above. In the event that mutually agreeable terms cannot be reached, the County reserves the right to begin negotiations with the next most advantageous Offeror(s) without undertaking a new procurement process.

12. Contract Award

Any contract awarded shall be awarded to the Offeror(s) whose proposal is most advantageous to the County, taking into consideration the evaluation factors set forth in this RFP. Such awards shall be subject to the prior review and approval of the County Commissioners.

13. Multiple Award

Sierra County reserves the right to issue multiple awards. The firms with the highest overall ranking in each Category from the shortlist after interviews, if applicable, will be recommended for award.

The selected firms will be submitted to the County Commission for approval of award for the applicable categories of work. The County will then enter into construction contract consistent with AIA Document A201 – 2007 and Supplementary Conditions (Appendix F) with each of the awarded firms for the applicable categories of work.

14. Protest Deadline

Any protest by an Offeror must be timely, in conformance with, and will be governed by Sections 13-1-172 through 13-1-176 NMSA 1978 and Sierra County Procurement Policy. The fifteen (15) day protest period for the submittal of a timely protest shall begin on the day following the contract award. Protests must be written and must include the name and address of the protestor and the Request for Proposals number. It must also contain a statement of grounds for protest including appropriate supporting exhibits, and it must

specify the ruling requested from the Chief Procurement Officer. The protest must be delivered to the Chief Procurement Officer:

*Sierra County Purchasing
Attn. Jocelyn Holguin, County Chief Procurement Officer
855 Van Patten
Truth or consequences, New Mexico 87901*

NOTE: Protests received after the deadline will not be accepted.

III. RESPONSE FORMAT AND ORGANIZATION

A. NUMBER OF RESPONSES

Offeror's may submit only one (1) response to this RFP.

B. NUMBER OF COPIES

Offerors shall deliver four (4) printed and one (1) electronic copies of their proposal to the location specified for the delivery and receipt of proposals on or before the closing date and time for receipt of proposals. *(Identical copies are defined as the original plus the number of additional copies needed to fulfill the requirement. For example, a requirement for five (5) identical copies would be fulfilled by submitting the original and four [4] copies of the original.)* The original copy should be clearly marked "ORIGINAL" on the front cover and shall contain original signatures

C. PROPOSAL FORMAT

The proposal must be limited in format and length. Format will be 8-1/2 inch x 11 inch, with fold-out sheets allowed up to 11 inch x 17 inch in size. All fold-out sheets, up to a maximum of 11 inch x 17 inch sheets, will be counted as two (2) pages and shall be labeled as such. Length of the proposal shall be limited *to a maximum number of twenty-five (25) pages* (printed sheet faces) of text and/or graphic material *in response to the evaluation criteria both non-weighted and weighted criteria*. Text shall be of font size no smaller than 10 point using font type Times New Roman or equivalent. Any questions regarding format requirements shall be directed to the Procurement Manager prior to submittal of documents.

Material excluded from the maximum number count of pages shall include and shall be limited to:

1. Front cover (blank on back side)
2. Acknowledgement of Receipt – Appendix A
3. Acknowledgement of Addenda – Appendix B
4. Conflict of Interest Certification Form – Appendix C
5. Federal Flow-Down Certification Requirements Form - Appendix D

6. Campaign Contribution Disclosure Form – Appendix E
7. Request for Cost From- Exhibit C
8. Table of Contents (one page maximum)
9. Divider pages (blank except for title information)
10. Back cover (blank on one side)

NOTE: Any sheets or pages included in the proposal response, but not specifically excluded, as noted above, shall be counted towards the maximum shown above.

D. PROPOSAL ORGANIZATION

All pages must be numbered except for those specifically excluded as noted above. All foldout pages shall be counted as two (2) pages and must be numbered as such. Proposals shall be organized in such a manner that mandatory and technical submittal requirements are clearly identified. Tabs delineating the various submittal requirements may be helpful.

Within each section of their proposal, Offerors should address the items in the order in which they appear in this RFP. Any forms provided in the RFP must be thoroughly completed and included in the appropriate section of the proposal. Any proposal that does not adhere to these requirements may be deemed non-responsive and rejected on that basis.

A proposal summary may be included by Offerors to provide the Evaluation Committee with an overview of the technical and business features of the proposal; however, this material will not be used in the evaluation process unless specifically referenced from other portions of the Offeror's proposal.

*Offerors may attach other material that they feel may improve the quality of their responses. However, these materials should be included as items in a separate appendix and will be counted towards the maximum allowance shown above.

III. EVALUATION CRITERIA

The Offerors' proposals will be evaluated and percentage will be given as shown below in the evaluation criteria.

The following is a summary of evaluation factors with point value assigned to each or a Pass/Fail evaluation. These, along with the requirements of this RFP, will be used in the evaluation of individual proposal submittals.

Mandatory Criteria

The mandatory requirements listed below requires a vendor response, as indicated. *Failure to respond to, or properly comply with, a mandatory requirement may result in the disqualification of the Offeror's proposal.* Note: failure to respond to a mandatory requirement will result in receiving a score of zero (0) for that requirement.

The following is a summary of evaluation factors with point value assigned to each or a Pass/Fail evaluation. These, along with the requirements of this RFP, will be used in the evaluation of individual proposal submittals.

A. License **(PASS/FAIL)**

State of New Mexico License – GF-4 Drainage or flood control systems or GF-98 Construct, Alter or repair fixed works facilities.

B. Prior Business Experience **(PASS/FAIL)**

Must have been in business performing similar and like services for a period of 5 years or more.

Evaluation Criteria

COUNTY shall utilize a scoring system based the established evaluation criteria. The following summarizes the criteria that will be considered and evaluated.

<u>Description</u>	<u>Maximum Percentage</u>
--------------------	---------------------------

C. Experience and Past Performance –

Maximum Points: 35

Evaluation and verification the Contractor's prior work history of jobs similar in nature to include:

Type of jobs and number of completed jobs within the past 5 years

Provide the size of the projects completed

Experience similar to the requirements of the SOW

Provide the project name(s), description, scope of work, original contract sum, final contract sum with explanation, and date of completion for each and every similar project undertaken by the firm

Length of time in business

D. Management and Technical Ability

Maximum Points: 25

Experience of staff (years of experience & experience on similar projects of the SOW)

Provide the name, title, including the detailed description of the role and job responsibilities, scope of work, education, construction experience, years with the firm for all management personnel who will have any direct or indirect responsibility over the project.

Management capability

Qualification of staff (certifications/license)

Past performance for jobs completed within the past 5 years

Company organization structure

E. Resources

Maximum Points: 20

Provide a description of owned equipment or available for use by the Contractor.

Provide employee certificates of training on proposed equipment.

F. Health/Safety/Insurance

Maximum Points: 10

Provide safety performance claims report over the past 5 years

Provide the three (3) year history of the Contractor's workers' compensation experience modifier.

Provide certificate of insurance at the insurance rates specified in the RFP.

G. Terminations

Maximum Points: 5

Provide a list of any projects on which the firm was the Contractor and was terminated, held in default, or failed to complete the work. Include the name of the project, the timeframe of the project and circumstances surrounding the termination or default.

H. Litigation and Claims

Maximum Points: 5

Provide information regarding each and every legal proceeding, administrative proceeding and arbitration pending against the Contractor in the past 5 years.

Total=

100 Points

BASIS OF AWARD: Contracts awarded as a result of this solicitation shall be awarded to the responsible Offeror(s) whose proposal represents the best value and is in the County's best interest. The evaluation committee will prepare a selection recommendation report for the Chief Procurement Officer or his/her designee recommending those firms that are considered to be the most highly qualified. All firms on the most highly qualified selection recommendation report are considered "selected firms" with which the Chief Procurement Officer or his/her designee may negotiate.

The final award decision shall be made by the Chief Procurement Officer or his/her designee. The selection authority will review the recommendations of the evaluation committee and shall, with the advice of appropriate technical and staff representatives, make the final selection. If the firm selected for award is not the recommended as the most highly qualified by the evaluation committee, the selection authority shall provide for the contract file a written explanation of the reason for the award preference. Such awards shall be subject to the prior review and approval of the County Commissioners. Such awards shall be subject to the prior review and approval of the County Commissioners.

APPENDIX A

**ACKNOWLEDGEMENT OF RECEIPT FORM
Request for Proposals**

**CUCHILLO NEGRO ARROYO BANK STABLIZATION
SIERRA COUNTY RFP #2019-05-009**

In acknowledgment of receipt of this Request for Proposal, the undersigned agrees that he/she has received a complete copy of the above referenced RFP including all Appendix and Exhibits.

The acknowledgment of receipt should be signed and returned (by fax, e-mail, and courier or hand delivery) to the Chief Procurement Officer no later than January 24, 2019.

The firm listed below does/does not (circle one) intend to respond to this Request for Proposals.

FIRM: _____

REPRESENTED BY: _____ TITLE: _____

E-MAIL ADDRESS: _____

PHONE NO.: _____ FAX NO.: _____

ADDRESS: _____

CITY: _____ STATE: _____ ZIP CODE: _____

SIGNATURE: _____ DATE: _____

This name and address will be used for all correspondence related to the Request for Proposals.

Please return to:
Jocelyn Holguin
Chief Procurement Officer
Sierra County
855 Van Patten
Truth or Consequences, NM 87901
Phone: (575) 894-6215
Fax: (575) 894-9548
E-mail: jholguin@sierraco.org

APPENDIX B

ACKNOWLEDGEMENT OF ADDENDA

**THE FOLLOWING OFFEROR INFORMATION MUST BE COMPLETED AND
RETURNED WITH THE RFP #2019-05-009**

ACKNOWLEDGMENT OF ADDENDA:

The undersigned acknowledges receipt of the following addenda:

Addenda No. ____ Dated _____ Addenda No. ____ Dated _____

Addenda No. ____ Dated _____ Addenda No. ____ Dated _____

The undersigned, as an authorized representative for the Company named below, acknowledges that the offeror has examined this RFP with its related documents and is familiar with all of the conditions surrounding the described materials, labor and/or services. Offeror hereby agrees to furnish all labor, materials and supplies necessary to comply with the specifications in accordance with the Terms and Conditions set forth in this RFP and at the prices stated within the RFP.

The undersigned further states that the company submitting this RFP is not in violation of any applicable Conflict of Interest laws or regulations or any other related clauses included in this RFP.

COMPANY NAME _____

ADDRESS _____

CITY/STATE/ZIP _____

TELEPHONE: _____ **FAX:** _____ **EMAIL:** _____

NEW MEXICO GROSS RECEIPTS TAX NO _____

FEDERAL EMPLOYER ID NUMBER (FEIN) _____

SIGNATURE OF AUTHORIZED REPRESENTATIVE _____

PRINTED OR TYPED NAME _____

TITLE _____

DATE: _____

APPENDIX C (MANDATORY)

**CONFLICT OF INTEREST-DEBARMENT/SUSPENSION CERTIFICATION FORM
SIERRA COUNTY CONFLICT OF INTEREST AND
DEBARMENT/SUSPENSION CERTIFICATION FORM
THE FOLLOWING MUST BE CERTIFIED IF ANY RESULTANT PURCHASE
ORDER/AGREEMENT IS \$20,000 OR GREATER
CONFLICT OF INTEREST; GOVERNMENTAL CONDUCT ACT.**

A. The Contractor represents and warrants that it presently has no interest and, during the term of this Agreement, shall not acquire any interest, direct or indirect, which would conflict in any manner or degree with the performance or services required under the Agreement.

B. The Contractor further represents and warrants that it has complied with, and, during the term of this Agreement, will continue to comply with, and that this Agreement complies with all applicable provisions of the Governmental Conduct Act, Chapter 10, Article 16 NMSA 1978. Without in anyway limiting the generality of the foregoing, the Contractor specifically represents and warrants that:

1) in accordance with Section 10-16-4.3 NMSA 1978, the Contractor does not employ, has not employed, and will not employ during the term of this Agreement any County employee while such employee was or is employed by the County and participating directly or indirectly in the County's contracting process;

2) this Agreement complies with Section 10-16-7(B) NMSA 1978 because (i) the Contractor is not a public officer or employee of the County; (ii) the Contractor is not a member of the family of a public officer or employee of the County; (iii) the Contractor is not a business in which a public officer or employee or the family of a public officer or employee has a substantial interest; or (iv) if the Contractor is a public officer or employee of the County, a member of the family of a public officer or employee of the County, or a business in which a public officer or employee of the County or the family of a public officer or employee of the County has a substantial interest, public notice was given as required by Section 10-16-7(B) NMSA 1978 and this Agreement was awarded pursuant to a competitive process;

3) in accordance with Section 10-16-8(C) NMSA 1978, (i) the Contractor is not, and has not been represented by, a person who has been a public officer or employee of the County within the preceding year and whose official act directly resulted in this Agreement and (ii) the Contractor is not, and has not been assisted in any way regarding this transaction by, a former public officer or employee of the County whose official act, while in County employment, directly resulted in the County's making this Agreement;

4) in accordance with Section 10-16-13 NMSA 1978, the Contractor has not directly participated in the preparation of specifications, qualifications or evaluation criteria for this Agreement or any procurement related to this Agreement; and

5) in accordance with Section 10-16-3 and Section 10-16-13.3 NMSA 1978, the Contractor has not contributed, and during the term of this Agreement shall not contribute, anything of value to a public officer or employee of the County.

C. Contractor's representations and warranties in Paragraphs A and B of this Article 13 are material representations of fact upon which the County relied when this Agreement was entered into by the parties. Contractor shall provide immediate written notice to the County if, at any time during the term of this Agreement, Contractor learns that Contractor's representations and warranties in Paragraphs A and B of this Article 13 were erroneous on the effective date of this Agreement or have become erroneous by reason of new or changed circumstances. If it is later determined that Contractor's representations and warranties in Paragraphs A and B of this Article 13 were erroneous on the effective date of this Agreement or have become erroneous by reason of new or changed circumstances, in addition to other remedies available to the County and notwithstanding anything in the Agreement to the contrary, the County may immediately terminate the Agreement.

D. All terms defined in the Governmental Conduct Act have the same meaning in this Article 13(B).

DEBARMENT/SUSPENSION STATUS

The Vendor certifies that it is not suspended, debarred or ineligible from entering into contracts with the Executive Branch of the Federal Government, or in receipt of a notice or proposed debarment from any Agency. The vendor agrees to provide immediate notice to the County Chief Procurement Officer in the event of being suspended, debarred or declared ineligible by any department or federal agency, or upon receipt of a notice of proposed debarment that is received after the submission of the quote or offer but prior to the award of the /Purchase Order/Agreement or contract.

CERTIFICATION

The undersigned hereby certifies that he/she has read the above CONFLICT OF INTEREST and DEBARMENT/SUSPENSION Status requirements and that he/she understands and will comply with these requirements. The undersigned further certifies that they have the authority to certify compliance for the vendor named **and that the information contained in this document is true and accurate to the best of their knowledge.**

Signature: _____ Title: _____ Date: _____

Name Typed: _____

Company Name: _____

Address _____ City/State/zip: _____

THE FOLLOWING MUST BE CERTIFIED IF ANY RESULTANT PURCHASE ORDER/AGREEMENT IS \$100,000 OR GREATER:

CERTIFICATION AND DISCLOSURE REGARDING PAYMENTS TO INFLUENCE CERTAIN FEDERAL TRANSACTIONS (September, 2005)

(a) In accordance with FAR 52.203-11, the definitions and prohibitions contained in the clause at FAR 52.203-12, Limitation on Payments to influence Certain Federal Transactions, included in this solicitation, are hereby incorporated by reference in paragraph (b) of this certification.

(b) The offeror, by signing its offer, hereby certifies to the best of his or her knowledge and belief that on or after; December 23, 1989

1) No Federal appropriated funds have been paid or will be paid to any person for influencing or attempting to influence an officer or employee of any agency, a Member of Congress, an officer or employee of Congress, or an employee of a Member of Congress on his or her behalf in connection with the awarding of any Federal contract.

2) If any funds other than Federal appropriated funds (including profit or fee received under a covered Federal Transaction) have been paid, or will be paid, to any person for influencing or attempting to influence an officer or employee of any agency, a Member of Congress, and officer or employee of Congress, or an employee of a Member of Congress on his or her behalf in connection with this solicitation, the offeror shall complete and submit, with its offer, OMB standard form LLL, Disclosure of Lobbying Activities, to the Contracting Officer; and

3) He or she will include the language of this certification in all subcontract awards at any tier and require that all recipients of subcontract awards in excess of \$100,000 shall certify and disclose accordingly.

(c) Submission of this certification and disclosure is a prerequisite for making or entering into this contract imposed by section 1352, title 31, United States Code. Any person who makes expenditure prohibited under this provision or who fails to file or amend the disclosure form to be filed or amended by this provision shall be subject to a civil penalty of not less than \$10,000 and not more than \$100,000 for each such failure.

CLEAN AIR ACT AND FEDERAL WATER POLLUTION CONTROL ACT

The undersigned company agrees to comply with all applicable standards, orders or regulations issued pursuant to the Clean Air Act (42 U.S.C. 7401 et seq.) and the Federal Water Pollution Control Act as amended (33 U.S.C. 1251 et seq.)

CERTIFICATION

The undersigned hereby certifies that he/she has read the above CERTIFICATION AND DISCLOSURE REGARDING PAYMENTS TO INFLUENCE CERTAIN FEDERAL TRANSACTION (APR 1991) and CLEAN AIR ACT AND FEDERAL WATER POLLUTION CONTROL ACT requirements and that he/she understands and will comply with these requirements. The undersigned further certifies that they have the authority to certify compliance for the vendor named below.

Signature: _____ Title: _____ Date: _____

Name Typed: _____

Company: _____

APPENDIX D (MANDATORY)

FEDERAL FLOW-DOWN CERTIFICATION REQUIREMENTS

1. 52.222-26 Equal Employment Opportunity. Representations required to implement provisions of Executive Order 11246 —

(1) Previous contracts and compliance. The offeror represents that—

(i) It _____ has, _____ has not participated in a previous contract or subcontract subject to the Equal Opportunity clause of this solicitation; and

(ii) It _____ has, _____ has not filed all required compliance reports.

(2) Affirmative Action Compliance. The offeror represents that—

(i) It _____ has developed and has on file, _____ has not developed and does not have on file, at each establishment, affirmative action programs required by rules and regulations of the Secretary of Labor (41 CFR parts 60-1 and 60-2), or

(ii) It _____ has not previously had contracts subject to the written affirmative action programs requirement of the rules and regulations of the Secretary of Labor. (CHECK THE APPLICABLE BOX)

2. 52.225-1 Buy American Act Certificate.

(1) The offeror certifies that each end product, except those listed in paragraph (2) of this provision, is a domestic end product and that for other than COTS items, the offeror has considered components of unknown origin to have been mined, produced, or manufactured outside the United States. The offeror shall list as foreign end products those end products manufactured in the United States that do not qualify as domestic end products, i.e., an end product that is not a COTS item and does not meet the component test in paragraph (2) of the definition of “domestic end product.” The terms “commercially available off-the-shelf (COTS) item,” “component,” “domestic end product,” “end product,” “foreign end product,” and “United States” are defined in the clause of this solicitation entitled “Buy American Act — Supplies.”

(2) Foreign End Products:

Line Item No.

Country of Origin

(List as Necessary)

3. 2.209-5 CERTIFICATION REGARDING RESPONSIBILITY MATTERS (APR 2010)

(a) (1) The Offeror certifies, to the best of its knowledge and belief, that-

(i) The Offeror and/or any of its Principals-

(A) Are _____ are not _____ presently debarred, suspended, proposed for debarment, or declared ineligible for the award of contracts by any Federal agency;

(B) Have _____ have not _____, within a three-year period preceding this offer, been convicted of or had a civil judgment rendered against them for: commission of fraud or a criminal offense in connection with obtaining, attempting to obtain, or performing a public (Federal, State, or local) contract or subcontract; violation of Federal or State antitrust statutes relating to the submission of offers; or commission of embezzlement, theft, forgery, bribery, falsification or destruction of records, making false statements, tax evasion, violating Federal criminal tax laws, or receiving stolen property (if offeror checks "have", the offeror shall also see 52.209-7, if included in this solicitation); and

(C) Are _____ are not _____ presently indicted for, or otherwise criminally or civilly charged by a governmental entity with, commission of any of the offenses enumerated in subdivision (a)(1)(i)(B) of this provision; and

(D) Have _____ have not _____, within a three-year period preceding this offer, been notified of any delinquent Federal taxes in an amount that exceeds \$3,000 for which the liability remains unsatisfied.

(1) Federal taxes are considered delinquent if both of the following criteria apply:

(i) The tax liability is finally determined. The liability is finally determined if it has been assessed. A liability is not finally determined if there is a pending administrative or judicial challenge. In the case of a judicial challenge to the liability, the liability is not finally determined until all judicial appeal rights have been exhausted.

(ii) The taxpayer is delinquent in making payment. A taxpayer is delinquent if the taxpayer has failed to pay the tax liability when full payment was due and required. A taxpayer is not delinquent in cases where enforced collection action is precluded.

(2) Examples.

(i) The taxpayer has received a statutory notice of deficiency, under I.R.C. § 6212, which entitles the taxpayer to seek Tax Court review of a proposed tax deficiency. This is not a delinquent tax because it is not a final tax liability. Should the taxpayer seek Tax Court review, this will not be a final tax liability until the taxpayer has exercised all judicial appeal rights.

- (ii) The IRS has filed a notice of Federal tax lien with respect to an assessed tax liability, and the taxpayer has been issued a notice under I.R.C. § 6320 entitling the taxpayer to request a hearing with the IRS Office of Appeals contesting the lien filing, and to further appeal to the Tax Court if the IRS determines to sustain the lien filing. In the course of the hearing, the taxpayer is entitled to contest the underlying tax liability because the taxpayer has had no prior opportunity to contest the liability. This is not a delinquent tax because it is not a final tax liability. Should the taxpayer seek tax court review, this will not be a final tax liability until the taxpayer has exercised all judicial appeal rights.
- (iii) The taxpayer has entered into an installment agreement pursuant to I.R.C. § 6159. The taxpayer is making timely payments and is in full compliance with the agreement terms. The taxpayer is not delinquent because the taxpayer is not currently required to make full payment.
- (iv) The taxpayer has filed for bankruptcy protection. The taxpayer is not delinquent because enforced collection action is stayed under 11U.S.C. 362 (the Bankruptcy Code).
- (ii) The Offeror has _____ has not _____, within a three-year period preceding this offer, had one or more contracts terminated for default by any Federal Agency.
- (2) “Principal,” for the purposes of this certification, means an officer; director; owner; partner; or a person having primary management or supervisory responsibilities within a business entity (e.g., general manager; plant manager; head of a division or business segment; and similar positions). This certification concerns a matter within the jurisdiction of an agency of the United States and the making of a false, fictitious, or fraudulent certification may render the maker subject to prosecution under section 1001, title 18, United States Code.
- (b) The Offeror shall provide immediate written notice to the Contracting Officer if, at any time prior to contract award, the Offeror learns that its certification was erroneous when submitted or has become erroneous by reason of changed circumstances.
- (c) A certification that any of the items in paragraph (a) of this provision exists will not necessarily result in withholding of an award under this solicitation. However, the certification will be considered in connection with a determination of the Offeror's responsibility. Failure of the Offeror to furnish a certification or provide such additional information as requested by the Contracting Officer may render the Offeror non-responsible.
- (d) Nothing contained in the foregoing shall be construed to require establishment of a system of records in order to render, in good faith, the certification required by paragraph (a) of this provision. The knowledge and information of an Offeror is not required to exceed that which is normally possessed by a prudent person in the ordinary course of business dealing.
- (e) The certification in paragraph (a) of this provision is a material representation of fact upon

which reliance was placed when making award. If it is later determined that the Offeror knowingly rendered an erroneous certification, in addition to other remedies available to the Government, the Contracting Officer may terminate the contract resulting from this solicitation for default. (CHECK THE APPLICABLE BOX)

4. 52.223-2CLEAN AIR AND WATER CERTIFICATION (APR 1984)

The Offeror certifies that--

(a) Any facility to be used in the performance of this proposed contract is [], is not [] listed on the Environmental Protection Agency (EPA) List of Violating Facilities;

(b) The Offeror will immediately notify the Contracting Officer, before award, of the receipt of any communication from the Administrator, or a designee, of the EPA, indicating that any facility that the Offeror proposes to use for the performance of the contract is under consideration to be listed on the EPA List of Violating Facilities; and

(c) The Offeror will include a certification substantially the same as this certification, including this paragraph (c), in every nonexempt subcontract. (CHECK THE APPLICABLE BOX)

_____ Date: _____

Authorized Signature and Date (**Must be signed by the person identified in line item #2 of EXHIBIT A**)

APPENDIX E (MANDATORY)

CAMPAIGN CONTRIBUTION DISCLOSURE FORM

Pursuant to the Procurement Code, Sections 13-1-28, et seq., NMSA 1978 and NMSA 1978, § 13-1-191.1 (2006), as amended by Laws of 2007, Chapter 234, any prospective contractor seeking to enter into a contract with any state agency or local public body **for professional services, a design and build project delivery system, or the design and installation of measures the primary purpose of which is to conserve natural resources** must file this form with that state agency or local public body. This form must be filed even if the contract qualifies as a small purchase or a sole source contract. The prospective contractor must disclose whether they, a family member or a representative of the prospective contractor has made a campaign contribution to an applicable public official of the state or a local public body during the two years prior to the date on which the contractor submits a proposal or, in the case of a sole source or small purchase contract, the two years prior to the date the contractor signs the contract, if the aggregate total of contributions given by the prospective contractor, a family member or a representative of the prospective contractor to the public official exceeds two hundred and fifty dollars (\$250) over the two year period.

Furthermore, the state agency or local public body may cancel a solicitation or proposed award for a proposed contract pursuant to Section 13-1-181 NMSA 1978 or a contract that is executed may be ratified or terminated pursuant to Section 13-1-182 NMSA 1978 of the Procurement Code if: 1) a prospective contractor, a family member of the prospective contractor, or a representative of the prospective contractor gives a campaign contribution or other thing of value to an applicable public official or the applicable public official's employees during the pendency of the procurement process or 2) a prospective contractor fails to submit a fully completed disclosure statement pursuant to the law.

The state agency or local public body that procures the services or items of tangible personal property shall indicate on the form the name or names of every applicable public official, if any, for which disclosure is required by a prospective contractor.

THIS FORM MUST BE INCLUDED IN THE REQUEST FOR PROPOSALS AND MUST BE FILED BY ANY PROSPECTIVE CONTRACTOR WHETHER OR NOT THEY, THEIR FAMILY MEMBER, OR THEIR REPRESENTATIVE HAS MADE ANY CONTRIBUTIONS SUBJECT TO DISCLOSURE.

The following definitions apply:

“Applicable public official” means a person elected to an office or a person appointed to complete a term of an elected office, who has the authority to award or influence the award of the contract for which the prospective contractor is submitting a competitive sealed proposal or who has the authority to negotiate a sole source or small purchase contract that may be awarded without submission of a sealed competitive proposal.

“Campaign Contribution” means a gift, subscription, loan, advance or deposit of money or other thing of value, including the estimated value of an in-kind contribution, that is made to or received by an applicable public official or any person authorized to raise, collect or expend contributions on that official’s behalf for the purpose of electing the official to statewide or local office. “Campaign Contribution” includes the payment of a debt incurred in an election campaign, but does not include the value of services provided without compensation or unreimbursed travel or other personal expenses of individuals who volunteer a portion or all of their time on behalf of a candidate or political committee, nor does it include the administrative or solicitation expenses of a political committee that are paid by an organization that sponsors the committee.

“Family member” means spouse, father, mother, child, father-in-law, mother-in-law, daughter-in-law or son-in-law of (a) a prospective contractor, if the prospective contractor is a natural person; or (b) an owner of a prospective contractor.

“Pendency of the procurement process” means the time period commencing with the public notice of the request for proposals and ending with the award of the contract or the cancellation of the request for proposals.

“Prospective contractor” means a person or business that is subject to the competitive sealed proposal process set forth in the Procurement Code or is not required to submit a competitive sealed proposal because that person or business qualifies for a sole source or a small purchase contract.

“Representative of a prospective contractor” means an officer or director of a corporation, a member or manager of a limited liability corporation, a partner of a partnership or a trustee of a trust of the prospective contractor.

Name(s) of Applicable Public Official(s): James E. Paxon, Travis Day and Frances Luna
(Completed by State Agency or Local Public Body)

DISCLOSURE OF CONTRIBUTIONS BY PROSPECTIVE CONTRACTOR:

Contribution Made By: _____

Relation to Prospective Contractor: _____

Date Contribution(s) Made: _____

Amount(s) of Contribution(s) _____

Nature of Contribution(s) _____

Purpose of Contribution(s)

(Attach extra pages if necessary)

Signature

Date

Title (position)

--OR--

NO CONTRIBUTIONS IN THE AGGREGATE TOTAL OVER TWO HUNDRED FIFTY DOLLARS (\$250) WERE MADE to an applicable public official by me, a family member or representative.

Signature

Date

Title (Position)

APPENDIX F

GENERAL CONDITIONS OF THE CONTRACT FOR CONSTRUCTION

The following supplements modify, change, delete from or add to the “General Conditions of the Contract for Construction”, AIA Document A201, 2019 as indicated in each numbered “Part” heading. Where any article of the General Conditions is modified or any paragraph, subparagraph or clause thereof is modified or deleted by these Supplementary Conditions, the unaltered provisions of that article, paragraph, subparagraph or clause shall remain in effect.

✦ MODIFICATIONS TO GENERAL CONDITIONS ✦

PART 1.0 (Re: 1.1 BASIC DEFINITIONS) - ADD THE FOLLOWING SUBPARAGRAPH 1.1.9:

“1.1.9 ADDITIONAL DEFINITIONS

The following definitions shall apply throughout the Bidding Documents or Contract Documents unless otherwise specified:

- .1 SURETY: The person or entity obligated to provide such performance or payment as set forth in bonds required by the Contract Documents.
- .2 UNIT PRICES: Amounts stated in the Contract as prices per unit of measurement for materials or services as described in the Contract Documents.
- .3 USER: The Owner agency or agencies or designated entity for whose use the Project is being constructed.
- .4 OWNER: Valencia County referenced as Owner within these Documents.
- .5 ARCHITECT/ENGINEER: The Architect/ Engineer referenced within these documents.
- .6 RETAINAGE: The amount of money otherwise due to a Contractor that may be withheld by the Owner to secure performance of the Contract.”

PART 2.0 (Re: 1.5 OWNERSHIP AND USE OF DRAWINGS, SPECIFICATIONS AND OTHER INSTRUMENTS OF SERVICE) - SUBSTITUTE THE FOLLOWING FOR THE FIRST SENTENCE OF SUBPARAGRAPH 1.5.1:

“1.5.1 The Drawings, Project Manual Documents and Technical Specifications, notes, and other work developed for the performance of this Contract and copies thereof furnished by the Architect/Engineer shall be the sole property of the Owner with the understanding and agreement that they are to be used only with respect to this Project and are not to be used on any other Project, or for any other purpose.”

PART 3.0 (Re: 3.6 TAXES) - ADD THE FOLLOWING TO PARAGRAPH 3.6:

“The Contractor shall comply with the requirements of the state of New Mexico gross receipts law and shall require all subcontractors to comply with the same. Any increase or decrease in gross receipts and local option taxes enacted after the date the Contract is signed shall result in a similar increase or decrease in the contract sum by appropriate modification.”

PART 4.0 (Re: 3.15 CLEANING UP) - ADD THE FOLLOWING TO SUBPARAGRAPH 3.15.1:

“The Contractor shall thoroughly clean the premises at the completion of the Work.”

PART 5.0 (Re: ARTICLE 4 ARCHITECT) - ADD THE FOLLOWING SUBPARAGRAPH 4.1.4:

“4.1.4 Any dispute in connection with such an appointment shall be considered an aggrievement and subject to the provisions of ARTICLE 15 CLAIMS AND DISPUTES.”

PART 6.0 (Re: ARTICLE 4 ARCHITECT) - ADD THE FOLLOWING SUBPARAGRAPH 4.1.5:

“4.1.5 The Owner may, but is not required, to assist the Architect/Engineer to provide administration of the Contract for Construction.”

PART 7.0 (Re: 4.2 ADMINISTRATION OF THE CONTRACT) - ADD THE FOLLOWING TO SUBPARAGRAPH 4.2.3:

“Should the Architect determine that any portion of the Work varies from the requirements of the Contract Documents, the Architect/Engineer shall promptly notify the Owner and the Contractor of the nature of the non-compliance and the correction of the Work required. The Contractor expressly recognizes that the Architect does not owe him any duty to supervise or direct his work as to protect the Contractor from the consequences of his own acts or omissions.”

PART 8.0 (Re: ARTICLE 7 CHANGES IN THE WORK) - DELETE ARTICLE 7 IN ENTIRETY AND SUBSTITUTE THE FOLLOWING “NEW” ARTICLE 7:

“ARTICLE 7 CHANGES IN THE WORK

7.1 CHANGES

7.1.1 Changes in the Work may be accomplished after execution of the Contract, and without invalidating the Contract, by initiation of a Construction Change Directive or order for a minor change in the Work, subject to the limitations stated in this Article 7 and elsewhere in the Contract Documents.

7.1.2 A Construction Change Directive requires agreement by the Owner and the Architect and shall be prepared by the Owner or the Architect on its own initiative or at the request of the Owner’s representative, or the Contractor. To result in a change in the Work, any change in Contract Time, any change in Contract Sum, or any combination of the foregoing, the Construction Change Directive must be included ultimately in a Change Order. An order for a minor change in the Work, without a change in Contract Time or Contract Sum, may be issued by the Architect alone.

7.1.3 Changes in the Work shall be performed under applicable provisions of the Contract Documents, and the Contractor shall proceed promptly, unless otherwise provided in the Construction Change Directive or order for a minor change in the Work.

7.1.4 If unit prices are stated in the Contract Documents or subsequently agreed upon, and if quantities originally contemplated are so changed in a Construction Change Directive that application of such unit prices to quantities of Work proposed will cause substantial inequity to the Owner or Contractor, the applicable unit prices shall be equitably adjusted.

7.2 CONSTRUCTION CHANGE DIRECTIVES

7.2.1 A Construction Change Directive is a written order signed by the Owner and Architect/Engineer, directing a

change in the Work an stating a proposed basis for adjustment, if any, in the Contract Sum or Contract Time, or both. The Owner may by Construction Change Directive, without invalidating the Contract, order changes in the Work within the general scope of the Contract consisting of additions, deletions or other revisions, the Contract Sum and Contract Time being adjusted accordingly.

7.2.2 If the Construction Change Directive provides for an adjustment to the Contract Sum, the adjustment shall be based on one of the following methods:

- .1 mutual acceptance of a lump sum properly itemized and supported by sufficient substantiating data on costs to permit evaluation;
- .2 unit prices stated in the Contract Documents or subsequently agreed upon; or
- .3 cost to be determined in accordance with Subparagraph 7.2.5 with or without a guaranteed maximum.

7.2.3 Upon receipt of a Construction Change Directive, the Contractor shall acknowledge receipt of it on the document, and , if applicable, the Contractor's agreement to its terms, promptly proceed with the change in the Work involved and advise the Architect/Engineer if the Contractor is in disagreement with the method, if any, provided in the Construction Change Directive for determining the proposed adjustment in the Contract Sum or Contract Time.

7.2.4 A Construction Change Directive signed as agreed to by the Contractor indicates the agreement of the Contractor therewith, including adjustment in Contract Sum and Contract Time or the method for determining them. Such agreement shall be effective immediately, shall remain binding for sixty days and shall ultimately be included in a Change Order.

7.2.5 If the Contractor does not respond promptly or disagrees with the method for adjustment in the Contract Sum, the method and the adjustment shall be determined by the Architect/Engineer on the basis of reasonable expenditures and savings of those performing the Work attributable to the change, including, in case of an increase in the Contract Sum, and a reasonable allowance for overhead and profit as set forth in Table 1 below. In such case, and also under Clause 7.2.2, the Contractor shall keep and present, in such form as the Architect/Engineer may prescribe, an itemized accounting together with appropriate supporting data of costs incurred in performing the change required by the Construction Change Directive. Costs for the purposes of this Paragraph 7.2.5 includes only the following:

- .1 material quantities and unit costs;
- .2 labor amounts and hourly rates (identified with specific items of material to be placed or operation to be performed);
- .3 costs inherent in the use of equipment owned by the Contractor, the Subcontractors, and/or the Sub-subcontractors;
- .4 equipment rental, if any;
- .5 worker's compensation and public liability insurance;
- .6 general administration, overhead, supervision, project insurance, bonds and profit, based on the following schedule (subtotal before applying the percentage shown):

TABLE 1	\$500 or less	\$501 to 5% of Contract	Over 5% of Contract Negotiable
Contractor for Work performed by his own forces	22%	19%	Negotiable
Contractor for Work performed by Subcontractor	10%	8%	Negotiable
Subcontractor for Work performed by his own forces	18%	15%	Negotiable
Subcontractor for Work performed by Sub-subcontractor	10%	8%	Negotiable
Sub-subcontractor for Work performed by his own forces	18%	15%	Negotiable

- .7 employment taxes under FICA and FUTA; and

.8 state gross receipts and local option tax (Contractor only).

7.2.6 Pending final determination of cost to the Owner, amounts not in dispute may be included in Applications for Payment. The amount of credit to be allowed by the Contractor to the Owner for a change that results in a net decrease in the Contract Sum shall be the amount of net cost decrease plus an amount equal to the net cost decrease multiplied by a percentage of 3% for general administration, overhead, supervision, project insurance, bonds, and profit as specified in Clause 7.2.5.6.

7.2.7 If the Owner and Contractor do not agree with the adjustment in Contract Time or the method for determining it, the adjustment or the method shall be referred to the Architect/Engineer for determination.

7.2.8 When the Owner and Contractor agree with the determination made by the Architect/Engineer concerning the adjustments in the Contract Sum and Contract Time, or otherwise reach agreement upon the adjustments, such agreement shall be effective immediately and shall be recorded by preparation and execution of an appropriate Change Order.

7.3 CHANGE ORDERS

7.3.1 A Change Order is a written instrument prepared by the Architect/Engineer and signed by the Owner, Contractor, and Architect/Engineer, stating their agreement upon all of the following:

- .1 a change in the Work;
- .2 the amount of the adjustment in the Contract Sum, if any, and
- .3 the extent of the adjustment in the Contract Time, if any.

7.3.2 A Change Order may include more than one Construction Change Directive and will customarily be executed after the completion in the Work.

7.4 MINOR CHANGES IN THE WORK

7.4.1 The Architect/Engineer will have authority to order minor changes in the Work not involving adjustment in the Contract Sum or extension of the Contract Time and not inconsistent with the intent of the Contract Documents. Such changes shall be effected by written order and shall be binding on the Owner and Contractor. The Contractor shall carry out such written orders promptly.”

PART 9.0 (Re: PROGRESS AND COMPLETION) - ADD THE FOLLOWING SUBPARAGRAPH 8.2.4:

“8.2.4 The Contractor agrees that the Work shall be prosecuted regularly, diligently and uninterruptedly at a rate of progress that will insure full completion within the Contract Time specified. It is expressly understood and agreed, by and between the Contractor and the Owner, that the Contract time specified for the completion of the Work is reasonable; taking into consideration the average climate conditions, temperature ranges, and usual industrial conditions prevailing in this locality. If the Contractor shall neglect, fail or refuse to complete the Work within the Contract Time, or any proper extension granted by the Owner, then the Contractor agrees, as a part consideration for the awarding of this Contract, not as a penalty but as liquidated damages for such breach of contract as set forth in the Contract Documents, for each and every calendar day that the Contractor shall be in default after the Contract Time.”

PART 10.0 (Re: 8.3 DELAYS AND EXTENSIONS OF TIME) - ADD THE FOLLOWING SENTENCE TO SUBPARAGRAPH 8.3.1:

“Where individual items or designated portions of the Work require changes in completion time, but are not interrelated with items of work governed by the Contract Time, the Architect/Engineer and the Owner may establish by Change Order separate completion dates with separate Liquidated Damages acceptable to the Contractor and leave the Contract Time unchanged.”

PART 11.0 (Re: 9.2 SCHEDULE OF VALUES) - ADD THE FOLLOWING TO SUBPARAGRAPH 9.2:

"This schedule shall include separate line items for costs pertaining to each Cash Allowance item indicated in the Contract Documents and for a reasonable amount, which shall be designated as 'Final Administrative Closeout', attributable to Contractor completion of the administrative and documentation requirements for Contract Closeout following certification of Substantial Completion."

PART 12.0 (Re: 9.3 APPLICATIONS FOR PAYMENT) - ADD NEW SUBPARAGRAPHS 9.3.1.3 and 9.3.1.4

"9.3.1.3 Retainage: Unless good cause exists, the Owner shall not withhold retainage from any payments due and owing a contractor.

9.3.1.4 Upon completion and acceptance of each separate building, public work, or other division of the contract, on which the price is stated separately in the contract, payment may be made without retention of a percentage."

PART 13.0 (Re: 9.5 DECISIONS TO WITHHOLD CERTIFICATION) - ADD THE FOLLOWING ITEMS TO SUB-SUBPARAGRAPH 9.5.1:

".8 failure to provide an approved progress schedule.

.9 the contract sum has been reduced by change order, and the payment request exceeds the revised Contract Sum."

PART 14.0 (Re: 9.5 DECISIONS TO WITHHOLD CERTIFICATION) - ADD THE FOLLOWING SUBPARAGRAPH 9.5.4:

"9.5.4 The Owner may refuse to make payment of the full amount recommended by the Architect/Engineer in order to protect itself from loss because of Subparagraphs 9.5.1.1 through 9.5.1.8, but the Owner must give the Contractor immediate written notice, with a copy to the Architect/Engineer, stating the reasons for such action."

PART 15.0 (Re: PAYMENTS AND COMPLETION) - ADD THE FOLLOWING PARAGRAPH 9.11:

9.11 LIQUIDATED DAMAGES

9.11.1 The Contractor and the Contractor's surety shall be jointly and severally liable for and shall pay the Owner the sums hereinafter stipulated in the Contract as liquidated damages for each calendar day of delay until the work is substantially complete. Liquidated damages set forth in the Agreement will be assessed from the Contractor's scheduled completion date."

PART 16.0 (Re: 10.3 HAZARDOUS MATERIALS) - DELETE IN ITS ENTIRETY. Article IX, Section 12 and the similar constitutional debt restrictions for the state and other local governments (N.M. Const. art. IX, §§ 8, 11-13) have been judicially interpreted to preclude a government from entering into an agreement subjecting it to contingent liability, the amount of which is uncertain at the time of the agreement.

PART 17.0 (Re: ARTICLE 11 INSURANCE AND BONDS) - SUBSTITUTE THE FOLLOWING FOR SUBPARAGRAPH 11.1.1:

1. 11.1.1 The contractor shall purchase and maintain, in a company or companies licensed to do business in the State in which the project is located, such insurance as will protect him, the Owner and the Architect from claims set forth below which may arise out of, or result from, the Contractors' operations under the contract, whether such operation be by himself, or by any Sub-contractor, or by anyone for whose acts any of them may be liable. (Subparagraphs .1 through .8 shall remain unchanged.)

2. 11.1.1.9 Liability insurance shall include all major divisions of coverage and be on a comprehensive basis including:

- a) Premises operations.
- b) Independent contractor's protective.
- c) Products and completed operations.
- d) Contractual – Including specified provisions for the Contractor's obligations under paragraph 4.18.
- e) Owned, non-owned, and hired vehicles.
- f) Broad form coverage for property damage.
- g) Personal injury.

3. For the duration of the contract and until all work specified in the contract is completed, the Contractor shall maintain in effect all insurance as required below and comply with all limits, terms, and conditions stipulated therein. Any claims made coverages shall be maintained for two years after the substantial completion.

- a) Work under this contract shall not commence until evidence of all required insurance and bonding is provided to the Owner and the Architect.
- b) All insurance shall be written to conform to the requirements below.
- c) Evidence of such insurance shall consist of a completed certificate of insurance, signed by the insurance agent for the Contractor and returned to the Owner.

4. Certificate of Insurance:

- a) All required insurance is in effect.
- b) The Owner is an additional insured on the Contractor's general liability policy with respect to activities under this contract. The additional insured endorsement shall be ISO form CG 20 10 11 85 or a substitute endorsement providing equivalent coverage.
- c) The general liability insurance afforded applies separately to each insured against whom claim is made or suit is brought except with respect to the limits of the company's liability.
- d) The general liability insurance of the Contractor shall be primary insurance and any insurance or self-insurance of the Owner shall be excess and not contributory insurance.
- e) If for any reason, any material change occurs in the coverage during the course of the contract, such change will not become effective until 30 days after the Owner has received written notice of such change.

5. Contractor shall obtain insurance of the types described below from an insurer with an A.M. Bests rating of not less than A-VIII and authorized to do business in the State of New Mexico.

- a) Commercial General Liability insurance shall be written on ISO occurrence form CG 00 01 or similar and shall cover liability arising from products and completed operations, premises, contractual liability, personal injury, and advertising injury. There shall be no endorsement or modification of the Commercial General Liability insurance limiting coverage for claims arising from explosion, collapse, or underground exposures.
- b) Workers' Compensation Insurance as required by the State.
- c) Automobile Liability Insurance covering all owned, non-owned, hired and leased vehicles. Coverage shall be written on ISO form CA 00 01 or a substitute form providing equivalent liability coverage.
- d) Property Insurance: Not required.

PART 18.0 (Re: ARTICLE 11 INSURANCE AND BONDS) - SUBSTITUTE THE FOLLOWING FOR SUBPARAGRAPH 11.1.2:

A. The limits of liability for the insurance required by Subparagraph 11.1.1 shall provide coverage for not less than the following amounts or greater if required by law:

- 1. Commercial General Liability insurance shall be written with limits no less than \$1,000,000 each occurrence, a \$2,000,000 general aggregate and a \$2,000,000 products-completed operations aggregate limit.
- 2. Workers' Compensation Insurance with limits as required by Statute.

3. Automobile Liability Insurance with a combined single limit for bodily injury and property damage of not less than \$1,000,000 per accident.

4. Commercial general liability and automobile liability insurance shall include as additional named insured: The Owner, the Architect, The Architect's consultants and engineers, and each of their officers, employees and agents, and any other persons with an insurable interest designated by the Owner as an additional named insured.

B. Subcontractors:

1. The Contractor shall:
a. Include all subcontractors as insureds under its policies, or
b. Shall furnish separate certificates and endorsements for each subcontractor to the Owner. The Subcontractors' Commercial General Liability insurance shall be written with limits no less than \$1,000,000 each occurrence, a \$2,000,000 general aggregate and a \$1,000,000 products-completed operations aggregate limit.

C. Contractor's Insurance for Other Losses:

1. The Contractor shall assume full responsibility for all loss or damage from any cause whatsoever to any tools, Contractor's employee-owned tools, machinery, equipment, or motor vehicles owned or rented by the Contractor, or the Contractor's agents, suppliers or contractors, as well as to any temporary structures, scaffolding, and protective fences.

PART 19.0 (Re: ARTICLE 11 INSURANCE AND BONDS) - ADD THE FOLLOWING TO SUBPARAGRAPH 11.1.3:

"11.1.3 Furnish one (1) copy of Certificates herein required for each copy of the Agreement, specifically setting forth evidence of all coverage required by subparagraph 11.1.2.

11.1.3.1 Should any of the above described policies be cancelled before the expiration date thereof, the issuing company will mail 30 days written notice to the certificate holder named to the left, but failure to mail such notice shall impose no obligation or liability of any kind upon the company, its agents or representatives."

PART 20.0 (Re: ARTICLE 11 INSURANCE AND BONDS) - ADD THE FOLLOWING SUBPARAGRAPH 11.1.4:

"11.1.4 The Contractor shall have the Owner named as an additional insured on the Comprehensive General Liability form or Commercial Liability form furnished by the Contractor. The certificate of insurance shall state that the coverage provided under the policy is primary over any other valid and collectible insurance."

PART 21.0 (Re: ARTICLE 11 INSURANCE AND BONDS) - MODIFY PARAGRAPH 11.4 IN THE FOLLOWING MANNER:

11.4.1 The General Contractor shall purchase Builder's Risk Insurance per Section 11.4.

11.4.1.2 The General Contractor shall purchase Builder's Risk Insurance.

11.4.1.3 The Contractor is responsible for Builder's Risk deductible.

11.4.2 Delete

PART 22.0 (Re: 11.4.3 LOSS OF USE INSURANCE) - DELETE THE LAST SENTENCE OF SUBPARAGRAPH 11.4.3.

PART 23.0 (Re: 11.5 PERFORMANCE BOND AND PAYMENT BOND) - SUBSTITUTE THE FOLLOWING FOR SUBPARAGRAPHS 11.5.1 and 11.5.2 and add 11.5.3 and 11.5.4:

11.5.1 The Contractor shall post a one hundred percent (100%) Performance Bond and a one hundred percent (100%) Labor and Material Payment Bond, forms attached hereto with amount payable conforming to the terms of the Contract. Surety shall be a company licensed to do business in the State of New Mexico and executed by such sureties as are named in the current list of Companies Holding Certificates of Authority as Acceptable Sureties on Federal Bonds as published in federal circular 570 by the Audit Staff Bureau of Accounts, U.S. Treasury Department.

11.5.2 Special attention is called to the requirements of §13-4-18 through §13-4-20, NMSA 1978, regarding a Contractor who does not have his principal place of business in the State of New Mexico for all taxes due arising out of construction services rendered under the Contract.

11.5.3 The right to sue on this Bond accrues only to the Owner and the parties to whom §13-4-18 through §13-4-20, NMSA 1978, grant such right; and any such right shall be exercised only in accordance with the provisions and limitations of said statutes.

11.5.4 Subcontractor Bonding Requirements

11.5.4.1 It is the responsibility of each subcontractor submitting a bid to a contractor to be prepared to submit a faithful performance and payment bond if the subcontract exceeds \$50,000.

11.5.4.2 In the event any subcontractor is submitting a bid to a contractor does not, upon the request of the contractor and at the expense of the contractor at the established charge or premium therefore, furnish to the contractor a bond issued by a corporate surety authorized to do business in New Mexico in accordance with the New Mexico in accordance with the New Mexico Insurance Code (59A-1-1 to 591-A-18, NMSA 1978) and listed in the United States Treasury Department circular 570 where in the contractor is named the obligee, guaranteeing prompt and faithful performance of the subcontract and the payment of all claims for labor and materials furnished or used in and about the work to be done and performed under the subcontract, the contractor may reject the bid and make a substitution of another subcontractor subject to the provisions of Section 13-4-36, NMSA 1978. Such bond may be required at the expense of the subcontractor only if the contractor has in his written or published request for subcontract bids:

- .1 Specifies that the expense for the bond shall be borne by the subcontractor; and
- .2 Clearly specifies the amount and requirements of the bond."

PART 24.0 (Re: 13.5 TESTS AND INSPECTIONS) - ADD THE FOLLOWING SUB-SUBPARAGRAPH TO SUBPARAGRAPH 13.5.1:

"13.5.1.1 All sampling, transportation, and storage of samples; testing; and reporting shall be undertaken by representatives of the testing laboratory. No sampling, transportation, and storage of samples; testing; or reporting shall be undertaken by the Architect/Engineer, the Owner, or the Subcontractors."

PART 25.0 (Re: 13.5 TESTS AND INSPECTIONS) - SUBSTITUTE THE FOLLOWING SUBPARAGRAPH 13.5.4:

"13.5.4 Two copies of all test reports shall be furnished directly to the Owner, the Architect/Engineer, and the Contractor by the testing laboratory. All test reports shall be sequentially numbered and labeled in accordance with industry standards."

PART 26.0 DELETE PARAGRAPH 13.6 IN ITS ENTIRETY.

PART 27.0 (Re: TERMINATION OR SUSPENSION OF THE CONTRACT) - ADD THE FOLLOWING TO ARTICLE 14:

"14.4.4 The terms of this Contract are contingent upon sufficient appropriations and authorization being made by the governing body for the performance of this Contract. If sufficient appropriations are not made by the governing

body, this Contract shall terminate upon written notice being given by the County to the Contractor. The County's determination as to whether sufficient appropriations are available shall be accepted by the Contractor and shall be final."

PART 28.0 (Re: ARTICLE 15 CLAIMS AND DISPUTES) - SUBSTITUTE THE FOLLOWING FOR THE FIRST SENTENCE OF SUBPARAGRAPH 15.1.2:

"15.1.2 NOTICE OF CLAIMS

All claims, disputes, and other matters in question between the Owner and the Contractor shall be referred to the Architect/Engineer for formal decision pursuant to the relevant paragraphs and clauses of ARTICLE 15 CLAIMS AND DISPUTES."

PART 29.0 (Re: PARAGRAPH 15.3 MEDIATION AND PARAGRAPH 15.4 ARBITRATION) - SUBSTITUTE THE FOLLOWING FOR PARAGRAPH 15, INCLUSIVE OF ALL SUBPARAGRAPHS AND FOR PARAGRAPH 15.4, INCLUSIVE OF ALL SUBPARAGRAPHS:

"15.3 AGGRIEVEMENT PROCEDURE DURING CONTRACT ADMINISTRATION

15.3.1 Any claim, dispute, or other matter in question between the Contractor and the Owner, except those relating to artistic effect as provided in Subparagraph 4.2.13 and except those which have been waived by the making or acceptance of final payment as provided in Subparagraph 9.10.4, shall be presented in the form of a written request accompanied by supporting data to the Architect/Engineer for formal decision, with a copy to the other party. Such formal decision of the Architect/Engineer is binding upon the Contractor and the Owner unless either or both parties notify each other and the Architect/Engineer in writing within fifteen days of their receipt of the decision that they are unwilling to abide by the Architect/Engineer's decision, and are thereby aggrieved in connection with the decision and are separately exercising such rights as either may have under the Contract Documents or by law and regulation. If the Architect/Engineer fails to provide a written decision or a reasonable schedule to issue a written decision or a reasonable schedule to issue a written decision with ten days after the Owner or the Contractor has presented his request, that party may consider himself aggrieved and may proceed to exercise his rights.

15.3.2 A settlement agreement signed by the Owner and the Contractor shall supersede and cancel any other dispute resolution proceedings regarding the same matter.

15.3.3 Mediation and arbitration of controversies and claims. Should the procedures for dispute resolution stated in Subparagraph 15.3.1 fail to adequately resolve the claim, dispute or other matter in question, any such claim, dispute or matter in question shall be resolved by binding arbitration governed by the provisions of this Paragraph 15.3.3 and the New Mexico Uniform Arbitration Act. Before submitting a dispute to arbitration the parties shall make a good faith effort to resolve the dispute through formal mediation or other agreed upon alternative dispute resolution technique. The arbitration shall be before a single arbitrator chosen by mutual agreement of the parties. If they cannot agree, then a list of seven potential arbitrators will be obtained from the New Mexico Association of Counties and the parties shall utilize a striking process until an arbitrator is agreed upon. In the event this Contract results in dispute, mediation, arbitration litigation, or settlement, the prevailing party of such action shall NOT be entitled to an award of attorneys' fees and costs.

15.3.4 Unless work is stopped or payment withheld in accordance with the conditions of the Contract, or unless otherwise agreed in writing, the Contractor shall carry on the Work and maintain its progress during any grievement proceedings, and the Owner shall continue to make payments to the Contractor in accordance with the Contract Documents."

◆ ADDITIONAL CONDITIONS ◆

PART 1.0 EQUAL OPPORTUNITY

1.1 The Contractor, all Subcontractors, and all Sub-subcontractors shall not discriminate against any employee or applicant for employment because of race, religion, color, sex, or national origin. The Contractor shall take affirmative action to ensure that applicants are employed and that employees are treated during employment without regard to their race, religion, color, sex, or national origin. Such action shall include, but not be limited to, the following: employment, recruitment or recruitment advertising, upgrading, layoff or termination, demotion, rates of pay or other forms of compensation, transfer, selection for training (including apprenticeship)

1.2 The Contractor agrees to post in conspicuous places, available to employees and applicants for employment, notices setting forth the policies of nondiscrimination.

1.3 The Contractor, all Subcontractors, and all Sub-subcontractors shall, in all solicitation or advertisement for employees placed by them or on their behalf, state that all qualified applicants will receive consideration for employment without regard to race, religion, color, sex, or national origin.

PART 2.0 MINIMUM WAGE RATES

2.1 The Contractor warrants and agrees that he will comply and will require all Subcontractors and Sub-subcontractors to comply with all applicable provisions of the New Mexico Public Works Minimum Wage Act as outlined in the Contract Documents. Wage rates are not applicable to projects costing less than \$20,000. The Contractor and his Subcontractors shall deliver by mail copies of certified weekly payroll in accordance with the regulations under "Minimum Wage Rates" to the office of the State Labor Commission, Santa Fe, New Mexico 87503, address as stated in the Determination and to the Owner.

PART 3.0 CONTRACT AUDIT

3.1 The Owner shall be entitled to audit the books and records of a Contractor or any Subcontractor under any negotiated contract or subcontract other than a firm fixed-price contract to the extent that such books and records relate to the performance of such contract or subcontract. Such books and records shall be maintained by the Contractor for a period of three years from the date of final payment under the prime Contract and by the Subcontractor for a period of three years from the date of final payment under the subcontract, unless a shorter period is otherwise authorized in writing (§13-1-16 NMSA 1978).

PART 4.0 DEBARRED OR SUSPENDED CONTRACTORS

4.1 A business (Contractor, Subcontractor, or Supplier) that has either been debarred or suspended pursuant to the requirements of Sections 13-1-177 through 13-1-180, and 13-4-11 through 13-4-17 NMSA 1978, shall not be permitted to do business with the State and shall not be considered for award of contract during the period for which it is debarred or suspended.

PART 5.0 BRIBES, GRATUITIES, AND KICKBACKS

5.1 It is illegal in the State of New Mexico for any public employee to solicit or accept anything of value in connection with award of contract for this Bid and for any person to offer or pay anything of value to any such public employee (§ 30-24-1 and 30-24-2 NMSA 1978).

5.2 Pursuant to Section 13-1-191 NMSA 1978, reference is hereby made to the Criminal Laws of New Mexico

(including §§ 30-24-1, 30-24-2, and 30-41-1 through 30-41-3 NMSA 1978), which prohibit bribes, kickbacks, and gratuities, and violation of which constitutes a felony. Further, the Procurement Code (§§ 13-1-28 through 13-1-199 NMSA 1978) imposes civil and criminal penalties for its violation.

PART 6.0 NONRESIDENT CONTRACTOR'S REQUIREMENTS: GROSS RECEIPTS TAX SURETY BOND

6.1 Section 7-1-55A NMSA 1978 provides that any person (as defined in § 7-1-3 NMSA 1978) engaged in the construction business who does not have his principal place of business in this state and enters into a prime construction contract to be performed in this State shall, at the time such contract is entered into, furnish the Director of the Revenue Division, Taxation and Revenue Department, or his delegate with a surety bond or other acceptable security in a sum equivalent to the gross receipts tax to be paid under the contract multiplied by the applicable rate of the gross receipts tax imposed by Section 7-9-4 NMSA 1978 to secure payment of the tax imposed on the gross receipts from the Contract. The person shall obtain a certificate from the Director of the Revenue Division, Taxation and Revenue Department, or his delegate that the requirements of this paragraph have been met.

6.2 If the total sum to be paid under the Contract is changed by ten percent (10%) or more after the date the surety bond or other acceptable security is furnished to the Director or his delegate, such person shall increase or decrease, as the case may be, the amount of the bond or security within 14 days after the change (§ 7-1-55B NMSA 1978).

6.3 In addition to the above requirements, the Contractor will be subject to all the requirements of Section 7-1-55 NMSA 1978.

PART 7.0 CONTRACTOR'S GROSS RECEIPTS TAX REGISTRATION

7.1 Section 7-10-4 NMSA 1978 provides that any person (as defined in § 7-10-3 NMSA 1978) performing services for the State, as those terms are used in the Gross Receipts and Compensating Tax Act (§§ 7-10-1 through 7-10-5 NMSA 1978), must be registered and be issued an identification number with the Revenue Division of the Taxation and Revenue Department to pay the gross receipts tax.

7.2 The identification number is needed to properly complete the approval process of the Contract; therefore, so as to cause no delay in the processing, the Contractor must register with the Division. For information, contact: Revenue Division, Taxation and Revenue Department, Manuel Lujan Sr., Building, 1200 St. Francis Drive, Santa Fe, New Mexico 87503, Telephone: (505) 988-2290.

7.3 If any person who performs services for the State is not registered to pay the gross receipt tax, the State shall withhold payment of the amount due until the person has presented evidence of registration with the Revenue Division to pay the gross receipts tax.

PART 8.0 ASSIGNMENT OF ANTITRUST CLAIMS

8.1 The Contractor agrees that any and all claims that the Contractor may have or that may inure to the Contractor for overcharges resulting from antitrust violations as to goods, services, and materials purchased in connection with this Bid are hereby assigned to the State of New Mexico, but only to the extent that such overcharges are passed on to the State. The Contractor further agrees to require each of its Suppliers, Subcontractors, and Sub-subcontractors to assign any and all such claims for overcharges to the State by executing an assignment on the form provided by the Owner for such purpose. The executed form (see Section 00600) shall be submitted prior to the commencement of the Work or the supplying of any materials by the Supplier, Subcontractor, or Sub-subcontractor. The submission of this executed form may be waived by the Owner upon a showing of a good-faith effort by the Contractor to obtain agreement in writing from his Supplier, Subcontractor, or Sub-subcontractor. Waiver by the Owner may not unreasonably be denied.

8.2 It is agreed that the Contractor retains all rights to any such antitrust claims to the extent of any overcharges

not passed on to the State, including the right to any treble damages attributable thereto.

PART 9.0 CONTRACTS WITH NONRESIDENT PERSONS OR PARTNERSHIPS OR UNADMITTED FOREIGN CORPORATIONS; AGENT FOR SERVICE OF PROCESS

9.1 Special attention of Bidders is called to requirements of Sections 13-4-21 through 13-4-24 NMSA 1978, whereby a public works contract with a nonresident person or partnership or foreign corporation not authorized to do business in the State shall contain a specific provision designating an agent resident within the State, and his address, upon whom process and writs in any action or proceeding against such business may be served in any action arising out of such contract.

PART 10.0 ADDENDA AND MODIFICATIONS

10.1 All Addenda and Modifications issued in writing during the Bidding period will become part of the Contract Documents.

-End-

PART 2 OF PACKET EXHIBIT A-E

EXHIBIT A (MANDATORY)

LETTER OF TRANSMITTAL FORM

Items #1 to 4 MUST EACH BE RESPONDED TO. Failure to respond to all four items WILL RESULT IN THE DISQUALIFICATION OF THE PROPOSAL!

1. Identity (Name) and Mailing Address of the submitting organization:

2: For the person authorized by the organization to contractually obligate the organization:

<u>Name</u>	
<u>Title</u>	

3. For the person authorized to negotiate the contract on behalf of the organization:

<u>Name</u>	
<u>Title</u>	
<u>E-Mail Address</u>	
<u>Telephone Number</u>	

4. For the person to be contacted for clarifications:

<u>Name</u>	
<u>Title</u>	
<u>E-Mail Address</u>	
<u>Telephone Number</u>	

- On behalf of the submitting organization named in item #1, above, I accept the Conditions Governing the Procurement as required in Section II, Paragraph C.1.
- I concur that submission of our proposal constitutes acceptance of the Evaluation Factors contained in Section III of this RFP #2019-05-009.
- I acknowledge receipt of any and all amendments to this RFP.

_____, 2019

Authorized Signature and Date (**Must be signed by the person identified in item #2, above.**)

EXHIBIT B

RFP QUESTION SUBMITTAL FORM

RFP# 2019-05-009

All written questions must be addressed to the Buyer for this RFP. Bidders are to submit written questions using the format below, or submitted in similar format sequence. Written responses to the questions received will be distributed by Sierra County Procurement Officer as addenda to this RFP solicitation. Submit questions to jholguin@sierraco.org

Question #	Reference Page/Paragraph/Sec	Question
1		
2		
3		
4		
5		
6		
7		
8		
9		
10		

Question Deadline: January 16, 2019 @ 2:00 PM MDT

EXHIBIT C

REQUEST FOR COST FORM

Reference Sierra County Agreement #: RFP #2019-05-009

OWNER: Sierra County

CONTRACTOR: _____

Sum total of prior authorized release amounts to date: \$ _____

(Note: Cumulative release authorization amounts not to exceed \$2,000,000 over four year period)

PROJECT DESCRIPTION/SCOPE:

Note: For each project \$25,000 and greater, a 100% labor, materials and performance bonds will be required of the Contractor and each subcontractor for the amount of work each sub-contractor is to perform.

Note: *New Mexico Local Public Works Projects* greater than \$60,000 shall be subject to the State of New Mexico Minimum Wage Act. Reference Wage Decision number: SI-19-0750-H

Note: **Federally Funded Projects** greater than \$2,000 shall be subject to the following Davis Bacon Wage Rate determination: NM190012 03/08/2019 NM12

In addition to the terms and conditions of the above referenced Sierra County Agreement, the terms and conditions of this release are those contained in the Project Manual dated December 20, 2019 and are as follows:

Document

Title

RFP #2019-05-009 FLOOD CONTROL CUCHILLO NEGRO ARROYO BANK STABLIZATION

(list other conditions)

<u>Number</u>	<u>Date</u>	<u>Pages</u>
_____	_____	_____
_____	_____	_____
_____	_____	_____

NOT TO EXCEED FEE PROPOSAL:

Each Application for Payment shall be based upon the Schedule of Values submitted by the Contractor in accordance with the Contract Documents to be supported with an attached fee/cost break down in the format of divisions and major subdivisions, as applicable, used by the Construction Specifications Institute (CSI).

CONTRACT SUM

The Contract Sum is based upon the following bid and bid bonds, which are described in the above Project Description/Scope:

Compensation for Construction Services:

Proposed Bid Cost for Project: \$ _____ .00

New Mexico Gross Receipt Tax: (8.500%) \$ _____

TOTAL NOT TO EXCEED FEE:

The Owner shall pay the Contractor in current funds for the Contractor's performance of the Contract the Contract Sum of _____ (\$ _____ .00), excluding NMGR T, subject to additions and deductions as provided in the Contract Documents.

Total compensation including NMGR T shall not exceed.

SUBCONTRACTOR LISTING:

Contractor is required to identify each subcontractor to be engaged in this project for which the sub-contractor will perform services in any amount. For each listed sub-contractor, Contractor is required to complete and submit the attached "Exhibit D, Subcontractor Listing Form".

SUBSTANTIAL COMPLETION:

The Contractor shall achieve Substantial Completion of the entire work not later than May 15, 2020 consecutive calendar days from the date of commencement, subject to adjustments of this Contract Time as provided in the Contract Documents.

LIQUIDATED DAMAGES:

The Contractor agrees to pay as liquidated damages, the sum of **Two-hundred and Fifty and Zero Cents (\$250.00)** for each consecutive calendar day after the stipulated contract time the work remains incomplete.

OFFEROR NAME: _____

TOTAL FIXED RATE WITHOUT GRT \$ _____

WRITTEN IN WORDS: _____

OTHER COST/EXPENSES WITHOUT GRT \$ _____

(PLEASE, PROVIDE EXPLANATION ON SEPARATE DOCUMENTS AND REFERENCE)

WRITTEN IN WORDS: _____

Typed/Printed Name: _____

Phone: _____ Email: _____

Company: _____

Address: _____

City/State/Zip: _____

Signature of Authorized Contractor: _____
Name and Title

Date: _____

EXHIBIT D

SUB- CONTRACTOR LISTING FORM

Pursuant to Section 13-4-34 of the New Mexico Procurement Code, the listing threshold for this Public Works Project is established regardless of the cost. Any person submitting an offer shall set forth:

1. The name and location of the place of business of each subcontractor under subcontract to the contractor who will perform work or labor or render service to the contractor in or about the construction of the Public Works Construction Project in an amount in excess of the listing threshold; and
2. The nature of the work which will be done by each subcontractor. List only one subcontractor for each category of work or trade.

If my Quote is accepted, the following subcontractor(s) may perform work under this contract. (If you do not plan to utilize subcontractors, write "None".)

Company Name: _____ **DOL Reg. #** _____

Address: _____ **City:** _____ **State:** _____ **Zip:** _____

E-Mail Address: _____ **License No:** _____

Phone No.: _____ **Fax No.:** _____

Work to be performed _____

Company Name: _____ **DOL Reg. #** _____

Address: _____ **City:** _____ **State:** _____ **Zip:** _____

E-Mail Address: _____ **License No:** _____

Phone No.: _____ **Fax No.:** _____

Work to be performed _____

Company Name: _____ **DOL Reg. #** _____

Address: _____ **City:** _____ **State:** _____ **Zip:** _____

E-Mail Address: _____ **License No:** _____

Phone No.: _____ **Fax No.:** _____

Work to be performed _____

(Please complete each section. Use the entire company name, not just initials unless the initials are officially used in the company name. Use additional sheets if necessary.)

RRPS must be notified of and must approve of any changes of proposed subcontractor(s) which may occur during the life of the Purchase Order for this Project. The Contractor shall be fully responsible for the work of the subcontractor(s), at any tier, to the full extent of the requirements of the Contract.

(Make additional copies if necessary)

Name of Contractor: _____

By: _____ **Date:** _____

[Signature]

Typed/Printed Name: _____

Title: _____

Date: _____

Phone: _____ **Fax:** _____

Address: _____

City/State/Zip: _____

EXHIBIT E

INSURANCE REQUIREMENTS

CERTIFICATES OF INSURANCE:

The Contractor shall furnish the Owner one copy each of Certificates of insurance herein required for each copy of the Purchase Order/Agreement showing coverage, limits of liability, covered operations, effective dates of expiration of policies of insurance carried by the Contractor. The Contractor shall furnish to the Owner copies of limits. The Certificate of Insurance shall be in the form of AIA Document G-705 or similar format acceptable to the Owner. Such certificates shall be filed with the Owner and shall also contain the following statements:

“Sierra County Commissioners, Sierra County its agents, servants and employee are held as additional insured.”

“The insurance coverage certified herein shall not be canceled or materially changed except after forty five (45) days written notice has been provided to the owner.”

COMPENSATION INSURANCE:

The Contractor shall procure and shall maintain during the life of this contract Worker’s Compensation as required by applicable State law for all Contractor’s employees to be engaged at the site of the project under this project and in case of any such work sublet the Contractor shall require the subcontractor or sub subcontractor similarly to provide Worker’s Compensation Insurance for all the subcontractor’s or sub subcontractor’s Workers which are covered under the Contractor’s Worker’s Compensation Insurance. In case any class of employee engaged in work on the project under this contract is not protected under a Worker’s Compensation Status, the Contractor shall provide and shall cause each subcontractor or sub subcontractor to provide Employer’s insurance in any amount of not less than \$500,000.

CONTRACTOR’S PUBLIC LIABILITY INSURANCE

The contractor shall procure and shall maintain during the life of this contract Public Liability Insurance as required by applicable State law. In case of any work being sublet, the Contractor shall require the subcontractor or sub-subcontractor similarly to provide Public Liability Insurance for all the subcontractor’s or sub-subcontractor’s work being performed under this Purchase Order/Agreement. In any case, whereby the Contractor’s sub-contractor or sub-subcontractor services are not covered under separate policy, the Contractor shall provide and shall cause each subcontractor or Sub-subcontractor to be covered under the contractor’s policy. The insurance must remain in force for the life of the contract including all contract extensions or renewals. The limits effective June 8, 2012 are:

\$1,000,000 per occurrence; \$1,000,000 annual aggregate.

CONTRACTOR'S VEHICLE LIABILITY INSURANCE:

The Contractor shall procure and shall maintain during the life of this contract Vehicle Liability Insurance coverage "equal to the maximum liability amounts set forth in the New Mexico Tort Claims Act Section 41-4-1 et.seq. NMSA 1978." The insurance must remain in force for the life of the contract including all contract extensions or renewals. The limits effective July 1, 1992 are:

Bodily Injury	\$750,000 Each Occurrence
Property Damage	\$100,000 Each Occurrence

SUBCONTRACTOR'S AND SUB CONTRACTOR'S PUBLIC AND VEHICLE LIABILITY INSURANCE:

The Contractor shall either:

1. Require each subcontractor or sub-contractor to procure and maintain during the life of the subcontract or sub subcontract public Liability Insurance of the types and amounts specified above or,
2. Insure the activities of the subcontractors of sub subcontractors in the Contractor's Policy as required under this Article.

GENERAL:

All Insurance policies are to be issued by companies authorized to do business under the laws of the state in which work is to be done and acceptable to owner.

The Contractor shall not violate, permit to be violated, any conditions of any said policies, and shall at all times satisfy the requirements for the insurance companies writing said policies.

PART 2 OF PACKET

EXHIBIT LISTING- F-H1 & H2+ ITEMS

EXHIBIT F

WAGE RATES

See Attached:

EXHIBIT G

DAVIS BACON

See Attached:

EXHIBIT H AND H2

**PETTIGREW & ASSOCIATES PA
BRIEF
ENGINEERING PLANS**

See Attached:

ITEM (S)

AREA PHOTOS AND DISCRIPTIONS



LABOR RELATIONS DIVISION

401 Broadway NE
 Albuquerque, NM 87102
 Phone: 505-841-4400
 Fax: 505-841-4424

226 South Alameda Blvd
 Las Cruces, NM 88005
 Phone: 575-524-6195
 Fax: 575-524-6194

WWW.DWS.STATE.NM.US

1596 Pacheco St, Suite 103
 Santa Fe, NM 87505
 Phone: 505-827-6817
 Fax: 505-827-9676

Wage Decision Approval Summary

1) Project Title: Cuchillo Negro Arroyo Bank Stabilization
 Requested Date: 12/10/2019
 Approved Date: 12/11/2019
 Approved Wage Decision Number: SI-19-2257-H

Wage Decision Expiration Date for Bids: 04/09/2020

2) Physical Location of Jobsite for Project:
 Job Site Address: NM-51, MP-1
 Job Site City: TRUTH OR CONSEQUENCES
 Job Site County: Sierra

3) Contracting Agency Name (Department or Bureau): Sierra County Administration
 Contracting Agency Contact's Name: Jocelyn Holguin
 Contracting Agency Contact's Phone: (575) 894-6215 Ext.

4) Estimated Contract Award Date: 02/18/2020

5) Estimated total project cost: \$339,000.00
 a. Are any federal funds involved?: Yes - \$255,000.00
 b. Does this project involve a building?: No
 c. Is this part of a larger plan for construction on or appurtenant to the property that is subject to this project?: No
 d. Are there any other Public Works Wage Decisions related to this project?: No
 e. What is the ultimate purpose or functional use of the construction once it is completed?: Flood mitigation/erosion control

6) Classifications of Construction:

Classification Type and Cost Total	Description
Heavy Engineering (H) Cost: \$339,000.00	Engineer developed project, for bank stabilization in the Cuchillo Negro Arroyo. Installation of sheet piles in four segments of the river bank. Based on flood damage in 2014 was declared by FEMA and the County for repairs. Th initial FEMA mitigation plan would not holdup should another large flood comes through. It was necessary to involve an engineer and provide an action plan to stabilize. Original wage decision expired as we waited for approval to move forward from Department of Homeland Security to review the RFP packet.

**EXHIBIT F
 WAGE RATES**

Type H - Heavy Engineering
Effective January 1, 2019

Trade Classification	Base Rate	Fringe Rate	Apprenticeship
Asbestos Worker - Heat & Frost Insulator	32.01	11.11	0.60
Boilermaker	34.97	27.35	0.60
Bricklayer/Blocklayer/StoneMason	23.78	8.34	0.60
Carpenter/Lather	24.08	10.34	0.60
Millwright/Piledriver	39.72	16.68	0.60
Cement Mason	21.00	9.38	0.60
Electricians			
Outside Classifications			
Groundman	22.81	11.93	0.60
Equipment Operator	32.73	14.51	0.60
Lineman/Tech	38.51	16.02	0.60
Cable Splicer	42.36	17.01	0.60
Inside Classifications			
Wireman/Tech	31.55	10.75	0.60
Cable Splicer	34.71	10.84	0.60
Glazier	20.25	5.05	0.60
Ironworker	26.50	15.56	0.60
Painter (Brush/Roller/Spray)	21.25	8.82	0.60
Plumber/Pipefitter	32.40	12.45	0.60
Roofer	24.49	7.80	0.60
SheetmetalWorker	30.28	16.60	0.60
Operators			
Group I	20.35	5.94	0.60
Group II	20.54	5.94	0.60
Group III	20.73	5.94	0.60
Group IV	20.87	5.94	0.60
Group V	20.98	5.94	0.60
Group VI	21.16	5.94	0.60
Group VII	21.18	5.94	0.60
Group VIII	23.06	5.94	0.60
Group IX	28.67	5.94	0.60
Group X	31.87	5.94	0.60
Laborers			
Group I	16.86	5.63	0.60
Group II	17.61	5.63	0.60
Group III	19.12	5.63	0.60
Group IV	19.52	5.63	0.60
Truck Drivers			
Group I	16.15	7.52	0.60
Group II	16.15	7.52	0.60
Group III	16.15	7.52	0.60
Group IV	16.15	7.52	0.60
Group V	16.15	7.52	0.60
Group VI	16.15	7.52	0.60
Group VII	16.15	7.52	0.60
Group VIII	16.21	7.52	0.60
Group IX	18.15	7.52	0.60

NOTE: All Contractors are required to pay SUBSISTENCE, ZONE AND INCENTIVE PAY according to the particular trade. Details are located in a PDF attachment at WWW.DWS.STATE.NM.US. Search Labor Relations/Labor Information/Public Works/Prevailing Wage Rates.



LABOR RELATIONS DIVISION
121 Tijeras Ave NE, Suite 3000
Albuquerque, NM 87102
Phone: 505-841-4400
Fax: 505-841-4424

WWW.DWS.STATE.NM.US

PUBLIC WORKS PROJECT REQUIREMENTS

As a participant in a Public Works project valued at more than \$60,000 in the state of New Mexico, the following list addresses many of the responsibilities that are defined by statute or regulation to each project stakeholder.

Contracting Agency

- Ensure that all contractors wishing to bid on a Public Works project when the project is \$60,000 or more are actively registered with the Public Works and Apprenticeship Application (PWAA) website: <http://www.dws.state.nm.us/pwaa> (Contractor Registration) prior to bidding.
- Please submit Notice of Award (NOA) and Subcontractor List(s) to the PWAA website promptly after the project is awarded.
- Please update the Subcontractor List(s) on the PWAA website whenever changes occur.
- All sub-contractors and tiers (excluding professional services) regardless of contract amount must be listed on the Subcontractor List and must adhere to the Public Works Minimum Wage Act.
- Ninety days after project completion please go into the PWAA system and close the project. Only contracting agencies are allowed to close the project. Agents or contractors are not allowed to close projects.

General Contractor

- Provide a complete Subcontractor List and Statements of Intent (SOI) to Pay Prevailing Wages for all contractors, regardless of amount of work, to the contracting agency within 3 (three) days of award.
- Ensure that all subcontractors wishing to bid on a Public Works project have an active Contractor Registration with the Public Works and Apprenticeship Application (PWAA) website: <http://www.dws.state.nm.us/pwaa> prior to bidding when their bid will exceed \$60,000.
- Make certain the Public Works Apprentice and Training Act contributions are paid either to an approved Apprenticeship Program or to the Public Works Apprentice and Training Fund.
- Confirm the Wage Rate poster, provided in PWAA, is displayed at the job site in an easily accessible place.
- When the project has been completed, make sure the Affidavits of Wages Paid (AWP) are sent to the contracting agency.
- All subcontractors and tiers (excluding professional services) regardless of contract amount must pay prevailing wages, be listed on the Subcontractor List, and adhere to the Public Works Minimum Wage Act.



LABOR RELATIONS DIVISION
121 Tijeras Ave NE, Suite 3000
Albuquerque, NM 87102
Phone: 505-841-4400
Fax: 505-841-4424

WWW.DWS.STATE.NM.US

Subcontractor

- Ensure that all subcontractors wishing to bid on a Public Works project have an active Contractor Registration with the Public Works and Apprenticeship Application (PWAA) website: <http://www.dws.state.nm.us/pwaa> prior to bidding when their bid will exceed \$60,000.
- Make certain the Public Works Apprentice and Training Act contributions are paid either to an approved Apprenticeship Program or to the Public Works Apprentice and Training Fund.
- All subcontractors and tiers (excluding professional services) regardless of contract amount must pay prevailing wages, be listed on the Subcontractor List, and adhere to the Public Works Minimum Wage Act.

Additional Information

Reference material and forms may be found in the New Mexico Department of Workforce Solutions Public Works web pages at: <https://www.dws.state.nm.us/Labor-Relations/Labor-Information/Public-Works>.

CONTACT INFORMATION

Contact the Labor Relations Division for any questions relating to Public Works projects by email at public.works@state.nm.us or call (505) 841-4400.

DAVIS BACON ACT

General Decision Number: NM190012 03/08/2019 NM12

Superseded General Decision Number: NM20180012

State: New Mexico

Construction Type: Heavy

Counties: De Baca, Eddy, Grant, Hidalgo, Lea, Lincoln, Luna, Roosevelt, Sierra and Socorro Counties in New Mexico.

HEAVY CONSTRUCTION PROJECTS

Note: Under Executive Order (EO) 13658, an hourly minimum wage of \$10.60 for calendar year 2019 applies to all contracts subject to the Davis-Bacon Act for which the contract is awarded (and any solicitation was issued) on or after January 1, 2015. If this contract is covered by the EO, the contractor must pay all workers in any classification listed on this wage determination at least \$10.60 per hour (or the applicable wage rate listed on this wage determination, if it is higher) for all hours spent performing on the contract in calendar year 2019. If this contract is covered by the EO and a classification considered necessary for performance of work on the contract does not appear on this wage determination, the contractor must pay workers in that classification at least the wage rate determined through the conformance process set forth in 29 CFR 5.5(a)(1)(ii) (or the EO minimum wage rate, if it is higher than the conformed wage rate). The EO minimum wage rate will be adjusted annually. Please note that this EO applies to the above-mentioned types of contracts entered into by the federal government that are subject to the Davis-Bacon Act itself, but it does not apply to contracts subject only to the Davis-Bacon Related Acts, including those set forth at 29 CFR 5.1(a)(2)-(60). Additional information on contractor requirements and worker protections under the EO is available at www.dol.gov/whd/govcontracts.

Modification Number	Publication Date
0	01/04/2019
1	01/18/2019
2	02/01/2019
3	03/08/2019

ELEC0583-006 01/01/2019

HIDALGO AND LUNA COUNTIES

	Rates	Fringes
ELECTRICIAN.....	\$ 29.52	5.25% + \$7.32

* ELEC0611-002 01/01/2019

DE BACA, GRANT, LINCOLN, ROOSEVELT, SIERRA & SOCORRO COUNTIES

	Rates	Fringes
ELECTRICIAN		
ZONE 1.....	\$ 31.55	11.22

ZONE 1: Mileage calculated from the main post office in the following towns: Albuquerque-40 miles, Belen-12 miles, Carrizozo-12 miles, Clovis-12 miles, Espanola-14 miles, Farmington-6 miles, Gallup-10 miles, Las Vegas-8 miles, Los Lunas-12 miles, Portales-12 miles, Ratan-6 miles, Roswell-12 miles, Ruidoso-12 miles, Santa Fe-10 miles, Tucumcari-6 miles.

ZONE 2: Extending up to 20 miles beyond Zone 1, EXCEPT ALBURQUERQUE, shall receive 9% above Zone 1 rate.

ZONE 3: Extending up to 30 miles beyond Zone 1, EXCEPT ALBURQUERQUE, shall receive 15% above Zone 1 rate.

ZONE 4: Extending more than 30 miles beyond Zone 1, EXCEPT ALBURQUERQUE, shall receive 26% above Zone 1 rate.

* ELEC0611-006 01/01/2019

EDDY & LEA COUNTIES

	Rates	Fringes
ELECTRICIAN		
Zone A.....	\$ 31.55	11.22

Zone A shall be designated 12 miles from the Main Post Office of Artesia, Carlsbad, Hobbs and Lovington, New Mexico.

Zone B extending up to 10 miles beyond Zone A, shall receive \$0.45 above Zone A wage rate.

Zone C extending up to 28 miles beyond Zone A, shall receive \$0.60 above Zone A wage rate.

Zone D extending more than 28 miles beyond Zone A, shall receive \$0.85 above Zone A wage rate.

IRON0495-004 06/01/2018

	Rates	Fringes
IRONWORKER		
Structural.....	\$ 26.50	16.01

SUNM2009-006 09/14/2010

	Rates	Fringes
CARPENTER.....	\$ 22.26	6.20
IRONWORKER, REINFORCING.....	\$ 22.75	9.60
LABORER: Common or General.....	\$ 12.37	0.00
LABORER: Flagger.....	\$ 10.90	0.00
OPERATOR: Backhoe.....	\$ 14.03	0.00
OPERATOR: Grader/Blade.....	\$ 18.79	2.35

OPERATOR: Loader (Front End)....\$ 22.07	5.05
OPERATOR: Scraper.....\$ 14.03	0.00
PIPEFITTER.....\$ 25.64	11.31
PLUMBER.....\$ 26.27	7.69
TRUCK DRIVER: Dump Truck.....\$ 11.90	0.00
TRUCK DRIVER: Water Truck.....\$ 13.72	5.25

WELDERS - Receive rate prescribed for craft performing operation to which welding is incidental.

Note: Executive Order (EO) 13706, Establishing Paid Sick Leave for Federal Contractors applies to all contracts subject to the Davis-Bacon Act for which the contract is awarded (and any solicitation was issued) on or after January 1, 2017. If this contract is covered by the EO, the contractor must provide employees with 1 hour of paid sick leave for every 30 hours they work, up to 56 hours of paid sick leave each year. Employees must be permitted to use paid sick leave for their own illness, injury or other health-related needs, including preventive care; to assist a family member (or person who is like family to the employee) who is ill, injured, or has other health-related needs, including preventive care; or for reasons resulting from, or to assist a family member (or person who is like family to the employee) who is a victim of, domestic violence, sexual assault, or stalking. Additional information on contractor requirements and worker protections under the EO is available at www.dol.gov/whd/govcontracts.

Unlisted classifications needed for work not included within the scope of the classifications listed may be added after award only as provided in the labor standards contract clauses (29CFR 5.5 (a) (1) (ii)).

The body of each wage determination lists the classification and wage rates that have been found to be prevailing for the cited type(s) of construction in the area covered by the wage determination. The classifications are listed in alphabetical order of "identifiers" that indicate whether the particular rate is a union rate (current union negotiated rate for local), a survey rate (weighted average rate) or a union average rate (weighted union average rate).

Union Rate Identifiers

A four letter classification abbreviation identifier enclosed in dotted lines beginning with characters other than "SU" or "UAVG" denotes that the union classification and rate were prevailing for that classification in the survey. Example: PLUM0198-005 07/01/2014. PLUM is an abbreviation identifier of the union which prevailed in the survey for this classification, which in this example would be Plumbers. 0198 indicates the local union number or district council number where applicable, i.e., Plumbers Local 0198. The next number, 005 in the example, is an internal number used in processing the wage determination. 07/01/2014 is the effective date of the most current negotiated rate, which in this example is July 1, 2014.

Union prevailing wage rates are updated to reflect all rate changes in the collective bargaining agreement (CBA) governing this classification and rate.

Survey Rate Identifiers

Classifications listed under the "SU" identifier indicate that no one rate prevailed for this classification in the survey and the published rate is derived by computing a weighted average rate based on all the rates reported in the survey for that classification. As this weighted average rate includes all rates reported in the survey, it may include both union and non-union rates. Example: SULA2012-007 5/13/2014. SU indicates the rates are survey rates based on a weighted average calculation of rates and are not majority rates. LA indicates

the State of Louisiana. 2012 is the year of survey on which these classifications and rates are based. The next number, 007 in the example, is an internal number used in producing the wage determination. 5/13/2014 indicates the survey completion date for the classifications and rates under that identifier.

Survey wage rates are not updated and remain in effect until a new survey is conducted.

Union Average Rate Identifiers

Classification(s) listed under the UAVG identifier indicate that no single majority rate prevailed for those classifications; however, 100% of the data reported for the classifications was union data. EXAMPLE: UAVG-OH-0010 08/29/2014. UAVG indicates that the rate is a weighted union average rate. OH indicates the state. The next number, 0010 in the example, is an internal number used in producing the wage determination. 08/29/2014 indicates the survey completion date for the classifications and rates under that identifier.

A UAVG rate will be updated once a year, usually in January of each year, to reflect a weighted average of the current negotiated/CBA rate of the union locals from which the rate is based.

WAGE DETERMINATION APPEALS PROCESS

1.) Has there been an initial decision in the matter? This can be:

- * an existing published wage determination
- * a survey underlying a wage determination
- * a Wage and Hour Division letter setting forth a position on a wage determination matter
- * a conformance (additional classification and rate) ruling

On survey related matters, initial contact, including requests for summaries of surveys, should be with the Wage and Hour Regional Office for the area in which the survey was conducted because those Regional Offices have responsibility for the

Davis-Bacon survey program. If the response from this initial contact is not satisfactory, then the process described in 2.) and 3.) should be followed.

With regard to any other matter not yet ripe for the formal process described here, initial contact should be with the Branch of Construction Wage Determinations. Write to:

Branch of Construction Wage Determinations
Wage and Hour Division
U.S. Department of Labor
200 Constitution Avenue, N.W.
Washington, DC 20210

2.) If the answer to the question in 1.) is yes, then an interested party (those affected by the action) can request review and reconsideration from the Wage and Hour Administrator (See 29 CFR Part 1.8 and 29 CFR Part 7). Write to:

Wage and Hour Administrator
U.S. Department of Labor
200 Constitution Avenue, N.W.
Washington, DC 20210

The request should be accompanied by a full statement of the interested party's position and by any information (wage payment data, project description, area practice material, etc.) that the requestor considers relevant to the issue.

3.) If the decision of the Administrator is not favorable, an interested party may appeal directly to the Administrative Review Board (formerly the Wage Appeals Board). Write to:

Administrative Review Board
U.S. Department of Labor
200 Constitution Avenue, N.W.
Washington, DC 20210

4.) All decisions by the Administrative Review Board are final.

END OF GENERAL DECISION



ENGINEERING | SURVEYING | TESTING
 DEFINING QUALITY SINCE 1965



AlbuquerqueJournal

CUCHILLO NEGRO ARROYO BANK STABILIZATION – SIERRA COUNTY, NM

To: Sierra County, New Mexico
 From: David Roybal, P.E. – Engineering Manager
 Date: March 14, 2019
 Subject: Technical Project Description

Project Description:

The project consists of the installation of 30 feet long PZC-18 section steel sheet piles along the northeast river bank of Cuchillo Negro Arroyo located on the northwest side of NM-51 at approximately MP-1 in Truth or Consequences, NM. The location of the installation of the sheet piles shall remain above the ordinary high water mark and below the existing top of bank. The total length of the project is 520.83 feet. The beginning of project (BOP) is (N783254.44'; E1343089.46') and end of project (EOP) is (N783311.05; E1343040.25'). The placement of the sheet pile consists of four main segments to be installed in a straight line, such straight segments shall follow the curvilinear shape along the existing river bank. The segment lengths (1 through 4) are; 75 feet, 200 feet, 125 feet and 120.83 feet. There are two more 12.5 feet segments located at the BOP and EOP to corner out the ends of the project to prevent further erosion. The location of the points of intersection (PI) had been defined in the construction plans. The sheet piles are to be driven 15 feet into the ground and hold a maximum of 15 feet of retained soil on the outside of the river bank.

The project site is to be cleared and grubbed, and graded per construction plans. The project also consists of the construction of an access road. The road shall be built by furnishing the required borrow and base course type II. The length and width of the proposed access road are 552 feet and 14 feet correspondingly.

SUMMARY OF QUANTITIES				
ITEM	ITEM DESCRIPTION	UNIT	ESTIMATED QUANTITY	FINAL QUANTITY
1	MOBILIZATION	L.S.	1	
2	NPDES PROTECTION	L.S.	1	
3	CONSTRUCTION STAKING	L.S.	1	
4	CLEARING AND GRUBBING	L.S.	1	
5	PZC-18 STEEL SHEET PILING (30' LONG SHEET) COMPLETE IN PLACE	SQ. FT.	16,375	
6	EARTHWORK AND GRADING, COMPLETE IN PLACE	SQ. YD.	1,850	
7	BORROW (CONTRACTOR FURNISHED, HANDLED, HAULED, AND INSTALLED) COMPLETE IN PLACE	CU. YD.	400	
8	BASE COURSE TYPE II (CONTRACTOR FURNISHED, HANDLED, HAULED, AND INSTALLED) COMPLETE IN PLACE	CU. YD.	180	

EXHIBIT H 1 PETTIGREW PROJECT DESCRIPTION

CUCHILLO NEGRO ARROYO

**BANK STABILIZATION
SIERRA COUNTY, NEW MEXICO
DECEMBER, 2017**

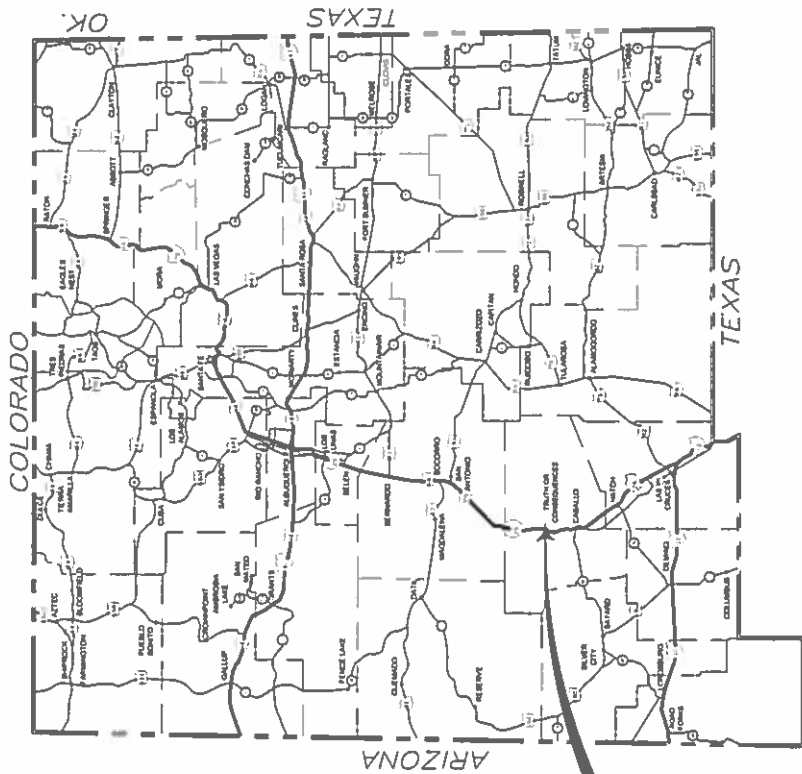

**PROJECT
LOCATION**

LOCATION MAP
NOT TO SCALE

MEXICO

FLOOD NOTE

THIS PROJECT IS LOCATED IN A "ZONE A" WITH NO BASE FLOOD ELEVATIONS AS SHOWN ON FEMA'S FIRM MAP NUMBER 500072000C WITH AN EFFECTIVE DATE OF JULY 15, 1998.



BE AWARE OF EXISTING UTILITIES AND STRUCTURES BEFORE YOU DIG. CALL 811 TO REPORT ANY UNIDENTIFIED UTILITIES OR STRUCTURES. CALL 811 AT LEAST 48 HOURS BEFORE ANY EXCAVATION. CALL 811 AT LEAST 24 HOURS BEFORE ANY EXCAVATION. CALL 811 AT LEAST 24 HOURS BEFORE ANY EXCAVATION. CALL 811 AT LEAST 24 HOURS BEFORE ANY EXCAVATION.

CONTACTS

OWNER
SIERRA COUNTY PUBLIC WORKS
100 E. MARSHALL DRIVE, SUITE 100
SIERRA COUNTY, NM 87791
(505) 748-1247
TRAVIS ATWELL, FLOOD DIRECTOR

DESIGNER
PETTIGREW & ASSOCIATES, P.A.
100 E. MARSHALL DRIVE, SUITE 100
SIERRA COUNTY, NM 87791
(505) 748-1247

ENVIRONMENTAL COMPLIANCE
MARRION AND ASSOCIATES
7111 COUTH STREET
ALBUQUERQUE, NM 87117
(505) 998-8344
HEATHER PARAMETER

LAND OWNERS

PRIVATE LANDOWNER
SANTITA E. SANCHEZ
FLEETON, TX
1805 ENDORWAY
TRUJON CONSEQUENCE, NM 87701

<p>PETTIGREW & ASSOCIATES PA 100 E. Marshall Drive, Suite 100 Sierra County, NM 87791 (505) 748-1247</p>		PROJECT NUMBER: 2016.1125 DRAWN BY:	REVISIONS NO. DATE DESCRIPTION	COVER SHEET CUCHILLO NEGRO ARROYO BANK STABILIZATION	SIERRA COUNTY FIRM NO. 000	PROJECT NUMBER 2016.1125	SHEET C-001
		PROJECT TITLE:	DATE:				

PETTIGREW ASSOCIATES PA
 1500 E. Irving Street, Suite 100, Phoenix, AZ 85016
 PHOENIX, ARIZONA 85016
 480.948.2027 • 480.948.1443
 Fax: 480.948.2028



PROJECT NUMBER: 15
 PROJECT LOCATION: Tempe, Cochise, & Pima Counties, AZ
 DRAWN BY: [Signature]

1.5" = 100' HORIZONTAL SCALE
 1" = 10' VERTICAL SCALE
 ALL DIMENSIONS UNLESS OTHERWISE NOTED ARE IN FEET AND INCHES
 ALL DIMENSIONS TO CENTERLINE UNLESS OTHERWISE NOTED

NO.	DATE	DESCRIPTION

OVERALL SITE LAYOUT AND CONTROL PLAN

CUCHILLO NEGRO ARROYO BANK STABILIZATION

SONORA COUNTY, ARIZONA
 PROJECT NUMBER: 2016.1125
 SHEET: C-002

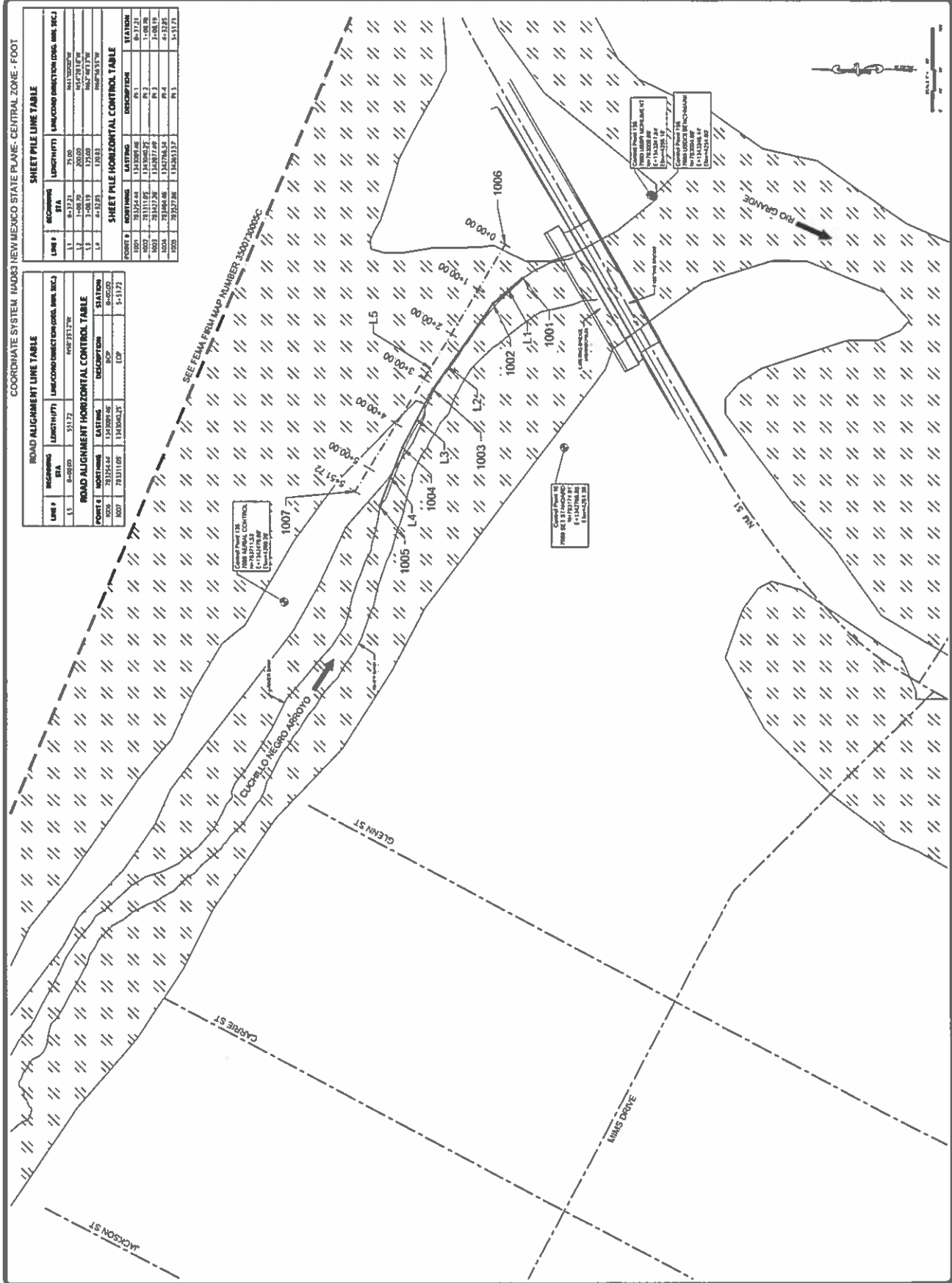

ROAD ALIGNMENT LINE TABLE

LINE #	DESCRIPTION	STA	LENGTH (FT)	LINE COMBINATION (CONV, CONV, CONV)
L1	ROAD ALIGNMENT	8+37.71	75.00	CONV, CONV, CONV
L2	ROAD ALIGNMENT	8+45.71	125.00	CONV, CONV, CONV
L3	ROAD ALIGNMENT	8+50.71	125.00	CONV, CONV, CONV
L4	ROAD ALIGNMENT	8+52.71	125.00	CONV, CONV, CONV
L5	ROAD ALIGNMENT	8+54.71	125.00	CONV, CONV, CONV
L6	ROAD ALIGNMENT	8+56.71	125.00	CONV, CONV, CONV

ROAD ALIGNMENT HORIZONTAL CONTROL TABLE

LINE #	DESCRIPTION	STATION	DESCRIPTION	STATION
L1	ROAD ALIGNMENT	8+37.71	CP 1	8+37.71
L2	ROAD ALIGNMENT	8+45.71	CP 2	8+45.71
L3	ROAD ALIGNMENT	8+50.71	CP 3	8+50.71
L4	ROAD ALIGNMENT	8+52.71	CP 4	8+52.71
L5	ROAD ALIGNMENT	8+54.71	CP 5	8+54.71
L6	ROAD ALIGNMENT	8+56.71	CP 6	8+56.71

SHEET PILE HORIZONTAL CONTROL TABLE

POINT #	DESCRIPTION	STATION	DESCRIPTION	STATION
SP 1	SHEET PILE	8+37.71	SP 1	8+37.71
SP 2	SHEET PILE	8+45.71	SP 2	8+45.71
SP 3	SHEET PILE	8+50.71	SP 3	8+50.71
SP 4	SHEET PILE	8+52.71	SP 4	8+52.71
SP 5	SHEET PILE	8+54.71	SP 5	8+54.71
SP 6	SHEET PILE	8+56.71	SP 6	8+56.71

SEE FEMA FIRM MAP NUMBER 33007-2002C

Scale: 1" = 100' HORIZONTAL, 1" = 10' VERTICAL

PETTIGREW ASSOCIATES PA
 ENGINEERING & ARCHITECTURE
 1575 300 0027 P.O. Box 1241
 Raleigh, NC



PROJECT NUMBER: 2016.1125
 PROJECT NAME: CUCHILLO NEGRO ARROYO BANK STABILIZATION

LEGEND
 --- EXISTING TO BE MAINTAINED
 --- EXISTING TO BE REMOVED
 --- PROPOSED
 --- PROPOSED WITH NOTES
 --- PROPOSED WITH NOTES AND DIMENSIONS
 --- PROPOSED WITH NOTES AND DIMENSIONS AND MATERIALS
 --- PROPOSED WITH NOTES AND DIMENSIONS AND MATERIALS AND SPECIFICATIONS
 --- PROPOSED WITH NOTES AND DIMENSIONS AND MATERIALS AND SPECIFICATIONS AND CONTRACT NOTES

TYPICAL ABBREVIATIONS
 --- EXISTING TO BE MAINTAINED
 --- EXISTING TO BE REMOVED
 --- PROPOSED
 --- PROPOSED WITH NOTES
 --- PROPOSED WITH NOTES AND DIMENSIONS
 --- PROPOSED WITH NOTES AND DIMENSIONS AND MATERIALS
 --- PROPOSED WITH NOTES AND DIMENSIONS AND MATERIALS AND SPECIFICATIONS
 --- PROPOSED WITH NOTES AND DIMENSIONS AND MATERIALS AND SPECIFICATIONS AND CONTRACT NOTES

REVISIONS

NO.	DATE	DESCRIPTION

PLAN AND PROFILE
 STA 00+00.00
 TO
 STA 5+51.72

CUCHILLO NEGRO ARROYO BANK STABILIZATION
 SERRANA COUNTY
 FARMINGTON

PROJECT NUMBER: 2016.1125
 SHEET: C-201

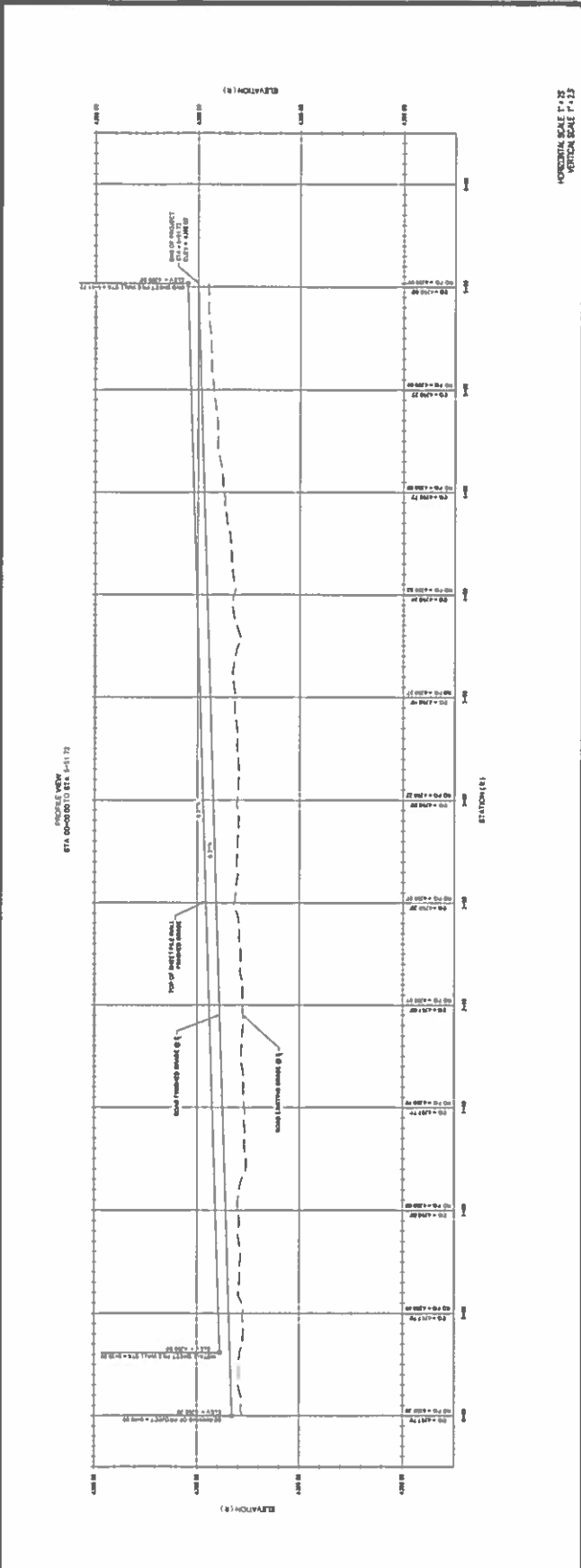
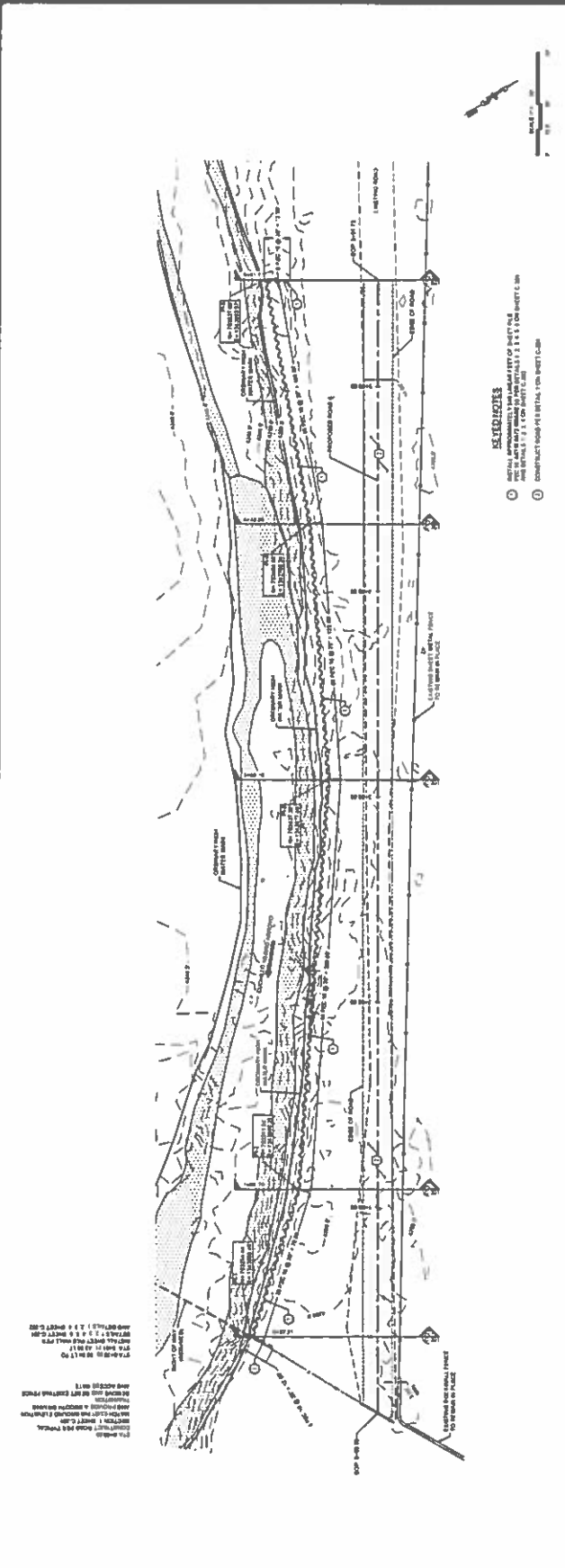



PROJECT NUMBER: 10000000000000000000
 DRAWING NUMBER: 10000000000000000000
 SHEET NUMBER: 10000000000000000000

NO.	DATE	REVISIONS	DESCRIPTION

DETAILS AND SECTIONS
CUCHILLO NEGRO ARROYO BANK STABILIZATION
 SHERIFF COUNTY, NEW MEXICO

PROJECT NUMBER: 2016.1125
 SHEET: C-301

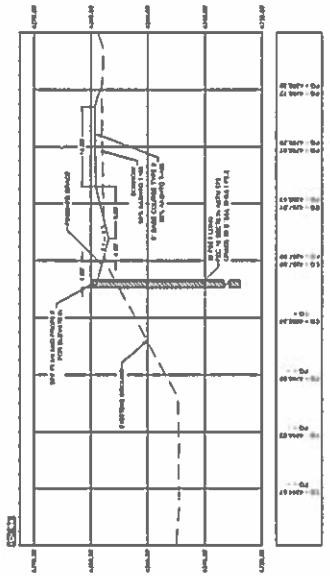

4 PI-3 CROSS SECTION
 STA-3+08.19
 SCALE 1"=10'

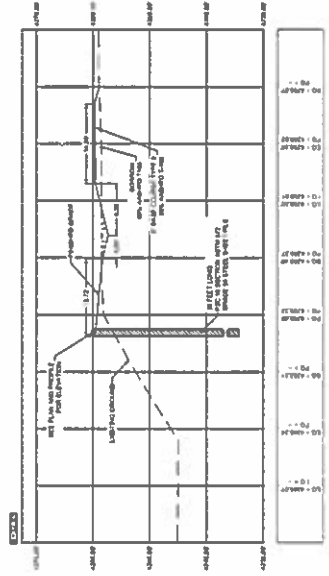

5 PI-4 CROSS SECTION
 STA-4+32.85
 SCALE 1"=10'

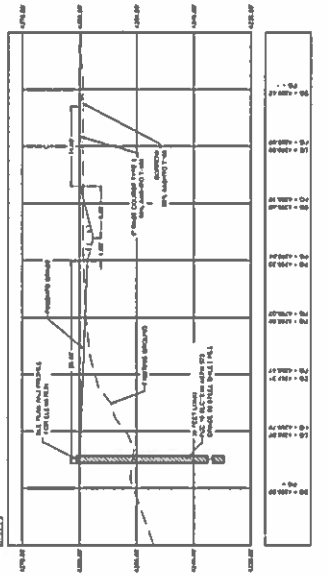

6 PI-5 CROSS SECTION
 STA-5+51.71
 SCALE 1"=10'

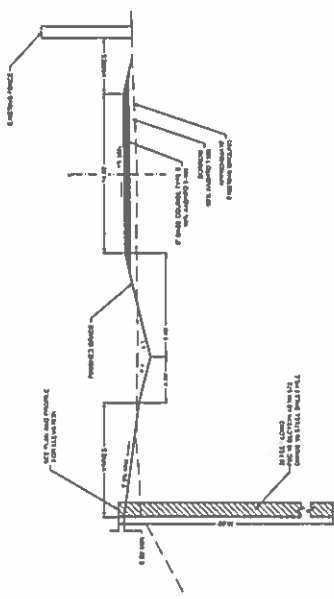

1 TYPICAL ROADWAY SECTION 1
 SCALE 1"=10'

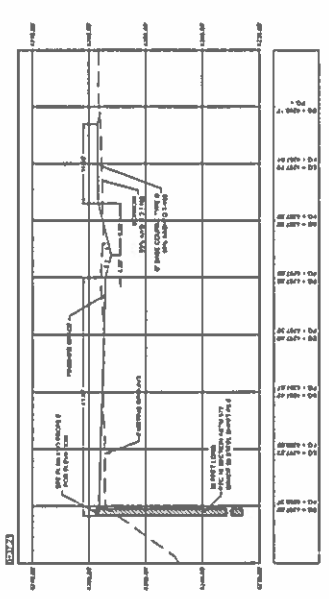

2 PI-1 CROSS SECTION
 STA-0+37.21
 SCALE 1"=10'

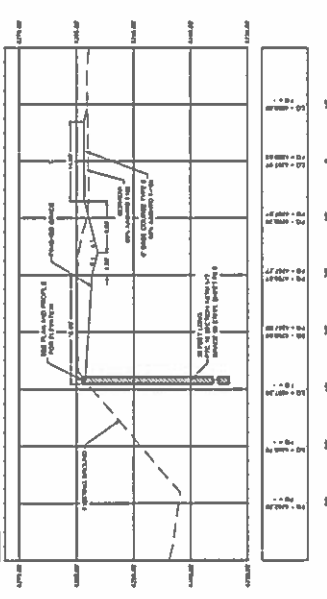

3 PI-2 CROSS SECTION
 STA-1+08.70
 SCALE 1"=10'

PETTIGREW ASSOCIATES
 Established Experts and Trusted
 Engineering Quality Since 1989
 484 E. Second Street Suite 400, Vista, CA 92083
 (619) 591-1100
 Fax: (619) 591-1101
 pettigrew.com



PROJECT NUMBER: 15-000000-01
 PRODUCT: 60620-0000-01
 DRAWING TITLE: BANK STABILIZATION

NO.	DATE	REVISIONS	DESCRIPTION

DETAILS AND SECTIONS
 CUCHILLO NEGRO ARROYO
 BANK STABILIZATION
 SERRA COUNTY
 NEW MEXICO

PROJECT NUMBER: 2016.1125
 SHEET: C-302

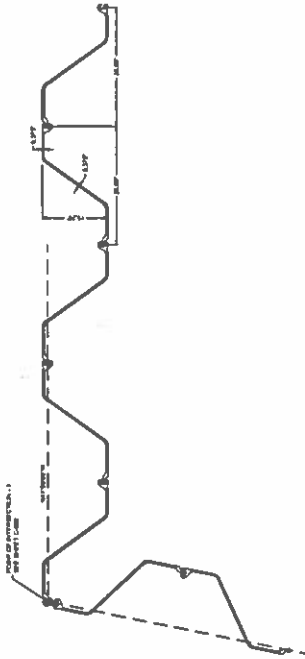

1 LAYOUT DETAIL
 PI-1

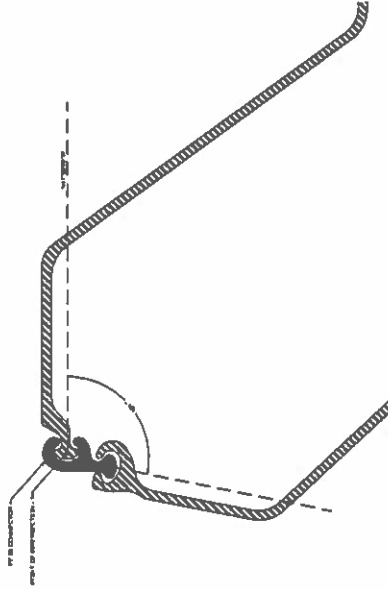

3 CONNECTOR DETAIL
 PI-1

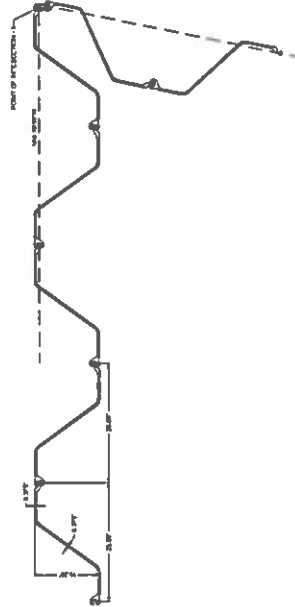

2 LAYOUT DETAIL
 PI-5

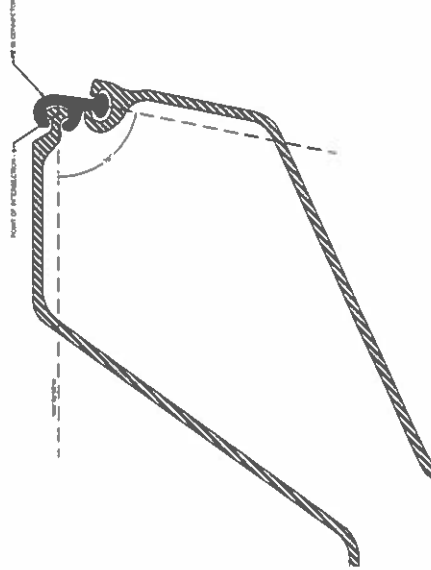

4 CONNECTOR DETAIL
 PI-5

**ITEM (S)
ITEM #1 AREA PHOTOS**

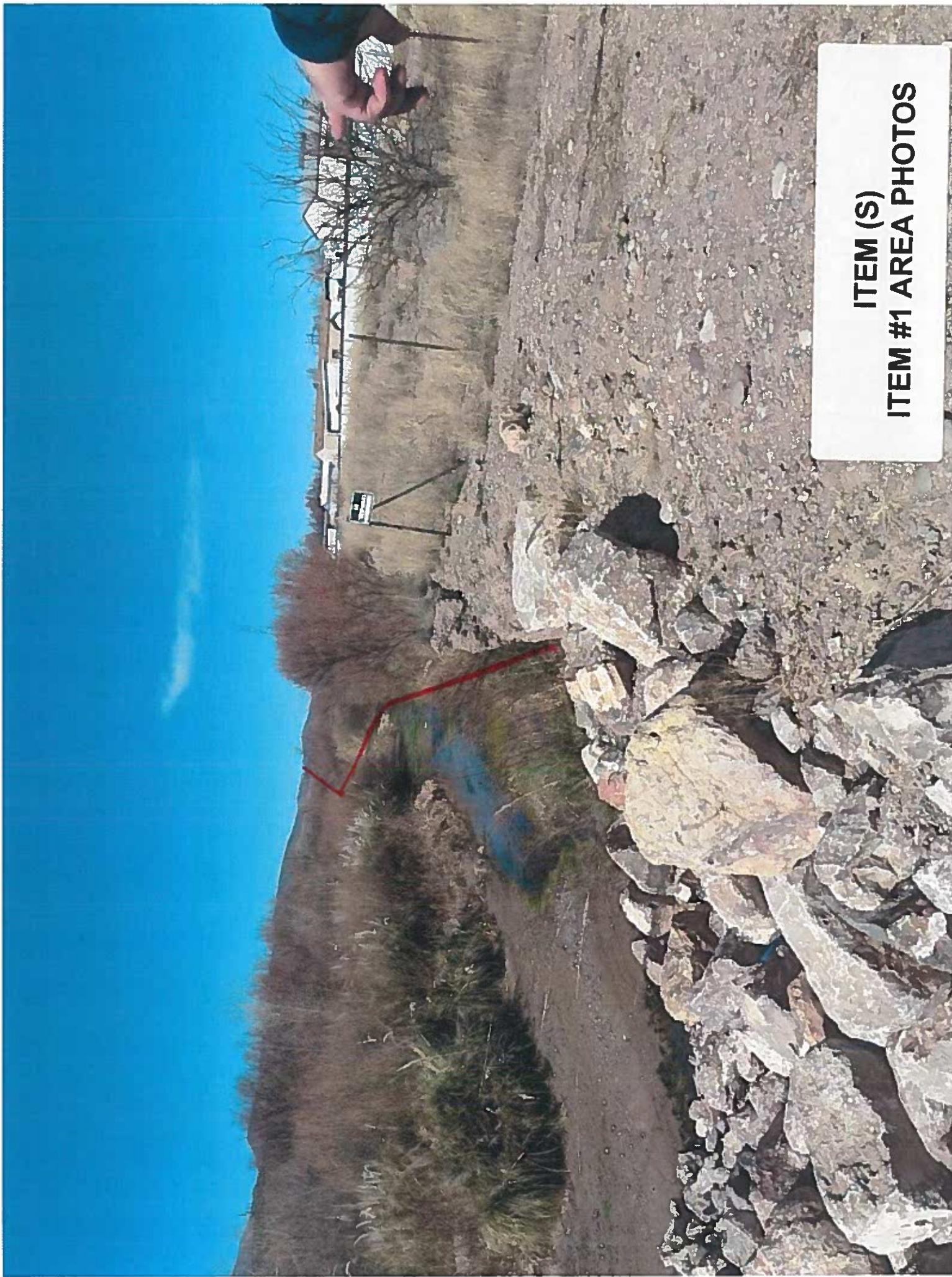

**100 FEET
AWAY FROM BRIDGE**

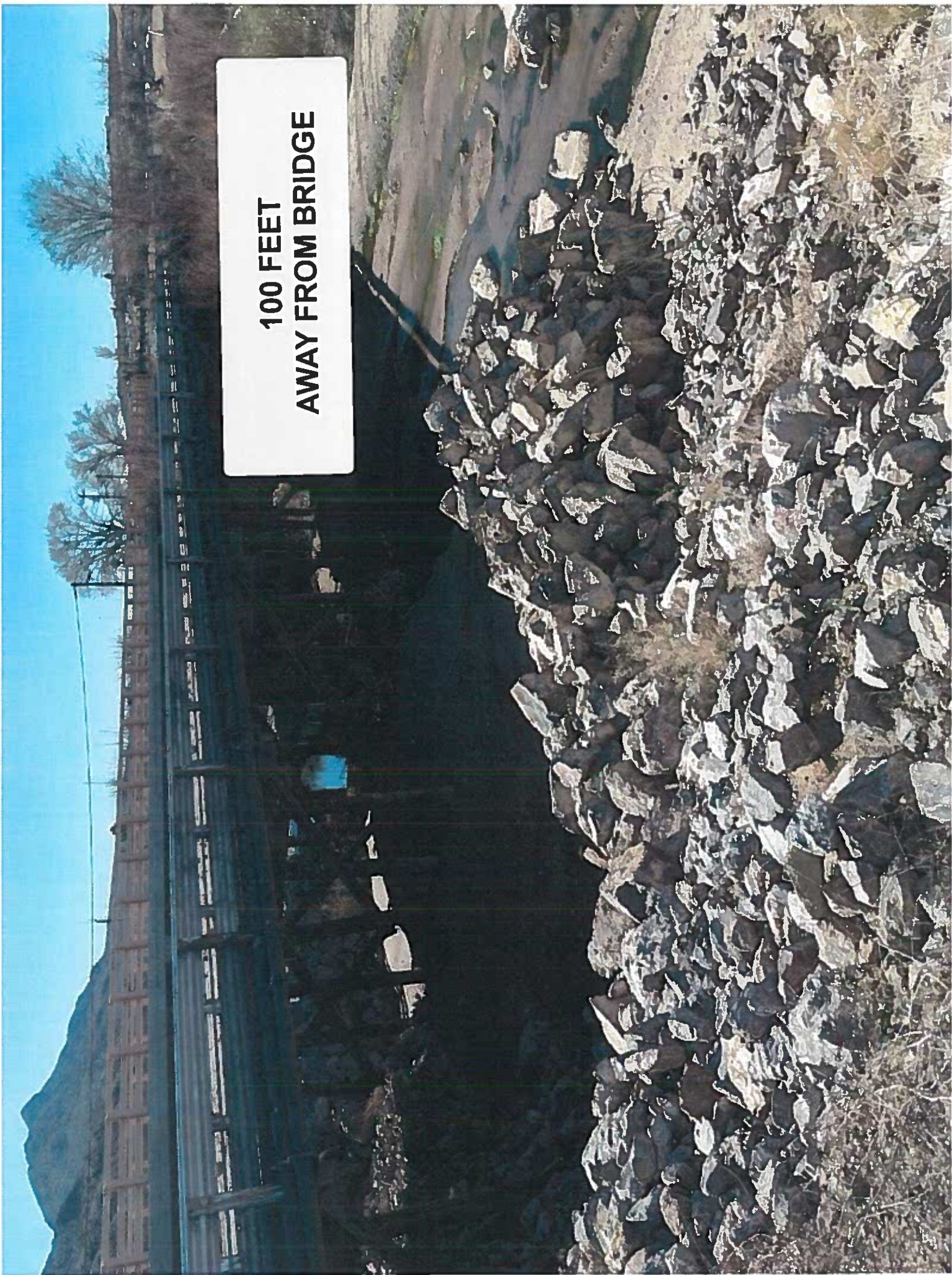

**100 FEET
AWAY FROM BRIDGE**

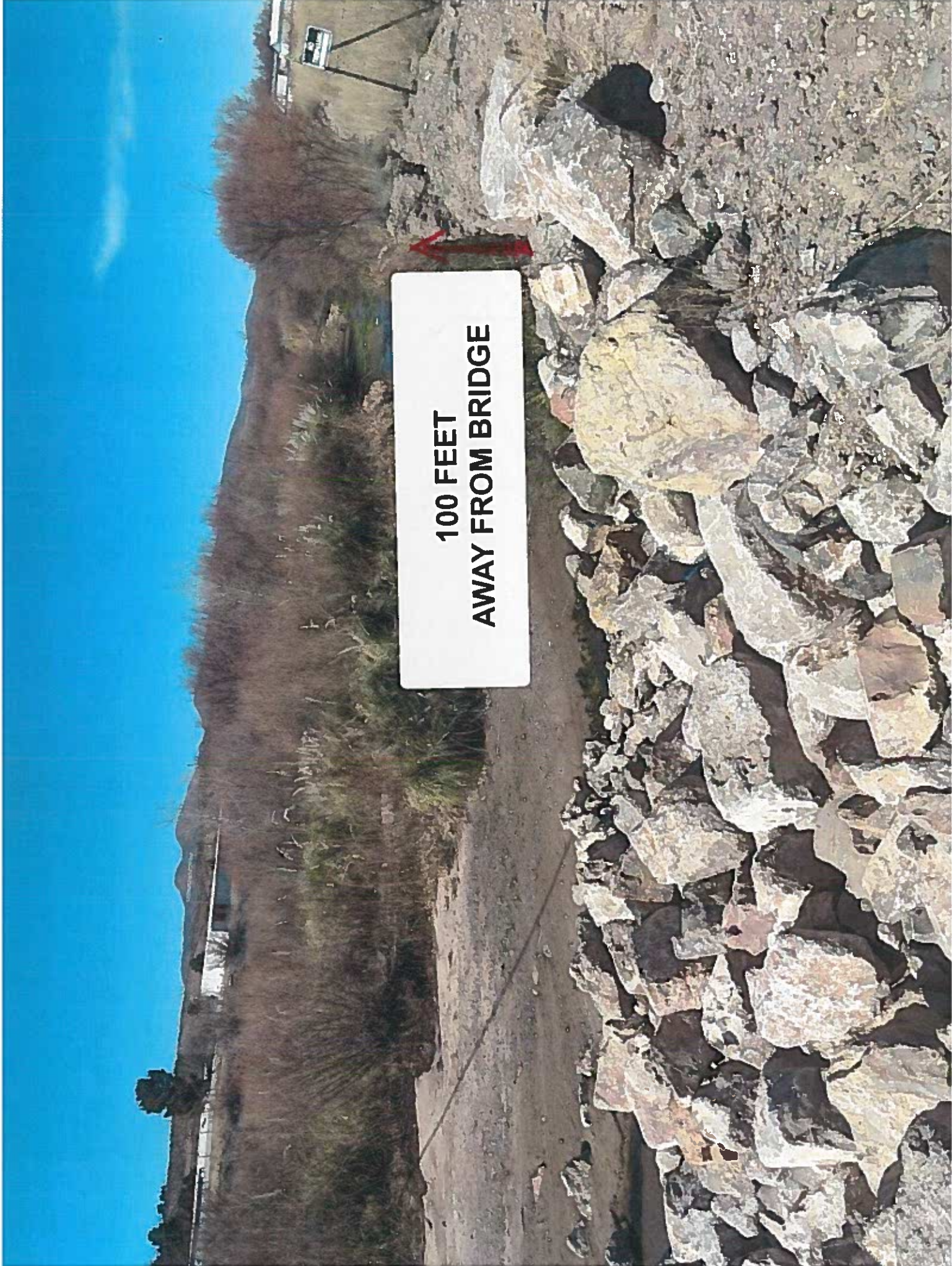

**SHEET PILING
ENGINEER MARKED**

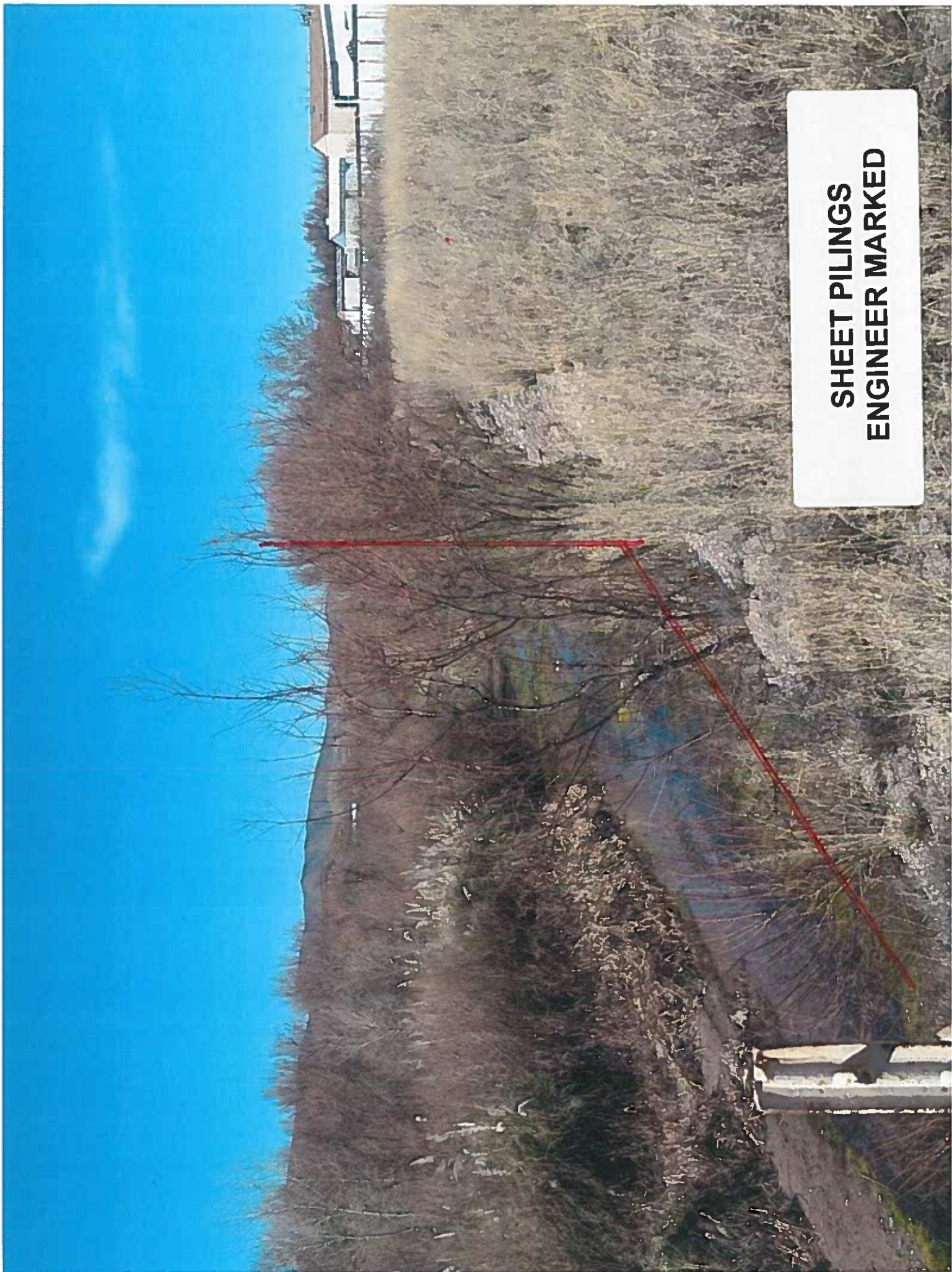



**DOT CULTURAL RESEARCH
SURVEY
NON-NATIVE VEGETATION**



