



Village of Buffalo Grove

Smartwater Zone Meter Install

Bid and Contract Documents

Finance Department
9/18/2019

TABLE OF CONTENTS

INVITATION TO BID2

INSTRUCTIONS TO BIDDERS.....3

EXHIBIT A - PUBLIC CONTRACT STATEMENT.....6

EXHIBIT B - SCHEDULE OF PRICES7

EXHIBIT C – REFERENCE LIST10

EXHIBIT D – IDOT AFFIDAVIT.....11

DESCRIPTION OF THE WORK.....13

SMARTWATER ZONE METER INSTALL CONTRACT1

 CONTRACT EXHIBIT A- DESCRIPTION OF WORK13

 CONTRACT EXHIBIT B- SCHEDULE OF PRICES.....14

 CONTRACT EXHIBIT C - FORM OF PERFORMANCE and PAYMENT BOND15

 CONTRACT EXHIBIT D – PARTIAL LIEN WAIVER16

 CONTRACT EXHIBIT E- FINAL LIEN WAIVER.....17

INVITATION TO BID

Smartwater Zone Meter Install

This project consists of the installation of 2-inch saddles and 2-inch water main taps in five existing water system valve vaults and the installation of new vaults over existing water main followed by 2-inch saddles and 2-inch taps in the water main in the new vaults in five locations throughout the Village of Buffalo Grove.

PREVAILING WAGE ACT - The Village is an Illinois unit of local government and the Work hereunder is subject to the Illinois Prevailing Wage Act, 820 ILCS 130/0.01, et seq.

For information on how to receive a copy of the Bid Package and any addenda contact the Office of the Purchasing Manager at 847-459-2500 or visit the Village of Buffalo Grove procurement website at www.vbg.org/bids

TIMELINE

Wednesday, October 2, 2019	Due date for all questions regarding the Work ("Question Due Date")
Wednesday, October 9, 2019	Bid Proposals due to the Village ("Bid Due Date")
Monday, October 21, 2019	Village Board Meeting ("Estimated Award Date")

INSTRUCTIONS TO BIDDERS

QUESTIONS ON THE WORK

All comments, concerns and questions regarding the Work and these documents shall be addressed to the Village of Buffalo Grove Purchasing Manager via email at BGfinance@vbg.org with the subject line “Smartwater Zone Meter Install”. All comments, concerns and questions regarding the Work must be received by the **9:30 AM CST** on the Question Due Date (defined above).

BID PROPOSAL DOCUMENTS

Each bidder must submit **two copies** of the following documents (collectively, the “**Bid Proposal**”):

1. Executed and notarized Public Contract Statement set forth on **Exhibit A**;
2. Completed Schedule of Prices set forth on **Exhibit B**;
3. Completed Reference List set forth on **Exhibit C**;
4. Completed IDOT Affidavit of Availability set forth on **Exhibit D**;
5. A list of the requested changes to the Contract citing the specific Article within the Contract and the specific change requested.

BID SECURITY

Along with the Bid Proposal, each bidder must submit with its Bid Proposal a bank draft, cashier’s check, certified check or bid bond equal to at least ten percent (10%) of the Total Contract Price, as set forth in their Schedule of Prices (the “**Bid Security**”).

BID SUBMITTAL

Sealed Bid Proposals shall be delivered to the Village at the Office of the Village Clerk at 50 Raupp Boulevard, Buffalo Grove, Illinois 60089 on or before **9:30 AM** local time on the Bid Due Date. Each bidder shall deliver their Bid Proposal along with their Bid Security in a sealed envelope or box. The envelope or box shall be labeled with the Bidder’s name and be marked or endorsed:

VoBG-2019-35a Bid for Village of Buffalo Grove, Illinois

Smartwater Zone Meter Install

NO WITHDRAWAL OF BIDS

No Bid Proposal shall be withdrawn after the Bid Due Date without the consent of the Village for a period of sixty (60) calendar days after the Bid Due Date.

QUALIFICATION OF BIDDERS

It is the intention of the Village to award the Work only to a bidder who furnishes satisfactory evidence that they have the requisite qualifications, capital, experience, facilities and ability to complete the Work successfully, promptly, and within the time frame set forth in these documents.

The Village reserves the right to make such investigations as it deems necessary to determine the qualifications and ability of any bidder. To that extent, all bidders agree to furnish to the Village any information and data requested by the Village in its investigation. Failure of a bidder to provide any information or data requested by the Village in its investigation will be grounds to reject that bidder from consideration for the Work.

INSTRUCTIONS TO BIDDERS

1. Bidders must inform themselves of all the conditions under which the Work is to be performed including, but not limited to, and where applicable, the structural integrity of the building, the conditions of the ground, building codes. No extra compensation will be given to any bidder who fails to apprise themselves of the conditions under which the Work is to be performed.
2. All changes requested by a bidder to the Contract must be submitted with their Bid Proposal.
3. Bidders shall be responsible, at their own expense, for all permits, business licenses and other licenses which may be required to complete the Work and required by local, county, state or federal government.
4. All Bidders are prohibited from making any contact with the Village President, Trustees, or any other official or employee of the Village (collectively, "Municipal Personnel") with regard to the work, other than in the manner and to the person(s) designated herein. The Village Manager reserves the right to disqualify any Service Provider that is found to have contacted Municipal Personnel in any manner with regard to the work. Additionally, if the Village Manager determines that the contact with Municipal Personnel was in violation of any provision of 720 ILCS 5/33E, the matter will be turned over to the Cook County State's Attorney for review and prosecution.
5. In submitting this Bid, Bidder represents that:
 - A. Bidder has examined and carefully studied the Bidding Documents, and any data and reference items identified in the Bidding Documents
 - B. Bidder has visited the Site, conducted a thorough, alert visual examination of the Site and adjacent areas, and become familiar with and satisfied itself as to the general, local, and Site conditions that may affect cost, progress, and performance of the Work.
 - C. Bidder is familiar with and is satisfied as to all Laws and Regulations that may affect cost, progress, and performance of the Work.
 - D. Bidder has considered the information known to Bidder; information commonly known to contractors doing business in the locality of the Site; information and observations obtained from visits to the Site; the Bidding Documents; and the Site-related reports and drawings identified in the Bidding Documents, with respect to the effect of such information, observations, and documents on (1) the cost, progress, and performance of the Work; (2) the means, methods, techniques, sequences, and procedures of construction to be employed by Bidder, including applying the specific means, methods, techniques, sequences, and procedures of construction expressly required by the Bidding Documents; and (3) Bidder's safety precautions and programs.

E. Based on the information and observations referred above, Bidder does not consider that any further examinations, investigations, explorations, tests, studies, or data are necessary for the determination of this Bid for performance of the Work at the price(s) bid and within the times required and in accordance with the other terms and conditions of the Bidding Documents.

F. Bidder has given the Village written notice of all conflicts, errors, ambiguities, or discrepancies that Bidder has discovered in the Bidding Documents, and the written resolution thereof by Village is acceptable to Bidder.

G. The Bidding Documents are generally sufficient to indicate and convey understanding of all terms and conditions for performance of the Work for which this Bid is submitted.

H. The submission of this Bid constitutes an incontrovertible representation by Bidder that Bidder has complied with every requirement of this Article, and that without exception the Bid and all prices in the Bid are premised upon performing and furnishing the Work required by the Bidding Documents.

RESERVATION OF RIGHTS

The Village reserves the following rights regarding the bidding process:

1. The right to accept the Bid Proposal that is, in the Village's sole judgment, the best and most favorable to the interests of the Village and the public.
2. To reject the lowest bidder.
3. To accept any item or any portion in any Bid Proposal from any bidder.
4. To accept and incorporate corrections, clarifications or modifications following the Bid Due Date when doing so would not, in the Village's opinion, prejudice the procurement process or create any improper advantage to any bidder.
5. To waive irregularities and informalities in the procurement process or in any Bid Proposal; provided, however, that the waiver of any prior defect or informality shall not be considered a waiver of any future or similar defects or informalities, and bidders shall not rely upon, or anticipate, such waivers in submitting their Bid Proposal.
6. To disqualify any bidder that is found to have contacted the Village's personnel in any manner with regard to the Work.
7. The right to approve or disapprove of any or all subcontractors, or insist on no subcontractors, in connection with any Bid Proposal.
8. Reject any subcontractor from working on the Work if they are not listed in the Bid Proposal.
9. The Village shall hold the Bid Security from the two (2) lowest bidders until the Contract is signed for the Work.
10. Disqualify any bidder who requests changes to the Contract when such changes were not submitted with their Bid Proposal.

EVALUATION CRITERIA

Bidders shall understand that the bids shall be evaluated and final selection will be based upon both the lowest Total Base Bid and a prompt Project Completion Date. Cost shall be weighted at 80% and Project Completion Date 20%

EXHIBIT A - PUBLIC CONTRACT STATEMENT

This Public Contract Statement (the “**Contract Statement**”) has been executed by the below supplier, contractor or vendor (collectively the “**Contractor**”) in order for the Village of Buffalo Grove to obtain certain information necessary prior to awarding a public contract. The Contract Statement shall be executed and notarized and submitted as part of the Bid Proposal.

CERTIFICATION OF CONTRACTOR/BIDDER

In order to comply with 720 Illinois Compiled Statutes 5/33 E-1 et seq., the Village of Buffalo Grove requires the following certification be acknowledged:

The Contractor certifies that it is not barred from bidding or supplying any goods, services or construction let by the Village of Buffalo Grove with or without bid, due to any violation of either Section 5/33 E-3 or 5/33 E-4 of Article 33E, Public Contracts, of the Chapter 720 of the Illinois Compiled Statutes, as amended. This act relates to interference with public contracting, bid rigging and rotating, kickbacks, and bidding.

CERTIFICATION RELATIVE TO 65 ILCS 5/11-42.1.1

In order to comply with 65 Illinois Compiled Statutes 5/11-42.1.1, the Village of Buffalo Grove requires the following certification:

The Contractor does hereby swear and affirm that it is not delinquent in the payment of any tax administered by the Illinois Department of Revenue unless it is contesting such tax in accordance with the procedures established by the appropriate revenue act, its liability for the tax or the amount of the tax. The undersigned further understands that making a false statement herein: (1) is a Class A misdemeanor, and (2) voids the contract and allows the Village to recover all amounts paid to it under the contract.

CONFLICT OF INTEREST

The Village of Buffalo Grove Municipal Code requires the following verification relative to conflict of interest and compliance with general ethics requirements of the Village:

The Contractor represents and warrants to the Village of Buffalo Grove as a term and condition of acceptance of their Bid Proposal that none of the following Village officials is either an officer or director of Contractor nor owns five percent (5%) or more of the Contractor: the Village President, the members of the Village Board of Trustees, the Village Clerk, the Village Treasurer, the members of the Zoning Board of Appeals and the Plan Commission, the Village Manager and his/her Assistant, or the heads of the various departments within the Village.

If the foregoing representation and warranty is inaccurate, state the name of the Village official who either is an officer or director of your business entity or owns five percent (5%) or more thereof:

_____.

IN WITNESS WHEREOF, the below Contractor has signed and sealed this Contract Statement as of this ____ day of _____, 20____.

Print Name of Contractor

Signature

Print Title

Given under my hand and official seal, this ____ day of _____, 20____.

Notary Public

EXHIBIT B - SCHEDULE OF PRICES

Name of Bidder:

Address of Bidder:

City _____ State _____ Zip _____

Telephone _____

Email Address: _____

The Bidder declares, represents and warrants that it has read and agrees to abide by the terms, conditions and obligations set forth in the Invitation to Bid. In particular, the Bidder declares, represents and warrants that it has informed itself of all the conditions under which the Work is to be performed including, but not limited to, and where applicable, the conditions of the ground and building codes. Bidder waives any right to additional compensation for failure to make itself aware of the afore-mentioned conditions.

Bidder further declares that if their Bid Proposal is accepted, that Bidder will enter into the Contract in the same form as set forth in the Bid and Contract Documents. However, Bidder may request changes to the Contract by submitting with this Schedule of Prices a list of requested changes to the Contract.

If this bid is accepted, and the undersigned fails to (i) contract as aforesaid, (ii) provide the Performance Bond required by the Contract, and (iii) provide all insurance required under the Contract within fifteen (15) calendar days after the date of the award of the Contract then the Village, at its option, may determine that the bidder has abandoned this Bid, and thereupon this Bid and the acceptance thereof shall be null and void, and such security accompanying this Bid shall be forfeited and shall be the property of the Village of Buffalo Grove not as penalty, but as liquidated damages.

BID SECURITY

Accompanying this Bid is a _____

in the amount of _____ Dollars

(\$ _____).

Note: (a) Insert the words “Bank Draft”, “Cashier’s Check”, “Certified Check” or “Bid Bond”, as the case may be.

(b) Amount must be equal to at least **ten percent (10%)** of the Total Base Bid.

EXHIBIT B - SCHEDULE OF PRICES (cont.)

Schedule of Prices				
Item	Description	Estimated Quantity	Unit	Extended Price
1	M1-1 INSTALL OWNER FURNISHED SADDLE AND 2" TAP	1	Lump Sum	
2	M1-2 INSTALL OWNER FURNISHED SADDLE AND 2" TAP	1	Lump Sum	
3	M2-1 INSTALL OWNER FURNISHED SADDLE AND 2" TAP	1	Lump Sum	
4	M2-2 INSTALL NEW VAULT AND OWNER FURNISHED SADDLE WITH 2" TAP	1	Lump Sum	
5	M2-3 INSTALL NEW VAULT AND OWNER FURNISHED SADDLE WITH 2" TAP	1	Lump Sum	
6	M2-4 INSTALL NEW VAULT AND OWNER FURNISHED SADDLE WITH 2" TAP	1	Lump Sum	
7	M3-1 INSTALL OWNER FURNISHED SADDLE AND 2" TAP	1	Lump Sum	
8	M3-2 INSTALL NEW VAULT AND OWNER FURNISHED SADDLE WITH 2" TAP	1	Lump Sum	
9	M3-3 INSTALL NEW VAULT AND OWNER FURNISHED SADDLE WITH 2" TAP	1	Lump Sum	
10	M3-4 INSTALL OWNER FURNISHED SADDLE AND 2" TAP	1	Lump Sum	
A. Total Base Bid				

A. TOTAL BASE BID

_____ Dollars (\$_____).

B. PROJECT FINAL COMPLETION DATE

EXHIBIT B - SCHEDULE OF PRICES (cont.)

SUBCONTRACTOR LISTING

Bidder, to employ the following listed subcontractors for the following enumerated classes of work and is not to alter or add to such list without the written consent of the Village.

	<u>SUBCONTRACTOR</u>	<u>CLASS OF WORK</u>
1.	_____	_____
2.	_____	_____
3.	_____	_____
4.	_____	_____

ACKNOWLEDGEMENT OF ADDENDA

Acknowledgement of receipt of Addenda(s) _____ (list each addendum number)

Attach each signed addendum, if any, to the bid packet as part of your submittal.

CONTRACTOR SIGNATURE and CONTACT INFORMATION

Date

Phone

Legal Entity

E-mail

(Sign here)

(Print Name)

EXHIBIT C – REFERENCE LIST

Contact Name: _____

Municipality/Business: _____

Dates Employed: _____ to _____

Phone Number or E-mail address: _____

Contact Name: _____

Municipality/Business: _____

Dates Employed: _____ to _____

Phone Number or E-mail address: _____

Contact Name: _____

Municipality/Business: _____

Dates Employed: _____ to _____

Phone Number or E-mail address: _____

Contact Name: _____

Municipality/Business: _____

Dates Employed: _____ to _____

Phone Number or E-mail address: _____



Illinois Department of Transportation

Bureau of Construction
2300 South Dirksen Parkway/Room 322
Springfield, Illinois 62764

Exhibit D.

**Affidavit of Availability
For the Letting of _____**

Instructions: Complete this form by either typing or using black ink. "Authorization to Bid" will not be issued unless both sides of this form are completed in detail. Use additional forms as needed to list all work.

Part I. Work Under Contract

List below all work you have under contract as either a prime contractor or a subcontractor. It is required to include all pending low bids not yet awarded or rejected. In a joint venture, list only that portion of the work which is the responsibility of your company. The uncompleted dollar value is to be based upon the most recent engineer's or owners estimate, and must include work subcontracted to others. If no work is contracted, show **NONE**.

	1	2	3	4	Awards Pending	
Contract Number						
Contract With						
Estimated Completion Date						
Total Contract Price						Accumulated Totals
Uncompleted Dollar Value if Firm is the Prime Contractor						
Uncompleted Dollar Value if Firm is the Subcontractor						
Total Value of All Work						

Part II. Awards Pending and Uncompleted Work to be done with your own forces.

List below the uncompleted dollar value of work for each contract and awards pending to be completed with your own forces. All work subcontracted to others will be listed on the reverse of this form. In a joint venture, list only that portion of the work to be done by your company. If no work is contracted, show **NONE**.

						Accumulated Totals
Earthwork						
Portland Cement Concrete Paving						
HMA Plant Mix						
HMA Paving						
Clean & Seal Cracks/Joints						
Aggregate Bases & Surfaces						
Highway, R.R. and Waterway Structures						
Drainage						
Electrical						
Cover and Seal Coats						
Concrete Construction						
Landscaping						
Fencing						
Guardrail						
Painting						
Signing						
Cold Milling, Planning & Rotomilling						
Demolition						
Pavement Markings (Paint)						
Other Construction (List)						
						\$ 0.00
Totals						

Disclosure of this information is **REQUIRED** to accomplish the statutory purpose as outlined in the "Illinois Procurement Code." Failure to comply will result in non-issuance of an "Authorization To Bid." This form has been approved by the State Forms Management Center.

Part III. Work Subcontracted to Others.

For each contract described in Part I, list all the work you have subcontracted to others.

	1	2	3	4	Awards Pending
Subcontractor					
Type of Work					
Subcontract Price					
Amount Uncompleted					
Subcontractor					
Type of Work					
Subcontract Price					
Amount Uncompleted					
Subcontractor					
Type of Work					
Subcontract Price					
Amount Uncompleted					
Subcontractor					
Type of Work					
Subcontract Price					
Amount Uncompleted					
Subcontractor					
Type of Work					
Subcontract Price					
Amount Uncompleted					
Subcontractor					
Type of Work					
Subcontract Price					
Amount Uncompleted					
Subcontractor					
Type of Work					
Subcontract Price					
Amount Uncompleted					
Subcontractor					
Type of Work					
Subcontract Price					
Amount Uncompleted					
Total Uncompleted					

I, being duly sworn, do hereby declare that this affidavit is a true and correct statement relating to ALL uncompleted contracts of the undersigned for Federal, State, County, City and private work, including ALL subcontract work, ALL pending low bids not yet awarded or rejected and ALL estimated completion dates.

Subscribed and sworn to before me
 this _____ day of _____, _____ Type or Print Name _____
 Officer or Director Title

 Notary Public
 My commission expires _____
 (Notary Seal)
 Signed _____
 Company _____
 Address _____

DESCRIPTION OF THE WORK

The work services, equipment, labor and/or materials below shall be collectively referred to as the “Work”:

This project consists of the installation of 2-inch saddles and 2-inch water main taps in five existing water system valve vaults and the installation of new vaults over existing water main followed by 2-inch saddles and 2-inch taps in the water main in the new vaults in five locations throughout the Village of Buffalo Grove.

The following Drawings titled “Water Distribution Flow Meter Installations - Smart Water Pilot Program” dated August 2019 describe the project and are included in the Contract:

SHEET 1	TITLE SHEET
SHEET 2	INDEX OF SHEETS / STANDARDS
SHEET 3	OVERALL SITE MAP / GENERAL NOTES
SHEET 4	INSERTION SADDLE AND VALVE VAULT DETAILS
SHEET 5	SADDLE DETAILS
SHEET 6 to 17	INSTALLATION LOCATIONS
SHEET 18	CONSTRUCTION DETAILS - 1
SHEET 19	CONSTRUCTION DETAILS - 2
SHEET 20	MATERIAL SPECIFICATIONS

WATER DISTRIBUTION FLOW METER INSTALATIONS - SMART WATER PILOT PROGRAM

FOR THE VILLAGE OF BUFFALO GROVE LAKE AND COOK COUNTIES, ILLINOIS AUGUST, 2019



BUFFALO GROVE,
IL

AREA MAP
NO SCALE

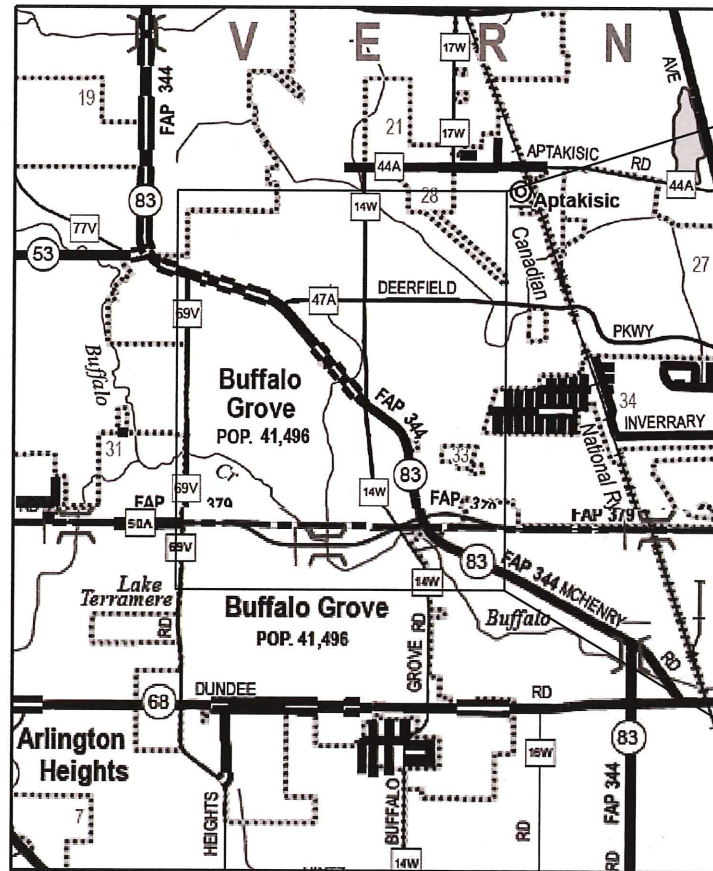
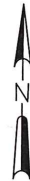

REGIONAL MAP
NO SCALE

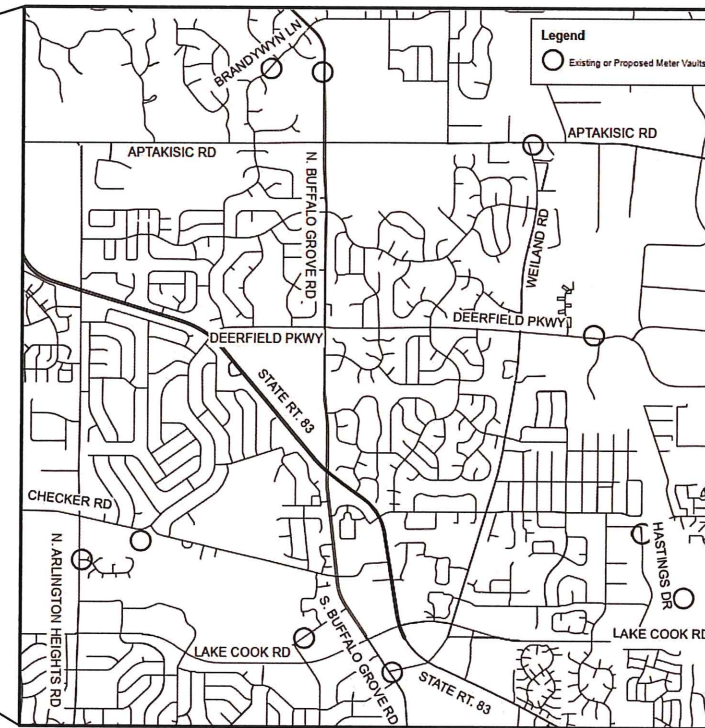
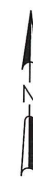

PROJECT LOCATION MAP
NO SCALE

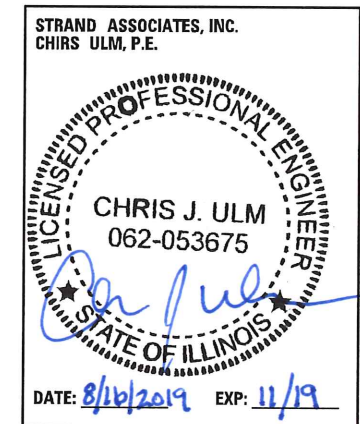

PROJECT LOCATION:
VARIOUS LOCATIONS IN THE
VILLAGE OF BUFFALO GROVE, IL

TOWNSHIP 42 NORTH AND TOWNSHIP 43
NORTH, RANGE 11 EAST OF THE THIRD
PRINCIPLE MERIDIAN.



TO OBTAIN LOCATION OF
PARTICIPANTS' UNDERGROUND
FACILITIES BEFORE YOU
DIG IN ILLINOIS

CALL J.U.L.I.E.
1-800-892-0123
TOLL FREE

REQUIRES MIN. OF 48 HOURS
NOTICE BEFORE YOU EXCAVATE.
(EXCLUDING SAT., SUN., & HOL.)

1170 SOUTH HOUBOLT ROAD
JOLIET, IL 60431
815 744-4200
815 744-4215 FAX
www.strand.com
IDFPR NO. 184-001273



ISSUED FOR BIDDING, 08/16/2019

SHEET
1
JOB NO. 1307.003

INDEX OF SHEETS

- 1 TITLE SHEET
- 2 INDEX OF SHEETS / STANDARDS
- 3 OVERALL SITE MAP / GENERAL NOTES
- 4 INSERTION SADDLE AND VALVE VAULT DETAILS
- 5 SADDLE DETAILS
- 6 - 17 INSTALLATION LOCATIONS
- 18 CONSTRUCTION DETAILS - 1
- 19 CONSTRUCTION DETAILS - 2
- 20 MATERIAL SPECIFICATIONS

IDOT HIGHWAY STANDARDS

- 000001-07 STANDARD SYMBOLS, ABBREVIATIONS AND PATTERNS
- 442201-03 CLASS C AND D PATCHES
- 602506-01 PRECAST VALVE VAULT TYPE A 5' (1.52 M) DIAMETER
- 602601-06 PRECAST REINFORCED CONCRETE FLAT SLAB TOP
- 602701-02 MANHOLE STEPS
- 604001-04 FRAME AND LIDS TYPE 1
- 604051-04 FRAME AND GRATE TYPE 11
- 604056-04 FRAME AND GRATE TYPE 11V
- 606001-07 CONCRETE CURB TYPE B AND COMBINATION CONCRETE CURB AND GUTTER
- 701001-02 OFF-RD OPERATIONS, 2L, 2W, MORE THAN 15' (4.5 M) AWAY
- 701006-05 OFF-RD OPERATIONS, 2L, 2W, 15' (4.5 M) TO 24" (600 MM) FROM PAVEMENT EDGE
- 701101-05 OFF-RD OPERATIONS, MULTILANE, 15' (4.5 MM) TO 24" (600 MM) FROM PAVEMENT EDGE
- 701106-02 OFF-RD OPERATIONS, MULTILANE, MORE THAN 15' (4.5 MM) AWAY
- 701301-04 LANE CLOSURE, 2L, 2W, SHORT TIME OPERATIONS
- 701801-06 SIDEWALK, CORNER OR CROSSWALK CLOSURE
- 701901-08 TRAFFIC CONTROL DEVICES

DISTRICT ONE STANDARD DETAILS

- BD-22 PAVEMENT PATCHING FOR HMA SURFACED PAVEMENT
- BD-24 CURB OR CURB AND GUTTER REMOVAL AND REPLACEMENT
- BD-32 BUTT JOINTS AND HMA TAPER
- TC-10 TRAFFIC CONTROL AND PROTECTION FOR SIDE ROADS, INTERSECTIONS AND DRIVEWAYS

DATE:									
REVISIONS									
NO.									

WORK SCOPE AND SITE SUMMARY TABLE

SITE ID	APPROXIMATE LOCATION	WORK SCOPE	PIPE SIZE (IN.)	PIPE MATERIAL	YEAR	USING EXISTING VAULT?	EXISTING VALVE TYPE	SHEET	PAY ITEM	UNIT	OPTIONAL LOCATION?
M1-1	BRANDYWYN LN BETWEEN DOVER CT AND BIRCHWOOD LN	INSTALL SADDLE WITH 2" TAP IN EXISTING VALVE VAULT	12	DI	1989	YES	GATE VALVE	6, 7	INSTALL OWNER FURNISHED SADDLE AND 2" TAP	LUMP SUM	YES
M1-2	N. BUFFALO GROVE RD BETWEEN BRANDYWYN LN AND CHURCHILL	INSTALL SADDLE WITH 2" TAP IN EXISTING VALVE VAULT	16	DI	2000	YES	BUTTERFLY VALVE	8, 9	INSTALL OWNER FURNISHED SADDLE AND 2" TAP	LUMP SUM	YES
M2-1	APTAKISIC RD AND WEILAND RD	INSTALL SADDLE WITH 2" TAP IN EXISTING VALVE VAULT	16	DI	1994	YES	BUTTERFLY VALVE	10	INSTALL OWNER FURNISHED SADDLE AND 2" TAP	LUMP SUM	NO
M2-2	DEERFIELD PKWY BETWEEN WINDBROOKE DR AND COMMERCE CT	INSTALL NEW VAULT AND SADDLE WITH 2" TAP ON EXISTING WATER MAIN	16	DI	1989	NO	N/A	11	INSTALL NEW VAULT AND OWNER FURNISHED SADDLE	LUMP SUM	NO
M2-3	760 HASTINGS DR	INSTALL NEW VAULT AND SADDLE WITH 2" TAP ON EXISTING WATER MAIN	12	DI	1982	NO	N/A	12	INSTALL NEW VAULT AND OWNER FURNISHED SADDLE	LUMP SUM	NO
M2-4	EAST SIDE OF PARKING LOT OF 151 HASTINGS DR	INSTALL NEW VAULT AND SADDLE WITH 2" TAP ON EXISTING WATER MAIN	12	DI	1982	NO	N/A	13	INSTALL NEW VAULT AND OWNER FURNISHED SADDLE	LUMP SUM	NO
M3-1	N. ARLINGTON HEIGHTS RD AND AUBURN LN	INSTALL SADDLE WITH 2" TAP IN EXISTING VALVE VAULT	20	DI	1977	YES	BUTTERFLY VALVE	14	INSTALL OWNER FURNISHED SADDLE AND 2" TAP	LUMP SUM	NO
M3-2	316 CHECKER DR	INSTALL NEW VAULT AND SADDLE WITH 2" TAP ON EXISTING WATER MAIN	12	DI	1977	NO	N/A	15	INSTALL NEW VAULT AND OWNER FURNISHED SADDLE	LUMP SUM	NO
M3-3	CHURCH RD BETWEEN RAUPP BLVD AND MANCHESTER DR	INSTALL NEW VAULT AND SADDLE WITH 2" TAP ON EXISTING WATER MAIN	10	DI	1977	NO	N/A	16	INSTALL NEW VAULT AND OWNER FURNISHED SADDLE	LUMP SUM	NO
M3-4	S. BUFFALO GROVE RD AND APTAKISIC RD	INSTALL SADDLE WITH 2" TAP IN EXISTING VALVE VAULT	12	DI	1976	YES	GATE VALVE	17	INSTALL OWNER FURNISHED SADDLE AND 2" TAP	LUMP SUM	NO

INDEX OF SHEETS / STANDARDS
 WATER DISTRIBUTION FLOW METER INSTALLATIONS
 VILLAGE OF BUFFALO GROVE
 LAKE AND COOK COUNTIES, ILLINOIS

JOB NO.
 1307.003
PROJECT MGR.
 CHIRS ULM



SHEET
 2

GENERAL NOTES

1. ANY REFERENCE OF A STANDARD IN THESE DRAWINGS SHALL BE TAKEN TO MEAN THE LATEST EDITION OF THE CITED STANDARD.
2. LOCATION AND ELEVATION OF THE VARIOUS UNDERGROUND UTILITIES AS SHOWN ON THE DRAWINGS ARE APPROXIMATE. CONTRACTOR SHALL VERIFY ALL UTILITIES IN THE FIELD TO DETERMINE EXACT HORIZONTAL AND VERTICAL LOCATIONS AND NOTIFY ALL UTILITY COMPANIES PRIOR TO BEGINNING CONSTRUCTION ACTIVITY.
3. AT NO TIME DOES THE CONTRACTOR HAVE PERMISSION OR AUTHORITY TO ENTER OR DISTURB PROPERTY OUTSIDE OF EXISTING RIGHT-OF-WAY OR EASEMENT.
4. NO TRENCH OR EXCAVATION IS TO BE LEFT OPEN OVERNIGHT OR OVER A HOLIDAY, WEEKEND, OR AFTER 3:00 P.M. ON THE DAY PRECEDING A HOLIDAY OR WEEKEND.
5. CONTRACTOR SHALL CLEAN SITE OF CONSTRUCTION DEBRIS DAILY TO THE SATISFACTION OF THE LOCAL MUNICIPALITY AND OWNER.
6. THE CONTRACTOR SHALL PROTECT ALL EXISTING UTILITIES AND BE RESPONSIBLE FOR THE REPAIR AND/OR REPLACEMENT OF ALL UTILITIES DAMAGED OR IMPACTED BY CONSTRUCTION ACTIVITY.
7. NO OPEN BURNING OF CONSTRUCTION DEBRIS SHALL BE ALLOWED WITHOUT A PROPER PERMIT.
8. NO CHEMICALS, FUELS, LUBRICANTS, BITUMINOUS MATERIAL, RAW SEWAGE, TREES, BRUSH, OR DEBRIS FROM DEMOLITION OR EXCAVATION ACTIVITIES SHALL BE DISCHARGED OR DISPOSED OF INTO OR ALONGSIDE ANY STREAM, WATERCOURSE, FLOOD PLAIN, OR WETLAND UNDER ANY CIRCUMSTANCES.
9. CONTRACTOR SHALL ERECT AND MAINTAIN REQUIRED TRAFFIC CONTROL IN CONFORMANCE WITH THE MANUAL OF UNIFORM TRAFFIC CONTROL DEVICES - LATEST EDITION.
10. DRAINAGE TILE BROKEN OR DAMAGED IN THE CONSTRUCTION OF THE PROPOSED VAULTS SHALL BE REPLACED FOR A DISTANCE OF TWO FEET ON EACH SIDE OF THE TRENCH WITH A SOLID PIPE OF THE SAME SIZE. THE REPLACEMENT PIPE SHALL BE INSTALLED WITH PEA GRAVEL OR ANY OTHER SUITABLE GRANULAR BACKFILL FROM THE BOTTOM OF THE TRENCH TO SIX INCHES ABOVE THE TOP OF THE REPLACEMENT PIPE AND ONE FOOT EACH WAY FROM THE CENTERLINE OF THE REPLACEMENT PIPE ALONG THE TRENCH. IN ALL CASES, THE REPAIR OF THE DRAINAGE TILE SHALL BE TO THE SATISFACTION OF THE OWNER.
11. CONTRACTOR IS RESPONSIBLE FOR REPLACING ANY AND ALL PAVEMENTS SCARRED/MARRED/CRACKED OR OTHERWISE DAMAGED BY ANY ACTIVITY FOR THE ENTIRE LENGTH OF THE PROJECT.

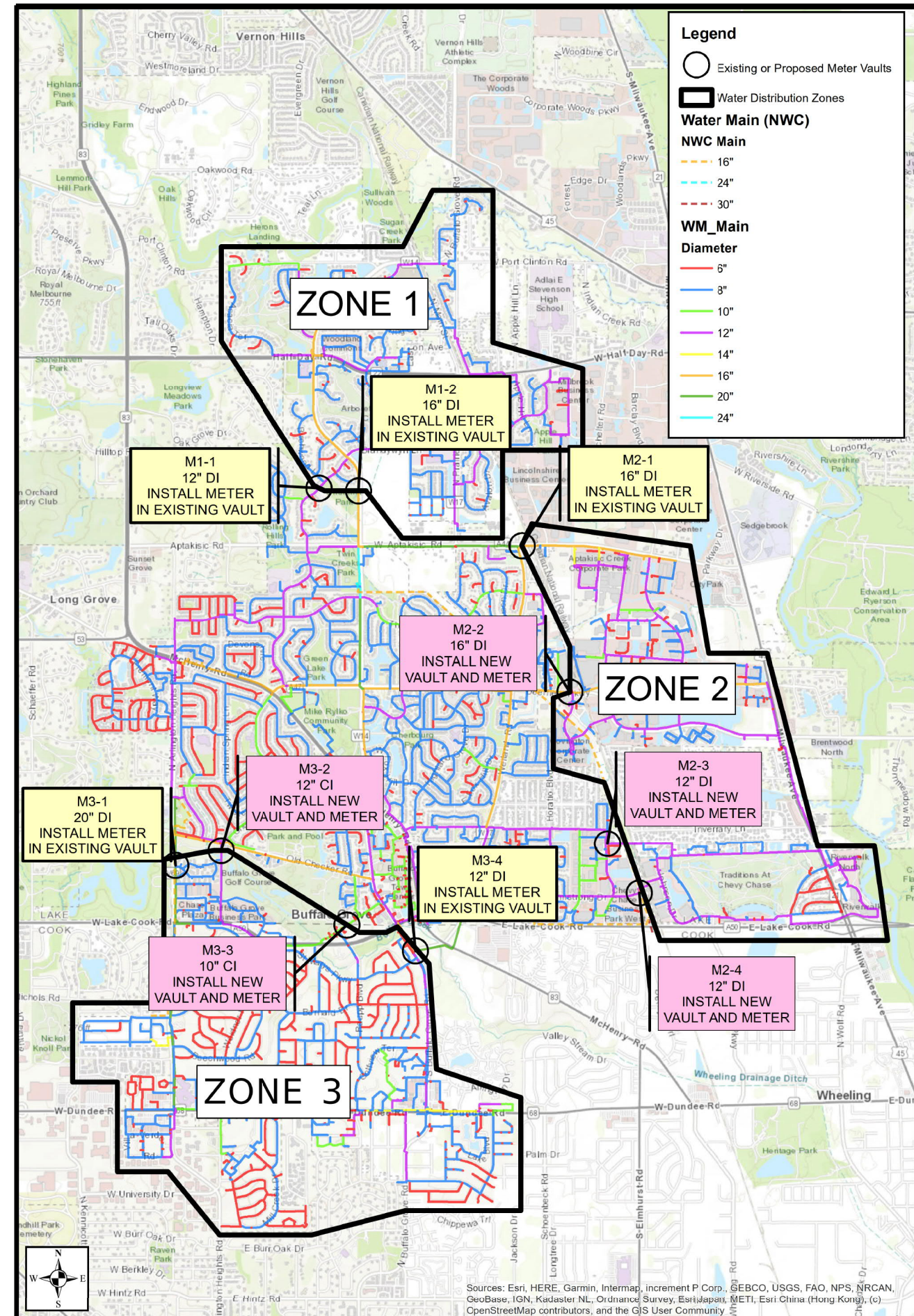

NO.	REVISIONS	DATE

OVERALL SITE MAP / GENERAL NOTES

WATER DISTRIBUTION FLOW METER INSTALLATIONS
VILLAGE OF BUFFALO GROVE
LAKE AND COOK COUNTIES, ILLINOIS

JOB NO.
1307.003
PROJECT MGR.
CHRIS ULM



SHEET
3

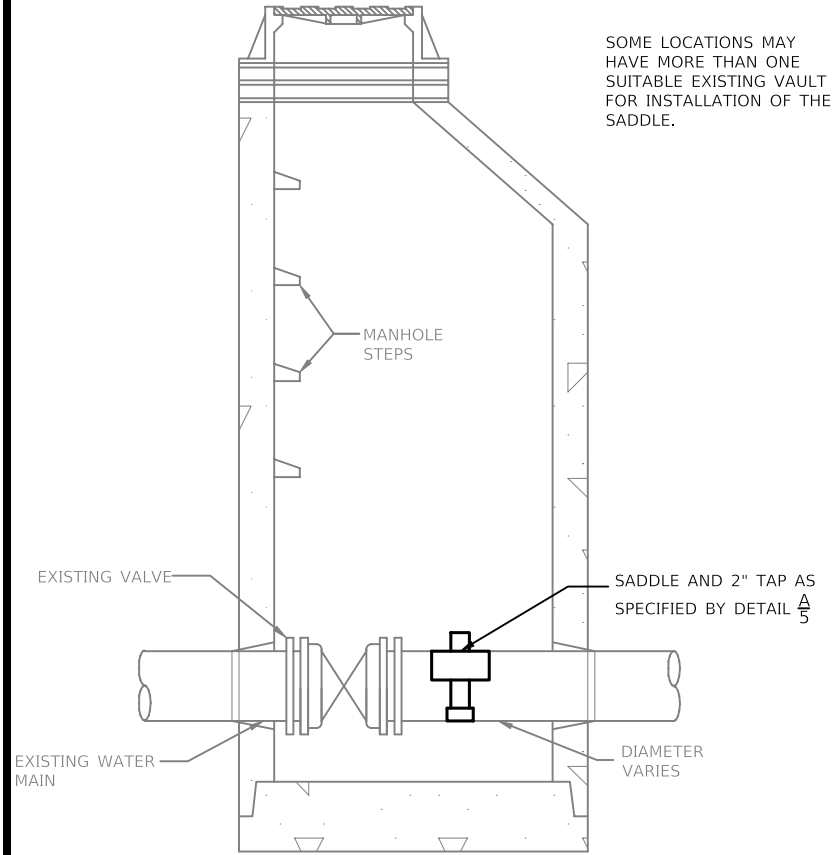

SOME LOCATIONS MAY HAVE MORE THAN ONE SUITABLE EXISTING VAULT FOR INSTALLATION OF THE SADDLE.

A
4 EXISTING VALVE VAULT WITH NEW SADDLE

NOT TO SCALE

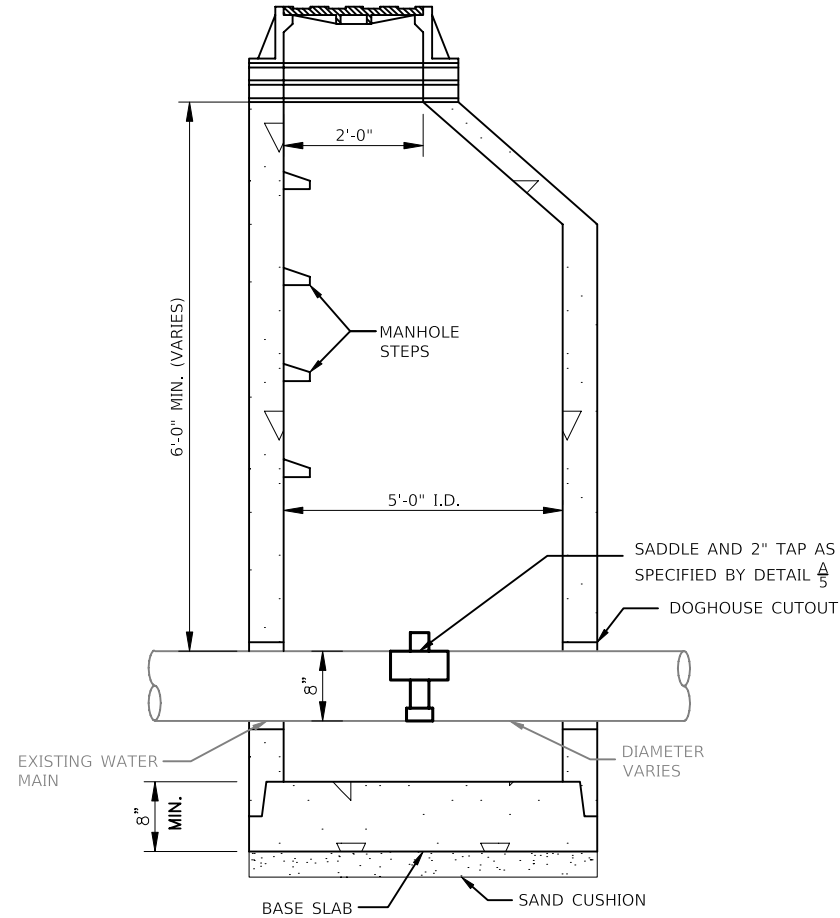

B
4 NEW VALVE VAULT AND SADDLE

NOT TO SCALE

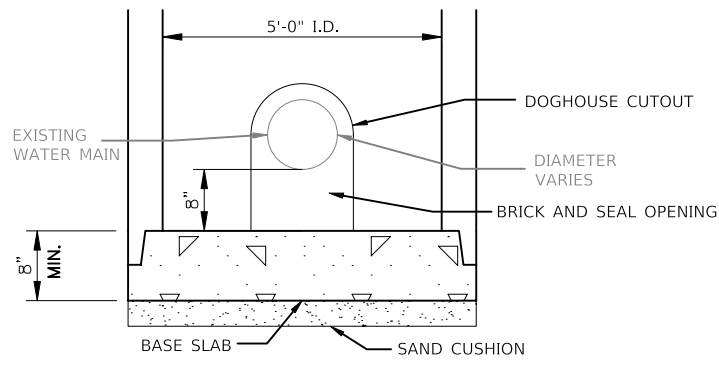

C
4 DOGHOUSE CUTOUT

NOT TO SCALE

- NOTES:**
1. NEW VAULTS SHALL BE INSTALLED IN LOCATIONS SHOWN ON THE DRAWINGS.
 2. VARIATION IN DIMENSIONS AND DESIGN MAY BE PERMISSIBLE PROVIDING EQUIVALENT CAPACITY AND STRENGTH ARE ATTAINED.
 3. NEW VAULTS SHALL FOLLOW THE VILLAGE OF BUFFALO GROVE MATERIAL SPECIFICATIONS AS SHOWN ON SHEET 20.
 4. NEW VAULTS SHALL BE PRECAST ACCORDING TO IDOT HIGHWAY STANDARD 602506-01 PRECAST VALVE VAULT TYPE A 5' (1.52 M) DIAMETER.
 5. PRECAST REINFORCED CONCRETE MANHOLE RISERS AND TOPS SHALL CONFORM TO ASTM C-478.
 6. STEPS SHALL BE INSTALLED IN ALL MANHOLES. MANHOLE STEPS SHALL BE NEENAH TYPE R-1981-N, MA INDUSTRIES NO. PS-4, OR EQUAL, 1'-4" O.C. AND COMPLIANT WITH IDOT HIGHWAY STANDARD 602701-02 MANHOLE STEPS.
 7. MANHOLE COVER SHALL BE NEENAH TYPE R-1772 WITH TYPE B NON-ROCKING LID AND EMBOSSED AS SHOWN ON SHEET 19.
 8. DETAILS RELATIVE TO ITEMS SHOWN ON THIS DRAWING SHALL CONFORM TO THE PERTINENT REQUIREMENTS OF THE SPECIFICATIONS.
 9. FLAT SLAB TOPS IF REQUIRED SHALL BE DESIGNED FOR H-20 TRUCK LOADING AND SHALL MEET REQUIREMENTS OF ASTM C-478.
 10. BASE SLABS SHALL BE REINFORCED AS FOLLOWS. REINFORCING SHALL BE PLACED IN EACH DIRECTION AT 2" CLEAR FROM TOP SURFACE OF SLAB. REINFORCING SHALL BE GRADE 60. USE OF CAST-IN-PLACE SLAB SHALL NOT RELIEVE CONTRACTOR OF REQUIREMENTS TO PROVIDE WATERTIGHT JOINTS.

INSIDE DIA.	DEPTH	REINF.
4'	≤ 30'	#3@8"
5'	≤ 20'	#3@8"
5'	20'-30'	#4@10"
6'	≤ 20'	#4@8"
6'	20'-25'	#4@8"
6'	25'-30'	#4@6"

DATE:					

NO.	REVISIONS

INSERTION SADDLE AND VALVE VAULTS DETAILS

 WATER DISTRIBUTION FLOW METER INSTALLATIONS
 VILLAGE OF BUFFALO GROVE
 LAKE AND COOK COUNTIES, ILLINOIS

JOB NO.
 1307.003
PROJECT MGR.
 CHIRS ULM



SHEET
 4

UNIVERSAL SHUT-OFF SADDLE

For steel, ductile iron and asbestos cement pipes



Design features

- For under pressure drilling
- Can be pressure tested from both directions
- Solid body
- Flexible padded wrap around strap for easy installation
- Favorable angle of contact
- Optimum force transfer of the strap screw connection through strap and cylinder disks as bolt contact area
- The saddle seal is moulded to fit the pipe diameter and is prefixed in the saddle body
- All internal threads are fitted with a corrosion protection ring to prevent corrosion and incrustations

No. 3800

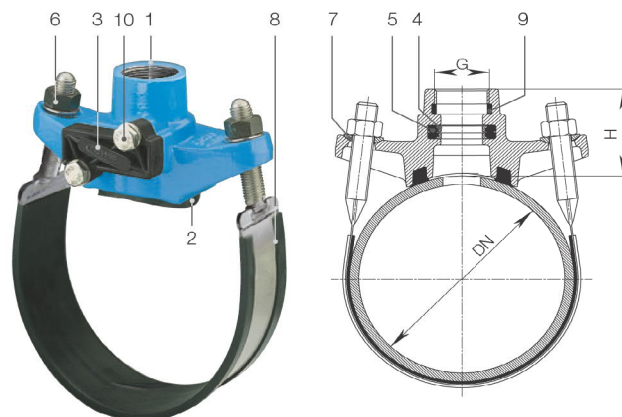

Material | Technical features

- 1 **Saddle body** made of ductile iron, epoxy powder-coated
- 2.5 **Saddle seal and seal** for intermediate shut-off made of elastomer
- 3 **Cover** made of POM, fiber glass reinforced (with rubber seal)
- 4 **O-ring carrier** made of POM
- 6 **Nuts** made of stainless steel (Molybdenum-coated)
- 7 **Ball disc** made of stainless steel
- 8 **Strap** of passivated stainless steel, strength 1,5 with insulating elastomer **rubber padding**
- 9 **Corrosion protection ring** made of elastomer
- 10 **Hexagonal screws and washers** made of stainless steel
 - Drilling instructions (see page I 3/1)

Order No.	Internal thread ISO 228	MOP (PN)	Dimension/DN														
			50	65	80	100	125	150	200	250	300	350	400	450	500	600	
3800	1"	16															
	1 1/4"																
	1 1/2"																
	2"																

Please specify pipe material on order

Application examples

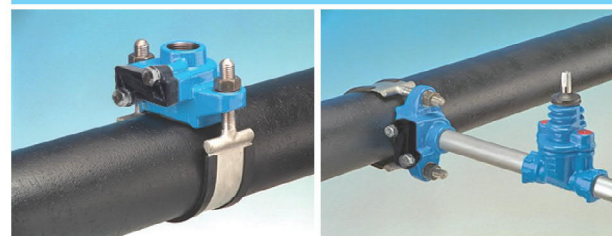

Suitable accessories

- Drilling machine:** No. 5800, No. 5805
- Saddle blade:** No. 8401

Order No.	Internal thread ISO 228 G	Dimension/DN														
		50	65	80	100	125	150	200	250	300	350	400	450	500	600	
3800	1"	Weight	2,10	2,10	2,10	2,70	3,10	3,20	4,00	4,60	4,70	7,00			8,00	8,60
		H	67	68	69	69	70	70	80	82	82	78			78	78
	1 1/4"	Weight	2,10	2,10	2,70	2,70	2,75	3,30	4,10	4,70	4,70				8,00	
		H	70	71	72	72	73	73	80	82	82				78	
	1 1/2"	Weight			3,00	3,00	3,60	3,70	4,30	4,90	4,90	7,00	7,40		8,10	9,00
		H			73	73	74	74	80	82	82	78	78		78	78
	2"	Weight			3,10	3,10	3,00	3,80	4,60	5,30	5,40	7,70	8,00	8,30	8,60	9,00
		H			78	78	78	78	81	83	83	78	78	78	78	78

Design features

- For shut-off saddles and shut-off adapters
- For under pressure drilling

Saddle blade No. 8401



Order No.		Size	Weight
8401	Model I:	For saddle 1" - 1 1/4"	0,20
	Model II:	For saddle 1 1/2" - 2"	0,25

DATE:					

REVISIONS				

NO.				

SADDLE DETAILS

WATER DISTRIBUTION FLOW METER INSTALLATIONS
VILLAGE OF BUFFALO GROVE
LAKE AND COOK COUNTIES, ILLINOIS

JOB NO.
1307.003
PROJECT MGR.
CHIRS ULM



SHEET
5



www.iplgroup.com

IPL group, Slane Road, Drogheda, Co. Louth, Ireland. Tel: +353 41 9832591 | Fax: +353 41 9832599 | Email: info@ipl.ie | Website: www.iplgroup.com

All illustrations, technical data, dimensions (in mm) and weights (all weights specified in kg) are non-binding. Subject to change.

Edition 11.2016

A
5 OWNER FURNISHED SHUT-OFF SADDLE

B
5 OWNER FURNISHED SADDLE BLADE

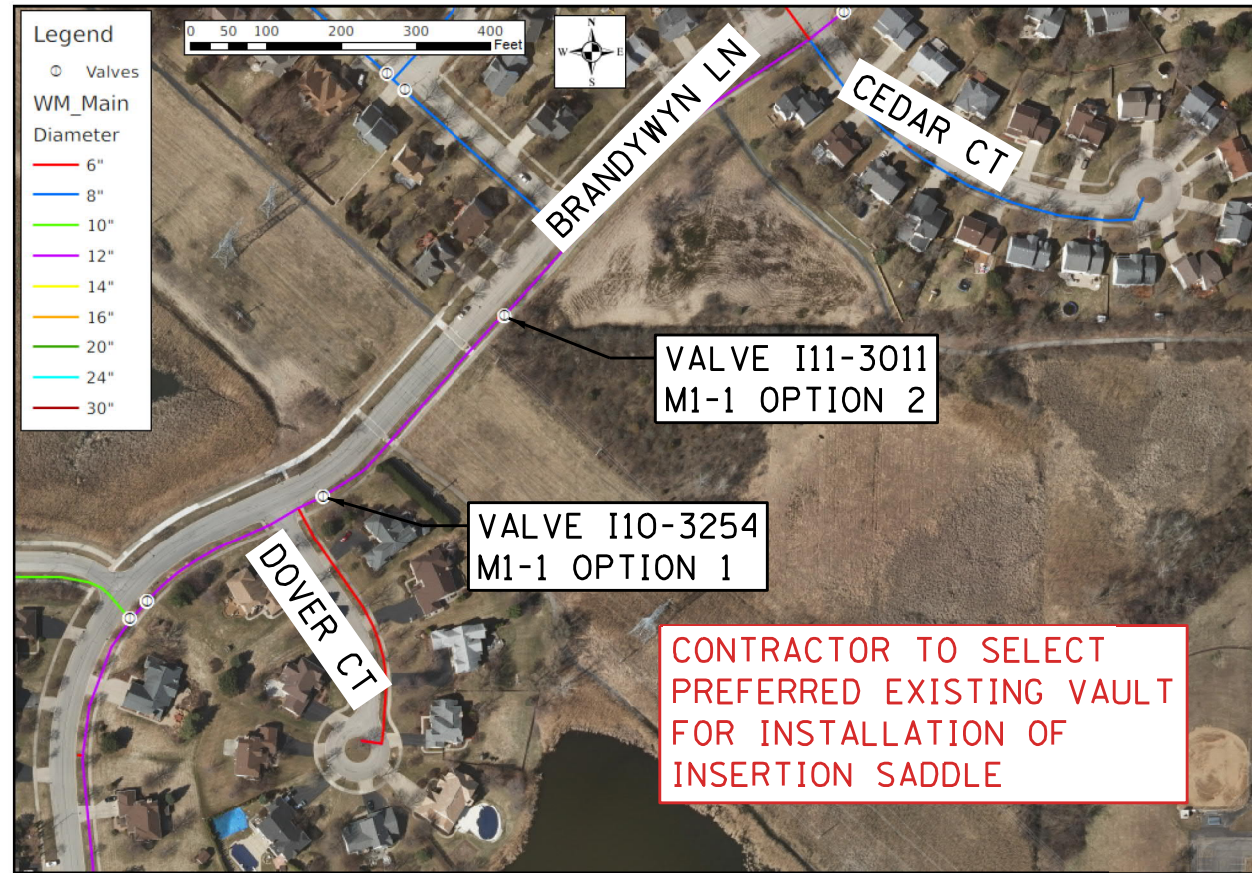

VALVE I10-3254
M1-1 OPTION 1

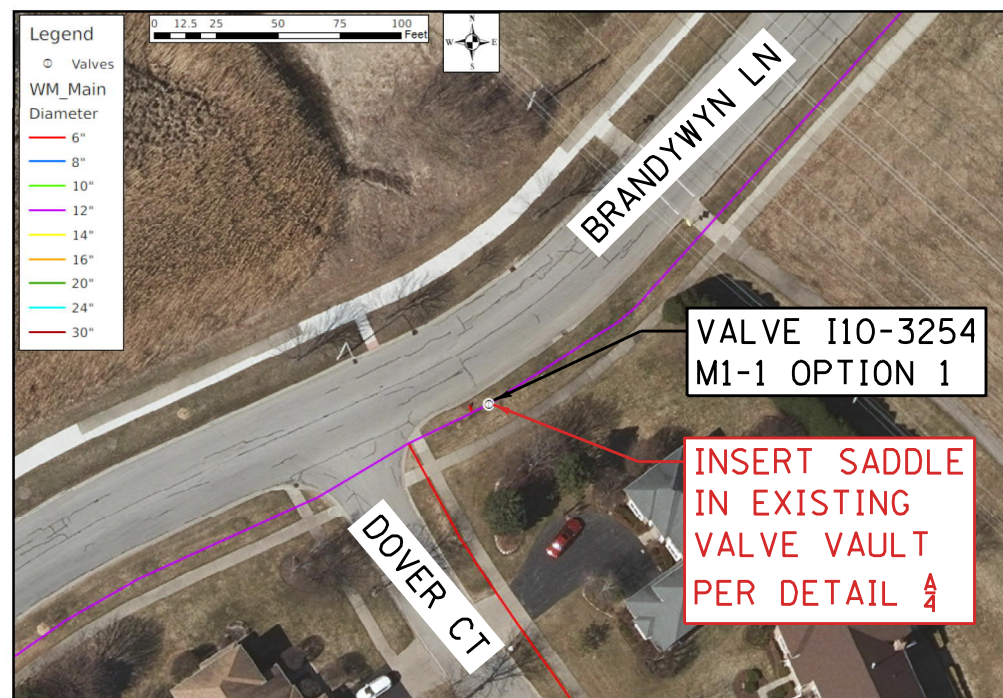

ALL WORK SHOWN ON THIS SHEET SHALL BE PAID AS "INSTALL OWNER FURNISHED SADDLE - LOCATION M1-1", INCLUDING BUT NOT LIMITED TO THE FOLLOWING:

1. SOIL TESTING AND HANDLING IN ACCORDANCE WITH CCDD REQUIREMENTS.
2. ALL SURFACE RESTORATIONS MATCHING AT LEAST EXISTING CONDITIONS.
3. ALL PIPES, FITTINGS, MANHOLES, AND ASSOCIATED APPURTENANCES NECESSARY FOR A COMPLETE INSTALLATION.

INSERTION LOCATION	M1-1 - OPTION 1	
VILLAGE VALVE NUMBER	I10-3254	
STREET LOCATION	NE CORNER OF BRANDYWYN LN AND DOVER CT	
TYPE OF VALVE STRUCTURE	ECCENTRIC	
DEPTH TO		
	TOP OF MAIN	9.5'
	VAULT	11'
DIAMETER	12"	
MATERIAL	DUCTILE IRON	
CONDITION	GOOD	
STEPS	FIRST 5 FEET	
OTHER	NEXT TO HYDRANT I10-4255	

NO.	REVISIONS	DATE

LOCATION M1-1 - OPTION 1
EXISTING MANHOLE - INSTALL INSERTION SADDLE
 WATER DISTRIBUTION FLOW METER INSTALLATIONS
 VILLAGE OF BUFFALO GROVE
 LAKE AND COOK COUNTIES, ILLINOIS

JOB NO.
1307.003
PROJECT MGR.
CHRIS ULM



SHEET
6

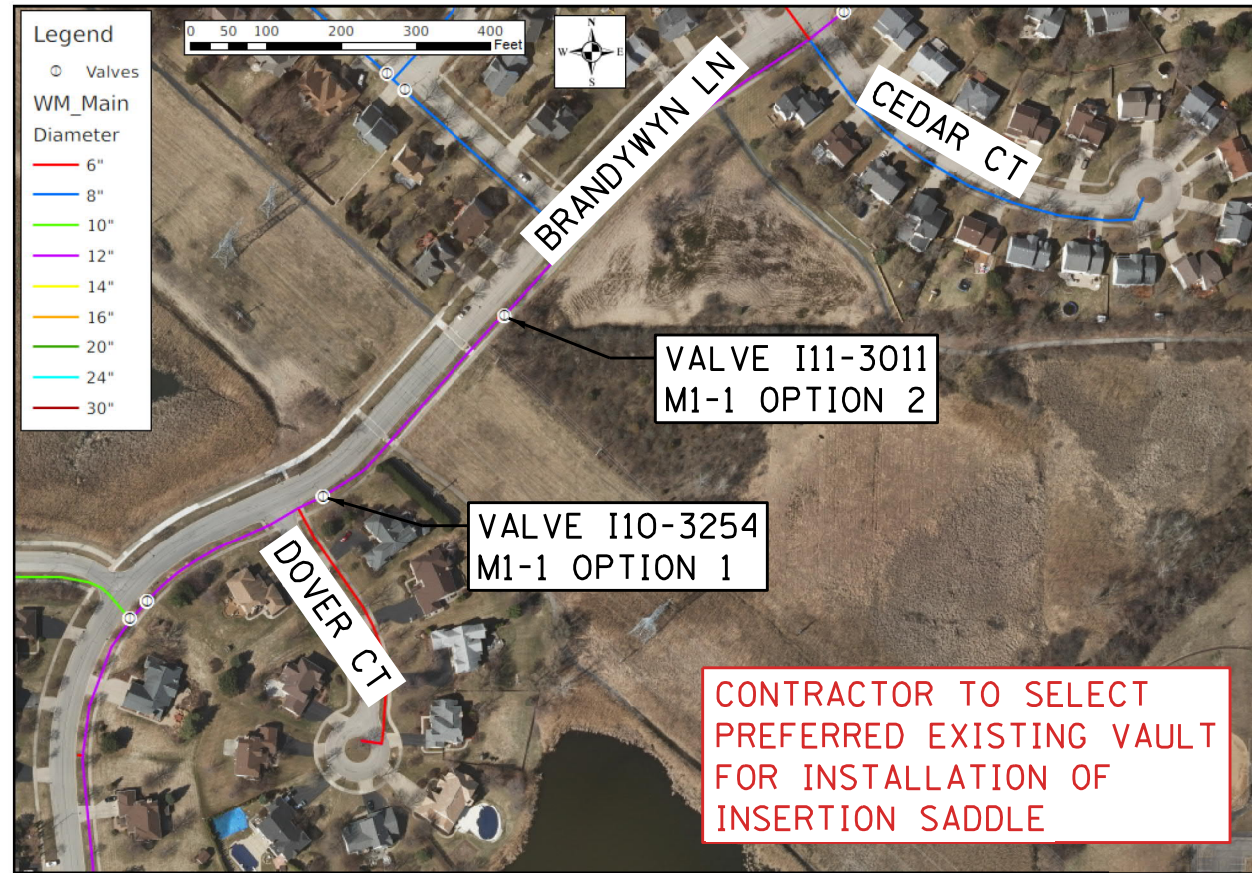

VALVE I11-3011
M1-1 OPTION 2

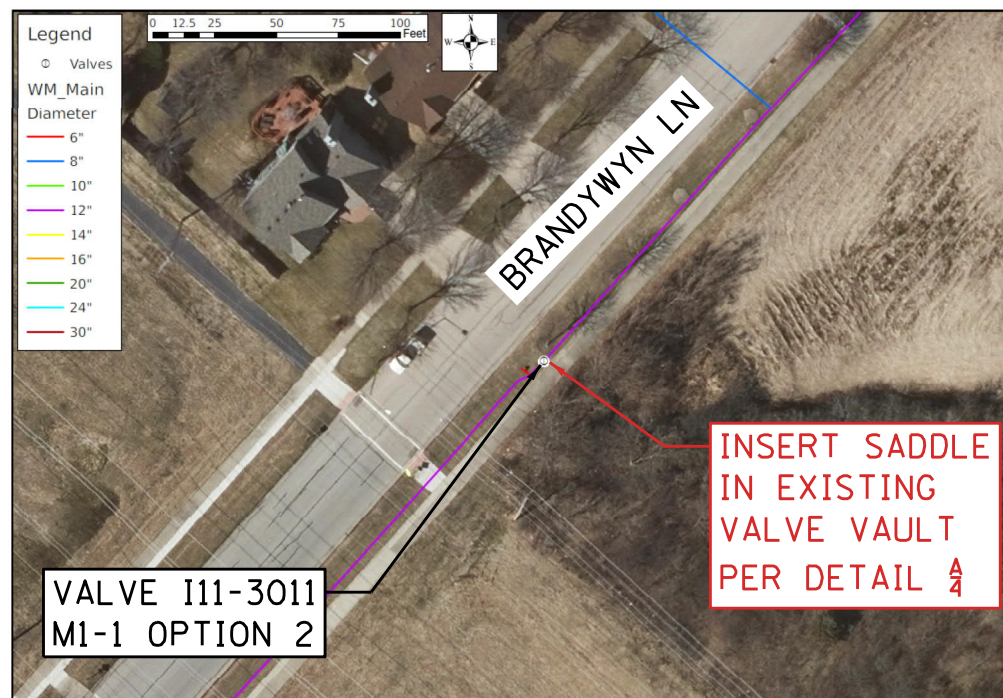

ALL WORK SHOWN ON THIS SHEET SHALL BE PAID AS "INSTALL OWNER FURNISHED SADDLE - LOCATION M1-1", INCLUDING BUT NOT LIMITED TO THE FOLLOWING:

1. SOIL TESTING AND HANDLING IN ACCORDANCE WITH CCDD REQUIREMENTS.
2. ALL SURFACE RESTORATIONS MATCHING AT LEAST EXISTING CONDITIONS.
3. ALL PIPES, FITTINGS, MANHOLES, AND ASSOCIATED APPURTENANCES NECESSARY FOR A COMPLETE INSTALLATION.

INSERTION LOCATION	M1-1 - OPTION 2
VILLAGE VALVE NUMBER	I11-3011
STREET LOCATION	EAST SIDE OF BRANDYWYN LN BETWEEN DOVER CT AND BIRCHWOOD LN
TYPE OF VALVE STRUCTURE	ECCENTRIC
DEPTH TO	
TOP OF MAIN	6'
VAULT	7.5'
DIAMETER	12"
MATERIAL	DUCTILE IRON
CONDITION	GOOD
STEPS	YES
OTHER	BETWEEN HYDRANT I11-4010 AND SIDEWALK

NO.	REVISIONS	DATE

LOCATION M1-1 - OPTION 2
EXISTING MANHOLE - INSTALL INSERTION SADDLE
 WATER DISTRIBUTION FLOW METER INSTALLATIONS
 VILLAGE OF BUFFALO GROVE
 LAKE AND COOK COUNTIES, ILLINOIS

JOB NO.
1307.003
PROJECT MGR.
CHRIS ULM



SHEET
7

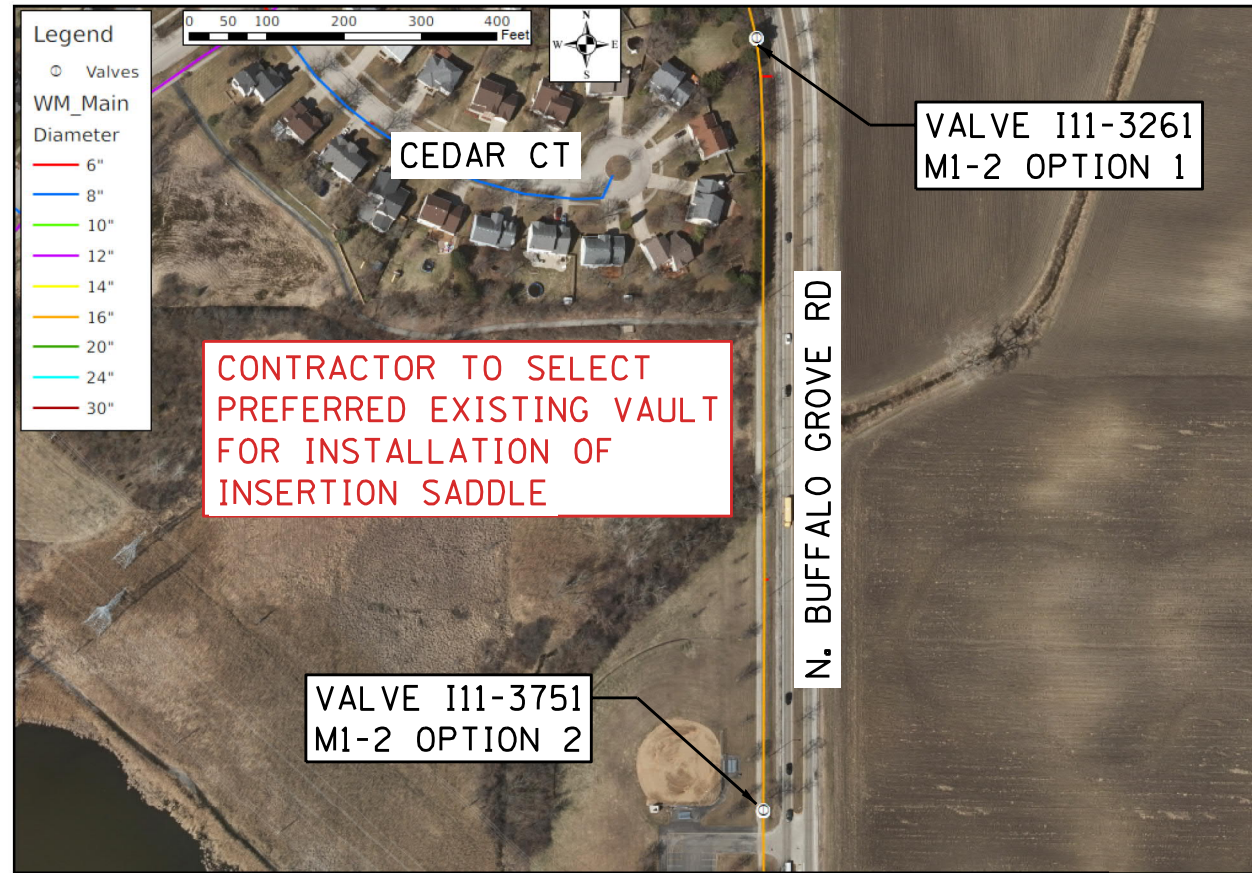

VALVE I11-3261
M1-2 OPTION 1

NO.	REVISIONS	DATE

LOCATION M1-2 - OPTION 1
EXISTING MANHOLE - INSTALL INSERTION SADDLE
 WATER DISTRIBUTION FLOW METER INSTALLATIONS
 VILLAGE OF BUFFALO GROVE
 LAKE AND COOK COUNTIES, ILLINOIS

JOB NO.
1307.003
 PROJECT MGR.
CHRIS ULM



SHEET
8

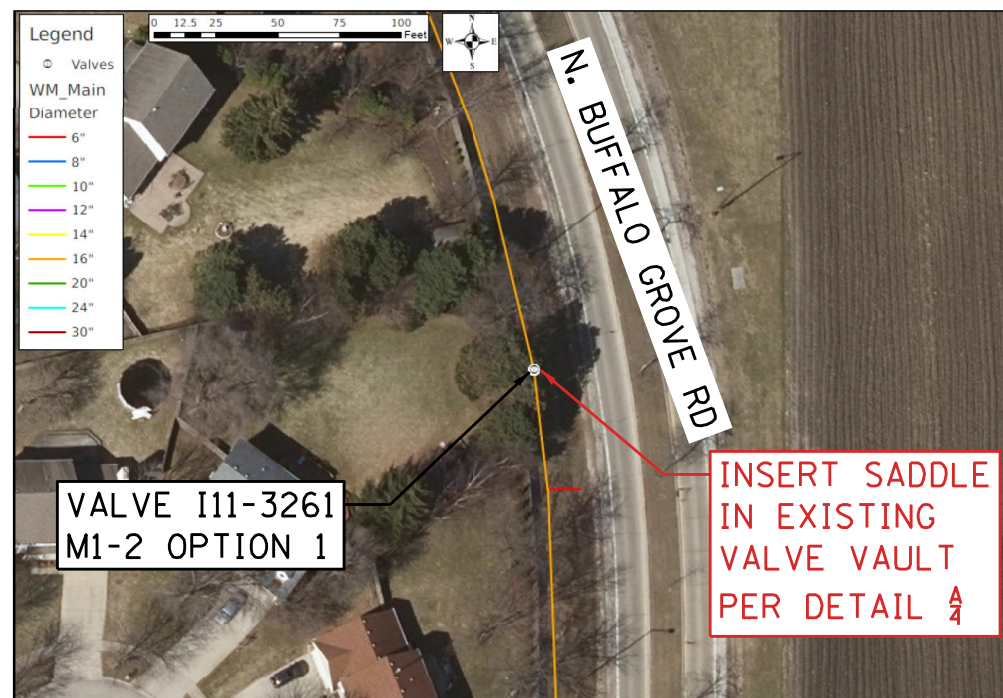

ALL WORK SHOWN ON THIS SHEET SHALL BE PAID AS "INSTALL OWNER FURNISHED SADDLE - LOCATION M1-2", INCLUDING BUT NOT LIMITED TO THE FOLLOWING:

1. SOIL TESTING AND HANDLING IN ACCORDANCE WITH CCDD REQUIREMENTS.
2. ALL SURFACE RESTORATIONS MATCHING AT LEAST EXISTING CONDITIONS.
3. ALL PIPES, FITTINGS, MANHOLES, AND ASSOCIATED APPURTENANCES NECESSARY FOR A COMPLETE INSTALLATION.

INSERTION LOCATION	M1-2 - OPTION 1
VILLAGE VALVE NUMBER	I11-3261
STREET LOCATION	WEST SIDE OF N. BUFFALO GROVE RD BETWEEN BRANDYWYN LN AND CHURCHILL PARK
TYPE OF VALVE STRUCTURE	ECCENTRIC
DEPTH TO	
TOP OF MAIN	5.5'
VAULT	7.5'
DIAMETER	16"
MATERIAL	DUCTILE IRON
CONDITION	GOOD
STEPS	YES
OTHER	

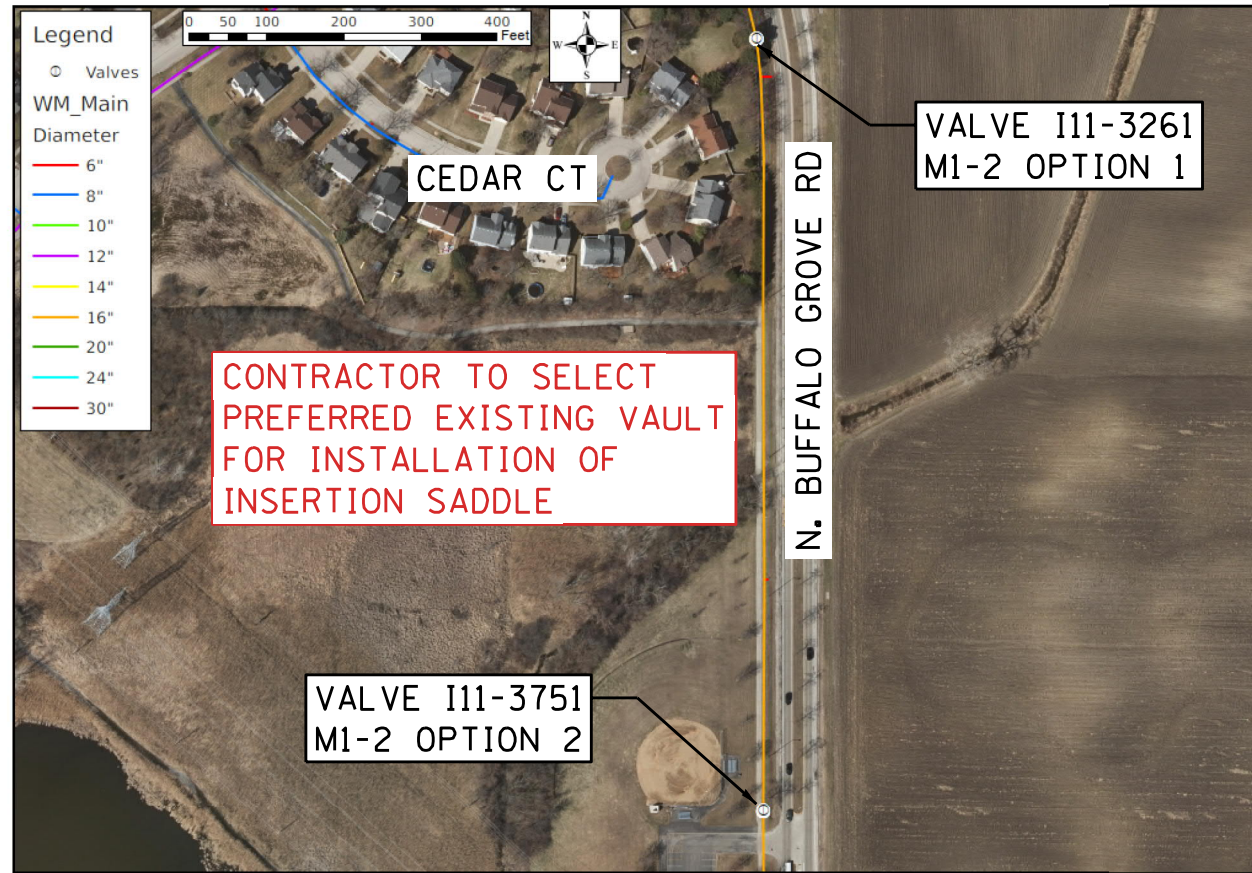

VALVE I11-3751
M1-2 OPTION 2

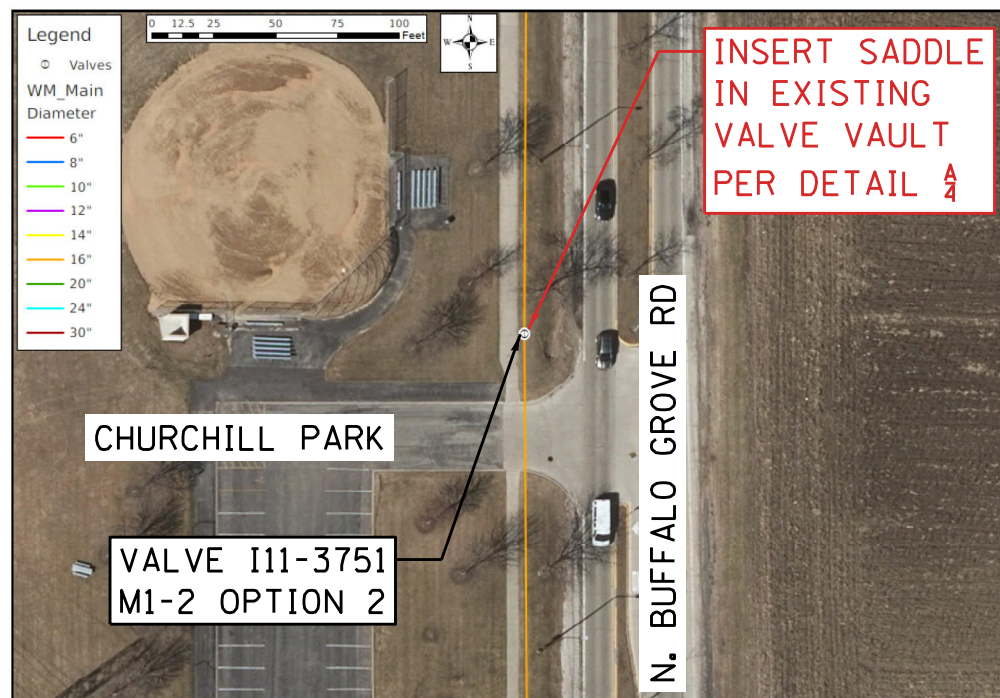

ALL WORK SHOWN ON THIS SHEET SHALL BE PAID AS "INSTALL OWNER FURNISHED SADDLE - LOCATION M1-2", INCLUDING BUT NOT LIMITED TO THE FOLLOWING:

1. SOIL TESTING AND HANDLING IN ACCORDANCE WITH CCDD REQUIREMENTS.
2. ALL SURFACE RESTORATIONS MATCHING AT LEAST EXISTING CONDITIONS.
3. ALL PIPES, FITTINGS, MANHOLES, AND ASSOCIATED APPURTENANCES NECESSARY FOR A COMPLETE INSTALLATION.

INSERTION LOCATION	M1-2 - OPTION 2
VILLAGE VALVE NUMBER	I11-3751
STREET LOCATION	WEST SIDE OF N. BUFFALO GROVE RD BETWEEN BRANDYWYN LN AND CHURCHILL PARK
TYPE OF VALVE STRUCTURE	ECCENTRIC
DEPTH TO	
TOP OF MAIN	6'
VAULT	7.5'
DIAMETER	16"
MATERIAL	DUCTILE IRON
CONDITION	GOOD
STEPS	YES
OTHER	NORTH OF DRIVEWAY FOR CHURCHILL PARK

NO.	REVISIONS	DATE

LOCATION M1-2 - OPTION 2
EXISTING MANHOLE - INSTALL INSERTION SADDLE
 WATER DISTRIBUTION FLOW METER INSTALLATIONS
 VILLAGE OF BUFFALO GROVE
 LAKE AND COOK COUNTIES, ILLINOIS

JOB NO.
1307.003
PROJECT MGR.
CHRIS ULM



SHEET
9



VALVE H15-3000

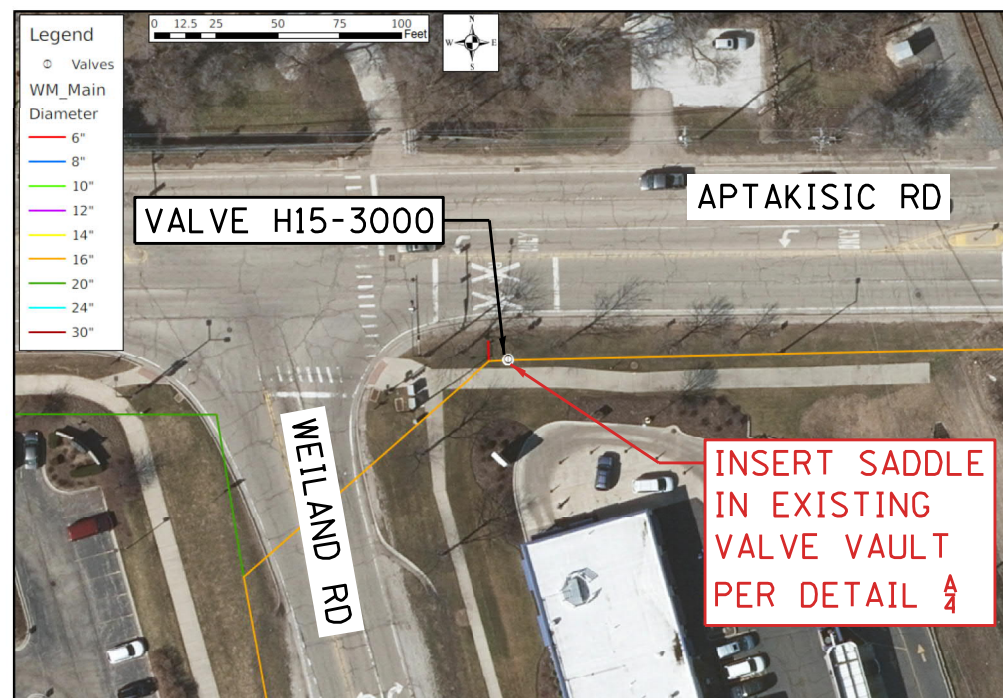

ALL WORK SHOWN ON THIS SHEET SHALL BE PAID AS "INSTALL OWNER FURNISHED SADDLE - LOCATION M2-1", INCLUDING BUT NOT LIMITED TO THE FOLLOWING:

1. SOIL TESTING AND HANDLING IN ACCORDANCE WITH CCDD REQUIREMENTS.
2. ALL SURFACE RESTORATIONS MATCHING AT LEAST EXISTING CONDITIONS.
3. ALL PIPES, FITTINGS, MANHOLES, AND ASSOCIATED APPURTENANCES NECESSARY FOR A COMPLETE INSTALLATION.

INSERTION LOCATION	M2-1
VILLAGE VALVE NUMBER	H15-3000
STREET LOCATION	SE CORNER OF APTAKISIC RD AND WEILAND RD
TYPE OF VALVE STRUCTURE	ECCENTRIC
DEPTH TO	
TOP OF MAIN	5.5'
VAULT	7'
DIAMETER	16"
MATERIAL	DUCTILE IRON
CONDITION	OKAY
STEPS	YES
OTHER	NEXT TO HYDRANT H15-4001

NO.	REVISIONS	DATE

LOCATION M2-1
EXISTING MANHOLE - INSTALL INSERTION SADDLE
 WATER DISTRIBUTION FLOW METER INSTALLATIONS
 VILLAGE OF BUFFALO GROVE
 LAKE AND COOK COUNTIES, ILLINOIS

JOB NO.
1307.003
 PROJECT MGR.
CHRIS ULM



SHEET
10

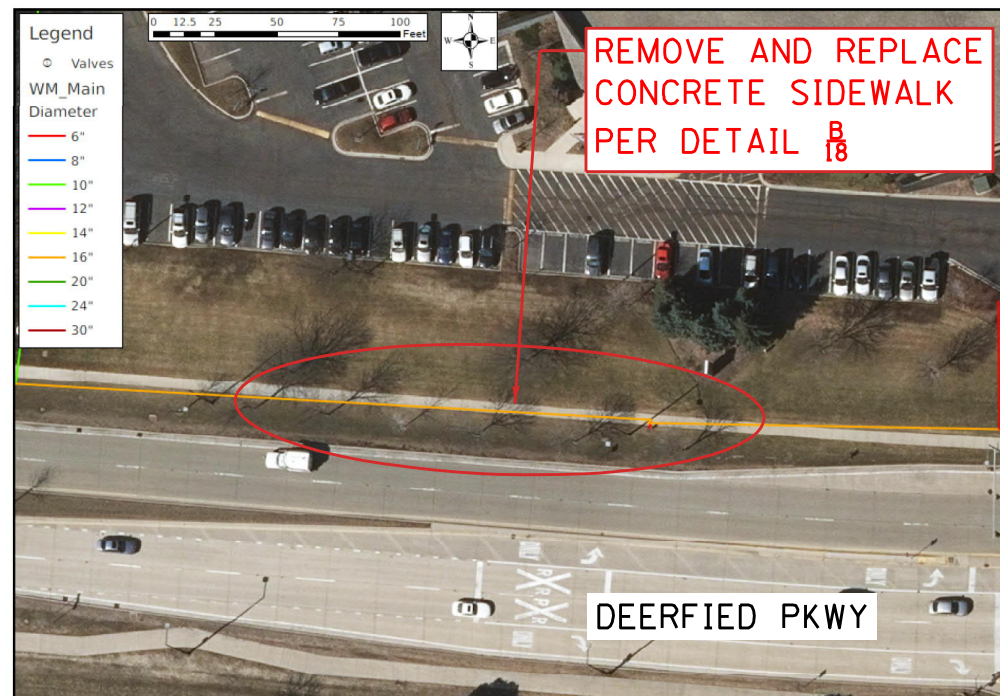
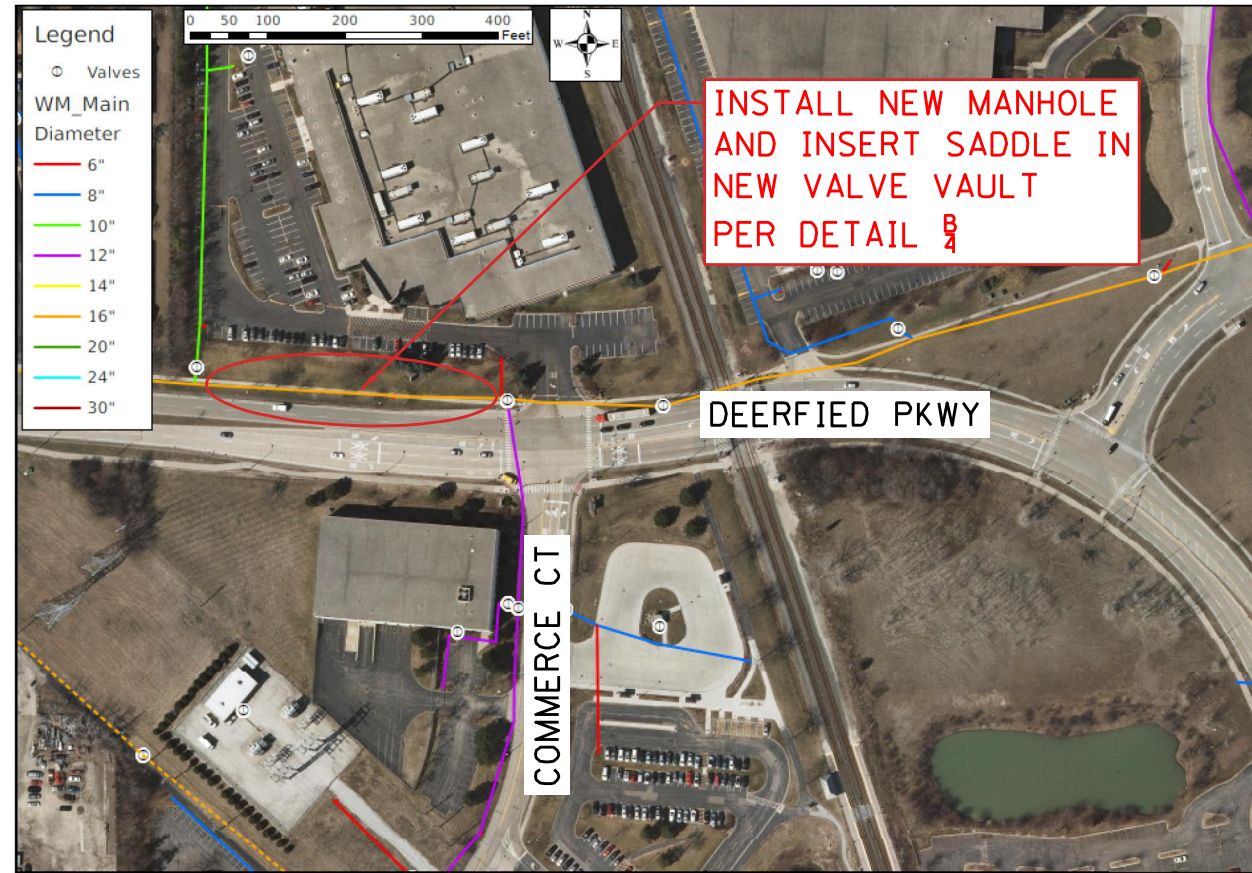

ALL WORK SHOWN ON THIS SHEET SHALL BE PAID AS "INSTALL NEW VAULT AND OWNER FURNISHED SADDLE - LOCATION M2-2", INCLUDING BUT NOT LIMITED TO THE FOLLOWING:

1. SOIL TESTING AND HANDLING IN ACCORDANCE WITH CCDD REQUIREMENTS.
2. ALL SURFACE RESTORATIONS MATCHING AT LEAST EXISTING CONDITIONS.
3. ALL PIPES, FITTINGS, MANHOLES, AND ASSOCIATED APPURTENANCES NECESSARY FOR A COMPLETE INSTALLATION.

INSERTION LOCATION	M2-2
VILLAGE WATER MAIN	G16-6501A
STREET LOCATION	NORTH SIDE OF DEERFIELD PKWY BETWEEN WINDBROOKE DR AND COMMERCE CT
TYPE OF VALVE STRUCTURE	N/A
DEPTH TO	
TOP OF MAIN VAULT	N/A
DIAMETER	16"
MATERIAL	DUCTILE IRON
CONDITION	N/A
STEPS	N/A
OTHER	

NO.	REVISIONS	DATE

LOCATION M2-2
INSTALL NEW VAULT AND INSERTION SADDLE
 WATER DISTRIBUTION FLOW METER INSTALLATIONS
 VILLAGE OF BUFFALO GROVE
 LAKE AND COOK COUNTIES, ILLINOIS

JOB NO.
1307.003
 PROJECT MGR.
CHRIS ULM



SHEET
11

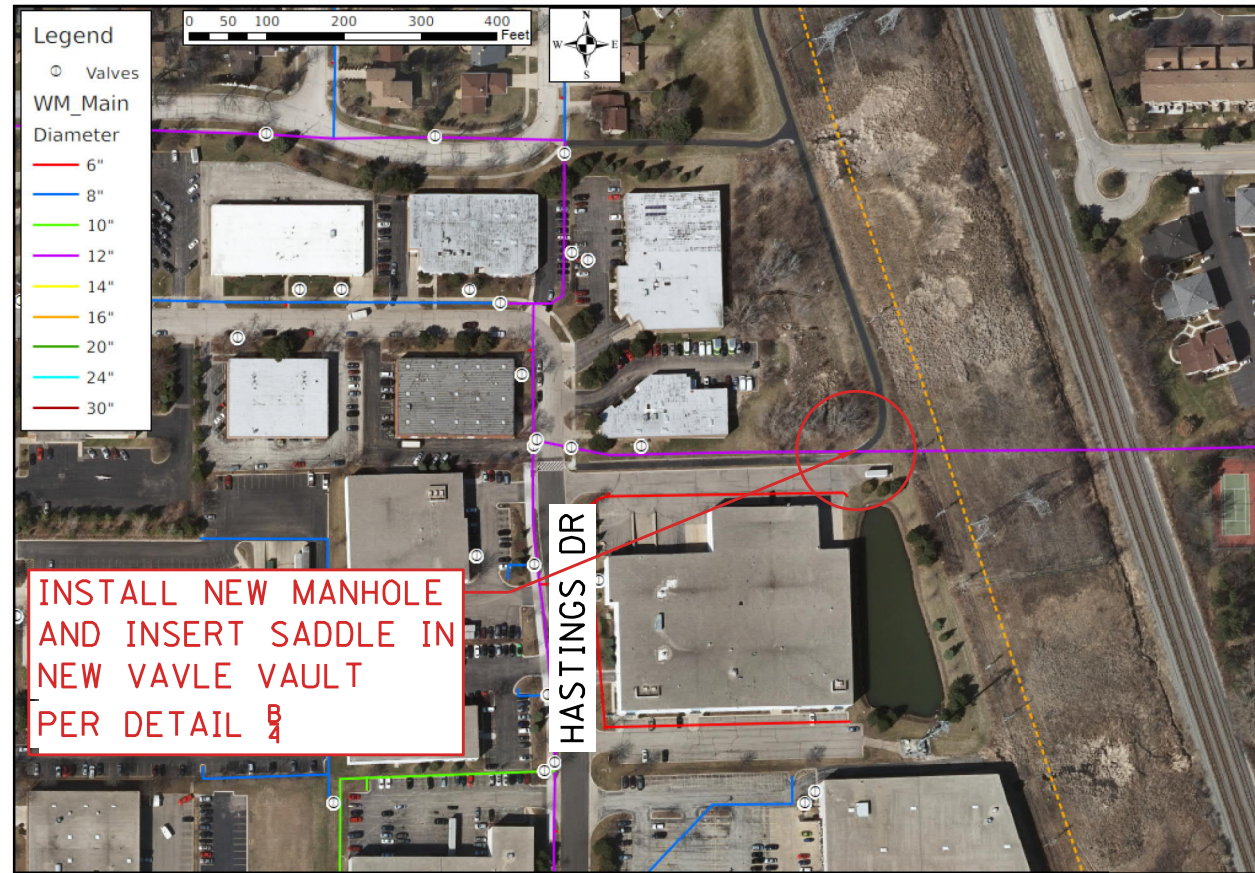

INSTALL NEW MANHOLE AND INSERT SADDLE IN NEW VAVLE VAULT PER DETAIL B

HASTINGS DR

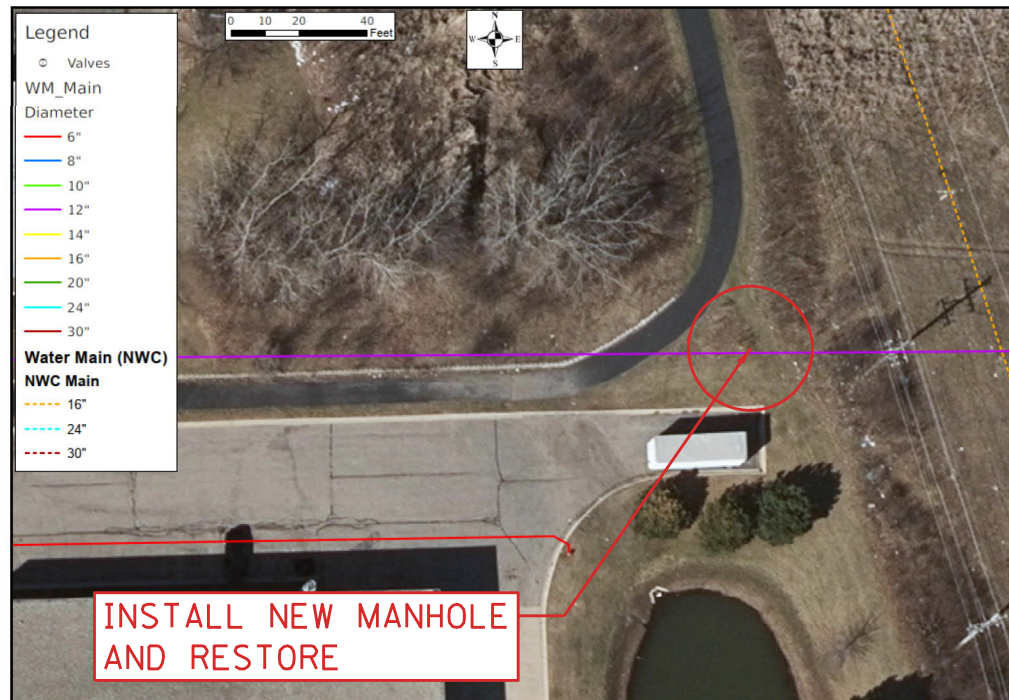

INSTALL NEW MANHOLE AND RESTORE

ALL WORK SHOWN ON THIS SHEET SHALL BE PAID AS "INSTALL NEW VAULT AND OWNER FURNISHED SADDLE - LOCATION M2-3", INCLUDING BUT NOT LIMITED TO THE FOLLOWING:

1. SOIL TESTING AND HANDLING IN ACCORDANCE WITH CCDD REQUIREMENTS.
2. ALL SURFACE RESTORATIONS MATCHING AT LEAST EXISTING CONDITIONS.
3. ALL PIPES, FITTINGS, MANHOLES, AND ASSOCIATED APPURTENANCES NECESSARY FOR A COMPLETE INSTALLATION.

INSERTION LOCATION	M2-3
VILLAGE WATER MAIN	E17-6010
STREET LOCATION	760 HASTINGS DR
TYPE OF VALVE STRUCTURE	N/A
DEPTH TO	
TOP OF MAIN	N/A
VAULT	N/A
DIAMETER	12"
MATERIAL	DUCTILE IRON
CONDITION	N/A
STEPS	N/A
OTHER	SE CORNER OF 760 HASTINGS DR PROPERTY

**LOCATION M2-3
INSTALL NEW VAULT AND INSERTION SADDLE**

WATER DISTRIBUTION FLOW METER INSTALLATIONS
VILLAGE OF BUFFALO GROVE
LAKE AND COOK COUNTIES, ILLINOIS

JOB NO.
1307.003
PROJECT MGR.
CHRIS ULM



SHEET
12

NO.	REVISIONS	DATE

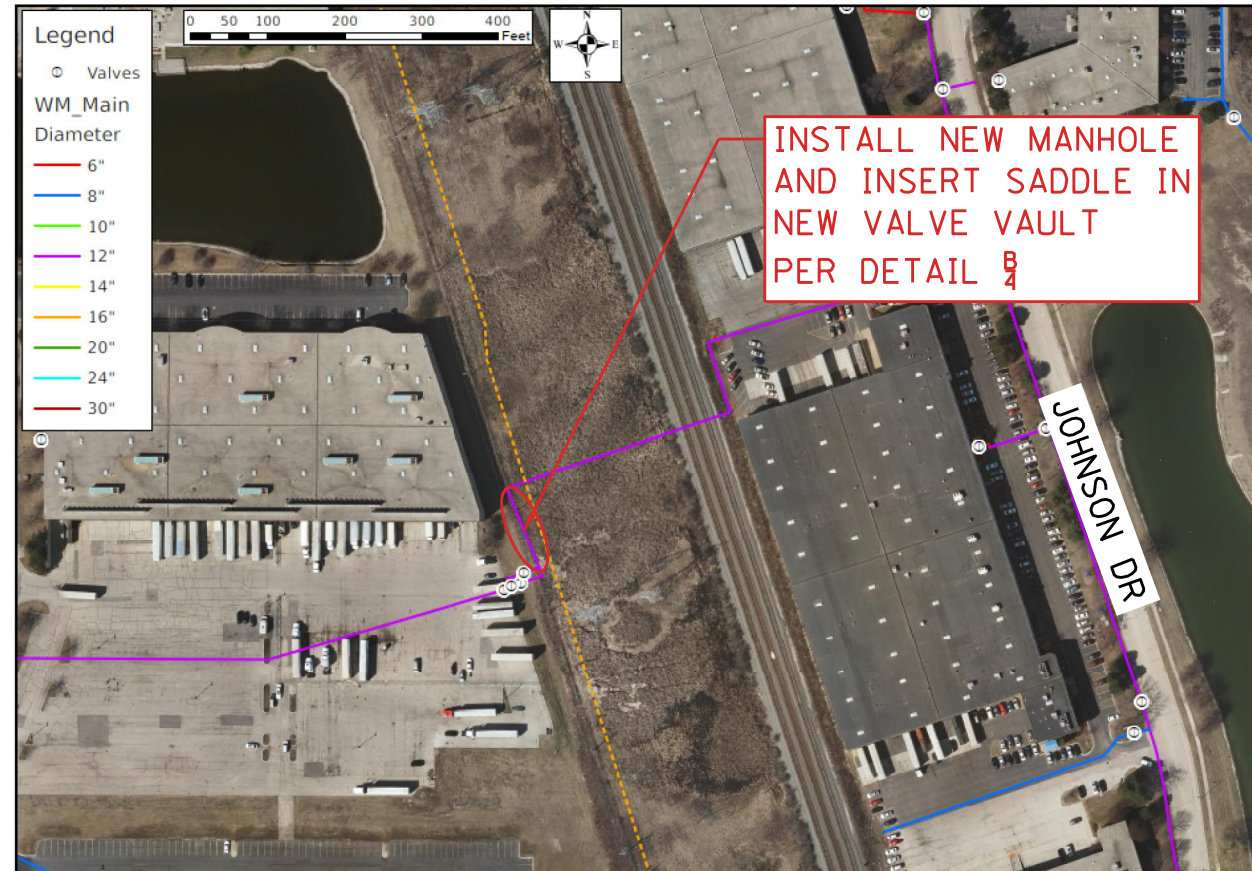

VIEW FACING NORTH

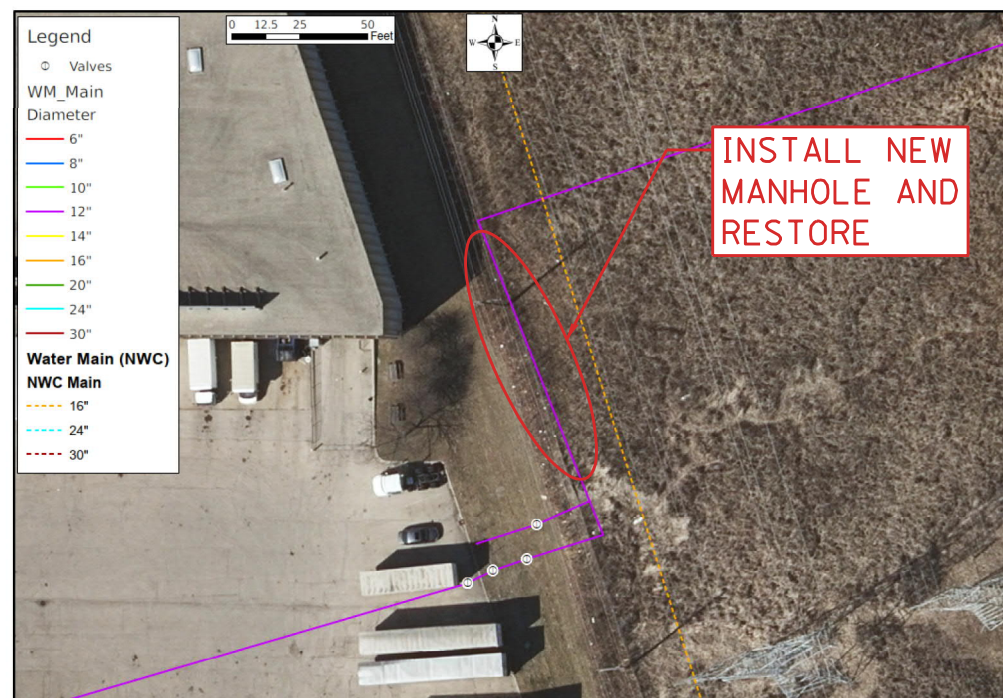

ALL WORK SHOWN ON THIS SHEET SHALL BE PAID AS "INSTALL NEW VAULT AND OWNER FURNISHED SADDLE - LOCATION M2-4", INCLUDING BUT NOT LIMITED TO THE FOLLOWING:

1. SOIL TESTING AND HANDLING IN ACCORDANCE WITH CCDD REQUIREMENTS.
2. ALL SURFACE RESTORATIONS MATCHING AT LEAST EXISTING CONDITIONS.
3. ALL PIPES, FITTINGS, MANHOLES, AND ASSOCIATED APPURTENANCES NECESSARY FOR A COMPLETE INSTALLATION.

INSERTION LOCATION	M2-4
VILLAGE WATER MAIN	E18-6500
STREET LOCATION	EAST SIDE OF PARKING LOT OF 151 HASTINGS DR
TYPE OF VALVE STRUCTURE	N/A
DEPTH TO	
TOP OF MAIN	N/A
VAULT	N/A
DIAMETER	12"
MATERIAL	DUCTILE IRON
CONDITION	N/A
STEPS	N/A
OTHER	

NO.	REVISIONS	DATE

LOCATION M2-4
INSTALL NEW VAULT AND INSERTION SADDLE
 WATER DISTRIBUTION FLOW METER INSTALLATIONS
 VILLAGE OF BUFFALO GROVE
 LAKE AND COOK COUNTIES, ILLINOIS

JOB NO.
1307.003
PROJECT MGR.
CHRIS ULM



SHEET
13



VALVE E08-3014

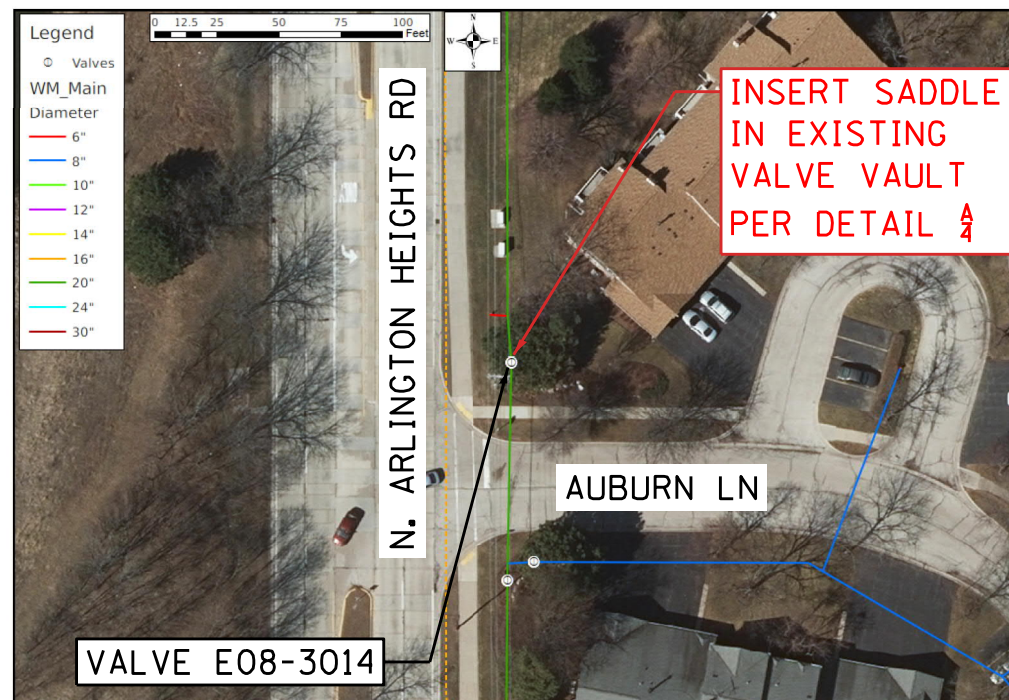

ALL WORK SHOWN ON THIS SHEET SHALL BE PAID AS "INSTALL OWNER FURNISHED SADDLE - LOCATION M3-1", INCLUDING BUT NOT LIMITED TO THE FOLLOWING:

1. SOIL TESTING AND HANDLING IN ACCORDANCE WITH CCDD REQUIREMENTS.
2. ALL SURFACE RESTORATIONS MATCHING AT LEAST EXISTING CONDITIONS.
3. ALL PIPES, FITTINGS, MANHOLES, AND ASSOCIATED APPURTENANCES NECESSARY FOR A COMPLETE INSTALLATION.

INSERTION LOCATION	M3-1	
VILLAGE VALVE NUMBER	E08-3014	
STREET LOCATION	NE CORNER OF N. ARLINGTON HEIGHTS RD AND AUBURN LN	
TYPE OF VALVE STRUCTURE	ECCENTRIC	
DEPTH TO		
	TOP OF MAIN	7'
	VAULT	9'
DIAMETER	20"	
MATERIAL	DUCTILE IRON	
CONDITION	GOOD	
STEPS	YES	
OTHER	IN BUSHES/MULCH BEHIND SIGN	

NO.	REVISIONS	DATE

LOCATION M3-1
EXISTING MANHOLE - INSTALL INSERTION SADDLE
 WATER DISTRIBUTION FLOW METER INSTALLATIONS
 VILLAGE OF BUFFALO GROVE
 LAKE AND COOK COUNTIES, ILLINOIS

JOB NO.
1307.003
 PROJECT MGR.
CHRIS ULM



SHEET
14

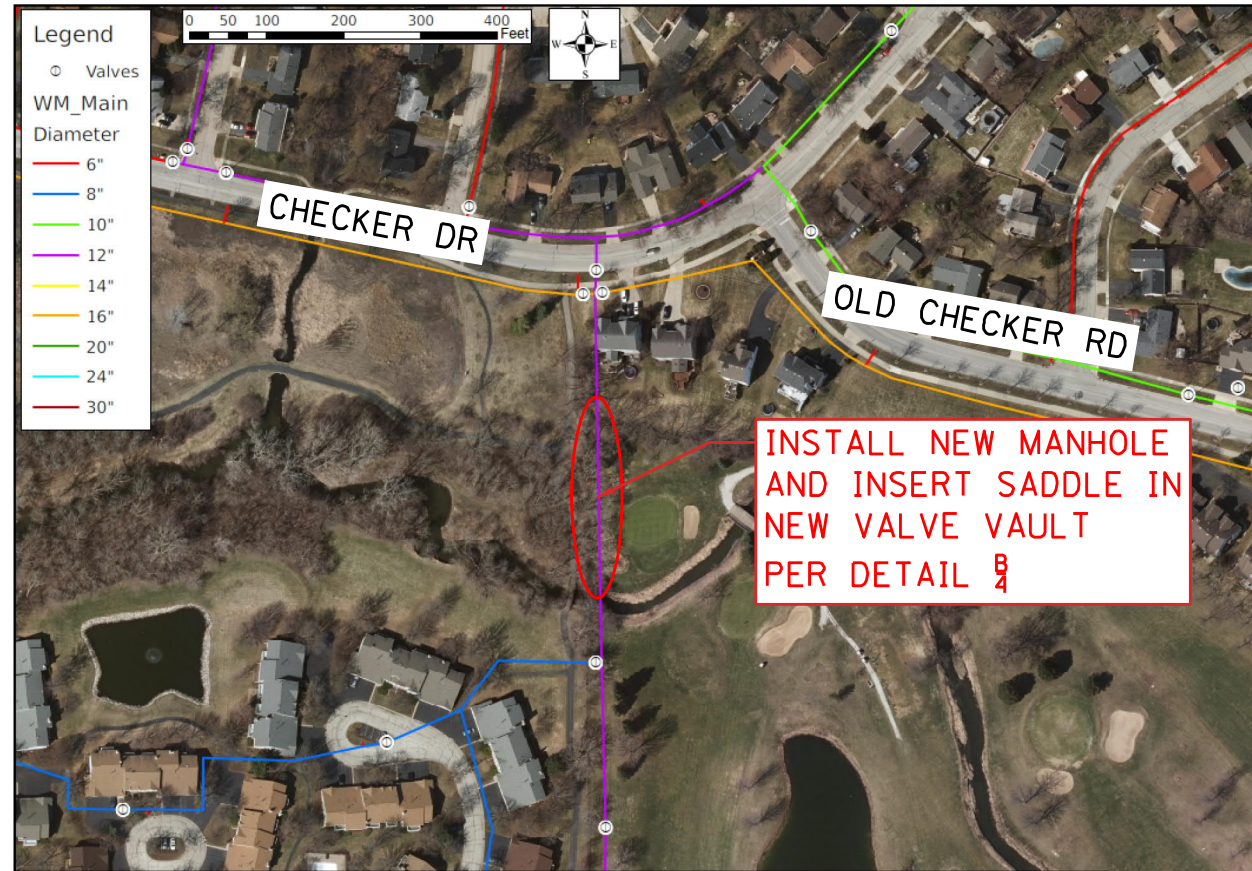

ALL WORK SHOWN ON THIS SHEET SHALL BE PAID AS "INSTALL NEW VAULT AND OWNER FURNISHED SADDLE - LOCATION M3-2", INCLUDING BUT NOT LIMITED TO THE FOLLOWING:

1. SOIL TESTING AND HANDLING IN ACCORDANCE WITH CCDD REQUIREMENTS.
2. ALL SURFACE RESTORATIONS MATCHING AT LEAST EXISTING CONDITIONS.
3. ALL PIPES, FITTINGS, MANHOLES, AND ASSOCIATED APPURTENANCES NECESSARY FOR A COMPLETE INSTALLATION.

INSERTION LOCATION	M3-2
VILLAGE WATER MAIN	E09-6015
STREET LOCATION	SOUTH SIDE OF CHECKER DR BETWEEN OLD CHECKER RD AND BURNT EMBER LN
TYPE OF VALVE STRUCTURE	N/A
DEPTH TO	
TOP OF MAIN	N/A
VAULT	N/A
DIAMETER	12"
MATERIAL	CAST IRON
CONDITION	N/A
STEPS	N/A
OTHER	RUNS ON WEST SIDE OF 316 AND HEADS SOUTH

NO.	REVISIONS	DATE

LOCATION M3-2
INSTALL NEW VAULT AND INSERTION SADDLE
 WATER DISTRIBUTION FLOW METER INSTALLATIONS
 VILLAGE OF BUFFALO GROVE
 LAKE AND COOK COUNTIES, ILLINOIS

JOB NO.
1307.003
PROJECT MGR.
CHIRS ULM



SHEET
15

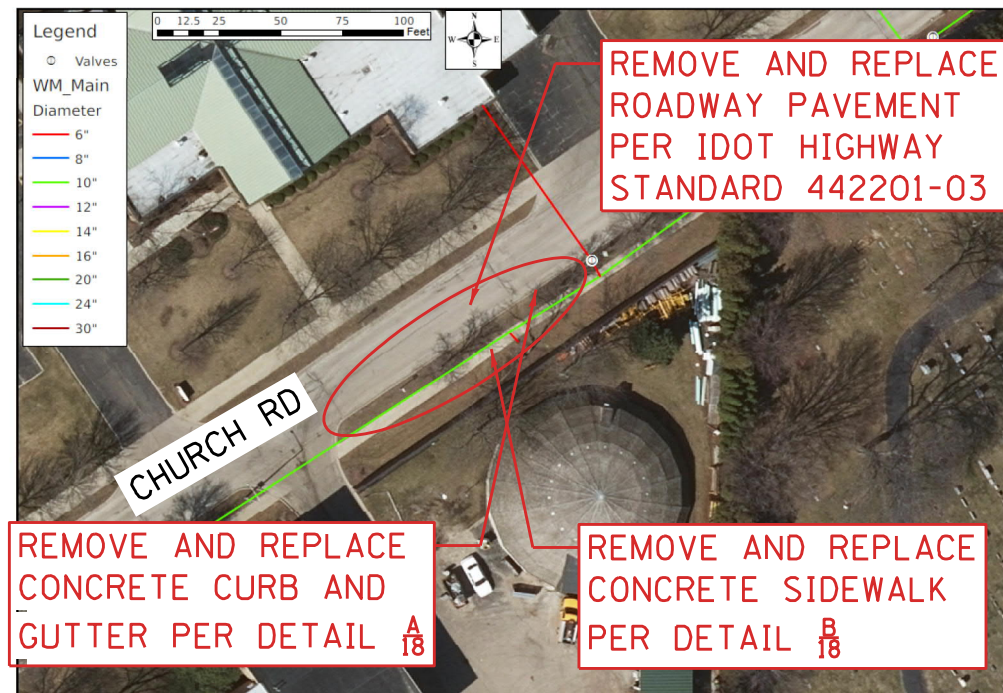
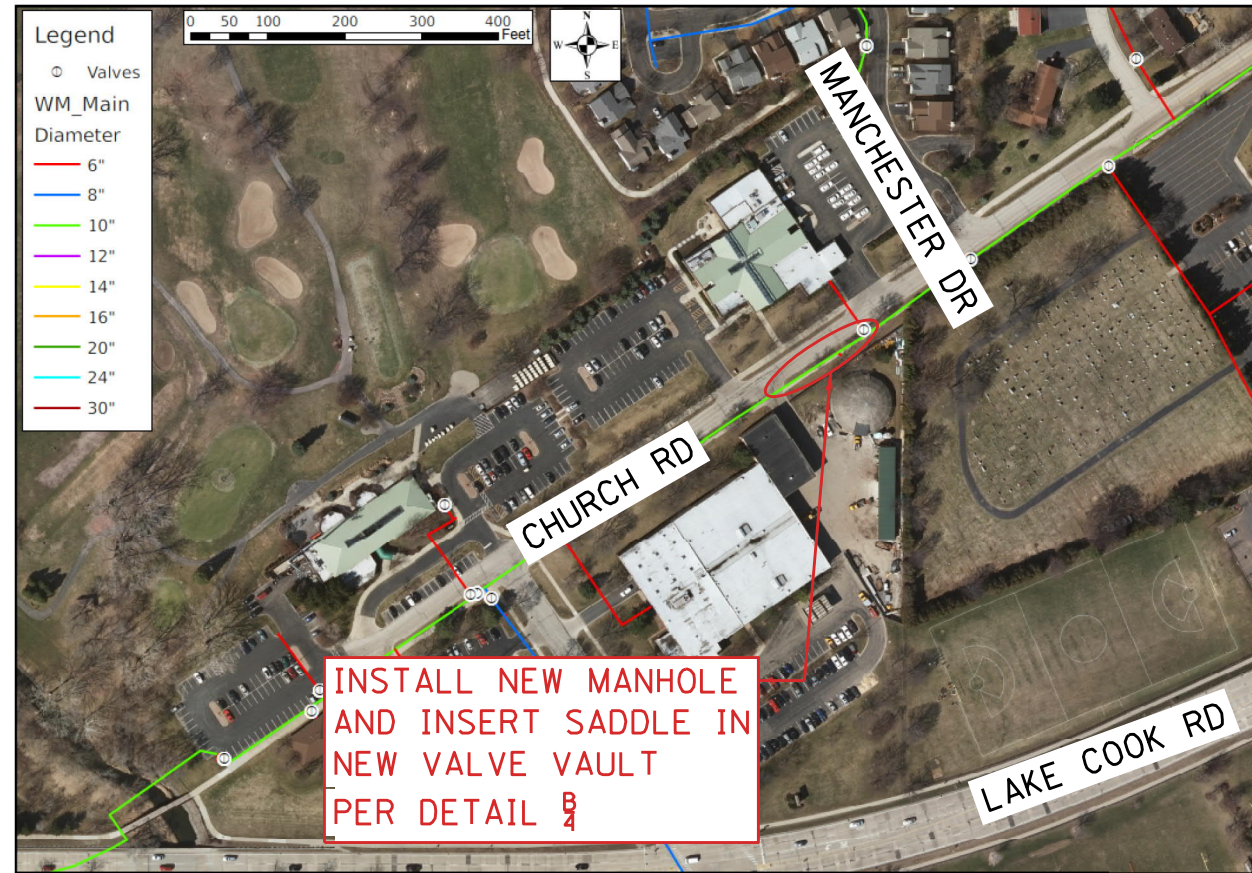

ALL WORK SHOWN ON THIS SHEET SHALL BE PAID AS "INSTALL NEW VAULT AND OWNER FURNISHED SADDLE - LOCATION M3-3", INCLUDING BUT NOT LIMITED TO THE FOLLOWING:

1. SOIL TESTING AND HANDLING IN ACCORDANCE WITH CCDD REQUIREMENTS.
2. ALL SURFACE RESTORATIONS MATCHING AT LEAST EXISTING CONDITIONS.
3. ALL PIPES, FITTINGS, MANHOLES, AND ASSOCIATED APPURTENANCES NECESSARY FOR A COMPLETE INSTALLATION.

INSERTION LOCATION	M3-3
VILLAGE WATER MAIN	E11-6790A
STREET LOCATION	SOUTH SIDE OF CHURCH RD BETWEEN RAUPP BLVD AND MANCHESTER DR
TYPE OF VALVE STRUCTURE	N/A
DEPTH TO	
TOP OF MAIN	N/A
VAULT	N/A
DIAMETER	10"
MATERIAL	CAST IRON
CONDITION	N/A
STEPS	N/A
OTHER	

NO.	REVISIONS	DATE

LOCATION M3-3
INSTALL NEW VAULT AND INSERTION SADDLE
 WATER DISTRIBUTION FLOW METER INSTALLATIONS
 VILLAGE OF BUFFALO GROVE
 LAKE AND COOK COUNTIES, ILLINOIS

JOB NO.
1307.003
PROJECT MGR.
CHRIS ULM



SHEET
16

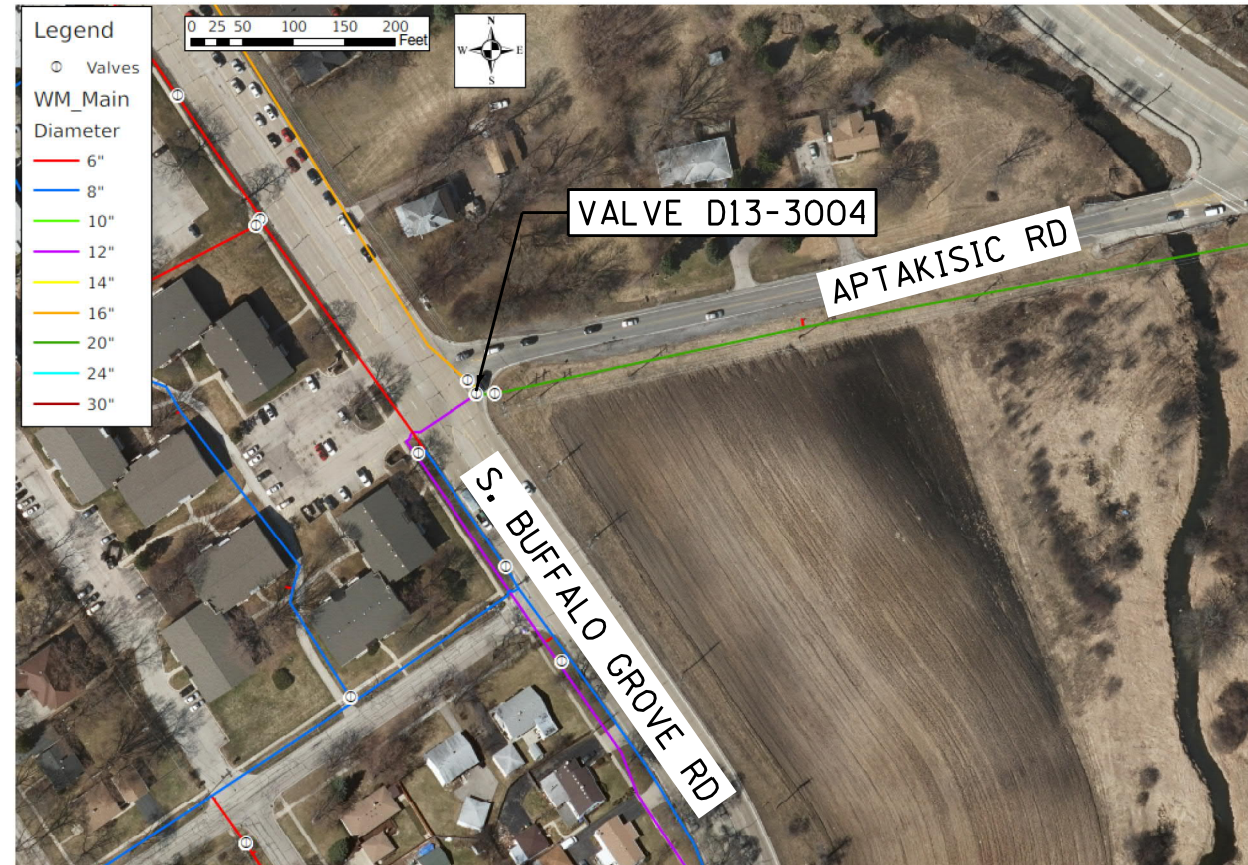

VALVE D13-3004

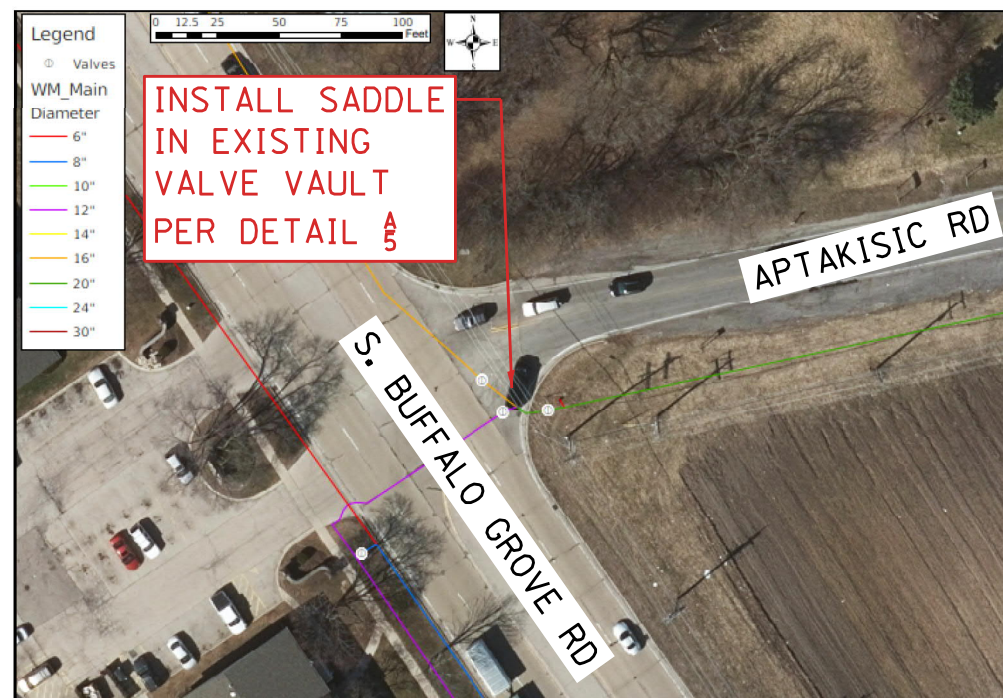

ALL WORK SHOWN ON THIS SHEET SHALL BE PAID AS "INSTALL OWNER FURNISHED SADDLE - LOCATION M3-4", INCLUDING BUT NOT LIMITED TO THE FOLLOWING:

1. SOIL TESTING AND HANDLING IN ACCORDANCE WITH CCDD REQUIREMENTS.
2. ALL SURFACE RESTORATIONS MATCHING AT LEAST EXISTING CONDITIONS.
3. ALL PIPES, FITTINGS, MANHOLES, AND ASSOCIATED APPURTENANCES NECESSARY FOR A COMPLETE INSTALLATION.

INSERTION LOCATION	M3-4
VILLAGE VALVE NUMBER	D13-3004
STREET LOCATION	SE CORNER OF S. BUFFALO GROVE RD AND APTAKISIC RD
TYPE OF VAULT STRUCTURE	ECCENTRIC
DEPTH TO	
TOP OF MAIN	5'
VAULT	6.5'
DIAMETER	12"
MATERIAL	DUCTILE IRON
CONDITION	CRUSTY
STEPS	YES
OTHER	

NO.	REVISIONS	DATE

LOCATION M3-4
EXISTING MANHOLE - INSTALL INSERTION SADDLE
 WATER DISTRIBUTION FLOW METER INSTALLATIONS
 VILLAGE OF BUFFALO GROVE
 LAKE AND COOK COUNTIES, ILLINOIS

JOB NO.
1307.003
 PROJECT MGR.
CHRIS ULM



SHEET
17

EXHIBIT NO. 501

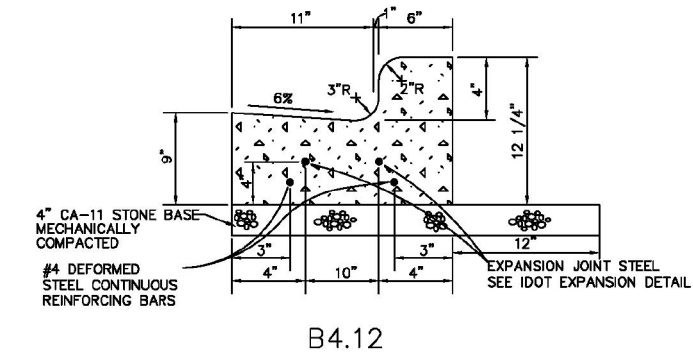

B4.12

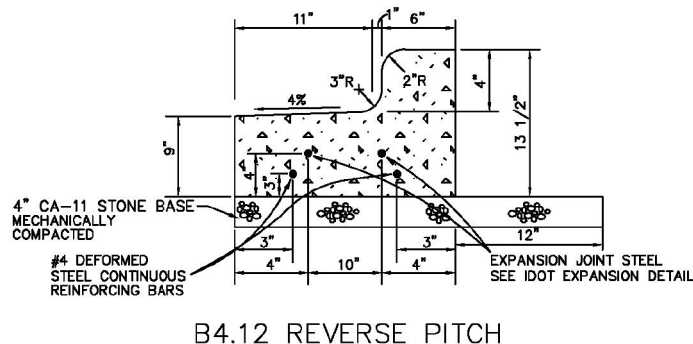

B4.12 REVERSE PITCH

B4.12 CURB AND GUTTER DETAIL

- NOTE:
1. SET EXPANSION JOINTS AT ALL PC'S, PT'S, FIVE FEET ON EITHER SIDE OF ANY FRAMES, AND AT 45' MAX. INTERVALS.
 2. CONTRACTION JOINTS SHALL BE TOOLED AT 15' INTERVALS AND SAW CUT WITHIN 24 HOURS.
 3. JOINTS SHALL BE CLEANED AND SEALED ACCORDING TO ARTICLE 420.12.
 4. CURING COMPOUND REQUIRED.
 5. IDOT APPROVED CURBS ALSO PERMITTED.

Prepared by the Village Engineering Division

A
18

EXHIBIT NO. 502

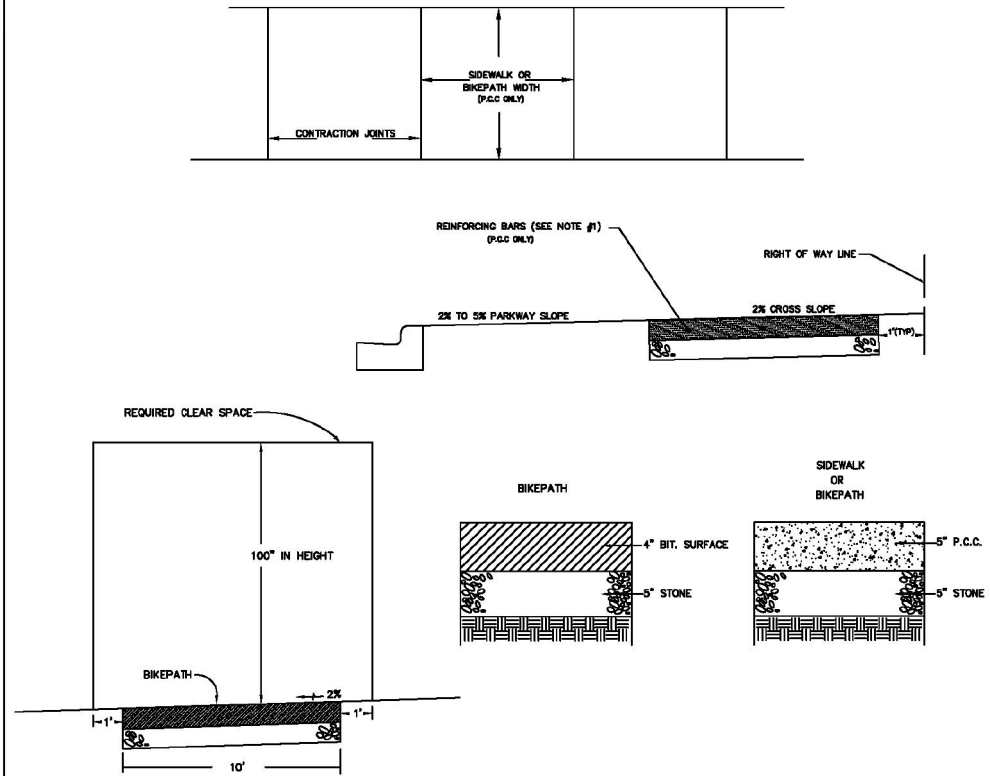

BIKEPATH & SIDEWALK DETAIL

- NOTE:
1. AT ALL TRENCH CROSSINGS, 3 - 10' X 3/4" REINFORCING BARS SHALL BE PLACED EQUALLY SPACED AND CENTERED OVER THE TRENCH.
 2. CONCRETE THICKNESS SHALL BE 6" AT ALL DRIVEWAYS AND TRENCH CROSSINGS.
 3. SET 3/4" EXPANSION JOINTS AT 50' MAX. SPACING INTERVALS.
 4. SIDEWALK WIDTH AS SHOWN ON PLANS.
 5. CURB RAMPS SHALL COMPLY WITH LATEST ACCESSIBILITY STANDARDS.

Prepared by the Village Engineering Division

B
18

NO.	REVISIONS	DATE

CONSTRUCTION DETAILS - 1
 WATER DISTRIBUTION FLOW METER INSTALLATIONS
 VILLAGE OF BUFFALO GROVE
 LAKE AND COOK COUNTIES, ILLINOIS

JOB NO.
1307.003
 PROJECT MGR.
CHIRS ULM



SHEET
18

EXHIBIT NO. 401

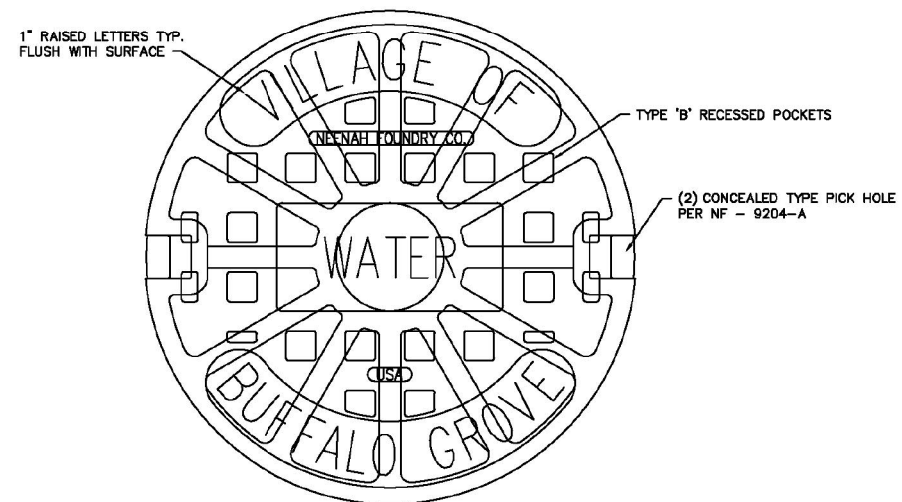

NEENAH FOUNDRY
R-1772 SOLID LID TYPE "B"

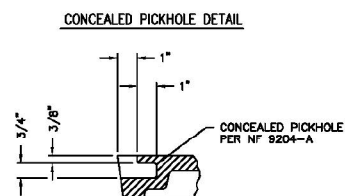

VALVE VAULT LID DETAIL

Prepared by the Village Engineering Division

A
19

NO.	REVISIONS	DATE:

CONSTRUCTION DETAILS - 2

WATER DISTRIBUTION FLOW METER INSTALLATIONS
VILLAGE OF BUFFALO GROVE
LAKE AND COOK COUNTIES, ILLINOIS

JOB NO.
1307.003
PROJECT MGR.
CHIRS ULM



SHEET
19

Water Distribution Material Specifications:

Water main pipe.	Ductile Iron Pipe. Pipe class thickness—AWWA C150, minimum thickness, Class 52. Pipe—AWWA C151. Pipe lining—AWWA C104. Fittings—AWWA C153. Joints—mechanical and push-on, AWWA C111. Wrap—4 mil. X-Lam conforming to AWWA C105.A21.5 and AWWA C600. No 90 degree bends allowed. All stainless steel trim.
Valves.	American Flow Control, Series 2500 resilient wedge gate valve, All sizes two inch to fourteen inch, counter clockwise to open, AWWA C500., AWWA C504. Clow AWWA C-504 Butterfly Valve for sixteen inch and above. Joint end—mechanical, AWWA C111. All stainless steel trim.
Valve Vault.	All structures shall be monolithically precast with designed openings or mechanically cored in the field and shall have rubber boots conforming to ASTM C-923. Dog house vaults are excluded from these requirements when permitted by Village Engineer. Size: For six and eight inch diameter valves, valve vaults shall have a forty-eight inch inside diameter; for pressure connections and valves ten inches and larger in diameter, valve vaults shall have a sixty inch inside diameter. All valve vault cones must be eccentric centers with valve properly aligned.
Castings.	Neenah No. R-1772, embossed per Exhibit No. 401.
Fire Hydrant.	Waterous Pacer Model WB67-250, AWWA C502, painted fire engine red above ground, with resilient wedge auxiliary gate valve. Nozzles, two at two and one half inch, one at four and one half inch, with threads conforming to National Standard Specifications. Frangible section (breakaway type) with the break line flange located one inch above finished grade. Joint end, six inch, mechanical or push-on. Stainless steel trim below ground. Auxiliary boxes and hydrants shall be a direct flange-to-flange connection.
Fire hydrant extension	Fire hydrant extensions and parts to be manufactured by Waterous only. All stainless steel trim.
Hydrant Valve Box \ Valve boxes	Hydrant Valve Box Tyler 664-S. Lid embossed "WATER." Rubber valve box stabilizer required.
Service Pipe.	Copper tube, two inches and smaller, ASTM B88, Type K (1" minimum). Ductile iron, larger than two inches. Conform to Water main section above. Service upgrade for existing water main requires a stainless steel tap repair clamp. Ford model FS1-CC, minimum length 15" long.
Corporation Stop.	Mueller H15000, 1" minimum, AWWA C800. 1" Direct tap or 1 1/4" and larger shall use Ford FC202 stainless steel band, epoxy coated saddle.
Curb Stop.	Copper service, Mueller H-15154. Ductile iron service, Resilient wedge counter clockwise to open, AWWA C500. Joint end—mechanical, AWWA C111.
Curb box	Copper service, Mueller H-10302. Ductile iron service, conform to Hydrant Valve Box section above. Ductile iron service, 6" and larger, conform to Valve Vault section above.
Copper to Copper Fittings	Mueller Company Model #H-15400. An all flared coupling is required, no sweat joint or compression allowed.
Pressure Connections	Ford FTSS style tapping sleeve. American Flow Control Series 2500 tapping valve four inch minimum. All stainless steel trim.

Material Specifications For All Utilities:

Bedding	CA-11, Class B or better. All stone shall be crushed; rounded aggregate will not be permitted. The stone shall be compacted to 90% modified proctor density as required by ASTM D1557 or AASHTO T-180. Recycled materials permitted from IDOT approved sources meeting the correct gradations.
Trench Backfill	CA-11, Class B or better. This item shall meet the requirements of Class B CA-11, per the IDOT Standard Specifications for Road and Bridge Construction. All stone shall be crushed; rounded aggregate will not be permitted. The stone shall be compacted to 90% modified proctor density as required by ASTM D1557 or AASHTO T-180. Jetting of trenches is not permitted. Recycled materials permitted from IDOT approved sources meeting the correct gradations.
Adjustments	No more than two precast concrete adjusting rings with six inch maximum height adjustment shall be allowed, minimum one 2" ring installed on new structures. Only one HDPE ring with a max of 2" may be used within the precast tolerances. Only precast concrete or HDPE adjustment rings permitted. 1/2" x 3.5" mastic to be used between all frames, rings and structures. Mortar around rings, but none between.

DATE:									
REVISIONS									
NO.									

MATERIAL SPECIFICATIONS

WATER DISTRIBUTION FLOW METER INSTALLATIONS
VILLAGE OF BUFFALO GROVE
LAKE AND COOK COUNTIES, ILLINOIS

JOB NO.
1307.003
PROJECT MGR.
CHRIS ULM



SHEET
20

SMARTWATER ZONE METER INSTALL CONTRACT

Smartwater Zone Meter Install Contract(the “**Contract**”) is entered between the Village of Buffalo Grove (hereinafter the “**Village**” or “**Owner**”), an Illinois home-rule unit of government, and _____ (hereinafter the “**Contractor**”) on this ____ day of _____, 2019 (the “**Effective Date**”). The Village and the Contractor are hereinafter sometimes collectively referred to as the “**Parties**” and individually as a “**Party**”.

RECITALS

WHEREAS, the Village has solicited bids for the Work (defined below), Contractor has submitted a bid for the Work and Village has selected Contractor for the Work based on their bid; and

WHEREAS, the Contractor wishes to enter into this Contract with the Village and the Village wishes to enter into this Contract with the Contractor for the Work;

NOW THEREFORE, for and in consideration of the mutual covenants and promises herein contained, the adequacy and sufficiency of which are hereby acknowledged by the Parties, it is agreed as follows:

ARTICLE I - WORK TO BE DONE BY THE CONTRACTOR

The Village does hereby hire and contract with the Contractor to provide all the labor, equipment, materials and/or services described more thoroughly on Contract **Exhibit A** (the “**Work**”) which is incorporated into the Contract by this reference.

ARTICLE II - CONTRACT DOCUMENTS

The following exhibits are attached hereto and incorporated herein by this reference:

- Contract Exhibit A – Description of the Work**
- Contract Exhibit B – Schedule of Prices**
- Contract Exhibit C – Performance and Payment Bond**
- Contract Exhibit D – Partial Lien Waiver**
- Contract Exhibit E – Final Lien Waiver**

If any term or provision of this Contract shall conflict with any term or provision of the exhibits referenced above, the terms and provisions of the exhibit shall control.

ARTICLE III - CONTRACT AMOUNT

The Village agrees to pay the Contractor for the proper and timely performance of the Work in strict accordance with this Contract as detailed in **Contract Exhibit B** (the “**Schedule of Prices**”) Unless explicitly provided otherwise in this Contract, the detailed sums shall be the full and exclusive compensation owed to the Contractor for the Work; and Contractor may not seek additional payments from the Village.

ARTICLE IV – APPLICATION FOR PAYMENT

The Contractor shall be paid at most once a month and only after providing the Village the following:

1. An executed and notarized Contractor’s Sworn Statement in a form similar to AIA G702 or AIA G703;
2. Either a partial or final lien waiver from every subcontractor, sub-subcontractor, or materialman in substantially the same form as attached here as **Contract Exhibit D** and **Contract Exhibit E**;
3. Certified payroll necessary for the Prevailing Wage Act; and

All payments under this Contract must be approved by the Village’s Board at regularly scheduled meetings. The Village reserves the right to request any receipts, invoices, proof of payments as the Village, in its sole discretion, may deem necessary to justify the payment requested *prior* to paying the requested payment. The Contractor shall furnish with his final application for payment a Final Lien Waiver from itself and, if not already provided, from every subcontractor and materialman of the Work.

The Contractor acknowledges that the Village is a unit of local government and that all payments under the Contract are subject to the Local Government Prompt Payment Act, 50 ILCS 505 et seq. To that extent, the Village shall have forty-five calendar (45) days from receipt of a bill or invoice to pay the same before it is considered late under the Contract. Interest, if any, charged for any late payments will be subject to the interest rate caps specified in the Prompt Payment Act.

ARTICLE V – CONTRACT TIME

The Contractor shall fully, and not substantially, complete all the Work and the Work shall be accepted by the Director of Public Works, provided that acceptance by the Director of Public Works shall not be unreasonably delayed, no later than _____ (B. PROJECT FINAL COMPLETION DATE)

If the Contractor shall fail to complete the work within the Contract Time which shall include any proper extension granted by the Village, the Contractor shall pay to the Village an amount equal to **Five Hundred dollars (\$500)** per calendar day for each day past the Contract Time until final acceptance by the Village, as liquidated damages and not as a penalty.

ARTICLE VI – PERFORMANCE and PAYMENT BOND

The Contractor shall provide the Village with a performance and payment bond in substantially the same form as on **Contract Exhibit C** (the “**Performance and Payment Bond**”) prior to Contractor beginning any Work and within 10 calendar days of the Notice of Award sent to the Contractor.

ARTICLE VII – ACCIDENT PREVENTION

The Contractor shall exercise every precaution at all times to protect itself, the property of the Village and the property of others. The safety provision of all applicable laws and ordinances shall be strictly observed by the Contractor at all times. Any practice deemed hazardous or dangerous by the Director of Public Works or his authorized representatives shall be immediately discontinued by the Contractor upon receipt of instructions from the Director of Public Works or his authorized representatives. To the fullest extent permitted by law, the Contractor shall be solely responsible for all safety-related matters.

ARTICLE VIII – INDEMNIFICATION

To the fullest extent permitted by law, the Contractor agrees to defend, pay on behalf of, indemnify, and hold harmless the Village, its elected and appointed officials, agents, employees and volunteers and others working on behalf of the Village against any and all claims, demands, suits or loss, including all costs connected therewith, and for any damages which may be asserted, claimed or recovered against or from the Village, its elected and appointed officials, agents, employees and volunteers and others working on behalf of the Village, by reason of personal injury, including bodily injury and death, and/or property damage, whether damage to property of the Village or of a third party, including loss of use thereof, which arises out of or is in any way connected or associated with the Contract and the Work.

For this project, the Village also hired a Consultant, Strand Associates Inc. The Contractor shall indemnify the Consultant in the same manner as the Village, as stated above.

ARTICLE IX – CONTRACTORS INSURANCE

Contractor shall procure and maintain, for the duration of the Contract and any maintenance period, insurance against claims for injuries to persons or damages to property, which may arise from or in connection with the performance of the work hereunder by the Contractor, his agents, representatives, employees or subcontractors.

A. Minimum Scope of Insurance: Coverage shall be at least as broad as:

Insurance Services Office Commercial General Liability occurrence form CG 0001 with the Village of Buffalo Grove named as additional insured on a primary and non-contributory basis. This primary, non-contributory additional insured coverage shall be confirmed through the following required policy endorsements: ISO Additional Insured Endorsement CG 20 10 or CG 20 26 and CG 20 01 04 13

1. Insurance Services Office Commercial General Liability occurrence form CG 0001 with the Village named as additional insured, on a form at least as broad as the ISO Additional Insured Endorsement CG 2010 and CG 2026
2. Insurance Service Office Business Auto Liability coverage form number CA 0001, Symbol 01 "Any Auto."
3. Workers' Compensation as required by the Labor Code of the State of Illinois and Employers' Liability insurance.

B. Minimum Limits of Insurance: Contractor shall maintain limits no less than:

1. Commercial General Liability: \$1,000,000 combined single limit per occurrence for bodily injury, personal injury and property damage. The general aggregate shall be twice the required occurrence limit. Minimum General Aggregate shall be no less than \$2,000,000 or a project/contract specific aggregate of \$1,000,000.
2. Business Automobile Liability: \$1,000,000 combined single limit per accident for bodily injury and property damage.
3. Workers' Compensation and Employers' Liability: Workers' Compensation coverage with statutory limits and Employers' Liability limits of \$500,000 per accident.

C. Deductibles and Self-Insured Retentions

Any deductibles or self-insured retentions must be declared to and approved by the Village. At the option of the Village, either: the insurer shall reduce or eliminate such deductibles or self-insured retentions as it respects the Village, its officials, agents, employees and volunteers; or the Contractor shall procure a bond guaranteeing payment of losses and related investigation, claim administration and defense expenses.

D. Other Insurance Provisions

The policies are to contain, or be endorsed to contain, the following provisions:

1. General Liability and Automobile Liability Coverages:
 - a. The Village, its officials, agents, employees and volunteers are to be covered as insureds as respects: liability arising out of activities performed by or on behalf of the Contractor; products and completed operations of the Contractor; premises owned, leased or used by the Contractor; or automobiles owned, leased, hired or borrowed by the Contractor. The coverage shall contain no special limitations on the scope of protection afforded to the Village, its officials, agents, employees and volunteers.
2. The Contractor's insurance coverage shall be primary and non-contributory as respects the Village, its officials, agents, employees and volunteers. Any insurance or self-insurance maintained by the Village, its officials, agents, employees and volunteers shall be excess of Contractor's insurance and shall not contribute with it.
3. Any failure to comply with reporting provisions of the policies shall not affect coverage provided to the Village, its officials, agents, employees and volunteers.
4. The Contractor's insurance shall contain a Severability of Interests/Cross Liability clause or language stating that Contractor's insurance shall apply separately to each insured against whom claim is made or suit is brought, except with respect to the limits of the insurer's liability.
5. If any commercial general liability insurance is being provided under an excess or umbrella liability policy that does not "follow form," then the Contractor shall be required to name the Village, its officials, employees, agents and volunteers as additional insureds
6. All general liability coverages shall be provided on an occurrence policy form. Claims-made general liability policies will not be accepted.
7. The contractor and all subcontractors hereby agree to waive any limitation as to the amount of contribution recoverable against them by the Village. This specifically includes any limitation imposed by any state statute, regulation, or case law including any Workers' Compensation Act provision that applies a limitation to the amount recoverable in contribution such as Kotecki v. Cyclops Welding

E. All Coverages:

1. No Waiver. Under no circumstances shall the Village be deemed to have waived any of the insurance requirements of this Contract by any act or omission, including, but not limited to:
 - a. Allowing work by Contractor or any subcontractor to start before receipt of Certificates of Insurance and Additional Insured Endorsements.
 - b. Failure to examine, or to demand correction of any deficiency, of any Certificate of Insurance and Additional Insured Endorsement received.
2. Each insurance policy required shall have the Village expressly endorsed onto the policy as a Cancellation Notice Recipient. Should any of the policies be cancelled before the expiration date thereof, notice will be delivered in accordance with the policy provisions.

F. Acceptability of Insurers

Insurance is to be placed with insurers with a Best's rating of no less than A-, VII and licensed to do business in the State of Illinois.

G. Verification of Coverage

Contractor shall furnish the Village with certificates of insurance naming the Village, its officials, agents, employees, and volunteers as additional insured's and with original endorsements, affecting coverage required herein. The certificates and endorsements for each insurance policy are to be signed by a person authorized by that insurer to bind coverage on its behalf. The certificates and endorsements are to be received and approved by the Village before any work commences. The Village reserves the right to request full certified copies of the insurance policies and endorsements.

H. Subcontractors

Contractor shall include all subcontractors as insured's under its policies or shall furnish separate certificates and endorsements for each subcontractor. All coverage's for subcontractors shall be subject to all of the requirements stated herein.

I. Assumption of Liability

The contractor assumes liability for all injury to or death of any person or persons including employees of the contractor, any subcontractor, any supplier or any other person and assumes liability for all damage to property sustained by any person or persons occasioned by or in any way arising out of any work performed pursuant to the Contract.

J. Workers' Compensation and Employers' Liability Coverage

The insurer shall agree to waive all rights of subrogation against the Village of Buffalo Grove, its officials, employees, agents and volunteers for losses arising from work performed by Contractor for the municipality.

K. Failure to Comply

In the event the Contractor fails to obtain or maintain any insurance coverage's required under this contract, The Village may purchase such insurance coverage's and charge the expense thereof to the Contractor.

L. Consultant

For this project, the Village also hired a Consultant, Strand Associates Inc. The Contractor shall include as an additional insured the Consultant in the same manner as the Village, as stated above. The Contractor shall also provide certificates and endorsements for the Consultants records.

ARTICLE X – CERTIFICATE OF AUTHORITY AND SURETY CERTIFICATE

The Contractor shall furnish the Village with a current Certificate of Authority or Surety Certificate issued by the Illinois Department of Insurance for the bonding company and insurance company they are using. In lieu of a Certificate of Authority of Surety Certificate, the Contractor may provide certificate of good standing from the Illinois Department of Insurance’s website.

ARTICLE XI – COPYRIGHTS AND LICENSES

The Contractor agrees that all documents of any kind whatsoever, and in whatever medium expressed, prepared by the Contractor and the Contractor’s consultants in connection with the Work (collectively, the “**Documents**”) or otherwise pursuant to this Contract and all rights therein (including trademarks, trade names, rights or use, copyrights and/or other proprietary rights) shall be and remain the sole property of the Village (regardless of whether the Village or the Contractor terminates this Contract for any reason whatsoever). The Contractor hereby agrees that the Documents are or shall be deemed to be “Works for Hire” within the meaning of Section 101 of the Copyright Act, and the Contractor hereby assigns to the Village all right, title and interest therein. Notwithstanding, the Contractor shall indemnify and hold harmless the Village, its appointed and elected officials, employees, agents and volunteers from and against all claims, damages, losses, and expenses (including attorneys’ fees and court and arbitration costs) arising out of any infringement of patent rights or copyrights incident to the Documents and the Work.

ARTICLE XII – NOTICE

All notices, demands, requests, consents, approvals and other communications required or permitted to be given hereunder (a “**Notice**”) shall be in writing and shall be deemed effective three (3) business days after mailing if mailed by certified mail with return receipt requested and immediately if served personally, and shall be addressed to the following:

IF TO THE VILLAGE: Village of Buffalo Grove
50 Raupp Blvd
Buffalo Grove, IL 60089
mreynolds@vbg.org
ATTN: Director of Public Works

WITH COPIES TO: Cc:pbrankin@schainbanks.com
Cc:brobinson@vbg.org

IF TO THE CONTRACTOR: _____

ATTN: _____

ARTICLE XIII – CHANGE ORDERS

If the Village requests any change to the Work the Village shall do so by delivering Notice of the same to the Contractor and the change requested by the Village shall be effective upon receipt of the Notice by the Contractor. The Contractor may propose a change to the Work by delivering Notice of the proposed change along with a description of the changes full effect on the Work to the Village; provided, such requested change shall not be deemed accepted until the Village has delivered to the Contractor Notice of the same. Prior to approving a proposed change to the Work by the Contractor, the Village may request such additional documentation as it deems necessary to investigate the proposed change. The Contractor shall be responsible for informing all its employees and subcontractors of any changes to the Work, whether such change is requested by the Contractor or the Village.

ARTICLE XIV – NOTICE OF STARTING WORK

The Contractor shall provide Notice to the Village prior to the Contractor, or its employees or subcontractors, starting the Work or any phase of the Work.

ARTICLE XV – SEQUENCE OF THE WORK

The Director of Public Works shall have the power to direct the order and sequence of the Work. On any major portion of the Work, all accessories shall be set coincident with the main construction. Payment for major portions of the Work may be withheld until proper completion of accessories.

ARTICLE XVI – SUPERVISION

The Director of Public Works shall have override power to superintend and direct the Work, and the Contractor shall perform all of the Work herein specified to the satisfaction, approval and acceptance of the Director of Public Works. The Contractor shall have at all times a competent foreman or superintendent at the Work's site, who shall have full authority to act for the Contractor and to receive and execute orders from the Director of Public Works, and any instructions given to such superintendant or person, executing work for the Contractor, shall be binding on the Contractor as though it was personally given to the Contractor.

ARTICLE XVII – STANDARD OF WORK AND WORKERS

The Contractor shall employ competent staff and shall discharge, at the request of the Director of Public Works, any incompetent, unfaithful, abusive or disorderly workers in its employ. Where experts or skilled workers must be employed, only expert or skilled workers shall be employed.

ARTICLE XVIII – CONDITIONS OF THE WORK SITE

The Contractor shall provide and maintain such sanitary accommodations for the use of its employees as may be necessary to comply with the State and local Board of Health requirements. Public nuisances will not be permitted. The Contractor shall leave said Work's site(s) in the best possible condition to the complete satisfaction of the Director of Public Works. No vehicles of any kind shall be placed, parked, or operated upon any grass areas at any time except as authorized by the Director of Public Works or his authorized representative. Further, the Contractor shall exercise every precaution for the protection of all persons and all property. The safety provisions of all-applicable laws and ordinances shall be strictly observed. Any practice hazardous in the opinion of the Director of Public Works or his authorized representatives shall be immediately discontinued by the Contractor upon his receipt of instructions from the Director of Public Works or his authorized representative. To the maximum extent permitted by law, the Contractor shall be responsible for all safety-related matters.

ARTICLE XIX – WARRANTY PERIOD

All material and workmanship shall be warranted and guaranteed according to manufacturer's recommendation after inspection and approval by the Director of Public Works or his designated representative. All work performed by the Contractor shall be warranted by the Contractor following completion and final acceptance of the Work for a period of twelve (12) months from the date of final, and not substantial, completion.

ARTICLE XX – ACCIDENTS

In the event of any accident of any kind that involves the general public or property of the Village or a third party, the Contractor shall immediately notify the Director of Public Works by phone as well as provide Notice of the same. The Notice shall include a full accounting of all details of the accident. The Contractor shall furnish the Village with copies of all reports of such accidents at the same time that the reports are forwarded to any other interested parties.

ARTICLE XXI – NO ASSIGNMENT

If the Contractor sublets or assigns any part of the Work then the Contractor shall not under any circumstances be relieved of its liabilities hereunder. All transactions of the Village shall be with the Contractor. Subcontractors shall be recognized only in the capacity of employees or workmen and shall be subject to the same requirements as to character and competence. The Contractor shall not assign, transfer, convey, sell or otherwise dispose of the whole or any part of this Contract to any person, firm or corporation without written consent of the Director of Public Works or his authorized representative.

ARTICLE XXII – DEFAULT

The following shall constitute a default an “**Event of Default**” by the Contractor under this Contract:

- A. If the Contractor shall fail to strictly observe or perform one or more of the terms, conditions, covenants and agreements of this Contract;
- B. If there shall be placed on any property owned by the Village any mechanics’, materialmens’ or suppliers’ lien;
- C. If there shall be instituted any proceeding against the Contractor seeking liquidation, dissolution or similar relief and the same shall not be dismissed within forty-five (45) calendar days;
- D. If there shall be appointed any trustee, receiver or liquidator of the Contractor and such appointment shall not have been vacated within forty-five (45) calendar days; and
- E. If the Contractor fails to maintain or obtain any and all permits, licenses and the like, if any, required by the Village, State or Federal governments for the Work.

Upon any Event of Default the Village shall have the option of (i) terminating the Contract; (ii) pursuing any remedy available to it at law or in equity; or (iii) pursuing both simultaneously. In addition, upon an Event of Default, the Village may withhold payments due to the Contractor until it has hired a replacement of the Contractor and deducted all costs of hiring a replacement.

ARTICLE XXIII – DELAYS

The Contractor shall not be liable in damages for delays in performance when such delay is the result of fire, flood, strike, acts of God, or by any other circumstances which are beyond the control of the Contractor; provided, however, under such circumstances the Village may, at its option, cancel the Contract.

ARTICLE XXIV – COMPLIANCE WITH LAWS

The Contractor shall comply with all applicable laws, regulations and rules promulgated by any federal, state, local, or other governmental authority or regulatory body pertaining to all aspects of the Work, now in effect, or which may become in effect during the performance of the Work. The scope of the laws, regulations, and rules referred to in this paragraph includes, but is in no way limited to, the Illinois Human Rights Act, Illinois Equal Pay Act of 2003, Occupational Safety & Health Act along with the standards and regulations promulgated pursuant thereto (including but not limited to those safety requirements involving work on elevated platforms), all forms of traffic regulations, public utility, Interstate and Intrastate Commerce Commission regulations, Workers’ Compensation Laws, Public Construction Bond Act, Public Works Preference Act, Employment of Illinois Workers on Public Works Act, USA Security Act, federal Social Security Act (and any of its titles), and any other law, rule or regulation of the Illinois Department of Labor, Department of Transportation, Illinois Environmental Protection Act, Illinois Department of Natural Resources, Illinois Department of Human Rights, Human Rights Commission, EEOC, and the Village of Buffalo Grove. Notwithstanding the following, the Contractor shall particularly note that:

- A. **NO DISCRIMINATION** – The Contractor shall comply with the provisions of the Illinois Public Works Employment Discrimination Act and the Illinois Human Rights Act/Equal Opportunity Clause which, pursuant to Illinois law, are deemed to be part of this Contract.

B. FREEDOM OF INFORMATION - The Contractor agrees to furnish all documentation related to the Contract, the Work and any documentation related to the Village required under an Illinois Freedom of Information Act (ILCS 140/1 et. seq.) (“**FOIA**”) request within five (5) calendar days after the Village issues Notice of such request to the Contractor. The Contractor agrees to defend, indemnify and hold harmless the Village, and agrees to pay all reasonable costs connected therewith (including, but not limited to attorney’s and witness fees, filing fees and any other expenses) for the Village to defend any and all causes, actions, causes of action, disputes, prosecutions, or conflicts arising from Contractor’s actual or alleged violation of FOIA or the Contractor’s failure to furnish all documentation related to a FOIA request within five (5) calendar days after Notice from the Village for the same. Furthermore, should the Contractor request that the Village utilize a lawful exemption under FOIA in relation to any FOIA request thereby denying that request, Contractor agrees to pay all costs connected therewith (such as attorneys' and witness fees, filing fees and any other expenses) to defend the denial of the request. This defense shall include, but not be limited to, any challenged or appealed denials of FOIA requests to either the Illinois Attorney General or a court of competent jurisdiction.

C. ILLINOIS WORKERS ON PUBLIC WORKS ACT - To the extent applicable, the Contractor shall comply with the Illinois Workers on Public Works Act, 30 ILCS 570/1 et seq., and shall provide to the Village any supporting documentation necessary to show such compliance.

D. NOT A BLOCKED PERSON - The Contractor affirms and covenants that neither the Contractor nor any individual employed by the Contractor for this Work or under this Contract is a person forbidden from doing business with a unit of local government under Executive Order No. 13224 (Sept 23, 2001), 66 Fed.Reg. 49,079 (Sept 23, 2001) or is a person registered on the Specially Designated Nationals and Blocked Persons List. The Contractor shall indemnify the Village from all costs associated with failure to comply with this paragraph.

E. SUBSTANCE ABUSE PREVENTION ON PUBLIC WORKS ACT - The Contractor knows, understands and acknowledges its obligations under the Substance Abuse Prevention on Public Works Act (820 ILCS 265/1 et seq.), and shall comply and require all subcontractors and lower tiered contractors to comply with the requirements and provisions thereof.

F. PREVAILING WAGE ACT - The Village is an Illinois unit of local government and the Work hereunder is subject to the Illinois Prevailing Wage Act, 820 ILCS 130/0.01, et seq. Consequently, the Contract and each subcontractor shall submit monthly with their application for payment a certified payroll along with a signed statement attesting that: (i) such payroll is true and accurate; (ii) the hourly rate paid to each worker is at least equal to the prevailing wage for such work; and (iii) the Contractor or subcontractor is aware that filing a falsely certified payroll is a Class B Misdemeanor. Any delay in processing the payments due to a lack of certified payroll shall not be an event of default by the Village and shall not excuse any delay by the Contractor who shall proceed with the Work as if no delay in payment has occurred. The Contractor and Village shall agree to take any further steps not outlined above to ensure compliance with the Prevailing Wage Act. Upon two business day’s Notice, the Contractor and each subcontractor shall make available to the Village their records to confirm compliance with the Prevailing Wage Act. Finally, to ensure compliance with Prevailing Wage Act, the Contractor and each subcontractor shall keep for a period of not less than 5 years after the Work has been completed records of all laborers, mechanics, and other workers employed by them for the Work; the records shall include each worker’s name, address, telephone number, classification or classifications, the hourly wages paid in each period, the number of hours worked each day, the starting and ending times of work each day and, when available, last four digits of the social security number. The Contractor shall provide a list of every name, address, phone number and email of every sub-contractor for the Work.

Current rates can be located on the Illinois Department of Labor website.

<https://www2.illinois.gov/idol/Laws-Rules/CONMED/Pages/2019-Rates.aspx>

ARTICLE XXV – NO WAIVER OF RIGHTS

A waiver by the Village of any Event of Default or any term of provision of this Contract shall not be a waiver of the same Event of Default, another Event of Default or any other term or provision of this Contract.

ARTICLE XXVI – CONTROLLING LAW AND VENUE

This Contract is entered into in the State of Illinois, for work to be performed in the State of Illinois and shall be governed by and construed in accordance with the laws of the State of Illinois. Any legal matters or dispute shall be resolved in the Circuit Court of Cook County and the Parties hereby submit to the jurisdiction of such Circuit Court. This Contract shall be construed without regard to any presumption or other rule requiring construction against the Party causing the Contract to be drafted.

ARTICLE XXVII – MISCELLANEOUS

- A. AMENDMENT** – This Contract may be amended only in writing executed by both Parties.
- B. NO RECORDING** – This Contract, or a memorandum thereof, may not be recorded in any form by either Party. If either Party records this Contract, or a memorandum thereof, they shall immediately file a release of the same.
- C. SECTION HEADINGS** – The headings in the Contract are intended for convenience only and shall not be taken into consideration in any construction or interpretation of the Contract.
- D. NO THIRD PARTY BENEFICIARIES** – This Contract does not confer any rights or benefits on any third party.
- E. BINDING EFFECT** – This Contract shall be binding and inure to the benefit of the Parties hereto, their respective legal representatives, heirs and successors-in-interest.
- F. ENTIRE AGREEMENT** – This Contract supersedes all prior agreements and understandings and constitutes the entire understanding between the Parties relating to the subject matter hereof.
- G. SEVERABILITY** - If any term, condition or provision of the Contract is adjudicated invalid or unenforceable, the remainder of the Contract shall not be affected and shall remain in full force and effect, to the fullest extent permitted by law.
- H. TORT IMMUNITY DEFENSES** - Nothing contained in this Contract is intended to constitute nor shall constitute a waiver of the rights, defenses, and immunities provided or available to the Village under the Local Governmental and Governmental Employees Tort Immunity Act, 745 ILCS 10 *et seq.*

- I. **CALENDAR DAYS AND TIME.** Unless otherwise provided in this Contract, any reference in this Contract to “day” or “days” shall mean calendar days and not business days. If the date for giving of any notice required to be given, or the performance of any obligation, under this Contract falls on a Saturday, Sunday or federal holiday, then the notice or obligation may be given or performed on the next business day after that Saturday, Sunday or federal holiday.
- J. **COUNTERPARTS** – This Contract may be executed by the Parties in any any number of counterparts, each of which shall be deemed an original, but all of which together shall constitute an original instrument.

IN WITNESS WHEREOF, the Parties hereto have caused the Contract to be executed as of the Effective Date.

Village of Buffalo Grove,
an Illinois home-rule unit of government

Company
[An Illinois _____ company]

By: _____
Name: Dane Bragg
Title: Village Manager

By: _____
Name: _____
Title: _____

CONTRACT EXHIBIT A- DESCRIPTION OF WORK

This project consists of the installation of 2-inch saddles and 2-inch water main taps in five existing water system valve vaults and the installation of new vaults over existing water main followed by 2-inch saddles and 2-inch taps in the water main in the new vaults in five locations throughout the Village of Buffalo Grove.

The following Drawings titled “Water Distribution Flow Meter Installations - Smart Water Pilot Program” dated August 2019 describe the project and are included in the Contract:

SHEET 1	TITLE SHEET
SHEET 2	INDEX OF SHEETS / STANDARDS
SHEET 3	OVERALL SITE MAP / GENERAL NOTES
SHEET 4	INSERTION SADDLE AND VALVE VAULT DETAILS
SHEET 5	SADDLE DETAILS
SHEET 6 to 17	INSTALLATION LOCATIONS
SHEET 18	CONSTRUCTION DETAILS - 1
SHEET 19	CONSTRUCTION DETAILS - 2
SHEET 20	MATERIAL SPECIFICATIONS

CONTRACT EXHIBIT B- SCHEDULE OF PRICES

[Insert Schedule of Prices From Bid Documents]

CONTRACT EXHIBIT C - FORM OF PERFORMANCE AND PAYMENT BOND

Bond Number: _____

KNOW ALL MEN BY THESE PRESENTS, That _____ (the "Principal") and _____ (the "Surety"), are held and firmly bound unto the Village of Buffalo Grove, an Illinois home-rule unit of government (the "Village"), the full and just sum of _____ Dollars (\$_____) in lawful money of the UNITED STATES OF AMERICA as herein provided.

THE CONDITION OF THIS OBLIGATION is such that the Principal and Surety agree to bind themselves, their successors, assigns, executors, heirs and administrators, jointly and severally, for the full and faithful performance of the Work as defined in that particular Smartwater Zone Meter Install contract between Principal and the Village dated __ day of _____, 20__, (hereinafter referred to as the "Contract"), a copy of which is attached and incorporated by reference as though fully set forth herein.

NOW THE CONDITIONS OF THIS OBLIGATION ARE SUCH that if the said Principal (i) shall in all respects keep and perform all the undertakings, covenants, terms, conditions and agreements of the Contract; (ii) shall pay all sums of money due or to become due, for any labor, materials, apparatus, fixtures or equipment furnished for the Work provided in said Contract; and (iii) shall remove and replace any defects in workmanship or materials which may be apparent or may develop within the ARTICLE XIX – WARRANTY PERIOD of the Contract, then this obligation shall be null and void; otherwise it shall remain in full force and effect.

And the said Surety, for value received, hereby stipulates and agrees that no change, extension of time, alteration or addition to the terms of the Contract or the Work thereunder shall in any way affect its obligation on this Bond, and it does hereby waive notice of any such change, extension of time, alteration or addition to the terms of the Contract or to the Work.

IN WITNESS WHEREOF, we have hereunto set our hands and sea ___ day of _____, 20__.

SURETY

PRINCIPAL

By: _____
Name: _____
Title: _____

By: _____
Name: _____
Title: _____

ATTEST

ATTEST

By: _____

By: _____

NOTE: Date of Bond must not be prior to date of Contract.
If Contractor is Partnership, all partners should execute Bond.
IMPORTANT: Surety companies executing Bonds must appear on the Treasury Departments most current list (Circular 570 as amended) and be authorized to transact business in the state where the Work is located.

CONTRACT EXHIBIT D – PARTIAL LIEN WAIVER

PARTIAL LIEN WAIVER

STATE OF ILLINOIS

COUNTY OF _____

TO WHOM IT MAY CONCERN:

WHEREAS the undersigned has been employed by _____
 to furnish _____
 for the premises known as _____
 of which _____ is the owner.
 THE undersigned, for and in consideration of _____
 (\$ _____

) Dollars, and other good and valuable considerations, the receipt whereof is hereby acknowledged, do(es) hereby waive and release any and all lien or claim of, or right to, lien, under the statutes of the State of Illinois, relating to mechanics' liens, with respect to and on said above-described premises, and the improvements thereon, and on the material, fixtures, apparatus or machinery furnished, and on the moneys, funds or other considerations due or to become due from the owner, on account of all labor, services, material, fixtures, apparatus or machinery, furnished to this date by the undersigned for the above-described premises, INCLUDING EXTRAS.*

DATE _____ COMPANY NAME _____
 ADDRESS _____
 SIGNATURE AND TITLE _____

*EXTRAS INCLUDE BUT ARE NOT LIMITED TO CHANGE ORDERS, BOTH ORAL AND WRITTEN, TO THE CONTRACT

CONTRACTOR'S AFFIDAVIT

STATE OF ILLINOIS

COUNTY OF _____

TO WHOM IT MAY CONCERN:

THE UNDERSIGNED, (NAME) _____ BEING DULY SWORN, DEPOSES
 AND SAYS THAT HE OR SHE IS (POSITION) _____ OF
 (COMPANY NAME) _____ WHO IS THE
 CONTRACTOR FURNISHING _____ WORK ON THE BUILDING
 LOCATED AT _____
 OWNED BY _____

That the total amount of the contract including extras* is \$ _____ on which he or she has received payment of \$ _____ prior to this payment. That all waivers are true, correct and genuine and delivered unconditionally and that there is no claim either legal or equitable to defeat the validity of said waivers. That the following are the names and addresses of all parties who have furnished or delivered material or labor, or both, for said work and all parties having contracts or sub contracts for specific portions of said work or for material entering into the construction thereof and the amount due or to become due to each, and that the items mentioned include all labor and material required to complete said work according to plans and specifications:

NAMES AND ADDRESSES	WHAT FOR	CONTRACT PRICE INCLUDE EXTRAS*	AMOUNT PAID	THIS PAYMENT	BALANCE DUE
TOTAL LABOR AND MATERIAL INCLUDING EXTRAS* TO COMPLETE					

That there are no other contracts for said work outstanding, and that there is nothing due or to become due to any person for material, labor or other work of any kind done or to be done upon or in connection with said work other than above stated.

DATE _____ SIGNATURE: _____
 SUBSCRIBED AND SWORN TO BEFORE ME THIS _____ DAY OF _____

*EXTRAS INCLUDE BUT ARE NOT LIMITED TO CHANGE ORDERS, BOTH ORAL AND WRITTEN, TO THE CONTRACT.

 NOTARY PUBLIC

CONTRACT EXHIBIT E- FINAL LIEN WAIVER

FINAL WAIVER OF LIEN

STATE OF ILLINOIS

COUNTY OF _____

TO WHOM IT MAY CONCERN:

WHEREAS the undersigned has been employed by _____
to furnish _____
for the premises known as _____
of which _____ is the owner.

THE undersigned, for and in consideration of _____
(\$ _____) Dollars, and other good and valuable considerations, the receipt whereof is hereby acknowledged,
do(es) hereby waive and release any and all lien or claim of, or right to, lien, under the statutes of the State of Illinois, relating
to mechanics' liens, with respect to and on said above-described premises, and the improvements thereon, and on the material,
fixtures, apparatus or machinery furnished, and on the moneys, funds or other considerations due or to become due from the
owner, on account of all labor, services, material, fixtures, apparatus or machinery, heretofore furnished, or which may be
furnished at any time hereafter, by the undersigned for the above-described premises, INCLUDING EXTRAS.*

DATE _____ COMPANY NAME _____

ADDRESS _____

SIGNATURE AND TITLE _____

*EXTRAS INCLUDE BUT ARE NOT LIMITED TO CHANGE ORDERS, BOTH ORAL AND WRITTEN, TO THE CONTRACT

CONTRACTOR'S AFFIDAVIT

STATE OF ILLINOIS

COUNTY OF _____

TO WHOM IT MAY CONCERN:

THE UNDERSIGNED, (NAME) _____ BEING DULY SWORN, DEPOSES
AND SAYS THAT HE OR SHE IS (POSITION) _____ OF
(COMPANY NAME) _____ WHO IS THE
CONTRACTOR FURNISHING _____ WORK ON THE BUILDING
LOCATED AT _____
OWNED BY _____

That the total amount of the contract including extras* is \$ _____ on which he or she has received payment of
\$ _____ prior to this payment. That all waivers are true, correct and genuine and delivered unconditionally and that
there is no claim either legal or equitable to defeat the validity of said waivers. That the following are the names and addresses
of all parties who have furnished or delivered material or labor, or both, for said work and all parties having contracts or sub
contracts for specific portions of said work or for material entering into the construction thereof and the amount due or to
become due to each, and that the items mentioned include all labor and material required to complete said work according to
plans and specifications:

NAMES AND ADDRESSES	WHAT FOR	CONTRACT PRICE INCLDG	AMOUNT PAID	THIS PAYMENT	BALANCE DUE
TOTAL LABOR AND MATERIAL INCLUDING EXTRAS*					

That there are no other contracts for said work outstanding, and that there is nothing due or to become due to any person for
material, labor or other work of any kind done or to be done upon or in connection with said work other than above stated.

DATE _____ SIGNATURE: _____

SUBSCRIBED AND SWORN TO BEFORE ME THIS _____ DAY OF _____

*EXTRAS INCLUDE BUT ARE NOT LIMITED TO CHANGE
ORDERS, BOTH ORAL AND WRITTEN, TO THE CONTRACT.

NOTARY PUBLIC