



CONTRACT DOCUMENTS AND SPECIFICATIONS

FOR

PROJECT # 1818

S. FRASER STREET (US HWY 17) SANITARY SEWER AND MANHOLE REHABILITATION

JANUARY 2024

MAYOR
CAROL JAYROE

CITY ADMISITRATOR
SCOTT WHITTIER

COUNCIL MEMBERS
JIM CLEMENTS
JONATHAN ANGNER
BRUCE CARL
ERIN ETHRIDGE
JIMMY MORRIS
TAMIKA WILLIAMS-OBENG

CITY ENGINEER
ORLANDO ARTEAGA, PE

BIDDING DOCUMENTS

CONTRACTOR: _____

ADDRESS: _____

CONTRACTOR'S LICENSE NUMBER: _____

CONTRACT DOCUMENTS AND SPECIFICATIONS

FOR

PROJECT # 1818

S. FRASER STREET (US HWY 17)
SANITARY SEWER AND MANHOLE REHABILITATION

Plans and Specifications Prepared by:



Weston & Sampson Engineers, Inc.
1201 Main Street, Suite 930, Columbia, SC 29201
W&S # ENG23-0476

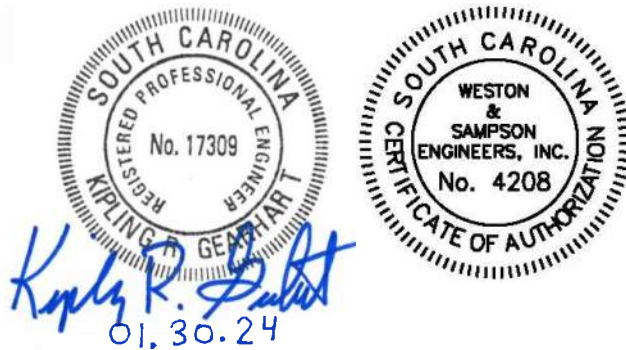

SOUTH CAROLINA CERTIFICATE OF AUTHORIZATION

The Standard Technical Specifications ("specifications") and Construction Details ("detail") bound into this booklet have been reviewed by Weston & Sampson ("Engineer") and have been found to be in conformance and consistent with the construction illustrated in the design drawings ("plans") prepared for this utility construction project. Discrepancies found between the plans and the specifications and the details shall be communicated to the Engineer and for interpretation in accordance with the General Conditions stated in the Contract Documents.

THIS PAGE INTENTIONALLY LEFT BLANK

TECHNICAL SPECIFICATIONS
TABLE OF CONTENTS

DIVISION 01 GENERAL REQUIREMENTS

01010	Summary of Work
01025	Measurement and Payment
01026	Applications for Payment
01035	Change Order Procedures
01045	Cutting, Coring, and Patching
01046	Control of Work
01170	Special Provisions
01200	Project Meetings
01300	Submittals
01310	Construction Scheduling
01320	Construction Photographs and Video Recording
01370	Schedule of Values
01400	Quality Control
01490	Mobilization/Demobilization
01500	Temporary Facilities
01570	Maintenance and Protection of Traffic
01600	Delivery, Storage and Handling
01720	Record Documents
01735	Warranties and Bonds
01740	Contract Closeout

DIVISION 02 SITE WORK

02210	Work in South Carolina Department of Transportation Rights-Of-Way
02221	Trench Excavation, Bedding and Backfill
02230	Granular Fill Materials
02240	Dewatering and Drainage
02250	Sheeting and Bracing
02270	Sedimentation and Erosion Control
02575	Pavement, Markings, and Appurtenances
02730	Sanitary Sewer Systems
02731	Ductile Iron Sewer Pipe
02733	Sanitary Sewer Service Connections
02800	Sewer Line Cleaning
02801	Sanitary Sewer CCTV Inspection
02803	Cured-In-Place Pipe Lining (CIPP)
02804	Cured-In-Place Pipe Lining (CIPP) – Ultraviolet (UV) Cured
02805	Grouting Mains and Lateral Connections
02806	Sewer Service Lateral CIPP Lining
02807	Manhole Lining
02860	Sanitary Sewer Flow Control

DIVISION 03 CONCRETE

03600 Grouting

APPENDIX I – PACP Main Line CCTV Reports

APPENDIX II – MACP Level II Manhole Inspection Reports

END OF SECTION

DIVISION 1

PAGE INTENTIONALLY LEFT BLANK

SECTION 01010
SUMMARY OF WORK

PART 1 GENERAL

1.01 LOCATION OF WORK

- A. The work of this Contract is located along S. Fraser Street from Bourne St. to Front St. within the City of Georgetown, South Carolina.

1.02 SCOPE OF WORK

- A. Furnish all labor, materials, equipment and incidentals required to construct and install the replacement and rehabilitation of sewer manholes, mainlines, and service lines in its entirety as shown on the Drawings and as specified herein. Work shall be completed between the hours of 7:00PM to 6:00 AM.
- B. The Work includes, but is not necessarily limited to, the following:
 - 1. Maintenance of Traffic
 - 2. Point repairs via open cut
 - 3. CIPP Lining of Sewer Mainlines (8, 12 & 15-inch)
 - 4. Raising manhole
 - 5. Installing new manhole
 - 6. Manhole repairs (Chimney, Cone, Wall, Bench, Channel & Inverts)
 - 7. Manhole lining
 - 8. Chimney seals
 - 9. Service lateral end seals

1.03 SUGGESTED GENERAL WORK SEQUENCE

- A. Perform Work in sequence listed below to accommodate the Owner's uninterrupted use of the existing facilities during the construction period and to ensure completion of the Work in the Contract Time. The Contractor is responsible for bypassing sewer flow during the execution of the work to prevent sanitary sewer overflows (SSO) or back-ups.
 - 1. Submit materials to be used for construction to Engineer.
 - 2. Submit bypass plan for the replacement of manhole 1828.
 - 3. Coordinate/Submit traffic control plan to SCDOT for approval for the replacement of manhole 1828.

4. Distribute notifications to property owners, emergency agencies, and regulatory agencies.
5. Replace manhole 1828 (intersection of S. Fraser St./US Hwy 17 & Front St.)
6. Complete point repair work.
7. Perform sewer main line rehabilitation via CIPP.
8. Perform manhole rehabilitation.
9. Conduct post-rehabilitation CCTV and submit video and PDF reports to Engineer for review.
10. Coordinate with Engineer and Owner for final review and project close-out.

1.04 CONTRACTOR'S USE OF PREMISES

- A. Contractor shall limit the use of the premises for his/her Work and for storage to allow for:
 1. Owner occupancy.
 2. Public use.
- B. The assets constructed and/or rehabilitated under this Contract will replace existing assets and may impact the operation and/or performance of existing facilities in the vicinity of the Work. The Contractor shall be responsible for maintaining sewer flows throughout construction duration.
- C. Coordinate use of premises with the Owner and the Engineer.
- D. Contractor shall assume full responsibility for security of all his/her and his/her subcontractors materials and equipment stored on the site.
- E. If directed by the Owner or Engineer, move any stored items which interfere with operations of Owner or other contractors.
- F. Obtain and pay for use of additional storage or work areas if needed to perform the Work.

END OF SECTION

SECTION 01025
MEASUREMENT AND PAYMENT

PART 1 - GENERAL

1.1 SCOPE OF WORK

- A. This Section includes specifications for the measurement and payment of the various elements of the Work; with provisions applicable to lump sum prices, unit prices, and allowances, if applicable.
- B. The Contractor shall receive no payment for any portion of the work until it is installed. The only exception to this is payment for stored materials on site if the Contract provides for the payment of stored materials.

1.2 LUMP SUM ITEMS

- A. Lump Sum measurement will be for the entire item, unit of work, structure, or combination thereof, as specified and as indicated in the Schedule of Prices in the Bid Form. Measurement and payment for all bid items indicated as Lump Sums shall include the cost of all labor, materials and equipment necessary to furnish, install, clean, test, and place each bid item into operation; including permitting, general conditions, overhead and profit.
- B. Progress payments will be based on the Schedule of Values, as specified in Section 01370, prepared by the Contractor and approved by the Owner/Engineer before acceptance of the first Application for Payment.
- C. In order for the Contractor to request progress payments against Lump Sum items, Contractor shall provide a breakdown in sufficient measurable detail that is acceptable to the Owner/Engineer.
- D. Measurement
 - 1. Measurement shall be based on the estimated percent complete of each Lump Sum item based on the Schedule of Values, as specified in Section 01370.
- E. Payment
 - 1. Payment will be made at the lump sum price proportional to the completion percentages approved by the Owner/Engineer.

1.3 UNIT PRICE ITEMS

- A. Quantity and measurement estimates stated in the Schedule of Prices in the Bid Form are estimates for bidding purposes only. Actual payments shall be based on actual quantities installed, in-place, as measured and/or verified by the Owner/Engineer.

- B. Unless otherwise provided in the General Conditions, the bid unit prices shall be in effect throughout the contract duration, regardless of variances between the estimated quantities and the actual installed quantities.
- C. The Contractor shall make no claim, nor receive any compensation, for anticipated profits, loss of profit, damages, or any extra payment due to any difference between the amounts of work actually completed, or materials or equipment furnished, and the estimated quantities.
- D. Unless otherwise approved by the Owner, any unit quantities exceeded may not be invoiced until the estimated quantity is increased by contract change order.
- E. Contractor shall assist Owner/Engineer by providing necessary equipment, workers, and survey personnel as required to measure quantities.
- F. Measured quantities shall be rounded to the nearest whole integer, unless the value of the unit price exceeds \$100, in which case measured quantities shall be rounded to the nearest half unit.
- G. Measurement
 - 1. Measurement for progress payment shall be made by, or approved by, the Owner/Engineer based on the estimated effective quantity installed. The effective quantity installed represents the actual units or quantities installed, adjusted for incomplete elements or components.
 - 2. Unless otherwise provided for in the Schedule of Prices in the Bid Form, unit price items are all-inclusive of all related work, direct and indirect, to provide a complete and functional item. For example, underground water pipe installation would include pipe, trenching, shoring, dewatering, bedding, installation, backfill, testing, flushing, disinfection, and commissioning; including all labor, materials and equipment necessary to furnish, install, clean, test, and place into operation; including permitting, general conditions, overhead and profit.
 - 3. The final measurement shall be based on actual quantities, jointly measured by Contractor and Owner/Engineer.
- H. Payment
 - 1. Progress payments shall be in accordance with the contract documents based on estimated effective quantities installed, paid at the bid unit price.
 - 2. The final payment shall be based on actual quantities, fully installed, tested and placed into service, paid at the bid unit price.

PART 2 - BID ITEMS

2.1 MISCELLANEOUS WORK (PART A)

- A. Mobilization/Demobilization and Related Expenses (Item A1)
 - 1. Method of Measurement.

- a. Mobilization, demobilization and related expense shall be a lump sum. This Item is meant for non-recurrent and general expenses related to establishment and close out of the Work.
2. Basis of Payment.
 - a. Mobilization, demobilization and related expenses shall be paid for on a lump sum basis. This price and payment shall be full compensation for all costs associated with initiating and completing the Contract, exclusive of the cost of materials. Payment shall include compensation for all expenses related to moving equipment onto and away from the jobsite, performance and payment bonds and other securities required, insurances, necessary permits and fees, posting required notices, project sign, Engineer's and Contractor's field office installation, if required, including hooking up initial utilities, site preparation, removal of any field offices and temporary utilities and roadways, removal of signs, submittal of all record documents, and the general costs associated with initiating the Work on site to assure that it is proceeding in a continuous manner. No additional payment shall be made for interim mobilization or demobilization associated with shutdown of Work by Contractor or Owner.
 - b. Mobilization, demobilization and related expenses shall also include all Contract general requirements including but not limited to full compensation for furnishing construction schedules including baseline and periodic updates; providing and maintaining the quality control plan; providing the project superintendent, project manager and project Engineer (if applicable) full-time; maintaining on-site field office and Engineer's field office if required; recurring expenses following initial mobilization; providing and maintaining dumpsters, security, fencing, and dust control; monthly utility charges; construction photographs; ongoing maintenance of Record Drawings; equipment maintenance; surveying, survey controls, and staking out of easements; project closeout costs; and all temporary facilities, labor, equipment and materials required for or incidental to the Work for which separate payment is not provided under other Bid Items.
 - c. Payments shall be made in three equal installments. The first two (2) installments shall coincide with the first two (2) monthly payment requisitions, contingent upon Owner acceptance of the baseline construction schedule, compliance with Section 01490 and demonstration of satisfactory construction progress, as determined by the Owner/Engineer. The third installment shall be made when the Contractor has completed all construction activity, including final cleanup, punch list Items, compliance with Section 01490 and satisfactory submission of Record Drawings.
 - d. The cost for this Item (A-1) shall not exceed three percent (3.0%) of the Total Bid Price, excluding this Item itself.

B. Maintenance and Protection of Traffic (Item A2)

1. Method of Measurement.
 - a. Maintenance and Protection of Traffic shall be a lump sum. This Item shall include costs related to traffic control that may be required over the term of the Work for the entire Contract.
2. Basis of Payment.

- a. Maintenance and protection of traffic shall be paid for at the contract lump sum price. This price and payment shall be full compensation for all costs associated with labor, equipment and services involved in the preparation of control plans; erection, maintenance, moving, adjusting, cleaning, replacement of damaged or worn devices, and removal of devices; labor for any required flaggers; and all other Items furnished by the Contractor as well as all costs of labor and equipment involved in performing the maintenance of vehicular and pedestrian traffic and all other Items necessary to complete the Work as shown and specified but not included for payment under other Items in the Schedule of Prices.
 - b. Payment shall be made as determined by the Owner/Engineer on a percent complete basis in accordance with the accepted Schedule of Values (Section 01370).
- C. Gathering Manhole GIS Data for Newly Found Assets in the Field (Item A3)
1. Method of Measurement.
 - a. Gathering manhole GIS data for newly found assets in the field shall be measured by the actual number of new manholes found and data gathered from said manhole.
 2. Basis of Payment.
 - a. Payment for gathering manhole GIS data for newly found assets and incorrectly identified assets in the field shall be for the quantity as above determined at the Contract unit price bid in the Schedule of Prices. This price and payment shall be full compensation for all labor, materials and equipment necessary for surveying the new asset, capturing all measurements and elevations specified in the technical specification, locating and indicating all pipe sizes and materials of pipes coming into and out of the new manhole, assigning an asset identification code in association with the Owner, collecting photographs as specified and if required, and all else incidental thereto for which separate payment is not provided under other items in the Schedule of Prices.
- D. Erosion and Sedimentation Control (Item A4)
1. Method of Measurement.
 - a. Erosion and sedimentation control shall be a lump sum. This Item shall include costs related to erosion and sedimentation control that may be required over the term of the Work for the entire Contract.
 2. Basis of Payment.
 - a. Erosion and sedimentation control shall be full compensation for all labor, equipment, materials and incidentals necessary to control erosion as specified in the technical specification, including but not limited to, furnishing, installing, maintaining, and removal of the erosion and sedimentation control devices, silt fences, stone for filtration devices, filter boxes, straw mulch, erosion control blankets, and all else incidental thereto for which separate payment is not provided under other Bid Items.

- c. All bypass pumping needs for the work to replace manhole 1828, at the intersection of Front St. and S. Fraser St. shall be included in the Bypass Pumping Operations bid item.
 3. Exclusion. Bypass Pumping Operations for CIPP installation and manhole lining shall not be included or associated with this line item. This bypass pumping shall be specifically paid under the pipe bursting line item.

2.2 PVC SEWER PIPE, MANHOLES AND APPURTENANCES

A. Precast Concrete Manholes (Items B1)

1. Method of Measurement
 - a. Precast concrete manholes will be measured in vertical feet from the invert of the lowest pipe of the manhole to the top of the manhole frame.
2. Basis of Payment
 - a. Payment for furnishing and installing concrete manholes complete in place will be made for the quantity as above determined at the price per vertical foot bid for Items B1 through B2, which price and payment shall be full compensation for all excavation (except rock and boulder), backfilling, flowable fill, for furnishing and installing precast sections and bases, platforms, damproofing, frames and covers, screened gravel subbase, all forms, reinforcing, concrete and masonry materials, top slabs for shallow manholes if used, leakage testing, and all else incidental thereto, for which separate payment is not provided under other items in the Schedule of Prices.
 - b. 60-inch diameter manholes shall be billed as Item B1.

2.3 SEWER REHABILITATION (PART C)

A. Cured-in-Place Pipe – Manhole to Manhole (Items C1 through C3)

1. Method of Measurement.
 - a. Cured-in place pipe (CIPP) shall be measured by the actual number of linear feet of CIPP installed, measured in place along the centerline of the pipe from center-to-center of the manholes of the various sizes indicated. Measurement shall be to the nearest foot. Only CIPP accepted by the Owner/Engineer shall be measured. No separate payment shall be made for unclogging service laterals as a result of the operation.
2. Basis of Payment.
 - a. Cured-in place pipe shall be paid for by the respective quantities, at the sizes defined, as determined above at the Contract unit price bid in the Schedule of Prices. This price and payment will be full compensation for furnishing all materials, labor, tools,

equipment and appurtenances required or otherwise necessary to satisfactorily complete the Work including light hydraulic cleaning, pre-television inspection, post-construction television inspection from manhole to manhole, stopping of active leaks that would interfere with the integrity of the liner to be installed, all approved liner repairs, removal and disposal of debris and any other obstructions excluding mechanical heavy cleaning, obtaining water, repairs to private property, public notification, odor control measures, sewer flow control, maintenance of flow in existing sewers with bypass pumping and maintenance of plugs, hydrophilic end seals, acceptance testing, care and protection of all property, and all costs, labor, materials, and equipment incidental thereto, for which separate payment is not provided under other items in the Schedule of Prices.

- b. 8-inch diameter CIPP shall be billed as Item C1.
- c. 12-inch diameter CIPP shall be billed as Item C2.
- d. 15-inch diameter CIPP shall be billed as Item C3.

B. DIP Point Repairs (Items C4 through C7)

1. Method of Measurement.

- a. DIP sewer point repairs for sanitary sewer mains shall be measured as the actual number of completed repairs accepted by the Owner/Engineer. Depths shall be from the ground surface to the invert of the pipe. Each point repair shall be a minimum 20 linear feet within a sewer reach identified.
- b. DIP sewer point repairs beyond the initial 20 linear feet shall be approved by City of Georgetown or their field representative prior to working be performed. Point repairs beyond 20 linear feet will be measured on a linear foot basis beyond the first 20 feet.
- c. Measurement shall be made along the horizontal centerline of the pipe with no deduction for fittings and shall be to the centerline of the adaptor at connections to existing pipe and/or to the inside edge of the manhole when repair is tied into manhole. Depths shall be from the ground surface to the invert of the pipe.

2. Basis of Payment.

- a. DIP sewer point repairs shall be paid for the respective quantities as determined above at the Contract unit price bid in the Schedule of Prices. The price and payment shall be full compensation for furnishing, laying and jointing the DIP pipe; fittings; couplings; removal and disposal of existing pipe types to be replaced; saw-cutting of pavement if required; excavation (except for rock and boulder removal); basic dewatering and drainage as specified in technical specification, support of excavation and protection of the sewer, existing utilities and structures; furnishing and installing all bedding and backfill materials up to but not including the pavement section (refer to Figure 4 Pavement Repairs on sheet C-500 for more information);

compaction; #57 stone; flowable fill; connections to existing and/or new manholes including coring of existing manholes; connecting to existing pipes; PVC wyes and tees and reconnection of any services; testing the pipe (including conducting post installation CCTV inspection of main line pipe from manhole to manhole); diversion and/or maintenance of existing flows; bypass pumping; control of groundwater and surface or drainage waters; protection, crossing, and supporting of existing structures and utilities; replacement of existing utilities disturbed during construction; care and protection of property; coordination with other contractors and utilities; and all other Items necessary to complete the Work as shown and specified but not included for payment under other Items in the Schedule of Prices.

C. Mechanical Heavy Sewer Cleaning/Silt Removal (Item C8)

1. Method of Measurement.

- a. Mechanical heavy sewer cleaning and silt/root removal shall be measured by the actual number of linear feet of pipe cleaned as approved by the Owner/Engineer. Pipe shall be measured in place along the centerline of the pipe from the center of manhole to center of manhole of each pipe. Measurement shall be to the nearest foot of the actual footage of what was cleaned.

2. Basis of Payment.

- a. Mechanical heavy sewer cleaning and silt/root removal of the existing sewer pipe shall be paid for the respective quantities as determined at the Contract unit price bid in the Schedule of Prices. This price and payment shall be full compensation for locating existing manholes; the removal, transportation, and disposal of debris within the sewers in accordance with these Specifications; for obtaining water; maintenance of flow in existing sewers including bypass pumping and plugs necessary for mechanical heavy sewer cleaning and root removal; and all else incidental thereto for which separate payment is not provided for under other items in the Schedule of Prices.

D. Reconnect Active Service Laterals to CIPP Lined Pipe, All Sizes All Depths (Item C9)

1. Method of Measurement.

- a. Reconnection of active service laterals to CIPP lined pipe shall be measured by the actual number of laterals reinstated. It shall be the contractor's responsibility to reinstate all active taps.

2. Basis of Payment.

- a. Reconnection of active service laterals shall be paid for each building lateral reinstated as determined above at the Contract unit price bid in the Schedule of Prices. This price and payment shall be full compensation for coordination with property owners; maintenance of sewer service flow; cleaning, removal and disposal of debris; furnishing all required equipment, reinstating all active service lateral as shown in CCTV; removal of liner coupon, and all else incidental thereto for which separate payment is not provided under other items in the Schedule of Prices.

E. Furnish and Install New Flexible Chimney Seals (Items C10)

1. Method of Measurement.

- a. Sewer manhole chimney seals for existing sewer manhole chimneys using an internal chimney lining system shall be measured in place on a per manhole basis. Measurement shall be based on completion of each chimney, including the replacement of broken or cracked bricks, the application of cementitious mortar to structurally restore the chimney, and preparation of the chimney for the installation of the internal chimney lining system.

2. Basis of Payment.

- a. Sewer manhole chimney lining shall be paid for the quantity as above determined at the Contract unit price bid in the Schedule of Prices. This price and payment shall be full compensation for removal and disposal of all unsuitable materials; stopping all active leaks with chemical or cementitious grout; cleaning; preparation of the chimney for the seal; furnishing and installing the internal chimney seal system and all else incidental thereto for which separate payment is not provided under other items in the Schedule of Prices.

F. Repairing and Rebuilding Brickwork for Inverts, Benches, Walls, and Chimneys in Manholes (Item C11)

1. Method of Measurement.

- a. Repairing or rebuilding of brickwork in existing masonry manholes shall be measured by the actual number of manholes repaired or rebuilt. Repairs or rebuilding to include work to the barrel section walls, transition sections, chimneys, benches, pipe connections, and inverts.

2. Basis of Payment.

- a. Repairing or rebuilding of existing manholes shall be paid for at the Contract unit price bid in the Schedule of Prices. This price and payment shall be full compensation for all labor, materials and equipment necessary for cleaning; stopping all active leaks with chemical or cementitious grout; maintenance of flow in existing sewers including bypass pumping and plugs; chipping away loose material; removal of existing manhole steps; protection of existing sewer lines; furnishing and installing all required masonry materials and brickwork; repairing and rebuilding manhole barrel section walls, transition sections, chimneys, benches, inverts and pipe connections as directed by the Owner/Engineer; and all incidentals thereto, for which separate payment is not provided under other items in the Schedule of Prices.

G. Coating all Manhole Inverts with Quick-Setting Grout (Items C12)

1. Method of Measurement.

- a. Coating of all manhole inverts with a quick-setting grout shall be measured by the actual number of manholes coated.
2. Basis of Payment.
 - a. Coating of all manhole inverts with a quick-setting grout shall be paid for at the Contract unit price bid in the Schedule of Prices. This price and payment shall be full compensation for all labor, materials and equipment necessary for cleaning, removal of all debris, application of the coating specified, maintenance of flow in existing sewers including bypass pumping and plugs, and repair as directed by the Owner/Engineer and all incidentals thereto, for which separate payment is not provided under other items in the Schedule of Prices.
- H. Sewer Manhole Monolithic Lining (Items C13)
1. Method of Measurement.
 - a. Sewer manhole monolithic lining for sealing of existing sewer manholes using monolithic surfacing system, shall be measured in place on a vertical foot basis from the invert of the lowest pipe of the manhole to the top of the manhole and chimney interface.
 2. Basis of Payment.
 - a. Sewer manhole monolithic lining for sealing of existing manholes using monolithic lining system, shall be paid for the quantity as above determined at the Contract unit price bid in the Schedule of Prices. This price and payment shall be full compensation for preparatory cleaning of the manhole walls and invert; sealing pipe connections and stopping active leaks with chemical or cementitious grout; maintenance of flow in existing sewers including bypass pumping and plugs; furnishing and installing the manhole monolithic lining system as specified; reopening all active manhole connections; proper disposal of cleaning solvents; materials testing; environmental protection; final acceptance testing and all else incidental thereto for which separate payment is not provided under other items in the Schedule of Prices.
- I. Removal and Disposal of Protruding Taps (Item C14)
1. Method of Measurement.
 - a. Removal of protruding taps shall be measured by the actual number of taps cut off and removed as determined by the Owner/Engineer.
 2. Basis of Payment.
 - a. Removal of protruding taps shall be paid for each building lateral cut off by a remote liner cutter as determined above at the Contract unit price bid in the Schedule of Prices. This price and payment shall be full compensation for coordination with property owners; maintenance of sewer service flow; cleaning, removal and disposal of debris; furnishing all required equipment, cutting each protruding tap with a remote-controlled cutting device; removal of cut tap, and all else incidental thereto

for which separate payment is not provided under other items in the Schedule of Prices.

2.4 ALTERNATE BID ITEMS (UNIT PRICE NOT PART OF BASE BID)

A. Sewer Service Lateral CIPP End Seals (Item A-7)

1. Method of Measurement.

- a. Sewer service cured-in-place (CIPP) end seals, shall be measured for payment by the actual number of CIPP end seals installed. No separate payment shall be made for unclogging service laterals as a result of the operation.

2. Basis of Payment.

- a. Sewer service lateral cured-in-place (CIPP) end seals, shall be paid for the respective quantities as determined at the Contract unit prices bid in the Schedule of Prices. This price and payment shall be full compensation for project notices; coordination with property owners; cleaning the existing service pipe and connection; removal of obstructions; removal and disposal of debris; performing post-construction television inspection (from sewer main to the cleanout); furnishing written logs and DVDs; stopping active infiltration; furnishing and installing the service lateral connection end seal; materials testing and acceptance; environmental protection; and all else incidental thereto for which separate payment is not provided under other items in the Schedule of Prices.

END OF SECTION

THIS PAGE INTENTIONALLY LEFT BLANK

SECTION 01026
APPLICATIONS FOR PAYMENT

PART 1 GENERAL

1.01 SCOPE OF WORK

- A. This section includes the requirements that the Contractor shall follow for submitting applications for payment. Requirements in this section supplement additional requirements contained in Section 00700.
- B. Its noted that the Owner, at its sole discretion, may authorize the Engineer to act on its behalf for any or all the of the tasks describe herein.

1.02 RELATED WORK

- A. Section 00700 - Conditions of Contract.
- B. Section 01025 - Measurement and Payment.
- C. Section 01370 - Schedule of Values.

1.03 PROCEDURES FOR SUBMITTING APPLICATIONS FOR PAYMENT

- A. The Contractor shall submit his draft Application for Payment on or before the third working day of each month, or another specific day established at the Pre-Construction Meeting as authorized by the Owner's Project Manager (PM). The Owner will pay the Contractor the value of the work performed, as approved by the Engineer, less retainage, less the aggregate of previous payments, typically within 21 working days of receipt from Engineer of final approved Application for Payment. Draft Applications for Payment that are submitted later will require additional time for processing for payment.
- B. The Owner's approving authority, usually the Engineer, will review the draft Application for Payment and provide the Contractor with comments typically within 10 working days. The Contractor then shall address all comments and be prepared to submit a final Application for Payment on the established date of the Monthly Construction Progress meeting. Final Applications for Payment that are submitted later will require additional time for processing for payment.
- C. Each Application for Payment shall be an itemized Application for Payment that includes the work completed as of the date indicated the application, with supporting documentation showing the extent of the work and/or quantities for which payment is requested. Supporting documentation shall be in a form such as drawings that represent the actual measurements and dimensions so they can be field verified and/or used in subsequent Applications for Payment. Previous quantities paid shall also be shown in the supporting documentation for comparison purposes and for tracking previous quantities paid and the respective locations at which they were paid.

- D. Each Application for Payment shall include a summary showing Adverse Weather Days incurred for the month and the supporting documentation from NOAA station at the GEORGETOWN LT.HOUSE, WINYAH BAY, SC (Station ID: 8662747) confirming the Adverse Weather experienced, as specified in Section 00700. Failure to submit this summary on a monthly basis forfeits the Contractor's rights to further adverse weather claims.
- E. Applications for Payment will be made using the Owner's standardized Application for Payment form(s). The PM will provide the Contractor an electronic copy of the form(s) prior to the first pay request. The Contractor shall reference the project name, purchase order number, description, and Owner's project number on all pay requests.
- F. All final Applications for Payment must be addressed to the PM. Four (4) original Application for Payments shall be signed, dated, notarized and submitted for payment. Payments will not be processed from copies. At the Owner's discretion, electronic submittals may be allowed if authorized at the Pre-Construction Meeting.
- G. If the Construction Management Team requests changes prior to payment or rejects payment in its entirety, the Contractor will be notified of those changes and/or the reasons for rejection and what the Contractor must do before the Application for Payment will be considered.
- H. Submittal of an itemized Application for Payment and supporting documentation by the Contractor shall indicate that the Contractor has inspected those portions of the work included in the application and has determined and certifies that all portions of the work are in compliance with the Contract Documents and that the quantities submitted for payment are true and accurate.
- I. Recommendations for payment will constitute a representation by the Owner based on supporting data that, to the best of the Owner's knowledge, information and belief, the work has progressed to the point indicated. However, recommendation for payment does not waive claims for defects, does not constitute acceptance of work not in accordance with the Contract Documents, does not indicate that the work was constructed in accordance with the Contract Documents and does not relieve the Contractor of the responsibility to correct any deficiencies or damaged work that may be found at a later date.
- J. If payment is requested on a basis of materials not yet incorporated into the work but which are delivered, suitably stored, and verified by the PM, the bill of sale, invoice, or other documentation shall be submitted with the Application for Payment warranting to the Owner that the materials are free and clear of all liens and evidenced that the materials are covered by appropriate property insurance or other arrangements showing protection of materials. Payment for stored materials shall be limited to 60 percent of the contract price listed in the Schedule of Values. Stored materials shall be stored at an Owner approved location within the State of South Carolina. Payment for stored materials does not imply acceptance. Include in the Application for Payment amounts applied for materials or equipment purchased or fabricated and stored, but not yet installed. Differentiate between items stored on-site and items stored off-site.
 - 1. Provide certificate of insurance, evidence of transfer of title to Owner, and consent of surety to payment, for stored materials.

2. Provide supporting documentation that verifies amount requested, such as paid invoices. Match amount requested with amounts indicated on documentation: do not include overhead and profit on stored materials.
 3. Provide summary documentation for stored materials. Submit and maintain a Stored Materials Log. The Stored materials Log will indicate the following:
 - a. Value of materials previously stored and remaining stored as of date of previous Applications for Payment.
 - b. Value of previously stored materials put in place after date of previous Application for Payment and on or before date of current Application for Payment.
 - c. Value of materials stored since date of previous Application for Payment and remaining stored as of date of current Application for Payment.
- K. The Owner may withhold, in whole or in part, payments previously made to such extent as may be necessary in the Owner's opinion to protect the Owner from loss for which the Contractor is responsible, including loss resulting from acts and/or omissions of the Contractor's employees, subcontractors and their agents and employees, and other persons or entities performing portions of the work for, or on behalf of, the Contractor or any of its subcontractors because of, but not limited to, the following:
1. Defective work not remedied;
 2. Third party claims filed or reasonable evidence indicating probable filing or such claims unless security acceptable to the Owner is provided by the Contractor;
 3. Failure of the Contractor to make payments properly to subcontractors or for labor, materials and/or equipment;
 4. Reasonable evidence that the work cannot be completed for the unpaid balance of the Contract Sum;
 5. Damage to the Owner or another Contractor;
 6. Reasonable evidence that the work will not be completed within the Contract Time, and that the unpaid balance would not be adequate to cover actual or liquidated damages for the anticipated delay; or
 7. Persistent and repeated failure to carry out the work in accordance with the Contract Documents.
- L. The Contractor agrees that he will indemnify and hold the Owner harmless from all claims growing out of the lawful demands of subcontractors, laborers, workmen, mechanics, material, men, and furnishers of machinery and parts thereof, equipment, power tools, and all supplies, including commissary, incurred in the performance of this contract. The Contractor shall, at the Owner's request, furnish satisfactory evidence that all obligations of nature hereinabove designated have been paid discharged, or waived. If the Contractor fails to do this the Owner may, after having served written notice on the Contractor, either pay unpaid bills, of which the

Owner has written notice, or withhold from the Contractor's unpaid compensation a sum of money deemed reasonably sufficient by the Owner to pay any and all lawful claims. When satisfactory evidence, as determined by the Owner, is furnished that all liabilities have been fully discharged, payment to the Contractor shall be resumed in accordance with the terms of this Contract. In no event shall the provisions of this paragraph be construed to impose any obligations upon the Owner to either the Contractor or his surety. In paying any unpaid bills of the Contractor, the Owner shall be deemed the agent of the Contractor, and any payment so made by the Owner shall be considered as payment made under the Contract to the Contractor, and the Owner shall not be liable to the Contractor for any such payment made in good faith.

1.04 PROCEDURES FOR SUBMITTING APPLICATIONS FOR FINAL PAYMENT

- A. The Contractor shall submit the following to the Owner prior to the Owner releasing final payment:
1. A certified copy of Engineer's Substantial Completion Punch List endorsed and dated by Owner/Engineer. Certified copy of the list shall state that each item has been completed or otherwise resolved for acceptance. Owner/Engineer will promptly make such inspection and, when the Work is found acceptable under the Contract Documents and the Contract fully performed, the Owner/Engineer will promptly issue a final Certificate for Payment stating that to the best of the Owner/Engineer's knowledge, information and belief and on the basis of on-site visits and inspections, the Work has been completed in accordance with terms and conditions of the Contract Documents and that the entire balance found to be due the Contractor and noted in the final Certificate is due and payable.
 2. In the event Contractor requests an inspection for final acceptance and it is determined that the Work is not ready and additional work is required, Contractor shall reimburse Owner for all additional Engineer fees incurred by Owner as a consequence of such re-inspection, if such re-inspection is necessitated solely by the Contractor's default.
 3. An affidavit that payrolls, bills for materials and equipment, and other indebtedness connected with the project for which the Owner or the Owner's property might be responsible or encumbered (less amounts withheld by the Owner) have been paid or otherwise satisfied.
 4. A certificate evidencing that insurance required by the Contract Documents to remain in force after final payment is currently in effect and will not be canceled or allowed to expire until at least 30 days' prior written notice has been given to the Owner.
 5. A written statement that the Contractor knows of no substantial reason that the insurance will not be renewable to cover the period required by the Contract Documents. Consent of surety, if any, to final payment. Data establishing payment or satisfaction of obligations, such as receipts, releases and waivers of liens, claims, security interests or encumbrances arising out of the Contract, to the extent and in such form as may be designated by the Owner.
- B. The making of final payment and retainage shall constitute a waiver of Claims by the Owner except those arising from:
1. Liens, claims, security interests or encumbrances arising out of the Contract and unsettled.

2. Failure of the work to comply with the requirements of the Contract Documents.
 3. Terms of all warranties and service plans required by the Contract Document.
- C. Upon completion and final acceptance by the Owner of all work covered under this Contract, the Owner will pay to the Contractor the amount remaining to be paid under the Contract.

END OF SECTION

THIS PAGE INTENTIONALLY LEFT BLANK

SECTION 01035
CHANGE ORDER PROCEDURES

PART 1 GENERAL

1.01 REQUIREMENTS INCLUDE

- A. Promptly implement change order procedures including providing full written data required to evaluate changes. Maintain detailed records of all work done on a time-and-material basis.
- B. Contractor shall maintain a Change Order Log. The Log shall include a sequential Change Order number, shall indicate both approved change orders (COs) and potential change orders (PCOs), description of the work, CO or PCO amount, and cumulative contract amounts. The Owner/ Engineer shall keep a similar log and the Contractor shall resolve any discrepancies between the Owner/Engineer log and his log at each monthly Construction Progress Meeting.

1.02 RELATED REQUIREMENTS

- A. Section 00500 - Contract.
- B. Section 00700 - Conditions of the Contract.
- C. Section 01026 - Applications for Payment.
- D. Section 01300 – Submittals.
- E. Section 01720 - Project Record Documents.

1.03 DEFINITIONS

- A. Change Order (CO) – if an amendment to the Contract Documents includes a change in the contract price or the contract time, such amendment must be set forth in a CO. The Owner and Contractor may amend terms and conditions of the Contract Documents that involve:
 - 1. Performance or acceptability of the work;
 - 2. The design (as set forth in the drawings, specifications, or otherwise) with approval of the Engineer, or;
 - 3. Other engineering or technical matters, without the approval of the Engineer.
- B. Work Change Directives (WCD) - a WCD will not change the contract price or the contract time but is evidence that the parties expect that the modification ordered or documented by a WCD will be incorporated in a subsequently issued CO. Contractor must submit any PCO seeking an adjustment of the contract price or the contract times, or both, no later than 30 days after the completion of the work set out in the WCD. Owner must submit any claim seeking an

adjustment of the contract price or the contract times, or both, no later than 60 days after issuance of the WCD.

- C. Field Orders (FO) – The Owner may authorize minor changes in the work or interpretations/clarifications of the Contract Documents if the changes or clarifications do not involve an adjustment in the contract price or the contract time and are compatible with the design concept of the project. Such changes will be binding on the Owner and also on Contractor. If Contractor believes that a FO justifies an adjustment in the contract price or contract time, or both, then before proceeding with the work at issue, the Contractor shall submit a PCO.
- D. Request for Proposal (RFP) – the Owner/Engineer may initiate changes by submitting a RFP to the Contractor.

1.04 PRELIMINARY PROCEDURES

- A. Owner/Engineer may initiate changes by submitting a RFP to the Contractor. The Owner shall provide the Contractor with a standard RFP request form. The response to the RFP by the Contractor shall include:
 - 1. Detailed description of the change and its associated cost.
 - 2. Products required and location of the change.
 - 3. Supplementary or revised Drawings and Specifications.
 - 4. The projected time span for making the change and a specific statement as to whether overtime work is, or is not, authorized.
 - 5. A specific period of time during which the requested price will be considered valid.
 - 6. Such request is for information only and is not an instruction to execute the changes, nor to stop work in progress.
- B. Contractor may initiate a PCO by submitting a written notice to Owner, containing:
 - 1. Description of the proposed changes.
 - 2. Statement of the reason for making the changes.
 - 3. Statement of the effect on the contract price and time with supporting documentation.

1.05 WORK DIRECTIVE CHANGE AUTHORIZATION

- A. In lieu of a RFP, Owner/Engineer may issue a work directive authorization for Contractor to proceed with a change for subsequent inclusion in a Change Order.

- B. Authorization will describe changes in the work, both additions and deletions, with attachments of revised Contract Documents to define details of the change and will designate the method of determining any change in the Contract price and any change in Contract time.
- C. Owner/Engineer will sign and date the Work Directive Change Authorization as authorization for the Contractor to proceed with the changes.
- D. Contractor may sign and date the Work Directive Change Authorization to indicate agreement with the terms therein.

1.06 DOCUMENTATION OF PROPOSALS AND CLAIMS

- A. Support each quotation for either a lump-sum proposal or unit price which has not previously been established, with sufficient substantiating data to allow Owner/Engineer to evaluate the quotation.
- B. On request, provide additional data to support time and cost computations including:
 - 1. Labor required.
 - 2. Equipment required.
 - 3. Products required.
 - a. Recommended source of purchase and unit cost.
 - b. Quantities required.
 - 4. Taxes, insurance and bonds.
 - 5. Credit for work deleted from Contract, similarly documented.
 - 6. Overhead and profit.
 - 7. Justification for any change in Contract time.
- C. Support each claim for additional costs for work done on a time-and-materials basis with the following documentation:
 - 1. Name of the Owner's authorized agent who ordered the work and date of the order.
 - 2. Dates and times work was performed and by whom.
 - 3. Time record, summary of hours worked and hourly rates paid.
 - 4. Receipts and invoices for:
 - a. Equipment used, listing dates and times of use.
 - b. Products used, listing of quantities.
 - c. Subcontracts.

1.07 PREPARATION OF CHANGE ORDERS

- A. Contractor will prepare and submit a PCO to the Owner/Engineer. PCO shall be prepared on a form or format acceptable to the Owner.
- B. The PM will negotiate the PCO. At the Owner's sole discretion this task may be delegated to the Engineer.
- C. Owner/Engineer will add and track progress of PCO from receipt through to final determination on a PCO/CO log which will be reconciled monthly with the Contractor's PCO/CO log.
- D. PCO will describe reason for changes, changes in the work, both additions and deductions, with attachments of revised Contract Documents to define details of the change.
- E. PCO will provide an accounting of the adjustment in the Contract price and in the Contract time.
- F. PM will determine if PCO will become CO and prepare Owner CO form and submit to Owner for the certification process.
- G. Owner performs CO certification process which may include approval for Design and Construction, Compliance, and Finance Department, and possibly other associated departments.
- H. Owner receives executed CO and issues hard copy notification to Contractor.

PART 2 PRODUCTS (NOT USED)

PART 3 EXECUTION (NOT USED)

END OF SECTION

SECTION 01045
CUTTING, CORING, AND PATCHING

PART 1 GENERAL

1.01 SCOPE OF WORK

- A. This Section covers the cutting, coring, rough and finished patching of holes and openings. Holes and openings may be in existing construction, or in parts of new construction. Procedures for cutting and patching will be the same for either condition.
- B. Provide all cutting, filling and patching, including excavation and backfill, required to complete the work or to:
 - 1. Make material parts fit together properly.
 - 2. Remove and replace defective work.
 - 3. Provide penetrations of structural surfaces and materials for installation of piping, ductwork, equipment and electrical conduit.
 - 4. Provide penetrations of non-structural surfaces and materials for installation of piping, ductwork, equipment and electrical conduit. The determination of what is a nonstructural surface or material shall be made by the Engineer.
 - 5. Remove, install, or relocate materials or equipment.

1.02 RELATED WORK

- A. Section 01010 - Summary of Work.
- B. Site work is included in Division 02.
- C. Cast-in-place concrete is included in Division 03.

1.03 SUBMITTALS

- A. Submit, in accordance with Section 01300, a written request prior to executing any cutting or alteration which is not shown or detailed on the Contract Documents which affects or requires:
 - 1. Cutting structural members.
 - 2. Holes drilled in beams or other structural members.
 - 3. Work of the Owner or any separate contractor.
 - 4. Structural value or integrity of any element of the project.
 - 5. Integrity or effectiveness of weather-exposed or moisture-resistant elements or systems.
 - 6. Efficiency, operational life, maintenance or safety of operational elements.

7. Visual qualities of sight-exposed elements.
- B. Request shall include:
1. Description of affected work.
 2. The reason for cutting, alteration or excavation.
 3. Effect on work of Owner or any separate contractor, or on structural or weatherproof integrity of project.
 4. Description of proposed work:
 - a. Method and extent of cutting, patching, alteration, or excavation.
 - b. Trades who will execute the work.
 - c. Products proposed to be used.
 - d. Extent of refinishing to be done.
 5. Alternatives to cutting and patching.
 6. Confirmation of coordination with any separate contractor whose work will be affected.
 7. Related shutdown requests if required to do the work.
 8. Request for hot work permission if required to do the work.
- C. Submit written notice to the Owner/Engineer designating the date and the time the work will be completed.
- D. When a written request is required, do not proceed with the work until a written notice to proceed is received from the Owner/Engineer.

PART 2 PRODUCTS

2.01 MATERIALS

- A. Comply with specifications and standards for each specific product involved.
- B. Concrete and grout for rough patching shall be as specified.
- C. Materials for finish patching shall be equal to those of adjacent construction. Where existing materials are no longer available, use materials with equivalent properties and that will provide the same appearance. The materials are to be approved by the Owner/Engineer prior to their use.

PART 3 EXECUTION

3.01 INSPECTION

- A. Inspect existing conditions of project, including elements subject to damage or to movement during cutting and patching.
- B. After uncovering work, inspect conditions affecting installation of products, or performance of work.
- C. Report unsatisfactory or questionable conditions to the Owner/Engineer in writing; do not proceed with work until further instructions have been received.

3.02 PREPARATION

- A. Provide adequate temporary support as necessary to assure structural value or integrity of affected portion of work.
- B. Protect surrounding materials and equipment prior to starting work.
- C. Contain and control cooling liquids and slurry produced by the cutting and coring operations.
- D. When the cutting or coring will result in the structure or equipment being exposed, provide adequate weather protection.
- E. Provide dewatering for excavation work if deemed necessary by the Owner/Engineer.

3.03 PERFORMANCE

- A. Execute cutting and demolition by methods which will prevent damage to other work and will provide proper surfaces to receive installation of repairs.
- B. Execute excavating and backfilling by methods which will prevent settlement or damage to other work. When excavating in close proximity to piping, duct banks or other items subject to damage, use hand excavation.
- C. All equipment and workplace safety shall conform to OSHA standards and applicable Contract Specifications and building codes.
- D. Execute fitting and adjustment of products to provide a finished installation to comply with specified products, functions, tolerances and finishes.
- E. Restore work which has been cut or removed; install new products to provide completed work in accordance with requirements of Contract Documents.
- F. Refinish entire surfaces as necessary to provide an even finish to match adjacent finishes:
 - 1. For continuous surfaces, refinish to nearest intersection.
 - 2. For an assembly, refinish entire unit.
- G. Remove rubble and excess patching materials from the premises.

3.04 CORING

- A. All coring shall be performed in such a manner as to limit the extent of patching. Locate the rebar before coring to minimize cut throughs
- B. Coring shall be performed with an approved non-impact rotary tool with diamond core drill bits.
- C. Size of holes shall be suitable for pipe, conduit, sleeves, equipment or mechanical seals to be installed.
- D. Fit work to minimize space to pipes, sleeves, ducts, conduit and other penetrations through surfaces.
- E. Fit to pipes and other penetrations in tanks to be water tight using seals or other methods defined in the specifications.
- F. All holes cut through concrete and masonry walls, slabs or arches shall be core drilled unless otherwise approved. All work shall be performed by mechanics skilled in this type of work.
- G. If holes are cored through floor slabs they shall be drilled from below where possible. If holes are drilled from above, provide protection and containment below the area being drilled to catch the plug and contain liquid and slurry.

3.05 CUTTING

- A. All cutting shall be performed in such a manner as to limit the extent of patching.
- B. Fit work to minimize space to pipes, sleeves, ducts, conduit and other penetrations through surfaces.
- C. Cutting shall be performed with a concrete saw and diamond saw blades of proper size.
- D. Provide for control of slurry generated by sawing operation on both sides of wall and from below if cutting a floor.
- E. When cutting a reinforced concrete wall or floor, the cutting shall be done so as not to damage the bond between the concrete and reinforcing steel left in structure. Cut shall be made so that steel neither protrudes nor is recessed from face of the cut.
- F. Adequate bracing of area to be cut shall be installed prior to start of cutting. Check area during sawing operations for partial cracking and provide additional bracing as required to prevent a partial release of cut area during sawing operations.
- G. Provide equipment of adequate size to remove cut panel.
- H. Saw cut concrete and masonry prior to breaking out sections.
- I. Install work to minimize the amount of cutting and patching.
- J. All cutting of structural members shall be done in a manner directed by the Owner/Engineer.

- K. When existing conduits or pipe sleeves are cut off at the floor line or wall line, they shall be filled with grout or suitable patching material.

3.06 PATCHING

- A. Rough patching shall be such as to bring the cut or cored area flush with existing construction unless otherwise shown.
- B. Finish patching shall match existing surfaces as approved.
- C. Patching shall be of the same kind and quality of material as was removed.
- D. The completed patching work shall restore the surface to its original appearance or better.
- E. Patching of waterproofed surfaces shall render the area of the patching completely waterproofed to include the joint between the existing material and the patch.

3.07 PROTECTION

- A. Provide devices and methods to protect other portions of project from damage.
- B. Provide protection from elements for that portion of the project which may be exposed by cutting and patching work.
- C. Maintain excavations free from water.
- D. Equipment damaged during cutting and patching shall be replaced or repaired at or replaced at no additional cost to the Owner.
- E. Repaint any damage to factory applied paint finishes using touch-up paint. The damaged section shall be repainted in accordance with appropriate specifications at the expense of the Contractor doing the work.
- F. Slurry or tailings resulting from coring or cutting operations shall be contained and vacuumed or otherwise removed from the area following drilling or cut.
- G. Equipment and utilities shall be protected against mechanical and water damage during cutting and patching. Provide protective covers or use other means such as temporary relocation to protect equipment that is at risk of damage from the cutting and patching.

END OF SECTION

THIS PAGE INTENTIONALLY LEFT BLANK

SECTION 01046
CONTROL OF WORK

PART 1 GENERAL

1.01 SCOPE OF WORK

- A. This Section is intended to ensure that the Contractor provides adequate labor, materials, and equipment to complete the construction with minimum disturbance to the public, private land, existing infrastructures, and other private property. These are general guidelines. It is the Contractor's responsibility to determine the specific construction techniques to meet these guidelines.

1.02 RELATED WORK

- A. Section 01570 - Maintenance and Protection of Traffic

1.03 LABOR AND EQUIPMENT

- A. Furnish all labor and equipment which will be sufficient, appropriate and large enough to secure a satisfactory quality of work to the Owner, and a rate of progress which will ensure the completion of the work within the Contract Time. If at any time such labor and equipment appears to be inefficient, inappropriate, or insufficient for securing the quality of work required or for producing the rate of progress aforesaid, Owner/Engineer may order the Contractor to increase the efficiency, change the character or increase the labor and equipment and the Contractor shall conform to such order. Failure of the Owner/Engineer to give such order shall in no way relieve the Contractor of his obligations to secure the quality of the work and rate of progress required.

1.04 ACCESS TO THE SITE

- A. Representatives of the U.S. Environmental Protection Agency, the South Carolina Department of Health and Environmental Control and any other state and any local agencies having a direct interest in the work shall have access to the work wherever it is in preparation or progress and the contractor shall provide proper facilities and safety precautions as necessary for such access and inspection.

1.05 EMERGENCY RESPONSE

- A. The Contractor shall at all times (including nights, weekends or holidays) have a responsible person available to act in case of emergency repairs whom the Owner may contact. Upon notification of any emergency work necessary, the Contractor's representative shall immediately take steps to make such repairs as may be required.
- B. In case of any emergency which threatens loss or injury of property and/or safety or life, the Contractor will be allowed to act, without previous instructions from the Owner/Engineer, in a diligent manner. He shall notify the Owner/Engineer immediately thereafter. Any claim for compensation by the Contractor due to such extra work shall be promptly submitted for review by the Owner.

- C. Where the Contractor has not taken action but has notified the Owner/Engineer of an emergency threatening injury to persons or damage to the work or any adjoining property that is not in any way related or due to the Contractor's work, negligence or performance, he shall act as instructed or authorized by the Owner/Engineer.

1.06 PRIVATE LAND

- A. Do not enter or occupy private land outside of easements, except by written permission of the landowner.

1.07 PIPE AND OTHER UTILITY LOCATIONS

- A. Existing pipelines and utilities are located substantially as indicated on the Drawings. The Owner/Engineer reserves the right to make such modifications in new pipeline locations as may be found desirable to avoid interference with existing structures, pipes or utilities or for other reasons.
- B. Where fittings are noted on the Drawings, such notations are for the Contractor's convenience and does not relieve him from laying and jointing differently or for providing and installing additional items where required.

1.08 OPEN EXCAVATIONS

- A. Adequately safeguard all open excavations by providing temporary barricades, caution signs, lights and other means to prevent accidents to persons and damage to property. Provide suitable and safe bridges and other crossings for accommodating travel by pedestrians and workmen. Remove bridges provided for access during construction when no longer required.
- B. The length or size of excavation will be controlled by the particular surrounding conditions, but shall always be confined to the limits indicated in the Contract Documents. If the excavation becomes a hazard, or if it excessively restricts traffic at any point, the Owner/Engineer may require special construction procedures such as limiting the length of the open trench, prohibiting stacking excavated material in the street and/or requiring that the trench shall not remain open overnight.
- C. Take precautions to prevent injury to the public due to open trenches. Provide adequate light at all trenches, excavated material, equipment, or other obstacles which could be dangerous to the public at night.
- D. The Contractor shall keep trenches and excavated areas as well as the site construction areas free from water. The Contractor shall remove all water, including rainwater, encountered during trench and sub-structure work by pumps, drains, and other approved methods. Additional dewatering requirements are specified in the technical specifications.

1.09 MAINTENANCE OF TRAFFIC

- A. Traffic control, detours and signage shall be provided as shown on the Contract Documents and as specified in Section 01570.
- B. Unless permission to close a street is received in writing from the proper authority, place all excavated material so that vehicular and pedestrian traffic may be maintained at all times. If the

construction operations cause traffic hazards, Contractor shall repair the road surface, provide temporary ways, erect wheel guards or fences, or take other measures for safety satisfactory to the Owner/Engineer.

- C. Take precautions to prevent injury to the public due to open trenches. Night watchmen may be required where special hazards exist, or police protection provided for traffic while work is in progress. Be fully responsible for damage or injuries whether or not police protection has been provided.

1.10 NOISE CONTROL

- A. All construction work shall be in compliance with all applicable County and local municipality noise ordinances.
- B. Definitions – The following words, terms and phrases, when used in this section, shall have the meanings described below:
 - 1. *Decibel* is a unit of measurement of intensity of sound (the sound pressure level).
 - 2. *Octave band* is a means of dividing the range of sound frequencies into octaves, in order to classify sound according to pitch.
 - 3. *Octave band filter* means an instrument, standardized by the American Standards Association, used in conjunction with a sound level meter to take measurements in specific octave bands.
 - 4. *Sound level meter* means an instrument, standardized by the American Standard Association, used for measurement of the intensity of sound and calibrated in decibels.
- C. Measurement of Sound level
 - 1. For the purpose of measuring the intensity and frequencies of sound, sound level meters and octave band filters shall be employed by the Contractor if requested by the Owner when noise complaints persist. In the enforcement of this section, noise produced by the operation of motor-driven vehicles, stationary units, flying objects or other transportation facilities shall be included in the determination of the maximum decibel levels permitted.
 - 2. Sound of short duration, from forge hammers, punch presses and metal shears, etc. which cannot be measured accurately with the sound level meter, shall be measured with an impact noise filter provided by the Contractor as manufactured by the General Radio Company, or its equivalent, in order to determine the peak value of the impact. For sounds so measured, the sound pressure level set forth in Table 1 may be increased by six decibels.
 - 3. Maximum Permitted Sound Levels – The Contractor shall ensure all his operations at all times are in compliance with the sound pressure levels delineated in Table 1.

TABLE 1. MAXIMUM PERMITTED SOUND PRESSURE LEVEL (IN DECIBELS)

Octave Band (cycles per second)	Sound Pressure Level (Decibels)	
	Residential Areas	Commercial Areas
0 - 75	65	79
75 - 149	60	74
150 - 299	55	66
300 - 599	55	59
600 – 1,199	45	53
1,200 – 2,399	45	47
2,400 – 4,799	40	41
4,800 – and over	40	39

1.11 CARE AND PROTECTION OF PROPERTY

- A. Be responsible for the preservation of all public and private property and use every precaution necessary to prevent damage thereto. If any direct or indirect damage is done to public or private property by or on account of any act, omission, neglect, or misconduct in the execution of the work on the part of the Contractor, restore such property to a condition similar or equal to that existing before the damage was done, or make good the damage in other manner acceptable to the Owner/Engineer.

1.12 PROTECTION AND RELOCATION OF EXISTING STRUCTURES AND UTILITIES

- A. Assume full responsibility for the protection of all buildings, pavement which is to remain, structures, and utilities, public or private, including poles, signs, services to buildings, utilities in the street, gas pipes, water pipes, hydrants, water works, storm drainage, sewer mains, telephone, fiber optics, electric and telephone cables, power lines & power poles, sprinkler systems, private out-buildings such as sheds, and other utilities whether or not they are shown on the Drawings. Carefully support and protect all such structures and utilities from injury of any kind. Immediately repair any damage resulting from the construction operations at no additional cost to the Owner.
- B. Assistance will be given the Contractor in determining the location of existing services. Existing underground utilities shown on the Drawings are based on record drawings provided by the Owner and field investigations. The Owner and its agents, including the Engineer, do not warrant that they are complete or entirely accurate. The Contractor shall bear full responsibility for obtaining all locations of underground structures and utilities and is responsible for locating and marking existing utilities including (including existing water services, drain lines, sewers, valves, boxes, drainage structures, irrigation lines, electric lines, telecommunication lines) within the Construction limits before any construction activity.
- C. The Contractor shall locate these and other possible unknown utility lines, and shall excavate and expose all existing underground lines as part of the excavation work under this contract. Be responsible for planning and coordinating the required work around the existing utilities

- D. Contractor shall coordinate location of the utilities with the owners of record for each utility.
 - E. The Contractor shall be solely responsible and liable for any damage (i.e. such as cutting or disturbing, etc.) to any utilities resulting from or incident to the Contractor's performance of these projects. The Contractor shall be responsible for notifying appropriate companies to protect or move the affected facilities, if any of the specified work is in the area of these affected facilities.
 - F. Contractor shall coordinate the removal and relocation of all existing utilities with their respective owner and provide temporary services as needed until new services can be installed, tested and accepted.
 - G. The power and phone companies may require that all poles within 5 feet of construction, or as noted on the Drawings, be held in place during construction by their own forces and will bill time and expenses. These costs shall be included in the unit cost of pipe and no additional cost will be considered. The Contractor is advised to familiarize himself with the proposed routing and location of utility poles before the submittal of bid. All of the above costs, including potential repair should any utility be damaged during construction, shall be the responsibility of the Contractor.
 - H. The Contractor is responsible for maintaining all existing utilities to the users along the project corridor. The Contractor shall provide the method for maintaining service to the Owner for approval prior to the start of any construction. The payment for maintaining utilities service shall be included in the unit price bid items for the appropriate pipe items. No separate payment will be made.
 - I. The flow in all sewers, drains, and watercourses encountered shall be maintained by the Contractor whenever such sewers, watercourses and drains are disturbed or destroyed during the construction of the work. They shall be restored by the Contractor at his expense with the same size pipe, or as directed by the Owner/Engineer. This includes pipes labeled to be restored by the Contractor on the Contract Drawings.
 - J. The Contractor will notify all utility companies in writing at least 72 hours (excluding Saturdays, Sundays and Legal holidays) before excavating in any public way. Also contact SC811 Call Before You Dig at telephone number 811 at least 72 hours prior to start of work.
 - K. Coordinate the removal and replacement of traffic loops and signals, if required for the performance of the work, at no additional cost to the Owner.
- 1.13 WATER FOR CONSTRUCTION PURPOSES
- A. Water will be available from selected hydrants owned and operated by the City of Georgetown. Contractor is responsible for obtaining all associated permits and paying the requisite fee to obtain the required water.
 - B. No fire hydrant shall be obstructed in case of fire in the area served by the hydrant.
- 1.14 MAINTENANCE OF FLOW
- A. Provide for the flow of sewers, storm drains and water courses interrupted during the progress of the work. Discuss the entire procedure of maintaining existing flow with the Owner/Engineer

well in advance of the interruption of any flow and provide a written plan and map of the proposed maintenance.

- B. Contractor is required to submit By-Pass pumping requirements including a pump around plan submittal. See also Section 02767 for additional requirements.

1.15 RESTORATION

- A. Where construction is called for through grassed areas, whether in public or private property, the sod shall be neatly cut, removed and carefully stored and kept watered until it is replaced by the Contractor. All grassed areas shall be replaced and Contractor is solely responsible for adequately watering the new sod 3 times a week for the first 2 weeks once sod is replaced. Topsoil underlying grassed areas, and all topsoil disturbed on private property, shall be removed for its full depth and stockpiled separate from the remainder of the material removed from the trench. The topsoil removed shall be replaced by the Contractor after the trenches have been backfilled.
- B. All trees and shrubbery interfering with the work or which may be damaged in pursuance of the work should be carefully removed, heeled and replaced by the Contractor. In some cases the property owners may have extended their terraces, lawns, shrubbery and other plantings into the right-of-way. Where any such terraces, lawns, shrubbery or other plantings will be disturbed by the Contractor's equipment or by the trenching or laying of pipe lines, the Contractor will be required to remove, maintain in suitable condition, and replace all topsoil, sod, shrubbery and other things that may interfere with or be damaged by the work. Seeding such areas is unacceptable and shall be considered temporary until sodding can be accomplished.
- C. As work progresses, disturbed areas shall be completely restored at a rate consistent with the rate of utility installation. There shall never be any more than 400 linear feet of unrestored trench from pipe installation, as measured along the trench line. All work in this area must be completed including the reestablishment of permanent services, closing of all excavated pits, restoration of pavement, shoulders, ditches, etc. and restoration of grassed and shrubbery areas prior to continuation of project. This distance shall not be exceeded without prior approval of the Owner/Engineer.
- D. The Contractor shall clean up daily and dispose of all surplus materials and refuse, rubbish, scrap materials, false work, temporary structures, foundations and debris of every nature caused by his operations. The site of the work shall present a neat and orderly.
- E. There will be no direct payment for restoration and cleanup. All costs associated with restoration shall be included in the pipe unit prices as indicated in the Schedule of Values.

1.16 ABANDONMENT OF EXISTING UTILITIES

- A. All contents of each pipe, manhole or vault to be abandoned shall be pumped out to a suitable holding tank, truck or container and all contents disposed of in a manner and at a location acceptable to the Owner/Engineer.
- B. Where specified on the plans, Contractor shall abandon existing utilities in place unless called for removal. Contractor shall plug each 4-inch and larger pipe to be abandoned with a concrete plug and fill existing utilities with flowable fill or other approved material as approved by the Owner/Engineer. Flowable fill shall be pumped in.

- C. The frames and covers of all manholes and vaults shall be removed and the top sections shall be removed to 1 feet below existing grade in paved and foundation areas. For all other areas, remove all of the cone section to a depth of 3 feet below finished or existing grade, whichever is lower. All pipe penetrations shall be plugged. The remainder of the trench shall be filled to the top with flowable fill.

1.17 DUST CONTROL

- A. Maintain all excavations, embankments, stockpiles, access roads, building sites, waste areas, borrow areas and all other work areas within or without the project boundaries free from dust which could cause standards for air pollution to be exceeded and which would cause a hazard or nuisance to others. Dust control shall be performed as the work proceeds and whenever a dust nuisance or hazard occurs.
- B. Dust control shall be generally accomplished by the use of water; however, the use of calcium chloride may be used when necessary to control dust nuisance.
- C. Calcium chloride shall conform to AASHTO M144, Type I except the requirements for "total alkali chlorides" and other impurities shall not apply.
- D. Methods of controlling dust shall meet all air pollutant standards as set forth by Federal and State regulatory agencies and conform to South Carolina DHEC.

1.18 EROSION CONTROL

- A. Erosion control shall also follow the requirements of the respective technical specifications.

1.19 PROTECTION OF STREAMS AND SURFACE WATERS

- A. Take precautions to prevent, or reduce to a minimum, damage to any stream or surface water from pollution by debris, sediment or other material, or from the manipulation of equipment and/or materials in or near streams and surface waters. Water that has been used for washing or processing, or that contains oils or sediments, and stormwater that will reduce water quality of receiving waters, shall not be directly returned to streams or other surface waters. Divert such waters through a settling basin, filter or appropriate Best Management Practice before being directed into streams or surface waters.
- B. Do not discharge water from dewatering operations directly into any live or intermittent stream, channel, wetlands, surface water or any storm sewer. Water from dewatering operations shall be treated by filtration, settling basins, or other approved method to reduce the amount of sediment contained in the water to allowable levels.
- C. Take preventative measures to avoid spillage of petroleum products and other pollutants. In the event of any spillage, prompt remedial action shall be taken in accordance with a contingency action plan approved by the Owner/Engineer. Submit two copies of approved contingency plans to the Owner/Engineer for information purposes only.
- D. Water being flushed from potable water structures or pipelines after disinfection shall be in accordance with Section 02610.

1.20 PROTECTION OF LAND RESOURCES, LAWNS, SHRUBBERY AND TREES

- A. Restore land resources within the project boundaries and outside the limits of permanent work to a condition that, after completion of clean-up, will approximate pre-construction conditions, appear to be natural, and not detract from the appearance of the project. Confine all construction activities to areas shown on the Contract Drawings. Complete project restoration activities depicted on Contract Drawings shall be implemented.
- B. Trees shall not be disturbed unless specifically indicated for removal in the Contract Documents. Contractor shall take all measures necessary to protect trees and tree root zones during construction. Ornamental shrubbery and tree branches shall be temporarily tied back, where appropriate, to minimize damage. Contractor is required to notify the Owner/Engineer and the appropriate authority of any damage to trees during construction for a decision on the extent of repair and/or if replacement is necessary. Trees which receive damage to branches shall be trimmed of those branches to improve the appearance of the tree. Tree trunks receiving damage from equipment shall be treated with tree dressing. Any such trees and shrubbery necessary to be removed shall be replaced and replanted at the contractor's expense. Trees may be removed only after written approval is obtained from the Owner, property owner, or the appropriate administrative authority. Cost of tree protection, replacement, repair, and removal shall be at the contractor's expense.
- C. Pruning of Trees to remain shall have only deadwood pruning and pruning only necessary for clearance of structures should be conducted. Requests for pruning to resolve conflicts with improvements and/or construction equipment shall be made in writing to the appropriate governing agency or property owner. Owner approved arborists only shall complete needed pruning. No fertilizer should be applied to trees in the project area prior to construction.
- D. Outside of areas requiring earthwork for the construction of the new facilities, do not deface, injure, or destroy trees or shrubs, nor remove or cut them without prior approval. No ropes, cables, or guys shall be fastened to or attached to any existing nearby trees for anchorage. Where special emergency use is permitted, first wrap the trunk with a sufficient thickness of burlap or rags over which softwood cleats shall be tied before any rope, cable, or wire is placed. The Contractor shall in any event be responsible for any damage resulting from such use.
- E. Before beginning operations near them, protect trees that may possibly be defaced, bruised, injured, or otherwise damaged by the construction equipment, dumping or other operations, by installing boards, planks, or poles around trunks to protect against damage. Monuments and markers shall be protected similarly.
- F. Any trees or other landscape features scarred or damaged by the Contractor's equipment or operations shall be restored as nearly as possible to their original condition. The Owner/Engineer will decide the method of restoration to be used and whether damaged trees shall be treated and healed or removed and disposed of. If requested by the Owner/Engineer or Owner, a SC certified arborist shall conduct an inspection of damaged trees and submit recommendations for any tree repair to the Contractor. Should the services of a certified arborist be required due to tree damage caused by the Contractor, the cost for the certified arborist shall be the responsibility of the Contractor and not reimbursed by the Owner.
 1. All scars made on trees by equipment, construction operations, or by the removal of limbs larger than 1-in in diameter shall be coated as soon as possible with an approved tree wound dressing unless otherwise directed by the Owner/Engineer. All trimming or

pruning shall be performed in an approved manner by experienced workmen with saws or pruning shears. Tree trimming with axes will not be permitted.

2. Trees that are to remain, either within or outside established clearing limits, that are subsequently damaged by the Contractor and are beyond saving in the opinion of the Owner/Engineer, shall be immediately removed and replaced.
- G. All debris and excess material will be disposed of outside wetland or floodplain areas in an environmentally sound manner, and in compliance with applicable federal, state and local regulations.
- H. Where trenches cross private property or public rights-of-way through established lawns, sod shall be cut, removed, stacked and maintained in suitable condition until replacement is approved by the Engineer. Topsoil underlying lawn areas shall be removed and kept separate from general excavated materials until replacement. Once sod is replaced, the Contractor shall be responsible for adequately watering the sod three times a week for four weeks.
- I. Contractor shall comply with any additional requirements identified and agreed to by the Owner as identified on the easement documents included with these Bid Documents.

1.21 PROTECTION OF AIR QUALITY

- A. Burning at the project site for the disposal of refuse and debris will not be permitted.
- B. Provide systems for control of atmospheric pollutants.
 1. Prevent toxic concentrations of chemicals.
 2. Prevent harmful dispersal of pollutants into the atmosphere.

1.22 POLLUTION CONTROL DURING CONSTRUCTION

- A. Maintain all facilities constructed for pollution control as long as the operations creating the particular pollutant are being carried out, or until the material concerned has become stabilized to the extent that pollution is no longer being created.
- B. Provide methods, means and facilities required to prevent contamination of soil, water or atmosphere by the discharge of noxious substances from construction operations.
- C. Provide equipment and personnel, perform emergency measures required to contain any spillages, and to remove contaminated soils or liquids.
 1. Contaminated soils and liquids shall be stored, transported, and disposed of in accordance with local, State, and federal regulations and this contract.
- D. Care shall be taken to prevent, or reduce to a minimum, damage to any water resource from pollution by debris, sediment or other material, or from the manipulation of equipment and/or materials in or near such waters. Water that has been used for washing or processing, or that contains oils or sediments that will reduce water quality shall be diverted through an oil/water separator or filter before being discharged.

- E. No materials shall be dispersed or stockpiled in any wetland area. No excavated materials or materials to be used in backfilling shall be deposited within 100 feet of any watercourse, wetland area, or drainage facility without prior approval from the Owner/Engineer and regulatory agencies.
- F. The storage of fuel oil and refueling of equipment shall be restricted to designated areas approved by the Owner/Engineer and appropriate regulatory agencies.
- G. The removal and disposal of fuel, lubricants, grease, and other operating fluids from equipment designated for demolition or to be removed shall be done in accordance with current federal, state, and local regulations.
- H. Contractor shall not locate his storage of equipment and materials within 100 feet of wetland boundaries or floodplains.
- I. All debris and excess material will be disposed of outside the boundaries of wetland or floodplain areas in an environmentally sound manner as determined by the federal, state, and local regulations.
- J. Take special measures to prevent harmful substances from entering public waters.
 - 1. Prevent disposal of wastes, effluents, chemicals, or other such substances adjacent to streams, or in sanitary or storm sewers.
- K. All Contractor's equipment used during construction shall conform to all current federal, state and local laws and regulations.

1.23 CLEAN UP AND DISPOSAL OF EXCESS MATERIAL

- A. During the course of the work, keep the site of operations as clean and neat as possible. Dispose of all residue resulting from the construction work and, at the conclusion of the work, remove and haul away any surplus excavation (including, but not limited to excavated rock, fill materials, broken pipe), broken pavement, lumber, equipment, temporary structures and any other refuse remaining from the construction operations and leave the entire site of the work in a neat and orderly condition.
- B. In order to prevent environmental pollution arising from the construction activities, comply with all applicable Federal, State and local laws and regulations concerning waste material disposal, as well as the specific requirements stated in this Section and in other related sections.
- C. Disposal of excess excavated material in wetlands, stream corridors and plains is strictly prohibited even if the permission of the property owner is obtained. Any violation of this restriction by the Contractor or any person employed by him will be brought to the immediate attention of the responsible regulatory agencies, with a request that appropriate action be taken against the offending parties. The Contractor will be required to remove the fill and restore the area impacted at no additional cost to the Owner.

END OF SECTION

SECTION 01170
SPECIAL PROVISIONS

PART 1 GENERAL

1.01 GENERAL

- A. These special provisions are established for the benefit of the City of Georgetown. Any discrepancies or ambiguities within these special provisions shall be interpreted to the best interest of the Owner.
- B. Pre-CCTV video as well as pipe cleaning was completed in May through August 2023. Due to potential sediment migration through the gravity sewer system, pipe cleaning may be needed prior to rehabilitation work being conducted.
- C. Pre-rehabilitation CCTV video, PACP reports, and MH Level 2 reports will be available to all bidders for this project. PACP report and MH Level 2 reports are found in Appendix 1 of the specification. Pre-rehabilitation CCTV video are available upon request to the Engineer or Owner.
- D. All third-party testing, inspections, or results shall be paid for and coordinated by the Contractor.

1.02 PROJECT COMPLETION TIME

- A. Contractor shall mobilize and begin work within 14 days of the issuance of the notice to proceed (NTP).
- B. The Contractor shall substantially complete the project within 75 consecutive calendar days and fully complete the project within 90 consecutive calendar days from the date of issuance of the notice to proceed.
- C. Substantial Completion – The time at which the Work has progressed to the point where, in the opinion of the Owner/Engineer, the Work is sufficiently complete, in accordance with the Contract, so that the Work can be utilized for the purposes for which it is intended. Liquidated damages may be assessed for Contractor’s failure to meet the Substantial Completion date.
- D. Final Completion – The time at which the Work has been fully completed to include demolition of existing facilities, completion of punch list items, paving, final sitework and landscaping, paving, and full demobilization and all else required by the Contract. Liquidated damages may be assessed for Contractor’s failure to meet the Final Completion date.

1.03 WORK HOURS

- A. Work for this project will be completed between the hours of 7:00 PM to 6:00 AM. Traffic control may begin setup at 7:00 PM and must be taken down prior to 6:00 AM.

END OF SECTION

THIS PAGE INTENTIONALLY LEFT BLANK

SECTION 01200
PROJECT MEETINGS

PART 1 GENERAL

1.01 SCOPE OF WORK AND REQUIREMENTS

- A. The Owner's Project Manager (PM), unless delegated to the Engineer, shall schedule and administer the Pre-Construction Conference and monthly Construction Progress Meetings throughout progress of the work. The PM, unless delegated to the Engineer, shall prepare minutes of these meetings and distribute. The Contractor shall:
 - 1. Assist with preparation of agenda for all meetings.
 - 2. Make physical arrangements for meetings, except for the Pre-Construction Conference which shall be at a place and time dictated by the PM.
 - 3. Distribute updated color copies (if applicable) of all schedules & Logs (i.e. Submittal Schedule, submittal Log, RFI Log, etc.)
 - 4. Attend all meetings.
- B. Ensure appropriate representatives of Contractor, subcontractors, utility owners, and suppliers attend meetings as necessary to act on behalf of the entity each represents.
- C. Ascertain that work is expedited consistent with Contract Documents and construction schedules.
- D. There shall be no direct payment for this item, the cost of which shall be included in other Bid Items as directed in Section 01025.

1.02 RELATED REQUIREMENTS

- A. Section 01310 - Construction Schedules.
- B. Section 01300 - Submittals.
- C. Section 01720 - Record Documents.
- D. Section 01730 - Operating and Maintenance Manuals and Vender Training.
- E. Section 01740 – Contract Close Out.

1.03 PRE-CONSTRUCTION CONFERENCE

- A. Attend a Pre-Construction Conference typically prior to date of Notice to Proceed.
- B. Location: A central site, convenient for all parties, designated by the Owner.
- C. Attendance

1. Owner's Representative.
2. Engineer and his/her professional consultants.
3. Contractor's Superintendent.
4. Major Subcontractors.
5. Major suppliers.
6. Utilities
7. PM
8. Others as appropriate.

D. Agenda and Tracking Logs

1. The PM will distribute the agenda prior to the day of the meeting and the Contractor shall be asked to add items of particular interest or concern to that agenda.
2. The Owner/Engineer shall have prepared a list of required shop drawing submittals, a list of required testing procedures (field tests, shop tests, and performance tests), a list of required warranties, and a list of required material samples and distribute these lists to all parties at or prior to the Pre-Construction Conference. These lists shall be maintained by both the Engineer and Contractor throughout the project duration and reconciled at each Monthly Construction Progress Meeting.

1.04 WEEKLY PLANNED WORK MEETINGS

- A. Schedule and attend regular weekly planned work meetings if requested by the Owner following the first Monthly Construction Progress Meeting. Weekly planned work meetings provide members of the project team the opportunity to monitor the project on a less formal, but more frequent basis. Frequency of these meetings may be modified, including more frequent than weekly, based on the complexity of the project and on projected need as jointly determined by the PM and Contractor.
- B. The participants will discuss the planned week's work for the project and any key issues that may affect the progress of the project. The Contractor shall meet weekly or as needed with the PM to discuss the planned week's work for the project and any key issues required to progress the project.
- C. These meetings will be held in the Project field office of the Contractor or other location mutually agreed to, and chaired by the Contractor. The UC will be in attendance and the PM on an as needed basis. The topics for discussion should include specific work elements that are occurring each week.
- D. The Contractor shall distribute copies of a two week look-ahead schedule and logs specified in 1.01A of this Specification Section.

- E. The Owner's PM or the Engineer shall document minutes of the meetings and disseminate weekly.

1.05 MONTHLY CONSTRUCTION PROGRESS MEETINGS

- A. Schedule and attend regular monthly progress meetings every 30 Calendar days with the first meeting 30 Calendar days after the Pre-Construction Conference.

- B. Location of the meetings: Project field office of Contractor or Engineer.

- C. Attendance

- 1. PM
- 2. Engineer and his/her professional consultants as needed.
- 3. Subcontractors as appropriate to the agenda.
- 4. Suppliers as appropriate to the agenda.
- 5. Others as appropriate.

- D. Suggested Agenda

- 1. Review, approval of minutes of previous meeting.
- 2. Review of work progress since previous meeting.
- 3. Field observations, problems and conflicts.
- 4. Safety issues or other items of concern.
- 5. Problems which could impede Construction Schedule.
- 6. Review of off-site fabrication, delivery schedules.
- 7. Corrective measures and procedures to regain projected schedule.
- 8. Possible revisions to Construction Schedule.
- 9. Progress and schedule for succeeding work period.
- 10. Review submittal schedules;
- 11. Reconciliation of all submittal, RFI, and testing logs, etc.
- 12. Maintenance of quality standards.
- 13. Pending changes and substitutions.
- 14. Review of Contractors monthly pay requisitions.

15. Other business.

1.06 SPECIALTY COORDINATION MEETINGS

- A. Schedule and attend any special meetings called by the Owner, Engineer or Contractor to assist in coordination or execution of the Work. Prepare agenda and meeting minutes along with documentation of all decisions reached or direction given.
- B. Invite subcontractors, utility owners, and/or suppliers as may be appropriate for such meetings.

1.07 CLOSE-OUT MEETING

- A. Schedule and attend a Project Close-Out Meeting in accordance with Section 01740. Comply with all requirements of Section 01740 prior to scheduling the meeting.
- B. With approval of the PM, the Close-Out Meeting may be held in conjunction with the final Monthly Construction Progress Meeting provided all requirements of Section 01740 are complied with in advance.

PART 2 PRODUCTS (NOT USED)

PART 3 EXECUTION (NOT USED)

END OF SECTION

SECTION 01300
SUBMITTALS

PART 1 GENERAL

1.01 SCOPE OF WORK

- A. This Section includes the requirements for compiling, processing and transmitting submittals required for execution of the project. Submittals are categorized into two types, Action Submittals and Informational Submittals, as follows:
1. Action Submittals: Written and graphic information submitted by the Contractor that requires the Owner/Engineer's approval. The following are examples of action submittals, which may or may not be required for this project per the Contract Documents:
 - a. Shop Drawings (including working drawings, valve schedules, and product data)
 - b. Samples
 - c. Operation & Maintenance Manuals
 - d. Schedule of Values
 - e. Equipment Delivery Schedule
 - f. Applications for Payment
 - g. Site Usage Plan (Contractor's staging and material laydown area)
 - h. Requests for Information (RFI)
 - i. Submittal Logs
 - j. Construction Site Weekly Reports.
 - k. Record Documents
 2. Informational Submittals: Information submitted by the Contractor that does not require the Owner/Engineer's approval. The following are examples of informational submittals, which may or may not be required for this project per the Contract Documents:
 - a. Shop Drawing Schedule
 - b. Construction Schedule
 - c. Statements of Qualifications
 - d. Health and Safety Plans
 - e. Fire Safety Program
 - f. Excavation/Sheet Piling Plans
 - g. Maintenance of Flow Plan
 - h. Maintenance of Traffic Plans
 - i. Moisture and Mold Control Plan
 - j. Dust and HVAC Control Plan
 - k. Outage Requests
 - l. Proposed Testing Procedures and Reports
 - m. Vendor Training Outlines/Plans
 - n. Warranties and Bonds
 - o. A-Built Surveys
 - p. Contract Close-out Documents

- 3 There will be no direct payment for this work, the cost of which shall be included in other bid items.

1.02 RELATED WORK

- A. Section 00700 - General Conditions for the Contract.
- B. Section 01026 - Applications for Payment.
- C. Section 01050 - Project Controls (Surveying).
- D. Section 01310 - Construction Schedules.
- E. Section 01320 - Construction Photos and Video Recording.
- F. Section 01720 - Record Documents.
- G. Section 01730 - Operation and Maintenance Manuals.
- H. Section 01735 - Warranties and Bonds.
- I. Section 01740 - Contract Closeout.

1.03 CONTRACTOR'S RESPONSIBILITIES

- A. All submittals shall be clearly identified with the following:
 1. Date of Submission.
 2. Project Number.
 3. Project Name.
 4. Contractor Identification.
 - a. Contractor.
 - b. Supplier.
 - c. Manufacturer.
 - d. Manufacturer or supplier representative.
 - e. Identification of the Product.
 5. Reference to Contract Drawing.
 6. Reference to applicable specification section number, page and paragraph(s).
 7. Reference to applicable standards, such as ASTM or other industry standard numbers.
 8. Contractor's Certification statement.
 9. Identification of deviations from the Contract Documents, if any.
 10. Reference to previous submittal (for resubmittals).

B. Contractor's / Subcontractor Certification and additional Requirements

1. Submittals shall be clear and legible, and of sufficient size for legibility and clarity of the presented data.
2. Each shop drawing, working drawings, product data, and sample shall have affixed to it the following Certification Statement:
 - a. Certification Statement: By this submittal, I hereby represent that I have determined and verified all field measurements, field construction criteria, materials, dimensions, catalog numbers and similar data and I have checked and coordinated each item with other applicable approved shop drawings and all Contract requirements.

C. Contractor shall maintain a log of all submittals. The submittal log shall be kept accurate and up to date. This log shall be submitted for review prior to the first submittal request for approval and reconciled with a similar log being kept by the PM, and Owner/Engineer on a monthly basis at the Construction Progress meetings. Separate logs shall be kept for shop Drawings, RFIs, and Substitutions. These logs should include the following items (as applicable):

1. Description.
2. Submittal Number.
3. Date transmitted to the Owner/Engineer.
4. Date returned to Contractor (from Owner/Engineer).
5. Status of Submittal (Approved/Not Approved/etc.).
6. Date of Resubmittal to Owner/Engineer and Return from Owner/Engineer (if applicable and repeat as necessary).
7. Date material released for fabrication.
8. Projected (or actual) delivery date .

D. Contractor shall utilize the following submittal identification numbering system:

1. The first character shall be a D, S, M or I which represents Shop Drawing (including working drawings and product data), Sample, Manual (Operating & Maintenance) or Informational, respectively.
2. The next five digits shall be the applicable Section Number.
3. The next three digits shall be the sequential number of each separate item or drawing submitted under each Specification Section, in the chronological order submitted, starting at 001.

4. The last character shall be a letter, A to Z, indicating the submission (or resubmission) of the same submittal, i.e., "A" = 1st submission, "B" = 2nd submission, "C" = 3rd submission, etc.
5. A typical submittal number would be as follows:
 - a. D-03300-008-B.
 - b. D = Shop Drawing (03300) = Section for Concrete.
 - c. 008 = the eighth different submittal under this Section.
 - d. B = the second submission (first resubmission) of that particular shop drawing.

1.04 VARIANCES

- A. Notify the Owner/Engineer in writing, at the time of submittal and clearly marked at the beginning, of any deviations in the submittals from the requirements of the Contract Documents.
- B. Notify the Owner/Engineer in writing, at the time of re-submittal (resubmission) and clearly marked at the beginning, of all deviations from previous submissions of that particular shop drawing, except those deviations which are the specific result of prior comments from the Owner/Engineer.
- C. "OR EQUAL" Items
 1. Whenever an item of material or equipment is specified or described in the Contract Documents by using the name of a proprietary item or the name of a particular supplier, the specification or description is intended to establish the type, function, appearance, and quality required. Unless the specification or description contains specifically states that no like, equivalent, or "or-equal" item, or no substitution is permitted, other items of material, products or equipment of other Suppliers may be submitted to the Engineer for review under the circumstances described below:
 2. If in the Owner/Engineer's discretion an item of material, product or equipment proposed by the Contractor is functionally equal to that named and sufficiently similar so that no change in related work will be required, it may be considered by the Owner/Engineer as an "or-equal" item. The review and approval of the proposed item may, in the Owner/Engineer's sole discretion, be approved. For the purposes of this specification, a proposed item of material, product or equipment may be considered functionally equal to an item so named if it is determined that all of the following are met:
 - a. It is equal in materials of construction, quality, durability, appearance, strength, and design characteristics,
 - b. It will reliably perform its intended function and achieve the results imposed by the design concept of the completed Project as a functioning whole,
 - c. Provide a record of performance and availability of responsive service,
 - d. The Contractor certifies that, if approved and incorporated into the Project, there will be no increase in Contract time or cost, and it will conform substantially to the detailed requirements of the item shown in the Contract Documents.

D. Substitute Items:

1. If in the Owner/Engineer's discretion, an item of material, product or equipment proposed by the Contractor does not qualify as an "or-equal" item under the above Section, they will consider a proposed substitute item. The Contractor shall submit sufficient information to allow the Owner/Engineer to determine that the item of material or equipment proposed is essentially equivalent to that named and an acceptable substitute thereof. Requests for review of proposed substitute items of material, product or equipment will not be accepted by the Owner/Engineer from anyone other than the Contractor.
2. The Contractor shall request to use substitute materials, products and/or equipment in writing and shall provide the Owner/Engineer certification that the proposed substitute will:
 - a. Perform the functions and achieve the results called for in the plans and the design.
 - b. Be similar in substance to that specified.
 - c. Be suited to the same use in the same conditions as that specified.
3. The Contractor shall:
 - a. State the extent, if any, to which the use of the proposed substitute will prejudice the Contractor's achievement of project completion.
 - b. State whether or not the use of the proposed substitute item in the work will require a change in any of the Contract Documents (or in the provisions of any other direct contract with the Owner for other work on the Project) to adapt the design to the proposed substitute item.
 - c. State whether or not incorporation or use of the proposed substitute item in connection with the work is subject to payment of any license or other fee.
 - d. Identify all variations and differences of the proposed substitute item from that specified.
 - e. Identify available Engineering, sales, maintenance, repair and replacement services.
 - f. Prepare an itemized estimate of the cost or credits that will result directly or indirectly from the use of the proposed item, including cost of redesign and claims of other Contractors affected by any resulting changes.

1.05 ACTION SUBMITTALS

A. General

1. Shop drawings, working drawings, and product data sheets 11-in x 17-in and smaller shall be bound together in an orderly fashion and bear the below Certification Statement on the cover sheet. The transmittal cover sheet for each identified shop drawing shall fully describe the packaged data and include a listing of all items within the package and include a place for the Owner/Engineer's stamp.
2. The review and approval of shop drawings, working drawings, product data, or samples by the Owner/Engineer shall not relieve the Contractor from the responsibility for the fulfillment of the terms of the Contract. All risks of error and omission are assumed by the Contractor and the Owner/Engineer will have no responsibility, therefore.

3. Submittals that are acceptable will be reviewed and returned with comments/notes to the contractor in a timely manner after receipt. The need for re-submittals will not be a basis for an extension of contract time for the Contractor.
4. The Contractor shall not receive time extensions or additional cost for expired certifications and/or delays to submittal reviews and approvals.
5. Project work, materials, fabrication, and installation shall conform to approved shop drawings (including working drawings and product data) and applicable samples.
6. No portion of the work requiring a shop drawing (including working drawings and product data) or sample shall be started, nor shall any materials be fabricated or installed before approval of such item. Procurement, fabrication, delivery or installation of products or materials that do not conform to approved shop drawings shall be at the Contractor's risk. Furthermore, such products or materials delivered or installed without approved shop drawings, or in non-conformance with the approved shop drawings will not be eligible for progress payment until such time as the product or material is approved or brought into compliance with approved shop drawings. Neither Owner/Engineer will be liable for any expense or delay due to corrections or remedies required to accomplish conformity.

B. Shop Drawings, Working Drawings, Product Data and Samples.

1. Shop Drawings.
 - a. Shop drawings as defined in the General Conditions, and as specified in individual Sections may include, but are not necessarily limited to, custom prepared data such as fabrication and erection/installation (working) drawings, scheduled information, setting diagrams, actual shop work manufacturing instructions, custom templates, valve schedules, wiring diagrams, coordination drawings, equipment inspection and test reports, and performance curves and certifications, as applicable to the work.
 - b. Prior to the beginning of construction, the Contractor shall submit (4) copies and one electronic version of each submittal and/or shop drawing for the Owner's use; Contractor shall provide additional copies as needed for their records. Submittal and shop drawing review shall be limited to general design requirements only and shall not relieve the Contractor from responsibility for errors and/or omissions or responsibility for resulting consequences due to deviations from the Contract Documents. Changes shall not be made to any submittal after it has been reviewed; a new submittal must be presented for review and approval if changes are requested.
 - c. Contractor shall verify all field measurements, field construction criteria, materials, dimensions, catalog numbers and similar data, and coordinate each item with other related shop drawings and the Contract requirements.
 - d. All details on shop drawings shall clearly show the relation of the various parts to the main members and lines of the structure and where correct fabrication of the work depends upon field measurements, such measurements shall be made and noted on the drawings before being submitted.
 - e. All shop drawings submitted by subcontractors and vendors shall be reviewed by the Contractor. Contractor shall confirm, materials, dimensions, catalog numbers, technical data and performance criteria; and shall coordinate with other related shop

drawings and the Contract requirements. In addition, Contractor shall confirm existing field conditions and dimensions and assure that the submittal is coordinated and compatible with existing conditions. Submittals directly from subcontractors or vendors will not be accepted by the Owner/Engineer.

- f. The Contractor shall be responsible the accuracy of the subcontractor's or vendor's submittal; and, for their submission in a timely manner to support the requirements of the Contractor's construction schedule. Shop drawings found to be inaccurate or otherwise in error shall be returned to the subcontractor or vendor to correct, before submission to the Owner/Engineer. All shop Drawings shall be approved by the Contractor.
- g. Delays to construction due to the untimely submission of submittals will constitute inexcusable delays, for which Contactor shall not be eligible for additional cost nor additional contract time. Inexcusable delays consist of any delay within the Contactor's control.
- h. Submittals for equipment specified under Divisions 11, 13, 14, 15 and 16 shall include a listing of installations where identical or similar equipment manufactured by that manufacturer has been installed and in operation for a period of at least five years or as otherwise specified in other specification sections.
- i. The Contractor, when required by the specifications, shall attach current documentation, certifications, the current Approval List published by SCDOT, etc. to appropriate submittals for review and approval by the Owner/Engineer. Submittals are required for materials, plants, etc. that are required to be certified and/or approved by the South Carolina Department of Transportation (SCDOT). Failure of the Contractor to attach the proper documentation to the submittals may result in delays of reviews and approvals.
- j. The Contractor shall be responsible for providing updated certifications/approvals prior to expiration of such. Uncertified and/or unapproved Contractors, materials, plants, etc. shall not participate in or perform work on this project until such time as documentation is provided to the Owner/Engineer showing recertification and/or approval.

2. Working Drawings

- a. Detailed installation drawings (sewers, equipment, piping, electrical conduits and controls, HVAC work, and plumbing, etc.) shall be prepared and submitted for review and approval by the Owner/Engineer prior to installing such work. Installation drawings shall be to-scale and shall be fully dimensioned.
- b. Piping working drawings shall show the laying dimensions of all pipes, fittings, valves, as well as the equipment to which it is being connected. In addition, all pipe supports shall be shown.
- c. Equipment working drawings shall show all equipment dimensions, anchor bolts, support pads, piping connections and electrical connections. In addition, show clearances required around such equipment for maintenance of the equipment.

- d. Electrical working drawings shall show conduits, junction boxes, disconnects, control devices, lighting fixtures, support details, control panels, lighting and power panels, and Motor Control Centers. Coordinate all locations with the Contract Documents and the Contractor's other working drawings.

3. Product Data

- a. Product data, as specified in individual Specification Sections, include, but are not limited to, the manufacturer's standard prepared data for manufactured products (catalog data), such as the product specifications, installation instructions, availability of colors and patterns, rough-in diagrams and templates, product photographs (or diagrams), wiring diagrams, performance curves, quality control inspection and reports, certifications of compliance (as specified or otherwise required), mill reports, product operating and maintenance instructions, recommended spare parts and product warranties, as applicable.
- b. The product data shall also include the manufacturer's recommendations for the repair of damaged materials, along with a list of all replaceable parts with Suppliers contact information.

4. Samples

- a. Furnish, samples required by the Contract Documents for the Owner/Engineer's approval. Samples shall be delivered to the Owner/Engineer as specified or directed. Unless specified otherwise, provide at least two samples of each required item. Materials or equipment for which samples are required shall not be used in the work unless and until approved by the Owner/Engineer.
- b. Samples specified in individual Specification Sections, include, but are not limited to: physical examples of the work (such as sections of manufactured or fabricated work), small cuts or containers of materials, complete units of repetitively-used products, color/texture/pattern swatches and range sets, specimens for coordination of visual effect, graphic symbols, and other specified units of work.
- c. Approval of a sample shall be only for the characteristics or use named in such approval and shall not be construed to change or modify and Contract Requirements.
- d. Approved samples not destroyed in testing shall be sent to the Owner/Engineer or stored at the site of the work. Approved samples of the hardware in good condition will be marked for identification and may be used in the work. Materials and equipment incorporated in work shall match the approved samples. Samples which fail testing or are not approved will be returned to the Contractor at his expense, if so requested at time of submission.

C. Schedule of Values

1. On projects consisting of lump sums (in whole or in part) submit a proposed schedule of values providing a breakdown of lump sum items into reasonably small components – generally disaggregated by building, area, and/or discipline as specified in Section 01370. The purpose of the schedule of values is for processing partial payment applications. If requested by the Owner/Engineer, provide sufficient substantiation for all or some items as

necessary to determine the proposed schedule of values is a reasonable representation of the true cost breakdown of the Work. The schedule of values shall not be unbalanced to achieve early payment or over-payment in excess of the value of work or any other mis-distribution of the costs. If, in the opinion of the Owner/Engineer, the schedule of values is unbalanced, Contractor shall reallocate components to achieve a balanced schedule acceptable to Owner/Engineer.

D. Equipment Delivery Schedule

1. The Contractor shall also prepare a schedule of anticipated shipping dates for materials and equipment. It is intended that equipment and materials be so scheduled as to arrive at the job site just prior to time for installation to prevent excessive materials on hand for inventory and the necessity for extensive storage facilities at the job site.

E. Payment Applications

1. The PM shall provide the Contractor an Application of Payment form at the Pre-Construction Meeting. This form shall be used for all monthly Applications for Payment unless otherwise directed by the PM.
2. See also Specification Section 01026.

F. Site Usage Plan

1. Submit a proposed site staging plan, including but not limited to the location of office trailers, storage trailers and material laydown. Such plan shall be a graphic presentation (drawing) of the proposed locations; and, shall include on-site traffic modifications, and temporary utilities, as may be applicable

G. Requests for Information (RFIs)

1. All RFI's will be submitted on the form mutually agreed upon by the Contractor and Owner/Engineer.

H. Submittal Logs

1. Contractor shall maintain logs of all submittals including shop drawings, RFIs, and substitutions. Additional requirements are as specified above in this Section.

I. Record Documents

1. No later than Substantial Completion, submit a record of all changes during construction not already incorporated into drawings – in accordance with Specification section 01720.

1.06 INFORMATIONAL SUBMITTALS

A. Shop Drawing Schedule

1. Prepare and submit a schedule indicating when shop drawings are required to be submitted to support the as-planned construction schedule. The submittal schedule shall allow sufficient time for preparation and submittal, review and approval, and fabrication and delivery to support the construction schedule.

2. Shop Drawing Schedule is to include any specified materials that has to be ordered very early due to long lead time.
- B. Construction Schedule
1. Prepare and submit construction schedules and monthly status reports as specified herein and in Section 01310(a).
- C. Statements of Qualifications
1. Provide evidence of qualification, certification, or registration, as required in the Contract Documents, to verify qualifications of licensed land surveyor, professional Engineer, materials testing laboratory, specialty subcontractor, technical specialist, consultant, specialty installer, and other professionals.
 2. Professional Engineer's qualifications shall be submitted along with the form included at the end of this Section.
- D. Health & Safety Plans
1. When specified, prepare and submit a general company Health and Safety Plan (HSP), modified or supplemented to include job-specific considerations.
- E. Fire Safety Program
1. Include Ingress & Egress Sketch and Plan showing how fire trucks will access site throughout construction phases. Should show specific hydrant(s) that are to be used.
- F. Excavation/Sheet Piling Near Existing Utilities Plan
1. Contractor to coordinate with and submit to the Owner/Engineer a plan before excavating or sheet piling near existing utilities to ensure that the Owner/Engineer is aware of the construction activities, and has given authorization for the construction methods to be utilized in the area.
- G. Maintenance of Flow Plan
1. The Contractor shall maintain existing, uninterrupted flow in sewers, drains, water courses and provide a written plan & map of "proposed maintenance of flow" to Owner/Engineer.
- H. Maintenance of Traffic Plans
1. Prepare maintenance of traffic plans where and when required by the Contract Documents and by local ordinances or regulations. If Contractor is not already knowledgeable about local ordinances and regulations regarding maintenance of traffic requirements, become familiar with such requirements and include all costs for preparation and submittal of traffic management plans and all associated costs for permits and fees to implement the traffic management plan, in the bid amount. In addition, unless a supplemental payment provision is provided in the bid form, include the cost of police attendance, when required.

2. Additional requirements are specified in Section 01570.

I. Outage Requests

1. Provide sufficient notification of any outages required (electrical, flow processes, etc.) as may be required to tie-in new work into existing facilities. Unless specified otherwise elsewhere, a minimum of seven calendar days' notice shall be provided.

J. Proposed Testing Procedures and Reports

1. Prepare and submit testing procedures it proposes to use to perform testing required by the various technical specifications.
2. Test Records and Reports
 - a. Provide copies of all test records and reports as specified in the various technical specifications.

K. Manufacturer's Guaranty/Warranty/Bonds

1. Contractor to provide a list at the Preconstruction conference of all Warranties deemed to start before Substantial Completion.
2. Assemble a booklet or binder of all warranties and bonds as specified in the various technical specifications and in accordance with the specification on Warranties and Bonds; and provide two originals to the Owner/Engineer.

L. As-Built Surveys

1. Engage the services of a licensed land surveyor in accordance with the Project Controls (Surveying) specification Section 01050. Prior to Final Completion, provide an as-built survey of all the constructed facilities, as specified.

M. Contract Close-Out Documents

1. Submit Contract documentation as indicated in the specification Section 01740.

PART 2 PRODUCTS (NOT USED)

PART 3 EXECUTION

3.01 SUBMITTAL SCHEDULE

- A. Provide an initial submittal schedule at the Pre-Construction conference for review by Owner/Engineer. Incorporate comments from Owner/Engineer into a revised submittal schedule.
- B. Maintain the submittal schedule and provide sufficient copies for review by Owner/Engineer. An up-to-date submittal schedule shall be provided at each project progress meeting.

3.02 TRANSMITTALS

- A. Prepare separate transmittal sheets for each submittal. Each transmittal sheet shall include at least the following: the Contractor's name and address, Owner's name, project name, project number, submittal number, description of submittal and number of copies submitted.
- B. Submittals shall be transmitted or delivered directly to the office of the Owner/Engineer, as indicated in the Contact Documents or as otherwise directed by the Owner/Engineer.
- C. Provide copies of transmittals forms or cover letters (without attachments) directly to the PM.

3.03 ACTION SUBMITTALS

- A. Contractors Responsibilities.
 1. Coordination of Submittal Times: Prepare and transmit each submittal sufficiently in advance of performing the related work or other applicable activities, or within the time specified in the individual work of other related Sections, so that the installation will not be delayed by processing times including disapproval and resubmittal (if required). Coordinate with other submittals, testing, purchasing, fabrication, delivery and similar sequenced activities. Extensions to the Contract Time will not be approved for the Contractor's failure to transmit submittals sufficiently in advance of the Work.
 2. The submittals of all shop drawings (including working drawings and product data) shall be sufficiently in advance of construction requirements to allow for possible need of re-submittals, including review time for the Owner/Engineer.
 3. No less than 30 calendar days will be required for Owner/Engineer's review time for shop drawings and O&M manuals involving only one Owner/Engineering discipline. No less than 45 calendar days will be required for Owner/Engineer's review time for shop drawings and O&M manuals that require review by more than one Owner/Engineering discipline. Resubmittals will be subject to the same review time.
 4. Submittals of operation and maintenance data shall be provided within 30 days of approval of the related shop drawing(s).
 5. Before submission to the Owner/Engineer, review shop drawings as follows:
 - a. make corrections and add field measurements, as required
 - b. use any color for its notations except red (reserved for the Owner/Engineer's notations) and black (to be able to distinguish notations on black and white Documents)
 - c. identify and describe each and every deviation or variation from Contract documents or from previous submissions, except those specifically resulting from a comment from the Owner/Engineer on a previous submission
 - d. include the required Contractor's Certification statement
 - e. provide field measurements (as needed)
 - f. coordinate with other submittals
 - g. indicate relationships to other features of the Work
 - h. highlight information applicable to the Work and/or delete information not applicable to the Work

6. Submit the following number of copies:
 - a. Shop drawings (including working drawings and product data) – Submit no fewer than four copies and an electronic version.
 - b. Samples – four copies and an electronic version
 - c. Site Usage Plan – four copies and an electronic version
 - d. Schedule of values – four copies and an electronic version
 - e. Payment application format – four copies and an electronic version
7. If Contractor considers any correction indicated on the shop drawings to constitute a change to the Contract Documents, provide written notice thereof to the Owner/Engineer immediately; and do not release for manufacture before such notice has been received by the Owner/Engineer.
8. When the shop drawings have been completed to the satisfaction of the Owner/Engineer, carry out the construction in accordance therewith; and make no further changes therein except upon written instructions from the Owner/Engineer.

B. Owner/Engineer’s Responsibilities

1. Owner/Engineer will not review shop drawings (including working drawings and product data) that do not include the Contractor's approval stamp and required certification statement. Such submittals will be returned to the Contractor, without action, for correction.
2. Partial shop drawings (including working drawings and product data) will not be reviewed. If, in the opinion of the Owner/Engineer, a submittal is incomplete, that submittal will be returned to the Contractor for completion. Such submittals may be returned with comments from Owner/Engineer indicating the deficiencies requiring correction.
3. If shop drawings (including working drawings and product data) meet the submittal requirements, Owner/Engineer will forward copies to appropriate reviewer(s). Otherwise, noncompliant submittals will be returned to the Contractor without action - with the Owner/Engineer retaining one copy.
4. Submittals which are transmitted in accordance with the specified requirements will be reviewed by the Owner/Engineer within the time specified herein. The time for review will commence upon receipt of submittal by Owner/Engineer.

C. Review of Shop Drawings (Including Working Drawings and Product Data) and Samples

1. The review of shop drawings, working drawings, data and samples will be for general conformance with the design concept and Contract Documents. They shall not be construed:
 - a. as permitting any departure from the Contract requirements
 - b. as relieving the Contractor of responsibility for any errors, including details, dimensions, and materials

- c. as approving departures from details furnished by the Owner/Engineer, except as otherwise provided herein
2. The Contractor remains responsible for details and accuracy, for coordinating the work with all other associated work and trades, for selecting fabrication processes, for techniques of assembly, and for performing work in a safe manner.
3. If the shop drawings (including working drawings and product data) or samples as submitted describe variations and indicate a deviation from the Contract requirements that, in the opinion of the Owner/Engineer are in the interest of the Owner and are so minor as not to involve a change in Contract Price or Contract Time, the Owner/Engineer may return the reviewed drawings without noting an exception.
4. Only the Owner/Engineer will utilize the color "RED" in marking submittals.
5. Shop drawings will be returned to the Contractor with one of the following codes.
 - a. Code 1 – "NO EXCEPTIONS" – This code is assigned when there are no notations or comments on the submittal. When returned under this code the Contractor may release the equipment and/or material for manufacture.
 - b. Code 2 - "APPROVED WITH CORRECTIONS NOTED" - This code is assigned when a confirmation of the notations and comments IS NOT required by the Contractor. The Contractor may release the equipment or material for manufacture; however, all notations and comments must be incorporated into the final product.
 - c. Code 3 - "APPROVED WITH CORRECTIONS NOTED/CONFIRM" - This combination of codes is assigned when a confirmation of the notations and comments is required by the Contractor. The Contractor may release the equipment or material for manufacture; however, all notations and comments must be incorporated into the final product. This confirmation shall specifically address each omission and nonconforming item that was noted. Confirmation is to be received by the Owner/Engineer within 15 calendar days of the date of the Owner/Engineer's transmittal requiring the confirmation.
 - d. Code 4 - "APPROVED AS NOTED/RESUBMIT" - This combination of codes is assigned when notations and comments are extensive enough to require a resubmittal of the entire package. This resubmittal is to address all comments, omissions and non-conforming items that were noted. Resubmittal is to be received by the Owner/Engineer within 30 calendar days of the date of the Owner/Engineer's transmittal requiring the resubmittal.
 - e. Code 5 – "REJECTED" – This code is assigned when the submittal does not meet the intent of the contract documents. The Contractor must resubmit the entire package revised to bring the submittal into conformance. It may be necessary to resubmit using a different manufacturer/vendor to meet the requirements of the contract documents.
 - f. Code 6 – "COMMENTS ATTACHED" – This code is assigned where there are comments attached to the returned submittal, which provide additional data to aid the Contractor.

- g. Code 7 – "RECEIPT ACKNOWLEDGED (Not subject to Owner/Engineer's Review or Approval)" – This code is assigned to acknowledge receipt of a submittal that is not subject to the Owner/Engineer's review and approval, and is being filed for informational purposes only. This code is generally used in acknowledging receipt of means and methods of construction work plans, field conformance test reports, and health and safety plans.
 - h. Codes 1 through 5 designate the status of the reviewed submittal. Code 6 indicates that some or all of the Owner/Engineer's comments are included in an attachment.
6. Repetitive Reviews: Shop drawings, O&M manuals and other submittals will be reviewed no more than twice at the Owner's expense. All subsequent reviews will be performed at the Contractor's expense. Reimburse the Owner for all costs invoiced by Engineer for the third and subsequent reviews.

D. Electronic Transmission

- 1. Action Submittals may be transmitted by electronic means provided the following conditions are met:
 - a. The above-specified material shall include a transmittal form with specified numbering configuration.
 - b. All other requirements specified above have been met including, but not limited to, coordination by the Contractor, review and approval by the Contractor, and the Contractor's Certification.
 - c. The submittal contains no pages or sheets larger than 11 x 17 inches.
 - d. With the exception of the transmittal sheet, the entire submittal is included in a single file.
 - e. The electronic files are PDF format (with printing enabled).
 - f. For Submittals that require certification, corporate seal, or professional embossment (i.e., P.E.s, Surveyors, etc.) transmit at least two hard-copy originals to the Owner/Engineer. In addition, provide additional photocopied or scanned copies, as specified above, showing the required certification, corporate seal, or professional seal.

3.04 INFORMATIONAL SUBMITTALS

A. Contractor's Responsibilities

- 1. Number of copies: Submit three copies, unless otherwise indicated in individual Specification sections
- 2. Refer to individual technical Specification Sections for specific submittal requirements.

B. Owner/Engineer's Responsibilities

1. The Owner/Engineer will review informal submittals, schedules, and information and determine if acceptable, however, acceptance will not impose responsibilities on the the Owner/Engineer or interfere with or relieve the Contractor from the Contractor's full responsibilities.
2. The Owner/Engineer will review each informational submittal within 14 Calendar days. If the informational submittal complies with the Contract requirements, Owner/Engineer will file for the project record and transmit a copy to the Owner. Owner/Engineer may elect not to respond to Contractor regarding informational submittals meeting the Contract requirements.
3. If an informational submittal does not comply with the Contract requirements, Owner/Engineer will respond accordingly to the Contractor within 14 Calendar days. Thereafter, the Contractor shall perform the required corrective action, including retesting, if needed, until the submittal, in the opinion of the Owner/Engineer, is in conformance with the Contract Documents.

C. Electronic Transmission

1. Informational submittals may be transmitted by electronic means providing all of the following conditions are met:
 - a. The above-specified material shall include a transmittal form with specified numbering configuration.
 - b. All other requirements specified above have been met including, but not limited to, coordination by the Contractor, review and approval by the Contactor, and the Contractor's Certification.
 - c. The submittal contains no pages or sheets larger than 11 x 17 inches.
 - d. With the exception of the transmittal sheet, the entire submittal is included in a single file.
 - e. The electronic files are PDF format (with printing enabled).
 - f. For Submittals that require certification, corporate seal, or professional embossment (i.e., P.E.s, Surveyors, etc.) transmit at least two hard-copy originals to the Owner/Engineer. In addition, provide additional photocopied or scanned copies, as specified above, showing the required certification, corporate seal, or professional seal.

END OF SECTION

P.E. CERTIFICATION FORM

The undersigned hereby certifies that he/she is a professional Engineer registered in the State of South Carolina and that he/she has been employed by

_____ to design
(Company Name)

(Insert P.E. Responsibilities)

In accordance with Specification Section _____ for the

_____.
(Name of Project)

The undersigned further certifies that he/she has performed the said design in conformance with all applicable local, state and federal codes, rules and regulations; and, that his/her signature and P.E. stamp have been affixed to all calculations and drawings used in, and resulting from, the design.

The undersigned hereby agrees to make all original design drawings and calculations available to the City of Georgetown or Owner's representative within seven days following written request therefor by the Owner.

P.E. Name

Company Name

Signature

Signature

P.E. Registration Number

Title

Address

Address

THIS PAGE INTENTIONALLY LEFT BLANK

SECTION 01310
CONSTRUCTION SCHEDULING

PART 1 GENERAL

1.01 PROGRAM DESCRIPTION

- A. A Critical Path Method (CPM) construction schedule shall be used to control the Work and to provide a basis for determining job progress. The construction schedule shall be prepared and maintained by the Contractor. All work shall be done in accordance with the established CPM schedule. The Contractor and all subcontractors shall cooperate fully in developing the construction schedule and in executing the work in accordance with the CPM schedule.
- B. The construction schedule shall consist of a computerized CPM network (diagram of activities) presented in a time-scaled graphic (print-out) with reports, as specified herein.
- C. There shall be no direct payment for this Work, the cost of which shall be included in other Bid Items as directed in Section 01025.

1.02 SUBMITTALS

- A. Contractor shall submit Interim, Preliminary Baseline, Baseline (also known as "as-planned") schedules, revisions, and Monthly Status Reports, all including graphics, reports, and narratives, and an as-built schedule, as specified herein.

PART 2 PRODUCTS

2.01 SOFTWARE

- A. Unless otherwise approved by the Owner/Engineer, the computer-based schedule shall be generated using Microsoft Project 2010 or higher or Oracle-Primavera P6 Professional Project Management Software Release 8.3 or higher.
- B. If the Contractor wants to pursue the use of another scheduling software (other than what is stated above) they need to submit a written request within 5 days of award of contract to the Owner/Engineer justifying their intended scheduling software selection.

2.02 NETWORK REQUIREMENTS

- A. Each schedule submittal shall contain and display the following identifying information:
 - 1. Project Title, Owner's Project Number
 - 2. Contractor's name
 - 3. All Contract milestones, as specified
 - 4. The project calendar(s) (including work week and holidays)
 - 5. Type of submittal (e.g., Interim, Preliminary Baseline, Baseline or Monthly Status Report)

6. Page number and total page count
 7. Data date and run (print) date and time
- B. The network of activities shall show the order and inter-dependence of activities; and, show the sequence in which the work is to be accomplished, as planned by the Contractor. The basic concept of a network analysis diagram shall be followed to show how each activity is dependent on preceding activities (predecessors) and following activities (successors).
 - C. All activities shall be sufficiently identified and/or described so that the scope of work of each activity is clear. All work tasks shall be broken down into appropriate scopes and durations to facilitate monitoring progress within a given month.
 - D. Network activities shall be organized (grouped) by phases (or stages), physical areas, buildings, elevations, or other portions of the project.
 - E. Separate network activities shall be provided for subcontractors.
 - F. The number of network activities, sufficiency of description, and level of breakdown shall be subject to the Owner/Engineer's review and approval to confirm conformance with the specified requirements.
 - G. The format of the schedule network graphic shall be a time-scaled logic diagram - with a list of network activities and the specified data fields presented adjacent to the graphic display.
 - H. The following general requirements also apply to the network diagram.
 1. The Critical Path (the sequence of project network activities that add up to the longest overall duration and thereby determines the shortest time possible to complete the project) shall be identified - preferably in 'red'.
 2. Unless otherwise approved by the Owner/Engineer, the Contractor's work schedule shall be based on 'normal work week' as defined in the Contract Documents – (typically 40 hours per week, consisting of five 8-hour days).
 3. The graphics shall indicate the calendar(s) on which activity durations are based (i.e., 5-day workweek or 7 calendar day week). When multiple calendars or work weeks are used, the graphics shall clearly indicate which calendars are used where.
 4. The project calendar shall include exclusions for holidays observed by the Contractor and those indicated in the Contract Documents.
 - I. Each network activity shall have the following information (fields) listed alongside the activity on the graphic display.
 1. Activity ID – a manually assigned designation (numeric or alphanumeric). The Contractor should use a logical approach to assigning identification to network activities to facilitate grouping (sorting) of activities.
 2. Activity Description needs to include an Action verb, Element, and Demarcation Points (for example: Excavate 6” CPVC Line from Sta. 14+15 to 16+01)

3. Original Duration – including allowances for adverse weather interruptions – normal for the project location, as defined in the Contract Documents.
4. Percent complete – the Contractor's estimated physical percent complete for each network activity as of the data date for the respective report.
5. Remaining Duration - a calculated value based on Original Duration of each network activity.
6. Early Start Date
7. Early Finish Date
8. Late Start Date
9. Latest Finish Date
10. Total Float

2.03 SUBMITTAL REQUIREMENTS

A. Each schedule submittal shall include the following elements:

1. Graphics – unless otherwise approved by the Owner/Engineer, the network graphics shall consist of 4 copies on 11X17 single sided sheets and an electronic PDF file; including a list of activities and the specified data fields.
2. Narrative
 - a. The Narrative shall consist of a written report by the Contractor providing an overview of the schedule – specific to each submittal.
 - b. The Narrative for the Baseline Schedule shall:
 - 1) explain key activities and assumptions on which the schedule is based;
 - 2) describe the Critical Path;
 - 3) discuss key deliveries that might adversely affect the project schedule; and,
 - c. The Narratives provided with Monthly Status Reports (updates) shall also identify:
 - 1) any changes the Contractor has made to the CPM logic (including any added, modified or deleted activities,
 - 2) any delays that have been encountered, and
 - 3) remedial actions or recovery steps the Contractor will employ to arrest and/or recover from such delays.

PART 3 EXECUTION

3.01 IMPLEMENTATION SCHEDULE

A. Interim Schedule

1. Within 15 days following the receipt of the Notice to Proceed, submit an Interim Schedule indicating the planned operations during the first 60 calendar days after Notice to Proceed. In addition, the Contractor shall indicate its general approach for the balance of the project.
2. While the Preliminary Baseline schedule is being developed, the Contractor shall update the Interim schedule on a monthly basis – indicating actual progress - until the Preliminary Baseline schedule is submitted.

B. Preliminary Baseline Schedule

1. Within 30 days following the receipt of Notice to Proceed, submit a proposed Preliminary Baseline Schedule. The Preliminary Baseline Schedule shall consist of a draft computer-generated CPM-schedule showing the entire Scope of Work. The Preliminary Baseline Schedule shall not include any actual progress earned during development of the schedule (i.e., as of the Notice to Proceed).
2. Within 5 days of submittal of the Preliminary Baseline Schedule, meet with the Owner/Engineer to discuss the review comments.
3. Once the Preliminary Baseline Schedule is submitted, Contractor shall discontinue updating the Interim Schedule. Provide monthly updates of the Preliminary Baseline Schedule until concurrence, acceptance, or approval of the Baseline Schedule.

C. Baseline (as-planned) Schedule

1. With 10 days of the review meeting on the Preliminary Baseline Schedule submittal, the Contractor shall incorporate the Owner/Engineer's comments into the network and submit a Baseline Schedule.

D. Monthly Status Reports

1. Monthly Status Reports shall include updated graphics and a narrative.
2. The Contractor shall provide Monthly Status Reports (schedule updates) commencing approximately 30 days after submission of the Interim Schedule.

E. As-Built Schedule

1. Upon achieving Substantial Completion, the Contractor shall submit an as-built schedule, showing all activities from the Notice to Proceed through Substantial Completion.

3.02 RESPONSIBILITY FOR SCHEDULE COMPLIANCE

- A. Whenever it becomes apparent from the current CPM schedule and CPM Status Report that delays to the critical path have resulted and the contract completion date will not be met, or when so directed by the Owner/Engineer, take some or all of the following actions at no additional cost to the Owner. Submit to the Owner/Engineer for approval, a written statement of the steps intended to take to remove or arrest the delay to the critical path in the approved schedule.
1. Increase construction manpower in such quantities and crafts,
 2. Increase the number of working hours per shift, shifts per day, working days per week,
 3. Increase the amount of construction equipment, and/or
 4. Reschedule activities to maximize the concurrence of activities and comply with the revised schedule.

END OF SECTION

THIS PAGE INTENTIONALLY LEFT BLANK

SECTION 01320
CONSTRUCTION PHOTOGRAPHS AND VIDEO RECORDING

PART 1 GENERAL

1.01 SCOPE OF WORK

- A. Furnish all labor, materials, equipment, and incidentals required to provide photographic documentation and video taping of the Project as specified herein.
- B. There shall be no direct payment for this Work, the cost of which shall be included in other Bid Items.
- C. Work includes administrative and procedural requirements for the following:
 - 1. Preconstruction photographs.
 - 2. Periodic construction photographs.
 - 3. Construction completion photographs.
 - 4. Preconstruction video recordings.
 - 5. Periodic construction video recordings.

1.02 RELATED WORK

- 1. Section 01300 - Submittals.
- 2. Section 01720 - Record Documents.

1.03 REFERENCES

- A. Not Used.

1.04 SUBMITTALS

- A. Key Plan: Submit key plan of Project site and/or buildings with notation of vantage points marked for location and direction of each photograph. Indicate elevation or story of construction if applicable.
- B. Digital Photographs: Submit image files within seven days of taking photographs.
 - 1. File Format: Minimum 3200 by 2400 pixels, in unaltered original files, with same aspect ratio as the sensor, uncropped, date and time stamped, in folder named by date of photograph, City of Georgetown's Project Number, and accompanied by key plan file.
 - 2. Submit digital photographs in data disc format as follows:
 - a. Full-size on recordable external storage devices.

- b. Clearly and indelibly label using self-adhesive labels specifically designed for labeling of discs. Include on the label the project name, project number, and the time period covered by the photographs contained on the disc.
 3. If requested by the Owner/Engineer, upload all digital photographs to the Project Management Information System as directed.
 4. Identification: Provide the following information with each image description in file metadata tag:
 - a. Name of Project.
 - b. Name and contact information for photographer.
 - c. Name of Engineer and/or Owner's Construction Manager.
 - d. Name of Contractor.
 - e. Date and time photograph was taken.
 - f. Description of vantage point, indicating location, direction (by compass point), and elevation or story of construction.
 - g. Unique sequential identifier keyed to accompanying key plan.

C. Video Recordings: Submit video recordings within seven days of recording.

1. Submit video recordings in digital video disc format acceptable to Owner/Engineer.
 - a. Full-size on recordable external storage devices.
 - b. Clearly and indelibly label using self-adhesive labels specifically designed for labeling of discs. Include on the label the project name, project number, and the time period covered by the photographs contained on the disc.
2. If requested by the Owner/Engineer, upload all digital photographs to the Project Management Information System as directed.
3. Identification: With each submittal, provide the following information:
 - a. Name of Project.
 - b. Name and contact information for videographer.
 - c. Name of Engineer and/or Owner's Construction Manager.
 - d. Name of Contractor.
 - e. Date video recording was recorded.
 - f. Description of vantage point, indicating location, direction (by compass point), and elevation or story of construction.
 - g. Weather conditions at time of recording.

1.05 USAGE RIGHTS

- A. Obtain and transfer copyright usage rights from photographer and/or videographer or Contractor to Owner for unlimited reproduction of photographic documentation.

PART 2 PRODUCTS

2.01 PHOTOGRAPHIC MEDIA

A. Digital Photographs:

1. Provide digital photographs produced by a dedicated, fixed- or interchangeable-lens digital camera or other electronic device.
2. Digital Camera: Have a minimum image resolution of 12 megapixels, and produce images in JPEG (.JPG) format with image dimensions of not less than 3200 by 2400 pixels.
3. Include date and time in file name for each image.

B. Digital Video Recordings:

1. Provide video recordings made with a dedicated digital video camera specifically made for video recordings.
2. Digital Video Camera: Have a minimum resolution of 720p (1280 x 720, progressive).
3. Provide video recordings in a common digital video format such as .MP4 or .WMV. The minimum resolution of all video files shall be 720p (1280 x 720, progressive).

PART 3 EXECUTION

3.01 GENERAL

- A. Engage a qualified photographer to take construction photographs.
- B. Take photographs that clearly show the Work. Exhibit correct exposure and focus, accurate color balance, maximum depth of field, minimal optical distortion, and minimal noise. Photographs that, in the Owner/Engineer's opinion, do not meet these quality criteria will not be accepted and shall be re-taken at no additional cost to the Owner.
- C. Discuss key plan and obtain Owner/Engineer preliminary approval at the Pre-Construction Meeting. Maintain key plan with each set of construction photographs that identifies each photographic location.
- D. Submit digital images exactly as originally recorded in the digital camera, without alteration, manipulation, editing, or modifications using image-editing software.

3.02 PRECONSTRUCTION PHOTOGRAPHS

- A. Before commencement of any excavation, demolition, or start of any construction, take photographs of Project site and surrounding properties, including existing items to remain during construction, from different vantage points. Take additional photographs as specifically as directed by the Owner/Engineer.
- B. Flag excavation areas and construction limits before taking construction photographs.

- C. Take photographs to show existing conditions, including roadways, parking lots, driveways, walkways, etc., adjacent to property before starting the Work.
- D. Take photographs of existing buildings either on or adjoining property to accurately record physical conditions at start of construction.
- E. Take photographs as required to record existing settlement or cracking of adjacent structures, pavements, and improvements.
- F. The exact number of photographs will depend on the complexity of the project and the density of the surrounding area. The Contractor shall ensure an adequate number of photographs are taken to properly document the above existing conditions.

3.03 PERIODIC CONSTRUCTION PHOTOGRAPHS

- A. As requested, take progress photographs periodically. Select vantage points to show status of construction and progress since last photographs were taken.

3.04 FINAL COMPLETION CONSTRUCTION PHOTOGRAPHS

- A. Take photographs after date of Substantial Completion for submission as project record documents as required by Section 01720.
- B. The exact number of photographs will depend on the complexity of the project and the density of the surrounding area, but in general should be at the same locations of the Preconstruction photographs. The Contractor shall ensure an adequate number of photographs are taken to properly document the above existing conditions.

END OF SECTION

SECTION 01370
SCHEDULE OF VALUES

PART 1 GENERAL

1.01 REQUIREMENTS INCLUDED

- A. Submit a Schedule of Values allocated to the various lump sum portions of the work, within 21 days after the effective date of the Agreement.
- B. Upon request of the Owner/Engineer, support the values with data which will substantiate their correctness.
- C. The accepted Schedule of Values shall be used only as the basis for the Contractor's Applications for Payment.

1.02 RELATED REQUIREMENTS

- A. Section 00700 - General Conditions of the Construction Contract.
- B. Section 01026 - Application for Payment.

1.03 FORM AND CONTENT OF SCHEDULE OF VALUES

- A. Type schedule on an 8-1/2-in by 11-in paper. Contractor's standard forms and automated printout will be considered for approval by the Owner/Engineer upon Contractor's request. Identify schedule with:
 - 1. Title of Project and location.
 - 2. Engineer and Project number.
 - 3. Name and Address of Contractor.
 - 4. Contract designation.
 - 5. Date of submission.
- B. Schedule shall list the installed value of the component parts of the work in sufficient detail to serve as a basis for computing values for progress payments during construction.
- C. Identify each line item with the number and title of the respective Section.
- D. For each major line item, list sub-values of major products or operations under the item.
- E. For the various portions of the work:
 - 1. Each item shall include a directly proportional amount of the Contractor's overhead and profit.

2. For items on which progress payments will be requested for stored materials, break down the value into:
 - a. The cost of the materials, delivered and unloaded, with taxes paid. Paid invoices are required for materials upon request by the Engineer.
 - b. The total installed value.
- F. The sum of all values listed in the schedule shall equal the total Contract Sum. If the schedule is specific to an individual lump sum bid item such as Miscellaneous Work – General Requirements, the total shall equal the total bid item amount.

1.04 SUBSCHEDULE OF UNIT MATERIAL VALUES

- A. Submit a sub-schedule of unit costs and quantities for:
 1. Products on which progress payments will be requested for stored products.
- B. The form of submittal shall parallel that of the Schedule of Values, with each item identified the same as the line item in the Schedule of Values.
- C. The unit quantity for bulk materials shall include an allowance for normal waste.
- D. The unit values for the materials shall be broken down into:
 1. Cost of the material, delivered and unloaded at the site, with taxes paid.
 2. Copies of invoices for component material shall be included with the payment request in which the material first appears.
 3. Paid invoices shall be provided with the second payment request in which the material appears or no payment shall be allowed and/or may be deleted from the request.
- E. The installed unit value multiplied by the quantity listed shall equal the cost of that item in the Schedule of Values.

PART 2 PRODUCTS (NOT USED)

PART 3 EXECUTION (NOT USED)

END OF SECTION

SECTION 01400
QUALITY CONTROL

PART 1 GENERAL

1.01 SCOPE OF WORK

- A. This Section includes general requirements related to the Contractor's responsibility for quality control involving inspections, testing, and certifications. Testing includes both shop tests (those provided by the manufacturer prior to shipment of equipment to the site) and field tests (performance tests of installed equipment and in-situ testing of materials by a state-certified laboratory). Specific requirements are also included in the individual technical sections.
- B. There shall be no direct payment for this Work, the cost of which shall be included in the Miscellaneous Work - Mobilization/Demobilization Bid Item.
- C. This Section includes the following:
 - 1. Inspections.
 - 2. Quality Assurance – Control of Installation.
 - 3. Inspecting and Physical Testing Laboratory Services.
 - 4. Equipment Calibration.
- D. Unless otherwise indicated, only new materials shall be incorporated in the Work. All materials furnished by the Contractor to be incorporated in the Work shall be subject to the inspection and approval of the Owner/Engineer. For all materials requiring approval, no materials shall be processed for, or delivered to the Site without prior approval by the Owner/Engineer.
- E. All materials of construction, supplies and parts, particularly those upon which the strength and durability of the structure may depend, shall be subject to inspection and testing to establish conformance with specifications and suitability for uses intended.
- F. All materials, parts and equipment furnished and incorporated in the work shall be of high grade materials, free from defects and imperfections, and of recent manufacture. Workmanship shall be of the highest grade and in accordance with the best modern standard of practice.
- G. When required, all tests shall be made in the presence of the Owner/Engineer. Where not required, sworn statements or test results shall be furnished by the Contractor within 7 days of completion of tests.

1.02 RELATED WORK

- A. Section 01300 - Submittals.
- B. Specific testing and inspection requirements are also specified in the individual Technical Specifications.

- C. Where standard published specifications of recognized authorities or organizations are specified, the latest revision of such specification at the time the work is executed shall govern, unless otherwise authorized or directed.

1.03 SUBMITTALS

- A. The Contractor is responsible for providing the Owner/Engineer a copy of the proposed Quality Control and Quality Acceptance Program for review and for maintaining such program for the duration of the project within 30 days of Notice to Proceed.
- B. The Contractor shall provide the Owner/Engineer copies of the Contractor-selected South Carolina Department of Transportation Certified material testing laboratories
- C. The Contractor shall provide the Owner/Engineer copies of current organizational chart including names, telephone numbers and current certifications of personnel responsible for the Quality Control Program, testing, inspection, etc. on the project. All tests performed shall be under the supervision of certified personnel or it may result in nonpayment, delay and/or reduction in payment for the material of concern.
- D. Where the specifications call for certified copies of mill or shop tests to establish conformance with the specifications, it shall be the responsibility of the Contractor to assure the delivery of such certifications to the Owner/Engineer.
- E. Transcripts or certified shop test reports including all test results shall be submitted for review to the Owner/Engineer and approved prior to delivery of any equipment to the site. The testing shall have been performed by an approved independent testing facility within the previous six months. Transcripts of test results shall be accompanied by a certificate in the form of a letter from the manufacturer or supplier certifying that the tested material meets the specified requirements and is of the same type, quality, manufacturer, and make as that specified.
- F. The Contractor shall submit signed and certified written reports of each field inspection, test, or similar quality control and quality assurance service performed to the Owner/Engineer within seven (7) working days of the performed service. Written reports and attached forms of each field inspection, test or similar service shall be complete and accurate, shall specify the test locations, shall specify the tests performed, shall include the methods used to perform the test and shall be signed, stamped and dated by the certified person of the state-certified laboratory or testing firm. Reports shall also include:
 - 1. Date of issue.
 - 2. Project title and project number.
 - 3. Name, address, and telephone number of testing laboratory or firm.
 - 4. Dates and locations of samples and tests or inspections.
 - 5. Names of individuals making the inspection or test.
 - 6. Designation of the Work and test method.
 - 7. Identification of product or material and Specification Section.

8. Complete inspection of test data.
9. Test results and an interpretation of test results.
10. Ambient conditions at the time of sample taking and testing.
11. Comments or professional opinion on whether inspected or tested Work complies with requirements.
12. Name and signature of laboratory inspector.
13. Recommendations on retesting.

1.04 INSPECTIONS

- A. The Engineer and the Owner shall have the right to inspect all material and equipment at all stages of collection and processing, and shall be allowed access to the site and to the Contractor's and supplier's facilities to conduct such inspections. Onsite work shall be subject to continuous inspection. Inspection by the Engineer or the Owner shall not release the Contractor from responsibility or liability with respect to material, installation or workmanship. The Engineer or the Owner will supply the Contractor a minimum of 24 hours' notice prior to unscheduled offsite inspections.
- B. No materials or finished articles shall be incorporated in the work until such materials and finished articles have passed any required tests. The Contractor shall promptly segregate and remove rejected material or finished articles from the site of the work. Failure to condemn the material on preliminary inspection shall not be grounds for acceptance if defects are found later.
- C. When local codes or laws require approval and inspection of the work by other agencies or organizations, the Contractor shall obtain such approval and submit one signed original and three copies of the approval to the Owner/Engineer.
- D. The Owner/Engineer shall have the right to mark rejected materials to distinguish them as such.
- E. The Contractor shall furnish the inspector with the necessary facilities and assistance for carrying out his duties. The work and materials shall be supervised by the Owner/Engineer and the inspectors to obtain the finished product in accordance with the Contract Documents. The Owner shall not assume any liabilities of the Contractor or relieve him of any of his obligations.
- F. The Owner/Engineer shall determine the quality and quantity of all work and materials which are included in this contract. He shall answer all questions relating to lines, levels and dimensions of the work, and interpretations of the plans and specifications.
- G. The Owner/Engineer shall be the final judge of the quality and suitability of the work and materials. Should they fail to meet his approval and/or do not conform to the requirements of the Contract Documents, upon notice from the Owner/Engineer, they shall be removed from the work, forthwith reconstructed, made good, replaced and/or corrected by the Contractor at his own expense. Rejected materials shall immediately be removed from the site. If, in the opinion of the Owner/Engineer, it is undesirable to replace any defective or damaged materials or to reconstruct or correct any portion of the work injured or not performed in accordance with the

Contract Documents, the compensation to be paid to the Contractor hereunder shall be reduced by such amount that, in the judgment of the Owner/Engineer, shall be equitable.

- H. The testing and approval of materials by the laboratory, or laboratories, shall not relieve the Contractor of his obligations to fulfill his contract and guarantee workmanship and materials. The Contractor may, at his option, and at his own expense, cause such other test to be conducted as he may deem necessary to assure suitability, strength and durability of any material or finished article.

1.05 QUALITY ASSURANCE – CONTROL OF INSTALLATION

- A. The Contractor shall monitor quality control over suppliers, products, services, site conditions, and workmanship, to produce work of specified quality.
- B. The Contractor shall comply with manufacturers' instructions, including complying with each step, in-sequence.
- C. The Contractor shall examine the areas and conditions where work is to be performed and notify the Owner/Engineer of conditions detrimental to the proper and timely completion of the Work. The Contractor shall not proceed with the work until unsatisfactory conditions have been corrected by the Contractor in a manner acceptable to the Owner/Engineer.
- D. The Contractor shall request clarification from Owner/Engineer should manufacturers' instructions conflict with Contract Documents. The clarification shall be received prior to proceeding.
- E. The Contractor shall comply with specified standards as minimum quality for the work except where more stringent tolerances, codes, or specified requirements indicate higher standards or more precise workmanship.
- F. Work shall be performed by persons qualified to produce workmanship of specified quality.
- G. All tests performed shall be under the supervision of certified personnel or it may result in nonpayment, delay and/or reduction in payment for the material of concern.

1.06 INSPECTING AND PHYSICAL TESTING LABORATORY SERVICES

- A. The Contractor shall contract with an independent Subcontractor, upon review and acceptance by the Owner and the Engineer, to perform laboratory testing as required by these Specifications and as required by the Owner.
- B. The independent testing firm(s) shall have performed previous similar work in a satisfactory manner, be an approved subcontractor, and specialize in the types of inspections and tests to be performed. Testing firm(s) shall be authorized by authorities having jurisdiction to operate in the State of South Carolina. Unless noted otherwise, the Contractor shall include the costs of this service in his bid.
- C. The Contractor shall provide labor and materials and necessary testing facilities at the site as required by Specifications and the independent laboratories. The Contractor shall cooperate with the Owner and the Engineer and the independent laboratory and shall provide the testing firm with at least 24 hours' notice prior to specified testing.

- D. Inspecting, testing, and source quality control may occur on or off the project site. Offsite inspecting or testing shall be performed as required by the Engineer or the Owner.
- E. The Contractor shall be responsible for scheduling and coordinating inspections, tests, and similar activities with minimum delay to project.
- F. The Contractor shall manage and coordinate all material testing and sequencing of activities to avoid the necessity of removing and replacing construction work to accommodate inspections and tests. The Contractor is responsible for scheduling times for inspections, testing, taking samples, and similar activities and shall be responsible for ensuring all tests are performed in accordance with the Contract Documents. The Contractor shall notify the Owner/Engineer a minimum of 24-hours in advance of testing and all testing shall be conducted during typical Owner working hours, unless approved otherwise in advance.

1.07 EQUIPMENT CALIBRATION

- A. All field test equipment will be kept under control of the Contractor's testing Subcontractor. The testing Subcontractor will be fully trained in the use of equipment, test procedures, and interpretations of results for each piece of test equipment. A copy of calibration certification will be kept by the testing Subcontractor and supplied to the Owner/Engineer.
- B. Calibration of nuclear-density gauges shall conform to the frequencies and methods outlined in ASTM D2922 and D3017. Unstable or erratic gauges shall not be used in density testing and shall be immediately removed from the site.

PART 2 PRODUCTS (NOT USED)

PART 3 EXECUTION (NOT USED)

END OF SECTION

THIS PAGE INTENTIONALLY LEFT BLANK

SECTION 01490
MOBILIZATION/DEMobilIZATION

PART 1 GENERAL

1.01 MOBILIZATION

- A. As required by the Contract Documents and for the proper performance and completion of the Work, mobilization shall/may include, but not be limited to, the following principal items:
1. Move onto the site all Contractor's equipment required for the first month's operation.
 2. Install temporary construction power, wiring, and lighting facilities.
 3. Provide and furnish field office trailers for Contractor and Owner/Engineer as required.
 4. Provide on-site sanitary facilities and potable water facilities.
 5. Arrange for and erect Contractor's work and storage yard.
 6. Submit all required insurance certificates and bonds.
 7. Obtain all required permits.
 8. Post all OSHA, SCDHEC, Department of Labor, and all other required notices.
 9. Erect all required Project signs.
 10. Photograph existing conditions, and video record as required, all construction areas within the project area.

B. PAYMENT FOR MOBILIZATION

1. The Contractor's attention is directed to the condition that no payment for mobilization, or any part thereof, will be approved for payment under the Contract until all mobilization items listed above have been satisfactorily completed as specified.

1.02 DEMOBILIZATION

- A. As required by the Contract Documents and for the proper performance and completion of the Work, demobilization shall/may include, but not be limited to, the following principal items:
1. Remove Contractor's and Owner/Engineer's field offices and trailer used for storage, if applicable.
 2. Remove all temporary power and utility lines.
 3. Remove any temporary roadways and parking areas.
 4. Seed all areas disturbed during construction as required per the Contract Documents.

5. Remove contract signs.
 6. Photograph all completed construction areas including final restoration, and video record as required.
 7. Meet with Owner/Engineer on site and have the site approved and acceptable as is.
 8. Complete all items and submit all documents required for Close out as specified in Sections 01720 and 01740.
- B. Demobilization activities must be completed prior to the final application for payment in accordance with Section 01026.

PART 2 PRODUCTS (NOT USED)

PART 3 EXECUTION (NOT USED)

END OF SECTION

SECTION 01500
TEMPORARY FACILITIES

PART 1 GENERAL

1.01 SCOPE OF WORK

- A. Furnish all labor, equipment, materials, and incidentals necessary and provide separate temporary facilities for the Contractor's use and the Owner's/Engineer's use, as specified herein and as shown on the drawings.
- B. Operate and maintain temporary facilities for the duration of the project and as directed by the Owner/Engineer.
- C. There shall be no direct payment for this Work, the cost of which shall be included in miscellaneous Bid Items as directed by Section 01025.

1.02 RELATED WORK

- A. Section 01046 - Control of Work.
- B. Section 01300 - Submittals.

1.03 QUALITY ASSURANCE

- A. Temporary facilities shall comply with all applicable state and local ordinances, codes and regulations.
- B. Coordinate with authorities having jurisdiction to inspect (and test if required) temporary facilities.
- C. Obtain all required permits for temporary facilities.

1.04 DEFINITIONS

PART 2 PRODUCTS (NOT USED)

PART 3 EXECUTION

3.01 TEMPORARY POWER AND LIGHT

- A. Contractor shall furnish temporary light and power, complete with wiring, lamps and similar equipment as required to adequately light all work areas and with sufficient power capacity to meet the project needs. Make all necessary arrangements with the local electric company for temporary electric service and pay all expenses in connection therewith.
- B. Provide connections to existing facilities sized to provide service required for power and lighting. Contractor shall pay the costs of power used.

- C. Provide properly configured NEMA polarized outlets to prevent insertion of 110-120 Volt plugs into higher voltage outlets. For connection of power tools and equipment, provide outlets equipped with ground-fault circuit interrupters, reset button and pilot light.
- D. Provide grounded extension cords. Use heavy duty cords where exposed to abrasion and traffic. Provide waterproof connectors to connect separate lengths of electric cords if more than one length is required.
- E. Provide general service incandescent lamps as required for adequate illumination. Provide guard cages or tempered glass enclosures where exposed to breakage. Provide exterior fixtures where exposed to moisture.

3.02 TEMPORARY AIR, STEAM AND WATER

- A. Provide all air, steam and water, including temporary piping and appurtenances required for cleaning and testing pipelines and equipment. Remove temporary piping and appurtenances upon approval of equipment being tested.
- B. In order to use water from a fire hydrant, the Contractor shall apply for all requisite permits, temporary hydrant meters via the City of Georgetown.

3.03 SANITARY FACILITIES

- A. Provide self-contained, single occupant toilet units of the chemical, aerated recirculation, or combustion type, properly vented and fully enclosed in a fiberglass or other approved non-absorbent shell.
- B. Sanitary facilities shall be conveniently located in multiple locations as needed to accommodate Contractors staff.

3.04 CONSTRUCTION AIDS

- A. Provide temporary elevators, hoists, cranes, scaffolding and platforms as necessary to perform the Work. Provide temporary stairs where ladders are not adequate. Protect permanent stairs from damage from construction operations.
 - 1. Add Pedestrian Safety Walkway protection with temporary roof when be needed to protect from falling objects.
 - 2. Perform daily inspections of fence and immediately repair or replace damaged or compromised sections and as directed by the Engineer.

3.05 WASTE MANAGEMENT

- A. Provide covered dumpster, minimum 4-cubic yards, dedicated for field office waste. Provide separate covered dumpster of adequate size for construction debris. Empty dumpsters on a regular basis and as directed by the Engineer. Dumpsters shall not exceed their capacities at any time.

3.06 REMOVAL AND RESTORATION

- A. Remove each temporary facility completely when need for its service has ended and as approved by the Engineer. Coordinate removal of temporary facilities with authorities having jurisdiction.

END OF SECTION

THIS PAGE INTENTIONALLY LEFT BLANK

SECTION 01570
MAINTENANCE AND PROTECTION OF TRAFFIC

PART 1 GENERAL

1.01 SCOPE OF WORK

- A. Furnish all labor, materials, equipment and incidentals required to provide a traffic control plan, implement and maintain all traffic control measures, and construct and remove temporary access roads and ways.
- B. No individual measurement will be made for temporary construction signs, traffic cones, drums, warning lights, arrow boards, message signs, flaggers, or construction barricades. These items and all costs associated with traffic control shall be included in the lump sum Bid Item for Maintenance and Protection of Traffic.

1.02 SUBMITTALS

- A. Submit in accordance with Section 01300:
 - 1. A temporary traffic control plan(s) covering the entire project and extending throughout the life of the project.
 - 2. Layout of all proposed temporary access roads, driveways and parking areas which the Contractor will construct for the project.

PART 2 PRODUCTS (NONE THIS SECTION)

PART 3 EXECUTION

3.01 GENERAL

- A. If traffic control plans are provided in the Contract Document, the Contractor shall implement the traffic control plans in accordance with the latest edition of the SCDOT standard specifications, the Manual on Uniform Traffic Control Devices (MUTCD), and all addenda to date. All proposed changes to traffic control plans shall first be approved by the Owner and Engineer before implementation. The Contractor may implement traffic control only after receiving approval from the Owner/Engineer. The Owner/Engineer will not be responsible for delays to the Contractor due to his failure to abide by this requirement.
- B. If specific traffic control plans are not provided in the Contract Documents, the Contractor shall develop the plans submit them to the Owner/ Engineer for review. Plans shall include the following restrictions:
 - 1. Unless permission to close a street is received in writing from the proper authority, all excavated material shall be placed so that vehicular and pedestrian traffic may be maintained at all times. If the operations cause traffic hazards, the Contractor shall repair the road surface, provide temporary ways, erect wheel guards or fences, or take other measures for safety satisfactory to the Owner/Engineer.

2. Detours around construction will be subject to the approval of the Owner/Engineer. Where detours are permitted, the Contractor shall provide all necessary barricades and signs as required to divert the flow of traffic and shall provide flagmen at all times and places necessary. While traffic is detoured the Contractor shall expedite construction operations and periods when traffic is being detoured will be strictly controlled by the Owner.
3. The Contractor shall take precautions to prevent injury to the public due to open trenches. Night watchmen may be required where special hazards exist, or police protection provided for traffic while work is in progress. The Contractor shall be fully responsible for damage or injuries whether or not police protection has been provided.
4. The Contractor shall provide flaggers near all or any areas of this project where construction and/or equipment create a "blind spot" for oncoming or turning traffic.

3.02 CONTROL MEASURES

- A. The Contractor is responsible for furnishing, installing and maintaining all signs, construction barricades, supplemental warning lights, cones, drums, flashing arrow boards, arrow boards with truck-mounted attenuators, changeable message signs, truck-mounted "Prepare to Stop" signs, temporary concrete barriers and pavement markings as required through the duration of the project in accordance with the MUTCD, the SCDOT Standard Specifications for Highway Construction, and the technical specifications. All traffic control devices shall be kept operational when in use and all signs shall be kept legible and plumb day and night during their use.
- B. In the event the Owner/Engineer finds Traffic Controls are not being provided as outlined, then the Contractor will be notified. If the condition is not promptly corrected, then all work shall be suspended until such conditions are corrected.
- C. The Contractor shall provide individuals who are properly trained in traffic control practices. The job duties of these individuals shall be restricted to providing quality assurance of the traffic control installation. The Contractor shall have a person in charge of the traffic control on the job site at all times when construction activities are in progress.
- D. Maintenance of traffic control devices shall be performed in accordance with these Specifications and as deemed necessary by the Owner/Engineer. When maintenance of traffic control devices is required, the Contractor shall give the Owner/Engineer a prior notification before conducting any maintenance activities. Traffic control maintenance performed without proper notification may be rejected by the Owner/Engineer. Also, traffic control maintenance performed without proper notification or which fails to meet required performance levels due to poor workmanship and/or factory defects shall be rejected and corrected at the Contractor's expense.
- E. The Contractor shall notify property owners, by placing door hangers at least three (3) business days in advance of any inconvenience, which will be caused to each owner due to construction. The Contractor's contract name and telephone number shall be included in the notice. The Contractor shall not cut off access to any more driveways than is absolutely necessary, at any given time.

- F. The Contractor shall be responsible for the immediate removal of such traffic hazards as mud, debris, loose stone, and trash as may be washed or spilled on the traveled roadway as a result of the construction work.
- G. Storage of material and equipment will not be permitted within 15 feet of a travel lane unless in an area protected by guardrail or temporary concrete barrier.
- H. All construction exposed to pedestrian traffic including shall comply with all requirements as set forth by the most recent version of the American with Disabilities Act and the MUTCD.

3.03 ACCESS ROADS, DRIVEWAYS AND PARKING AREAS

- A. Contractor shall construct temporary access roads, driveways and parking areas where shown on the Drawings or as shown on the Contractor's approved plans at no additional cost to the Owner. These shall be included in the in the lump sum for Traffic Control Bid Item.
- B. Public streets, roads and drives used by the Contractor for access to and from the site shall be protected from damage in excess of that caused by the normal traffic of vehicles used in connection with construction work. Any such damage done shall be repaired immediately to the satisfaction of the Owner/Engineer, and left in good condition at the end of the construction period.
- C. The Contractor shall restore all existing dirt and/or gravel roads, driveways, and parking areas disturbed during the installation of the work to their preconstruction conditions, or better, unless otherwise indicated. Temporary roads and drives constructed by the Contractor for his use shall be removed and surface restored to original condition unless otherwise directed by the Owner/Engineer. No additional payment will be made for this work.
- D. Where the Work is not accessible from existing roads or streets, the Contractor shall prepare necessary roads and grade or otherwise smooth irregular terrain, along the right-of-way and/or easement, so that equipment may be moved to and operated on and along the site. Any work done under the foregoing requirements will be subject to the Owner/Engineer's approval. Easements and/or permissions to construct such roads must be in the possession of the Contractor.

END OF SECTION

THIS PAGE INTENTIONALLY LEFT BLANK

SECTION 01600
DELIVERY, STORAGE AND HANDLING

PART 1 GENERAL

1.01 SCOPE OF WORK

- A. This Section specifies the general requirements for the delivery handling, storage and protection for all items required in the construction of the work. Specific requirements, if any, are specified within individual technical sections.
- B. All materials furnished by the Contractor shall be delivered, handled, and distributed at the site by the Contractor as recommended by the manufacturer. No materials will be furnished by the Owner unless otherwise noted.
- C. There shall be no direct payment for these items, the cost of which shall be included in other bid items.

1.02 TRANSPORTATION AND DELIVERY

- A. Equipment delivery schedule – The Contractor shall prepare a schedule of anticipated shipping dates for materials and equipment. It is intended that equipment and materials be so scheduled as to arrive at the job site just prior to time for installation to prevent excessive materials on hand for inventory and the necessity for extensive storage facilities at the job site. Under no circumstances shall equipment be delivered to the site more than one month prior to installation without written authorization from the Owner/Engineer.
- B. Transport and handle items in accordance with manufacturer's instructions.
- C. Coordinate delivery with installation to ensure minimum holding time for items that are hazardous, flammable, easily damaged or sensitive to deterioration.
- D. Deliver products to the site in manufacturer's original sealed containers or other packing systems, complete with instructions for handling, storing, unpacking, protecting and installing.
- E. All items delivered to the site shall be unloaded and placed in a manner which will not hamper the Contractor's normal construction operation or those of subcontractors and other contractors and will not interfere with the flow of necessary traffic.
- F. Provide necessary equipment and personnel to unload all items delivered to the site.
- G. Promptly inspect shipment to assure that products comply with requirements, quantities are correct, and items are undamaged. For items furnished by others (i.e., Owner, other Contractors), perform inspection in the presence of the Owner/Engineer. Notify Owner/Engineer verbally, and in writing, of any problems.
- H. If any item has been damaged, including pipe and fitting linings, coatings, etc., such damage shall be repaired at no additional cost to the Owner as recommended by the manufacturer or replaced with new materials as required by the Owner/Engineer.

1.03 STORAGE AND PROTECTION

- A. Store and protect products in accordance with the manufacturer's instructions, with seals and labels intact and legible. Storage instruction shall be studied by the Contractor and reviewed with the Owner/Engineer. Instruction shall be carefully followed and a written record of this kept by the Contractor. Arrange storage to permit access for inspection.
- B. Store loose granular materials on solid flat surfaces in a well-drained area. Prevent mixing with foreign matter.
- C. Cement and lime shall be stored under a roof and off the ground and shall be kept completely dry at all times. All structural, miscellaneous and reinforcing steel shall be stored off the ground or otherwise to prevent accumulations of dirt or grease and in a position to prevent accumulations of standing water and to minimize rusting. Beams shall be stored with the webs vertical. Precast concrete shall be handled and stored in a manner to prevent accumulations of dirt, standing water, staining, chipping or cracking. Brick, block and similar masonry products shall be handled and stored in a manner to reduce breakage, cracking and spalling to a minimum.

END OF SECTION

SECTION 01720
PROJECT RECORD DOCUMENTS

PART 1 GENERAL

1.01 SCOPE

- A. The Contractor shall keep and maintain, at the job site or have readily available for review, a copy of submittals and contract documents, marked up to indicate all changes made during the course of a project.
- B. At the completion of the project, the Engineer is required to certify all as-built Drawings. The Engineer is responsible for drafting as-built changes to the Contract Drawings and for final submittal of CADD files to the Owner. The Contractor shall maintain as-built drawings throughout the project in a neat and orderly manner.
- C. Contractor shall keep and maintain and submit to the Owner/Engineer all required as-built drawings and specs, construction photographs, survey control, final survey, warranties/bonds, schedules, shop drawings and other submittals, testing results, and all else specified herein. Items submitted for the record or for approval throughout the duration of the project do not need to be resubmitted at the conclusion of the project.

1.02 RELATED REQUIREMENTS

- A. Section 01050 – Project Control.
- B. Section 01300 – Submittals.
- C. Section 01310 - Construction schedules.
- D. Section 01320 - Construction photographs.
- E. Section 01735 - Warranties and bonds.
- F. Section 01740 - Contract close-out.

1.03 REQUIREMENTS INCLUDED

- A. Contractor shall maintain a record copy of the following documents, marked up to indicate all changes made during the course of a project:
 - 1. Contract Drawings - A full set of plans regularly “red lined”, or other approach as mutually agreed to with the Engineer, with as-built drawing data. Plans should reflect up to date construction that parallels current Application for Payment quantities.
 - 2. Specifications - A full set of specifications regularly “red lined”, or other approach as mutually agreed to with the Engineer, with record data reflecting any approved deviations.

- B. If not previously submitted during construction, the Contractor shall assemble copies of the following documents, as appropriate, for turnover to the Owner/Engineer at the end of the project:
1. All Field Orders, Change Orders, Design Modifications, and RFIs
 2. All Field Test records
 3. All Permits and permit close-outs (final approvals)
 4. Certificate of Occupancy, Permit to Operate, or Certificate of Completion, as applicable
 5. All Laboratory test reports (e.g., bacteriological and primary & secondary water quality)
 6. Certificates of Compliance for materials and equipment
 7. All Record Shop Drawings
 8. All Final Submittal logs
 9. Final change order and potential change order logs.
 10. Construction photographs
 11. Final Survey and Control
 12. All Samples
 13. All required Warranties/ Bonds
- C. As-built Drawings
1. The Contractor shall annotate (mark-up) the Contract Drawings to indicate all project conditions, locations, configurations, and any other changes or deviations that vary from the original Contract Drawings. This requirement includes, but is not limited to, buried or concealed construction, such as the exact location of all horizontal and vertical bends, valves, tees and other fittings installed during the course of construction – whether or not they were indicated on the Contract Drawings. The record information added to the drawings may be supplemented by detailed sketches, if necessary, clearly indicating, the WORK, as constructed.
 2. These annotated Contract Drawings constitute the Contractor's As-built Drawings and are actual representations of as-built conditions, including all revisions made necessary by change orders, design modifications, requests for information and field orders.
 3. The annotated Contract Drawings shall include at least three actual dimensions from permanent markers, accurately locating all underground piping, bends, fittings, valves, structures, or appurtenances.
 4. Legibly mark drawings with as-built information including elevations and dimensions of structures and structural elements, all underground utilities (piping and electrical),

horizontal and vertical locations of underground piping and fittings and appurtenances, installed pipe material, class, size, joint type, etc.

5. As-built drawings shall be accessible to the Owner/Engineer at all times during the construction period.

PART 2 – PRODUCTS (NOT USED)

PART 3 – EXECUTION

3.01 MAINTENANCE OF RECORD DOCUMENTS AND SAMPLES

- A. Maintain documents in a clean, dry, legible, condition and in good order. Do not use record documents for construction purposes.
- B. Label each document "PROJECT RECORD" in neat large-printed letters.
- C. Record information contemporaneously with construction progress and payment applications.

3.02 SUBMITTAL COMPLETION

- A. Upon substantial completion of the Work and prior to final acceptance, the Contractor shall finalize and deliver two complete sets of As-built Drawings to the Engineer conforming to the construction records of the Contractor. The set of drawings shall consist of corrected and annotated drawings showing the recorded location(s) of the work.
- B. The information submitted by the Contractor into the As-built Drawings and Record Documents will be assumed to be correct, and the Contractor shall be responsible for the accuracy of such information and shall bear the costs resulting from the correction of incorrect data, or obtaining missing data.
- C. Delivery and Approval of As-built Drawings and Record Documents to the Owner will be a prerequisite to Final payment.

END OF SECTION

THIS PAGE INTENTIONALLY LEFT BLANK

SECTION 01735
WARRANTIES AND BONDS

PART 1 GENERAL

1.01 SCOPE OF WORK

- A. This Section specifies general administrative and procedural requirements for warranties and bonds required by the Contract Documents, including manufacturer's standard warranties on products and special warranties.

1.02 RELATED WORK

- A. Refer to Conditions of Contract for the general requirements relating to warranties and bonds.
- B. Section 01740 – Contract Closeout.
- C. Specific requirements for warranties for the work, products and installations are specified in the individual Technical Sections.

1.03 SUBMITTALS

- A. Submit written warranties to the Owner prior to Final Payment. If the Certificate of Final Payment designates a commencement date for warranties other than the date of Final Payment for the work, or a designated portion of the work, submit written warranties upon request of the Owner.
- B. When a designated portion of the work is completed and occupied or used by the Owner, by separate agreement with the Contractor during the construction period, submit properly executed warranties to the Owner within [15] days of completion of that designated portion of the Work.
- C. When a special warranty is required to be executed by the Contractor, or the Contractor and a subcontractor, supplier or manufacturer, prepare a written document that contains appropriate terms and identification, ready for execution by the required parties. Submit a draft to the Owner for approval prior to final execution.
- D. Refer to individual Sections for specific content requirements, and particular requirements for submittal of special warranties.
- E. When operating and maintenance manuals are required for warranted construction, provide additional copies of each required warranty, as necessary, for inclusion in each required manual.
- F. The Engineer shall provide a list of all required Warranties to the Contractor at the time of the Pre-Construction Conference. The Contractor shall verify that all warranties on that list have been submitted to the Owner prior to Final Payment. The Contractor is required to submit all warranties requested in the Contract Documents, whether or not the Engineer has included the warranty on the list.

1.04 WARRANTY REQUIREMENT

- A. Related Damages and Losses: When correcting warranted work that has failed, remove and replace other work that has been damaged as a result of such failure or that must be removed and replaced to provide access for correction of warranted work.
- B. Reinstatement of Warranty: When work covered by a warranty has failed and been corrected by replacement or rebuilding, reinstate the warranty by written endorsement. If a piece of equipment or work is replaced, rebuilt, or repaired, then the warranty shall restart at the full term.
- C. Replacement Cost: Upon determination that work covered by a warranty has failed, replace or rebuild the work to an acceptable condition complying with requirements of Contract Documents. The Contractor is responsible for the cost of replacing or rebuilding defective work and/or materials regardless of whether the Owner has benefited from use of the work through a portion of its anticipated useful service life.
- D. Owner's Recourse: Written warranties made to the Owner are in addition to implied warranties, and shall not limit the duties, obligations, rights and remedies otherwise available under the law, nor shall warranty periods be interpreted as limitations on time in which the Owner can enforce such other duties, obligations, rights, or remedies.
- E. Rejection of Warranties: The Owner reserves the right to reject warranties and to limit selections to products with warranties not in conformance with requirements of the Contract Documents.
- F. For a period of at least two years after the date of Final Payment, as specified in Section 00700, the contractor warrants the fitness and soundness of all work done and materials and equipment put in place under the contract. Neither the certificate of Substantial Completion, certificate of final acceptance, payment of the final application for payment, nor any provision in the Contract Documents, not partial or entire occupancy of the premises by the Owner shall constitute an acceptance of work not done in accordance with the Contract Documents, nor relieve the Contractor of liability in respect to any express warranties or responsibility for faulty materials or workmanship.
- G. The Contractor shall remedy any defects in the work and pay for any damage to work resulting therefrom, which shall appear within a period of two years from the date of Final Payment of the work ***unless a longer period is specified, as specified in Section 00700***. The Owner will give notice of observed defects with reasonable promptness.
- H. The two-year warranty described herein shall be in addition to all other warranties required in the Contract Documents. The two-year warranty extended herein shall not limit, alter or prejudice any other right or remedy available to the Owner under the Contract Documents or granted by law. All of the Owner's rights under this two-year warranty are cumulative, and in addition to, all other rights and remedies under the contract.
- I. The Contractor shall bear the cost of correcting destroyed or damaged construction, whether completed or partially completed, of Work which is not in accordance with the requirements of the Contract Documents. If the Contractor fails to correct nonconforming Work within a reasonable time, as determined by the Owner, during that period after receipt of notice from the

Owner, the Owner may correct it and charge the Contractor all costs related to correcting the Work.

- J. The two-year period for correction of Work shall be extended with respect to portions of Work first performed after Final Payment by the period of time between Final Payment and the actual performance of the Work.
- K. The Contractor shall remove from the site portions of the Work which are not in accordance with the requirements of the Contract Documents and are neither corrected by the Contractor nor accepted by the Owner.
- L. Establishment of the two-year period for correction of Work relates only to the specific obligation of the Contractor to correct the Work and has no relationship to the time within which the obligation to comply with the Contract Documents may be sought to be enforced, nor to the time within which proceedings may be commenced to establish the Contractor's liability with respect to the Contractor's obligations other than specifically to correct the Work.

1.05 MANUFACTURERS CERTIFICATIONS

- A. Where required, the Contractor shall supply evidence, satisfactory to the Owner/Engineer, that the Contractor can obtain manufacturers' certifications as to the Contractor's installation of equipment.

1.06 DEFINITIONS

- A. Standard Product Warranties are preprinted written warranties published by individual manufacturers for particular products and are specifically endorsed by the manufacturer to the Owner.
- B. Special Warranties are written warranties required by or incorporated in the Contract Documents, either to extend time limits provided by standard warranties or to provide greater rights for the Owner.

PART 2 PRODUCTS (NOT USED)

PART 3 EXECUTION (NOT USED)

END OF SECTION

THIS PAGE INTENTIONALLY LEFT BLANK

SECTION 01740
CONTRACT CLOSEOUT

PART 1 GENERAL

1.01 SCOPE OF WORK

- A. This Section specifies administrative, verification and procedural requirements for project closeout, including but not limited to:
 - 1. Operation & Maintenance data and Manuals, instrumentation, and control adjustments in Section 01730 and in the respective technical specifications.
 - 2. Project Record Documents in Section 01720.
 - 3. Spare parts and maintenance materials (spare paint, lubricants, special tools) in the respective technical specifications.
 - 4. Record Shop Drawings in Section 01300.
 - 5. Warranties, guarantees, and bonds in Section 01735 and applicable technical specifications.
 - 6. Reconciliation of final accounting, final change order, final payment application in Sections 00700, 01026, and 01035.
 - 7. Construction schedule in Section 01310.
 - 8. Training Confirmation as stated in the technical specifications.
 - 9. Permit close-outs including Certificate of Occupancy or Certificate of Completion.
- B. There shall be no specific Payment for Contract Closeout, the associated costs shall be included in the Miscellaneous Work – Mobilization/Demobilization Bid Item.

1.02 CLOSEOUT PROCEDURES

- A. Provide all final deliverables and project obligations as defined in the contract documents, prior to submitting the final application for payment.
- B. Verify that the Contractors Shop Drawing log, testing log (field tests, shop tests, and performance tests), warranties list, and material samples list is consistent with that of the Owner/Engineer.
- C. Provide submittals to Owner/Engineer that are required by governing or other authorities having applicable jurisdiction including but not limited to permit close out information, certificates of occupancy, etc.
- D. Submit Certificate of Occupancy to the Owner, if applicable to the project.

- E. Submit Application for Final Payment identifying total adjusted Contract Sum, previous payments and sum remaining due, following submittal and approval of Record Documents and As-Built Drawings.
- F. Submit Contractor's Final Release and Release of Liens with final payment application.

1.03 FINAL CLEANING

- A. Contractor to complete final cleaning prior to submittal of the final application for payment. Conduct cleaning and waste-removal operations to comply with local laws and ordinances and Federal and local environmental and antipollution regulations.
- B. Remove from the project site all temporary construction facilities (those used for both the Contractor and Owner/Engineer) as specified in Section 01500. Remove tools, construction equipment, machinery, and surplus material from Project site.
- C. Comply with safety standards for cleaning. Do not burn waste materials. Do not bury debris or excess materials on Owner's property. Do not discharge volatile, harmful, or dangerous materials into drainage systems. Remove waste materials from Project site and dispose of lawfully.
- D. Provide final cleaning by a professional service company if project is located in a building or facility. Clean each surface or unit to condition expected in an average commercial building cleaning and maintenance program. Comply with manufacturers written instructions. Use cleaning materials and agents recommended by manufacturer or fabricator of the surface to be cleaned. Do not use cleaning agents that are potentially hazardous to health or property or that might damage finished surfaces. Complete the following cleaning operations for all buildings or facilities worked on as part of the Project before requesting inspection for certification of Substantial Completion for entire Project or for a portion of the Project:
 - 1. Clean exposed exterior and interior hard-surfaced finishes to a dirt-free condition, free of stains, films, and similar foreign substances. Avoid disturbing natural weathering of exterior surfaces. Restore reflective surfaces to their original condition.
 - 2. Remove debris and surface dust from limited access spaces, including roofs, plenums, shafts, trenches, equipment, vaults, manholes, attics, and similar spaces.
 - 3. Sweep concrete floors, broom clean in unoccupied spaces.
 - 4. Vacuum carpet and similar soft surfaces, removing debris and excess nap; shampoo if visible soil or stains remain.
 - 5. Clean transparent materials, including mirrors and glass in doors and windows. Remove glazing compounds and other noticeable, vision-obscuring materials. Replace chipped or broken glass and other damaged transparent materials. Polish mirrors and glass, taking care not to scratch surfaces.
 - 6. Remove labels that are not permanent.
 - 7. Touch up and otherwise repair and restore marred, exposed finishes and surfaces. Replace finishes and surfaces that cannot be satisfactorily repaired or restored or that already show

evidence of repair or restoration. Remove any rust from areas. Do not paint over “UL” and similar labels, including mechanical and electrical nameplates.

8. Wipe surfaces of mechanical and electrical equipment, elevator equipment, and similar equipment.
 9. Remove excess lubrication, paint and mortar droppings, and other foreign substances.
 10. Replace parts that were subject to unusual operating conditions.
 11. Clean plumbing fixtures to a sanitary condition, free of stains, including stains resulting from water exposure.
 12. Replace disposable air filters and clean permanent air filters. Clean exposed surfaces of diffusers, registers, and grills. Clean ducts, blowers, and coils if units were operated without filters during construction.
 13. Clean light fixtures, lamps, globes, and reflectors to function with full efficiency. Replace burned-out bulbs, and those noticeably dimmed by hours of use, and defective and noisy starters in fluorescent and mercury vapor fixtures to comply with requirements for new fixtures.
 14. Leave Project clean and ready for occupancy.
- E. For pipeline projects, clean Project site, yard, streets, parking areas, easement areas, grounds, landscaped areas, and all other areas disturbed by construction activities. Remove rubbish, waste material, litter, and other foreign substances.
1. Sweep paved areas broom clean. Remove petrochemical spills, stains, and other foreign deposits.
 2. Rake grounds that are neither planted nor paved to a smooth even textured surface.

PART 2 PRODUCTS (NOT USED)

PART 3 EXECUTION (NOT USED)

END OF SECTION

THIS PAGE INTENTIONALLY LEFT BLANK

DIVISION 2

PAGE INTENTIONALLY LEFT BLANK

SECTION 02210
WORK IN SOUTH CAROLINA DEPARTMENT OF TRANSPORTATION
RIGHTS-OF-WAY

PART 1 - GENERAL

1.1 SCOPE

- A. All work within the rights-of-way of the South Carolina Department of Transportation (DOT) shall be done in accordance with the contract documents and the DOT's requirements. Upon completion of such work and prior to final payment, the Contractor shall present to the Owner certificates in duplicate from the DOT stating that the work has been done in accordance with the DOT's requirements and is acceptable to them. Construction signing and traffic control shall conform to the "Manual on Uniform Traffic Control Devices" (MUTCD) latest revision, as published by the State of South Carolina Department of Transportation, Division of Highways.
- B. Contractor shall meet all requirements of the SCDOT Encroachment Agreement Special Conditions.
- C. All construction shall be in conformance with the current edition of the South Carolina Department of Transportation Standard Specifications for Highway Construction, unless otherwise specified herein.

1.2 RELATED SECTIONS

- A. Section 01570 – Maintenance and Protection of Traffic
- B. Section 02221 - Trench Excavation, Bedding, and Backfill
- C. Section 02250 – Sheeting and Bracing
- D. Section 02730 – Sanitary Sewer Systems

PART 2 - PRODUCTS

- 2.1 Flowable fill is controlled low strength material (CLSM) used as backfill material in SCDOT roadways. Flowable fill used for this purpose shall conform to Section 210 of the South

Carolina Department of Transportation Standard Specifications for Highway Construction.

PART 3 - EXECUTION

3.1 SAFETY

- A. Barricades, signs, lights, pilot cars, flagmen, and watchmen with reflective vests shall be used where required by the Division Engineer or his representatives. All operations in the DOT's rights-of-way shall be conducted at all times in such a manner so as not to create a hazard to or impede the flow of traffic. All costs for these items shall be included in the base bid.
- B. The Contractor shall provide, erect and maintain all necessary barricades, lights, danger signals, signs and other control devices, provide qualified flaggers and watchmen where necessary; shall take all necessary precautions for the protection of the work, the warning that work is under construction, and the safety of the public. Suitable advance warning signs shall be erected in advance where operations interfere with the use of the road by traffic. Lane closures (or partial closures) will not be permitted unless provided for in the permit. Where a lane (or a portion of a lane) is closed, traffic control devices and flaggers shall be used in accordance with the MUTCD. All barricades, signs and traffic control devices shall conform to the requirements of the MUTCD.
- C. Traffic will be maintained at all times and lane closures will only be permitted after a traffic control plan is approved. Driveways will be maintained so as to permit ingress and egress to properties adjacent to the roadway. Blocking or closing of a driveway will not be permitted without the approval of the property owner.
- D. When equipment is not in use on urban roadways with limited right-of-way and on rural roadways, store material and equipment not closer than 15 feet from the near edge of the adjacent travel lane when space is available. Whenever space is limited and the 15-foot clear distance is not available, store material and equipment at the greatest possible distance from the near edge of the travel lane and supplement the complete length of the storage area with portable plastic drums spaced at 5-foot intervals.
- E. Manholes shall not be located in the wheel path of a vehicle. Where the County/SCDOT requirements differ on manhole location, the County/SCDOT specifications shall prevail.
- F. All contractors, sub-contractors, utility company employees and their sub-contractors performing work on the right-of-way must wear safety vest and hardhats as outlined in the Manual on Uniform Traffic Control Devices for Streets and Highways (MUTCD).

3.2 EXCAVATION AND BACKFILLING IN SCDOT RIGHT-OF-WAY

- A. No pipeline, including service connections, shall be installed in open trench unless actually shown on plans as open cut. All service connections shall be bored, driven, or punched under roadways maintained by the DOT. If open cutting is allowed, backfilling of trenches is to be accomplished immediately after placement of the pipe. Trenches will not be left open during hours of darkness.
- B. The top of the pipeline or casing shall be installed at a minimum depth of forty-eight (48) inches from grade for longitudinal installations located between the ditch line and the right-of-way line. The top of the pipeline or casing shall be installed at a minimum depth of forty-eight (48) inches from the top of asphalt.

- C. Excavation for the roadways, drives, and parking areas shall conform to the lines, grades, cross sections, and dimensions indicated on the drawings and shall include the excavation of all unsuitable material from the subgrade. After shaping to line, grade, and cross section, the subgrade shall be placed and compacted in six (6) inch layers or less with each layer being thoroughly compacted to a density of 95% standard proctor as determined by AASHTO T-99. This operation shall include any reshaping and wetting or drying required to obtain proper compaction. All soft or otherwise unsuitable material shall be removed and replaced with suitable material. Compaction tests shall be taken per associated SCDOT permit.
- D. Soil unsuitable for backfill shall be replaced with crusher run.
- E. All open trenches shall be covered or backfilled with compacted backfill at the end of each day. Trenches will not be left open during hours of darkness.
- F. Where it is necessary to cut existing pavement in roads, the road shall be repaired with a surface of the same type as the existing unless specified otherwise. All replaced surfacing shall meet the requirements of the DOT both as to material and performance of work. If mutually satisfactory arrangements can be made with the Division Engineer through whose division the pipeline passes, pavement may be restored by the DOT's maintenance forces with the Contractor assuming the cost of replacement.
- G. Where the County or SCDOT require additional measures or more stringent requirements, those requirements shall be implemented.

3.3 INSPECTIONS

- A. Before any crossing of a highway is made, written notice shall be given to the DOT's Division Engineer, 48 hours in advance so that a DOT Inspector may be assigned to the work at the Division Engineer's option. Any inspector assigned to the pipe laying operations shall have full authority to act in behalf of the DOT and to stop any work affecting highways, provided the work is not being performed in accordance with DOT's requirements.

3.4 MAINTENANCE

- A. Pavement shall be kept clear of mud and debris.
- B. All work done in DOT's right-of-way shall be maintained by the Contractor for a period of one year (minimum) after completion of the contract. The DOT shall request the Contractor to make any repairs to work not satisfactorily maintained, and if not brought up to the DOT's standard may be repaired by the DOT's forces and all cost of repairs shall be charged to the Contractor.

END OF SECTION

THIS PAGE INTENTIONALLY LEFT BLANK

SECTION 02221
TRENCH EXCAVATION, BEDDING AND BACKFILL

PART 1 - GENERAL

1.1 SCOPE

- A. The work required under this section shall consist of furnishing all labor, equipment and materials required for earthwork operations conducted for trenching for all piping and appurtenances, including bedding and backfill operations, drainage, disposal of surplus materials and restoration of trench surfaces and easements necessary for a complete installation as shown on the Drawings.
- B. Excavation shall be classified as "common excavation" or "rock excavation" as defined herein. Excavation of every description, regardless of material encountered within the grading limits of the project shall be performed to the lines and grades indicated. Excavation and backfilling shall be performed in a manner and sequence that will provide drainage at all times. Grading shall be done as may be necessary to prevent surface water from flowing into trenches or other excavations; any water accumulating therein shall be removed by pumping or by other approved methods. Sheeting and shoring shall be erected as required for the protection of the work and for the safety of personnel.

1.2 RELATED WORK

- A. Section 01046 Control of Work
- B. Section 02011 Test Pits
- C. Section 02100 Clearing and Grubbing
- D. Section 02222 Rock and Boulder Excavation
- E. Section 02230 Granular Fill Materials
- F. Section 02240 Dewatering and Drainage
- G. Section 02250 Sheeting and Bracing
- H. Section 02270 Sedimentation and Erosion Control
- I. Section 02730 Sanitary Sewer Systems

1.3 JOB CONDITIONS

- A. Existing utilities:
 - 1. Approximate location of certain underground lines and structures are shown on the plans for information only, other underground lines or structures may not be shown.

2. Locate these and other possible unknown utility lines using electronic pipe finder, or other approved means.
3. Locate, excavate and expose all existing underground lines in advance of trenching operations.
4. The Contractor will be held responsible for the workmanlike repair of any damage, at no cost to the Owner, done to any of these utilities in the execution of his work under this Section.
5. The Contractor shall familiarize himself with the existing conditions and be prepared to adequately care for and safeguard himself and the Owner from damage.
6. All Work shall be completed in accordance with the provisions of Section 01046.

B. Notification of intent to excavate:

1. South Carolina Underground Utility Damage Prevention Act (S.C. Code Ann, 58-35-10, CT-SEQ, Supp. 1978) requires persons to ascertain the location of underground public utility property prior to excavation or demolition in certain situations. The Act also requires such persons to give timely notice of intent to excavate or demolish prior to commencing such operations. Failure to comply could subject the violator to a civil penalty of up to one thousand dollars (\$1,000) for each violation of the Act.
2. Notification of intent to excavate may be given by calling this toll-free number: 888-721-7877.

C. Protecting trees, shrubbery, and lawns:

1. Trees and shrubbery in developed areas and along the trench line shall not be disturbed unless absolutely necessary, and subject to the approval of the Owner/Engineer and in accordance with Section 01046. Any such trees and shrubbery necessary to be removed shall be heeled in and replanted.

D. Clearing:

1. Perform all clearing necessary for installation of the complete work in accordance with Section 02100.
2. Clearing shall consist of removing all trees, stumps, roots, brush and debris in the rights-of-way obtained for the Work.
3. All timber of merchantable size shall remain the property of the Owner and shall be trimmed and cut in such lengths as directed and stacked along the edge of the right-of-way.
4. All other material, including trimmings from above, shall be completely disposed of in a satisfactory manner.

E. Removing and resetting fences:

1. Where existing fences must be removed to permit construction of utilities, remove such fences and reset the fences in their original location and condition in accordance with the property owner and as the Work progresses.
2. Provide temporary fencing or other safeguards as required to prevent stock and cattle from wandering to other lands.

F. Restoration of disturbed areas:

1. Restore all areas disturbed by construction activities to their existing or better condition. For existing areas with sod type grasses, replace with new sod. Existing sod may be reused where properly removed and stored and as approved by the Owner/Engineer.

1.4 MANHOLE EXCAVATION

- A. Excavation for manholes and similar appurtenances shall extend a sufficient distance from walls and footings to allow for placing and removal of forms, installation of services and for inspection. An over depth excavation below such appurtenances, which has not been directed by the Engineer, will be considered unauthorized and shall be refilled with sand, gravel, or concrete, as directed by the Engineer at no cost to the Owner.

1.5 PIPELINES

- A. The width of the trench 18-inches above the top of the pipe shall be wide as necessary for sheeting and bracing and the proper performance of the work.

1.6 REFERENCE STANDARDS

- A. ASTM D698 – Standard Test Methods for Laboratory Compaction Characteristics of Soil Using Standard Effort
- B. ASTM D2321 – Underground Installation of Thermoplastic Pipe for Sewers and Other Gravity Flow Applications.
- C. ASTM D2487 – Standard Practice for Classification of Soils for Engineering Purposes (Unified Soil Classification System).

PART 2 - PRODUCTS

2.1 BEDDING MATERIALS

- A. Materials for pipe bedding shall be washed stone (No. 57 in accordance with the SCDOT Standard Specifications for Highway Construction).

2.2 BACKFILL MATERIAL

- A. General backfill material for the lower portion of the trench above the bedding material and around manholes shall consist of fine, loose earth, free of large clods, stones, vegetable matter, debris, and/or other objectionable material. It shall have a moisture content suitable for compaction.

2.3 STABILIZATION STONE

- A. Stabilization stone shall be the same as bedding materials.

2.4 SELECT BACKFILL

- A. Select backfill material shall be well graded soil obtained from on site or off-site locations. Material shall be free from roots and vegetative matter, debris, stones larger than 1-1/2", and organic matter including soils OL, OH and PT as defined in the Unified Soil Classification System and referenced in ASTM D2487.

PART 3 - EXECUTION

3.1 TEST PITS

- A. Excavation of test pits may be required for the purpose of locating underground utilities or structures as an aid in establishing the precise location of new work.
- B. Test pits shall be backfilled as soon as the desired information has been obtained. The backfilled surface shall be maintained in a satisfactory condition for travel until resurfaced as specified.

3.2 TRENCH EXCAVATION

- A. Trenches shall be excavated by an approved method to a depth to permit installation of pipe along the lines and grades shown on the Drawings.
- B. Where excavation is in rock, the rock shall be removed to a depth below grade of at least 12 inches. Before laying the pipe, the trench shall be refilled to grade with approved gravel, firmly compacted to provide proper bedding for the pipe. Bell holes shall be excavated accurately to size.
- C. If ground water is encountered in the bottom of the trench, material shall be excavated below subgrade sufficiently to allow a bed of suitable material to be placed in which to bed pipe. Depth of cut below subgrade shall be the minimum amount to accomplish the purpose and shall be as directed by the Engineer.

3.3 ROCK EXCAVATION

- A. The Contractor shall notify the Engineer immediately if "rock excavation" is encountered. "Rock excavation" shall be material which, in the opinion of the Engineer, cannot be removed by conventional mechanical excavation equipment and requires continuous, systematic drilling, blasting, wedging, sledging, cutting, barring, jack hammering, hoe ramming or expansive chemical splitting.
- B. "Common excavation" shall include all types of materials that do not fall into the category of "rock excavation" as defined above. Classification of excavation shall be determined by the Engineer.
- C. Rock excavation in pipe trenches shall be removed to a width specified in Section 01025, and 6-inches below the outside bottom of the pipe.

- D. Rock excavation for manholes shall be removed 12" beyond the outside wall. Rock shall be excavated to 6-inches below the base of the manhole and backfilled to subgrade with crushed stone.

3.4 BLASTING

- A. If conditions are such that blasting or any use of explosives is required, the Contractor, prior to blasting, shall submit to the Engineer satisfactory evidence of blasting and explosive insurance. Insurance shall be in the amounts of bodily injury and property damage specified in the Supplemental Conditions. Contractor shall provide to the satisfaction of the Engineer, experience and capability of the Contractor's organization to safely handle and perform such operations.
- B. The Contractor shall maintain the blasting insurance coverage for the duration of the blasting. The Engineer shall be given 5-days written notice of cancellation of the blasting insurance.
- C. Handling and storing of blasting materials shall be performed only by qualified persons skilled in such work. Adequate precautions shall be taken to prevent accidents, injury to persons, or damage to property. Qualifications of blasting operation personnel and safety precautions shall be in full compliance with all codes governing such operations, Local, State or Federal. Full responsibility for all blasting operations shall remain with the Contractor.
- D. Where in close proximity to building, transmission lines, telephone lines or other facilities, timber mats or other means of preventing damage from flying debris shall be used. Ample and suitable signals shall be given in proximity to the work before each blast, and flagmen shall be placed on all roads beyond the danger zone in every direction to warn traffic. Contractor shall be responsible for all damage resulting from blasting.
- E. The Contractor shall maintain drilling and blasting log, in the permanent job file, of all blasting operations performed on the project. The format may vary, but the logs should contain all the information shown on the Typical Blasting Log at the end of this section.

3.5 GEOTEXTILES

- A. Subsurface Drainage Geotextile: Nonwoven needle-punched geotextile, manufactured for subsurface drainage applications, made from polyolefins or polyesters; with elongation greater than 50 percent; complying with AASHTO M 288 and the following, measured per test methods referenced:
 - 1. Survivability: Class 3; AASHTO M 288.
 - 2. Survivability: As follows:
 - a. Grab Tensile Strength: 120 lbf (534 N); ASTM D 4632/ D 4632M.
 - b. Tear Strength: 50 lbf (223 N); ASTM D 4533/D 4533 M.
 - c. Puncture Strength: 310 lbf 1 N); ASTM D 6241.
 - 3. Apparent Opening Size: No. 70 (0.212-mm) sieve, maximum; ASTM D 4751.
 - 4. Permittivity: 0.1 per second, minimum; ASTM D 4751.
 - 5. UV Stability: 70 percent after 500 hours' exposure; ASTM D 4355/D 4355M.

- B. Product: Provide “Mirafi 140N,” by TenCate Geosynthetics – Nicolon Corporation, or equal.

3.6 BEDDING

- A. General. The bedding surface for the pipe shall provide a firm foundation of uniform density throughout the entire length of the pipe. If soft, mucky, or otherwise unstable or unsuitable materials are encountered in the trench bottom, it shall be removed and replaced with stabilization stone as directed by the Engineer.
- B. Joints. Bell holes and depressions for joints shall be shaped in order that the pipe or conduit rest on the prepared bottom for its full length, bell holes and depressions shall be only of such length, depth and width as required for making the particular type of joint. Blocking under pipe or conduit will not be allowed.
- C. Manholes. Manholes shall have a minimum bedding of 12 inches of compacted angular bedding material placed on a stable subgrade to prevent settlement and misalignment.

3.7 BRACING AND SHEETING

- A. The side of all trenches and excavations shall be adequately braced and sheeted to protect personnel, structures and property from slides, cave-ins, or settlement and to maintain the work clear of all obstructions. Bracing, shoring and sheeting shall comply with all applicable safety regulations governing the work. Full responsibility for the design, type, and strength of shoring, sheeting and bracing shall rest with the Contractor.

3.8 PUMPING

- A. The Contractor shall do all pumping necessary for dewatering trenches and to provide proper work conditions for installation of pipe and appurtenances. Pipe shall be installed on dry, stable trench bottoms.

3.9 TRENCH EARTH DAMS

- A. Earth dams, consisting of a minimum ten (10) foot trench length of select compacted backfill to replace the angular bedding, shall be installed as directed by the Engineer in wet areas to prevent groundwater movement in bedding material.

3.10 BACKFILLING

- A. Immediately after the pipe has been laid the trench shall be backfilled around the barrel of the pipe with the required bedding or backfill material. Backfill materials shall be deposited in layers not to exceed 6-inches in thickness tamped or rammed around the pipe with approved hand or power-driven tools until enough material has been placed and compacted to provide a cover of not less than 18-inches over the top of the pipe. Care shall be exercised to avoid any wedging action or eccentric action upon or against any pipe or structure and to avoid any disturbance or damage to the work.

- B. No rock or boulders shall be used in the backfill for at least 18 inches above the top of the pipe and no stone larger than 6-inches in its greatest dimension shall be used in any backfilling.
- C. Along the pipelines in areas not subject to superimposed loads, trench backfill may be placed from the level 18-inches above the top of the pipe upward in 12-inch layers and compacted lightly by rolling with wheeled equipment or other means. Care shall be taken to prevent damage to the pipe. Such backfill may be coarser than specified above, but shall be free of roots, brush, trash, other perishable matter and organic material, and no stone larger than 6 inches in any dimension. In open acreage areas, backfill shall be neatly rounded and dressed over with sufficient height to allow for settlement to existing surface. The overfill shall not impede existing surface drainage. In built-up areas, the top of backfill shall be maintained to the original surface.
- D. In roads and road right-of-ways, parking lots, across sidewalks and driveways and at other places subject to vehicular traffic or other superimposed loads, trench backfill material as specified above shall be compacted in 6-inch layers for the full depth of the trench and consolidated in such a manner to provide an unyielding foundation for vehicular traffic. Unless otherwise shown on the plans or required by governing authorities, the compaction density shall be equal to the density of the original adjacent material. However, the minimum compaction density shall be 95% of maximum density as specified by ASTM D698 or AASHTO T 99 (Standard Proctor) Method A, at optimum moisture content. Wet or dry backfill as necessary.
- E. In all paved areas the Contractor shall provide crushed stone for the top 4" of the trench backfill as a temporary patch. The crushed stone shall be maintained flush with existing pavement until the temporary patch is removed and replaced with the required base course. The Contractor shall be responsible for maintaining the pavement cut in a safe condition for pedestrian and vehicular traffic.
- F. Backfill adjacent to manholes shall be placed and compacted uniformly in such a manner as to prevent wedging action or eccentric loading upon or against the structure. Slopes bounding or within the areas to be backfilled shall be stepped or serrated to prevent sliding of the fill. During backfilling operations, equipment that will overload the structure in passing over and compacting these fills shall not be used.
- G. Any deficiency in the quantity or quality of material for backfilling the trenches, or for repairing depressions caused by settlement, shall be supplied by the Contractor at his expense from an approved borrow site or the Contractor may use crusher run stone at his option without additional cost to the Owner.
- H. In paved areas or areas subject to vehicular traffic where the Engineer determines soil conditions adjacent to the trench prohibit adequate compaction of soil backfill, crusher run stone shall be required for backfill.
- I. No more than 350 feet of trench shall be open at any given time.
- J. All road surfaces shall be broomed and hose-cleaned immediately after backfilling. Dust control measures shall be employed at all times.

3.11 EXCAVATION BELOW GRADE AND REFILL

- A. Whatever the nature of unstable material encountered or the groundwater conditions, trench drainage shall be complete and effective.
- B. If the Contractor excavates below grade through error or for the Contractor's own convenience, or through failure to properly dewater the trench, or disturbs the subgrade before dewatering is sufficiently complete, he may be directed by the Owner/Engineer to excavate below grade as set forth in the following paragraph, in which case the work of excavating below grade and furnishing and placing the refill shall be performed at his own expense.
- C. If the material at the level of trench bottom consists of fine sand, sand and silt or soft earth which may work into the screened gravel notwithstanding effective drainage, the subgrade material shall be removed to the extent directed and the excavation refilled with a 6-in layer of SCDOT #57 stone, as approved by the Owner/Engineer. The composition and gradation of gravel shall be approved by the Owner/Engineer prior to placement. Gravel shall then be placed in 6-in layers thoroughly compacted up to the normal grade of the pipe.
 - 1. Payment for excavation below grade and refill shall be at the unit price bid in the Schedule of Prices for the Over Excavation of Unsuitable Soils and Refill bid Item. Payment shall only be made for removal and replacement of existing unsuitable soils. No payment will be made for removal and replacement of unsuitable soils resulting from improper excavation, improper dewatering or accidental overexcavation by the Contractor.
- D. Geotextile non-woven filter fabric may be substituted for filter layer if approved by the Engineer.

3.12 DISPOSAL OF MATERIALS

- A. Excavated material shall be stacked without excessive surcharge on the trench bank or obstructing free access to hydrants and other utilities. Inconvenience to traffic and abutters shall be avoided as much as possible. Excavated material shall be segregated for use in backfilling as specified below.
- B. It is expressly understood that no excavated material shall be removed from the site of the work or disposed of, except as directed by the Owner/Engineer. When removal of surplus materials has been approved by the Owner/Engineer, dispose of such surplus material in approved designated areas.
- C. Should conditions make it impractical or unsafe to stack material adjacent to the trench, the material shall be hauled and stored at a location approved by the Owner/Engineer. When required, it shall be re-handled and used in backfilling the trench.

3.13 TESTING

- A. Field and laboratory tests will be performed as necessary by the soils engineer to ensure compliance of the Contractor's work and materials with the drawings and these specifications. Initial tests will be paid for by the Owner. Should the Contractor's work or materials used fail to meet the specified requirements, the unacceptable areas will be reworked, and unacceptable materials replaced with specified materials at the expense of the Contractor. Subsequent tests

will be made to ensure compliance of replaced materials and reworked areas. In any case, the Owner shall select the Soils Engineer. Owner will back charge the Contractor for all retests.

3.14 RESTORING TRENCH SURFACE

- A. Where the trench occurs adjacent to paved streets, in shoulders, sidewalks, or in cross-country areas, thoroughly consolidate the backfill and shall maintain the surface as the work progresses. If settlement takes place, immediately deposit additional fill to restore the level of the ground.
- B. The surface of any driveway or any other area which is disturbed by the trench excavation and which is not a part of the paved road shall be restored to a condition at least equal to that existing before work began.
- C. In sections where the pipeline passes through grassed areas, and at the Contractor's own expense, remove and replace the sod, or loam and seed the surface to the satisfaction of the Engineer.

END OF SECTION

THIS PAGE INTENTIONALLY LEFT BLANK

SECTION 02230
GRANULAR FILL MATERIALS

PART 1 - GENERAL

1.1 SCOPE OF WORK

- A. Furnish all labor, materials, equipment and incidentals required and obtain materials for filling and backfilling, grading and miscellaneous site work, for the uses shown on the Drawings and as specified herein.

1.2 RELATED WORK

- A. Clearing and Grubbing is included in Section 02100.
- B. Trench Excavation, Bedding and Backfill is included in Section 02221.
- C. Pavement, Markings, And Appurtenances is included in Section 02575.

1.3 SUBMITTALS

- A. Submit, in accordance with Section 01300, complete product data and sieve analysis for all materials specified in this Section.

PART 2 - PRODUCTS

2.1 MATERIALS

- A. Granular materials shall be free of all organic material, trash, snow, ice, frozen soil, or other objectionable materials which may be compressible, or which cannot be properly compacted.
- B. Crushed Stone (commonly known as #57 stone) shall be sound, durable stone, angular in shape, and free of any foreign material, structural defects and chemical decay. Crushed stone shall conform to the following gradation limits:

Sieve Size	Percent Finer By Weight
1 1/2-in	100
1-in	95-100
1/2-in	25-60
No. 4	0-10
No. 8	0-5

- C. Crushed Stone may be substituted with SCDOT 305.2.1 Macadam Base upon the Engineer’s approval. Ensure that aggregate is free from vegetable matter, sand, lumps or balls of clay and other deleterious material. Macadam Base shall conform to the following gradation limits:

Sieve Size	Percent Finer By Weight
2-in	100
1 1/2-in	95-100
1-in	70-100
1/2 -in	48-75
No. 4	30-60
No. 30	11-30
No. 200*	0-12

*AASHTO T-11 is used to determine the amount passing the No. 200 sieve.

- D. Crusher run shall be sound, durable stone, angular in shape, and free of any foreign material, structural defects and chemical decay. Crusher run shall conform to the following gradation limits:

Sieve Size	Percent Finer By Weight
1-in	100
3/4-in	90
1/2-in	60
1/4-in	25

- E. Common fill shall be free of any foreign material, structural defects and chemical decay. Common fill shall also be free from organic material and muck. Material shall be screened mixed in order to distributed any large pieces of clay. Materials shall have a maximum dry density not less than 100 lbs/ft³ at optimum moisture when tested in accordance with SCDOT’s SC-T-29.
- F. Sand shall consist of hard, sharp, angular grains of quartz or other durable rock, free from excessive quantities of clay or other deleterious substances, and containing not more than 10.0% total material passing the No. 200 sieve with a maximum of 6.0% clay. Use sand that is free of clay balls, and if it has any clay contained within it, the clay is uniformly dispersed throughout the material. Excavated, blend, and stockpile the sand so that a uniform product is provided.
- G. Gravel shall be composed of hard durable particles of clean stone, free from an excess of thin or elongated pieces, vegetable matter, or other deleterious substances. Gravel shall conform to the following gradation limits:

Sieve Size	Percent Finer By Weight
2-in	100
1 1/2-in	95-100
1-in	70-100
1/2-in	35 - 65
No. 4	10 - 40

- H. Structural fill shall be sound, durable stone free of any foreign material structural defects and chemical decay. Structural fill shall consist of the following soil types, as defined by AASHTO M 145: Well Graded A-1 soils, Screenings meeting A-1, Macadam Graded aggregate base, Uniformly graded coarse sand A-3 soils (wrapped), Uniformly graded angular stone as large as #5 stone (wrapped).
1. Materials labelled as (wrapped) above require geotextile wrap to control the migration of fines into open voids. In all cases, use a geotextile that prevents the transmission of the smallest soil particles present in both the in-situ soil and the soil used for bedding and structural backfill.
- I. Flowable Fill shall be Excavatable consisting of a mixture of Portland cement, fly ash, fine aggregate, air entraining admixture, and water. Flowable Fill shall meet the requirements of the latest edition of SCDOT SC-M-210.
1. The Contractor shall utilize flowable fill as identified in the Contract Drawings and SCDOT Encroachment Permit.
 2. The materials and equipment used to produce, transport, and place flowable fill shall be in compliance with the requirements set forth by the SCDOT Standard Specifications for Highway Construction, latest edition. Sampling and testing of flowable fill and materials used to produce it may be required at the discretion of the Owner/Engineer at no additional cost.
 3. The Contractor shall be responsible for providing the Owner/Engineer with certification from the supplier that mix design is in accordance with SCDOT Standard Specification for Highway Construction, latest edition, SCDOT SC-M-210. The Contractor shall use all necessary construction techniques to assure that the finished material will perform as intended. Anticipated unconfined compressive strength for the mixtures shall be a minimum of 80 psi at 28 days and 150 psi at 56 days.
 4. Flowable fill will harden sufficiently to allow full traffic within 8 to 20 hours, depending upon placement conditions. If necessary to return traffic in less than 8 hours or if there is concern that traffic flow will cause damage to the fill or any structure below, steel plates shall be used to bridge over the hardening flowable fill as directed by the Owner/Engineer.

PART 3 EXECUTION (NOT USED)

END OF SECTION

THIS PAGE INTENTIONALLY LEFT BLANK

SECTION 02240
DEWATERING AND DRAINAGE

PART 1 - GENERAL

1.1 SCOPE OF WORK

- A. The Work specified in this Section includes Designing, furnishing, installing, operating, monitoring, maintaining and removing temporary dewatering and drainage systems as required to lower and control water levels to at least 2 feet below the lowest level of the excavation to permit construction in the dry. Contractor shall obtain and pay for all permits required for temporary dewatering and drainage systems.
- B. Furnish, maintain and remove temporary surface water control measures adequate to drain and remove surface water entering excavations.
- C. Retain the services of a professional engineer registered in the State of South Carolina to prepare dewatering and drainage system designs and submittals described herein.
- D. Work shall include the design, furnishing equipment and materials, installation, protection, and monitoring of geotechnical instrumentation required to monitor the performance of the dewatering and drainage system as required herein.
- E. Collect and properly dispose of all discharge water from the dewatering and drainage systems in accordance with the provisions of this Section and Section 01046. Under no circumstances shall water from dewatering systems be discharged into the existing or new sanitary sewer systems.
- F. Obtain and pay for all permits required for dewatering and drainage systems.
- G. Repair damage caused by dewatering and drainage system operations.
- H. Basic trench dewatering which does not require a design, permitting, deep wells, well points, or complex pumping is specified in the technical specification and will be paid for under the individual pipe items.

1.2 RELATED WORK

- A. Section 01300 - Submittals
- B. Section 01046 – Control of Work
- C. Section 02100 – Clearing and Grubbing
- D. Section 02221 – Trench Excavation, Bedding and Backfill

1.3 SUBMITTALS

- A. Dewatering and drainage system designs shall be prepared by a licensed professional engineer retained by the Contractor. The Contractor shall submit an original and three copies of the licensed professional engineer's certification on the PE form specified in Section 01300. The Contractor shall also submit qualifications as required herein.
- B. The Contractor shall submit a dewatering and drainage system design plan. The plan shall include a description of the proposed dewatering system and include the proposed installation methods to be used for dewatering and drainage system elements and for observation wells. The plan shall include equipment, drilling methods, holes sizes, filter sand placement techniques, sealing materials, development techniques, the number and location of dewatering points and observations wells, etc. Include the dewatering system design calculations in the plan.
- C. The plan shall identify the anticipated area influenced by the dewatering system and address any impacts to adjacent existing and proposed structures. The submittal shall also include detailed plans for pre-construction surveys of existing structures in the vicinity of the dewatering system, settlement monitoring of existing structures during construction, and provisions to address settlement of existing structures resulting from dewatering activities.
- D. Coordinate dewatering and drainage submittals with the excavation and support submittals. The submittal shall show the areas and depths of excavation to be dewatered.
- E. Do not proceed with any excavation or dewatering activities until the dewatering submittals has been reviewed and approved by the Owner/Engineer.
- F. If visible contaminants, odorous waste or any other potentially hazardous material is encountered during the dewatering process, the Contractor shall stop work and store the contaminated water in approved containers. Contractor shall develop disposal plan, to be approved by the Owner/Engineer before work can proceed. The Contractor shall make every effort to limit the environmental impact of the contaminants.
- G. Preconstruction surveys as specified below.

1.4 QUALITY ASSURANCE

- A. Regulations: Perform all work in accordance with current applicable regulations and codes of all Federal, State and local agencies.
- B. The Contractor shall have at least 5 years of experience with work compatible to the Work shown and specified, employing labor and supervisory personnel who are similarly experienced in this type of Work.
- C. The Contractor's design engineer shall be registered in the State of South Carolina and have a minimum of 5 years of professional experience in the design and construction of dewatering and drainage systems and shall have completed not less than 5 successful dewatering and drainage projects of equal type, size, and complexity to that require for the work.

1.5 DESIGN REQUIREMENTS

- A. The Contractor is responsible for the proper design and implementation of methods for controlling surface water and groundwater.
- B. The primary purpose of the groundwater control system is to preserve the natural undisturbed condition of the subgrade soils in the areas of the proposed excavations. Prior to excavation, the Contractor shall lower the groundwater to at least 2-ft below the lowest excavation subgrade elevation. Additional groundwater lowering may be necessary beyond the 2-ft requirement, depending on construction methods and equipment used and the prevailing groundwater and soil conditions. The Contractor is responsible for lowering the groundwater as necessary to complete construction in accordance with the plans and specifications at no additional cost to the Owner.
- C. Design deep wells, well points and sumps, and all other groundwater control system components to prevent loss of fines from surrounding soils. Sand filters shall be used with all dewatering installations unless screens are properly sized by the Contractor's design engineer to prevent passage of fines from surrounding soils.
- D. Design review and field monitoring activities by the Owner/Engineer shall not relieve the Contractor of his/her responsibilities for the work.
- E. The Contractor shall perform pre-conditions surveys of facilities located within 50ft of the work. Pre-condition survey shall be performed to include detailed documentation of facilities to include, but not limited to, buildings, roadways, utilities, asphalt parking lots and driveways. Surveys shall document interior and exterior cracking, settlement and distresses which exist prior to any construction activities. Pre-condition shall be submitted to Owner/Engineer prior to beginning any construction activity.

1.6 DEFINITIONS

- A. Where the phrase "in-the-dry" is used in this Section, it shall be defined as an excavation subgrade where the groundwater level has been lowered to at least 2-ft below the lowest level of the excavation, is stable with no ponded water, mud, or muck, is able to support construction equipment without rutting or disturbance and is suitable for the placement and compaction of fill material, pipe or concrete foundations.

PART 2 - PRODUCTS

2.1 MATERIALS

- A. Pipe for observation wells shall consist of minimum 1-in I.D, Schedule 40 PVC pipe and machine slotted PVC well points, maximum slot size 0.020-in.
- B. Piping, pumping equipment and all other materials required to provide control of surface water and groundwater in excavations shall be suitable for the intended purpose.
- C. Standby pumping systems and a source of standby power shall be maintained at all sites.

PART 3 - EXECUTION

3.1 GENERAL

- A. Control surface water and groundwater such that excavation to final grade is made in-the-dry, the natural undisturbed condition of the subgrade soils are maintained, and softening and/or instability or disturbance due to the presence or seepage of water does not occur. All construction and backfilling shall proceed in-the-dry and flotation of completed portions of work shall be prohibited.
- B. Methods of groundwater control may include but are not limited to perimeter trenches and sump pumping, perimeter groundwater cutoff, well points, ejectors, deep wells and combinations thereof.
- C. Where groundwater levels are above the proposed bottom of excavation level, a pumped dewatering system will be required for predrainage of the soils prior to excavation, and for maintaining the lowered groundwater level until construction has been completed to such an extent that the structure, pipeline or fill will not be floated or otherwise damaged.
- D. It is expected that the type of system, spacing of dewatering units and other details of the work will have to be varied depending on soil/water conditions at a particular location.
- E. All work included in this Section shall be done in a manner which will protect adjacent structures and utilities and shall not cause loss of ground or disturbance to the pipe bearing soils or to soils which support overlying or adjacent structures.
- F. Install, monitor and report data from observation wells. Evaluate the collected data relative to groundwater control system performance and modify systems as necessary to dewater the site in accordance with the Contract requirements.
- G. Locate groundwater control system components where they will not interfere with construction activities adjacent to the work area or interfere with the installation and monitoring of geotechnical instrumentation including observation wells. Excavations for sumps or drainage ditches shall not be made within or below 1H:1V slopes extending downward and out from the edges of existing or proposed foundation elements or from the downward vertical footprint of the pipe.

3.2 SURFACE WATER CONTROL

- A. Construct surface water control measures, including dikes, ditches, sumps and other methods to prevent, as necessary, flow of surface water into excavations and to allow construction to proceed without delay.

3.3 EXCAVATION DEWATERING

- A. At all times during construction, provide and maintain proper equipment and facilities to promptly remove and properly dispose of all water entering excavations. Excavations shall be

maintained in-the-dry. Groundwater levels shall be kept at least 2-ft below the lowest excavation level.

- B. Excavation dewatering shall maintain the subgrade in a natural undisturbed condition and until the fill, structure or pipes to be built thereon have been completed to such extent that they will not be floated or otherwise damaged by allowing water levels to return to natural elevations.
- C. Pipe, masonry, and concrete shall not be placed in water or be submerged within 24 hours after being installed. Water shall not flow over new masonry or concrete within four days after placement.
- D. In no event shall water rise to cause unbalanced pressure on structures until the concrete or mortar has set at least 24 hours. Prevent flotation of the pipe by promptly placing backfill.
- E. Dewatering shall at all times be conducted in such a manner as to preserve the natural undisturbed condition of the subgrade soils at the proposed bottom of excavation.
- F. If the subgrade of the trench or excavation bottom becomes disturbed due to inadequate dewatering or drainage, excavate below normal grade as directed by the Owner/Engineer and refill with structural fill, screened gravel or other material as approved by the Owner/Engineer at the Contractor's expense.
- G. It is expected that the initial dewatering plan may have to be modified to suit the variable soil/water conditions to be encountered during construction. Dewater and excavate, at all times, in a manner which does not cause loss of ground or disturbance to the pipe bearing soil or soil which supports overlying or adjacent structures.
- H. If the method of dewatering does not properly dewater the excavation as specified, install additional groundwater observation wells as directed by the Owner/Engineer and do not place any pipe or structure until the readings obtained from the observation wells indicate that the groundwater has been lowered a minimum of 2-ft below the bottom of the final excavation within the excavation limits.
- I. Dewatering units used in the work shall be surrounded by suitable filter sand and no fines shall be removed by pumping. Pumping from the dewatering system shall be continuous until pipe or structure is adequately backfilled. Stand-by pumps shall be provided.
- J. Water entering the excavation from precipitation or surface runoff shall be collected in shallow ditches around the perimeter of the excavation, drained to a sump and pumped from the excavation to maintain a bottom free from standing water.
- K. Drainage shall be disposed of in an approved area as specified in Section 01046. Existing or new sanitary sewers shall not be used to dispose of drainage.

3.4 WELL POINT SYSTEMS

- A. Where necessary, install a vacuum well point system around the excavation to dewater the excavation. Each well point and riser pipe shall be surrounded by a sand or gravel filter. Sand or gravel shall be of such a gradation that, after initial development of the well points, the quantity

and size of soil particles discharged shall be negligible. Well point systems shall be capable of operating continuously under the highest possible vacuum.

- B. Installation of well point systems shall be in accordance with the approved submittal and in the presence of the Owner/Engineer.

3.5 DEEP WELLS

- A. Where necessary, install a deep well system around the excavation to dewater or depressurize the excavation. Each well shall be surrounded by a sand or gravel filter with adequate gradation such that after development, the quantity and size of soil particles discharged are negligible. Sufficient number of wells shall be installed to lower or depressurize the groundwater level to allow excavation to proceed in-the-dry.
- B. Installation of deep well shall be in accordance with the approved submittal and in the presence of the Owner/Engineer.

3.6 OBSERVATION WELLS

- A. Install observation wells to monitor groundwater levels beneath and around the excavated area until adjacent structures and pipelines are completed and backfilled.
- B. Observation Well Locations and Depths:
 - 1. A minimum of 3 wells (one upstream and two downstream of the groundwater gradient) shall be installed around the excavation area. They shall be located in critical areas with respect to groundwater control to monitor performance of dewatering systems designed by the Contractor's Engineer.
 - 2. Observation wells required shall be installed to a depth of at least 10-ft below the deepest level of excavation, unless otherwise approved by the Owner/Engineer, and to whatever depth is necessary to indicate that the groundwater control system designed by the Contractor's Engineer is performing as intended. Additional observation wells may be required by the Owner/Engineer if deemed necessary to monitor the performance of the Contractor's groundwater control system.
 - a. Locations and depths of observation wells are subject to approval by the Owner/Engineer.
- C. Protect the observation wells at ground surface by providing a lockable box or outer protective casing with lockable top and padlock. Design the surface protection to prevent damage by vandalism or construction operations and to prevent surface water from infiltrating.
- D. Provide two copies of keys for each padlock to the Owner/Engineer for access to each well.
- E. Observation wells shall be developed so as to provide a reliable indication of groundwater levels. Wells shall be re-developed if well clogging is observed, in the event of apparent erroneous readings, or as directed by the Owner/Engineer.

- F. Submit observation well installation logs, top of casing elevation, and well locations to the Owner/Engineer within 24 hours of completion of well installation.
- G. Observation Well Maintenance
 - 1. The Contractor shall maintain each observation well until adjacent structures and pipelines are completed and backfilled. Clean out or replace any observation well which ceases to be operable before adjacent work is completed.
 - 2. It is the Contractor's obligation to maintain observation wells and repair or replace them at no additional cost to the Owner, whether or not the observation wells are damaged by the Contractor's operations or by third parties.
 - 3. Monitoring and Reporting of Observation Well Data
 - a. The Contractor shall begin daily monitoring of groundwater levels in work areas prior to initial operation of drainage and dewatering system. Daily monitoring in areas where groundwater control is in operation shall continue until the time that adjacent structures and pipelines are completed and backfilled and until the time that groundwater control systems are turned off.
 - b. The Contractor is responsible for processing and reporting observation well data to the Engineer on a daily basis. Data is to be provided to the Owner/Engineer on a form, which shall include the following information: observation well number, depth to groundwater, total depth of well, top of casing elevation, groundwater level elevation and date and time of reading.
- H. The groundwater level shall be kept at a minimum of 2-ft below the lowest subgrade level for a given excavation.

3.7 REMOVAL OF SYSTEMS

- A. At the completion of the excavation and backfilling work, and when approved by the Owner/Engineer, all pipe, deep wells, well points, pumps, generators, observation wells, other equipment and accessories used for the groundwater and surface water control systems shall be removed from the site. All materials and equipment shall become the property of the Contractor. All areas disturbed by the installation and removal of groundwater control systems and observation wells shall be restored to their original condition.
- B. Leave in place any casings for deep wells, well points or observation wells located within the plan limits of structures or pipelines or within the zone below 1H:1V planes extending downward and out from the edges of foundation elements or from the downward vertical footprint of the pipe, or where removal would otherwise result in ground movements causing adverse settlement to adjacent ground surface, utilities or existing structures.
- C. Where casings are pulled, holes shall be filled with sand. Where left in place, casings should be filled with cement grout and cut off a minimum of 3-ft below finished ground level or 1-ft below foundation level so as not to interfere with finished structures or pipelines.

END OF SECTION

THIS PAGE INTENTIONALLY LEFT BLANK

SECTION 02250
SHEETING AND BRACING

PART 1 - GENERAL

1.1 SUMMARY

- A. Work consists of providing and maintaining trench boxes, bracing, shoring and any supports required to stabilize excavations in order to proceed with the work.
- B. All excavation, trenching and related sheeting, bracing, etc., shall comply with the requirements of OSHA excavation safety standards (29 CFR Part 1926 Subpart P).
- C. Related Sections
 - 1. Section 02221-Trench Excavation, Bedding and Backfill
 - 2. Section 02240-Dewatering and Drainage

1.2 SITE CONDITIONS

- A. Contractor shall be fully responsible for the protection of his crew and equipment, and to assure compliance with all local, state, and federal regulations. It will not be the Owner's responsibility to notify the Contractor of insufficient or improper supports.

PART 2 – PRODUCTS – NOT USED

PART 3 - EXECUTION

3.1 INSTALLATION

- A. Furnish, put in place and maintain sheeting and bracing required by Federal, State or local safety requirements to support the sides of the excavation and prevent loss of ground which could endanger personnel, damage or delay the work or endanger adjacent structures. If the Owner/Engineer is of the opinion that at any point sufficient or proper supports have not been provided, he/she may order additional supports placed at the expense of the Contractor. Compliance with such order shall not relieve the Contractor from his/her responsibility for the sufficiency of such supports. Care shall be taken to prevent voids outside of the sheeting, but if voids are formed, they shall be immediately filled and rammed.
- B. When moveable trench bracing such as trench boxes, moveable sheeting, shoring or plates are used to support the sides of the trench, care shall be taken in placing and moving the boxes or supporting bracing to prevent movement of the pipe, or disturbance of the pipe bedding and the screened gravel backfill.

- C. When installing rigid pipe (D.I., etc.), any portion of the box extending below mid diameter shall be raised above this point prior to moving the box ahead to install the next pipe. This is to prevent the separation of installed pipe joints due to movement of the box.
- D. When installing flexible pipe (PVC, etc.), trench boxes, moveable sheeting, shoring or plates shall not be allowed to extend below mid-diameter of the pipe. As trench boxes, moveable sheeting, shoring or plates are moved, screened gravel shall be placed to fill any voids created and the screened gravel and backfill shall be re-compacted to provide uniform side support for the pipe.
- E. Permission will be given to use steel sheeting in lieu of wood sheeting for the entire job wherever the use of sheeting is necessary. The cost for use of sheeting will be included in the bid items for pipe and shall include full compensation for driving, bracing and later removal of sheeting.
- F. All sheeting and bracing shall be carefully removed in such manner as not to endanger the construction of other structures, utilities, or property, whether public or private. All voids left after withdrawal of sheeting shall be immediately refilled with sand by ramming with tools especially adapted to that purpose, by watering or otherwise as directed.
- G. No payment will be given for sheeting, bracing, etc, during the progress of the work. No payment will be given for sheeting which has actually been left in the trench for the convenience of the Contractor.
- H. Sheeting driven below mid-diameter of any pipe shall remain in place from the driven elevation to at least 1-ft above the top of the pipe.
- I. Sheeting and bracing shall remain in place to allow for inspection of the work.

3.2 REMOVAL

- A. In removing sheeting and bracing after the construction has been completed, take special care to prevent any collapse of the excavation and injury to the completed work or adjacent property.
- B. Remove sheeting as the backfilling progresses. Take special care to fill and compact voids created by removal of bracing and sheeting.

END OF SECTION

SECTION 02270
SEDIMENTATION AND EROSION CONTROL

PART 1 - GENERAL

1.1 SCOPE OF WORK

- A. Furnish all labor, materials, equipment, and incidentals required and perform all installation, maintenance, removal and area cleanup related to erosion and sedimentation control work as shown on the Drawings and as specified herein. The work shall include, but not necessarily be limited to; installation of temporary access ways and staging areas, silt fences, stone filter boxes, stone filter berms, sediment removal and disposal, device maintenance, removal of temporary devices, temporary mulching, excelsior matting installation and final cleanup.

1.2 RELATED WORK

- A. Dust control is included in Section 01046.
- B. Trench Excavation, Bedding and Backfill is included in Section 02221.
- C. Granular fill materials are included in Section 02230.

1.3 SUBMITTALS

- A. Submit, in accordance with Section 01300, within 20 days after award of Contract, technical product literature for all commercial products to be used for erosion and sedimentation control.

1.4 QUALITY ASSURANCE

- A. Be responsible for the timely installation and maintenance of all sedimentation control devices necessary to prevent the movement of sediment from the construction site to offsite areas or into the stream system via surface runoff or underground drainage systems. Measures in addition to those shown on the Drawings necessary to prevent the movement of sediment off site shall be installed, maintained, removed, and cleaned up at the expense of the Contractor. No additional charges to the Owner will be considered.
- B. Sedimentation and erosion control measures shall conform to the requirements outlined in the South Carolina Department of Health and Environmental Control, Owner and the County guidelines and regulations.

PART 2 - PRODUCTS

2.1 MATERIALS

- A. Crushed stone for sediment filtration devices, access ways and staging areas shall be as specified in Section 02230.
- B. Berm structural stone shall be rip-rap as follows:
 - 1. Rip-rap shall be sound, durable rock which is roughly rectangular shape and of suitable quality to ensure permanence in the condition in which it is to be used. Rounded stones, boulders, sandstone or similar soft stone will not be acceptable. Material shall be free from overburden, spoil, shale and organic material, meet the Engineer's approval and be well graded.
- C. Silt Fence
 - 1. Sediment fence shall be a prefabricated commercial product made of a woven, polypropylene, ultraviolet resistant material such as "Envirofence" by Mirafi Inc., Charlotte, NC or equal.
- D. 1/4-in woven wire mesh for filter boxes shall be galvanized steel or hardware cloth.
- E. Straw mulch shall be utilized on all newly graded areas to protect areas against washouts and erosion. Straw mulch shall be comprised of threshed straw of oats, wheat, barley, or rye that is free from noxious weeds, mold or other objectionable material. The straw mulch shall contain at least 50 percent by weight of material to be 10-in or longer. Straw shall be in an air-dry condition and suitable for placement with blower equipment.
- F. Erosion control blanket shall be installed in all seeded drainage swales and ditches as shown on the Drawings or as directed by the Owner/Engineer. Erosion control blanket shall be 100 percent agricultural straw matrix stitch bonded with degradable thread between two photodegradable polypropylene nettings, such as Model S150 Double Net Short-Term Blanket (10 months) by North American Green, Evansville, IN or equal.

PART 3 - EXECUTION

3.1 INSTALLATION

- A. Silt Fence Installation
 - 1. Silt fences shall be positioned as indicated on the Drawings and as necessary to prevent off site movement of sediment produced by construction activities as directed by the Owner/Engineer.
 - 2. Dig trench approximately 6-in wide and 6-in deep along proposed fence lines.
 - 3. Drive stakes, 8-ft on center (maximum) at back edge of trenches. Stakes shall be driven 2-ft (minimum) into ground.

4. Hang filter fabric on posts carrying to bottom of trench with about 4-in of fabric laid across bottom of trench. Stretch fabric fairly taut along fence length and maintain secure both ways.
 5. Backfill trench with excavated material and tamp.
 6. Install pre-fabricated silt fence according to manufacturer's instructions.
- B. Construct filter boxes as detailed on the Drawings, from 1/4-in woven wire mesh or hardware cloth and wood. Fill with crushed stone and place overall drop inlets and manholes to storm drain system as each inlet is completed. This should be done prior to setting casting, if there is a delay between installation of inlet structures or drain manholes and setting of castings. An alternate method is to ring each inlet with a sediment fence.
- C. Stone Filter Berm Installation
1. Place berm structural stone across channel just below lower sandbag wall at work area. Face upstream side of structural berm with crushed stone.
- D. Staging areas and access ways shall be surfaced with a minimum depth of 4-in of crushed stone.

3.2 MAINTENANCE AND INSPECTIONS

A. Inspections

1. Make a visual inspection of all erosion and sedimentation control devices once per week and promptly after every rainstorm. If such inspection reveals that additional measures are needed to prevent movement of sediment to offsite areas, promptly install additional devices as needed. Sediment controls in need of maintenance shall be repaired promptly.

B. Device Maintenance

1. Silt Fences

- a. Remove accumulated sediment once it builds up to 1/2 of the height of the fabric.
- b. Replace damaged fabric, or patch with a 2-ft minimum overlap.
- c. Make other repairs as necessary to ensure that the fence is filtering all runoff directed to the fence.

2. Filter Boxes

- a. Replace crushed stone when it becomes saturated with silt.

3. Stone Filter Berm

- a. Muck out trapped silt from dewatering operations when it has built up to within 6-in of the top of the berm.
- b. Replace crushed stone filter when saturated with silt.

4. Add crushed stone to access ways and staging area as necessary to maintain a firm surface free of ruts and mudholes.

3.3 TEMPORARY MULCHING

- A. Apply temporary mulch to areas where rough grading has been completed but final grading is not anticipated to begin within 30 days of the completion of rough grading.
- B. Straw mulch shall be applied at rate of 100 lbs/1000 sq ft and tackified with latex acrylic copolymer at a rate and diluted in a ratio per manufacturer's instructions.

3.4 EROSION CONTROL BLANKETS

- A. Erosion control blankets shall be installed in all seeded drainage swales and ditches as shown on the Drawings and as directed by the Owner/Engineer in accordance with manufacturer's instructions. The area to be covered shall be properly prepared, fertilized and seeded with permanent vegetation before the blanket is applied. When the blanket is unrolled, the netting shall be on top and the fibers in contact with the soil over the entire area. The blankets shall be applied in the direction of water flow and stapled. Blankets shall be placed a minimum of three rows (of 4-ft) wide (total approx. 12-ft width) within the drainage swale/ditch and stapled together in accordance with manufacturer's instructions. Side overlaps shall be 4-in minimum. The staples shall be made of wire, 0.091-in in diameter or greater, "U" shaped with legs 10-in in length and a 1-1/2-in crown. Commercial biodegradable stakes may also be used with prior approval by the Engineer. The staples shall be driven vertically into the ground, spaced approximately two linear feet apart, on each side, and one row in the center alternately spaced between each size. Upper and lower ends of the matting shall be buried to a depth of 4-in in a trench. Erosion stops shall be created every 25-ft by making a fold in the fabric and carrying the fold into a silt trench across the full width of the blanket. The bottom of the fold shall be 4-in below the ground surface. Staple on both sides of fold. Where the matting must be cut or more than one roll length is required in the swale, turn down upper end of downstream roll into a slit trench to a depth of 4-in. Overlap lower end of upstream roll 4-in past edge of downstream roll and staple.
 - 1. To ensure full contact with soil surface, roll matting with a roller weighing 100 lbs/ft of width perpendicular to flow direction after seeding, placing matting and stapling. Thoroughly inspect channel after completion. Correct any areas where matting does not present a smooth surface in full contact with the soil below.

3.5 REMOVAL AND FINAL CLEANUP

- A. Once the site has been fully stabilized against erosion, remove sediment control devices and all accumulated silt. Dispose of silt and waste materials in proper manner. Regrade all areas disturbed during this process and stabilize against erosion with surfacing materials as indicated on the Drawings.

END OF SECTION

SECTION 02575
PAVEMENT, MARKINGS, AND APPURTENANCES

PART 1 - GENERAL

1.1 SCOPE OF WORK

- A. Furnish all labor, materials, equipment, and incidentals required to install paved roadway, parking areas, and guard, rails as shown on the Drawings and as specified herein.
- B. The work includes removal of existing pavement, preparation of existing paved surfaces and repaving of those surfaces as specified herein.
- C. All pavement markers and markings shown on the Drawings or that existed prior to construction shall be replaced with new markers and new markings.
- D. All work on South Carolina State Highways shall conform to South Carolina Department of Transportation (SCDOT) requirements as well as the requirements specified herein. The Contractor shall familiarize himself with all requirements of the SCDOT. The Owner will furnish copies of State Highway Encroachment Permits to the Contractor. The Contractor shall perform all work in accordance with all requirements and stipulations contained therein or per the requirements stated by the encroachment permit.
- E. Traffic shall be maintained on all roads and streets during pipeline construction.
- F. Where drives, patios or pavement on private property must be cut for the execution of the work, the Contractor shall replace pavement with similar materials. Entire disturbed areas shall be repaired to as good or better condition than existed prior to construction.

1.2 RELATED WORK

- A. Trench Excavation, Bedding and Backfill is included in Section 02221.
- B. Granular Fill Materials are included in Section 02230.
- C. Sedimentation and Erosion Control: Section 02270.

1.3 SUBMITTALS

- A. Submit to the Owner/Engineer in accordance with Section 01300, shop drawings showing dimensions, layouts, and details of construction, and accessories required.
- B. Copies of load tickets shall be submitted to the Engineer on a daily basis when paving work is performed.

1.4 REFERENCE STANDARDS

- A. Except as otherwise specified herein, the material and construction shall be in accordance with the current Standard Specifications for Highway Construction and relevant supplemental specifications as issued by the SCDOT.
- B. American Society for Testing and Materials (ASTM)
 - 1. ASTM A307 – Standard Specification for Carbon Steel Bolts, Studs, and Threaded Rod 60,000 Psi Tensile Strength.
- C. American Association of State Highway and Transportation Officials (AASHTO)
 - 1. AASHTO M144 – Standard Specification for Calcium Chloride.
 - 2. AASHTO M180 – Standard Specification for Corrugated Sheet Steel Beams for Highway Guardrail.
- D. American Wood Preservers Association (AWPA)
 - 1. AWPA C1 – All Timber Products, Preservative Treatment by Pressure Process.
 - 2. AWPA C14 – Wood for Highway Construction, Preservative Treatment by Pressure Process.
 - 3. AWPA M4 – Standard for the Care of Preservative-Treated Wood Products.
 - 4. AWPA P5 – Standards for Waterborne Preservatives.
- E. Where reference is made to one of the above standards, the revision in effect at the time of Bid opening shall apply.

PART 2 - PRODUCTS

2.1 MATERIALS

- A. SURFACE COURSE: The surface course shall be Type C, in accordance with Section 403 (omitting paragraphs 403.5 and 403.6) of the SCDOT Specifications.
- B. STABILIZED AGGREGATE BASE COURSE: The aggregate base course shall meet all requirements of Section 305 (omitting paragraphs 305.5 and 305.6) of the SCDOT specifications. Rolling shall meet requirements of Section 305.4.3, and the surface shall be rolled three times with a steel roller. The finished surface shall be protected until hard.
- C. Bituminous concrete binder course shall meet Section 402 of SCDOT standards.

- D. Calcium chloride shall meet AASHTO M-144 and shall be spread wherever directed to allay dust conditions. The Owner/Engineer may direct the Contractor to employ sprinkling of water in lieu of calcium chloride for dust control.
- E. Asphalt – Tack coat shall consist of either emulsified asphalt or cutback asphalt conforming to the above referenced SCDOT standards.
- F. Pavement marking paint shall be fast-drying type conforming to the above referenced SCDOT standards and Federal Specifications TT-P 1952B.
- G. CONCRETE: Concrete shall be 3,000 PSI minimum 28-day compressive strength air-entrained ready-mix batched in accordance with SCDOT SC-M-501.

PART 3 - EXECUTION

3.1 GENERAL

- A. Asphalt pavement materials specified shall be installed in accordance with the requirements of Section 401 of SCDOT Specifications.
- B. Concrete materials shall be installed in accordance with the SCDOT Specification Section 720.
- C. Before construction of the base course, the subgrade shall be prepared as required. Subgrade shall conform to the lines, grades and cross sections indicated on the Drawings or encroachment permits, and fills shall be compacted as specified in Section 02221.
- D. For concrete pavement resurfacing, the entire area to be repaired shall be dampened prior to the placement of the concrete to limit the moisture extraction by the base material.
- E. When required, remove existing pavement by saw, pneumatic hammer, or wheel, cutting edges of trenches to be repaved as directed by the Owner/Engineer. After pipe laying, backfilling, and compaction operations are completed satisfactorily, and after the gravel subbase is shaped and compacted, place the type of pavement as shown on the Drawings.
- F. Furnish and spread calcium chloride on or wet down disturbed surfaces to allay dust conditions as directed by the Owner/Engineer.
- G. All new and existing manhole frames, utility boxes, and drain inlets shall be set to the grade of the wearing course. At no time shall the manhole frames be allowed to protrude above the surface of the wearing course.
- H. The contact surfaces of castings, previously constructed asphalt or Portland cement concrete pavements shall be painted with a tack coat in accordance with SCDOT standards. Surfaces shall be thoroughly cleaned of all loose material and debris prior to application of the tack coat.
- I. Pavement replacement and other surfacing as specified herein will be a condition of progress payment applications.

- J. No vehicular traffic or loads shall be permitted on the newly completed pavement, until adequate stability has been attained and/or the material has cooled sufficiently to prevent distortion or loss of fines. If climatic or other conditions warrant it, the period of time before opening to traffic may be extended at the discretion of the Owner/Engineer.
- K. Contractor shall properly maintain the pavement cut until the patch is made and shall promptly fill ruts and depressions.
- L. Contractor shall maintain pavement under this Contract during the guarantee period of two year and shall promptly (within three days of notice given by Owner/Engineer) refill and repave areas which have settled or are otherwise unsatisfactory for traffic.

3.2 BITUMINOUS PAVING

- A. All pavement thicknesses referred to herein are compacted thicknesses. The Contractor shall place sufficient mix to ensure that the specified thickness of pavement occurs where called for.
- B. Where the trench patch crosses a SCDOT roadway, the roadway shall be resurfaced per SCDOT requirement. The limit of surface course shall be feathered into the existing pavement.
- C. Entire areas to be resurfaced (including edges of existing pavement) shall be primed with an acceptable asphalt prime coat just prior to placing new pavement.
- D. The binder course shall be placed as soon as possible after the aggregate base course has been prepared, shaped, and compacted.
- E. The binder course shall be placed and compacted by steel-wheeled rollers of sufficient weight to thoroughly compact the bituminous concrete. Where necessary, the new pavement shall be rolled smooth and even with the existing pavement.
- F. Hose clean all road surfaces after backfilling and before any surfacing but, in no case, shall pavement be placed until the gravel base is dry and compacted to at least 98-percent maximum density at optimum moisture content in accordance with the requirements of Section 02221.
- G. After the paving mixture has been properly spread, initial compaction shall be obtained by the use of power rollers weighing not less than 240 pounds per inch width of tread.
- H. Asphalt surface course shall be as specified and shall be applied at the minimum rate of 110 pounds per square yard per inch of thickness.
- I. Final compaction of the surface shall be accomplished by rollers weighing not less than 285 pounds per inch width of tread. Along curbs, structures, and all places not accessible with a roller, the mixture shall be thoroughly compacted with tampers. Such tampers shall not weigh less than 25 pounds and shall have a tamping face of not more than 50 square inches. The surface of the mixture after compaction shall be smooth and true to the established line and grade.
- J. When the air temperature falls below 50°F, extra precautions shall be taken in drying the aggregates, controlling the temperatures of the materials, and placing and compacting the mixtures.

- K. No mixtures shall be placed when the air temperature is below 40°F nor when the material on which the mixtures are to be placed contains frost or has a surface temperature the Owner/Engineer considers too low.

3.3 CONCRETE PAVING, CURB AND GUTTER

- A. The replacement of concrete pavements, and concrete curb and gutters shall meet all requirements of Section 720 of the SCDOT specifications.

3.4 CUTTING AND REPLACING SIDEWALK

- A. Where sidewalk is cut for installation of pipe or other utilities, Contractor shall cut it neatly in advance of trench and replace as described below or as shown on the plans. Where installation is along the line of sidewalk, sidewalk may be removed, with Engineer's approval and replaced in kind.
- B. Trench Backfill under sidewalk shall be as describe in Subgrade Preparation (3.01C) above.
- C. Base for sidewalk shall be minimum 4-inches compacted crusher run granite stone material.
- D. Pavement for sidewalk shall match existing walk in material and finish with a minimum 3-inches thick hot plant mix asphalt or minimum 4-inches thick concrete, to match existing sidewalk material.

3.5 TRENCH PAVEMENT RESTORATION

- A. Restore trench pavement in County and State roads as shown on the Drawings.
- B. If points of settlement or holes appear in the pavement, the Contractor shall repair the same within three days of notification by the Owner/Engineer. If, after due notice, the Contractor fails to make the repairs, the work will be done by the Owner and the total cost of such repairs will be charged to the Contractor.

3.6 ROAD REFLECTIVE MARKERS

- A. Road markers shall be installed in accordance with the manufacturer's instructions.
- B. Road marker locations shall be spotted in the field and approved by the Owner/Engineer before installation.

3.7 ROADWAY MARKINGS

- A. Markings shall be located as shown on the Drawings or as existed prior to construction.

- B. All surface dirt within the areas to be painted shall be removed. Large areas of tar, grease, or foreign materials may require sand blasting, steam cleaning, or power brooming to accomplish complete removal. Application of stripes shall not proceed until final authorization is received from the Owner/Engineer.
- C. No thinners shall be used for the pavement marking applications, except in accordance with the manufacturer's specifications and at the direction of the Owner/ Engineer.
- D. No paint or pavement marking material shall be heated above the temperature marked on the container.
- E. Bituminous concrete pavements shall have been in place for 48 hours prior to the application of pavement markings.
- F. If for any reason, material is spilled or tracked on the pavement; or if any markings applied, in the Owner/Engineer's judgement, fail to conform because of a deviation from the desired pattern, the Contractor shall remove such material by a method that is not injurious to the roadway surface and is acceptable to the Owner/ Engineer. Contractor shall clean the roadway surface and prepare the surface for a reapplication of markings, and reapply the markings as directed without additional compensation.

END OF SECTION

SECTION 02730
SANITARY SEWER SYSTEMS

PART 1 - GENERAL

1.1 SCOPE:

- A. Work in this section consists of the supply and installation of all gravity sanitary sewer lines including layout, identification of other utility crossings or conflicts, establishment and maintenance of required alignment and grade, cleaning, and testing as shown on the drawings and specified herein.

1.2 RELATED WORK

- A. Section 02221 Trench Excavation, Bedding and Backfill
- B. Section 02731 Ductile Iron Sewer Pipe (DIP)
- C. Section 02732 Polyvinyl Chloride (PVC) Sewer Pipe

1.3 OTHER REQUIREMENTS

- A. All pipe elevations shown on the Drawings are invert elevations (i.e., the bottom inside of pipe), unless otherwise shown.

1.4 SUBMITTALS

- A. Submit material certifications and product data for all pipe, couplings and fittings demonstrating conformance to specifications.

1.5 QUALITY ASSURANCE:

- A. Comply with all applicable standards contained herein and with the provisions of the following codes and standards except as otherwise shown or specified:
 - 1. South Carolina Department of Health and Environmental Control: All applicable rules and regulations.
 - 2. All requirements of the sewer service agency that will own, operate and maintain this sewer.

1.6 REFERENCE STANDARDS:

- A. ASTM A53 - Standard Specification for Pipe, Steel, Black and Hot-Dipped, Zinc-Coated, Welded and Seamless.

- B. ASTM A126 – Standard Specification for Gray Iron Castings for Valves, Flanges, and Pipe Fittings.
- C. ASTM A139 - Standard Specification for Electric-Fusion (Arc)-Welded Steel Pipe (NPS 4 and Over).
- D. ASTM C425 – Standard Specification for Compression Joints for Vitrified Clay Pipe and Fittings.
- E. ASTM C923 – Standard Specification for Resilient Connectors between Reinforced Concrete Manhole Structures, Pipes and Laterals.
- F. ASTM D3034 – Standard Specification for Type PSM Poly (Vinyl Chloride) (PVC) Sewer Pipe and Fittings.
- G. AWWA C200 – Standard for Steel Water Pipe 6 Inch (150 mm) & Larger.
- H. AWWA C900 – Polyvinyl Chloride (PVC) Pressure Pipe and Fabricated Fittings, 4 in. through 60 in.

PART 2 - PRODUCTS

2.1 COUPLINGS:

- A. Couplings shall be used to join pipe of different materials. Couplings with adjustable stainless steel shear rings shall be installed according to the manufacturer's instructions.
- B. Acceptable couplings are Mission Seals by Mission Rubber Company LLC or approved equal.
- C. Coupling to connect steel pipe shall be steel per approved materials list to suit the piping to be connected.

2.2 PIERS AND PROTECTION WORK:

- A. Piers and concrete protection work shall be constructed where indicated on plans or directed by Engineer. All piers shall be of concrete unless shown otherwise on plans or directed by Engineer.
- B. Concrete Piers: Foundation for piers shall be adequate to support intended load and will be subject to Engineer's approval prior to pouring concrete.
- C. Protection Concrete shall be provided in locations as shown on plans or directed by Engineer.
- D. Concrete for piers, protection and other uses shall be composed of Portland cement, sand, coarse aggregate, water and such admixtures as may be allowed, in such proportions as to provide a minimum 28-day compressive strength of 4,000 psi. Source of concrete and mix design shall be approved by Engineer prior to use.

2.3 PRECAST CONCRETE MANHOLES

- A. Sections shall conform to ASTM C478 or ASTM C913. Concrete shall have a minimum 28-day compressive strength of 4,000 psi. Minimum wall thickness shall be 5".
- B. Section joints shall be watertight and shall conform to Federal Specification SS-S-210, Type B Butyl Rubber. Joints shall be externally sealed with a polyethylene backed butyl rubber sheet no less than 1/16" thick and 6" wide.

2.4 FOUNDATION MATERIAL

- A. Materials placed for structure foundations shall be washed stone (No. 57 stone per SCDOT Standard Specifications for Highway Construction).

2.5 FLEXIBLE PIPE CONNECTORS

- A. Flexible connectors shall conform to ASTM C923. All clamps and metal accessories shall be stainless steel.

2.6 CAST-IN-PLACE-CONCRETE

- A. Concrete shall have a minimum compressive strength of 4,000 psi.

2.7 MANHOLE STEPS

- A. Steps shall be Copolymer Polypropylene Plastic reinforced with a 1/2" diameter grade 60 steel bar.

2.8 MANHOLE RINGS AND COVERS

- A. Standard Manhole rings and covers shall be gray iron, Class 35B, conforming to ASTM A48 or AASHTO M105, and AASHTO M306. Manhole rings and covers shall be for heavy duty use with standard weights of 190 pounds min. for each ring, and 90 pounds min. for each cover. Castings shall be free from blow holes, porosity, hard spots, shrinkage distortion, or other defects. Bearing surfaces between ring and cover or grate shall be machined to prevent rocking and rattling.
- B. Watertight Manhole rings and covers shall be gray iron, Class 35B, conforming to ASTM A48 or AASHTO M105, and AASHTO M306. Manhole rings and covers shall be for heavy duty use with standard weights of 190 pounds min. for each ring, and 90 pounds min. for each cover. Castings shall be free from blow holes, porosity, hard spots, shrinkage distortion, or other defects. Bearing surfaces between ring and cover or grate shall be machined to prevent rocking and rattling. Covers must be fitted with adjustable camlocks and TGS gaskets.

2.9 MORTAR

- A. Masonry cement shall conform to ASTM C270, Type II non-shrinking with maximum 12% air content by volume. Masonry cement shall be Type S conforming to ASTM C270.
- B. Mortar shall have an integral waterproofing additive and shall be composed of masonry cement and sand in proportions recommended by the manufacturer of the cement. Maximum proportions shall not exceed 3 parts sand to one part masonry cement, measured by volume and mixed dry. Bag, premixed Type S mortar may be used in lieu of job mix mortar.
- C. Water used in mixing mortar shall be clean and free of deleterious amounts of acid, oil, alkalis or organic materials. Mortar shall not be allowed to stand for longer than one hour after water is added.

2.10 TRACER WIRE

- A. Provide minimum 12-gage solid copper tracer wire encased in 30 mils HDPE insulation for all force mains.
- B. Provide tracer wire connection point at each manhole and access ports along force mains.

PART 3 - EXECUTION

3.1 GENERAL

- A. Under no circumstances shall pipe be laid in water, on rock, or when trench conditions or weather is unsuitable for such work. Each pipe shall be carefully examined before being installed and any defective or damaged pipe shall be removed from the site. Proper facilities shall be provided for lowering sections of pipe into trenches. The pipe shall have uniform bearing upon the pipe bed for the full length of its barrel. Raising the pipe off the subgrade (bridging) to obtain the proper elevation will not be allowed. Pipe shall be laid on a uniform slope between pipe invert elevations. Each section shall be securely attached to the adjoining sections by the method approved in accordance with the type of joints used.
- B. Any pipe, in the Owner/Engineer's opinion, which is not in true alignment or shows settlement after laying, or is damaged, shall be removed and re-laid at no additional cost to the Owner.
- C. Pipe shall be hoisted from the trench side to the trench by means of wide belt slings. Chains, cables, tongs, or other equipment likely to cause damage to the pipe coatings will not be permitted, nor will dragging or skidding of the pipe. The Contractor shall allow inspection of the pipe while it is suspended from the slings. Any damage shall be repaired before the pipe is lowered into the trench.
- D. At all times during storage and construction of the pipeline, the Contractor shall use every precaution to prevent damage to protective coating on the pipe. Pipe shall be stored along the trench side, suitably supported off the ground to avoid damage to the coating. No metal tools or heavy objects shall be permitted to come into contact unnecessarily with the finished coating. Any damage to the pipe or the protective coating from any cause before final acceptance by the

Owner shall be repaired, as directed by the Engineer by and at the expense of the Contractor.

- E. During times when pipe laying is not in progress, the open ends of pipe shall be closed and no trench water shall be permitted to enter the pipe.

3.2 PIPE INSTALLATION

- A. Piping shall be installed in accordance with best practice, manufacturer's instructions and Engineer's direction. Where pipeline crosses under or is installed on highway or railroad right-of-way, work shall be done in accordance with such requirements specified by the right-of-way agreement.
- B. Pipelines shall be installed in locations as shown on the plans, and to alignment and grade shown thereon. Prior to beginning work on any section of line, Contractor shall consult with Owner and determine that all rights-of-way and necessary permits have been obtained. Contractor shall familiarize himself with all conditions and/or limitations of such rights-of-way and any encroachment beyond these limits shall be contractor's liability.
- C. Pipe shall be laid with beginning at the bottom of the slope and proceed upward with the bell ends of the new pipe upslope. The spigot end shall be installed into the bell end until the reference point on the pipe.
- D. Pipe joints shall be made up in strict accordance with the manufacturer's directions.

3.3 INSTALLATION OF PIPE REPAIR COUPLINGS

- A. Existing sewer pipe shall be excavated with care so no damage to the pipe or existing fittings is caused. Hand digging around the existing pipe may be required to provide a clear opening for repairing or removing and reinstalling new pipe as specified herein.
- B. All repair couplings shall be examined before installation and none shall be installed which are found to be defective.
- C. Installation of flexible couplings shall be in accordance with manufacturer's instructions and as specified herein.
- D. Any damage to existing pipe or fittings other than pipe or fittings specifically intended to be removed, replaced or abandoned as part of this Contract shall be repaired by the Contractor as directed by the Inspector. If the Contractor damages existing pipe or fittings through error or for his own convenience he will be directed by the Owner/Engineer to repair all damages, in which case the repair work shall be performed at his own expense.
- E. Flexible sleeve type couplings shall be installed for connecting new replacement pipe and fittings to existing sewer pipe made of any pipe material.
- F. Flexible sleeve type couplings shall be installed over smooth spigot or cut ends of pipe. If cutting pipe is required, the cutting shall be done by machine or tool specifically intended for the purpose of cutting the type of pipe being worked on. All cutting of pipe shall be at right angles to the axis of the pipe and shall be performed so as to leave a smooth cut.

- G. Replacement of existing sewer pipe using flexible couplings shall consist of removing the damaged pipe to the length as specified on the Drawings for each point repair. Care shall be exercised so that on the existing pipe left-in-place, a clean, unbroken spigot end (or smooth cut end) and a clean, unbroken bell end (or smooth cut end) are available to connect the replacement pipe. The replacement pipe shall have a sleeve coupling slid onto the opposite end of the replacement pipe aligned with the existing spigot end. The sleeve coupling shall then be slid halfway back over the existing spigot and clamped securely into place. The new pipe shall be bedded and backfilled as specified. The new pipe shall be accurately cut to length so that the gap left is 1/2 inch or less.

3.4 MANHOLE INSTALLATION

- A. Precast base sections shall be installed on a firm foundation, which has been prepared to prevent settlement and misalignment. Refer to specification section 02221 for backfill and compaction requirements. Pipe openings shall be exactly aligned to that of pipe entering and leaving structure.
- B. Minimum 1-inch diameter joint sealant shall be installed against clean, dry concrete surfaces to form seal between sections. Remove protective backing from sealant and fill annular space uniform to make a watertight seal between all precast sections.
- C. Rings and covers shall be installed per the Standard Details. Use grade rings to adjust rings & covers to final grade. Seal all joints between rings, grade rings and precast sections with butyl sealant. No more than 10" of grade rings will be allowed. Metal grade rings are not acceptable. Use only Owner approved grade rings.
- D. Steps shall be vertically aligned at the spacing indicated, but in no case more than 16 inches on center.
- E. Pipe shall be placed in openings provided in the base section and properly aligned and set to grade.
- F. For Concrete Collars. Pipe shall be firmly held in place, and the opening around the exterior of pipe and the base opening shall be filled with an expanding non-shrink grout rammed into place, to provide a water-tight connection.
- G. Inverts shall be U-shaped channel with a minimum height of 0.8 of the diameter and be smooth continuation of the pipe. The benches shall be constructed with a slope of two-tenths of a drop per manhole. The channel and invert shall be constructed with a minimum of 3,500 psi concrete or brick and mortar fill with concrete finish minimum one inch thick. Where sewer changes directions, the manhole channel shall be constructed with a smooth curve with a radius as large as the diameter of the manhole will allow. The bench at the edge of the channel shall be level.
- H. Fill in all chips or holes greater than 1/2" in depth with mortar to provide a final finish.
- I. Where visible leakage occurs through the structure walls, the Contractor shall immediately notify the Owner and the Engineer. The Contractor shall provide all requisite information to the Owner and Engineer to help determine the cause of the leak, location of the leak fix (internal or external) and shall address the leak as directed by the Owner.

3.5 CLEANING

- A. All foreign matter and dirt shall be cleaned from the inside of the pipe before installing and shall be kept clean during and after installation. All lines, upon completion or at such time as directed, shall be cleaned, inspected and tested.

3.6 INSPECTION AND TESTING

- A. General. After completion of the work or any part thereof, but before its final acceptance, all parts of the job shall be tested to determine that it is constructed or installed in accordance with the Drawings and Specifications. Failure of any section to meet the requirements of the testing shall be repaired at the Contractor's expense and retested until conformance is achieved. The Contractor shall maintain the project for such time as is necessary to satisfy the Engineer that all installations are correct. All final testing and inspections shall be performed in the presence of the Engineer and the Owner's Representative.
- B. Air Testing. All new sewer lines including service lines shall be subjected to a low-pressure air test to determine the presence of damaged pipe or faulty installation. The Contractor will furnish all facilities and personnel for conducting the tests. The Contractor may desire to make an air test prior to backfilling for his own purposes. However, the required air test shall be made after backfilling has been completed and compacted and in the presence of the Engineer and/or Owner. The test shall be performed in accordance with ASTM F1417 Time-Pressure drop method and as outlined below.
 - 1. Low pressure testing shall be performed with a continuous monitoring gauge no less than 4 inches in diameter with minimum divisions of 0.10 psi, an accuracy of 0.04 psi \pm and a max reading of 30 psi. All air shall pass through a single, above ground control panel visible to the Engineer.
 - 2. Determine the groundwater elevation and determine the average groundwater head above the section being tested. Adjust the test pressures by adding 0.43 psi per foot of groundwater head.
 - 3. Determine the test time for the section being tested using Low Pressure Air Testing Times located at the end of this specification section. Add in time for service laterals connected to the line being tested if directed by the Owner/Engineer.
 - 4. Plug all openings in test section.
 - 5. Pressurize the section gradually to a minimum of 4.0 psi (maximum of 9.0 psi) and allow pressure to stabilize (maintain the minimum pressure for a minimum of 5 minutes). Do not over-pressurize the section. No one will be allowed in the manhole during testing.
 - 6. Once the pressure has stabilized, shut off pressure supply and start timing using a stop watch or other acceptable timing device. Measure the pressure drop for the period of time as computed above (Item iii).
 - 7. If the pressure drops more than 1.0 psi within this time, then the section has failed.
- C. Deflection of flexible gravity sewer pipe shall be tested by pulling a go/no-go gage through the pipe. Diametric deflection of the pipe shall not exceed 5% of the base inside diameter as stated in ASTM D3034 latest edition. The gage shall be drawn through the pipe from manhole to manhole. Any portion of pipe through which the gage passes freely shall be deemed to have passed the deflection test. Deflection test shall be performed no sooner than 30 days after installation as stated in ASTM D2321 latest edition.

- D. **Manhole Vacuum Testing.** All new manholes shall be subjected to a vacuum test to determine the presence of damaged or faulty installation. The vacuum test shall be made after backfilling has been completed and the base course of roadway has been installed. The vacuum testing must be conducted in the presence of the Owner.

The test will be performed as follows:

1. Plug all manhole entrances and exits other than the manhole top access using suitably sized pneumatic or mechanical pipeline plugs and follow all manufacturer's recommendations and warnings for proper and safe installation of such plugs.
2. Install the vacuum tester head assembly at the top access of manhole.
3. Evacuate the manhole to 10" Hg. (approximately negative 5 psig, 0.3 bar).
4. Close vacuum inlet/outlet ball valve and shut off vacuum pump. If vacuum does not drop in excess of 1" Hg. within time indicated below manhole is considered acceptable and the manhole passes the test. If manhole fails the test, complete necessary repairs and repeat test procedures until satisfactory results are obtained.

Manhole Diameter (in.)	Test Time for manhole depth of 24 ft and less* (sec.)
48	60
60	75
72	90
84	105
96	120
120	150

*- for manhole depths above 24 feet, test times as recommended by ASTM C1244 shall be used.

- E. **Visual Inspection.** Manholes shall be inspected for visible leaks. Manholes showing signs of leakage will not be accepted.

3.7 CLEAN UP

- A. Upon completion of the construction work the Contractor shall immediately remove all construction equipment, excess materials, tools, debris, etc., from the site(s) and leave the same in a neat, orderly condition acceptable to the Engineer. All project areas shall be graded so as to shed water to natural drainage areas. The areas shall be raked to a uniform surface free from rocks, clods of earth or other irregularities. All areas shall be left in a clean, neat condition.
- B. Final Clean-Up will meet approval of Engineer, Owner and property owner where applicable, with all defects in trench settlement, pavement patches or other deficiencies being promptly corrected.

Low Pressure Air Testing Times

**MINIMUM SPECIFIED TIME REQUIRED FOR A 1.0 PSIG PRESSURE DROP
FOR SIZE AND LENGTH OF PIPE INDICATED FOR Q = 0.0015**

Pipe Diameter (in.)	Specification Time for Length of Pipe Shown (min:sec)					
	100 ft	150 ft	200 ft	250 ft	300 ft	350 ft
6	5:40	5:40	5:40	5:40	5:40	5:40
8	7:34	7:34	7:34	7:34	7:36	8:52
10	9:26	9:26	9:26	9:53	11:52	13:51
12	11:20	11:20	11:24	14:15	17:05	19:56
15	14:10	14:10	17:48	22:15	26:42	31:09
18	17:00	19:13	25:38	32:03	38:27	44:52

*Source: Unibell PVC Pipe Association – Table UNI-B-6-98

END OF SECTION

THIS PAGE INTENTIONALLY LEFT BLANK

SECTION 02731
DUCTILE IRON SEWER PIPE

PART 1 - GENERAL

1.1 SCOPE

- A. This section establishes the criteria for acceptance of Ductile Iron Pipe (DIP).
- B. Related Work.
 - 1. Section 02221 Trench Excavation, Bedding and Backfill
 - 2. Section 02730 Sanitary Sewer Systems
- C. Submittals that include material certifications and product data for all pipe, pipe joints, and fittings that demonstrate conformance to specifications shall meet all requirements of Section 1300.

1.2 REFERENCE STANDARDS

- A. American National Standard Institute (ANSI) and American Water Works Association (AWWA):
 - 1. ANSI B18.2.2 Nuts for General Applications Machine Screw Nuts, Hex, Square, Hex Flange, and Coupling Nuts
 - 2. AWWA C105/A21.5 American National Standard for Polyethylene Encasement for Ductile-Iron Pipe.
 - 3. AWWA C110/A21.10 Ductile Iron and Gray Iron Fittings.
 - 4. ANSI/AWWA C111/A21.11 Rubber Gasket Joints for Ductile Iron and Gray Iron Pressure Pipe and Fittings.
 - 5. ANSI/AWWA C151/A21.51 Ductile Iron Pipe, Centrifugally Cast.
 - 6. AWWA C600 Installation of Ductile Iron Water Mains and Their Appurtenances.
 - 7. AWWA C210 Liquid-Epoxy Coatings and Linings For Steel Water Pipe and Fittings.
- B. American Society for Testing and Materials (ASTM):
 - 1. ASTM A307 – Standard Specification for Carbon Steel Bolts, Studs, and Threaded Rod 60,000 psi Tensile Strength
 - 2. ASTM A746 – Standard Specification for Ductile Iron Gravity Sewer Pipe
 - 3. ASTM D1330 – Standard Specification for Rubber Sheet Gaskets
- C. The Society for Protective Coatings Paint Application
 - 1. SSPC-PA-2 Procedure for Determining Conformance to Dry Coating Thickness Requirements

1.3 QUALITY ASSURANCE

- A. The manufacturer is responsible for the performance of all inspection requirements as specified in ANSI/AWWA and/or ASTM Standards. All pipe and fittings to be installed under this Contract may be inspected at the plant for compliance with these Specifications by the Owner, by an independent testing laboratory selected by the Owner, or by other representative of the Owner.
- B. Care shall be taken in shipping, storing, handling, and laying to avoid damaging the pipe and fittings. Any pipe or fittings damaged in these activities shall be replaced or cut off or repaired as directed solely by the Engineer.
- C. Inspection of the pipe and fittings will be made by the Engineer or other representative of the Owner after delivery and after installation. The pipe shall be subject to rejection at any time on account of failure to meet any of the Specification requirements even though pipes may have been accepted as satisfactory at the place of manufacture. Pipe rejected after delivery shall be marked for identification and shall be removed immediately from the work site.
- D. Any pipe or fitting showing a crack, indentation, or other obvious damage to the metal shall be marked by the Engineer as rejected shall be removed immediately from the work site. Pipe damaged on the spigot end may, if approved by the Engineer, be cut off and the end re-prepared and the shorter pipe used. The Engineer's opinion on such observations and rejections shall be final.
- E. The pipe materials specified in this section shall be furnished by a manufacturer who is fully experienced, reputable, and qualified in the manufacturing of the specified materials. The manufacturer shall have successfully manufactured and delivered pipe of the diameters used in this project the general intent of this specifications for a minimum of 15 projects over the past 5 years.

1.4 INSPECTION, TEST REPORTS, MARKINGS, AND SUBMITTALS

- A. All pipe and fittings to be installed under this Contract shall be inspected and tested at the place of manufacture by the manufacturer to verify compliance with the Specifications.
- B. Pipe shall be subject to inspection and approval at the factory, place of coating, point of delivery, and before and after installation as specified above. The Engineer shall have the right to reject any pipe whose manufacture, in his sole opinion, is inconsistent with the Specifications and to take independent samples of the materials being used at any time.
- C. The manufacturer shall perform factory testing as specified herein and in accordance with the standards. Copies of test reports shall be submitted to the Engineer before the pipe is shipped to the site.
- D. In the event any of the test results fail to meet the Specifications, all pipe represented by such tests shall not be shipped to the job site and shall be subject to rejection. The Contractor may perform additional tests from the pipe represented by the failed tests if he desires to verify the inadequacy of the original tests. The Engineer will review the test results and advise on the suitability of the pipe.

- E. Pipe which has been rejected by the Engineer shall not be shipped to the site or shall be removed from the site of the work by the Contractor and replaced with pipe which meets these Specifications.
- F. All pipe and fittings shall be stenciled in durable white paint on opposite exterior sides or coded with the following information:
 - 1. Manufacturer name or trademark.
 - 2. Date and place of manufacture.
 - 3. Size, type, thickness or class, and wall thickness.
 - 4. Standard produced to (ANSI/AWWA).
 - 5. Other markings as required by standard.

1.5 DELIVERY, STORAGE AND HANDLING

- A. Care shall be taken in loading, transporting, and unloading to prevent injury to the pipe or coatings. Under no circumstances shall the pipe be dropped or skidded against each other. Slings, hooks, or pipe tongs shall be padded and used in such a manner as to prevent damage to the exterior surface or internal coating or lining of the pipe.
- B. Stored pipe shall be kept safe from damage and away from traveled ways. The interior of all pipes, fittings and other appurtenances shall be kept free from water, dirt, or foreign matter at all times.
- C. Stored pipe shall not be placed on the ground or in contact with another or stacked. The bottoms shall be kept off the ground on plastic film and timbers, rails, or concrete. Pipe shall be chocked. At least 4- by 4-inch timbers shall be placed on each side of each pipe in order to prevent movement.

PART 2 - PRODUCTS

2.1 DUCTILE IRON PIPE (DIP)

- A. Pipe shall comply with ASTM A746 and ANSI A21.50, ANSI/AWWA C151/A21.51 and shall be Pressure Class 350 unless otherwise noted meeting the size and dimensions shown on the drawings. Pipe shall be furnished with push-on, mechanical or flanged joints, as indicated.
- B. Mechanical and Push on joints shall conform to ANSI/AWWA C111/A21.11. When required or necessary, use approved type joint restrain devices with a minimum working pressure of 200 psi and a factor of safety of 2.
- C. Rubber gaskets shall conform to ANSI A21.11 and AWWA C111 for mechanical and push-on type joints. Natural rubber will not be accepted.
- D. Flanged Joints shall conform to ANSI/AWWA C115/A21.15. Bolts per ASTM A307, chamfered or rounded ends projecting 1/4 to 1/2 inch beyond outer face of nut. Nuts per ASTM A307, hexagonal, ANSI/ASME B18.2.2, heavy semi-finished pattern. Gaskets per ASTM D1330, Grade I rubber, full face type, 1/8-inch thick.

- E. Fittings shall meet the requirements of ANSI/AWWA C110/A21.10 or ANSI/AWWA C153/A21.53. Fittings and Specials shall be manufactured of ductile iron and rated as a minimum to equal the pressure rating of the pipeline. Ductile iron tees or wyes for service laterals shall meet the requirements of this Specification section. Fittings shall have joints compatible with the pipe with which it is to be connected.
1. Fittings for piping 6-inches and above shall be mechanical joint (MJ), domestic manufacture with interior lining as specified in paragraph 2.1.F. Provide transition gaskets in conformance to AWWA C111/A21.11 to accommodate the transition from MJ to SDR-26. Fittings on the 6-inch lateral to accommodate pipe bends and alignment to the existing service laterals shall conform to Section 02732.
- F. Interior Lining: Unless stated otherwise on the plans, the interior of all ductile iron pipe and fittings shall be coated with Tnemec 431 per manufacturer's specifications and in accordance with AWWA C210. All field touchups to be completed per manufacturer's specifications. The epoxy lining shall be applied to a minimum 40 mils dry film thickness and shall cover the entire inside of the pipe.
1. The epoxy lining shall be applied only by a firm certified as an applicator by the epoxy manufacturer. Application of the epoxy lining to the ductile iron pipe shall be in strict accordance with the epoxy manufacturer's specifications and installation procedures. All pipe linings shall be checked for thickness using a magnetic film thickness gauge. The thickness testing shall be done using the method outlined in SSPC-PA-2 film thickness testing. The barrel of all pipe and fittings shall be pinhole detected with a non-destructive 2,500-volt pinhole test. Each pipe joint and fitting shall be marked with the date of application of the lining system and with its numerical sequence of application on that date. The pipe or fitting manufacturer must supply a certificate attesting to the fact that the Applicator met the requirements of this specification, that the material used was as specified, and that the material was applied as required by the specification.
 2. All pinholes and damaged lined areas shall be repaired in accordance with written repair procedures furnished by the manufacturer of the lining material so that the repaired area is equal in performance to the undamaged lined areas.
- G. Lined pipe and fittings must be handled only from the outside of the pipe and fittings. The pipe shall not be dropped or unloaded by rolling. Care should be taken to not let the pipe strike sharp objects while swinging or being off loaded. Ductile iron pipe should never be placed on grade by use of hydraulic pressure from an excavator bucket or by banging with heavy hammers.
- H. Exterior of all pipe fittings and specials shall be coated with asphaltic coating in accordance with ANSI/AWWA C151/A21.51.
- I. Bolts, nuts, gaskets and any other material needed for the complete installation of all pipe joints shall be furnished.

2.2 RESTRAINED JOINT DUCTILE IRON PIPE

- A. Pipe shall comply with all paragraphs of Section 2.1 and shall be furnished with mechanical joints.

2.3 DUCTILE IRON EXPANSION JOINTS

- A. Provide ductile iron expansion joints per approved materials list.

PART 3 - EXECUTION

3.1 GENERAL

- A. Ductile iron pipe shall be installed in accordance with AWWA C600 latest edition. If there is conflict, the manufacturer's instructions shall take precedence.
- B. Pipe shall be laid with beginning at the bottom of the slope and proceed upward with the bell ends of the new pipe upslope. The plain end shall be installed into the bell end until the reference point on the pipe.
- C. The joint surfaces shall be cleaned and lubricated and the plain end of the pipe shall be aligned with the bell of the pipe to which it is to be joined and pushed home. After joining the pipe, a metal feeler shall be used to make certain that the rubber gasket is properly seated.
- D. Bedding shall be as shown on the detail drawings for gravity sewer.

END OF SECTION

THIS PAGE INTENTIONALLY LEFT BLANK

SECTION 02733
SANITARY SEWER SERVICE CONNECTIONS

PART 1 - GENERAL

1.1 SCOPE

- A. Work in this section consist of the supply and installation of service connections from sanitary sewer collector lines to each dwelling, commercial building and/or residential or industrial lot in the area unless designated by the Engineer to the contrary.
- B. Related Work.
 - 1. Section 02221 Trench Excavation, Bedding and Backfill
 - 2. Section 02730 Sanitary Sewer Systems
 - 3. Section 02731 Ductile Iron Sewer Pipe
 - 4. Section 02732 Polyvinyl Chloride Sewer Pipe
- C. The Contractor shall contact property owners whenever feasible and cooperate with the property owner in the placement of the service unless otherwise directed by the Engineer or Owner's representative.
- D. Unless otherwise noted on the drawings or instructed by property owner or Engineer, service connections for vacant lots shall be extended to the property line and shall terminate on the property at a minimum distance of five (5) feet upgrade of the low property corner.
- E. The Contractor shall be responsible for locating existing service lines and coordinating reconnection locations that provide the best gravity sewer solution with the Engineer and/or Owner. Reconnection of existing services shall be performed after sanitary sewer collector lines have been completed, tested and accepted.

1.2 SUBMITTALS

- A. Submit product data for all service pipe and fittings.
- B. Drawings showing the location of service connections properly referenced sewer line station numbers shall be prepared as the work progresses.

1.3 QUALITY ASSURANCE

- A. Comply with all applicable standards contained herein and with the provisions of the following codes and standards except as otherwise shown or specified.
 - 1. South Carolina Department of Health and Environmental Control: All applicable rules and regulation.
 - 2. All requirements of the sewer service agency that will own, operate and maintain this sewer.

1.4 REFERENCE STANDARDS

- A. American Society for Testing and Materials (ASTM):
 - 1. ASTM D3034 – Type PSM PVC Sewer Pipe and Fittings.
 - 2. ASTM F949 – Standard Specification for Poly(Vinyl Chloride) (PVC) Corrugated Sewer Pipe With a Smooth Interior and Fittings

PART 2 - PRODUCTS

2.1 SERVICE PIPE

- A. Tee-wyes for service connections to mainline carrier pipe shall be either PVC or DIP. DIP shall be used when the main line pipe material is either vitrified clay pipe (VCP) or DIP.
- B. PVC and fittings shall be SDR-26 pipe meeting all requirements of ASTM D3034, latest edition. Tee-wyes on ribbed PVC pipe shall have SDR-26 branches and meet all requirements of ASTM F949, latest edition.
- C. DIP tee-wyes shall meet all requirements of Specification Section 02731.

PART 3 - EXECUTION

3.1 GENERAL

- A. The service shall be placed to a minimum grade of 1% and shall be left low enough to give basement service to the building to be served and placed low enough to give a minimum of 2'-0" cover in piping to the building unless otherwise designated by the Engineer.
- B. Failure on the part of the Contractor to place the service to the grades specified shall make the Contractor liable for paralleling the lateral sewer to a point where grade can be met.
- C. Tee-wyes are to be placed on the sewer main and services installed during installation of the lateral sewer. Saddles are not acceptable.
- D. Service connection to manholes shall be installed with inverts and benches to prevent solids deposition in manhole.

3.2 INSPECTION AND TESTING

- A. Service laterals shall be tested in accordance with Section 02730. For services being reconnected, Contractor shall test lateral prior to reconnection to existing service.

END OF SECTION

SECTION 02800
SEWER LINE CLEANING

PART 1 - GENERAL

1.1 SCOPE OF WORK

- A. Clean all sewer pipe to be inspected using closed circuit television (CCTV), and as specified, defined or directed by Engineer. Furnish all labor, materials, equipment and incidentals required to clean all sewer pipe as required and directed by Engineer.
- B. Cleaning shall include proper high pressure water jetting, rodding, bucketing, brushing, and flushing sewers and manholes prior to inspection by CCTV, pipeline rehabilitation or replacement, point repairs, manhole rehabilitation, and testing operations. It shall also include traffic control, water used for jetting as appropriate, debris dewatering, removal and proper disposal of debris, and root cutting as necessary.
- C. Cleaning may involve hydraulic light sewer cleaning (small amounts of debris or deposits settled and/or light root growth existing within the sewer line) or mechanical heavy sewer cleaning (large amounts of debris, grease, attached deposits, large size stones and bricks, and/or heavy root growth existing within the sewer line). Cleaning shall dislodge, transport and remove all sludge, mud, sand, gravel, rocks, bricks, grease, roots, sticks, and all other debris from the interior of the sewer pipe and manholes.
- D. Hydraulic light sewer cleaning shall be paid for under the appropriate CIPP lining, point repair, pipe bursting, or manhole rehabilitation item in the Schedule of Prices. Mechanical heavy sewer cleaning and heavy root removal shall be paid for under the Mechanical Heavy Sewer Cleaning/Root Removal item in the Schedule of Prices.
- E. The goal of the cleaning is to remove all debris, roots, deposits, and other blockages to a 95 percent minimum open area so the rehabilitation can be successfully installed without any significant installation issues or post defects. On all sewers, perform sewer cleaning work to an acceptable level as necessary to perform a thorough CCTV inspection of the sewer main. If the pipe condition is such that cleaning may cause a potential collapse, the pipe shall be CCTV'd without attempting to clean it to the 95 percent condition, pending approval by Engineer.
- F. Root cutting or sawing may be deemed necessary and should be brought to that attention of the Owner/Engineer. If deemed necessary by the Owner, root cutting shall be paid for separately under the Mechanical Heavy Sewer Cleaning/Root Removal item in the Schedule of Prices.
- G. If access to private property is required to perform the work the contractor must determine access prior to starting. Clearing and other costs related to gaining access (including restoration) should be included in contractor's pricing.
- H. Any access to private property must be approved by the homeowner prior to starting work.

- I. Contractor to assume responsibility for relocating sheds if such relocation is required to perform work. The final location of the shed will be determined on a case by case basis, in cooperation with the Property Owner.
- J. Fences to be replaced in kind and a gate should be placed along the easement to allow future access by Owner forces and equipment. Each of these will be determined on a case by case basis directly with the Property Owner and Contractor.
- K. Contractor shall include site restoration including irrigation line repairs, driveway restoration, shrubbery replacement, etc. when choosing a route of access/repair. The Contractor shall be fully responsible for all damages caused on public or private property. The Contractor shall restore all disturbances to pre-existing conditions or better.

1.2 RELATED WORK

- A. Measurement and Payment is specified in Section 01025.
- B. Sanitary Sewer CCTV Inspection is specified in Section 02801.
- C. Database Template Description PACP is specified in Section 02802.
- D. Cured-in-place Pipe Lining is specified in Section 02803.
- E. Cured-in-place Pipe Lining UltraViolet Cured is specified in Section 02804
- F. Sewer Service Lateral CIPP Lining is specified in Section 02806.
- G. Manhole Lining is specified in Section 02807.
- H. Pipe Bursting is specified in Section 02850.
- I. Sanitary Sewer Flow Control is specified in Section 02860.

1.3 SUBMITTALS

- A. Submit a Traffic Control Plan to the Owner's Representative. Traffic Control Plan shall be in accordance with Section 01570.
- B. Confined space entry plan, certifications and hazardous atmosphere training certifications, if applicable.
- C. The work described in this Scope of Work, including any internal sewer or manhole inspections, shall meet the minimum requirements as presented in the OSHA Standard, Title 29 CFR 1910.146, Permit Required Confined Spaces. Upon commencement of the Work, copies of all confined space entry permits shall be submitted to Engineer. Contractor shall notify the Owner or delegated representative each day by phone, email or fax when it is necessary for Contractor to enter a manhole(s). Contractor shall identify all manholes that Contractor plans on entering that day by street location and manhole number.

- D. Contractor to complete a work summary sheet each month by Asset ID, electronically in Excel format, documenting what was cleaned that month for each asset. This shall be submitted on a monthly basis along with the pay application to the Owner. A copy of the template will be provided upon request.

1.4 NOTIFICATIONS

A. Notify the Engineer:

1. On a weekly basis of scheduled work for the upcoming week by asset ID, including a map showing the area of work, and a map and list of fire hydrants that will be utilized for a water source, and a list of streets being affected. Submittal shall be provided by electronic mail in PDF format. Provide 24-hour notice for deviations from the plan that are not caused by weather or natural causes.
2. Water for use on this project will be available from selected hydrants owned and operated by the governing potable water providers. Contractor is responsible for obtaining all associated permits, paying the requisite fee and notifying the governing potable water providers.
3. Immediately, when a collapsed pipe or other pipe failure is identified.
4. Immediately, if the conditions for the work described are found to be unsafe or impractical.
5. Immediately, if a manhole is buried, cannot be found or cannot be accessed. Along with the manhole identification number, provide a map (in PDF format) showing the location of the manhole and its asset ID, and what procedures were used to attempt to locate the manhole.
6. Immediately of any defects posing imminent danger to the public (missing lids, covers broken during inspection, sink holes, etc.) and any observed pipe blockages, surcharging, or potential overflow conditions.
7. If the pipe configuration in the field is different than shown, or if a new asset is found, the notification shall include a diagram clearly indicating the location of structures in relation to immediately adjacent structures in PDF format via electronic mail.
8. If any obstructions are found within the easement, even if not impacting work.

B. Notify the public and coordinate with homeowners:

1. Contractor shall prepare and install yard signs to notify customers in the area of work being conducted and who to contact for information. The city-approved Columbia Water yard sign file will be provided by City. This file is the standard sign layout to be filled in with project specific information. (Sign specs: digital print full color two-sided coroplast 4mm 18"x24" & metal step stakes 30"x10").
 - a. Approximately 25 signs are anticipated to be required.
 - b. Signs shall be placed in key intersections and at the project site, incoming/outgoing roads to the area/neighborhood, and intersections near the site at start of project.
 - c. Signs shall be placed in yards a minimum of 7 days prior to work but no more than 14 days ahead of scheduled work.
 - d. Signs shall be displayed throughout scheduled work and will be replaced if removed or damaged.
 - e. Signs shall be removed at the conclusion of the project.

2. A minimum of 72 hours prior to the inspection or work on any manhole, cleanout, service lateral, or line segment, distribute door-to-door an Owner approved Homeowner Notification door hanger describing the work to be performed with date and projected time, if work is performed or accessed through private property or easement adjacent to property, or if the property is potentially tied to the section of line being inspected or worked on. On the day of work and prior to beginning the work, knock on the doors of all properties that will require entering their private property to access the manholes, cleanouts, or pipes which will potentially be impacted by the work and notify occupants of the work to be performed.
3. Contractor shall use approved magnetic car signs affixed to vehicles at all times during the project to identify affiliation with the the Owner. Contractor's personnel shall also wear Owner issued safety vests. Contractor responsible for determining route of access for the proposed work, unless specified otherwise, and is responsible for coordinating with the Property Owner to obtain any temporary access to perform the work.
4. Contractor to notify Property Owner of any that all trees or other obstructions within easements that need to be moved to access or perform the work. The Property Owner shall be given a minimum of 7 days to relocate the obstruction off of the easement at their own cost to their own chosen location. After this time period, the Contractor shall be responsible for removing and disposing of the obstruction, and all costs associated with this. Contractor to coordinate with the Engineer on each obstruction found before proceeding.

PART 2 - PRODUCTS

2.1 CLEANING MATERIALS AND EQUIPMENT

A. Hydraulically propelled Sewer Cleaning Equipment.

1. Hydraulically propelled sewer cleaning equipment shall be the movable dam type constructed such that a portion of the dam may be collapsed during cleaning to prevent flooding of the sewer.
2. The movable dam shall be the same diameter as the pipe being cleaned and shall provide a flexible scraper around the outer periphery to ensure total removal of grease.
3. Contractor shall take precautions against flooding prior to using sewer cleaning balls or other such equipment that cannot be collapsed instantly.

B. High Velocity Hydro-Cleaning Equipment shall have the following:

1. A minimum 500-foot high pressure hose.
2. Two or more high velocity nozzles able to produce a scouring action from 15 to 45 degrees in all size lines to be cleaned.
3. A high velocity gun for washing and scouring manhole walls and floor.
4. Capability of producing flows from a fine spray to a long distance solid stream.
5. A water tank, auxiliary engines and pumps and a hydraulically driven hose reel.
6. Equipment operating controls located above ground.

C. Mechanical heavy cleaning equipment shall be either power buckets or power rodders. Mechanical equipment can only be utilized with approval of Engineer and after the structural condition of the pipe has been verified by the Contractor and Contractor has indicated that jetting

will not be sufficient to perform the cleaning and mechanical cleaning will not further damage the pipe.

1. Bucket machines shall:
 - a. Be furnished with buckets in pairs and with sufficient dragging power to perform the work efficiently.
 - b. Use V-belts for power transmission or have an overload device. No direct drive machines will be permitted.
 - c. Be equipped with a take up drum and a minimum 500-foot cable.
2. Power rodding machine shall:
 - a. Be either sectional or continuous.
 - b. Hold 750 feet minimum of rod.
 - c. Have rods made from treated steel.
 - d. Be fully enclosed and have an automatic safety throw out clutch.

PART 3 - EXECUTION

3.1 PERFORMANCE

- A. Cleaning Precautions: During sewer cleaning operations, satisfactory precautions shall be taken when using cleaning equipment.
 1. When hydraulically propelled cleaning tools (which depend on water pressure to provide their cleaning force) or tools which retard the flow in the sewer line are used, precautions shall be taken to ensure the water pressure created does not damage or cause flooding of public or private property being served by the sewer.
- B. Sewer Cleaning:
 1. Cleaning equipment selection shall be based on the conditions of lines at the time the work commences.
 2. The equipment and methods selected shall be satisfactory to the Engineer.
 3. The equipment shall be able to remove dirt, grease, rocks, sand, and other materials and obstructions from the sewer lines and manholes.
 4. If cleaning of an entire section cannot be successfully performed from one manhole, the equipment shall be set up on the other manhole and cleaning again attempted. If successful cleaning still cannot be performed or the equipment fails to traverse the entire manhole section, it will be assumed a major blockage exists, and the Engineer shall be immediately notified. The cleaning effort shall be repeated with other equipment types.
 5. The goal of the cleaning is to remove all debris, roots, deposits and other blockages to a minimum of 95% open area. On all sewers, Contractor shall perform sewer cleaning work to an Owner acceptable level. If the pipe condition is such that cleaning may cause a potential collapse, then the Contractor shall immediately contact the Engineer.
- C. Selection of cleaning equipment shall be based on the conditions of the manholes and sewer lines at the time the work commences.

1. Light hydraulic cleaning (small amounts of debris existing within the sewer line):
 - a. Use balls, scooters, high pressure water jetting equipment, brushes, and swabs.
 - b. “Light hydraulic Cleaning” will be defined and managed as follows:
 - 1) Sewer reaches which do not require mechanical heavy cleaning, as defined below, and all cleaning up to and including five (5) passes of high pressure water jetting. If, after five (5) passes of high-pressure water jetting, the sewer is still not clean, the Contractor shall inform the Engineer of the condition and the reason(s) for the failure to fully clean the line. The Engineer may then direct the Contractor to perform heavy cleaning of the problem section of sewer.
 - 2) Costs related to light hydraulic cleaning such sewers shall be included in the Contractor’s unit price for the appropriate CIPP Lining item in the Schedule of Prices. Costs related to light hydraulic cleaning of pipeline rehabilitation or replacement, point repairs, or manhole rehabilitation shall be included in the appropriate rehabilitation/replacement bid item in the Schedule of Prices.
2. Mechanical heavy cleaning (large deposits and/or encrustations of debris, grease, heavy silt settlement or heavy root growth existing within the sewer line) will be defined and managed as follows:
 - a. Use bucket machines, scrapers, hydraulic pressure jetting with special aggressive root cutting nozzles, or tools and augers. Cleaning requiring more than five (5) passes with hydraulic cleaning equipment to achieve acceptable results shall be considered heavy cleaning.
 - b. Mechanical heavy cleaning will be conducted only with approval and direction of the Engineer. “Mechanical Heavy Cleaning” is managed as follows:
 - 1) Sewer reaches requiring debris removal for depths larger than 25 percent of the pipe height and requires more than five (5) passes with the jetter to sufficiently remove the debris and other deposits and/or obstructions from the sewer line. Sewer reaches requiring root removal for lengths up to 25 percent of the pipe segment and requires more than five (5) passes with the jetter to sufficiently remove the roots.”
 - 2) Costs related to the cleaning of such sewers shall be included in Contractor’s unit price for Heavy Sewer Cleaning/ Root Removal in the Schedule of Prices.
 - 3) Compensation for heavy cleaning a particular line will only be paid if at least one of the following apply:
 - a) The Engineer authorized the heavy cleaning prior to Contractor performing the work. The Contractor shall obtain a written signature from the Owner or Owner’s representative agreeing to the terms, prices, and lengths of the heavy cleaning. A Daily Heavy Cleaning Log shall be kept and signed by the Owner’s inspector verifying that the cleaning performed meets the requirements/definition of heavy cleaning as defined in these specifications.

- b) Contractor proves that both significant time AND effort were necessary to clean the line. Video proof of heavy cleaning must be obtained by acquiring a “before” video of all accessible portions of the obstructed reach and submitting that to Engineer along with the completed inspection. A submerged camera does not justify a need for heavy cleaning; proof that the submergence was due to a blockage and/or heavy debris and not a sag in the line will be required.
3. Contractor shall clean these pipes to the standards listed above. Upon completion of the cleaning, each sewer line shall be CCTV'd to assess the condition of the sewer pipe and to confirm that it meets the standards of cleanliness listed above. Mechanical heavy cleaning will be paid for only if these standards are met. Mechanical heavy cleaning will be paid for on a linear foot basis only for the length required to be cleaned, not the entire length of pipe, unless otherwise agreed to be paid for before performing the work in writing.
 - D. Contractor shall provide appropriate screening to stop materials from passing into downstream sewers. All solid or semisolid materials dislodged during cleaning operations shall be removed from the sewer by the Contractor at the downstream manhole in the sewer section being cleaned. These materials shall become property of the Contractor, shall be removed from the site at the end of each workday, and shall be properly disposed of in a lawful manner by Contractor. Passing dislodged materials downstream from the sewer segment being cleaned shall not be permitted. In such an event, as observed or detected by the Owner, Engineer, or any third party, the Contractor shall be responsible for cleaning the affected downstream sewers in their entirety, at no additional cost to Owner.
 - E. Use properly selected equipment to remove all dirt, grease, rock, and other deleterious materials and obstructions.
 - F. Protect existing sewer lines from damage caused by improper usage of cleaning equipment. Contractor is solely responsible for the operations and for preventing sewer backups into area homes and causing sewage overflow. Contractor is solely responsible for all damages resulting from operations.
 - G. Take precautions to avoid damage or flooding to public or private property being served by the line being cleaned.
 - H. Disposal of Material:
 1. Remove from the site and properly dispose of all solids or semi-solids recovered during the cleaning operation. No solids shall be allowed to re-enter the sanitary sewer system. The Contractor shall be responsible for properly disposing of all collected material at their expense. Specifics regarding the scheduling, monitoring, disposal fees (if any) and approved methods and procedures for disposal are the Contractor's responsibility and shall comply with all County, State and Federal regulations.
 - I. No sewer cleaning shall take place in a particular sewer segment until all upstream pipe segments have been cleaned. If cleaning is performed in a downstream pipe segment to facilitate overall cleaning operations, the segment shall be re-cleaned at no additional cost, after all pipes upstream of that segment have been cleaned.

3.2 FIELD QUALITY CONTROL

- A. Acceptance for this work portion shall depend on the results from the CCTV inspection. The goal of cleaning is to remove all necessary debris, roots, and deposits sufficiently to inspect the pipeline and provide at least 95% percent open area of the pipeline so the rehabilitation can be successfully installed without any significant installation issues or defects due to cleaning quality. Sewers that are not sufficiently clean as to permit CCTV inspection shall be re-cleaned and re-inspected at no additional cost to the Owner.
- B. Upon cleaning acceptance, restore the project area affected by the operations to a condition at least equal to that existing prior to the work.

PART 4 - CLOSEOUT

- 4.1 Contractor shall confirm that the previous Monthly Work Summary Sheets are 100-percent complete, accurate, and submitted to the Engineer during the Monthly Project Update Meetings and prior to approval of payment.

END OF SECTION

SECTION 02801
SANITARY SEWER CCTV INSPECTION

PART 1 - GENERAL

1.1 SCOPE OF WORK

- A. The Work covered by this section includes furnishing all labor, competent certified technicians, equipment, tools, accessories, materials and incidentals required to closed-circuit television (CCTV) inspect the designated sanitary sewer lines specified, including all pipe segments to be rehabilitated.
- B. Prior to completing any CCTV work, all sewers shall be cleaned as specified in Section 02800.
- C. CCTV inspection of sanitary sewers as follows:
 - 1. CCTV all main lines proposed for rehabilitation and all laterals proposed for CIPP rehabilitation, as well as any other lines called for CCTV in the contract documents.
 - 2. All CCTV work shall conform to version 7 NASSCO Pipeline Assessment Certification Program (PACP®) standards.
 - 3. Contractor shall use a NASSCO Pipeline and Assessment Certification Program (PACP®) certified operators and GraniteNet software by CUES. CCTV inspections (video and data collected) shall be delivered entirely in digital format. Data files shall be formatted to facilitate upload into a NASSCO (version 7) certified CCTV software package.
- D. If access to private property is required to perform the work the contractor must determine access prior to starting.
- E. Any access to private property must be approved in writing by the homeowner prior to starting work. Upon request, the Owner shall be provided copies of these homeowner approvals prior to entry.
- F. Contractor to assume responsibility for relocating sheds if such relocation is required to perform work. The final location of the shed will be determined on a case by case basis.
- G. Fences to be replaced in kind and a gate should be placed along the easement to allow future access by Owner forces and equipment. Each of these will be determined on a case by case basis directly with the Property Owner and Contractor.
- H. Contractor shall include site restoration including irrigation line repairs, driveway restoration, shrubbery replacement, etc. when choosing a route of access/repair.

1.2 REFERENCES

- A. Where materials and methods are indicated in these specifications as being in conformance with a standard specification, it shall refer to the latest edition of the specifications and shall include all interim revisions. Listing a standard specification without further reference indicates the particular material or method shall conform to such listed specification.

1. National Association of Sewer Service Companies (NASSCO):
 - a. Pipeline Assessment and Certification Program (PACP®) Reference Manual.
 - b. Recommended Specifications for Sewer Collection System Rehabilitation Standard (2006).

1.3 RELATED WORK

- A. Measurement and Payment is specified in Section 01025.
- B. Sewer Line Cleaning is specified in Section 02800.
- C. Sanitary Sewer CCTV Inspection is specified in Section 02801.
- D. Database Template Description PACP is specified in Section 02802.
- E. Cured-in-place Pipe Lining is specified in Section 02803.
- F. Sewer Service Lateral CIPP Lining is specified in Section 02806.
- G. Manhole Lining is specified in Section 02807.
- H. Pipe Bursting is specified in Section 02850.
- I. Sanitary Sewer Flow Control is specified in Section 02860.

1.4 SUBMITTALS

- A. Submit a Traffic Control Plan to the Owner's Representative (Engineer) in accordance with Section 01570.
- B. Confined space entry plan, certifications and hazardous atmosphere training certifications for all staff engaged in activities within or near the open structures, if applicable.
- C. Prior to beginning work, submit to the Engineer certification of the NASSCO PACP Program for all CCTV operators that will be working and performing this inspection work on the project. Contractor shall not commence work until such certification is provided. Submit 2 copies of the NASSCO issued identification card and PACP certification number.
- D. The work described in this Scope of Work, including any internal sewer or manhole inspections, shall meet the minimum requirements as presented in the OSHA Standard, Title 29 CFR 1910.146, Permit Required Confined Spaces. Upon commencement of the Work, copies of all confined space entry permits shall be submitted to Engineer. Contractor shall notify the Owner or delegated representative each day by phone, email or fax when it is necessary for Contractor to enter a manhole(s). Contractor shall identify all manholes that Contractor plans on entering that day by street location and manhole number, prior to entry.
- E. Contractor shall submit to Engineer for Owner's review and approval, sample videos and photographs at the beginning of the project that shows no less than 20 line segments within the work area. Submitted videos will be reviewed to determine expected quality of data. All data

shall be submitted referencing the pipe and manhole asset identifier codes approved by the Owner and described herein.

- F. Final sewer inspection reports, digital videos/photographs and data shall be submitted in accordance with the requirements of this specification.

1.5 QUALITY ASSURANCE

A. Qualifications:

1. Contractor: Performed work successfully for at least three other projects, within last 5 years, with at least 500,000 linear feet and the CCTV operator shall be PACP certified and have at least 250,000 linear feet of CCTV experience in NASSCO PACP format.
2. Crew Chief: Minimum 5 years of experience on projects similar to this Project. PACP certified, and experienced using proposed equipment for this Project.

1.6 NOTIFICATIONS

A. Notify the Owner and Engineer:

1. On a weekly basis of scheduled work for the upcoming week, including a map showing the area of work, and a list of streets being affected. Submittal shall be provided by electronic mail in PDF format. Provide 24-hour notice for deviations from the plan that are not caused by weather or natural causes.
2. Immediately, when a collapsed pipe or other pipe failure is identified.
3. Immediately, if the conditions for the work described are found to be unsafe or impractical.
4. Immediately, if a manhole is buried, cannot be found or cannot be accessed. Along with the manhole identification number, provide a map (in PDF format) showing the location of the manhole and what procedures were used to attempt to locate the manhole.
5. Immediately of any defects posing imminent danger to the public (missing lids, covers broken during inspection, sink holes, etc.) and any observed pipe blockages, surcharging, or potential overflow conditions.
6. If the pipe configuration in the field is different than shown or if a new asset is found, the notification shall include a diagram clearly indicating the location of structures in relation to immediately adjacent structures in PDF format via electronic mail.
7. If any obstructions are found within the easement, even if not impacting work.

B. Notify the public and coordinate with business owners:

1. A minimum of 72 hours prior to the inspection or work on any manhole, cleanout, service lateral, or line segment, the contractor shall distribute door-to-door an Owner approved Work Notification door hanger describing the work to be performed, if work is performed or accessed through private property or easement adjacent to property, or if the property is potentially tied to the section of line being inspected or worked on. On the day of work and prior to beginning the work, the contractor shall knock on the doors of all properties that will require entering their private property to access the manholes, cleanouts, or pipes which will potentially be impacted by the work and notify occupants of the work to be performed.

2. Contractor shall notify Property Owner of any that all trees or other obstructions within easements that need to be moved to access or perform the work. The Property Owner shall be given a minimum of 7 days to relocate the obstruction off of the easement at their own cost to their own chosen location. After this time period, the Contractor shall be responsible for removing and disposing of the obstruction, and all costs associated with this. Contractor to coordinate with the Engineer on each obstruction found before proceeding.

PART 2 - PRODUCTS

2.1 TELEVISION INSPECTION EQUIPMENT

- A. Contractor shall furnish all labor, materials, machinery, equipment and incidentals required to perform thorough cleaning and CCTV of the assigned sewers within the study area as specified herein and in Section 02800.
- B. Provide a mobile vehicle with video monitoring equipment specifically compatible with the camera equipment being used. The vehicle shall be large enough to accommodate at least three people at any time for viewing of the monitor. Owner and Engineer shall have unrestricted access to observe the television screen and all other operations at all times.
- C. Contractor shall ensure equipment utilized for CCTV of main lines and to reinstate service laterals is capable of passing through offset joints up to 1 inch minimum.
- D. Equipment must be adaptable to be able to locate assets that are buried if needed.
- E. The television camera used for the inspection shall be one specifically designed and constructed for such inspection. Adjustable light source to allow an even distribution of lighting for the camera shall be suitable to allow a clear color picture of the entire periphery of the pipe. The camera shall be capable panning 360° and tilting 270° to facilitate the inspection of all laterals and defects, with optimum picture quality provided by focus and iris adjustment. The camera, television monitor, and other components of the video system shall be capable of producing a minimum 460-line resolution picture. A backup camera shall be readily available to cause no delay in schedule. The camera shall be operative in 100 percent humidity conditions. Camera shall be operative in a hazardous and corrosive environment. The camera shall be capable of zooming at least 10:1 for looking further down the pipe or up into the laterals.
- F. The camera, television monitor, and other components of the video system shall be capable of producing picture quality to the satisfaction of Engineer and/or Owner.
- G. The television inspection equipment shall have an accurate footage counter that shall display on the monitor the exact distance of the camera from the centerline of the starting manhole. Contractor shall, in the presence of inspector, calibrate the camera footage every week with above ground tape measure and simultaneous CCTV footage counter.
- H. The CCTV equipment shall include the most current version of PACP compliant software application and database referenced in these specifications, or as approved by the Owner.

PART 3 - EXECUTION

3.1 PREPARATION

- A. Prior to the inspection, Contractor shall use CCTV or other means to identify any significant blockages. If the upstream manhole is full of water due to a blockage, a reverse setup shall be done to locate the blockage if possible. Then the cleaning and CCTV inspection shall be performed. No additional payment will be made for reverse setups.
- B. Prior to inspection, the Contractor shall thoroughly clean the pipelines of debris, grease, roots, sediment, broken pipe, or other obstructions that could retard the movement of the television camera. This includes cleaning of the downstream pipe prior to CCTV operations. No cleaning equipment is allowed in the piping during CCTV operations. Precautions shall be taken to protect the sewer lines being cleaned from damage by the cleaning equipment. Contractor should perform cleaning in accordance with Specification Section 02800.
- C. Immediately after cleaning, the sewer line section shall be visually inspected by means of closed-circuit television to determine the condition of the line and to locate existing service connections. The inspection shall be done one manhole section at a time and the flow in the section being inspected will be suitably controlled as specified in Section 3.04.
- D. After rehab, replacement or repair, the sewer line section shall be visually inspected by means of closed-circuit television to determine the condition of the line and to locate existing service connections. The inspection shall be done one manhole section at a time and the flow in the section being inspected will be suitably controlled as specified in Section 3.04.
- E. Contractor is solely responsible for the operations and for preventing sewer backups into area homes and causing sewage overflow. Contractor is solely responsible for all damages resulting from operations.

3.2 CCTV INSPECTION

- A. Perform all CCTV inspection using personnel who are trained and certified (current standing) in the use of NASSCO's Pipeline and Assessment Certification Program (PACP®).
- B. Move the camera through the line in either direction (direction versus flow shall however be noted) at less than or equal to 30 feet per minute rate, stopping when necessary to permit proper documentation of the construction features and pipe condition. Manual winches, power winches, TV cable, and powered rewinds or other devices that do not obstruct the camera view or interfere with proper documentation of the sewer conditions shall be used to move the camera through the sewer line.
- C. When manually operated, winches are used to pull the television camera through the line, use telephones or other suitable means of communication set up between the two manholes of the section being inspected to ensure good communications between members of the crew.
- D. Obstructions that cause a stuck camera are the responsibility of the Contractor, and the retrieval of equipment or cameras is the responsibility of the Contractor and will be performed at the Contractor's expense.

- E. Adjust the camera height such that the camera lens is always centered in the pipe being televised. Prior to starting the camera down the line, a tape measure shall be placed at the pipe opening at the upstream manhole to clearly show/verify, on-screen, the pipe diameter of the section of pipe to be televised during the subsequent inspection.
- F. Video shall include overlay/text display. Each inspection start shall include overlay display of section details:
 - 1. Owner name
 - 2. Project name
 - 3. Contractor name
 - 4. Street name
 - 5. Date/Time of inspection
 - 6. Start Manhole ID / End Manhole ID
 - 7. Pipe material
 - 8. Pipe size
 - 9. Direction of video
 - 10. Weather or Flow level
- G. A constant display of the street name, start Manhole ID / end Manhole ID, date and distance shall appear on screen. Contractor shall move or remove overlay display accordingly so it does not interfere with the inspection review of a particular observation/defect. As an observation/defect is noted, a descriptive text display shall appear for a minimum of 4 seconds.
- H. At a minimum 70% of the pipe diameter shall be visible during CCTV inspection. Contractor shall implement bypass and/or plugging to meet the visibility requirements.
- I. Provide lighting system adequate for good quality pictures. A reflector in front of the camera may be required to enhance lighting in black pipe.
- J. Do not float the camera unless permitted by the Owner or their designated representative.
- K. The camera shall be stopped at all service laterals and pan such an angle that an internal view of the service lateral is available. Digital photographs shall be made of any service lateral or deficiency observed in the sewer line and the photograph itself shall contain a brief description of the issue. The descriptions shall also be noted in the inspection condition record within the database. Where other pipe deficiencies are noted, stop the camera to observe the condition, record information and take digital photographs. All digital photos shall be cataloged in the CCTV database and linked to the specific length along the inspection via linkage to the defect record in the database.
- L. The Contractor shall lateral launch (PREFERRED) or otherwise provide CCTV video (e.g. push-camera) to inspect conditions of all service laterals conveying to manholes or pipes identified for rehabilitation on the Drawings, and for laterals otherwise noted for rehabilitation on the Drawings. The Contractor shall obtain video which identifies whether each lateral contains defects, is abandoned or capped, combines multiple service lines, or otherwise requires rehabilitation. The Contractor shall, at minimum, obtain video and provide assessment of service lateral conditions to the property line or existing cleanout. The Contractor shall be responsible for verifying active customer connection and lateral condition prior to rehabilitation or determination of satisfactory service lateral conditions.

- M. If the data is available, the Owner will provide the Contractor information on the location of known active laterals and cleanouts; however, this list may not be interpreted as all-inclusive. The Contractor shall be responsible for verifying active customer service connection prior to rehabilitation. The Contractor shall compare the service connections from the CCTV video with above ground measurements at the approximate location of center of each house or building. Any discrepancies between the CCTV data and above ground measurements of laterals shall be brought to the attention of the Owner/Engineer for a determination of lateral reinstatements. If the Contractor discovers an error or addition to the list provided, the Contractor shall immediately notify the Engineer for additional investigation.
- N. Note in the PACP database the status of identified laterals as active or inactive, and other PACP database information required including location of each service lateral based on television inspection logs, accurate distance measured from the centerline of the starting manhole as well as the notation of where on the circumference of the pipe the service lateral connects, etc. See Specification Section 02802 for additional PACP Database Template information.
- O. Provide a complete television inspection for the upstream and downstream manholes. The CCTV operator shall pan and zoom up the manhole from the invert for each manhole, and obtain the best possible image of the manhole including cone and corbel sections and for each pipe connection within each manhole. The CCTV operator shall zoom in on each pipe connection so the photos capture the each pipe connection's size, location, and approximate elevation.

3.3 PASSAGE OF TV CAMERA

- A. It is the intent of the Scope of Work to inspect the full length of sewer between each manhole, but there may be occasions during the CCTV inspection of a sewer line section when the camera will be unable to pass an obstruction even though flow is continuing. If, during the inspection operation, the television camera will not pass through the entire pipe section, set up the CCTV equipment so that the inspection can be performed from the opposite manhole. No additional payment shall be made for reverse set-ups required due to an obstruction. Reverse setups shall be noted in the CCTV database submittal in a separate database field to indicate that the inspection was performed in the reverse direction of flow as specified in Part 4.
- B. CCTV videos shall be submitted in one continuous video section from manhole to manhole, and not in multiple files, unless specifically approved by Engineer and Owner. See Part 4 and Specification Section 02802 for file naming convention details and additional PACP database template information.
- C. The television camera shall travel through the lines using its own power, floating of CCTV is not allowed. The digital pictures taken of the entire inside periphery of the pipe shall be clear and visible. Picture quality and definition shall be to the satisfaction of Engineer, and if unsatisfactory, the equipment shall be removed and no payment made for the unsatisfactory inspection.
- D. See Specification 02800 for Sewer Line Cleaning Prior to CCTV and Rehabilitation Work.

3.4 SANITARY SEWER FLOW CONTROL

- A. CCTV inspection shall be done one sewer line section (i.e. manhole structure to manhole structure) at a time, and the flow in the section shall be suitably controlled.

- B. Sewer flow control procedures shall be performed in accordance with specification Section 02860.

3.5 SEWER INSPECTION SOFTWARE

- A. All inspections shall use software that is capable of providing complete survey reports in compliance with the most current version of NASSCO PACP software referenced in these specifications, or as specified by the Owner. Owner has no intent to specify which software the Contractor should use, but requires the submitted database to be fully compliant with PACP. No payment will be rendered for improperly formatted data.
- B. All NASSCO PACP mandatory fields and any additional available fields requested by the Owner or his representative shall be populated during the inspections. All reports and/or submittals shall adhere to NASSCO PACP/MACP Standards.
- C. The software shall maintain a database of underground pipe and manhole assets referencing the pipe and manhole structure asset identifier codes provided in GIS format by the Owner. The pipe segment information shall be entered prior to the actual survey based on the numbering convention provided by the Owner. Surveys for pipes found not to be included in the Owner's GIS database will be numbered per Part 4. The software shall also have the capability to import and export survey results in the current NASSCO PACP Exchange digital format and to manage the database to meet the specifications in Part 4 herein.

PART 4 - DELIVERABLES

4.1 DIGITAL DATA DELIVERY

- A. Contractor shall submit in electronic format digital videos, digital photographs, evaluation reports, and databases in NASSCO PACP Exchange format version 6 to Engineer. Please consult with the Owner before proceeding if a more recent version is currently available to determine if the more recent version should be utilized.
- B. If digital videos are of such poor quality that Engineer is unable to evaluate the condition of the sanitary sewer main, locate the sewer service connections, or verify the cleaning Contractor shall be required to re-televiser the sanitary sewer and provide new digital videos of good quality, at no additional cost to Owner.
- C. All digital videos and data shall become the property of Owner.

4.2 DATA DELIVERY REQUIREMENTS

- A. All data submittals shall include a standard Owner data transmittal form filled out in its entirety both electronically included on the hard drive with the submittal, and in hard copy attached to the hard drive upon delivery to the Owner.
- B. All reports and/or submittals shall adhere to NASSCO PACP Standards.
- C. Contractor shall provide a rating of each pipe per the Engineer's recommendations.
- D. Contractor to provide inspection data on a monthly basis to the Engineer with the database and data on an external hard drive. The Contractor to provide two hard drives on an alternating monthly basis. The submittals shall be cumulative (i.e. each successive database delivery will include previous deliveries as well). Contractor shall provide Owner with a final external hard drive capable of storing all anticipated data for the project upon completion. The final hard drive shall be submitted on the first monthly submittal with the first month of data loaded and will become property of the Owner upon project completion. Data to be submitted shall include: 1) NASSCO PACP Database files, 2) JPEG (.jpg) files (still photos), 3) mp4 files (videos) for each pipe segment and 4) a PDF of any separate inspection reports.
- E. Each database submittal shall indicate the range of dates for which the database is being submitted as well as a list of new items as of the last submittal so that the Owner may separate out and review the newly delivered records from previous submittals in an Excel format.
- F. The databases shall be cumulative, with one database for PACP CCTV inspections. Each subsequent submittal shall be added into these databases. Throughout the duration of the project, should Engineer discover inaccuracies in any of the videos, Contractor shall re-inspect those pipes at no additional cost to the Engineer or Owner. Contractor to provide all data submittals to the Engineer for review and approval. Upon approval Engineer will submit to the Owner for review and approval.
- G. Databases, video files, digital photographs and supporting documentation (PDF, spreadsheets), etc. shall be placed in separate folders on the hard drives. Separate subfolders shall not be used to separate video files, etc. under the main folder. All videos, digital photographs, etc. of the same file type should be placed in a single folder on the hard drive in order to provide a single location to access the data.
- H. The CCTV equipment/software shall be capable of producing digital still images of all sewer line defects, and sewer line service connections in JPEG (.jpg) image format. Contractor shall take digital still images of each defect, with a minimum of one independent photo file per defect, construction features and service connections to clearly depict it. More images may be necessary depending upon the condition of the pipe. The digital images shall have a minimum size/resolution of 620x480. The screen captures or digital images shall include an onscreen display with date, sewer main reach number, footage, and type of defect/PACP Code. The filename of each JPEG (.jpg) shall be in accordance with these specifications.
- I. A final, compiled version of the inspection database in PACP Exchange format shall be delivered at the end of the project to the Owner through the Engineer. The final database shall include all inspection records previously delivered in the individual inspections as well as incorporate all requested changes by the Engineer and Owner. The database filename will use the following format using upper case letters:

P_SS7207_BR02_YYYYMMDD.MDB

Where P = PACP database; SS7207 = Example PO_Number ; BR02= Example Sub_Basin_ID, and YYYYMMDD = 8 digit date.

For projects that do not encompass an entire sub-basin, Engineer to contact Owner's GIS Administrator to obtain a "Sub_Basin_ID" for file naming.

- J. The PACP database submittals shall meet the requirements for naming, linkage, etc as defined in Specification Section 02802, Database Template Description PACP.
- K. Note that there are six (6) different asset type codes (including MH) that are to be used in the unique pipe/file identification codes as follows: MH (manhole), FM (force main), PS (pump station), CO (cleanout), LH (lamp hole), and OT (other miscellaneous). The samples and descriptions within these specifications utilize MH for simplicity and should be replaced with the applicable asset type code as appropriate.
- L. All database inspection records shall be linked to the Owner's unique pipe numbering system which is based on the upstream and downstream structure asset numbers for the pipe end structures (manhole, outfall, cleanout, etc.). The unique pipe identifier shall take the following form: 1234001 where "1234" indicates the Subdivision/Subbasin ID and "001" indicates the consecutively numbered pipe within respective subdivision/subbasin. The unique manhole identifier shall take the following form: 1234-001 where "1234" indicates the Subdivision/Subbasin ID and "001" indicates the consecutively numbered manhole within the respective subdivision/subbasin. Although, not always the case, a pipe's ID should indicate the update stream manhole. For example, pipe ID: 1234001 will typically indicate that the upstream manhole ID will typically be 1234-001. These values will be provided within the Owner's GIS database however, if additional intermediate structures are located in the field, the naming convention described below shall be used.
- M. During the inspection work, if a previously unknown manhole not shown in the GIS is found between two named manholes, the letter "A" will be added to the end of the upstream manhole ID (no spaces or special characters allowed) to form a new manhole ID in the inspection records. The data / video files shall then be re-named to include the new manhole ID, and a new CCTV inspection shall be started from the new manhole ID. If more than one unnamed manhole is found between two named manholes, subsequent new manhole IDs will be formed using the letters "B", "C" etc. Individual and final deliverables must include database records that link to the Owner's GIS database using unique manhole identification numbers per the Owner's standard manhole identification number (MH_Asset_ID field in the Owner's GIS) format. The newly located manholes must be added to the manhole inspection database using the same new identification codes.

During the inspection work, if a previously unknown manhole not shown in the GIS is found on the terminal upstream end of a pipe, the characters "Z1" will be added to the end of the downstream manhole ID (no spaces or special characters allowed) to form a new manhole ID in the inspection records. For example, if a new manhole is found upstream of an existing manhole "MH50", the upstream manhole shall be named "MH50Z1". The data / video files shall then be renamed to include the new manhole ID, and a new CCTV inspection shall be started from the new manhole ID. If more than one unnamed manhole is found at the terminal upstream end, subsequent new manhole IDs will be formed using the letter Z followed by a sequential numbering sequence: "Z1", "Z2", ..., "Z5", etc. Individual and final deliverables must include database records that link to the Owner's GIS database using unique manhole identification numbers per the Owner's standard manhole identification number (MH_Num

field in the Owner's GIS) format. The newly located manholes must be added to the manhole inspection database using the same new identification codes.

Example file names for pipe segments that may be encountered while performing sanitary sewer CCTV inspections include:

1. Example file name for pipe segment between a known Upstream structure and Downstream structure:

1234001_YYYYMMDD.MP4

Where 1234001 = pipe asset ID, and YYYYMMDD = 8 digit date.

2. Example file name for pipe segments associated with a relief sewer or double barrel sewer, facing downstream towards the downstream asset:

1234001_(1,2 or 3)_YYYYMMDD.MP4

Where 1234001 = pipe asset ID, 1,2 or 3 represent the pipe segment from left to right (facing downstream), YYYYMMDD = 8 digit date.

3. Example file name for pipe segment between an Upstream structure and Downstream structure where the structure had previously not been known to exist between manholes 1234-001 and 1234-002:

1234001A_YYYYMMDD.MP4

Where 1234001A = the asset ID for the newly located upstream pipe found between manholes 1234-001 and 1234-002, 1234-002 = the downstream asset ID, and YYYYMMDD = 8 digit date.

4. Example file name for a previously unknown pipe segment where a new structure is found to exist Upstream of the manhole 1234-001:

1234001Z1_YYYYMMDD.MP4

Where 1234001Z1 = the asset ID for the newly located upstream pipe found at the terminal end of the previously unknown pipe segment with the known downstream manhole 1234-001Z1, 1234-001Z1 = the downstream asset ID that was previously thought to be the terminate upstream manhole, and YYYYMMDD = 8 digit date.

- N. There may be situations that require Contractor to televise an individual pipe segment from more than one direction, i.e. the camera is only able to televise 75% of the segment heading downstream, and the remaining 25% is televised from the other end heading either downstream or upstream. The name of additional database files etc. produced in these circumstances shall be the unique upstream asset ID followed by the unique downstream asset ID followed by “_1”, “_2” etc. for additional files that do not use a reverse camera direction.

Examples:

Initial file name: 1234001_YYYYMMDD..MP4

Additional file name(s): 1234001_YYYYMMDD_1..MP4

Reverse setup name(s): 1234001_YYYYMMDD_R..MP4

Where 1234001 = pipe asset ID, YYYYMMDD = 8 digit date, 1 = a subsequent video of the same sewer pipe should multiple inspections be performed on the same date.

The direction of camera pull versus the pipe flow must be noted in the inspection record in the database in the 'Direction' field based on the starting direction. For inspections that subsequently require CCTV from the opposite direction, i.e. a reverse pull, these should have file naming conventions that end with an R to indicate the reverse pull. Should additional reverse pulls be required a sequential number _1, _2, etc. should be added to the end of the file after the R designation.

- O. The name of each digital still image shall be based on the video / data file name of the sewer reach in which the image was taken. The name shall be recorded as follows:

Examples: 1234001_HSV_37_2_YYYYMMDD.jpg

1234001_R_MCU_113_7_YYYYMMDD.jpg

Where 1234001 is the pipe asset ID, R is a reverse pull indication, HSV and MCU are PACP defect codes, 37 and 113 are the footage counts for the defect locations along the pipe, 2 and 7 are the sequential defect photo numbers along the pipe, and YYYYMMDD is the 8 digit date of the inspection.

- P. Digital files of all field data collection forms (if used by Contractor) should be delivered in PDF format and shall have file names that include the same unique identifier as the database submittal so that they can easily be related to the database and digital photograph/video submittals, if a naming convention is not specified.

END OF SECTION

SECTION 02803
CURED-IN-PLACE PIPE LINING

PART 1 - GENERAL

1.1 SCOPE OF WORK

- A. Furnish all labor, materials, equipment, and incidentals required to install and test the cured-in-place pipe (CIPP) lining and appurtenances complete as shown on the Drawings and as specified herein, including, but not limited to services necessary for traffic control, bypass pumping and/or diversion of sewage flows, cleaning and television inspection of sewers to be lined, liner installation, reinstatement of service connections, quality control, provide samples for performance of required material tests, final television inspection, testing of lined pipe system and warranty work, all as specified herein.
- B. CIPP lining (manhole to manhole) shall be paid for under the respective CIPP lining (manhole to manhole) bid items in the Schedule of Prices. CIPP point repairs shall be paid for under the respective CIPP point repair bid items in the Schedule of Prices.
- C. Sewer cleaning, pre-rehabilitation and post-rehabilitation CCTV inspection of all pipes to be rehabilitated by CIPP lining methods are required and shall be in accordance with Specifications 02800, and 02801, respectively. Hydraulic light sewer cleaning and pre- and post CCTV inspection shall be paid for under the appropriate CIPP lining bid item in the Schedule of Prices.
- D. Mechanical heavy sewer cleaning shall be paid for under the “Mechanical Heavy Sewer Cleaning/Root Removal” bid item in the Schedule of Prices.
- E. Reinstatement of active sewer services shall be paid for under the “Reconnect Active Sewer Laterals to CIPP Lined Pipe, All Sizes” bid item in the Schedule of Prices.
- F. The Contractor shall remove obstructions and protruding service connections as required to complete the CIPP rehabilitation. Removal of all pipeline obstructions and protruding service connections required for sewer rehabilitation using cured-in-place pipe lining shall be completed prior to the pre-rehabilitation CCTV inspection as specified in Section 02801. Removal of Protruding taps shall be paid for under the “Removal and Disposal of Protruding Service Lateral Connections” bid item in the Schedule of Prices.
- G. Neither the CIPP system, nor its installation, shall cause adverse effects to any of the Owner’s processes or facilities. The use of the product shall not result in the formation or production of any detrimental compounds or by-products in the system or at the wastewater treatment plant. The Contractor shall notify the Owner and identify any by-products produced as a result of the installation operations, test and monitor the levels, and comply with any and all local waste discharge requirements. The Contractor shall cleanup, restore existing surface conditions and structures, and repair any of the CIPP system determined to be defective by the Owner/Engineer. The Contractor shall conduct installation operations and schedule cleanup in a manner to cause the least possible obstruction and inconvenience to traffic, pedestrians, businesses, and property owners or tenants.

- H. If access to private property is required to perform the work, the contractor must determine access prior to starting.
- I. Any access to private property must be approved by the homeowner prior to starting work.
- J. Where necessary, Contractor is to assume responsibility for relocating sheds if such relocation is required to perform work. The final location of the shed will be determined on a case-by-case basis. Relocation of sheds shall be performed only upon approval of Property Owner. The Contractor shall submit such approvals to the Owner/Engineer for Information purposes. Payment for such relocation shall be approved by Owner under 'Miscellaneous Work'.
- K. If applicable, fences to be replaced in kind and a gate should be placed along the easement to allow future access by Owner forces and equipment. Each of these will be determined on a case-by-case basis directly with the Property Owner and Contractor.
- L. Contractor shall include site restoration including irrigation line repairs, driveway restoration, shrubbery replacement, etc. when choosing a route of access/repair.
- M. Contractor is allowed up to two weeks from the time of installation of a temporary asphalt patch to the completion of a permanent repair unless approved otherwise by the Owner.

1.2 REFERENCES

- A. Where materials and methods are indicated in these specifications as being in conformance with a standard specification, it shall refer to the latest edition of the specifications and shall include all interim revisions. Listing a standard specification without further reference indicates the particular material or method shall conform to such listed specification. The following standards shall be followed while executing the work:
 - 1. ASTM D543 - Standard Practices for Evaluating the Resistance of Plastics to Chemical Reagents
 - 2. ASTM D638 - Standard Test Method for Tensile Properties of Plastics
 - 3. ASTM D790 - Standard Test Method for Flexural Properties of Unreinforced and Reinforced Plastics and Electrical Insulating Materials
 - 4. ASTM D792 - Standard Test Methods for Density and Specific Gravity (Relative Density) of Plastics by displacement.
 - 5. ASTM D2412 - Standard Test Method for Determination of External Loading Characteristics of Plastic Pipe by Parallel-Plate Loading
 - 6. ASTM F1216 – Standard Practice for Rehabilitation of Existing Pipelines and Conduits by the Inversion and Curing of a Resin-Impregnated Tube
 - 7. ASTM F1743 – Standard Practice for Rehabilitation of Existing Pipelines and Conduits by Pulled-in-Place Installation of Cured-in-Place Thermosetting Resin Pipe (CIPP)
 - 8. ASTM D5813 - Standard Specification for Cured-in-Place Thermosetting Resin Sewer Piping Systems
 - 9. ASTM F2561 - Standard Practice for Rehabilitation of a Sewer Service Lateral and Its Connection to the Main Using a One Piece Main and Lateral Cured-in-Place Liner
 - 10. ASTM D2990 - Standard Test Methods for Tensile, Compressive, and Flexural Creep and Creep-Rupture of Plastics

11. ASTM F2019 - Standard Practice for the Rehabilitation of Existing Pipelines and Conduits by the Pulled in Place Installation of Glass Reinforced Plastic (GRP) Using the UV-Light Curing Method
12. ASTM D2122 - Standard Test Method for Determining Dimensions of Thermoplastic Pipe and Fittings

1.3 RELATED WORK

- A. Measurement and Payment is specified in Section 01025.
- B. Sewer Line Cleaning is specified in Section 02800.
- C. Sanitary Sewer CCTV Inspection is specified in Section 02801.
- D. Database Template Description PACP is specified in Section 02802.
- E. Sewer Service Lateral CIPP Lining is specified in Section 02806.
- F. Manhole Lining is specified in Section 02807.
- G. Sanitary Sewer Flow Control is specified in Section 02860.

1.4 SUBMITTALS

- A. Submit to the Owner/Engineer shop drawings in accordance with the contract documents including, product data, materials of construction, design calculations, and details of installation. The Contractor shall provide this information without delay or claim to any confidentiality. Submittals shall include but are not limited to the following:
 1. Submit a Traffic Control Plan to the Owner's Representative (Engineer) in accordance with Section 01570.
 2. Letter to certify that the CIPP will conform to the project requirements as outlined in the Scope of Work and as delineated in these specifications.
 3. Detailed information on the CIPP installation procedures (wet-out, heating, curing, and cool down) and all tools and equipment required for a complete installation. Identify which tools and equipment will be redundant on the job site in the event of equipment breakdown. All equipment, to be furnished for the project, including proposed back-up equipment, shall be clearly described. The Contractor shall outline the mitigation procedure to be implemented in the event of key equipment failure during the installation process.
 4. CIPP lining schedules including field-verified lengths and diameters of all CIPP lining and appurtenances required. Plans should include map(s) that show insertion points for all CIPP installations.
 5. Shop drawings and product data to demonstrate compliance with these specifications and identify materials of construction (including resins, catalysts, felt, etc.), felt manufacturer, location of the felt manufacturing facility, location of the wet-out facility, etc., flexible membrane (coating) material (including recommended repair/patching procedure if applicable).
 6. Manufacturers' shipping, storage and handling recommendations for all components of the CIPP System.

7. Safety Data Sheets for all materials to be furnished for the project.
8. Detailed installation procedures and manufacturer's recommended cure method for each diameter and thickness of CIPP liner to be installed, including CIPP lining production schedule, curing medium and method of application, acceptable inversion heads and pressures, inversion procedures, curing and cool-down procedures detailing the curing rate of temperature increases and cool down and the method of application, and times for each stage of the process.
9. Detailed sample collection, laboratory testing and quality control procedures, including schedule and shipping and storage requirements.
10. Detailed written plan of the method of flow maintenance (Bypass Pumping plan) and noise prevention measures ten days in advance of flow interruption.
11. Prior to each shipment of CIPP lining, submit certified test reports that the CIPP lining for this Contract was manufactured and tested in accordance with all ASTM Standards specified and referenced herein.
12. An odor control plan that will ensure that project specific odors will be minimized at the project site and surrounding area.
13. A detailed public notification plan shall be prepared and submitted including detailed staged notification to residences affected by the CIPP installation.
14. A complete description of the proposed wet-out procedure for the proposed technology.
15. Wet-out forms/reports for each CIPP segment with detailed information including but not limited to: volumes and/or weights of resin, length of CIPP liner, roller gap settings, start times, finish times, gel times, resin injection locations and any other pertinent data documenting the wet-out for each section of CIPP liner manufactured.
16. Design data and specification data sheets listing all parameters used in the CIPP liner design and thickness calculations based on ASTM F1216 for fully deteriorated gravity pipe conditions." All calculations shall be prepared under the supervision of and stamped by a professional engineer registered in the State of South Carolina.
17. A list of all service laterals that were abandoned or reconnected as part of the work as further defined herein.
18. The end seal material and installation materials.
19. Five (5) reports from projects within the past two years from independent testing laboratory analysis of liner materials showing: Modulus of elasticity as determined by appropriate ASTM standard and Flexural stress as determined by appropriate ASTM standard. The lining shall be of the same resin system and felt tube materials as proposed for this project.
20. Data on the maximum allowable stresses and elongation of the tube during installation and the means in which the Contractor will monitor stress and elongation (i.e., ideal inversion head and maximum cold head, minimum inversion head, maximum hot head).
21. A proposed Safety Plan to the Owner/Engineer, prior to beginning any work, identifying all competent persons, a description of a daily safety program for the job site and all emergency procedures to be implemented in the event of a safety incident. All work shall be conducted in accordance with the Contractor's submitted Safety Plan.
22. A detailed quality control plan (QCP) that fully represents and conforms to the requirements of these specifications. At a minimum the QCP shall include the following:
 - a. A detailed discussion of the proposed quality controls to be performed by the Contractor.
 - b. Defined responsibilities, of the Contractor's personnel, for assuring that all quality requirements, for this contract, are met. These shall be assigned, by the Contractor, to specific personnel.
 - c. Proposed procedures for quality control including those pertaining to fit and finish, product sampling and testing shall be defined and submitted as part of the plan.

- d. Proposed methods for product performance controls, including method of and frequency of product sampling and testing both in raw material form and cured product form.
 - e. A scheduled performance and product test result reviews between the Contractor and the Owner at a regularly scheduled job meeting.
 - f. Inspection forms and guidelines for quality control inspections shall be prepared in accordance with the standards specified in this contract and submitted with the QCP.
23. Submittals during the execution of the CIPP installation work shall include the following:
- a. Prior to each shipment of CIPP lining, submit certified test reports that the CIPP lining for this Contract was manufactured and tested in accordance with all ASTM Standards specified and referenced herein.
 - b. CIPP lining schedules including field-verified lengths and diameters of all CIPP lining and appurtenances required. Plans should include map(s) that show insertion points for all CIPP installations.
 - c. Wet-out forms/reports for each CIPP segment with detailed information including but not limited to: date and time of wet-out, wet-out facility address, volumes and/or weights of resin, length and diameter of CIPP liner (both wet-tube and dry-tube), roller gap settings, start times, finish times, resin used (product name and batch/shipment number) and quantity, gel times, resin injection locations, thickness of CIPP liner (dry and wet), catalyst(s) name and quantity used, and any other pertinent data documenting the wet-out for each section of CIPP liner manufactured. The wet-out forms shall be submitted prior to CIPP liner installation and shall be provided without delay or claim to any confidentiality. Wet out forms shall be submitted to the Owner/Engineer field representative on the day of delivery.
 - d. CIPP liner field curing reports documenting the liner installation for all sewer segments. The CIPP liner reports shall document all details of liner installation, including manhole numbers, street names/sewer location, project number, date, time, temperature, heads used during the inversion process, heads (minimum inversion pressure, ideal head, maximum hot head and maximum cold head) used during curing (including cool down), curing temperature, curing time, CIPP liner thickness, etc. A sample report shall be submitted to the Engineer for approval prior to the installation of any CIPP lining. The reports shall be submitted prior to requesting payment and shall be provided without delay or claim to any confidentiality.
24. Pre-rehabilitation and post-rehabilitation closed-circuit television (CCTV) inspection data as further defined herein.
25. Samples of installed liner(s) for testing to be performed by an ASTM-certified independent testing laboratory, as described further herein.
26. Defective installations or improperly installed CIPP, as determined by the OWNER, may result in the need to repair or replace a defective CIPP at no additional cost to the Owner. The Contractor shall outline specific repair or replacement procedures for potential defects that may occur in the installed CIPP. Repair/replacement procedures shall be as recommended by the CIPP system manufacturer and shall be submitted to also include the following:
- a. Defects in the installed CIPP that will not affect the operation and long-term life of the product shall be identified and defined.

- b. Repairable defects that may occur in the installed CIPP shall be specifically defined by the Contractor based on manufacturer's recommendations, including a detailed step-by-step repair procedure, resulting in a finished product meeting the requirements of these contract specifications. Repairable defects may include but are not limited to blisters, wrinkles, fins, pinholes, over- or under-cut lateral connections, and any voids found between liner and the host pipe.
 - c. Un-repairable defects that may occur to the CIPP shall be clearly defined by the Contractor based on the manufacturer's recommendations, including a recommended procedure for the removal and replacement of the CIPP. Un-repairable defects may include but are not limited to thickness below required minimum thickness, structural strength below required limits, lifts, folds, bulges, and delamination.
27. Contractor to complete a monthly work-summary sheet by Asset ID electronically in Excel format documenting what was completed that month for each asset. This shall be submitted on a monthly basis along with the pay application.

1.5 QUALIFICATIONS

- A. The Contractor to perform the CIPP lining work shall be fully qualified, experienced and equipped to complete this work in a timely and satisfactory manner and shall be certified and/or licensed as an installer by the CIPP lining manufacturer. The Contractor shall submit the following information to the Engineer for review and approval before any work is performed.
1. Submit a Contractor statement of qualifications which identifies key personnel and their specific CIPP experience, and recent projects listing the total length installed by host pipe diameter. Work and personnel experience listed must reference projects that used process method and materials to be used on this project. Include project names, references/contacts and phone numbers.
 2. The Contractor's personnel shall have successfully installed a minimum of 500,000 feet (total) of the proposed CIPP liner for a continuous period of at least five (5) years installing CIPP liners in pipe of a similar size, length and configuration as contained in this contract as documented by verifiable references.
 3. The name and experience of each lead individual performing work on this contract shall be submitted. Personnel replaced by the contractor, on this contract, shall have similar, verifiable experience as the personnel originally submitted for the project.
 4. The project manager for the CIPP Contractor shall have a minimum of 5 years' experience managing CIPP projects for wastewater collection systems.
 5. The full-time, on-site superintendent/foreman that will supervise the CIPP lining installation under this Contract shall have successfully installed a minimum of 300,000 feet (total) of the proposed size range of CIPP liner.
 6. The lead personnel including the superintendent, the foreman and the lead crew personnel for the CCTV inspection, resin wet-out, the CIPP liner installation, liner curing and the robotic service reconnections each shall have a minimum of three (3) years of total experience with the CIPP technology proposed for this contract and shall have demonstrated competency and experience to perform the scope of work contained in this contract as documented by verifiable references.
 7. The Owner reserves the right to disapprove the use of the Contractor, Superintendent, and/or manufacturer based on the submitted qualifications.

8. The CIPP felt and resin manufacturer(s) shall have successfully supplied a minimum of 500,000 feet of the proposed liner and 1 million pounds of resin as documented by verifiable references.
9. The lateral cutter is required to have at least 12 months of experience reinstating the connection between the sewer main and lateral lining as documented by verifiable references.
10. A certified statement from the manufacturer that the Contractor is an approved installer as certified and/or licensed by the CIPP liner manufacturer.
11. A qualified bidder for installing CIPP liner shall have a minimum 5-years history of satisfactory performance having installed a similar manufactured system as documented by verifiable references.

1.6 NOTIFICATIONS

A. Notify the Owner and Engineer:

1. On a weekly basis of scheduled work for the upcoming week, including a map showing the area of work and a list of streets being affected. Submittal shall be provided by electronic mail and a map and list of fire hydrants that will be utilized for a water source, in PDF format. Provide 24-hour notice for deviations from the plan that are not caused by weather or natural causes.
2. Immediately, when a collapsed pipe or other pipe failure is identified.
3. Immediately, if the conditions for the work described are found to be unsafe or impractical.
4. Immediately, if a manhole is buried, cannot be found or cannot be accessed. Along with the manhole identification number, provide a map (in PDF format) showing the location of the manhole and what procedures were used to attempt to locate the manhole.
5. Immediately of any defects posing imminent danger to the public (missing lids, covers broken during inspection, sink holes, etc.) and any observed pipe blockages, surcharging, or potential overflow conditions.
6. If the pipe configuration in the field is different than shown or if a new asset found, the notification shall include a diagram clearly indicating the location of structures in relation to immediately adjacent structures in PDF format via electronic mail.
7. If any obstructions are found within the easement, even if not impacting work.

B. Notify the public and coordinate with homeowners:

1. Contractor shall prepare and install yard signs to notify customers in the area of work being conducted and who to contact for information. The Owner-approved Water yard sign file will be provided by the Owner. This file is the standard sign layout to be filled in with project specific information. (Sign specs: digital print full color two-sided coroplast 4mm 18"x24" & metal step stakes 30"x10").
 - a. Approximately 25 signs are anticipated to be required.
 - b. Signs shall be placed in key intersections and at the project site, incoming/outgoing roads to the area/neighborhood, and intersections near the site at start of project.
 - c. Signs shall be placed in yards a minimum of 7 days prior to work but no more than 14 days ahead of scheduled work.
 - d. Signs shall be displayed throughout scheduled work and will be replaced if removed or damaged.

- e. Signs shall be removed at the conclusion of the project.
2. A minimum of 72 hours prior to the inspection or work on any manhole, cleanout, service lateral, or line segment, distribute door-to-door an Owner approved Homeowner Notification door hanger describing the work to be performed, if work is performed or accessed through private property or easement adjacent to property, or if the property is potentially tied to the section of line being inspected or worked on. On the day of work and prior to beginning the work, knock on the doors of all properties that will require entering their private property to access the manholes, cleanouts, or pipes which will potentially be impacted by the work and notify occupants of the work to be performed.
3. Contractor shall use approved magnetic car signs affixed to vehicles at all times during the project to identify affiliation with the Owner.
4. Contractor responsible for determining route of access for the proposed work, unless specified otherwise, and is responsible for coordinating with the Property Owner to obtain any temporary access to perform the work. Contractor shall provide copies of temporary access/easement agreements made with Property Owners. Clearing and other costs related to gaining access (including restoration) shall be paid under the respective pay items.
5. Contractor to notify Property Owner of any that all trees or other obstructions within easements that need to be moved to access or perform the work. The Property Owner shall be given a minimum of 7 days to relocate the obstruction off of the easement at their own cost to their own chosen location. After this time period, the Contractor shall be responsible for removing and disposing of the obstruction, and all costs associated with this. Contractor to coordinate with the Engineer on each obstruction found before proceeding.

1.7 GUARANTEE

- A. All CIPP lining placed shall be guaranteed by the Contractor and manufacturer for a period of 2 years from the date of final payment. During this period, any and all serious defects discovered in the CIPP lining, as determined by the Owner and which may materially affect the integrity, strength, function and/or operation of the pipe, shall be removed and replaced as recommended by the manufacturer in a satisfactory manner by the Contractor at no cost to the Owner. The Owner may conduct an independent CCTV inspection, at their own expense, of the CIPP lining work prior to the completion of the guarantee period. Any defects replaced at that time shall be fully guaranteed by the Contractor and manufacturer for a period of 2 year(s) from the date the defect was repaired. Wrinkles in the flow stream, blisters that may affect the longevity of the CIPP liner, dry spots where the liner tube has no resin saturation, or other defects that may affect the integrity or strength of the CIPP or the flow capacity of the pipe, are unacceptable. Contractor will be responsible to remove and repair, at Contractor's expense, all such defects in a manner that is satisfactory to the Owner/Engineer. Defects also include but are not limited to:
 1. Leakage through the liner.
 2. Reduction of the liner thickness of more than 10 percent of the thickness designed and/or required. Final liner thickness shall be delivered by the contractor based on installed product physical properties and as specified in the contract requirements.
 3. Separation of the liner from the host pipe where an annular space is clearly noticed, shrinkages (longitudinal and/or circumferential), dry spots, delamination of the liner, cured lifts, dry spots, bulges due to external loading, reverse curvatures, splits, cracks, lifts, breaks, folds, major wrinkles (as defined further herein), flats, pinholes, crazing, and any other defects that will compromise the longevity of the installed product.

4. Circumferential defects (wrinkle, fin, bulge, etc.) in the invert of pipe between 4:00 and 8:00 o'clock shall not exceed three percent of the host pipe diameter or 1/2-inches by visual measurement, whichever is smaller, at the discretion of the Owner.
5. Longitudinal wrinkles or fins shall not exceed maximum allowable height of five percent of equivalent host pipe diameter or 1-inch, whichever is smaller.
6. Structural strength below required limits.

1.8 QUALITY ASSURANCE

- A. All CIPP linings shall follow the quality control plan submitted by the contractor.
- B. All CIPP linings shall be from a single manufacturer. The suppliers shall be responsible for the provisions of all test requirements specified herein as applicable. In addition, all CIPP lining to be installed under this Contract may be inspected at the plant for compliance with these specifications by an independent testing laboratory provided by the Contractor. The Contractor shall require the manufacturer's cooperation with these inspections.
- C. Inspections of the CIPP lining may also be made by the Engineer or other representatives of the Owner after delivery. The CIPP lining shall be subject to rejection at any time on account of failure to meet any of the requirements specified, even though sample CIPP lining may have been accepted as satisfactory at the place of manufacture. CIPP lining rejected after delivery shall be marked for identification and shall be removed from the job site.
- D. Along with the physical properties testing and post installation CCTV survey, the Contractor shall deliver a certified copy of the curing report output from the temperature monitoring system used in the control of the curing process.
- E. The Contractor shall submit a proposed plan for ensuring that the installed CIPP meets the above minimum thickness requirements. The plan shall include the proposed CIPP thickness to be installed (pre-installation thickness) and detailed inversion or pull-in procedures to reduce stretching and to reduce migration of resin.

1.9 DELIVERY, STORAGE AND HANDLING

- A. Care shall be taken in shipping, handling and laying to avoid damaging the CIPP liner. Any CIPP liner damaged beyond repair in shipment shall be replaced as directed by the Owner and/or Engineer.
- B. Any CIPP liner showing a split or tear, or which has received a blow that may have caused damage, even though no such damage can be seen, shall be repaired per manufacturer's recommendations or, if not possible, marked as rejected and removed at once from the work.
- C. While stored, the CIPP shall be adequately supported and protected. CIPP shall be stored in a manner as recommended by the manufacturer.
- D. The CIPP liner shall be maintained at a proper temperature in refrigerated facilities to prevent premature curing at all times prior to installation. The CIPP liner shall be protected from UV light. Any CIPP liner showing evidence of premature curing will be rejected for use and will be removed from the site immediately.

1.10 WATER

- A. Water for use on this project may be available from the City of Georgetown. The Contractor is responsible for applying for the requisite permits, and obtaining meter and backflow assembly to be used at all times. The Contractor shall provide copies of such permits to the Owner.

PART 2 - PRODUCTS

2.1 CIPP FELT LINER AND RESIN

- A. CIPP liner shall be Insituform by Insituform Technologies, Inc., National Liner by National Liner Group, Reynolds Inliner by Inliner Technologies, Inc; Improved Technologies Group; Applied Felts, Inc. or approved equal.
- B. The CIPP liner shall be composed of tubing material consisting of one or more layers of a flexible non-woven polyester felt with or without additives such as woven fiberglass or other fibers and meet the requirements of ASTM F 1216, ASTM F 1743, and ASTM D 5813. The felt content of the CIPP liner shall be determined by the Contractor, but shall not exceed 15 percent of the total impregnated liner volume. The fabric tube shall be capable of absorbing and carrying resins, constructed to withstand installation pressures and curing temperatures and stretch to fit irregular pipe sections. The contractor shall submit certified information from the felt manufacturer on the normal void volume in the felt fabric that will be filled with resin.
- C. The CIPP liner tube may be made of single or multiple layer construction, with any layer not less than 1.5 mm thick, unless the tube is made of fiberglass material. The wet-out fabric tube shall have a uniform thickness and void space for resin distribution that when compressed at installation pressures will produce a predictable finished thickness that meets or exceeds the design thickness after cure.
- D. No material shall be included in the fabric tube that may cause de-lamination in the cured CIPP. No dry or unsaturated layers shall be acceptable upon visual inspection as evident by color contrast between the felt fabric and the activated resin containing a colorant.
- E. The Contractor shall verify the lengths in the field before cutting the fiber tube to length. Continuous lining over one manhole to manhole reach shall be allowed, and excess CIPP lining within the manhole channel shall be cut to match existing channel.
- F. The wall color of the interior pipe surface of CIPP after installation shall be a light reflective color so that a clear detailed examination with closed circuit television inspection equipment may be made. The hue of the color shall be dark enough to distinguish a contrast between the fully resin saturated felt fabric and dry or resin lean areas.
- G. Seams in the fabric tube, if applicable, shall meet the requirements of ASTM D5813.
- H. Resin: The resin shall be a corrosion resistant polyester or vinyl ester resin and catalyst system or epoxy and hardener system manufactured specifically for sewer rehabilitation, that, when properly cured within the tube composite, meets the requirements of ASTM F1216, ASTM F1743 or F2019, the physical properties herein, and those, which are to be utilized in the design of the CIPP for this project. The resin shall produce CIPP which will comply with or exceed the

structural and chemical resistance requirements of this specification. The liner material and resin shall be completely compatible. Generally, the resin shall not contain fillers, except those required for viscosity control or fire retardance or increase strength, and with applications for which inert fillers would facilitate better heat transfer and retention during installation. The liner contractor may add up to 5 percent by mass, a thixotropic agent for viscosity control, which will not interfere with visual inspection.

- I. The resins may contain pigments, dyes, or colorants, which shall not interfere with visual inspection of cured liner. The quantity of resin used for tube impregnation shall be sufficient to fill the volume of air voids in the tube with additional allowances for polymerization shrinkage and the loss of resin through cracks and irregularities in the original pipe wall. Use serial vacuum impregnation or pressure impregnation process (or equal) to provide maximum resin impregnation throughout the tube.
- J. The resin manufacturer shall not include any old resin or rework in the product shipped to the wet-out facility. The resin shall be manufactured under ISO 9002 certified procedures. Such certification shall be submitted to the Engineer for each shipment of resin to the wet-out facility. The proposed resin shall equal or exceed the published properties of AOC 102NA resin (for isothalic polyester resin) or Reichhold Atlac 580-20 (for vinyl ester resin).
- K. The exact makeup of the resin shall be submitted to the Engineer including chemical resistance information, cure logs and temperatures. Polyester resins shall have a minimum Heat Distortion Temperature of 212 degrees Fahrenheit per ASTM D648. Vinyl ester resins shall have a minimum Heat Distortion Temperature of 220 degrees Fahrenheit per ASTM D648.
- L. The exact mixture ratio of resin and catalyst shall also be submitted. The catalyst system shall be identified by product name. The resin/catalyst ratio shall be approved by the resin manufacturer in writing.
- M. The cure schedules for the CIPP shall be submitted to the Engineer for review. The curing process/schedules shall be approved by the resin manufacturer in writing. The cure schedules shall include specific information on stepping the temperature up to “cooking” temperatures, “cooking” temperatures and durations, and cool-down procedures – all to be approved in writing by the resin manufacturer. The CIPP shall cure in the presence of water or steam. The minimum cure/“cook” time shall be as recommended by the resin manufacturer. The cure time shall be increased as deemed necessary by the Contractor/resin manufacturer, including but not limited to, longer CIPP installations, active ground water infiltration into the existing sewers, pipe type, pipe location, etc.
- N. No fillers or additives shall be added at the wet-out facility except for the required catalyst as recommended by the resin manufacturer. The Contractor shall submit a Certificate of Authenticity from the resin manufacturer for each shipment to the wet-out facility (to include the date of manufacture and the Heat Distortion Temperature). This information shall be submitted prior to manufacturing any CIPP.
- O. With each shipment of resin to the wet-out facility, submit certification that the resin was manufactured under ISO 9002 certified procedures and meets these specifications.
- P. Prior to inversion/pull-in as applicable, the outside and/or inside layer of the tube shall be coated with an impermeable, flexible membrane that will contain the resin and facilitate, if applicable,

vacuum impregnation and monitoring of the resin saturation during the resin impregnation (wet out) procedure.

- Q. The exterior of the manufactured tube shall have distance markings along its length at regular intervals not to exceed 5 feet. Use these marks as a gauge to measure elongation during insertion. Should the overall elongation of a reach exceed 5 percent, the liner tube shall be rejected and replaced.
- R. The Contractor shall identify the wet-out facility where all CIPP liner under this Contract will be manufactured. All CIPP liner shall be manufactured from this designated wet-out facility throughout the entire Contract unless specifically approved otherwise by the Engineer in writing. Multiple wet-out facilities shall not be allowed. The resin shall be shipped directly from the resin manufacturer's facility to the CIPP wet-out facility. The resin shall not be sent to any intermediate mixing facility. Copies of the shipment documents from the resin manufacturer shall be submitted to the Engineer showing dates of shipment, the originating location and the receiving location.
- S. The Owner and/or an agent of the Owner may inspect the CIPP liner during manufacturing and wet-out. The Owner/Engineer shall be given an opportunity to witness the manufacturing of all CIPP liner for this project. The Owner is responsible for costs associated with witnessing the manufacturing of the CIPP liner.
- T. If the Owner/Engineer decides to inspect the manufacturing of the CIPP liner, the Contractor shall provide full access to witness the wet-out process and shall provide any and all information related to the manufacturing as requested by the Owner or the Owner's agent without delay and without claims of confidentiality or product privacy.
- U. The application of the resin to the felt tubing (wet-out) shall be conducted under factory conditions and the materials shall be fully protected against UV light, excessive heat and contamination at all times. If on-site wet out is required, the Contractor shall be required to maintain ambient conditions similar to those encountered during factory wet outs.
- V. Liners that are impregnated at the factory and transported to the project site in refrigerated trucks shall be installed as soon as possible and no more than two (2) weeks after the date of impregnation at the factory.
- W. When cured, the CIPP liner shall form a continuous, tight-fitting, hard, impermeable liner which is chemically resistant to any chemicals normally found in domestic sewage per Table X2.1 in ASTM F1216. The CIPP liner shall be chemically resistant to trace amounts of gasoline and other oil products commonly found in municipal sewerage and soils adjacent to the sewer pipe to be lined.
- X. The CIPP liner tube shall be manufactured or fabricated to a size that will tightly fit the internal circumference of the sewer being rehabilitated after being installed and cured. The CIPP liner shall be capable of fitting into irregularly shaped pipe sections and through bends and dips within the pipeline. Allowance for longitudinal and circumferential expansion shall be taken into account when sizing and installing the CIPP liner. The tube shall be properly sized to the diameter of the existing pipe and the length to be rehabilitated and be able to stretch to fit irregular pipe sections and negotiate bends. The Contractor shall determine the minimum tube length necessary to effectively span the designated run between manholes. The Contractor shall verify the lengths in the field prior to ordering and prior to impregnation of the tube with resin, to ensure that the tube will have sufficient length to extend the entire length of the run. The Contractor shall also measure

the inside diameter and circumference of the existing pipelines at the face of each manhole in the field prior to ordering liner so that the liner can be installed in a tight-fitted condition with little or no wrinkling.

- Y. The length of the CIPP liner shall be as deemed necessary by the Contractor to effectively carry out the insertion of the CIPP liner and sealing of the CIPP liner at the outlet and inlet manholes. The required diameter and length of each pipe segment shall be measured in advance of wet-out and a list of these measurements shall be submitted to the Engineer at least one week prior to installation of each CIPP liner.
- Z. The Contractor shall be responsible for ensuring that the correct liner is installed in each sewer reach being rehabilitated.
- AA. The minimum installed, cured liner thickness shall be as listed below. The bid form and/or drawings may list the thickness, including alternate thickness, based on Engineer’s decision to suit the conditions.

Sewer Diameter (inches)	CIPP Installed and Cured Thickness (mm)	Depth (feet)
8	6	0 to 20
	7.5	20.1 to 28
10	6	0 to 14
	7.5	14.1 to 25
12	7.5	0 to 16
	9	16.1 to 24
15	7.5	0 to 10
	9	10.1 to 15
	10.5	15.1 to 24
16	7.5	0 to 8
	9	8.1 to 13
	10.5	13.1 to 18
	12	18.1 to 24
18	9	0 to 11
	10.5	11.1 to 16
	12	16.1 to 22
	13.5	22.1 to 28
21	10.5	0 to 12
	12	12.1 to 15
	13.5	15.1 to 20

- BB. The Contractor shall verify the proposed CIPP liner thicknesses and submit the associated calculations. The actual cured liner thickness shall be -5/+10 percent of the approved design thickness and shall not include the thickness of any non-structural membrane (inner/pre- liner). The CIPP liner shall be designed in accordance with the applicable provisions of ASTM F1216 for “fully deteriorated gravity pipe conditions”. The CIPP liner shall meet the following design conditions, unless the Engineer agrees, in writing, of their change:
 1. AASHTO H-20 Live Load.
 2. Soil modulus of elasticity of 1,000 psi.
 3. Soil weight of 120 pounds per cubic foot and a coefficient of friction of $Ku'=0.130r$ shall be used for the installed depths.

4. The long-term flexural modulus used in the design calculations shall be estimated by multiplying the lowest short-term flexural modulus used in the design calculations by a retention factor of 0.50 (i.e., long-term retention of mechanical properties equal to 50 percent.)
5. Design safety factor of 2.0.
6. Typical groundwater levels shall be estimated at 1/2 the distance between the pipe’s invert and the ground surface. If actual groundwater depth information is available from USGS or other sources, it may be used in the calculations. If the sewer is within 50 feet of a creek or other water body or if indicated on the Drawings, the groundwater depth used in the calculations should be the maximum depth from the ground surface to the pipe crown.
7. Maximum long-term deflection shall be 5 percent
8. Service temperature range shall be 40 to 100 degrees F.
9. Minimum ovality of host pipe of 2 percent.
10. The thickness to be used for the CIPP liner shall be the largest thickness as determined by calculations for deflection, bending, buckling and minimum stiffness.

CC. The CIPP liner shall provide a minimum service life of 50 years and, for design purposes, shall have the following minimum initial and long-term properties:

Property	Test Method	Initial (psi)	Time Weighted (psi)
Flexural Strength	ASTM D790	4,500	2,250
Flexural Modulus of Elasticity	ASTM D790	250,000	175,000

DD. The CIPP shall be designed to withstand all imposed loads, including live loads and, if applicable, hydrostatic pressure. The liner shall have sufficient wall thickness to withstand all anticipated external pressures and loads that may be imposed after installation.

2.2 END SEALS

- A. End seals shall be composed of hydrophilic rubber and molded as a one-piece, 3-inch-wide cylinder which when installed will form a 360 degree seal between the host pipe and the newly installed liner. The use of caulking, rope or band type of an end seal will not be allowed.
- B. Acceptable seals are Insignia™ End Seals by LMK Enterprises or approved equal.
- C. Contractor shall install epoxy at the end of each lined pipe to cover any piece of existing pipe that are exposed at the manhole wall. Acceptable epoxy resins are nonshrink grout or approved equal.

2.3 CIPP POINT REPAIRS

- A. Subcontractor shall install a sectional CIPP point repairs as shown on the Drawings and for areas where longitudinal shrinkage of the installed CIPP liner near the manholes is three (3) inches or more, at no cost to the Owner/Engineer.
- B. CIPP point repairs shall be ambient cure and shall have a fiberglass mat consisting of two or more layers of 0/90 bias woven fiberglass with a Trevara felt coating on one side and capable of

carrying a two component, 100% solid epoxy or silicate base resin. Acceptable fiberglass CIPP point repairs are Prime Line sectional lining spot repair or approved equal.

2.4 CIPP LATERAL LINING

- A. CIPP lateral lining shall be as indicated on the Drawings and as specified in Section 02806.

PART 3 - EXECUTION

3.1 PRE-INSTALLATION

- A. If available, examine Owner's CCTV video of each pipe segment before starting work.
- B. The Contractor shall notify all property owners or businesses that discharge sewage directly to the sewer being lined and whose service lateral will be affected by the lining work, that their service will be temporarily discontinued during installation of the CIPP liner. The Contractor shall notify individual property owners at least 72 hours in advance, giving the date, start time and estimated completion time for the work being conducted, and any restrictions on use of the sewage system facilities including exact days and hours when the sewer system cannot be used. This notification shall be coordinated with the distribution of door hangers and the Notifications section of the Specifications.
- C. The Contractor shall clean each length of pipe to be lined and shall dispose of any resulting material offsite as specified in Section 02800.
- D. The Contractor shall conduct a pre-rehabilitation CCTV inspection of all sewers to be rehabilitated by CIPP lining methods in accordance with Section 02801. The inspection shall be for the purpose of identifying defects in the pipe, to document the location of all service lateral connections, and to confirm point repair locations. The Engineer will review pre-rehabilitation inspection videos to confirm locations of point repairs. The Contractor may not proceed with CIPP liner installation until the Engineer has reviewed and approved the Contractor's pre-rehabilitation CCTV inspection data.
- E. If the data is available, the Engineer will provide the Contractor information on the location of known active laterals and cleanouts; however, this list may not be interpreted as all-inclusive. The Contractor shall be responsible for verifying active customer service connections prior to rehabilitation. If the Contractor discovers an error or addition to the list provided, the Contractor shall immediately notify the Engineer for additional investigation. Upon completion of the rehabilitation work, a list of all service laterals abandoned or reconnected as part of the work shall be submitted to the Owner. The compiled list shall include the following information:
 - 1. Location of each service lateral based on the CCTV inspection logs. Location shall include both accurate distance measured from the centerline of the starting manhole as well as a notation (by clock-reference) of where on the circumference of the pipe, the service lateral connects.
 - 2. Status (Active or Inactive).
 - 3. The address of each customer and associated active lateral location.

- F. During the pre-rehabilitation CCTV inspection and prior to installation of the CIPP lining, all service lateral connections protruding into the main line by 1/2-inch or more shall be internally cut or ground down flush with the pipe wall with a robotic cutter specifically designed for this purpose. The internal cutter shall be capable of cutting unreinforced concrete pipe (CP), cast iron pipe, PVC, vitrified clay pipe (VCP), ductile iron pipe, and Orangeburg pipe. All materials / cuttings shall be removed from the sewer and properly disposed of. Payment for removal and disposal of protruding taps shall be made under the "Removal and Disposal of Protruding Service Lateral Connections" bid item in the Schedule of Prices.
- G. The maximum amount of time any home or business shall be without sanitary sewer service is 10 hours and not between 6:00 PM and 8:00 AM. Any service out longer than 10 hours shall be bypassed to a sanitary sewer at no cost to the owner.
- H. The Contractor shall provide bypass pumping of sewage flows in accordance with Section 02860. Service connection effluent may be plugged only after proper notification to the affected residence and may not remain plugged overnight. Installation of the liner shall not begin until the Contractor has installed the required plugs or a sewage by-pass system and all pumping facilities have been installed and tested under full operating conditions including the bypass of mainline and side sewer flows. Once the lining process has begun, existing sewage flows shall be maintained, until the resin/felt tube composite is fully cured, cooled down, full televised and the CIPP ends finished.
- I. The Contractor shall take precautions to avoid damage or flooding to public or private property being served by the sewer being lined. The Contractor shall be responsible for all flooding and pay for cleanup from flooding to the satisfaction of the property owner. The Contractor shall document all backups and submit documentation to the Engineer including the reason for the backup, the time and date of the backup, the property owner's name, address and phone number, the resolution to problem, the time and date the problem was resolved, and any special cleanup work that had to be performed. This required documentation shall be submitted for all backups regardless of when they occur. All cleanup shall be completed within 4 hours of the backup.
- J. The Contractor shall furnish and install the CIPP liner in the full length of sewer as shown on the drawings. The installation of the CIPP liner shall be in complete accordance with the applicable provisions of ASTM F1216 and/or ASTM F1743 and the manufacturer's recommendations.
- K. The contractor shall install a hydrophilic end seals at the face of each manhole at all manhole penetrations as specified herein prior to inverting or pulling in the uncured CIPP liner.
- L. If, in the opinion of the CIPP liner manufacturer, the rate of infiltration in the sewer segment is high enough to risk washout of the resin, then the Contractor shall perform measures, as required, to minimize infiltration prior to installation. If during the pre-CCTV inspection, any infiltration runners or gushers are observed, the Contractor shall submit, in writing for approval by the Engineer, the methods and materials for mitigating any adverse impacts from the infiltration.
- M. Pressure gauges for the ends shall be digital pressure gauges with a pressure range of 0 to 50 psi and $\pm 0.25\%$ accuracy.
- N. Contractor shall install and use continuous temperature sensor strips on:
1. all pipes with known heat sinks,
 2. in locations with significant known groundwater infiltration,

3. if the pipe is within 50 feet of stream, river or lake,
 4. pipes 18 inches in diameter and larger.
- O. Provide the Owner's Representative with access to the longitudinal temperature monitoring system data via digital data, or other approved methodology and printed reports.

3.2 INSTALLATION

- A. The CIPP liner shall be installed via inversion or winching in per ASTM F1216 or ASTM F1743 respectively and using hydrostatic head or air pressure in accordance with the manufacturer's recommendations. The hydrostatic head and/or steam pressure used during the installation process shall be sufficient to hold the liner tight to the pipe wall; producing dimples at all service connections, and flared ends at the two access manholes. Contractor shall closely follow the requirements in the submitted liner field curing reports, including the minimum inversion pressure, ideal head, maximum hot head and maximum cold head for each installation.
- B. If the CIPP does not fit tightly against the original pipe at its termination points, at no additional cost to the Owner, the full circumference of the CIPP exiting the host pipe shall be filled with a resin mixture compatible with the CIPP, approved by the CIPP manufacturer and the Owner/Engineer. There shall be no significant leakage of groundwater between the existing pipe and the CIPP at the manhole connection or service lateral connections. Any leakage shall be removed and/or eliminated by the Contractor at no additional cost to the Owner. Any infiltration found at the manhole and/or service connections shall be eliminated by the Contractor at no additional cost to the Owner. Any infiltration runners or gushers as defined by NASSCO PACP shall be stopped with chemical grouting.
- C. Fit the heat source with monitors to accurately gauge the temperature of the incoming and outgoing water supply. Place another such gauge between the CIPP liner and the pipe invert at the downstream end to determine the temperature during the curing process. The temperature in the CIPP during the curing process shall be as recommended by the resin manufacturer. The length of time for allowing the curing process to be completed shall be of the duration recommended by the manufacturer, during which time the Contractor shall maintain the required temperature throughout the CIPP. Provide a written temperature data chart/curing log to the Owner's Representative for review to ensure that curing temperatures for the resin meet the manufacturer's recommendations.
- D. The installed resin-impregnated flexible felt tube CIPP liner shall be cured using circulating heated water or steam in accordance with ASTM F1216 or F1743 and manufacturer's recommendations to effect the desired cure throughout the length of the tube, extending full length from manhole to manhole(s). The resin shall be cured into a hard impermeable pipe with the minimum specified thickness, providing a structurally sound, uniformly smooth interior and tight-fitting liner within the existing pipe. Cool-down procedures shall be in accordance with ASTM F1216 and manufacturer's recommendations. The cool-down shall follow manufacturer's guidelines, be measured digitally to allow inspector to inspect or record, be linear, and be gradual; no super cooled air shall be allowed to be injected.
- E. When installing CIPP lining in multiple sewer segments at one time, the top one-half of the CIPP liner in the intermediate manhole shall be neatly removed, and the void between the CIPP liner and existing channel shall be filled with nonshrink grout. The manhole bench shall be reconstructed as required to provide a smooth transition to the new CIPP liner.

- F. All cutting and sealing of the CIPP liner at manhole connections shall provide watertight pipe and manhole seals. All cut edges of the cured liner shall be thoroughly sealed with the same resin as was used in the liner. The catalyst or hardener used shall be compatible with the resin/catalyst used in the liner previously, but shall not require an external heat source to begin the exothermic reaction (curing). There shall be no leakage of groundwater into the manhole between the CIPP liner and existing sewer pipe and between the existing sewer pipe and manhole wall.
- G. For pipes 18" and greater, a continuous temperature monitoring system shall be installed at the invert of the pipe and be installed per the manufacturers recommended procedures. Temperature sensors shall be placed at the upstream and downstream ends of the reach being lined to monitor the pressurized fluid's (air or water) temperature during the curing process. To monitor the temperatures inside the tube wall and to verify proper curing, temperature sensors shall be placed between the host pipe and the liner in the bottom of the host pipe (invert) throughout the reach to record the heating and cooling that takes place on the outside of the liner during processing. The sensors shall be spaced apart at intervals greater than 10-feet. Additionally, sensors shall be strategically placed at points where a significant heat sink is likely to be anticipated. The monitoring of these sensors shall be by a computer which can record the temperatures at this interface throughout the processing of the CIPP utilizing a tamper-proof database. Temperature monitoring systems shall be Zia Systems or Vericure by Pipeline Renewal Technologies.
- H. Prior to installing the liner in the host pipe, the temperature monitoring system's proper functioning shall be confirmed by hooking it up to the computer and seeing that the sensors are reporting their ambient temperatures. No more than two sensors in sequence can be found faulty during this test. If three or more sensors in sequence are discovered faulty, a new sensor array shall be pulled into the host pipe replacing the previously installed array; and the new array shall be again tested for its proper functioning.
- I. Curing of the resin system shall be as per the direction of the CIPP system manufacturer of the CIPP product. The temperatures achieved and the duration of holding the liner at those temperatures shall be per the System Manufacturer's established procedures. If any sensor or sensors along the reach indicates that there is a localized issue with respect to achieving proper curing per the written installation procedure, the Contractor shall address the issue immediately using previously established protocols for such an event. The sensor array's database required in the above paragraph shall have an output report that identifies each sensor by its station in the reach and shows the maximum temperature achieved during the processing of the CIPP and the time sustained at or above the Manufacturer's required curing temperature at each sensor.
- J. If cool-down is to be accomplished by the introduction of cool water into an inversion standpipe to replace the water being drained from a small hole made in the downstream end, cool the hardened pipe to a temperature below 100 degrees F (38 degrees C) before relieving static head in the inversion standpipe. Ensure that, in the release of static head, a vacuum will not be produced that could damage the newly installed CIPP liner.
- K. Vent and/or exhaust noxious fumes or odors generated during and remaining after the curing process is completed. This process shall remain in place at all manholes, laterals, etc., until noxious odors have dissipated to an acceptable level in accordance with OSHA requirements for the materials used and there is no more air pollution or potential health hazard left to the general public or the construction workers.
- L. Curing water shall be discharged to sanitary sewer system as approved by the Owner/Engineer.

- M. Provide piping, pumps, valves, and other equipment to discharge curing water.
- N. Cut and trim the new liner at each manhole wall. Seal the liner to the manhole wall with a sealant material.
- O. The installed CIPP shall be continuous over the entire length of a sewer line section and be free from visual defects such as foreign inclusions, dry spots, pinholes, major wrinkles and delamination. The CIPP shall be free of any defects that will diminish the long term serviceability of the installed CIPP and shall be impervious and free of any leakage from the pipe to the surrounding ground or from the ground to inside the lined pipe.
- P. Perform testing required prior to reinstatement of services as specified herein.

3.3 REINSTATEMENT OF SERVICES

- A. After the new CIPP has been cured and completely cooled down, the Contractor shall reconnect the existing service laterals as designated by the pre-installation television inspection report generated by the Contractor. This shall be done without excavation but from the interior of the pipeline by means of a television camera and a remote cutting device that reestablishes the service connection to not less than 95 percent or better of the original diameter and to a maximum of 100 percent of the original diameter; overcut connections are not acceptable. All openings shall be clean and neatly cut and the cut shall be buffed with a wire brush to remove rough edges and provide a smooth finish. Coupons shall be recovered and removed in their entirety. The bottom of the openings shall be flush with the bottom of the lateral pipe and shall have smooth edges with no protruding material capable of hindering flow or catching debris.
- B. The Contractor shall be fully responsible for all backups and damage caused by not fully opening a lateral connection, including paying all costs associated with repairing damage as required by the Engineer, Owner and/or property owner.
- C. Coupons shall be removed from laterals by any means possible including entering homes to flush the material via access from cleanout.
- D. Service laterals that were determined to be inactive during the CCTV inspection will be abandoned by not reopening the service connection after installation of the cured-in-place pipe liner.
- E. Provide a fully operational backup device for reinstating service laterals. If there is any doubt about live vs. dead service based upon above property comparison with pipe connections during pre-installation CCTV, then contractor shall verify with dye testing. If for any reason the remote cutting device fails during the reinstatement of a service lateral, immediately deploy the standby device to complete the reinstatement. The backup device shall be fully functional without requiring removal of parts from the primary device. The backup equipment shall be onsite throughout the reinstatement process.
- F. Reconnections are to be made with a tee fitting in accordance with CIPP System Manufacturer's recommendations. Saddle connections shall be seated and sealed to the new CIPP using grout or resin compatible with the CIPP for service lateral reconnections and/or renewals to be made by excavation methods, InsertaTees may be used for solid wall pipes having a 0.36-inch or greater wall thickness. InsertaTees shall be "Fatboy" type with hub manufactured of SDR 26 PVC

material incorporating a 360 degree integral stop on the hub surface and exceeding ASTM F1336 Section 10.3 Pipe Stop Load Support Test, or approved equal. Romac type saddles shall be used for pipes having a wall thickness thinner than 0.36-inches. Other services will be renewed by trenchless lateral lining as specified in Section 02806. Saddle connections shall be seated and sealed to new CIPP using grout or resin compatible with the CIPP.

- G. All existing break-in and/or hammer-tap (break-in) laterals shall be cut and sealed per this specification to provide a watertight connection between the lateral and the lined pipe. Contractor shall submit a method for cutting and sealing each lateral.
- H. Payment for reinstatement of all active services along CIPP main lines shall be paid for under the "Reconnect Active Sewer Laterals, All Sizes" bid item in the Schedule of Prices.

3.4 FIELD TESTING AND ACCEPTANCE

- A. Field acceptance of the CIPP lining shall be based on the Owner's and Engineer's evaluation of the installation, including a review of the CIPP liner curing data, review of the post-rehabilitation CCTV inspection data, review of the certified test data for the installed CIPP liner, and review of CIPP air testing results. All CIPP sample testing, and repairs to the installed CIPP as applicable, shall be completed before final acceptance, meeting the requirements of these specifications and documented in written form.
- B. When the CIPP is installed using pressurized air, the Contractor shall perform an air-test as defined below in the presence of the Owner's representative immediately following cool down and prior to lateral reinstatement. Otherwise, Hydrostatic testing (exfiltration test) of the completed liner shall be performed after liner curing and cool down in accordance with ASTM F1216. Hydrostatic testing shall be performed prior to reinstatement of the active services.
 - 1. The lining shall have zero groundwater infiltration, and each lateral shall pass a 2-minute 4 psi air test conducted by the Contractor as described herein.
 - 2. Provide the necessary equipment and labor to perform low positive pressure air tests in accordance with the provisions in ASTM C924, ASTM C1103, or ASTM F1417 as appropriate for size and material type.
 - 3. This test shall be performed in the Engineer's presence and on all gravity sewer pipe material types. It is imperative the plugs be installed and braced to prevent blowouts. A 6-psi pressure relief device must be used. No one shall be allowed in or near the manholes during pressurization, testing, or depressurization.
 - 4. If hydrostatic testing method is selected the liner shall be tested by a hydrostatic pressure test lasting a minimum of 30 minutes. Water level at the deployment manhole shall not drop more than one (1) inch in height during the one hour hydrostatic test. Alternate testing will be considered by the Engineer. If alternate leak testing is requested, the Contractor shall submit a testing proposal at the pre-construction meeting.
- C. The Contractor shall perform sampling and testing on 10 percent of CIPP liner sections as determined by the Engineer, to determine the installed CIPP liner flexural properties and CIPP liner thickness. Additional testing may be required at the discretion of the Owner if a liner tested does not meet the engineer's minimum design criteria. The Contractor shall maintain Chain of Custody records for all CIPP Samples to ensure no tampering or misrepresentation of the installed liner.

- D. Testing shall be performed by an independent testing laboratory certified by the American Association for Laboratory Accreditation (A2LA). The Contractor shall submit to the Engineer the name and location of the independent testing laboratory, a certified statement from the laboratory indicating that they are independent from and not associated with the Contractor in any way, and the A2LA certification for the independent testing laboratory.
- E. Sampling and testing of the installed CIPP liner shall conform to ASTM F1216 and the following requirements:
1. Remove one restrained sample of the installed CIPP liner at least 18-inches in length. The sample shall be captured by installing the CIPP liner through a section of PVC pipe (same diameter as the existing sewer diameter) within the most downstream manhole of the installation and at all intermediate manholes if multiple sewer segments are lined at the same time.
 2. The CIPP liner thickness shall be measured in accordance with ASTM D5813. Flexural properties shall be determined in accordance with ASTM D790. The Engineer shall be copied on all transmittals to the independent testing laboratory. Testing results shall be submitted to the Engineer or Owner within 30 days after installation of the CIPP liner or payment will be withheld.
 3. Any CIPP lining that, does not meet the thickness requirements, shall be corrected by the Contractor in a manner approved by the Engineer at no additional cost to the Owner. The Owner's decision on how to correct deficient CIPP liner installations shall be final. Options for correcting deficient CIPP liner installations that will be considered by the Owner include the following: removal of the existing CIPP liner and re-lining the sewer, open-cut replacement of the sewer from manhole to manhole, re-lining the sewer with the existing CIPP liner in place or accept the following penalties: For structural and thickness tests, if the tests are within 90 percent of the specification the payment shall be 90 percent of the bid price per item. If the tests are between 75 percent and 89 percent, then 75 percent of the price shall be paid. If below 75 percent, the contractor shall reline the segment with a new liner that meets the structural requirements.
- F. The Contractor shall perform a post-rehabilitation CCTV inspection of all sewers rehabilitated using CIPP lining methods in accordance with Section 02801. The post-rehabilitation CCTV inspection shall be performed following installation of the CIPP liner and reinstatement of all active service laterals. The Contractor's project manager and/or superintendent shall review the post-rehabilitation inspection videos to confirm the quality of the videos and of the installed CIPP; only after the Contractor has confirmed that the video is of good quality, the videos shall be submitted to the Engineer as a submittal. Upon review and approval by the Engineer only then should it be submitted to the Owner. If it is determined that any repairs are needed at any segment, a new CCTV inspection shall be performed of the entire segment(s) after the repairs have been completed.
- G. Liner Installation Inspection - A visual inspection of the pipe will be considered acceptable if the liner shows no significant lifts, wrinkles, ridges, splits, cracks, delaminations or other type defects in the CIPP lining. Significant defects shall be defined as any defect that may create a maintenance issue in the future such as inhibiting CCTV cameras or allowing solids to get caught on the defect. Also any defect that appears to reduce the long-term structural strength or stability of the pipeline. Longitudinal wrinkles/fins in height up to a maximum of 5% of the inside diameter of the host pipe may be acceptable and shall be evaluated by the Engineer for acceptance on a case by case basis. Any circumferential defect (wrinkle, fin, or bulge etc.) in the invert of the pipe between 4:00 and 8:00 o'clock shall not exceed 3% of the host pipe diameter or ½", whichever is smaller.

Defects exceeding this criteria shall be deemed significant and shall be removed, relined or replaced by the Contractor. Defective lining will be repaired or replaced at no additional cost to the Owner. If during the removal process, the pipe is damaged, the Contractor will perform a point repair at Contractor's own expense.

- H. Groundwater infiltration through the wall of the liner shall be zero.
- I. All service connections shall be opened to a minimum of 95 percent and a maximum of 100 percent of the opening so that a new lateral or lateral lining can be installed properly. Any overcuts more than 105% shall be repaired with hydrophilic seal hat connection, CIPP liner or other approved method by the Engineer.
- J. All coupons and excess resin shall be removed from reinstated service laterals prior to acceptance of the CIPP lining.
- K. All pipe-to-manhole connections shall be watertight and free of infiltration.
- L. Engineer shall review Contractor's post rehabilitation CCTV and approve payment based upon satisfactory completion of a liner that is free of significant defects as defined in this section.
 - 1. Removal of wrinkles or fins shall be accomplished using a milling head relined or replaced by the Contractor as directed by the Owner at no additional cost.
 - 2. Longitudinal shrinkage of the CIPP liner's length, of more than three (3) inches from the face of the manhole shall be repaired with a fiberglass reinforced CIPP spot repair per this specification at no cost to the Owner.
 - 3. Circular shrinkage shall be measured by the Contractor via man entry to try to insert a 1/16" thick ruler or similar into any gap more than 8 inches past the MH wall. The Contractor shall document these measurements with digital photos that shall be submitted to the Owner/Engineer for approval. Circular shrinkage shall be repaired per manufacturer recommendations at no cost to the Owner.
- M. Overall, the hydraulic capacity shall be maintained as large as possible. The installed CIPP shall at a minimum be equal to the full flow capacity of the original pipe before rehabilitation. In those cases where full capacity cannot be achieved after liner installation, the Contractor shall submit a request to waive this requirement, together with the reasons for the waiver request. Calculated capacities may be derived using a roughness coefficient for the existing pipe material taking into consideration its age and condition, as provided or approved by the Owner.

3.5 CLEAN-UP

- A. After the installation work and testing have been accepted, restore the project area affected by the operations to a condition at least equal to what existed prior to initiating construction activities.

PART 4 – CLOSEOUT

- A. Provide in accordance with Section 01740.

END OF SECTION

SECTION 02804
CURED-IN-PLACE PIPE LINING (CIPP) - ULTRAVIOLET (UV) CURED

PART 1 - GENERAL

1.1 SCOPE

- A. Work under this section consists of furnishing all materials, labor, and equipment required for the installation of cured-in-place pipe (CIPP) in main sewers cured by ultraviolet (UV) light. Work shall include, but is not limited to services necessary for traffic control, bypass pumping and/or diversion of sewage flows, cleaning and television inspection of sewers to be lined, liner installation, reinstatement of service connections, quality control, provide samples for performance of required material tests, final television inspection, testing of lined pipe system and warranty work, all as specified herein.
- B. Sewer cleaning, pre-rehabilitation and post-rehabilitation CCTV inspection of all pipes to be rehabilitated by CIPP lining methods are required and shall be in accordance with Specifications 02800 and 02801, respectively. Hydraulic light sewer cleaning and pre- and post CCTV inspection shall be paid for under the appropriate CIPP lining bid item in the Schedule of Prices.
- C. CIPP UV lining (manhole to manhole) shall be paid for under the respective CIPP UV lining (manhole to manhole) bid items in the Schedule of Prices. CIPP point repairs shall be paid for under the respective CIPP point repair bid items in the Schedule of Prices.
- D. Mechanical heavy sewer cleaning shall be paid for under the “Mechanical Heavy Sewer Cleaning/Root Removal” bid item in the Schedule of Prices.
- E. Reinstatement of active sewer services shall be paid for under the “Reconnect Active Sewer Laterals to CIPP Lined Pipe, All Sizes” bid item in the Schedule of Prices.
- F. The Contractor shall remove obstructions and protruding service connections as required to complete the CIPP UV rehabilitation. Removal of all pipeline obstructions and protruding service connections required for sewer rehabilitation using cured-in-place pipe lining shall be completed prior to the pre-rehabilitation Closed Circuit Television (CCTV) inspection as specified in Section 02801. Removal of Protruding taps shall be paid for under the “Removal and Disposal of Protruding Service Lateral Connections” bid item in the Schedule of Prices.
- G. Neither the CIPP system, nor its installation, shall cause adverse effects to any of the Owner’s processes or facilities. The use of the product shall not result in the formation or production of any detrimental compounds or by-products in the system or at the wastewater treatment plant. The Contractor shall notify the Owner and identify any by-products produced as a result of the installation operations, test and monitor the levels, and comply with any and all local waste discharge requirements. The Contractor shall cleanup, restore existing surface conditions and structures, and repair any of the CIPP UV system determined to be defective by the Owner/Engineer. The Contractor shall conduct installation operations and schedule cleanup in a manner to cause the least possible obstruction and inconvenience to traffic, pedestrians, businesses, and property owners or tenants.

- H. If access to private property is required to perform the work, the contractor must determine access prior to starting.
- I. Any access to private property must be approved by the homeowner prior to starting work.
- J. Where necessary, Contractor is to assume responsibility for relocating sheds if such relocation is required to perform work. The final location of the shed will be determined on a case-by-case basis. Relocation of sheds shall be performed only upon approval of Property Owner. The Contractor shall submit such approvals to the Owner/Engineer for Information purposes. Payment for such relocation shall be approved by Owner under 'Miscellaneous Work'.
- K. If applicable, fences to be replaced in kind and a gate should be placed along the easement to allow future access by Owner forces and equipment. Each of these will be determined on a case-by-case basis directly with the Property Owner and Contractor.
- L. Contractor shall include site restoration including irrigation line repairs, driveway restoration, shrubbery replacement, etc. when choosing a route of access/repair.
- M. Contractor is allowed up to two weeks from the time of installation of a temporary asphalt patch to the completion of a permanent repair unless approved otherwise by the Owner.

1.2 REFERENCES

- A. Where materials and methods are indicated in these specifications as being in conformance with a standard specification, it shall refer to the latest edition of the specifications and shall include all interim revisions. Listing a standard specification without further reference indicates the particular material or method shall conform to such listed specification. The following standards shall be followed while executing the work:
 - 1. ASTM D543 - Standard Practices for Evaluating the Resistance of Plastics to Chemical Reagents
 - 2. ASTM D638 - Standard Test Method for Tensile Properties of Plastics
 - 3. ASTM D790 - Standard Test Method for Flexural Properties of Unreinforced and Reinforced Plastics and Electrical Insulating Materials
 - 4. ASTM D792 - Standard Test Methods for Density and Specific Gravity (Relative Density) of Plastics by displacement.
 - 5. ASTM D2412 - Standard Test Method for Determination of External Loading Characteristics of Plastic Pipe by Parallel-Plate Loading
 - 6. ASTM F1216 – Standard Practice for Rehabilitation of Existing Pipelines and Conduits by the Inversion and Curing of a Resin-Impregnated Tube
 - 7. ASTM F1743 – Standard Practice for Rehabilitation of Existing Pipelines and Conduits by Pulled-in-Place Installation of Cured-in-Place Thermosetting Resin Pipe (CIPP)
 - 8. ASTM D5813 - Standard Specification for Cured-in-Place Thermosetting Resin Sewer Piping Systems
 - 9. ASTM F2561 - Standard Practice for Rehabilitation of a Sewer Service Lateral and Its Connection to the Main Using a One Piece Main and Lateral Cured-in-Place Liner
 - 10. ASTM D2990 - Standard Test Methods for Tensile, Compressive, and Flexural Creep and Creep-Rupture of Plastics

11. ASTM F2019 - Standard Practice for the Rehabilitation of Existing Pipelines and Conduits by the Pulled in Place Installation of Glass Reinforced Plastic (GRP) Using the UV-Light Curing Method
12. ASTM D2122 - Standard Test Method for Determining Dimensions of Thermoplastic Pipe and Fittings

1.3 RELATED WORK

- A. Measurement and Payment is specified in Section 01025.
- B. Sewer Line Cleaning is specified in Section 02800.
- C. Sanitary Sewer CCTV Inspection is specified in Section 02801.
- D. Database Template Description PACP is specified in Section 02802.
- E. Sewer Service Lateral CIPP Lining is specified in Section 02806.
- F. Manhole Lining is specified in Section 02807.
- G. Sanitary Sewer Flow Control is specified in Section 02860.

1.4 SUBMITTALS

- A. Submit to the Owner/Engineer shop drawings in accordance with the contract documents including, product data, materials of construction, design calculations, and details of installation. The Contractor shall provide this information without delay or claim to any confidentiality. Submittals shall include but are not limited to the following:
 1. Submit a Traffic Control Plan to the Owner's Representative (Engineer) in accordance with Section 01570.
 2. Letter to certify that the CIPP UV will conform to the project requirements as outlined in the Scope of Work and as delineated in these specifications.
 3. Detailed information on the CIPP UV installation procedures and all tools and equipment required for a complete installation. Identify which tools and equipment will be redundant on the job site in the event of equipment breakdown. All equipment, to be furnished for the project, including proposed back-up equipment, shall be clearly described. The Contractor shall outline the mitigation procedure to be implemented in the event of key equipment failure during the installation process.
 4. Submit a contractor statement of qualifications which identifies key personnel and their specific UV light cured CIPP experience, and recent projects listing the total length of UV light cured CIPP installed by host pipe diameter. Work and personnel experience listed must reference projects that used process method and materials to be used on this project. Include project names, references/contacts and phone numbers.
 5. Shop drawings and product data to demonstrate compliance with these specifications and identify materials of construction (including resins, catalysts, photo initiator, fiber tube, etc.), fiber tube manufacturer, location of the fiber tube manufacturing facility, location of the wet-out facility, etc.

6. Manufacturers' shipping, storage and handling recommendations for all components of the CIPP UV System.
7. Safety Data Sheets for all materials to be furnished for the project.
8. Detailed installation procedures and manufacturer's recommended cure method for each diameter and thickness of CIPP UV liner to be installed, including CIPP UV lining production schedule, curing medium and method of application, curing procedures detailing the curing rate of temperature increases, the method of application, and times for each stage of the process.
9. Detailed sample collection, laboratory testing and quality control procedures, including schedule and shipping and storage requirements.
10. Detailed written plan of the method of flow maintenance (Bypass Pumping plan) and noise prevention measures ten days in advance of flow interruption.
11. Prior to each shipment of CIPP UV lining, submit certified test reports that the CIPP UV lining for this Contract was manufactured and tested in accordance with all ASTM Standards specified and referenced herein, including chemical resistance tests per ASTM F2019.
12. An odor control plan that will ensure that project specific odors will be minimized at the project site and surrounding area.
13. A detailed public notification plan shall be prepared and submitted including detailed staged notification to residences affected by the CIPP UV installation.
14. A complete description of the proposed wet-out procedure for the proposed technology.
15. Wet-out forms/reports for each CIPP UV segment with detailed information including but not limited to: volumes and/or weights of resin, length of CIPP UV liner, roller gap settings, start times, finish times, gel times, resin injection locations and any other pertinent data documenting the wet-out for each section of CIPP UV liner manufactured.
16. Design data and specification data sheets listing all parameters used in the CIPP UV liner design and thickness calculations based on ASTM F1216 and F2019 for fully deteriorated gravity pipe conditions. All calculations shall be prepared under the supervision of and stamped by a professional engineer registered in the State of South Carolina. Any deviation from the design parameters shall be justified and clearly noted.
17. A list of all service laterals that were abandoned or reconnected as part of the work as further defined herein.
18. The end seal material and installation materials.
19. Five (5) reports from projects within the past two years from independent testing laboratory analysis of liner materials showing: Modulus of elasticity as determined by appropriate ASTM standard and Flexural stress as determined by appropriate ASTM standard. The lining shall be of the same resin system and fiber tube materials as proposed for this project.
20. A proposed Safety Plan to the Owner/Engineer, prior to beginning any work, identifying all competent persons, a description of a daily safety program for the job site and all emergency procedures to be implemented in the event of a safety incident. All work shall be conducted in accordance with the Contractor's submitted Safety Plan.
21. A detailed quality control plan (QCP) that fully represents and conforms to the requirements of these specifications. At a minimum the QCP shall include the following:
 - a. A detailed discussion of the proposed quality controls to be performed by the Contractor.
 - b. Defined responsibilities, of the Contractor's personnel, for assuring that all quality requirements, for this contract, are met. These shall be assigned, by the Contractor, to specific personnel.
 - c. Proposed procedures for quality control including those pertaining to fit and finish, product sampling and testing shall be defined and submitted as part of the plan.
 - d. Proposed methods for product performance controls, including method of and

- frequency of product sampling and testing both in raw material form and cured product form.
- e. A scheduled performance and product test result reviews between the Contractor and the Owner at a regularly scheduled job meeting.
 - f. Inspection forms and guidelines for quality control inspections shall be prepared in accordance with the standards specified in this contract and submitted with the QCP.
22. Submittals during the execution of the CIPP UV installation work shall include the following:
- a. Prior to each shipment of CIPP UV lining, submit certified test reports that the CIPP UV lining for this Contract was manufactured and tested in accordance with all ASTM Standards specified and referenced herein.
 - b. CIPP UV lining schedules including field-verified lengths and diameters of all CIPP UV lining and appurtenances required. Plans should include map(s) that show insertion points for all CIPP UV installations.
 - c. Wet-out forms/reports for each segment with detailed information including but not limited to: date and time of wet-out, wet-out facility address, volumes and/or weights of resin, length and diameter of CIPP UV liner (both wet-tube and dry-tube), roller gap settings, start times, finish times, resin used (product name and batch/shipment number) and quantity, gel times, resin injection locations, thickness of CIPP UV liner (dry and wet), catalyst(s) name and quantity used, and any other pertinent data documenting the wet-out for each section of CIPP liner manufactured. The wet-out forms shall be submitted prior to CIPP UV liner installation and shall be provided without delay or claim to any confidentiality. Wet out forms shall be submitted to the Owner/Engineer field representative on the day of delivery
 - d. CIPP UV liner field curing reports documenting the liner installation for all sewer segments. The CIPP UV liner reports shall document all details of liner installation, including manhole numbers, street names/sewer location, project number, date, time, light source and wattage, Inner air pressure, temperature, curing temperature, curing speed, CIPP UV liner thickness, length of liner, etc. A sample report shall be submitted to the Engineer for approval prior to the installation of any CIPP UV lining. The reports shall be submitted prior to requesting payment and shall be provided without delay or claim to any confidentiality.
 - e. Cure data from during the curing process. Infrared sensors shall be used to record curing data that shall be submitted to the Engineer with the post CCTV inspection. This shall be accomplished using a computer and database that are tamper proof.
23. Pre-rehabilitation and post-rehabilitation CCTV inspection data as further defined herein.
24. Samples of installed liner(s) for testing to be performed by an ASTM-certified independent testing laboratory, as described further herein.
25. Defective installations or improperly installed liner, as determined by the Owner, may result in the need to repair or replace a defective CIPP at no additional cost to the Owner. The Contractor shall outline specific repair or replacement procedures for potential defects that may occur in the installed CIPP UV. Repair/replacement procedures shall be as recommended by the CIPP UV system manufacturer and shall be submitted to also include the following:
- a. Defects in the installed CIPP UV that will not affect the operation and long-term life of the product shall be identified and defined.
 - b. Repairable defects that may occur in the installed CIPP UV shall be specifically defined by the Contractor based on manufacturer's recommendations, including a

detailed step-by-step repair procedure, resulting in a finished product meeting the requirements of these contract specifications. Repairable defects may include but are not limited to blisters, wrinkles, fins, pinholes, over- or under-cut lateral connections, and any voids found between liner and the host pipe.

- c. Un-repairable defects that may occur to the liner shall be clearly defined by the Contractor based on the manufacturer's recommendations, including a recommended procedure for the removal and replacement of the liner. Un-repairable defects may include but are not limited to thickness below required minimum thickness, structural strength below required limits, lifts, folds, bulges, and delamination.

26. Contractor to complete a monthly work-summary sheet by Asset ID electronically in Excel format documenting what was completed that month for each asset. This shall be submitted on a monthly basis along with the pay application.

1.5 QUALIFICATIONS

- A. The Contractor to perform the CIPP UV lining work shall be fully qualified, experienced and equipped to complete this work in a timely and satisfactory manner and shall be certified and/or licensed as an installer by the CIPP UV lining manufacturer. The Contractor shall submit the following information to the Engineer for review and approval before any work is performed.
 1. Submit a Contractor statement of qualifications which identifies key personnel and their specific CIPP UV experience, and recent projects listing the total length installed by host pipe diameter. Work and personnel experience listed must reference projects that used process method and materials to be used on this project. Include project names, references/contacts and phone numbers.
 2. The Contractor must have successfully installed at least 300,000 feet of glass fiber reinforced, UV light cured CIPP for a minimum of 10 years in wastewater collection systems. The Contractor shall submit detailed references (project names, dates, owner contact names and numbers, project descriptions with lengths installed, etc.) to the Engineer as requested to demonstrate compliance with the above experience requirements. The Engineer's decision on whether the Contractor meets the experience requirements shall be final, and the Contractor shall not be due any additional money if the experience requirements are not met.
 3. The project manager for the CIPP UV Contractor shall have a minimum of 5 years' experience managing CIPP UV projects for wastewater collection systems.
 4. The full-time, on-site superintendent/foreman that will supervise the CIPP lining installation under this Contract shall have successfully installed a minimum of 300,000 feet (total) of the proposed size range of CIPP liner of which 50,000 linear feet must be glass fiber reinforced, UV cured CIPP.
 5. The lead personnel including the superintendent, the foreman and the lead crew personnel for the CCTV inspection, resin wet-out, the CIPP UV liner installation, liner curing and the robotic service reconnections each shall have a minimum of three (3) years of total experience with the CIPP UV technology proposed for this contract and shall have demonstrated competency and experience to perform the scope of work contained in this contract as documented by verifiable references.
 6. The Owner reserves the right to disapprove the use of the Contractor, Superintendent, and/or manufacturer based on the submitted qualifications.

7. The CIPP product manufacturer shall have at least 10 years of experience in the successful manufacturing of glass fiber, UV cured-in-place liners. The CIPP UV product must have been installed in a minimum of 5,000,000 feet of successful wastewater collection system installations worldwide, of which 1,000,000 feet shall be within the U.S. The manufacturer and facility shall not change throughout the duration of the contract unless approved by the Engineer in writing. The lateral cutter is required to have at least 12 months of experience reinstating the connection between the sewer main and lateral lining as documented by verifiable references.
8. A certified statement from the manufacturer that the Contractor is an approved installer as certified and/or licensed by the CIPP UV liner manufacturer.

1.6 NOTIFICATIONS

A. Notify the Owner and Engineer:

1. On a weekly basis of scheduled work for the upcoming week, including a map showing the area of work and a list of streets being affected. Submittal shall be provided by electronic mail and a map and list of fire hydrants that will be utilized for a water source, in PDF format. Provide 24-hour notice for deviations from the plan that are not caused by weather or natural causes.
2. Immediately, when a collapsed pipe or other pipe failure is identified.
3. Immediately, if the conditions for the work described are found to be unsafe or impractical.
4. Immediately, if a manhole is buried, cannot be found or cannot be accessed. Along with the manhole identification number, provide a map (in PDF format) showing the location of the manhole and what procedures were used to attempt to locate the manhole.
5. Immediately of any defects posing imminent danger to the public (missing lids, covers broken during inspection, sink holes, etc.) and any observed pipe blockages, surcharging, or potential overflow conditions.
6. If the pipe configuration in the field is different than shown or if a new asset found, the notification shall include a diagram clearly indicating the location of structures in relation to immediately adjacent structures in PDF format via electronic mail.
7. If any obstructions are found within the easement, even if not impacting work.

B. Notify the public and coordinate with homeowners:

1. Contractor shall prepare and install yard signs to notify customers in the area of work being conducted and who to contact for information. The Owner-approved Water yard sign file will be provided by the Owner. This file is the standard sign layout to be filled in with project specific information. (Sign specs: digital print full color two-sided coroplast 4mm 18"x24" & metal step stakes 30"x10").
 - a. Approximately 25 signs are anticipated to be required.
 - b. Signs shall be placed in key intersections and at the project site, incoming/outgoing roads to the area/neighborhood, and intersections near the site at start of project.
 - c. Signs shall be placed in yards a minimum of 7 days prior to work but no more than 14 days ahead of scheduled work.
 - d. Signs shall be displayed throughout scheduled work and will be replaced if removed or damaged.
 - e. Signs shall be removed at the conclusion of the project.

2. A minimum of 72 hours prior to the inspection or work on any manhole, cleanout, service lateral, or line segment, distribute door-to-door an Owner approved Homeowner Notification door hanger describing the work to be performed, if work is performed or accessed through private property or easement adjacent to property, or if the property is potentially tied to the section of line being inspected or worked on. On the day of work and prior to beginning the work, knock on the doors of all properties that will require entering their private property to access the manholes, cleanouts, or pipes which will potentially be impacted by the work and notify occupants of the work to be performed.
3. Contractor shall use approved magnetic car signs affixed to vehicles at all times during the project to identify affiliation with the Owner.
4. Contractor responsible for determining route of access for the proposed work, unless specified otherwise, and is responsible for coordinating with the Property Owner to obtain any temporary access to perform the work. Contractor shall provide copies of temporary access/easement agreements made with Property Owners.
5. Contractor to notify Property Owner of any that all trees or other obstructions within easements that need to be moved to access or perform the work. The Property Owner shall be given a minimum of 7 days to relocate the obstruction off of the easement at their own cost to their own chosen location. After this time period, the Contractor shall be responsible for removing and disposing of the obstruction, and all costs associated with this. Contractor to coordinate with the Engineer on each obstruction found before proceeding.

1.7 GUARANTEE

- A. All CIPP UV lining placed shall be guaranteed by the Contractor and manufacturer for a period of 2 years from the date of final payment. During this period, any and all serious defects discovered in the CIPP UV lining, as determined by the Owner and which may materially affect the integrity, strength, function and/or operation of the pipe, shall be removed and replaced as recommended by the manufacturer in a satisfactory manner by the Contractor at no cost to the Owner. The Owner may conduct an independent CCTV inspection, at their own expense, of the CIPP UV lining work prior to the completion of the guarantee period. Any defects replaced at that time shall be fully guaranteed by the Contractor and manufacturer for a period of 2 year(s) from the date the defect was repaired. Wrinkles in the flow stream, blisters that may affect the longevity of the CIPP UV liner, dry spots where the liner tube has no resin saturation, or other defects that may affect the integrity or strength of the CIPP UV or the flow capacity of the pipe, are unacceptable. Contractor will be responsible to remove and repair, at Contractor's expense, all such defects in a manner that is satisfactory to the Owner/Engineer. Defects also include but are not limited to:
 1. Leakage through the liner.
 2. Reduction of the liner thickness of more than 10 percent of the thickness designed and/or required. Final liner thickness shall be delivered by the contractor based on installed product physical properties and as specified in the contract requirements.
 3. Separation of the liner from the host pipe where an annular space is clearly noticed, shrinkages (longitudinal and/or circumferential), dry spots, delamination of the liner, cured lifts, dry spots, bulges due to external loading, reverse curvatures, splits, cracks, lifts, breaks, folds, major wrinkles (as defined further herein), flats, pinholes, crazing, and any other defects that will compromise the longevity of the installed product.

4. Circumferential defects (wrinkle, fin, bulge, etc.) in the invert of pipe between 4:00 and 8:00 o'clock shall not exceed three percent of the host pipe diameter or 1/2-inches by visual measurement, whichever is smaller, at the discretion of the Owner.
5. Longitudinal wrinkles or fins shall not exceed maximum allowable height of five percent of equivalent host pipe diameter or 1-inch, whichever is smaller.
6. Structural strength below required limits.

1.8 QUALITY ASSURANCE

- A. All CIPP UV linings shall follow the quality control plan submitted by the contractor.
- B. All CIPP UV linings shall be from a single manufacturer. The suppliers shall be responsible for the provisions of all test requirements specified herein as applicable. In addition, all CIPP UV lining to be installed under this Contract may be inspected at the plant for compliance with these specifications by an independent testing laboratory provided by the Contractor. The Contractor shall require the manufacturer's cooperation with these inspections.
- C. Inspections of the CIPP UV lining may also be made by the Engineer or other representatives of the Owner after delivery. The CIPP UV lining shall be subject to rejection at any time on account of failure to meet any of the requirements specified, even though sample CIPP UV lining may have been accepted as satisfactory at the place of manufacture. CIPP UV lining rejected after delivery shall be marked for identification and shall be removed from the job site.
- D. Along with the physical properties testing and post installation CCTV survey, the Contractor shall deliver a certified copy of the curing report output from the temperature monitoring system used in the control of the curing process.
- E. The Contractor shall submit a proposed plan for ensuring that the installed CIPP UV meets the above minimum thickness requirements. The plan shall include the proposed CIPP UV thickness to be installed (pre-installation thickness) and detailed inversion or pull-in procedures to reduce stretching and to reduce migration of resin.

1.9 DELIVERY, STORAGE AND HANDLING

- A. Care shall be taken in shipping, handling and laying to avoid damaging the CIPP UV liner. Any CIPP UV liner damaged beyond repair in shipment shall be replaced as directed by the Owner and/or Engineer.
- B. Any CIPP UV liner showing a split or tear, or which has received a blow that may have caused damage, even though no such damage can be seen, shall be repaired per manufacturer's recommendations or, if not possible, marked as rejected and removed at once from the work.
- C. While stored, the CIPP UV shall be adequately supported and protected, and shall be stored in a manner as recommended by the manufacturer.
- D. The CIPP UV liner shall be maintained at a proper temperature in refrigerated facilities to prevent premature curing at all times prior to installation. The CIPP UV liner shall be protected from UV light. Any CIPP UV liner showing evidence of premature curing will be rejected for use and will be removed from the site immediately.

1.10 WATER

- A. Water for use on this project may be available from the appropriate body (County/City/Greenville Water System, etc). The Contractor is responsible for applying for the requisite permits and obtaining meter and backflow assembly to be used at all times. The Contractor shall provide copies of such permits to the Owner.

PART 2 - PRODUCTS

2.1 CURED-IN-PLACE-PIPE UV LINING

- A. CIPP UV lining shall be one of the following products or approved equal. The products below shall adhere to all requirements specified herein and shall be modified as necessary to meet these requirements:
- Saertex Liner by Saertex Multicom
 - Inliner STX by Granite Inliner
 - iMPREGLiner by Impreg Group CIPP Technology Solutions
 - Berolina-Liner System by BKP Berolina
 - Alphaliner by Reline America
 - iPlus Glass by Insituform
- B. The CIPP tube shall consist of one or more layers of glass fiber reinforced materials capable of carrying resin, withstanding installation pressures and curing temperatures. The fiber tube should be compatible with the resin system to be used on this project.
- C. The fiber tube shall be fabricated under controlled conditions to a size that, when installed, will tightly fit the internal circumference and the length of the original conduit. The tube shall be able to stretch to fit irregular pipe sections and negotiate minor bends in the sewer and shall have sufficient strength to bridge missing pipe sections.
- D. The glass fiber tube shall be saturated with the appropriate resin using a resin bath system to allow for the lowest possible amount of air entrapment. An inner and outer material shall be added that are both impervious to airborne styrene with the outer material also having UV blocking characteristics. If required by the liner manufacturer, the inner membrane will be removed after the installation and curing processes are completed.
- E. The Contractor shall verify the lengths in the field before cutting the fiber tube to length. Continuous lining over one manhole to manhole reach shall be allowed, and excess CIPP lining within the manhole channel shall be cut to match existing channel.
- F. The fiber tube shall be uniform in thickness and when subjected to the manufacturer recommended installation pressures shall meet or exceed the designed wall thickness.
- G. Interior and exterior plastics shall be styrene resistant to protect and contain the resin used in the liner.

- H. A pre-liner (or “gliding foil”) shall be inserted into the pipe prior to inserting the liner as deemed necessary by the Contractor and/or as required by the CIPP manufacturer for proper installation and to meet CIPP warranty requirements.
- I. The liner is to be constructed with an inner fleece layer giving the exposed inside surface a resin rich layer.
- J. The wall color of the interior pipe surface of CIPP UV after installation shall be a light reflective color so that a clear detailed examination with CCTV inspection may be made.
- K. The fiberglass within the liner shall be non-corrosion (E-CR Glass) material and shall be free from tears, holes, cuts, foreign materials and other surface defects. Its glass fibers must extend in a longitudinal direction to ensure no longitudinal stretching during the pull-in process.
- L. At time of manufacture, each lot of fiber tube shall be inspected and certified to be free of defects. The fiber tube shall be marked for distance at regular intervals along its entire length, not to exceed five feet. Such markings shall also include the fiber tube manufacturer’s name or identifying symbol.
- M. The resin used to impregnate the liner shall produce a cured liner pipe resistant to shrinkage, corrosion, abrasion and shall have a proven resistance to municipal wastewater. The impregnation equipment shall contain devices to secure a proper distribution of resin. Following impregnation, the fabric tube shall be exposed to a resin thickening procedure.
- N. The resin shall be a chemically resistant, UV cured, isophthalic polyester resin or vinyl ester resin (as determined by the Engineer).
- O. When combined with the fiber tube, the resin system shall provide a CIPP that meets the structural requirements of ASTM F2019, the minimum physical properties specified herein, and those properties which are to be utilized in the design of the lining system for this project.
- P. When combined with the fiber tube, the resin system shall provide a liner that complies with the chemical resistance requirements specified in ASTM F2019. The chemical resistance tests shall be completed in accordance with ASTM D5813.
- Q. The exact makeup of the resin system shall be submitted to the Engineer including the resin type (manufacturer name and specific resin and applicability to CIPP UV) and formulations to include any added fillers and catalysts, chemical resistance information, and UV-cure procedures and requirements (including curing cycles, bulb wattage, etc.). Any additional/mixing of fillers and catalysts to the resin shall be performed at the wet-out facility and not at any intermediary mixing facility unless approved otherwise by the Engineer. Copies of the shipment documents from the resin manufacturer shall be submitted to the Engineer showing dates of shipment, the originating location and the receiving location. The Contractor shall submit a Certificate of Authenticity from the resin manufacturer for each shipment to the wet-out facility (to include the date of manufacture). This information shall be submitted prior to manufacturing any CIPP UV.
- R. The Contractor shall identify the wet-out facility where all CIPP UV under this Contract will be manufactured. All CIPP UV shall be manufactured from this designated wet-out facility throughout the entire Contract unless specifically approved otherwise by the Engineer in writing. Multiple wet-out facilities shall not be allowed.

- S. The Engineer, Owner and/or an agent of the Owner may inspect the CIPP during manufacturing (during “wet-out”). The Contractor shall submit UV wetout schedules so that an agent of the Owner may inspect the CIPP manufacturing process. The Contractor shall submit a schedule for manufacturing the CIPP to the Engineer every Friday for the following week. The Engineer and Owner must be given an opportunity to witness the manufacturing of all CIPP for this project. If the liner is manufactured without providing the required notice to the Engineer, the liner will be marked as rejected prior to installation and will not be approved for installation in this project.
- T. If the Engineer and/or Owner decide to inspect the manufacturing of the liner, the Contractor shall provide full access to witness the wet-out process and shall provide any and all information related to the manufacturing as requested by the Engineer, Owner or the Owner’s agent without delay and without claims of confidentiality or product privacy, including documentation of all resin and added fillers/catalysts used for each CIPP segment.
- U. The installed thickness shall be measured as specified elsewhere herein. The Contractor shall submit their proposed plan for ensuring that the installed CIPP UV meets the minimum thickness requirements. The plan shall include the proposed CIPP UV thickness to be installed (pre-installation thickness) and detailed installation procedures to reduce stretching and to reduce migration of resin.

2.2 DESIGN AND PERFORMANCE REQUIREMENTS

- A. The liner shall be designed for a life of 50 years or greater in accordance with ASTM F1216, Appendix X.1, for “fully deteriorated gravity pipe conditions.” The Bid Form and/or Drawings may list alternate minimum required thicknesses for installation based on the Engineer’s decision for specific installations and may list specific thicknesses for larger diameter sewers.
- B. Each liner shall be designed to withstand internal and/or external loads as dictated by the site and pipe conditions. Unless listed by the Engineer on the Bid Form and/or Drawings, the required installed thickness of the liner shall be derived using the standard engineering methodology as found in ASTM F1216, Appendix X1. In no case shall the installed thickness be less than 3 mm. The thickness calculations shall be submitted to the Engineer prior to CIPP installation. The designs shall include a step-by-step calculation that shows all equations, defines all variables, lists all assumptions, and clearly indicates all values used for the design.
- C. The layers of the finished liner shall be uniformly bonded. It shall not be possible to separate any two layers with a probe or point of a knife blade so that the layers separate cleanly or such that the knife blade moves freely between the layers. If separation of the layers occurs during testing of the field samples, new samples will be cut from the work. Any reoccurrence may be cause for rejection of the work.
- D. The wall thickness calculations shall be in accordance with ASTM F2019 and the design equations in Appendix X1 of ASTM F1216. The wall thicknesses presented herein and as shown on the Bid Form for the various depths shall be considered the minimum wall thicknesses for each depth category.
- E. The Contractor shall submit detailed product information and test results to document the physical properties of the proposed liner. The tests results shall include certified 20,000 hour test results to document the long-term creep factors to be used in the design calculations. The Contractor shall also submit design calculations from the proposed liner manufacturer which are

based on the proposed product’s documented physical properties. However, under no circumstance will the short-term flexural modulus or the creep retention factor be approved for a value higher than that listed below. The liner thicknesses for installation shall be adjusted (as required by the calculations) to the various specified depths based on the proposed product’s physical properties and the design calculations submitted. Under no circumstance shall the installed liner be thinner than specified herein for the various depths of sewer, regardless of the submitted calculations. Payment will be made for the installed CIPP UV based on the depth of installation.

Design Safety Factor	2.0
Short-Term Flexural Modulus	2,800,000 psi
Short-Term Flexural Strength	39,000 psi
Creep Retention Factor	78% (based on 20,000 hour tests)
Ovality	2%
Soil Modulus	1,000 psi
Soil Density	120 pounds per cubic foot
Soil Coefficient of Friction	0.130 r
Groundwater Depth	Ground Surface Elevation unless otherwise noted
Live Load	H20 Highway
Poisson’s Ratio	0.3
Enhancement Factor, K	7
Service Temperature Range	40 to 140 degrees F
Maximum Long-Term Deflection	5 percent

NOTE: A modification to the soil modulus may be considered for sewers with more than 30 feet of cover as approved or specified by the Engineer. In addition, where other data exists for ovality or other parameters, the required structural CIPP wall thickness shall be based on the more stringent parameters unless otherwise approved or specified by the Engineer.

Based on the above physical properties, the minimum installed, cured liner thicknesses per various depths shall be as listed below. The Bid Form and/or Drawings may list alternate thicknesses for installation based on the Engineer’s decision for specific installations.

8” sewer:	0’ to 30’ deep =	3 mm
10” sewer:	0’ to 30’ deep =	3 mm
12” sewer:	0’ to 20’ deep =	3 mm
	20.1’ to 30’ deep =	4 mm
15” sewer:	0’ to 11’ deep =	3 mm
	11.1’ to 22’ deep =	4 mm
	22.1’ to 30’ deep =	5 mm
16” sewer:	0’ to 10’ deep =	3 mm
	10.1’ to 20’ deep =	4 mm
	20.1’ to 30’ deep =	5 mm

18" sewer:	0' to 15' deep =	4 mm
	15.1' to 25' deep =	5 mm
21" sewer:	0' to 10' deep =	4 mm
	10.1' to 17' deep =	5 mm
	17.1' to 27' deep =	6 mm

2.3 END SEALS

- A. End seals shall be composed of hydrophilic rubber and molded as a one-piece, 3-inch wide cylinder which when installed will form a 360 degree seal between the host pipe and the newly installed liner. The use of caulking, rope or band type of an end seal will not be allowed.
- B. Acceptable seals are Insignia™ End Seals by LMK Enterprises or approved equal.
- C. Contractor shall install epoxy at the end of each lined pipe to cover any piece of existing pipe that are exposed at the manhole wall. Acceptable epoxy resins are nonshrink grout or approved equal.

2.4 CIPP POINT REPAIRS

- A. Subcontractor shall install a sectional CIPP point repairs as shown on the Drawings and for areas where longitudinal shrinkage of the installed CIPP UV liner near the manholes is three (3) inches or more, at no cost to the Owner/Engineer.
- B. CIPP point repairs shall be ambient cure and shall have a fiberglass mat consisting of two or more layers of 0/90 bias woven fiberglass with a Trevara felt coating on one side and capable of carrying a two component, 100% solid epoxy or silicate base resin. Acceptable fiberglass CIPP point repairs are Prime Line sectional lining spot repair or approved equal.

2.5 CIPP LATERAL LINING

- A. CIPP lateral lining shall be as indicated on the Drawings and as specified in Section 02806.

PART 3 - EXECUTION

3.1 PRE-INSTALLATION

- A. If available, examine Owner's CCTV video of each pipe segment before starting work.
- B. The Contractor shall notify all property owners or businesses that discharge sewage directly to the sewer being lined and whose service lateral will be affected by the lining work, that their service will be temporarily discontinued during installation of the CIPP UV liner. The Contractor shall notify individual property owners at least 72 hours in advance, giving the date, start time and estimated completion time for the work being conducted, and any restrictions on use of the sewage system facilities including exact days and hours when the sewer system cannot be used.

This notification shall be coordinated with the distribution of door hangers and the Notifications section of the Specifications.

- C. The Contractor shall clean each length of pipe to be lined and shall dispose of any resulting material offsite as specified in Section 02800.
- D. The Contractor shall conduct a pre-rehabilitation CCTV inspection of all sewers to be rehabilitated by CIPP lining methods in accordance with Section 02801. The inspection shall be for the purpose of identifying defects in the pipe, to document the location of all service lateral connections, and to confirm point repair locations. The Engineer will review pre-rehabilitation inspection videos to confirm locations of point repairs. The Contractor may not proceed with CIPP UV liner installation until the Engineer has reviewed and approved the Contractor's pre-rehabilitation CCTV inspection data.
- E. If the data is available, the Engineer will provide the Contractor information on the location of known active laterals and cleanouts; however, this list may not be interpreted as all-inclusive. The Contractor shall be responsible for verifying active customer service connections prior to rehabilitation. If the Contractor discovers an error or addition to the list provided, the Contractor shall immediately notify the Engineer for additional investigation. Upon completion of the rehabilitation work, a list of all service laterals abandoned or reconnected as part of the work shall be submitted to the Owner. The compiled list shall include the following information:
 - 1. Location of each service lateral based on the CCTV inspection logs. Location shall include both accurate distance measured from the centerline of the starting manhole as well as a notation (by clock-reference) of where on the circumference of the pipe, the service lateral connects.
 - 2. Status (Active or Inactive).
 - 3. The address of each customer and associated active lateral location.
- F. During the pre-rehabilitation CCTV inspection and prior to installation of the CIPP lining, all service lateral connections protruding into the main line by 1/2-inch or more shall be internally cut or ground down flush with the pipe wall with a robotic cutter specifically designed for this purpose. The internal cutter shall be capable of cutting unreinforced concrete pipe (CP), cast iron pipe, PVC, vitrified clay pipe (VCP), ductile iron pipe, and Orangeburg pipe. All materials / cuttings shall be removed from the sewer and properly disposed of. Payment for removal and disposal of protruding taps shall be made under the "Removal and Disposal of Protruding Service Lateral Connections" bid item in the Schedule of Prices.
- G. The maximum amount of time any home or business shall be without sanitary sewer service is 10 hours and not between 6:00 PM and 8:00 AM. Any service out longer than 10 hours shall be bypassed to a sanitary sewer at no cost to the owner.
- H. The Contractor shall provide bypass pumping of sewage flows in accordance with Section 02860. Service connection effluent may be plugged only after proper notification to the affected residence and may not remain plugged overnight. Installation of the liner shall not begin until the Contractor has installed the required plugs or a sewage by-pass system and all pumping facilities have been installed and tested under full operating conditions including the bypass of mainline and side sewer flows. Once the lining process has begun, existing sewage flows shall be maintained, until the resin/fiber tube composite is fully cured, cooled down, full televised and the CIPP ends finished.

- I. The Contractor shall take precautions to avoid damage or flooding to public or private property being served by the sewer being lined. The Contractor shall be responsible for all flooding and pay for cleanup from flooding to the satisfaction of the Property Owner. The Contractor shall document all backups and submit documentation to the Engineer including the reason for the backup, the time and date of the backup, the property owner's name, address and phone number, the resolution to problem, the time and date the problem was resolved, and any special cleanup work that had to be performed. This required documentation shall be submitted for all backups regardless of when they occur. All cleanup shall be completed within 4 hours of the backup.
- J. The contractor shall install hydrophilic end seals at the face of each manhole at all manhole penetrations as specified herein prior to pulling in the uncured CIPP UV liner.
- K. If, in the opinion of the CIPP UV liner manufacturer, the rate of infiltration in the sewer segment is high enough to risk washout of the resin, then the Contractor shall perform measures, as required, to minimize infiltration prior to installation. If during the pre-CCTV inspection, any infiltration runners or gushers are observed, the Contractor shall submit, in writing for approval by the Engineer, the methods and materials for mitigating any adverse impacts from the infiltration.
- L. Pressure gauges for the ends shall be digital pressure gauges with a pressure range of 0 to 50 psi and $\pm 0.25\%$ accuracy.
- M. Provide the Owner's Representative with access to the longitudinal temperature monitoring system data via digital data, or other approved methodology and printed reports.

3.2 INSTALLATION

- A. The CIPP liner shall be installed per ASTM F2019, except as modified herein and in accordance with the manufacturer's recommendations.
- B. As required by the CIPP manufacturer and/or as deemed necessary by the Contractor for a proper installation and to meet warranty requirements, a plastic sheet at least 10 mil thick (pre-liner or gliding foil) shall be pulled into the host pipe prior to liner insertion to protect the liner from damage as the liner is pulled in.
- C. The liner shall be pulled-in through an existing manhole or approved access point and fully extend to the next designated manhole or termination point. The pulling speed shall not exceed 15 ft/min. Care shall be exercised not to damage the fiber tube during the pulling phase.
- D. A constant tension winch shall be used, as specified by the liner manufacturer, to pull the glass fiber liner into position in the pipe. The liner shall have a longitudinal fiberglass reinforcement band which runs the entire length of the liner ensuring that the pulling force is transferred to the band and not the fiberglass liner. Once inserted, end plugs shall be used to cap each end of the glass fiber liner to prepare for pressurizing the liner. The end plugs shall be secured to prevent them from being expelled due to pressure. Liner restraints shall be used in manholes.
- E. The liner shall then be inflated with air with sufficient pressure to hold the liner tight to the host pipe wall.

- F. The inflated liner shall be CCTV'd prior to commencement of the curing process. The Contractor shall make this CCTV available to the Engineer upon request.
- G. Curing shall be in accordance with applicable ASTM F2019, with the following modifications:
1. The ultraviolet curing lamps shall operate in a sufficient frequency range to ensure the curing of the resin.
 2. A camera must be located on the ultraviolet light assembly to enable the video inspection of the liner and to ensure that the liner has been properly inflated and any liner problems can be identified before curing begins.
 3. The Contractor shall submit a documented record of time, rate of travel of the ultraviolet light assembly, and internal temperatures and pressures during the curing process to the Engineer upon request.
- H. The UV light sources shall be assembled according to the manufacturer's specifications for the liner diameter. For the liner to achieve the required water tightness and specified mechanical properties, the following parameters must be controlled during the entire curing process, giving the Engineer a record of the curing parameters over every segment of the entire length of the liner. The recording shall include:
1. Curing speed
 2. Light source and wattage
 3. Inner air pressure
 4. Curing temperatures
 5. Date and time
 6. Length of liner
- I. The optimal curing speed, or travel speed of the energized UV light sources, is determined for each length of liner based on liner diameter, liner thickness, and exothermic reaction temperature. Curing speed shall be as recommended by the manufacturer and determined by contractor based on various site specific field conditions. This shall be accomplished using a computer and database that are tamper proof. During the curing process, infrared sensors shall be used to record curing data that will be submitted to the Engineer with a post CCTV inspection.
- J. If the liner is manufactured with a removable inner film, the inner film material shall be removed and discarded after curing to provide optimal quality of the final product.
- K. All cutting and sealing of the CIPP UV liner at manhole connections shall provide watertight pipe and manhole seals. All cut edges of the cured liner shall be thoroughly sealed with the same resin as was used in the liner. The catalyst or hardener used shall be compatible with the resin/catalyst used in the liner previously but shall not require an external heat source to begin the exothermic reaction (curing). There shall be no leakage of groundwater into the manhole between the CIPP liner and existing sewer pipe and between the existing sewer pipe and manhole wall.
- L. Vent and/or exhaust noxious fumes or odors generated during and remaining after the curing process is completed. This process shall remain in place at all manholes, laterals, etc., until noxious odors have dissipated to an acceptable level in accordance with OSHA requirements for the materials used and there is no more air pollution or potential health hazard left to the general public or the construction workers.

- M. The CIPP shall be neatly cut at the pipe exit after installation unless otherwise directed by the Engineer. The CIPP shall be sealed at the manholes to provide a watertight liner connection at the manhole. There shall be no leakage of groundwater into the manhole between the CIPP and existing sewer pipe and between the existing sewer pipe and manhole wall. A hydrophilic waterstop shall be installed around the liner 6 inches from each manhole wall prior to processing the liner to provide additional waterstop protection. As the CIPP is expanded, the waterstop shall be pressed tightly against the existing sewer to provide a leak-tight seal. All CIPP connections to manholes shall be further sealed with an approved nonshrink grout to completely cover the CIPP/manhole connection point. CIPP lining shall be sealed to manhole linings (where specified) in an acceptable manner as approved by the Engineer. Further, all invert channels shall be coated with an approved grout to match the CIPP elevations in the manhole. Submit detailed drawings of the pipe-manhole connections to the Engineer for approval, including termination points in manholes and transitions with manhole linings where installed.
- N. The installed CIPP UV shall be continuous over the entire length of a sewer line section and be free from visual defects such as foreign inclusions, dry spots, pinholes, major wrinkles and delamination. The CIPP UV shall be free of any defects that will diminish the long-term serviceability of the installed CIPP UV and shall be impervious and free of any leakage from the pipe to the surrounding ground or from the ground to inside the lined pipe.

3.3 REINSTATEMENT OF SERVICES

- A. After the new CIPP UV has been cured, the Contractor shall reconnect the existing service laterals as designated by the pre-installation television inspection report generated by the Contractor. This shall be done without excavation but from the interior of the pipeline by means of a television camera and a remote cutting device that reestablishes the service connection to not less than 95 percent or better of the original diameter and to a maximum of 100 percent of the original diameter; overcut connections are not acceptable. All openings shall be clean and neatly cut and the cut shall be buffed with a wire brush to remove rough edges and provide a smooth finish. Coupons shall be recovered and removed in their entirety. The bottom of the openings shall be flush with the bottom of the lateral pipe and shall have smooth edges with no protruding material capable of hindering flow or catching debris.
- B. The Contractor shall be fully responsible for all backups and damage caused by not fully opening a lateral connection, including paying all costs associated with repairing damage as required by the Engineer, Owner and/or property owner.
- C. Coupons shall be removed from laterals by any means possible including entering homes to flush the material via access from cleanout.
- D. Service laterals that were determined to be inactive during the CCTV inspection will be abandoned by not reopening the service connection after installation of the cured-in-place pipe liner.
- E. Provide a fully operational backup device for reinstating service laterals. If there is any doubt about live vs. dead service based upon above property comparison with pipe connections during pre-installation CCTV, then contractor shall verify with dye testing. If for any reason the remote cutting device fails during the reinstatement of a service lateral, immediately deploy the standby device to complete the reinstatement. The backup device shall be fully functional

without requiring removal of parts from the primary device. The backup equipment shall be onsite throughout the reinstatement process.

- F. Reconnections are to be made with a tee fitting in accordance with CIPP System Manufacturer's recommendations. Saddle connections shall be seated and sealed to the new CIPP using grout or resin compatible with the CIPP for service lateral reconnections and/or renewals to be made by excavation methods, InsertaTeEs may be used for solid wall pipes having a 0.36-inch or greater wall thickness. InsertaTeEs shall be "Fatboy" type with hub manufactured of SDR 26 PVC material incorporating a 360 degree integral stop on the hub surface and exceeding ASTM F1336 Section 10.3 Pipe Stop Load Support Test, or approved equal. Romac type saddles shall be used for pipes having a wall thickness thinner than 0.36-inches. Other services will be renewed by trenchless lateral lining as specified in Section 02806. Saddle connections shall be seated and sealed to new CIPP using grout or resin compatible with the CIPP.
- G. All existing break-in and/or hammer-tap (break-in) laterals shall be cut and sealed per this specification to provide a watertight connection between the lateral and the lined pipe. Contractor shall submit a method for cutting and sealing each lateral.
- H. Payment for reinstatement of all active services along CIPP main lines shall be paid for under the "Reconnect Active Sewer Laterals, All Sizes" bid item in the Schedule of Prices.

3.4 FIELD TESTING AND ACCEPTANCE

- A. Field acceptance of the CIPP UV lining shall be based on the Owner's and Engineer's evaluation of the installation, including a review of the CIPP UV liner curing data, review of the post-rehabilitation CCTV inspection data, review of the certified test data for the installed CIPP UV liner, and review of CIPP air testing results. All CIPP sample testing, and repairs to the installed CIPP as applicable, shall be completed before final acceptance, meeting the requirements of these specifications and documented in written form.
- B. The Contractor shall perform an air-test as defined below in the presence of the Owner's representative immediately following curing and prior to lateral reinstatement. Otherwise, Hydrostatic testing (exfiltration test) of the completed liner shall be performed after liner curing in accordance with ASTM F1216. Hydrostatic testing shall be performed prior to reinstatement of the active services.
 - 1. The lining shall have zero groundwater infiltration, and each lateral shall pass a 2-minute 4 psi air test conducted by the Contractor as described herein.
 - 2. Provide the necessary equipment and labor to perform low positive pressure air tests in accordance with the provisions in ASTM F1417 as appropriate for size and material type.
 - 3. This test shall be performed in the Engineer's presence and on all gravity sewer pipe material types. It is imperative the plugs be installed and braced to prevent blowouts. A 6-psi pressure relief device must be used. No one shall be allowed in or near the manholes during pressurization, testing, or depressurization.
 - 4. If hydrostatic testing method is selected, the liner shall be tested by a hydrostatic pressure test lasting a minimum of 30 minutes. Water level at the deployment manhole shall not drop more than one (1) inch in height during the one hour hydrostatic test. Alternate testing may be considered by the Engineer. If alternate leak testing is requested, the Contractor shall submit a testing proposal at the pre-construction meeting.

- C. For every sewer segment that is lined, the Contractor shall remove one restrained sample of the installed liner at least 12 inches in length for testing of installed CIPP flexural properties and thickness. The CIPP testing shall include determining flexural strength, flexural modulus, tensile strength, and thickness of each sample. These four separate individual tests make up one complete CIPP test.
- D. For sewers 15 inches in diameter and smaller, the sample shall be captured by installing the lining through a section of PVC pipe (same diameter as the existing sewer diameter) within the most downstream manhole of the installation and at all intermediate manholes if multiple sewer segments are lined at the same time. For sewers larger than 15 inches in diameter, samples shall be obtained from the liner being cured.
- E. Contractor shall cut a 1-inch wide representative sample (taken at least 2 inches from the end of the specimen) for the Engineer's records.
- F. Testing shall be performed by an independent testing laboratory certified by the American Association for Laboratory Accreditation (A2LA). The Contractor shall submit to the Engineer the name and location of the independent testing laboratory, a certified statement from the laboratory indicating that they are independent from and not associated with the Contractor in any way, and the A2LA certification for the independent testing laboratory.
- G. Sampling and testing of the installed CIPP UV liner shall conform to ASTM F2019 and the following requirements:
1. The CIPP UV liner thickness shall be measured in accordance with ASTM D5813. Flexural properties shall be determined in accordance with ASTM D790. The Engineer shall be copied on all transmittals to the independent testing laboratory. Testing results shall be submitted to the Engineer or Owner within 30 days after installation of the CIPP UV liner or payment will be withheld.
 2. Any CIPP UV lining that does not meet the thickness requirements, shall be corrected by the Contractor in a manner approved by the Engineer at no additional cost to the Owner. The Owner's decision on how to correct deficient CIPP liner installations shall be final. Options for correcting deficient CIPP UV liner installations that will be considered by the Owner include the following: removal of the existing CIPP UV liner and re-lining the sewer, open-cut replacement of the sewer from manhole to manhole, re-lining the sewer with the existing CIPP UV liner in place or accept the following penalties: For structural and thickness tests, if the tests are within 90 percent of the specification the payment shall be 90 percent of the bid price per item. If the tests are between 75 percent and 89 percent, then 75 percent of the price shall be paid. If below 75 percent, the contractor shall reline the segment with a new liner that meets the structural requirements.
- H. The Contractor shall perform a post-rehabilitation CCTV inspection of all sewers rehabilitated using CIPP UV lining methods in accordance with Section 02801. The post-rehabilitation CCTV inspection shall be performed following installation of the CIPP UV liner and reinstatement of all active service laterals. The Contractor's project manager and/or superintendent shall review the post-rehabilitation inspection videos to confirm the quality of the videos and of the installed CIPP UV; only after the Contractor has confirmed that the video is of good quality, the videos shall be submitted to the Engineer as a submittal. Upon review and approval by the Engineer only then should it be submitted to the Owner. If it is determined

that any repairs are needed at any segment, a new CCTV inspection shall be performed of the entire segment(s) after the repairs have been completed.

- I. Liner Installation Inspection - A visual inspection of the pipe will be considered acceptable if the liner shows no significant lifts, wrinkles, ridges, splits, cracks, delaminations or other type defects in the CIPP UV lining. Significant defects shall be defined as any defect that may create a maintenance issue in the future such as inhibiting CCTV cameras or allowing solids to get caught on the defect. Also any defect that appears to reduce the long-term structural strength or stability of the pipeline. Longitudinal wrinkles/fins in height up to a maximum of 5% of the inside diameter of the host pipe may be acceptable and shall be evaluated by the Engineer for acceptance on a case by case basis. Any circumferential defect (wrinkle, fin, or bulge etc.) in the invert of the pipe between 4:00 and 8:00 o'clock shall not exceed 3% of the host pipe diameter or ½", whichever is smaller. Defects exceeding this criteria shall be deemed significant and shall be removed, relined or replaced by the Contractor. Defective lining will be repaired or replaced at no additional cost to the Owner. If during the removal process, the pipe is damaged, the Contractor will perform a point repair at Contractor's own expense.
- J. Groundwater infiltration through the wall of the liner shall be zero.
- K. All service connections shall be opened to a minimum of 95 percent and a maximum of 100 percent of the opening so that a new lateral or lateral lining can be installed properly. Any overcuts more than 105% shall be repaired with hydrophilic seal hat connection, CIPP liner or other approved method by the Engineer.
- L. All coupons and excess resin shall be removed from reinstated service laterals prior to acceptance of the CIPP lining.
- M. All pipe-to-manhole connections shall be watertight and free of infiltration.
- N. Engineer shall review Contractor's post rehabilitation CCTV and approve payment based upon satisfactory completion of a liner that is free of significant defects as defined in this section.
 - 1. Removal of wrinkles or fins shall be accomplished using a milling head relined or replaced by the Contractor as directed by the Owner at no additional cost.
 - 2. Longitudinal shrinkage of the CIPP liner's length, of more than three (3) inches from the face of the manhole shall be repaired with a fiberglass reinforced CIPP spot repair per this specification at no cost to the Owner.
 - 3. Circular shrinkage shall be measured by the Contractor via man entry to try to insert a 1/16" thick ruler or similar into any gap more than 8 inches past the MH wall. The Contractor shall document these measurements with digital photos that shall be submitted to the Owner/Engineer for approval. Circular shrinkage shall be repaired per manufacturer recommendations at no cost to the Owner.
- O. Overall, the hydraulic capacity shall be maintained as large as possible. The installed CIPP UV shall at a minimum be equal to the full flow capacity of the original pipe before rehabilitation. In those cases where full capacity cannot be achieved after liner installation, the Contractor shall submit a request to waive this requirement, together with the reasons for the waiver request. Calculated capacities may be derived using a roughness coefficient for the existing pipe material taking into consideration its age and condition, as provided or approved by the Owner.

3.5 CLEAN-UP

- A. After the installation work and testing have been accepted, restore the project area affected by the operations to a condition at least equal to what existed prior to initiating construction activities.

PART 4 – CLOSEOUT

- A. Provide in accordance with Section 01740.

END OF SECTION

SECTION 02805
GROUTING MAINS AND LATERAL CONNECTIONS

PART 1 - GENERAL

1.1 SCOPE OF WORK

- A. Furnish all labor, materials, equipment and incidentals required to eliminate infiltration runners or gushers at sewer main joints and defects, lateral joints and defects, lateral connections to sewer mains using chemical grout that is installed using a grout packer. Sewer main and service connection cleaning, testing and grouting shall be as described in this Section. All equipment shall enter sewer mains from the manholes.
- B. Furnish all labor, materials, equipment and incidental required to grout all 4-inch lateral connections, 4-inch lateral runs, and other lateral connections and lateral runs that will not be rehabilitated using CIPP, with a chemical grout that is installed using a grout packer. All equipment shall enter sewer mains from the manholes.

1.2 RELATED WORK

- A. Measurement and Payment is specified in Section 01025.
- B. Cured-in-place Pipe Lining is specified in Section 02803.
- C. Sanitary Sewer Flow Control is specified in Section 02860.
- D. Sanitary Sewer CCTV Inspection is specified in Section 02801.
- E. Sewer Line Cleaning is specified in Section 02800.

1.3 SUBMITTALS

- A. The Contractor shall submit the following:
 - 1. Name of the Supervisor directly responsible for grouting operations
 - 2. Qualifications of the grouting superintendent
 - 3. Certification of all installers by the grout manufacturer or their approved representatives
 - 4. Product information on the grout, additives, and packer. Grout and additive product data shall include both chemical and physical properties.
 - 5. Manufacturer's installation instructions
 - 6. Safety Data Sheets

1.4 QUALITY ASSURANCE

- A. Sealing shall be performed by a crew under the direct supervision of a superintendent who has a minimum of two years documented experience in the sealing procedures as specified herein and

as considered standard in the sewer rehabilitation industry. Submit documentation of this experience with references for approval prior to the start of work.

PART 2 - PRODUCTS

2.1 DESCRIPTION OF WORK

- A. Clean (including roots, etc.), grout and test each defect as required. Furnish and utilize such equipment as is necessary to conduct all of the work specified in this Section from inside each main or service connection. Access to each service connection shall be from within the main sewer from the nearest sewer manhole. Access from private property shall be considered only after all options to access from the main sewer have been attempted. Where private property access is required, Contractor shall be responsible for obtaining access.

2.2 SEALING MATERIALS

A. General

1. Mixing, handling, and application of chemical sealing materials shall be in strict accordance with the manufacturer's recommendations.
2. While being injected, the chemical sealant must be able to react/perform in the presence of water.
3. The cured sealing material must prevent the passage of water through the pipe joint and the annular space. The sealing material must withstand submergence in water without degradation, remain flexible after curing, and must be able to withstand freeze/thaw and wet/dry cycles without adversely affecting the seal.
4. The cured sealant must be chemically stable and resistant to acids, alkalis and organics normally found in sewage, and must not be biodegradable.
5. Residual sealing materials must be easily removable from the sewer line to prevent reduction or blockage of sewage flow.
6. Handling, formulation and storage of the sealing gel compound shall be in strict conformance with the manufacturer's recommendations. The uncured gel shall be delivered to the site in unopened containers, with the date of manufacture clearly indicated, no uncured gel manufactured more than six months prior to the date of application shall be utilized. Any uncured gel compound determined to be more than six months old shall be immediately removed from the site. Once a container of uncured gel has been opened it shall be used as soon as practically possible. If the container of gel is not used within 24 hours of being opened, ensure that the gel has not been contaminated. Any contaminated gel, as determined by the Engineer or Owner, shall be removed from the site and disposed of.

B. Acrylic base gel chemical sealing material shall have the following characteristics:

1. A minimum of 10% acrylic base material by weight in the total sealant mix. A higher concentration (%) of acrylic base material may be used to increase strength of set during injection.
2. The ability to tolerate some dilution and react in moving water during injection.
3. A viscosity of approximately 2 centipoise, which can be increased with additives.

4. A constant viscosity during the reaction period.
 5. A controlled reaction time from 5 seconds to 6 hours.
 6. The ability to increase mix viscosity, density, and gel strength by the use of additives.
 7. Acrylic base gel chemical sealing material shall be Avanti AV-118 or equal.
- C. Urethane base gel chemical sealing material shall have the following characteristics:
1. One part urethane prepolymer thoroughly mixed with between 5 and 10 parts of water weight. The recommended mix ratio is one part urethane prepolymer to 8 parts of water (11% prepolymer).
 2. A liquid prepolymer having a solids content of 77% to 83%, specific gravity of 1.04 (8.65 lbs./gal.) and a flash point of 20 degrees F.
 3. A liquid prepolymer having a viscosity of 600 to 1200 centipoise at 70 degrees F that can be pumped through 500 feet of hose with a 1000 psi head at a flow rate of 1 ounce per second.
 4. Water used to react the prepolymer shall have a pH between 5 and 9.
 5. A cure time of 80 seconds at 40 degrees F, 55 seconds at 60 degrees F, and 30 seconds at 80 degrees F, when 1 part prepolymer is reacted with 8 parts of water only. Cure time shall be adjustable by the use of additives to the reaction water.
- D. Icoset shall be added to all chemical grout installed under this contract. The application shall be in accordance with the manufacturer's recommendations.
- E. A representative of the grout manufacturer shall be on site for one day at the start of the project to assure that all requirements are met.

PART 3 - EXECUTION

3.1 GENERAL

- A. Prior to grouting, the Contractor shall thoroughly clean the interior of the sewer main and lateral of deposits, debris, foreign matter, and any obstructions or defects that prevent the movement or seating of the packer. The lateral shall be cleaned of obstructions and roots for the length to be sealed. Cleaning shall be performed in accordance with Section 02800.
- B. The Contractor shall be prepared to bypass pump the sewage flow as part of his operation where the sealing procedures require such diversion. Where the sealing equipment is designed to allow the passage of flow, the flow shall be limited to that as recommended by the equipment manufacturer.
- C. Where normal cleaning or light cleaning efforts do not remove the deposits, debris, foreign matter or obstructions, the Contractor, upon the Owner's approval, shall use heavy cleaning or specialty cleaning.
- D. The equipment shall consist of a closed-circuit television system and a sealing packer device along with the necessary chemical sealant containers, pumps, controls, regulators, valves, hoses, etc. The sealing packer shall be so constructed that it can straddle 4 to 6-in diameter service connections in 8-in or larger main sewer lines. When properly positioned and with the end elements inflated, an inflatable inversion sealing tube shall be extruded up the service lateral

thereby isolating a portion of the service lateral containing one or more pipe joints for testing or sealing. The pumping unit, metering equipment, and the packer device shall be designed so that proportions and quantities of materials can be regulated in accordance with the type and size of the leak being sealed. Mainline packer and lateral bladder device shall be manufactured by American logiball, Inc. or equal.

3.2 SEWER MAINS AND LATERALS CONNECTED TO MANHOLES

- A. The Contractor shall note the location of all leaking defects and joints to be grouted using the pre-CCTV footage.
- B. The grout packer shall be positioned accurately using the noted location, marked push rod, or through a CCTV camera in the lateral where nearby cleanout access is available.
- C. The packer shall then be expanded to seal the inside diameter of the pipe completely such that a void is formed around the defect or joint, and the defect or joint is completely isolated from the rest of the pipe.
- D. Grout shall then be pumped into the leaking defect or joint. Pumping pressure shall be controlled during grouting to stay above ground water pressure.
- E. Grout shall be pumped until the soil surrounding the leaking defect or joint is saturated or solidified. Grouting shall be stopped at refusal. Refusal shall be defined as the inability of the leaking defect or joint to accept any further grout, due to the formation of a cohesive seal in the surrounding soil thereby preventing any further grout flow. Refusal shall be monitored by the Contractor during the grouting process. Any instantaneous increase of the packer's void pressure by 5 psi or more compared to the normal void pressure shall denote refusal. Refusal may also be observable when the pumping pressure exceeds the holding pressure of the packer end elements.
- F. If the application exceeds 1/2 a gallon of grout per inch-diameter per leaking defect or joint, the Owner shall be immediately notified. Additional application of grout shall be implemented only after Owner's approval.
- G. Upon completion of grouting, the packer shall be deflated to allow for the gel ring formed around the void to break away. The grouted defect or joint shall then be air tested. If the air test fails, additional grouting shall be performed at no cost to the Owner. This process shall be repeated until the defect or joint passes the air test.
- H. After completion of grouting operations, all excess grout shall be flushed to the downstream manhole, removed and disposed.

3.3 SERVICE LATERALS

- A. Lateral connection sealing shall be used when leaking lateral connections or lateral defects are noticed. Lateral connection sealing and lateral grouting shall also be used on all 4-inch laterals and other laterals connections and lateral runs that are determined by the Owner to be not suited for CIPP rehabilitation.

- B. Grout shall be pumped using a packer with the inversion tube extruded into the service lateral, until the soil surrounding the annular space between the CIPP liner and the lateral connection, and other leaking defects in the lateral is saturated to form a cohesive seal that prevents further pumping of grout. For lateral connections and laterals that are not suited for CIPP rehabilitation, an initial air test shall be performed to determine leaks.
- C. The void pressure shall be monitored continuously during grouting operation. Grouting shall be stopped once a minimum of 8 psi backpressure is achieved during pumping. When the effective quantity of grout pumped exceeds one gallon per foot of sealing distance plus 3 gallons it will be suspected that there are unseen voids outside of the pipe and the applicator shall, upon the Owner's approval, try to build grout dams by repetitively pumping and curing the grout until the area is dammed off and the refusal pressure is met. The amount of chemical per pump stroke shall be measured from time to time and then the number of pump strokes can be used to measure the amount of chemical delivered to each lateral.
- D. Upon completion of grouting, testing shall be conducted by properly positioning the packer device in the main sewer line with the inversion tube extruded into the service lateral and performing an air test. This test shall be accomplished by applying a positive air pressure equal to 1/2 psi /ft of main sewer line depth into the created void area between the packer device and the extended end of the inversion tube, but not to exceed 10 psi. After the required test pressure has been displayed on the test meter above ground, the application of the air pressure shall be stopped and a 20 second test period shall commence. The test pressure meter shall be observed during the 20-second test period and should the pressure drop exceed 50 percent of the test pressure, the service lateral shall have failed the test and shall be sealed. Should it not be possible to develop the required air test pressure, then the service lateral shall also have failed the test and shall be sealed.
- E. Upon completion of the sealing operation, the service lateral shall be retested to ensure the effectiveness of the work. The retesting shall be accomplished using the same procedures previously described. Should the service lateral fail to pass the test, it shall be resealed and retested until the test requirements can be met.
- F. After the service lateral has been successfully sealed and retested the following procedures shall be performed to ensure that the sealing operation did not block the service lateral.
1. The inversion tube shall be removed from the lateral.
 2. The packer and elements shall remain inflated or be reinflated.
 3. Air shall then be introduced into the service lateral line.
- G. If during the injection of the air, no pressure build up is recorded on the pressure gauge the service lateral shall be considered free flowing. However, should air pressure build up indicating a partial or total blockage of the lateral it shall then be cleaned to restore proper flow.
- H. Any service laterals, which fail, shall be resealed and retested until it passes the test before moving on to the next service lateral.
- I. Residual sealing materials that extend into the pipe, reduce the pipe diameter, or restrict the flow shall be removed from the joint. The sealed joints shall be reasonably flush with the existing pipe surface. It is the responsibility of the Contractor to verify that the sealing of laterals did not restrain the flow and to remove any grout which would restrain flow. Lateral flow shall be verified after the sealing of each lateral. With the lateral being viewed with the pan and tilt

camera, an attempt is made to obtain a water flush by the occupant. If the flow seems abnormal, it is assumed that the building sewer is blocked with grout and must be cleared

- J. Extreme caution shall be utilized during the testing and sealing operations in order to avoid damaging the existing sewer. If any damage occurs, it shall be repaired to the satisfaction of the OWNER with no additional cost.

END OF SECTION

SECTION 02806
SEWER SERVICE LATERAL CIPP LINING

PART 1 - GENERAL

1.1 SCOPE OF WORK

- A. Furnish all labor, materials, equipment, and incidentals required to install cured-in-place pipe (CIPP) lining to rehabilitate existing active service laterals as shown on the Drawings or as directed by the Engineer. Service laterals shall be lined from the connection with the main sewer line to the property line or easement edge, unless otherwise noted or approved by the Engineer.
- B. Furnish all labor, materials, equipment, and incidentals required to conduct air testing, pre- and post-rehabilitation CCTV inspections, flexural strength and flexural modulus testing, and other requirements described herein for final service lateral lining acceptance.
- C. This specification shall also apply to installing CIPP lining for laterals discharging directly into manholes, if the pipe diameter is 6-inch. Contractor to verify with Engineer if CIPP is to be utilized on 4-inch laterals, or if other rehabilitation methods are to be used.
- D. Service laterals may be a combination of tees, wyes, or break-in taps of varying sizes (6-inch to 8-inch) with angles generally ranging up to 90 degrees. If a cleanout is required to line the service, it shall be installed at the property line or easement edge.
- E. If any active service laterals are identified as defective and the Contractor is unable to line the lateral from the main sewer to the property line or edge of easement, the Contractor shall inform the Engineer about the lateral's condition and shall propose a rehabilitation method that maximizes the lateral's rehabilitated length while minimizing the extent of surface disruption. The Engineer will direct the Contractor as to the acceptable approach for rehabilitating or replacing the service lateral in question.
- F. Neither the CIPP system, nor its installation, shall cause adverse effects to any of the Owner's processes or facilities. The use of the product shall not result in the formation or production of any detrimental compounds or by-products in the system or at the wastewater treatment plant. The Contractor shall notify the Owner and identify any by-products produced as a result of the installation operations, test and monitor the levels, and comply with any and all local waste discharge requirements. The Contractor shall cleanup, restore existing surface conditions and structures, and repair any of the CIPP system determined to be defective. The Contractor shall conduct installation operations and schedule cleanup in a manner to cause the least possible obstruction and inconvenience to traffic, pedestrians, businesses, and property owners or tenants.
- G. If access to private property is required to perform the work the contractor must determine access prior to starting. Clearing and other costs related to gaining access (including restoration) shall be covered under the respective pay items.
- H. Any access to private property must be approved by the homeowner prior to starting work.

- I. Contractor to assume responsibility for relocating sheds if such relocation is required to perform work. The final location of the shed will be determined on a case-by-case basis. Relocation of sheds shall be performed only upon approval of Property Owner. The Contractor shall submit such approvals to the Owner/Engineer for Information purposes. Payment for such relocation shall be approved by Owner under 'Miscellaneous Work'.
- J. Fences to be replaced in kind and a gate should be placed along the easement to allow future access by Owner forces and equipment. Each of these will be determined on a case-by-case basis directly with the Property Owner and Contractor.
- K. Contractor shall include site restoration including irrigation line repairs, driveway restoration, shrubbery replacement, etc. when choosing a route of access/repair.
- L. Contractor is allowed up to 2 weeks from the time of the installation of a temporary asphalt patch to the completion of a permanent repair. All temporary asphalt patching and the permanent repair shall be per DOT/County standards.
- M. The initial 12.5 feet of CIPP lateral lining including the seal connection to the main line shall be paid for on an individual basis under the Sewer Service lateral Cured-In-Place Liner (from 0 to 12.5 feet) Bid Item in the Schedule of Prices. CIPP lateral lining in excess of 12.5 feet shall be paid for on a linear foot basis, excluding the initial 12.5 feet, under the Sewer Service lateral Cured-In-Place Liner (Greater than 12.5-feet) Bid Item in the Schedule of Prices.

1.2 REFERENCES

- A. Where materials and methods are indicated in these specifications as being in conformance with a standard specification, it shall refer to the latest edition of the specifications and shall include all interim revisions. Listing a standard specification without further reference indicates the particular material or method shall conform to such listed specification. The following standards shall be followed while executing the work:
 - 1. ASTM D790 – Standard Test Methods for Flexural Properties of Unreinforced and Reinforced Plastics and Electrical Insulating Materials
 - 2. ASTM F1216 – Standard Practice for Rehabilitation of Existing Pipelines and Conduits by the Inversion and Curing of a Resin-Impregnated Tube
 - 3. ASTM F2561 – Standard Practice for Rehabilitation of a Sewer Service Lateral and its Connection to the Main Using a One Piece Main and Lateral Cured-in-Place Liner
 - 4. ASTM F1743 – Standard Practice for Rehabilitation of Existing Pipelines and Conduits by Pulled-in-Place Installation of Cured-in-Place Thermosetting Resin Pipe (CIPP)
 - 5. ASTM D2990 – Standard Test Methods for Tensile, Compressive, and Flexural Creep and Creep-Rupture of Plastics
 - 6. ASTM F2561 – Standard Practice for Rehabilitation of a Sewer Service Lateral and its Connection to the Main Using a One Piece Main and Lateral Cured-in-Place Liner

1.3 RELATED WORK

- A. Measurement and Payment is specified in Section 01025.
- B. Sewer Line Cleaning is specified in Section 02800.

- C. Sanitary Sewer CCTV Inspection is specified in Section 02801.
- D. Database Template Description PACP is specified in Section 02802.
- E. Cured-in-place Pipe Lining is specified in Section 02803.
- F. Manhole Lining is specified in Section 02807.
- G. Sanitary Sewer Flow Control is specified in Section 02860.

1.4 SUBMITTALS

- A. Submit to the Owner/Engineer shop drawings in accordance with the contract documents, shop drawings, product data, materials of construction, design calculations, and details of installation. The Contractor shall provide this information without delay or claim to any confidentiality. Submittals required shall include but are not limited to the following:
 - 1. Submit a Traffic Control Plan to the Owner's Representative (Engineer), which includes the following items.
 - 2. Shop drawings and schedules for all service lateral lining and appurtenances required.
 - 3. Design data and specification data sheets listing all parameters used in the lining design.
 - 4. Thickness calculations based on ASTM F1216, Appendix XI.1.2 for fully deteriorated pipe. All service lateral lining design calculations shall be sealed and signed by a South Carolina registered professional engineer.
 - 5. Detailed procedure for installing the service lateral lining.
 - 6. The service lateral lining manufacturer's name and the facility location where the service lateral lining will be manufactured.
 - 7. Material Certifications. Written certification is required from the manufacturer stating all materials used in the work were manufactured and tested in accordance with ASTM F1216 and is being used or installed in conformance with the manufacturer's recommendations.
 - 8. Customer Notifications. Submit a copy of the initial customer notification as described in this Specification.
 - 9. Storage and Delivery Procedures. Provide the lining manufacturer's recommended storage and delivery procedures. This shall include storage and delivery temperatures, maximum time from wet-out to installation, and other pertinent information.
 - 10. Material Safety Data Sheets. Submit Material Safety Data Sheets (MSDS) for each component of the service lateral lining system.
 - 11. Test Results. Prior to using any materials, furnish the proposed material's test results from an independent laboratory in conformance with these specifications. All submitted test data shall have been performed on field installed samples within the last 12 months.

Testing by an independent laboratory shall verify the products to be used meet all minimum strength standards as set forth in ASTM F1216. Testing shall also verify any product to be used on the project meets the minimum chemical resistance requirements as established in ASTM F1743, where the testing is in accordance with ASTM F1743.

12. Pipe Cleaning Narrative. Submit a narrative describing in sufficient detail the proposed methods for root cutting and cleaning the existing laterals. Prepare such narrative to include the degree of cleaning as recommended by the lining manufacturer. Such narrative shall indicate the lining manufacturer's technical representative's approval for the proposed cleaning methods.
13. Lining Thickness Calculations. Perform lining thickness calculations for each set of laterals for each manhole-to-manhole section and furnish them to the Engineer with supporting assumptions. Calculations shall be done after cleaning, televising, and other field inspections have been accomplished. Design parameters shall be used in calculations.
14. Detailed installation procedures and manufacturer's recommended cure method for each diameter and thickness of lateral liner to be installed, including lining production schedule, curing medium and method of application, inversion or installation procedures, acceptable inversion/installation heads and pressures, curing and cool-down procedures detailing the curing rate of temperature increases and cool down and the method of application, and times for each stage of the process.
15. Submit a copy of the cure logs for each lateral installation.
16. Post-lining inspection data. Post-Rehabilitation CCTV of the full lateral is not required to be submitted to the Owner in a NASSCO compatible format. However, Post-Rehabilitation CCTV shall be performed as required in this specification as a part of determining the acceptance of the lined lateral. The final lateral rehabilitation information shall be submitted in a NASSCO compatible database that shows the rehabilitated lateral in the mainline CCTV per Section 02801.
17. Contractor to complete an Owner monthly work-summary sheet by Asset ID electronically in Excel format documenting what was completed that month for each asset. This shall be submitted on a monthly basis along with the pay application. A copy of the template will be provided upon request.

1.5 QUALIFICATIONS

- A. The Contractor or Subcontractor to perform the CIPP lining work shall be fully qualified, experienced and equipped to complete this work in a timely and satisfactory manner and shall be certified and/or licensed as an installer by the CIPP lining manufacturer. The Contractor shall submit the following information to the Engineer for review and approval before any work is performed.
 1. A copy of manufacturer's licenses certificate.
 2. A qualified bidder for installing a mainline/lateral connection and lateral repair system shall have a minimum 5-years history of satisfactory performance having installed a similar manufactured system as documented by verifiable references.

3. The manufactured system shall have a minimum of 20,000 documented successful installations in the United States as documented by verifiable references.
4. A licensed and/or certified trainer and representative from the lining system manufacturer shall be on-site to assist in the work for a minimum of 2 weeks. This trainer shall have a minimum of 5 years' experience installing this system with 20,000 minimum installations.
5. As an alternate requirement, the superintendent shall have the same minimum installations and experience. Submit list with 10 similar jobs within the past 3 years that used this manufacturer's product. Provide project information such as project name, number of service connection laterals, date completed, and project references. The following information shall be submitted for review and approval:
 - a. The Contractor's years of experience in performing service lateral lining projects.
 - b. The name for the service lateral lining manufacturer and supplier for this work and previous work listed below. The Contractor shall be an approved installer as certified and/or licensed by the lining manufacturer.
 - c. A list with municipal clients for whom the Contractor has performed this type without defects or performance problems.
 - 1) The list shall contain names, email addresses, and telephone numbers for persons to contact to verify previous satisfactory performance.
 - 2) A full description for the actual work performed.
 - 3) The number of service laterals lined over the past 3 years.

1.6 NOTIFICATIONS

A. Notify the Owner and Engineer:

1. On a weekly basis of scheduled work for the upcoming week, including a map showing the area of work, and a map and list of fire hydrants that will be utilized for a water source, and a list of streets being affected. Submittal shall be provided by electronic mail in PDF format. Provide 24-hour notice for deviations from the plan that are not caused by weather or natural causes.
2. Immediately, when a collapsed pipe or other pipe failure is identified.
3. Immediately, if the conditions for the work described are found to be unsafe or impractical.
4. Immediately, if a manhole is buried, cannot be found or cannot be accessed. Along with the manhole identification number, provide a map (in PDF format) showing the location of the manhole and what procedures were used to attempt to locate the manhole.
5. Immediately of any defects posing imminent danger to the public (missing lids, covers broken during inspection, sink holes, etc.) and any observed pipe blockages, surcharging, or potential overflow conditions.
6. If the pipe configuration in the field is different than shown, or if a different asset is found, the notification shall include a diagram clearly indicating the location of structures in relation to immediately adjacent structures in PDF format via electronic mail.
7. If any obstructions are found within the easement, even if not impacting work.

B. Notify the public and coordinate with homeowners:

1. Contractor shall prepare and install yard signs to notify customers in the area of work being conducted and who to contact for information. The Owner-approved Water yard sign file will be provided by the Owner. This file is the standard sign layout to be filled in with

project specific information. (Sign specs: digital print full color two-sided coroplast 4mm 18"x24" & metal step stakes 30"x10").

- a. Approximately 25 signs are anticipated to be required.
 - b. Signs shall be placed in key intersections and at the project site, incoming/outgoing roads to the area/neighborhood, and intersections near the site at start of project.
 - c. Signs shall be placed in yards a minimum of 7 days prior to work but no more than 14 days ahead of scheduled work.
 - d. Signs shall be displayed throughout scheduled work and will be replaced if removed or damaged.
 - e. Signs shall be removed at the conclusion of the project.
2. A minimum of 72 hours prior to the inspection or work on any manhole, cleanout, service lateral, or line segment, distribute door-to-door an Owner approved Homeowner Notification door hanger describing the work to be performed, if work is performed or accessed through private property or easement adjacent to property, or if the property is potentially tied to the section of line being inspected or worked on. On the day of work and prior to beginning the work, knock on the doors of all properties that will require entering their private property to access the manholes, cleanouts, or pipes which will potentially be impacted by the work and notify occupants of the work to be performed.
 3. Contractor shall use approved magnetic car signs affixed to vehicles at all times during the project to identify affiliation with the Owner.
 4. Contractor responsible for determining route of access for the proposed work, unless specified otherwise, and is responsible for coordinating with the Property Owner to obtain any temporary access to perform the work. Clearing and other costs related to gaining access (including restoration) should be included in Contractor's pricing.
 5. Contractor to notify Property Owner of any trees or other obstructions within easements that need to be moved to access or perform the work. The Property Owner shall be given a minimum of 7 days to relocate the obstruction off of the easement at their own cost to their own chosen location. After this time period, the Contractor shall be responsible for removing and disposing of the obstruction, and all costs associated with this. Contractor to coordinate with the Engineer on each obstruction found before proceeding.
 6. On the Homeowner Notification door hanger include any restrictions on using the sewage system facilities. Describe exact days and hours when the sewer system cannot be used. Contact any home or business that cannot be reconnected within time stated in the written notice.
 7. The maximum time any home or business shall be without sanitary sewer service is 10 hours, and not between 6:00 pm and 8:00 a.m. Any service out longer than 10 hours will have service restored at contractor's expense or temporary measures taken.

1.7 GUARANTEE

- A. All lining work shall be fully guaranteed by the Contractor and manufacturer for 2 years from the final payment date. A written warranty shall be submitted to the Owner. During this period, all serious defects, including failure of the seal between the service lateral lining and the main sewer, discovered by Owner shall be removed and replaced by the Contractor in a satisfactory manner at no additional cost to Owner. At their own expense, Owner may conduct an independent television inspection of the lining work prior to the guarantee period's completion. Any defects replaced at that time shall be fully guaranteed by the Contractor and manufacturer for 2 years from the date the defect was repaired. Wrinkles, blisters, dry spots in resin, or other defects in

the finished service lateral, which in the Engineer's opinion, negatively affect the service lateral's integrity or strength or the pipe's flow capacity or performance of solids passage are unacceptable. Contractor will be responsible to remove and repair, at Contractor's expense, all such defects in a manner satisfactory to the Engineer. Defects also include but are not limited to:

- B. The lining shall be as free as commercially practical from visual defects as defined herein. Some minor waviness that, in the Engineer's opinion, will not appreciably decrease the flow cross section or affect the flow characteristics may be permissible.
- C. Warrant to Owner the equipment and materials used on this Contract, where covered by patents or license agreements, is furnished in accordance with such agreements, and the prices included herein cover all applicable royalties and fees in accordance with such license agreements. Defend, indemnify, and hold Owner and the Engineer harmless from and against any and all costs, loss, damage, or expense arising from or in any way connected with any claim of infringing on patent, trademark, or violation of license agreement.

1.8 QUALITY ASSURANCE

- A. The Contractor performing the service lateral lining work shall be fully qualified, experienced, and equipped to complete this work expeditiously and in a satisfactory manner. See Submittals section for Contractor qualifications.
- B. Be able to provide crews as needed to complete the work without undue delay and within the contract time allotted.
- C. Contractor shall ensure equipment utilized for CCTV of main lines is capable of passing through offset joints up to 1 inch minimum.
- D. The service lateral lining shall be provided by a single manufacturer. The supplier shall be responsible for providing all test requirements specified herein as applicable.
- E. The Engineer may inspect the service lateral lining after delivery. The service lateral lining shall be subject to rejection at any time if it fails to meet any requirements specified, even though sample lining may have been accepted as satisfactory by the manufacturer. Lining rejected after delivery shall be marked for identification and removed from the job site at once.
- F. Final Installed Lining Thickness. The final installed lining thickness shall not be less than or more than 10 percent greater than the required thickness. The final installed lining thickness measurement shall be determined from lining sample coupons retrieved from the sewer, plate samples or as deemed necessary by the Engineer. It shall be the Contractor's responsibility to consider site conditions and their installation process to determine the proper lining thickness to install.
- G. Non-Compliance. If the flat plate samples do not meet the required 4,500 psi flexural strength and 250,000 psi flexural elasticity modulus as outlined, actual installed samples shall be taken. The installed samples shall be taken as directed by the Engineer and in accordance with all applicable ASTM requirements. From these samples, the installed thickness shall be determined by taking an average of at least 10 thickness measurements. Installed samples shall then be prepared for re-testing in accordance with these specifications.

1.9 DELIVERY, STORAGE AND HANDLING

- A. Care shall be taken in shipping, handling, and storing to avoid damaging the service lateral lining. Extra care shall be taken during cold weather construction. Any lining damaged in shipment shall be replaced as directed by the Engineer and at no additional cost to the Owner.
- B. Any lining showing a split or tear, or which has received a blow that may have caused damage, even though damage may not be visible, shall be marked as rejected, removed at once from the job site, and shall be replaced at no additional cost to the Owner.
- C. At all times, the lining materials, including the wet-out lining, shall be maintained at a proper temperature, such as in refrigerated facilities, to prevent premature curing prior to installation. The lining shall be protected from UV light prior to installation. Any lining showing evidence of premature curing shall be rejected for use, shall be removed from the site immediately, and shall be replaced at no additional cost to the Owner.

1.10 WATER

- A. Water for use on this project may be available from the City of Georgetown. The Contractor is responsible for applying for the requisite permits, and obtaining meter and backflow assembly to be used at all times. The Contractor shall provide copies of such permits to the Owner.

PART 2 - PRODUCTS

2.1 MATERIALS

- A. Brim style (top hat) connections shall not be allowed for any reason.
- B. The service lateral lining shall be a seamless, corrosion-resistant, cured-in-place pipe lining product that seals the service lateral pipe and the junction between the service lateral pipe and main sewer. The portion of the lateral lining system that connects to the main/lateral interface shall be a full-wrap connection type.
- C. The service lateral lining shall be a resin-impregnated, flexible polyester felt, non-woven textile tube, needle punched felt, circular knit or circular braid, glass fiber reinforced plastic or equivalent material tube which is cured -in-place by an acceptable curing method. The tube shall be able to conform to bends, offset joints, bells, and disfigured pipe sections.
- D. The service lateral shall provide a 50-year service life and shall have the minimum structural properties listed below:

<u>Physical Properties</u>	<u>Minimum Standard</u>
Flexural Strength (ASTM D790).....	4,500 psi
Flexural Modulus of Elasticity (ASTM D790).....	250,000 psi

- E. The service lateral shall be designed, fabricated, and installed for the actual conditions encountered for this application including the host pipe material, in accordance with the

applicable ASTM F1216, ASTM D2990 provisions, and shall meet the following minimum design conditions:

1. AASHTO H-20 live load
 2. Soil Weight 120 pounds per cubic foot
 3. Friction coefficient $Ku'=0.130$
 4. Estimated maximum groundwater level at ground surface
 5. Fully deteriorated pipe with 2 percent (min.) ovality. If existing pipe's ovality is found to be worse, use actual percent up to 5 percent (max.).
 6. Soil Modulus 1,000 psi
 7. Safety factor = 2
 8. Soil Depth: The cover depth will be determined by field measurements.
- F. The finished lining shall have a 4.5 mm minimum thickness for all 4-inch through 6-inch laterals, unless another thickness is specifically requested and approved by the Engineer.
- G. The service lateral lining shall have sufficient wall thickness to withstand all anticipated external pressures and loads that may be imposed after installation. The design shall be performed and certified by a South Carolina registered professional engineer.
- H. The service lateral lining shall be manufactured and installed by T-Liner by LMK, SCS+L by BLD Services, LLC, or approved equal.
- I. When cured, the service lateral lining shall extend from the mainline into the lateral connection in a continuous tight fitting, watertight pipe-within-a-pipe to eliminate any visible groundwater leakage and future root growth at the lateral to mainline connection and along the lateral. The service lateral product system shall be compatible with the mainline and/or lateral pipe or lining. The lining portion within the mainline pipe shall be a full-wrap connection.
- J. When cured, the finished service lateral product shall be chemically resistant to domestic sewage over the rehabilitated pipe's expected lifetime. The lining material and resin shall be completely compatible.
- K. The connection between the service lateral and the main sewer shall be lined so a continuous overlap between the service lateral lining and the main sewer extends 3-inches minimum from the lateral along the entire circumference.
- L. A leak-free seal shall be created to form a sealing bond between the service lateral product and the host lateral and mainline pipe walls. The Contractor should use either a hydrophilic material or an epoxy-sealing component at each lining tube end to provide a leak-free seal.
- M. When cured, the lining shall form a hard, impermeable lining that is chemically resistant to chemicals found in domestic sewage.
- N. The resin system shall meet the requirements of ASTM F1216. The resin installed service lateral lining system shall produce a service lateral that will comply with the structural requirements specified herein, and shall provide chemical resistance for the flow media in the gravity pipe. The resin shall be compatible with the rehabilitation process, shall be able to cure in water's presence or absence, and shall have an initiation temperature for cure as recommended by the resin manufacturer. Unless otherwise specified, provide a general purpose or enhanced strength

unsaturated, thermosetting, polyester, vinyl ester, epoxy or silicate resin and a catalyst system compatible with the installation process. The resin shall be vacuum impregnated into the lining.

- O. Submit documentation from the resin manufacturer specifically describing the resin system's chemical characteristics including allowable mixing, impregnation, and handling time, transportation, and storage time, and recommended curing cycle including temperatures, pressures, and times. The resin manufacturer's documentation shall also include maximum allowable time for handling the impregnated tube prior to insertion and the maximum allowable elapsed time from insertion to exotherm. If remedial measures are available to extend either of the maximum allowable times indicated above, without affecting the resin's physical properties, the resin manufacturer should describe these measures and the time limits beyond which even these measures will not prevent altering the resin's physical properties.

PART 3 - EXECUTION

3.1 PRE-INSTALLATION

- A. In accordance with Section 02801, a pre-rehabilitation digital CCTV video inspection shall be done on the mainline pipe and on the service lateral with a pan and tilt camera to confirm the proposed repair falls within the limitation parameters set by the manufacturer on the following aspects:
 - 1. The location and clock reference of the lateral junctions to be lined
 - 2. Any offsets, any intrusions from the lateral into the main
 - 3. Angle at which the connection comes in
 - 4. Any changes in the lateral's approach angle for the repair length
 - 5. Potential flows coming throughout the lateral pipe
 - 6. Potential flows going through the main pipe
 - 7. Diametric connection size for the lining length
 - 8. Main pipe's size at the service lateral point
 - 9. Service lateral's condition including the presence of debris, turns, bends, changes in diameter, or other observations
 - 10. Active infiltration present within the work area vicinity
 - 11. Any defects noted in the mainline pipe or lateral shall be documented using NASSCO PACP/LACP Standards.
- B. Inform the Engineer about service laterals in which a service lateral lining cannot be installed from the main sewer to the cleanout established at the property line or easement line. The Contractor shall identify these service laterals and provide the Engineer with documentation about the conditions encountered including the CCTV inspection. If a full-length lateral lining cannot be installed, or a point repair on the service cannot be performed, the Engineer may direct the Contractor to install a short lateral lining with no cleanout required extending up the lateral from the main. The length is to be field determined to the maximum length possible, but should extend 3 feet minimum up the lateral from the main.
- C. Inform the Engineer about service laterals in which a short length service lateral product cannot be installed. The Contractor shall identify, document, and video record these services, and inform the Engineer about the conditions encountered. If a short length lateral lining cannot be installed, the service connection will be "cut and buffed" to restore a 95% minimum service opening.

3.2 LINE PREPARATION

- A. Prior to installing the service lateral product, the area around the lateral sealing surface in the main and lateral shall be inspected. Waste product build-up, hard scale, roots, lateral cutting debris, or resin slugs shall be removed using high-pressure water jetting or in-line cutters. All laterals to be lined shall be cleaned as required prior to lining. The term “cleaned” shall mean removing all sand, dirt, roots, grease, and other solids or semisolid materials from the interior face of the sewer mainlines and the service laterals.
- B. Built-up deposits on the main and lateral pipe walls shall be removed. The removal shall reach at least 1 foot beyond the scheduled service lateral installation length to allow the bladder to inflate tightly against the pipe walls ensuring a smooth transition from service lateral product to the existing pipe wall.
- C. Televiser the lateral to provide a detailed record of existing conditions and lateral connections. Either a push camera from the cleanout or a launch camera from the main line are acceptable. Have a copy of the pre-lining inspections in the field. Immediately prior to lining insertion, the camera shall traverse the lateral to inspect for debris that may have entered the line after the existing condition inspection.
- D. Where active infiltration is present, and when it is recommended by the service lateral lining manufacturer, the infiltration shall be stopped in advance by grouting.
- E. Additional precautions need to be taken when applying the sleeve to a main pipe lined with a CIPP lining with a polyolefin coating. The coating is to be lightly scarified, scraping off the coating in the main CIPP in the service lateral lining’s vicinity and verified by the Engineer. This scuffing is mandated for service lateral linings required to adhere to the pipe wall. Service lateral linings with hydrophilic seal materials are not required to have the existing lining scarified.
- F. The Contractor shall be responsible, if needed, for bypassing sewage while installing the service lateral lining product. In cases where the temporary sewage backup is accepted by the Owner and the property owner as a replacement for bypassing, the Contractor shall be responsible for all damage caused by sewage backing up into properties or sanitary sewer overflows.

3.3 INSTALLATION

- A. CIPP lining of the service lateral shall be from the main sewer to the existing cleanout at the property line or edge of easement line. If a cleanout does not exist, the Contractor shall install a cleanout at the property line or edge of easement line at a location designated by the Engineer and terminate the rehabilitation or replacement pipe at this new cleanout.
- B. The service lateral lining shall be vacuum-impregnated with resin (wet-out) under controlled conditions. The resin volume used shall be sufficient to fill all voids in the textile lining material at nominal thickness and diameter. The volume shall be adjusted by adding 5% to 10% excess resin for the change in resin volume due to polymerization and to allow for any resin migration into the cracks and joints in the original pipe. All resin shall be contained within the translucent bladder during vacuum impregnations. No dry or unsaturated area in the lateral tube shall be acceptable upon visual inspection.

- C. The service lateral lining product shall be loaded on the applicator apparatus, attached to a robotic manipulator device, and positioned at the cleanout or pipe opening of the service connection that is to be rehabilitated. For service lateral full-wrap style linings with compression gaskets, the mainline lining and bladder shall be wrapped around the "T" launching device and held firmly by placing four (4) hydrophilic material bands around the main lining. For service lateral full-wrap linings that do not use hydrophilic material, a 300 ml volume adhesive sealant shall be applied to the main/lateral interface, and shall be applied as a 2-inch wide band on the main lining. For service lateral brim-sill connection style linings, 300 ml minimum volume excessive resin or hydrophilic materials shall be applied to the main/lateral interface, and shall be applied as a band on the main brim-seal. The robotic device with a television camera shall be used to align the repair product with the service connection opening. The insertion pressure shall be adjusted to fully deploy the service lateral product into the lateral connection and hold the service lateral product tight to the main and lateral pipe walls.
- D. The pressure apparatus shall include a bladder with sufficient length in the main and lateral lines so the inflated bladder extends beyond the ends of the service lateral product's lateral tube and main line tube, pressing the end edges flat against the internal pipe wall, thus forming a smooth transition from service lateral product to pipe diameters without a step, ridge, or gap between the service lateral product and the lateral and mainline pipes' inner diameters.
- E. For service lateral linings with hydrophilic sealing materials, the main bladder shall be inflated causing the main sheet to unwrap and expand, embedding the hydrophilic material between the main lining and the main pipe as the main lining is pressed tight against the main pipe.
- F. After insertion is completed, recommended pressure shall be maintained on the impregnated service lateral product according to ASTM F1216, pressing the lining firmly against the inner pipe wall during the entire curing process. The lining shall be cured at ambient temperatures or by a suitable heat source. In no instance will sewage be used to invert or cure linings or calibration tubes.
- G. The finished service lateral lining shall be free from dry spots, lifts, and delamination. The installed service lateral lining should not inhibit the CCTV post installation video inspection for the mainline and service lateral pipes or future pipe cleaning operations. For service lateral linings with compression gaskets, the CIPP shall taper at each end providing a smooth transition to accommodate video equipment and maintain proper flow in the mainline. In all cases, the finished product shall provide an airtight/watertight verifiable non-leaking connection between the main sewer and sewer service lateral. During the warranty period, any defects with the service lateral that affect the lateral connection's performance, cleaning, or water tightness shall be repaired at the Contractor's expense in a manner acceptable to Owner.
- H. Following the lining installation, provide the Engineer with post-rehabilitation CCTV, an electronic photo, and recorded data identifying the location and showing the completed work and restored condition for all the rehabilitated service laterals from the sewer main to the service reconnection point. The extents and specifics of lining for each lateral shall also be recorded on the record drawings for the project. The final lateral rehabilitation information shall be submitted in a NASSCO compatible database that shows the rehabilitated lateral in the mainline CCTV per Section 02801.

3.4 FIELD TESTING AND ACCEPTANCE

- A. The lining's field acceptance shall be based on the Owner's and Engineer's evaluation of the installation including post-lined digital CCTV inspection and reviewing certified test data for the installed pipe samples. The CCTV inspection for each lateral shall extend 10 feet minimum past the end of the rehabilitation work on the service lateral. For laterals where a cleanout was installed, the CCTV inspection shall include the cleanout and the connection to the existing, undisturbed service lateral.
- B. The lining shall have zero groundwater infiltration, and each lateral shall pass a 2-minute 4 psi air test conducted by the Contractor as described below.
 - 1. After completing construction or earlier if the Engineer deems advisable, provide the necessary equipment and labor to perform low positive pressure air tests in accordance with ASTM C1103, or ASTM F1216 provisions as appropriate for size and material type.
 - 2. This test shall be performed in the Engineer's presence and on all gravity sewer pipe material types. This test shall also include sewer services to the cleanout assembly and service lines from manholes. It is imperative the plugs be installed and braced to prevent blowouts. A 6-psi pressure relief device must be used. No one shall be allowed in or near the manholes during pressurization, testing, or depressurization.
- C. A flat plate sample shall be collected by Contractor for every 50 lateral installations, and the sample shall be submitted to a third party testing laboratory to confirm strength properties (flexural strength and flexural modulus) in accordance with ASTM F1216. The Contractor shall maintain Chain of Custody records for all CIPP samples to ensure no tampering or misrepresentation of the installed liner. Additional testing may be required at the discretion of the Owner if samples do not meet test criteria.
- D. All service connections shall be open, clear, and watertight.
- E. The lining shall have no evidence of splits, cracks, breaks, lifts, kinks, pinholes, delaminations, crazing or other defects.
- F. If any defective lining is discovered after it has been installed, it shall be removed and replaced by the Contractor with a new lining, a new pipe, or other measures with the Engineer's approval at no additional cost to Owner. Any lining installation not meeting specified strengths or thickness shall be addressed with other acceptable remediation measures or credit as approved by the Engineer. The re-inspection requirements as listed above shall apply to this re-installed section of line.

3.5 CLEAN-UP

- A. After the installation work and testing have been accepted, restore the project area affected by the operations to a condition at least equal to what existed prior to initiating construction activities.

PART 4 – CLOSEOUT

4.1 Provide in accordance with Section 01740.

END OF SECTION

SECTION 02807
MANHOLE LINING

PART 1 - GENERAL

1.1 SCOPE OF WORK

- A. Furnish all labor, materials, equipment and incidentals required and install the manhole lining system and appurtenances as specified herein. The protective manhole lining shall be used to rehabilitate the interior of all designated existing sewer manholes.
- B. Where indicated in the drawings or as directed by the Owner/Engineer, work may require patching and filling cracks and spalls in manhole walls, benches, chimneys and inverts; stopping infiltration with chemical or cementitious grout; rebuilding brickwork in inverts, walls, and benching; resetting or replacing manhole frame and cover assemblies; installing chimney seals; installing new drop assemblies; coating manhole inverts; installing a cementitious or epoxy monolithic coating to the entire manhole; and adjusting elevation of manhole frames and covers.
- C. The Contractor shall accurately field measure and size each individual manhole. The Contractor is reminded that each existing sewer manhole designated to receive the lining may have a different configuration and varying field dimensions. All field measurements shall conform to the requirements of the monolithic lining manufacturer.
- D. The manhole lining shall not be installed until all main sewer, service lateral, and manhole work is complete.
- E. Each manhole shall be thoroughly cleaned and then inspected for loose or missing bricks, loose mortar, holes, etc. All leaks shall be plugged prior to manhole lining. Separate bid items are included in the Schedule of Prices for the following:
 - 1. Repairing and rebuilding brickwork for inverts, walls, chimneys and benches with new brick and mortar.
 - 2. Patching, filling and repairing cracks and spalls.
 - 3. Removing and resetting existing manhole frames and covers.
 - 4. Removing and disposing of existing manhole frames and covers and installing new ones.
 - 5. Sealing existing manhole chimneys.
 - 6. Installing new drop assemblies.
 - 7. Installing Monolithic Lining System.
 - 8. Coating manhole inverts.

1.2 SUBMITTALS

- A. Identify the staging area for deployment of manhole repair equipment for each work area.
- B. Submit to the Owner/Engineer, in accordance with the contract documents, shop drawings and product data for all manhole rehabilitation materials specified in this Section for each manhole to be rehabilitated.
 - 1. Shop drawings and product data on the chemical grout and additives, cementitious compound, waterproofing, and corrosion control materials that will be used, the installation method, testing and equipment. For the materials that will be used, identify and furnish references for successful use of the materials in similar applications.
 - 2. Submit a Traffic Control Plan to the Owner's Representative (Engineer) in accordance with Section 01570.
 - 3. Contractor to complete an Owner monthly work-summary sheet by Asset ID electronically in Excel format documenting what was completed that month for each asset. This shall be submitted on a monthly basis along with the pay application. A copy of the template will be provided upon request.
 - 4. Quality control procedures for all work and installations.
 - 5. All testing results shall be submitted to Engineer and Owner.
 - 6. Written statement indicating compliance with the 2-year guarantee for all manhole work as required herein.

1.3 REFERENCE STANDARDS

- A. American Society for Testing and Materials (ASTM)
- B. ASTM C39 - Standard Test Method for Compressive Strength of Cylindrical Concrete Specimens
- C. ASTM C109 - Standard Test Method for Compressive Strength of Hydraulic Cement Mortars
- D. ASTM C293 - Standard Test Method for Flexural Strength of Concrete (Using Simple Beam With Center-Point Loading)
- E. ASTM C321 - Standard Test Method for Bond Strength of Chemical-Resistant Mortars
- F. ASTM C496 - Standard Test Method for Splitting Tensile Strength of Cylindrical Concrete Specimens
- G. ASTM C596 - Standard Test Method for Drying Shrinkage of Mortar Containing Portland Cement
- H. ASTM C666 - Standard Test Method for Resistance of Concrete to Rapid Freezing and Thawing

- I. ASTM C1244 - Standard Test Method for Concrete Sewer Manholes by the Negative Air Pressure (Vacuum) Test
- J. ASTM D638 – Standard Test Method for Tensile Properties of Plastics
- K. ASTM D695 – Standard Test Method for Compressive Strength of Rigid Plastics
- L. ASTM D790 – Standard Test Method for Flexural Properties of Unreinforced and Reinforced Plastics and Electrical Insulating Materials
- M. ASTM D2240 – Standard Test Method for Rubber Property – Durometer Hardness
- N. ASTM D4414 – Standard Practice for Measurement of Wet Film Thickness by Notch Gages
- O. ASTM D4541 – Standard Test Method for Pull-Off Strength of Coatings Using Portable Adhesion Testers
- P. ASTM F2551 – Standard Practice for Installing a Protective Cementitious Liner System in Sanitary Sewer Manholes
- Q. NACE - The published standards of National Association of Corrosion Engineers (NACE International), Houston, TX.
- R. NACE RPO 188-99 Discontinuity (Holiday) Testing of New Protective Coatings on Conductive Substrates
- S. Where reference is made to one of the above standards, the revision in effect at the time of the pre-construction meeting shall apply.

1.4 QUALIFICATIONS

- A. The installer performing the work shall be fully qualified, experienced and equipped to complete this work expeditiously and in a satisfactory manner and shall be an approved installer as certified and licensed by the manufacturer. The installer shall have successfully installed the proposed lining system in a minimum of 400 manholes as documented by verifiable references. There shall be no exceptions to this experience requirement. The Contractor shall submit the following information to the Owner for review and approval before any work is performed.
- B. The Contractor shall have 5 years of experience in performing this type of specialized work and in installing the specified lining system.
- C. The Contractor shall also be capable of providing crews as needed to complete this work without delay.
- D. The Contractor shall submit the name of the manufacturer and supplier for this work and previous work listed below.
- E. The Contractor shall submit a list of municipal clients that the installer has performed this type of work including contact names, phone numbers, and number of manholes.

- F. The Contractor shall submit a certified statement from the manufacturer that he/she is a certified and/or licensed installer of the liner.
- G. The Owner reserves the right to approve or disapprove the Contractor/Installer, based on the submitted qualifications.

1.5 NOTIFICATIONS

A. Notify the Owner and Engineer:

1. On a weekly basis of scheduled work for the upcoming week, including a map showing the area of work and a list of streets being affected. Submittal shall be provided by electronic mail and a map and list of fire hydrants that will be utilized for a water source, in PDF format. Provide 24-hour notice for deviations from the plan that are not caused by weather or natural causes.
2. Immediately, when a collapsed pipe or other pipe failure is identified.
3. Immediately, if the conditions for the work described are found to be unsafe or impractical.
4. Immediately, if a manhole is buried, cannot be found or cannot be accessed. Along with the manhole identification number, provide a map (in PDF format) showing the location of the manhole and what procedures were used to attempt to locate the manhole.
5. Immediately of any defects posing imminent danger to the public (missing lids, covers broken during inspection, sink holes, etc.) and any observed pipe blockages, surcharging, or potential overflow conditions.
6. If the pipe configuration in the field is different than shown or if a new asset found, the notification shall include a diagram clearly indicating the location of structures in relation to immediately adjacent structures in PDF format via electronic mail.
7. If any obstructions are found within the easement, even if not impacting work.

B. Notify the public and coordinate with homeowners:

1. Contractor shall prepare and install yard signs to notify customers in the area of work being conducted and who to contact for information. The Owner-approved Water yard sign file will be provided by the Owner. This file is the standard sign layout to be filled in with project specific information. (Sign specs: digital print full color two-sided coroplast 4mm 18"x24" & metal step stakes 30"x10").
 - a. Approximately 25 signs are anticipated to be required.
 - b. Signs shall be placed in key intersections and at the project site, incoming/outgoing roads to the area/neighborhood, and intersections near the site at start of project.
 - c. Signs shall be placed in yards a minimum of 7 days prior to work but no more than 14 days ahead of scheduled work.
 - d. Signs shall be displayed throughout scheduled work and will be replaced if removed or damaged.
 - e. Signs shall be removed at the conclusion of the project.
2. A minimum of 72 hours prior to the inspection or work on any manhole, cleanout, service lateral, or line segment, distribute door-to-door an Owner approved Homeowner Notification door hanger describing the work to be performed, if work is performed or accessed through private property or easement adjacent to property, or if the property is

potentially tied to the section of line being inspected or worked on. On the day of work and prior to beginning the work, knock on the doors of all properties that will require entering their private property to access the manholes, cleanouts, or pipes which will potentially be impacted by the work and notify occupants of the work to be performed.

3. Contractor shall use approved magnetic car signs affixed to vehicles at all times during the project to identify affiliation with the Owner.
4. Contractor responsible for determining route of access for the proposed work, unless specified otherwise, and is responsible for coordinating with the Property Owner to obtain any temporary access to perform the work. Contractor shall provide copies of temporary access/easement agreements made with Property Owners. Clearing and other costs related to gaining access (including restoration) should be included in Contractor's pricing.
5. Contractor to notify Property Owner of any trees or other obstructions within easements that need to be moved to access or perform the work. The Property Owner shall be given a minimum of 7 days to relocate the obstruction off of the easement at their own cost to their own chosen location. After this time period, the Contractor shall be responsible for removing and disposing of the obstruction, and all costs associated with this. Contractor to coordinate with the Engineer on each obstruction found before proceeding.

1.6 GUARANTEE

- A. All monolithic cementitious lining installed shall be guaranteed by the Contractor for a period of two years from the date of final payment. During this period, all defects discovered in the monolithic lining, as determined by the Owner, shall be repaired or replaced in a satisfactory manner by the Contractor at no cost to the Owner.
- B. All epoxy lining installed shall be guaranteed by the Contractor for a minimum period of five years from the date of final payment. During this period, all defects discovered in the monolithic lining, as determined by the Owner, shall be repaired or replaced in a satisfactory manner by the Contractor at no cost to the Owner.
- C. The Contractor is responsible for properly preparing the existing manhole for lining prior to the installation of the monolithic lining system, including stopping all leaks, patching voids, removing steps/manhole rungs, cleaning, removing rubble, root removal, etc.

1.7 QUALITY ASSURANCE

- A. Coating product(s) shall be capable of being installed and cured properly within an active sanitary sewer manhole environment. Coating product(s) shall be resistant to all forms of chemical or bacteriological attack found in municipal sanitary sewer systems; and, capable of adhering to the manhole structure substrates.
- B. Repair product(s) shall be fully compatible with coating product(s) including ability to bond effectively forming a composite system.
- C. Installer shall utilize equipment for the spray application of the coating product(s) which has been approved by the coating product manufacturer; and, shall have received training on the operation and maintenance of said equipment from the coating product manufacturer.

- D. Installer shall be trained by, or have their training approved and certified by, the coating product manufacturer for the handling, mixing, application and inspection of the coating product(s) to be used as specified herein.
- E. The supplier shall be responsible for the provisions of all test requirements specified in the above referenced ASTM Standards as applicable.
- F. Inspections of the lining products and materials may also be made by any representative of the Owner. The lining products and materials shall be subject to rejection at any time on account of failure to meet any of the Specification requirements, even though samples may have been accepted as satisfactory at the place of manufacture. Manhole lining materials rejected after delivery shall be marked for identification and shall be removed from the job at once.
- G. Installer shall be trained in the use of testing or inspection instrumentation and knowledgeable of the proper use, preparation and installation of the coating product(s) to be used as specified herein. Installer shall provide appropriate guidance on inspecting coating application prior to construction.
- H. Installer shall initiate and enforce quality control procedures consistent with the coating product(s) manufacturer recommendations and applicable standards as referenced herein.

1.8 DELIVERY, STORAGE AND HANDLING

- A. Care shall be taken in shipping, handling and placing to avoid damaging the lining products. Extra care may be necessary during cold weather construction. Any lining product or material damaged in shipment shall be replaced as directed by the Owner.
- B. Any lining product showing deterioration, or which has been exposed to any other adverse storage condition that may have caused damage, even though no such damage can be seen, shall be marked as rejected and removed at once from the work.
- C. While stored, the lining products shall be adequately packaged and protected. The lining products shall be stored and handled in a manner as recommended by the manufacturer and safety data sheets (SDS).
- D. Do not store coating products near flame, heat or strong oxidants.

1.9 SITE CONDITIONS

- A. Contractor shall conform to all local, state and federal regulations including those set forth by OSHA, RCRA and the EPA and any other applicable authorities.
- B. Confined space entry, flow diversion and/or bypass plans shall be presented by Contractor to perform the specified work.

PART 2 - PRODUCTS

2.1 MATERIALS TO STOP ACTIVE LEAKS

- A. All active leaks in manholes to be rehabilitated shall be stopped prior to performing the rehabilitation. Elimination of active leaks shall be paid for in related other bid items, no separate payment shall be made.
- B. To stop active leaks in the manhole, the Contractor must use one or more of the following materials and procedures to stop the active leaks prior to completing the rehabilitation.
 - 1. Premixed Fast-Setting, Volume-Stable Waterproof Cement Plug - This material shall consist of hydraulic cement, graded silica aggregates, special plasticizing and accelerating agents. It shall not contain chlorides, gypsums, plasters, iron particles, aluminum powder or gas-forming agents, or promote the corrosion of steel it may come in contact with. The cement plug should have the following minimum requirements:

Minimum Requirements		
Compressive Strength	ASTM C109	>1000 psi, 1hr. >2500 psi, 24 hrs.
Sulfate Resistance	ASTM C267	No weight loss after 15 cycles @ 2000 ppm
Freeze/Thaw	ASTM C666 "Method A"	100 cycles
Pull Out Strength	ASTM C234	14,000 lbs.
Set Time		<5.0 minutes

- 2. Chemical Grout - Repair work shall be in accordance with ASTM F 2414, and manufacturers recommended installation methods. Use in accordance with the manufacturer’s recommendations for the specific application. The grout shall be of a formula that is suitable for application in a manhole that is susceptible to frost, if applicable for the regional climate.
 - a. Drilling and injection method shall use a hydrophilic polyurethane chemical grout manufactured by Avanti or equal unless otherwise approved by the Owner/Engineer.
 - b. Exterior chemical curtain grouting method shall use a hydrophobic polyurethane chemical grout manufactured by Avanti or equal unless otherwise approved by the Owner/Engineer.
 - c. Expanded Gasket Procedure shall use Oil Free Oakum with hydrophilic polyurethane chemical grout manufactured by Avanti or equal used for sealing larger cracks and manhole joints, unless otherwise approved by the Owner/Engineer.
- 3. Obtain approval from Owner/Engineer for materials to stop active leaks before starting the Field Work.
- 4. Obtain approval from Owner/Engineer for application equipment prior to starting the Field Work.

2.2 PATCHING, FILLING AND REPAIRING CRACKS AND SPALLS IN CONCRETE AND MASONRY MANHOLES

- A. A quick-setting cementitious material shall be used as a patching material and is to be mixed and applied according to manufacturer’s recommendations and shall have the following minimum requirements:

Physical Properties		
Compressive Strength	ASTM C109	>1800 psi, 1 hr. >2600 psi, 24hr. >3000 psi, 28 days
Bond	ASTM C882	>1600 psi, 28 days
Applied Density		105 lbs. pcf ± 5 lbs.
Shrinkage	ASTM C596	0% at 90% R.H.
Placement Time		5 to 10 minutes
Set Time		15 to 30 minutes

- B. The material used to mix product shall be clean and potable. No material (other than water) shall be used with or added to the patching product without prior approval or recommendation from manufacturer.

2.3 COATINGS FOR INVERTS

- A. A quick-setting material shall be used to coat the inverts of manholes as indicated on the Drawings. The coating shall be mixed and applied according to manufacturer’s recommendations and shall have the following minimum requirements:

Physical Properties		
Compressive Strength	ASTM C109	>1800 psi, 1 hr. >2600 psi, 24hr. >3000 psi, 28 days
Bond	ASTM C882	>1600 psi, 28 days
Applied Density		105 lbs. pcf ± 5 lbs.
Shrinkage	ASTM C596	0% at 90% R.H.
Placement Time		5 to 10 minutes
Set Time		15 to 30 minutes

- B. Water used to mix product shall be clean and potable. Potable water need not be tested. No material (other than water) shall be used with or added to the patching product without prior approval or recommendation from manufacturer.

2.4 INTERIOR FLEXIBLE CHIMNEY SEALS

- A. Interior flexible chimney seals shall prevent leakage of water into the manhole through the frame joint area and the area above the manhole cone including all extensions to the chimney area. The seal shall remain flexible allowing for repeated vertical or horizontal movements of the frame due to frost lift, ground movement, or the thermal movement of pavement.

1. Flexible Internal Rubber Sleeve

- a. The flexible rubber sleeve shall be extruded or molded from a high-grade rubber conforming to the applicable material requirements of ASTM C923, with a minimum 1500 psi tensile strength, a maximum 18% compression set and a hardness (durometer) of 48 ± 5 .
- b. The sleeve shall have a minimum thickness of 0.130 inches and a range of coverage which allows a span of up to 24 vertical inches of chimney without the use of an extension. The area of the seal that compresses against the manhole frame casting and the chimney/cone shall have a series of sealing fins to facilitate a watertight seal.
- c. Any splice used to fabricate the sleeve shall be hot vulcanized and have a strength such that the sleeve shall withstand a 180-degree bend with no visible separation.
- d. The expansion bands used to compress the sleeve against the manhole shall be integrally formed from 16-gauge stainless steel conforming to the applicable material requirements of ASTM C923, Type 304, with no welded attachments and shall have a minimum width of 1-3/4 inches.
- e. The bands shall have a minimum adjustment range of 2-1/2 diameter inches and the mechanism used to expand the band shall have the capacity to develop the pressures necessary to make a watertight seal. The band shall be permanently held in place with a positive locking mechanism which secures the band in its expanded position after tightening.
- f. Rubber sleeve shall be manufactured by Cretex Specialty Products or approved equal.

2.5 BRICKWORK AND MASONRY FOR REPAIRING AND REBUILDING INVERTS, BENCHES, WALLS AND CHIMNEYS IN EXISTING MANHOLES

- A. Bricks shall be sound, hard, uniformly burned, regular and uniform in shape and size. Underburned or salmon brick shall not be acceptable. Only whole brick shall be used.
- B. Bricks for channels and shelves shall conform to ASTM C32, Grade SS except that the mean of five tests for absorption shall not exceed 8 percent and no individual brick exceed 11 percent.
- C. Mortar shall be composed of 1 part Portland cement, 2 parts sand, and hydrated lime not to exceed 10-lbs to each bag of cement. Portland cement shall be ASTM C150, Type II; hydrated lime shall conform to ASTM C207.
- D. Sand shall be washed, cleaned, screened, well graded with all particles passing a No. 4 sieve and conform to ASTM C33.

2.6 RAISING MANHOLE FRAMES TO FINISHED GRADE

- A. Grade adjustment rings shall be manufactured using a high compression molding process to produce a finished density of 120 g/l ((7.5 pcf).
- B. Grade adjustment rings may contain either an upper and lower keyway (tongue and groove) for vertical alignment and/or an adhesive trench on the underside with a flat top.
- C. “Finish” or “Flat” rings may either have a keyway (groove) on the underside for vertical alignment and/or an adhesive trench with a flat upper surface. These rings shall be available in heights (thicknesses) which will allow final adjustment of the frame and cover or grate to within ¼” (one quarter inch) to ½” (one half inch) of the specified final elevation.
- D. “Finish” rings may also have a keyway on the upper surface of the inner diameter to facilitate installation of an “Angle” ring.
- E. “Angle” rings may either have an upper and lower keyway (tongue and groove) for vertical alignment and/or an adhesive trench on the underside. When required, the “Angle” ring or rings shall allow final adjustment of the frame and cover or grate to within ¼” (one quarter inch) to ½” (one half inch) of the specified final elevation.
- F. Grade adjustment rings shall be manufactured by Cretex Specialty Products or approval equal.

2.7 MANHOLE FRAME AND COVERS

- A. Manhole frames and covers shall be of good quality, strong, tough, even grained cast iron smooth, free from scale, lumps, blisters, sand holes and defects of any kind that render them unfit for the service for which they are intended. Manhole frame and cover seats shall be machined to a true surface. Castings shall be thoroughly cleaned and subject to hammer inspection. Manhole frames and covers shall be Owner approved standard as specified in Section 02730.

2.8 MANHOLE MONOLITHIC LINING SYSTEMS

- A. The monolithic manhole lining system shall be designed and installed to protect concrete, brick, mortar, and other manhole surfaces from corrosion. The products shall be designed to stop infiltration, root intrusion, and further deterioration in the manhole. The interior surfaces to be protected shall include the walls, benches, inverts, pipe junctions and the chimney (corbel). The table below outlines the different monolithic manhole lining systems and the respective product specification paragraph(s) for each lining system. The pH limits listed below are typical and the type of manhole lining used shall be as shown on the drawings or as directed by the Owner/Engineer.
- B. **CONDITION A: CEMENTITIOUS MANHOLE LINING - WALLS AND BENCHES**
 - 1. Liner material shall consist of a cementitious based product capable of forming a structurally enhanced monolithic covering. The cementitious lining system shall be a pumpable Portland based cement or fused calcium aluminate cement. The lining shall be installed via low-pressure application only. The materials shall be suitable for all the specified design conditions. The following materials are pre-approved:

- a. Strong Seal MS-2A, MS-2C, or High Performance by Strong Seal Systems
 - b. QM-1s Restore or Aluminaliner by Quadex
 - c. Cemtec Silatec MSM or CAM by A.W. Cook Cement
 - d. Sewpercoat PG by Kerneos, Inc.
 - e. Permacast MS-10,000 or CR-9000 by Action Products Marketing Corp.
 - f. PerpetuCrete MSC or CA by Protective Liner Systems
 - g. Mainstay ML-72, ML-CA or ML-PF by Madewell
 - h. Reliner MSP or Maximum CA Cement by Standard Cement Materials
 - i. High Performance by Strong Seal Systems
 - j. Aluminaliner PF by Quadex
 - k. Sewpercoat PG by Kerneos, Inc.
 - l. Mainstay ML-PF by Madewell
 - m. Cemtec HITECH 100 by A.W. Cook Cement
 - n. Maximum CA Plus Cement by Standard Cement Materials
2. The cementitious lining shall be self-forming and shall be applied to cover all interior manhole surfaces including the invert, walls, benches and chimney. All cementitious lining shall be troweled smooth after spray application. The cured cementitious lining shall be applied to a minimum total thickness of 1 inch. The cured surfacing thickness shall be smooth and continuous with proper sealing connections to all unsurfaced areas.
 3. The materials used in the cementitious lining systems shall be mixed on site in accordance with the manufacturer’s recommendations. Water shall only be added to the materials during the mixing process and prior to material pumping or spray application. No water shall be added at the nozzle.
 4. The cementitious liner when cured shall have the following minimum characteristics as measured by the applicable ASTM standards referenced herein:

Compressive Strength	ASTM C109	> 8,000 psi @ 28 days
Tensile Strength	ASTM C496	> 600 psi @ 90 days
Flexure Strength	ASTM C293	> 1,200 psi @ 28 days
Shrinkage @ 90% Relative Humidity	ASTM C596	0% @ 28 days
Freeze/Thaw Resistance	ASTM C666	100 cycles with no visible damage.

5. The cementitious lining shall provide a minimum service life of 25 years.
6. The cured cementitious lining shall be continuously bonded to all the brick, mortar, concrete, chemical sealant, grout, pipe, and other surfaces inside the sewer manhole.
7. Chemical sealants or grouts used to seal active manhole leaks, to patch cracks, to fill voids and to otherwise prepare the manhole surfaces for the lining installation shall be suitable for the intended purpose and shall be compatible with the lining as certified by the manufacturer.
8. When cured, the monolithic cementitious lining shall form a continuous, tight-fitting, hard, impermeable surfacing which is suitable for sewer system service and chemically resistant to any chemicals or vapors normally found in domestic sewage.
9. The monolithic cementitious lining shall cover the complete interior of the existing sewer manhole including the benches (shelves). The lining shall effectively seal the interior surfaces of the sewer manhole and prevent any penetration or leakage of groundwater infiltration.

10. The lining shall be compatible with the thermal condition of the existing sewer manhole surfaces. Surface temperatures will range from 20oF to 100oF. Provide test data on shrinkage of the cementitious lining based on ASTM C596.

C. CONDITION A: CEMENTITIOUS MANHOLE LINING - INVERT CHANNEL COATING

1. All invert channels shall be coated with cementitious mortar.
2. The cementitious mortar used for the invert channel shall be suitable for the intended purpose and shall be compatible with the materials used for the lining system. The cementitious mortar for the invert channel shall be as manufactured by the cementitious liner manufacturer.

D. CONDITION B: EPOXY MANHOLE LINING

1. The materials to be utilized in the lining of manholes shall be designed and manufactured to withstand the severe effects of hydrogen sulfide in a wastewater environment. Manufacturer of corrosion protection products shall have proven experience in the production of the lining products utilized and shall have satisfactory installation record.
2. The materials shall be applied by an approved certified applicator and must meet the manufacturer’s recommendations.
3. Equipment for installation of lining materials shall be high quality grade as deemed by the Owner and be as recommended by the manufacturer.
4. The epoxy liner when cured shall have the following minimum characteristics as measured by the applicable ASTM standards referenced herein:

Color		Any
Solids Content		100%
Solvent Content		0%
Compressive Strength	ASTM D695	135,00 psi
Tensile Strength	ASTM D638	7,500 psi
Tensile Elongation	ASTM D638	1.5%
Flexural Strength	ASTM D790	11,500 psi
Shore Hardness, Type D	ASTM D2240	80
Bond Strength	ASTM D4541	> Tensile Strength of Concrete
Primer Required		None

PART 3 - EXECUTION

3.1 INSTALLATION - GENERAL

- A. The Contractor shall complete manhole installation prior to lining including surface preparation, patching of voids and sealing of leaks, invert channel coating, and other required manhole rehabilitation work. The Contractor shall dispose of any resulting material.

- B. The Contractor shall notify all property owners who discharge sewage directly to the manhole being surfaced that their service will be discontinued while the lining is being placed, cured and active pipe and service connections reopened.
- C. The Contractor shall provide bypass pumping of sewage flows where and when the rehabilitation work is being performed.
- D. Prior to placing the lining, the Owner and the manufacturer's representatives (when on site) along with the Contractor must inspect and approve the surface preparation work. The Contractor shall notify the Owner when the manholes are ready for inspection. The Contractor is responsible for ensuring proper installation conditions including temperature and moisture.
- E. If the drawings call for a flexible ring-chimney seal, then the lining shall be installed to 1 inch below the bottom of the manhole ring. The termination of and surface of the lining shall be suitable for proper installation of the manhole ring-chimney seal. If a ring-chimney seal is not required, then manhole lining shall be installed to the bottom of the manhole ring.
- F. Temperature limitations must be handled as appropriate and as approved by the manufacturer.
- G. A complete, watertight seal shall be provided at pipe and manhole wall connections.
- H. The Contractor shall reopen all of the existing active pipe connections in each sewer manhole following lining.

3.2 INSTALLATION - CEMENTITIOUS LINERS

- A. The Installer shall furnish and place cementitious lining in each manhole as shown on the Drawings and where directed by the Owner. The installation of the lining shall be in complete accordance with the applicable provisions of ASTM F2551 and the manufacturers' specifications. A representative of the manufacturer shall be present during actual installation of lining of the first ten (10) manholes.
- B. All bottom and horizontal surfaces including the benches shall have the lining applied to the required thickness by hand troweling or spray-on methods. Cementitious linings that are spray-applied shall be troweled smooth after application.
- C. All side vertical surfaces shall have the monolithic lining applied to the required thickness by a spray-on method in one pass or application. All lining shall be troweled smooth after spray application.

3.3 INSTALLATION - EPOXY LINERS

- A. Epoxy liners shall be installed on newly installed cementitious liner. Epoxy lining shall be applied only after the cementitious liner has fully set.
- B. The corrosion resistant barrier shall be spray applied as per the manufacturer's recommendation and shall have an average minimum finished thickness of 100 mils when applied in conjunction with cementitious liner.

- C. The Contractor shall maintain dry conditions for the corrosion resistant liner application and subsequent curing as per manufacturer's recommendations.

3.4 FIELD TESTING AND ACCEPTANCE

- A. Field acceptance of manhole lining shall be based on the Owner's evaluation of the proper surfacing of the manhole per field inspections. Acceptance shall also be based on the Owner's evaluation of the appropriate installation and curing test data.
- B. Minimum Liner Thickness:
 - 1. The cementitious lining shall provide a continuous monolithic surfacing with uniform thickness throughout the manhole interior, and this depth shall be verified by the use of a feeler gauge or by counting the number of bags required. Special attention shall be given to the chimneys of brick manholes to insure that liner material covers and seals the bottom joints at all masonry units. If the thickness of the cementitious lining is not uniform or is less than specified, it shall be repaired or replaced.
 - 2. Epoxy Liner Thickness Measurement: During application of corrosion resistant liner, a wet film thickness gauge, meeting ASTM D4414, shall be provided by the Contractor. Measurements shall be taken, documented and attested by the Contractor for submission to the Owner. Additional measurements may be made by the Owner.
- C. The Owner may enter the manholes to inspect the benching, invert channels, manhole wall/pipe connections, surface preparation, and other parts of the work. The Contractor shall provide forced air ventilation, gas monitors and detectors, harnesses, lights, etc. for the Owner to enter the manhole and perform the inspection in complete accordance with OSHA requirements.
- D. There shall be no groundwater infiltration or other leakage through the manhole wall after it has been lined. If leakage is found, it shall be eliminated with an appropriate method as recommended by the liner manufacturer and upon approval by the Owner.
- E. All pipe connections shall be open and clear.
- F. Cementitious Material Property Testing: One 2X2 inch sample cube shall be taken for every 50 bags of material used. Samples shall be sprayed from nozzle, identified in the presence of the Owner's representative and sent, by the Owner's representative, to an independent test laboratory, selected by the Contractor for compression strength testing as described in ASTM C-109.
 - 1. Cementitious Liner: There shall be no cracks, voids, pinholes, uncured spots, dry spots, lifts, de-laminations or other type defects in the cementitious lining.
 - 2. Holiday Testing of Epoxy Liner: After proper curing, epoxy liner shall be inspected for holidays with high-voltage holiday detection equipment provided by the Contractor. Reference NACE RPO 188-99 for performing holiday detection.
 - a. An induced holiday shall be made into the coated surface and serve to determine the min/max voltage to be used to test the coating.
 - b. The holiday tester shall be initially set to 100 volts per mil of specified thickness but shall be increased if it cannot detect induced holidays.

- c. All detected holidays shall be marked and repaired by abrading the coating surface with grit disk paper or other hand tooling method. After abrading and cleaning, additional coating can be hand applied to the repair area. All touch-up/repair procedures shall follow the coating manufacturer's recommendations. Documentation on areas tested, results and repairs made shall be provided to Owner by Contractor.
- d. If any defective lining is discovered after it has been installed, it shall be repaired or replaced in a satisfactory manner within 72 hours. This requirement shall apply for the entire guarantee period.

3.5 DOCUMENTATION

- A. Rehabilitation Documentation: Contractor shall complete a Rehabilitation Report for each sewer manhole that includes the following information:

1. Owner Name
2. Project Location
3. Cleaning Date
4. Rehabilitation Date
5. Superintendent's Name
6. Rehabilitation Weather Conditions
7. Manhole Number
8. Manhole Location
9. Manhole Diameter
10. Manhole Height
11. Manhole Substrate Material (i.e., brick, block, pre-cast concrete, etc.)
12. Liner Thickness Applied
13. Type and Amount of Patching Material Used
14. Type of Liner Used
15. Number of Bags/Tubs of Cementitious Liner Used
16. Gallons of Epoxy Applied
17. Steps Removed?
18. Description of any problems during installation
19. Duration of Vacuum Test
20. Holiday Test Voltage
21. Number of Holidays Found
22. Signature of Tester

END OF SECTION

THIS PAGE INTENTIONALLY LEFT BLANK

SECTION 02860
SANITARY SEWER FLOW CONTROL

PART 1 - GENERAL

1.1 SCOPE OF WORK

- A. This Section includes all materials, labor, and equipment required to provide bypass flow control for new sanitary sewer line construction, upgrades or rehabilitation. This section also includes all materials, labor, and equipment required to provide bypass flow control for conducting proper PACP CCTV inspection of sewers.
- B. The Contractor shall be responsible for maintaining wastewater flow in all public and private pipes during construction. All bypass pumping systems shall be manned by the Contractor during non-working hours, seven (7) days per week as necessary. During the installation and/or rehabilitation of sections of the sewer system, it is required that the Contractor maintain sewage flows in the system and from all abutting properties at all times. No sanitary service shall be interrupted by the Contractor except as absolutely necessary and then for only very short periods of time of no more than thirty (30) minutes and only when coordinated with the affected property Owner. During main line cured-in-place pipe lining operations, interruption at the street tie-in will be allowed for up to twenty-four (24) hours, when coordinated, by the Contractor, with the affected property Owner.
- C. The Contractor is required to furnish all power, maintenance, etc. to implement the bypass flow control system necessary to divert the existing flow around the work area for the work's duration. The design, installation, and operation for the temporary bypass pumping system shall be solely the Contractor's responsibility. Bypass pumping is required to adequately control the flow as listed in Paragraph 3.01.
- D. The Contractor shall exhaust all attempts with other methods of flow control (i.e. work in low flow times, plugs, dams, blocking, etc.) prior to recommending bypass pumping. If bypass pumping is determined to be needed, concurrence from the Owner is required before proceeding.
- E. If access to private property is required to perform the work, the contractor must obtain access prior to starting any work. Clearing and other costs related to gaining access (including restoration) should be included in contractor's pricing. Contractor to assume responsibility for relocating sheds if such relocation is required to perform work. The final location of the shed will be determined on a case-by-case basis.
- F. If fence removal is required, fences shall be replaced in kind and a gate should be placed along any easements to allow future access by Owner forces and equipment. Each of these will be determined on a case-by-case basis directly with the Property Owner and Owner.
- G. Contractor shall include site restoration including irrigation line repairs, driveway restoration, shrubbery replacement, etc. when choosing a route for bypass equipment.
- H. Contractor is solely responsible for any damages resulting from his/her operations.

1.2 RELATED WORK

- A. Measurement and Payment is specified in Section 01025.
- B. Sanitary Sewer CCTV Inspection is specified in Section 02801.
- C. Cured-in-place Pipe Lining is specified in Section 02803.
- D. Sewer Service Lateral CIPP Lining is specified in Section 02806.
- E. Manhole Lining is specified in Section 02807.
- F. Pipe Bursting is specified in Section 02850.

1.3 SUBMITTALS:

- A. Submit the following to Engineer prior to commencing work for review and approval.
 - 1. Bypass Sewage Pumping Plan. Plan shall contain, at minimum, the following:
 - a. Staging areas for pumps.
 - b. Sewer plugging method and types of plugs.
 - c. Number, size, material, location and method of installation of suction piping.
 - d. Number, size, material, method of installation and location of installation of discharge piping.
 - e. Calculations of bypass pump sizes, capacity, number of each size to be on site and power requirements. Pump sizing shall clearly indicate compliance with requirements of this Specification.
 - f. Calculations of static lift, friction losses, and flow velocity (pump curves showing pump operating range shall be submitted).
 - g. Standby power generator size and location and spill prevention and control measures.
 - h. Downstream discharge plan along with method of protecting discharge manholes or structures from erosion and damage.
 - i. Thrust and restraint block sizes and locations.
 - j. Sections and plans showing suction and discharge pipe location, depth, embedment, select fill and special backfill.
 - k. Method of noise control for each pump and/or generator.
 - l. Any temporary pipe supports and anchoring required.
 - m. Schedule for installation of and maintenance of bypass pumping lines.
 - n. Plan indicating monitoring locations.
 - o. All items related to testing, inspection, maintenance, and monitoring as described in these section.
 - p. All other incidental items necessary and/or required to ensure facilities are properly protected including protecting the access and bypass pumping locations from damage due to the discharge flows, and compliance with the requirements and permit conditions specified in the Contract Documents.
 - q. For sewer rehabilitation by lining methods, generic plans may be developed for typical situations and various sizes to be implemented.

PART 2 - PRODUCTS

2.1 BYPASS EQUIPMENT

- A. All equipment utilized for bypass pumping shall be specifically designed for intended purpose. All piping, pumps, etc. in contact with sanitary sewage shall be manufactured with materials designed for use in a sewage environment.
- B. All pumps used shall be fully automatic self-priming units which do not require foot valves or vacuum pumps in the priming system.
- C. The pumps shall be electric, hydraulic, or diesel powered.
- D. All pumps used shall be constructed to allow dry running for long time periods to accommodate cyclical flows.
- E. Above ground pumps and/or power units shall be located inside a temporary portable berm to contain any fuel or sewage that may spill during the normal course of operation.
- F. Hard discharge piping shall be butt-welded HDPE with a minimum pressure rating of 2.5 times the total dynamic pump head.
- G. Under no circumstances will irrigation type piping or glued PVC pipe be allowed.
- H. Discharge hose may be allowed on rehabilitation projects for short-term setups (less than or equal to 48 hours) on short sections with approval from the Engineer. Hoses shall have no leaks, and all couplings shall be quick connecting with gaskets.
- I. The multiple pump header system shall have check valves to facilitate pump removal, service, and/or replacement while the system remains operational.
- J. All above ground pumps and/or power units shall be equipped with sound attenuation measures to reduce noise levels to 75-decibels maximum at a 50-foot distance from the equipment during all operation periods or meet other noise requirements governing the location of construction. The most stringent noise requirements must be met at all time. If equipment is operated between 8:00 PM and 6:00 AM, this equipment shall also be provided with a sound attenuation 3-sided enclosure including a roof constructed of 2 x 4 lumber frame with 1/2-inch plywood sheathing and 2-inch extruded polystyrene foam panels attached to the inside of the entire enclosure. The enclosure shall be portable to allow the enclosure to be moved when bypass pumping equipment is moved.
- K. Include 100% mechanical redundancy installed online with a float or ultrasonic type system to switch to the standby system automatically if the primary system fails.
- L. The discharge location (the point where the bypass main reenters the gravity sewer system) shall be to existing manholes and constructed with adequate sealant materials to minimize sewer gas and odor release to the maximum extent possible.

PART 3 - EXECUTION

3.1 FLOW REQUIREMENTS

- A. Provide bypass sewage pumping, as required, around the area of work being performed. Bypass pumping shall be the full responsibility of the Contractor.
- B. For television inspection, bypass pumping should be utilized if the depth of wastewater flow within the sewer mains to be inspected exceed the following:

6" – 10" pipe: 20% of pipe's diameter

12" – 24" pipe: 25% of pipe's diameter

24" pipe: 30% of pipe's diameter

If Contractor has exhausted all other means for flow control (plugs, night time work, etc.), the depth of wastewater flow within the sewer mains to be inspected may be allowed up to 50% of pipe diameter with approval from the Engineer.

- C. For complete bypass required for new construction and pipe rehabilitation, the bypass system shall be a sufficient capacity to handle full pipe capacity for the pipeline section being bypassed times 1.25 and shall provide and maintain sufficient flow at all times to prevent any backwater flooding due to obstructions caused by the construction. Prior to starting work, the Contractor shall submit required information as described in this specification to the Engineer for review and approval. No work shall commence until the Engineer provides approval.

3.2 GENERAL REQUIREMENTS

- A. If at any time the Contractor is unable to properly bypass pump the sewage, construction will be stopped until the Contractor is able to continue work in an acceptable manner. The Contractor will not receive additional contract time for delays caused by improper equipment, labor, or breakdowns.
- B. Discharge of sewage to the ground, creeks, and/or storm sewers shall be prohibited. Any violation shall be corrected immediately. If the Owner is required to alleviate any prohibited discharges, the Contractor shall be charged two times the Owner's cost of labor, equipment and materials. All costs shall be deducted from the Contract Amount.
- C. Service shall be maintained at all times. Surcharges due to plugging the sewer line for bypass pumping shall be maintained to prevent backups in services and overflows at any point in the system. Contractor is fully responsible for any backups or overflows caused by bypass pumping operations or any associated work.
- D. The Contractor shall be capable of pumping all the sewage in the existing line under all weather and seasonal conditions. All pumping equipment to be used shall be submitted to the Owner for review and approval.
- E. Bypass pumping systems are required to be operated and continuously 24-hours per day.

- F. All suction and discharge piping shall be free of leaks and designed to carry the required pumped sewage. Any leaks shall be repaired immediately. If the piping used is inadequate in size, amount of hose on site, or condition, the Contractor shall be required to replace the hose as directed by the Owner's Representative.
- G. The use of a partial plug may be considered if approved by the Engineer.

3.3 PERFORMANCE REQUIREMENTS

- A. It is essential that the system operate uninterrupted throughout the project's duration. Provide, maintain, and operate all bypass facilities such as dams, plugs, pumping equipment (primary and backup units as required), conduits, all necessary power equipment, and all other labor and equipment necessary to intercept the incoming flow before it reaches the point where it would interfere with the work, carry it past the work area, and return it to the existing system downstream of the work.
- B. The temporary pumping system's design, installation, and operation shall be the Contractor's responsibility. The bypass system shall meet all codes and requirements for regulatory agencies having jurisdiction.
- C. Provide all necessary means to safely convey the sewage past the work area. The Contractor will not be permitted to stop or impede the sewer main flows under any circumstances.
- D. No flow diversion around the work area shall be performed in a manner that will cause damage to or surcharging of the Owner's system. The diversion shall protect public and private property from damage and flooding.

3.4 FIELD QUALITY CONTROL AND MAINTENANCE

- A. **Testing:** Prior to actual operation, test the complete bypass pumping system for leaks and pressure using clean water. Bypass piping shall be hydrostatically tested following each setup and prior to flow diversion to a minimum pressure 2.5 times the pump(s) total dynamic head. The Engineer shall be given a 24-hour notice prior to testing.
- B. **Inspection:** Inspect the bypass pumping system on a continuous basis to ensure the system is working properly. A daily checklist for the entire system shall be required. The checklist shall contain all bypass pumping system components, and shall be specifically developed to address all aspects for the individual project. The daily checklist shall be submitted to the Engineer. The completed daily checklists shall be maintained, available for review, and on-site for the project's duration.
- C. **Maintenance Service:** Ensure the temporary bypass pumping system is properly maintained, and a responsible operator shall be readily available at all times when pumps are operating.
- D. **Monitoring:**
 - 1. During bypass pumping, continuously monitor all bypass pumping system components.
 - 2. A telemetry system or designated personnel to maintain 24-hour onsite monitoring shall be required to alert the Contractor to system malfunctions or high liquid levels in manholes.

E. Additional Materials:

1. Spare parts for pumps and piping shall be kept on site as required.
2. Adequate hoisting equipment for each pump and accessories shall be maintained on site.

F. Preparations and Precautions:

1. Locate any existing utilities in the area selected for the bypass pipelines. Locate the bypass pipelines to minimize any disturbance to existing utilities, and obtain approval for the pipeline locations. Pay all costs associated with relocating utilities and obtaining all approvals.
2. During all bypass pumping operations, protect the Owner's system (pumping station, conveyance system, etc.) as applicable from damage inflicted by any equipment. The Contractor is responsible for all physical damage to the system caused by human or mechanical failure.

G. Installation and Removal:

1. When plugging or blocking is no longer needed for work performance, it is to be removed in a manner that permits the sewage flow to slowly return to normal without surge flows to prevent surcharging or causing other major disturbances downstream.
2. When working inside manholes, sewers, or force mains, exercise caution and comply with all applicable OSHA requirements.
3. Bypass pipeline installation is prohibited in all wetland areas. The pipeline shall be located, if possible, off streets and sidewalks and on road shoulders. If in easements, the bypass pipeline shall be within the easement area acquired for the project.
4. When the bypass pipeline crosses local streets and private driveways, place the bypass pipelines in trenches and cover with temporary pavement. Obtain any property owner approvals before placing the temporary pipeline.

3.5 CLEAN-UP

- A. Upon acceptance of the work, the Contractor shall restore the project area affected by the operations to a condition at least equal to that existing prior to the work.

END OF SECTION

DIVISION 3

PAGE INTENTIONALLY LEFT BLANK

SECTION 03600
GROUTING

PART 1 - GENERAL

1.1 RELATED DOCUMENTS

- A. Drawings and general provisions of the Contract, including General and Supplementary Conditions and Division 01 Specification Sections, apply to this Section.

1.2 SUMMARY

- A. Section Includes:
 - 1. Portland cement grout.
 - 2. Cement grout.
 - 3. Nonshrink cementitious grout.
- B. Related Requirements:
 - 1. Section 02807 "Manhole Lining."

1.3 ACTION SUBMITTALS

- A. Product Data: Submit manufacturer information regarding grout and surface preparation, mixing and installation.
 - 1. Commercially manufactured nonshrink cementitious grout. Include catalog cuts, technical data, storage requirements, product life, working time after mixing, temperature considerations, and conformity to the specified ASTM standards.
 - 2. Cement grout. Include the type and brand of cement, the gradation of fine aggregate, product data on any proposed admixtures and the proposed grout mix.
 - 3. Concrete grout. Include data as required for concrete and for fiber reinforcement as delineated in Section 03301.

1.4 INFORMATIONAL SUBMITTALS

- A. Manufacturer's Certificate: Certify that products meet or exceed specified requirements.
- B. Manufacturer Instructions: Submit instructions for mixing, handling, surface preparation, and placing nonshrink grouts.
- C. Field Quality-Control Submittals: Indicate results of Contractor-furnished tests and inspections.
- D. Qualifications Statement:

1. Submit qualifications for manufacturer.

1.5 QUALITY ASSURANCE

- A. Perform Work according to the standards referenced herein.
- B. Manufacturer: Company specializing in manufacturing products specified in this Section with minimum ten years' experience in production and use of provided grouts.
- C. Independent testing laboratory shall meet the requirements of ASTM E329 and ASTM C1077 and be acceptable to the Engineer. Laboratories affiliated with the Contractor or in which the Contractor or officers of the Contractor's organization have beneficial interest are not acceptable.
- D. Field Testing:
 1. Assist in the sampling of materials and cooperate by allowing free access to the work and permitting the use of ladders, scaffolding, and such incidental equipment as may be required. Methods of testing will comply with the applicable ASTM Standards.

1.6 DELIVERY, STORAGE, AND HANDLING

- A. Inspection: Accept materials on Site in manufacturer's original packaging and inspect for damage.
- B. Store materials according to manufacturer instructions. Limit total storage time from date of manufacture to date of installation to six months or the manufacturer's recommended storage time, whichever is less.
- C. Remove immediately from the site material which becomes damp, contains lumps, or is hardened and replace with acceptable material.
- D. Protection:
 1. Protect materials from moisture and dust by storing in clean, dry location.
 2. Provide additional protection according to manufacturer instructions.

1.7 AMBIENT CONDITIONS

- A. Maximum Conditions: Do not perform grouting if temperatures exceed 90 degrees F.
- B. Minimum Conditions: Do not perform grouting if the minimum temperature of base plates, supporting concrete and grout are less than 40 degrees F. Maintain minimum temperature of 40 degrees F before, during, and after grouting, until grout has set.

PART 2 - PRODUCTS

2.1 PORTLAND CEMENT GROUT

- A. Portland Cement: Comply with ASTM C150/C150M, Type I and II.
- B. Water:
 - 1. Potable.
 - 2. No impurities, suspended particles, algae, or dissolved natural salts in quantities capable of causing:
 - a. Corrosion of steel.
 - b. Volume change increasing shrinkage cracking.
 - c. Efflorescence.
 - d. Excess air entraining.
- C. Fine Aggregate:
 - 1. Washed natural sand.
 - 2. Gradation:
 - a. Comply with ASTM C33/C33M.
 - b. Represented by smooth granulometric curve within required limits.
 - 3. Free from injurious amounts of organic impurities according to ASTM C40/C40M.
- D. Mix:
 - 1. Portland cement, sand, and water.
 - 2. Do not use ferrous aggregate or staining ingredients in grout mixes.

2.2 NONSHRINK CEMENTITIOUS GROUT

- A. Description:
 - 1. Pre-mixed and ready-for-use formulation requiring only addition of water.
 - 2. Nonshrink, non-corrosive, nonmetallic, non-gas forming, not containing expansive cement and no chlorides.
 - 3. No shrinkage when tested in conformity with ASTM C827/C827M.
- B. Performance and Design Criteria:
 - 1. Certified to maintain initial placement volume or expand after set, and to meet following minimum properties when tested according to ASTM C1107/C1107M for Grades B, C, D and CRD-C621 nonshrink grout:
 - a. Setting Time:
 - 1) Initial: Approximately two hours.

- 2) Final: Approximately three hours.
 - 3) Comply with ASTM C191.
- b. Maximum Expansion: 0.10 to 0.40 percent.
 - c. Minimum Compressive Strength:
 - 1) One-Day: 4,000 psi (27.6 MPa).
 - 2) Seven-Day: 7,000 psi (48.3 MPa).
 - 3) 28-Day: 10,000 to 10,800 psi (69.0 to 74.5 MPa).
 - 4) Comply with CRD-C621.

2.3 CONCRETE GROUT

- A. Description: Conform to the requirements of Section 03301, except as follows. Proportion with Type II cement, coarse and fine aggregates, water, water reducing admixture, and air entraining agent to produce specified mix performance:
 1. Average Strength (ASTM C579): 3500 psi (24.1 MPa) at 28 days.
 2. Maximum Coarse Aggregate Size: 3/8-inch (9.5 mm).
 3. Minimum Cement Content: 540 lbs per cubic yard (245 Kg per cubic meter).
 4. Maximum Water to Cement Ratio: 0.45.
 5. Maximum Slump: 5 inches (127 mm).
- B. Add synthetic reinforcing fibers to the concrete grout mix at the rate of 1.5 lbs (0.68 Kg) of fibers per cubic yard (meter) of grout. Add fibers from manufacturer's pre-measured bags and according to manufacturer's recommendations to ensure complete dispersion of fiber bundles as single monofilaments within the concrete grout.

PART 3 - EXECUTION

3.1 EXAMINATION

- A. Verify areas to receive grout.

3.2 PREPARATION

- A. Place grout where indicated or specified over existing concrete and cured concrete which has attained its specified design strength unless otherwise approved by Engineer.
- B. Remove defective concrete, ice, laitance, dirt, oil, grease, form release agents, paints, and other foreign material from concrete surfaces, which may affect the bond or performance of the grout by brushing, hammering, chipping, sand blasting or other similar dry mechanical means until sound and clean concrete surface is achieved. Irregular voids or projecting coarse aggregate need not be removed if they are sound, free of laitance and firmly embedded into the parent concrete.
 1. Air compressors used to clean surfaces in contact with grout shall be the oil-less type or equipped with an oil trap in the airline to prevent oil from being blown onto the surface.

- C. Roughen concrete lightly, but not to interfere with placement of grout.
- D. Remove foreign materials from metal surfaces in contact with grout.
- E. Align, level, and maintain final positioning of components to be grouted.
- F. Wash concrete surfaces clean and then keep moist for at least 24 hours prior to the placement of nonshrink cementitious or cement grout. Saturation may be achieved by covering the concrete with saturated burlap bags, use of a soaker hose, or flooding the surface. Upon completion of the 24 hour period, remove visible water from the surface prior to grouting.
- G. Support equipment during alignment and installation of grout by shims, wedges, blocks, or other approved means. Prevent bond of shims, wedges and blocking devices by bond breaking coatings and remove after grouting unless otherwise approved by Engineer. Grout voids created by the removal of shims, wedges, and blocks.

3.3 INSTALLATION - GENERAL

A. Formwork:

- 1. Construct leakproof forms anchored and shored to withstand grout pressures.
- 2. Install formwork with clearances to permit proper placement of grout.

B. Mixing - Portland Cement Grout:

- 1. Use proportions of two parts sand and one part cement, measured by volume.
- 2. Prepare grout with water to obtain consistency to permit placing and packing.
- 3. Mix water and grout in two steps:
 - a. Premix using approximately 2/3 of water.
 - b. After partial mixing, add remaining water to bring mix to desired placement consistency and continue mixing two to three minutes.
- 4. Mix only quantities of grout capable of being placed within 30 minutes after mixing.
- 5. Do not add additional water after grout has been mixed.
- 6. Minimum Compressive Strength (ASTM C 579):
 - a. In 48 hours: 2,400 psi.
 - b. In 28 days 7,000 psi.

C. Placing of Grout:

- 1. Place grout material quickly and continuously.
- 2. Do not use pneumatic-pressure or dry-packing methods.
- 3. Apply grout from one side only to avoid entrapping air.
- 4. Do not vibrate placed grout mixture or permit placement if area is being vibrated by nearby equipment.
- 5. Thoroughly compact final installation and eliminate air pockets.
- 6. Do not remove leveling shims for at least 48 hours after grout has been placed.

D. Curing:

1. Prevent rapid loss of water from grout during first 48 hours by using wet burlap bags, soaker hoses or ponding.
 2. Immediately after placement, protect grout from premature drying, excessively hot or cold temperatures, and mechanical injury.
 3. After grout has attained its initial set, keep damp for minimum three days.
- E. Reflect existing underlying expansion joints, partial contraction joints, and construction joints through the grout.

3.4 INSTALLATION - CONCRETE GROUT

- A. Inspect finished slabs and scheduled to receive concrete grout. ICRI CSP 6 (medium scarification). Protect and keep the surface clean until placement of concrete grout.
- B. Remove debris and clean the surface by sweeping and vacuuming of all dirt and other foreign materials. Pressure wash the surface. Do not flush debris into tank drain lines.
- C. Saturate the concrete surface for at least 24 hours prior to placement of the concrete grout by use of saturated burlap bags, soaker hoses or ponding. Remove excess water just prior to placement of the concrete grout. Place a cement slurry immediately ahead of the concrete grout so that the slurry is moist when the grout is placed. Work the slurry over the surface with a broom until it is coated with approximately 1/16 to 1/8-in (1.58 to 3.18 mm) thick cement paste.
- D. Place concrete grout to final grade using the scrapers of the installed mechanical equipment as a guide for surface elevation and to eliminate high and low spots. Unless specifically approved by the equipment manufacturer, do not use mechanical scraper mechanisms powered by their motors as a finishing machine or screed to push grout.
- E. Steel trowel finish. Cure the concrete grout as specified for cast-in-place concrete in Section 03301.

3.5 SCHEDULE

- A. Use particular types of grout as follows:
 1. General Purpose Nonshrink Cementitious Grout (CRD-C621 Grade D): Use at locations where nonshrink grout is indicated, except for base plates greater in area than 3-feet wide by 3-feet long (0.91 meters wide by 0.91 meters long).
 2. Flowable (precision) Nonshrink Cementitious Grout (CRD-C621 Grade B or C): Use under base plates greater in area than 3-feet wide by 3-feet long (0.91 meters wide by 0.91 meters long). Use at locations indicated to receive flowable (precision) nonshrink grout. Flowable (precision), nonshrink, cementitious grout may be substituted for general purpose nonshrink cementitious grout.
 3. Cement Grout: Use where indicated.

END OF SECTION

APPENDIX I

PACP MAIN LINE CCTV REPORTS

THIS PAGE INTENTIONALLY LEFT BLANK



Vortex Services
521 Federal Road
Livermore, ME 04253
(207) 897-3348

Main Inspections Summary

Weston & Sampson - 2319762

Mainline ID	End date/time	Surveyed by	Start MH	Finish MH	Material	Height	Total length	Length	
1834 - 1833	5/24/2023 2:11 AM	Mike Swilley	1834	1833	VCP	12 in.	257.000 ft.	257.000 ft.	
							Sub-Total	257.0 ft.	257.0 ft.
							Total	257.0 ft.	257.0 ft.



Vortex Services
 521 Federal Road
 Livermore, ME 04253
 (207) 897-3348

Main Inspections Small Photos and Scoring

Mainline ID: 1834 - 1833	City: Georgetown, SC	Street: Hwy 17	Project name: Weston & Sampson - 2319762
Start date/time: 5/23/2023 11:15 PM	Total length: 257.000 ft.	Weather: 1	Surveyed by: Mike Swilley
Upstream MH No: 1834	Depth US:	Downstream MH No: 1833	Depth DS: 8.000 ft.
Shape: C	Material: VCP	Height: 12 in.	Width:
Additional info:			

Scores



Calculated at: **5/24/2023 12:17:38 PM**

Grade	Structural:				O&M:				Overall:	
	Segment Grade	Pipe Rating	Quick Rating	Pipe Rating Index	Segment Grade	Pipe Rating	Quick Rating	Pipe Rating Index	Pipe Rating	Pipe Rating Index
1	0	0	0000	0.0	0	0	0000	0.0	0	0.0
2	0									
3	0									
4	0									
5	0									

Observations

Distance	Dir.	Length	From/To	Code	Modifier	Rating	Remarks
0.0 ft.	D		/	AMH			1834
0.0 ft.	D		/	MWL			

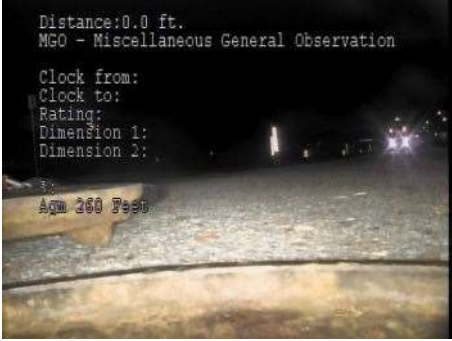
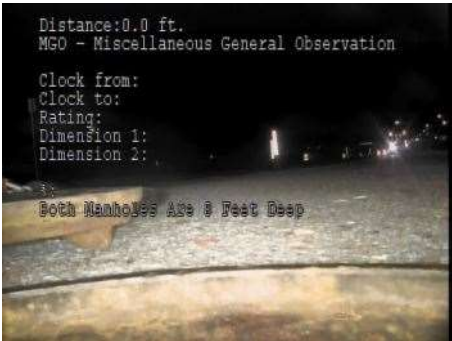
Observations

Distance	Dir. Length	From/To Code	Modifier	Rating	Remarks
0.0 ft.	D	/	MGO		Agm 260 Feet
<div style="display: flex; justify-content: space-between; align-items: flex-start;"> <div style="width: 30%; font-family: monospace; font-size: 0.8em;"> Distance:0.0 ft. MGO - Miscellaneous General Observation Clock from: Clock to: Rating: Dimension 1: Dimension 2: Agm 260 Feet </div> <div style="width: 65%; text-align: center;">  </div> </div>					
0.0 ft.	D	/	MGO		Both Manholes Are 8 Feet Deep
<div style="display: flex; justify-content: space-between; align-items: flex-start;"> <div style="width: 30%; font-family: monospace; font-size: 0.8em;"> Distance:0.0 ft. MGO - Miscellaneous General Observation Clock from: Clock to: Rating: Dimension 1: Dimension 2: Both Manholes Are 8 Feet Deep </div> <div style="width: 65%; text-align: center;">  </div> </div>					
0.0 ft.	D	/	MGO		12 Inch
<div style="display: flex; justify-content: space-between; align-items: flex-start;"> <div style="width: 30%; font-family: monospace; font-size: 0.8em;"> Distance:0.0 ft. MGO - Miscellaneous General Observation Clock from: Clock to: Rating: Dimension 1: Dimension 1: #: 12 Inch </div> <div style="width: 65%; text-align: center;">  </div> </div>					

Observations

Distance	Dir.	Length	From/To	Code	Modifier	Rating	Remarks
----------	------	--------	---------	------	----------	--------	---------

83.3 ft. D 9 / TF



85.7 ft. D 3 / TFA



140.3 ft. D 2 / TFC



Observations

Distance	Dir.	Length	From/To	Code	Modifier	Rating	Remarks
----------	------	--------	---------	------	----------	--------	---------

142.7 ft. D 9 / TF



189.8 ft. D 2 / TFC



192.4 ft. D 9 / TF



Observations

Distance	Dir. Length	From/To Code	Modifier	Rating	Remarks
----------	-------------	--------------	----------	--------	---------

239.9 ft. D 9 / TF



257.0 ft. D / AMH

1833



Inspection's photos

Main Inspections Pipe Run and Scoring

Project name:	Mainline ID:	City:	Street:
Weston & Sampson - 2319762	1834 - 1833	Georgetown, SC	Hwy 17
Start date/time:	Direction:	Weather:	Location code:
5/23/2023 11:15 PM	D	1	A
Shape:	Material:	Height:	Width:
C	VCP	12 in.	

Scores

Calculated at: **5/24/2023 12:17:38 PM**

Grade	Structural:				O&M:				Overall:	
	Segment Grade	Pipe Rating	Quick Rating	Pipe Rating Index	Segment Grade	Pipe Rating	Quick Rating	Pipe Rating Index	Pipe Rating	Pipe Rating Index
1	0			0.0	0			0.0		0.0
2	0			0.0	0			0.0		0.0
3	0	0	0000	0.0	0	0000	0.0	0	0.0	0.0
4	0			0.0	0			0.0		0.0
5	0			0.0	0			0.0		0.0

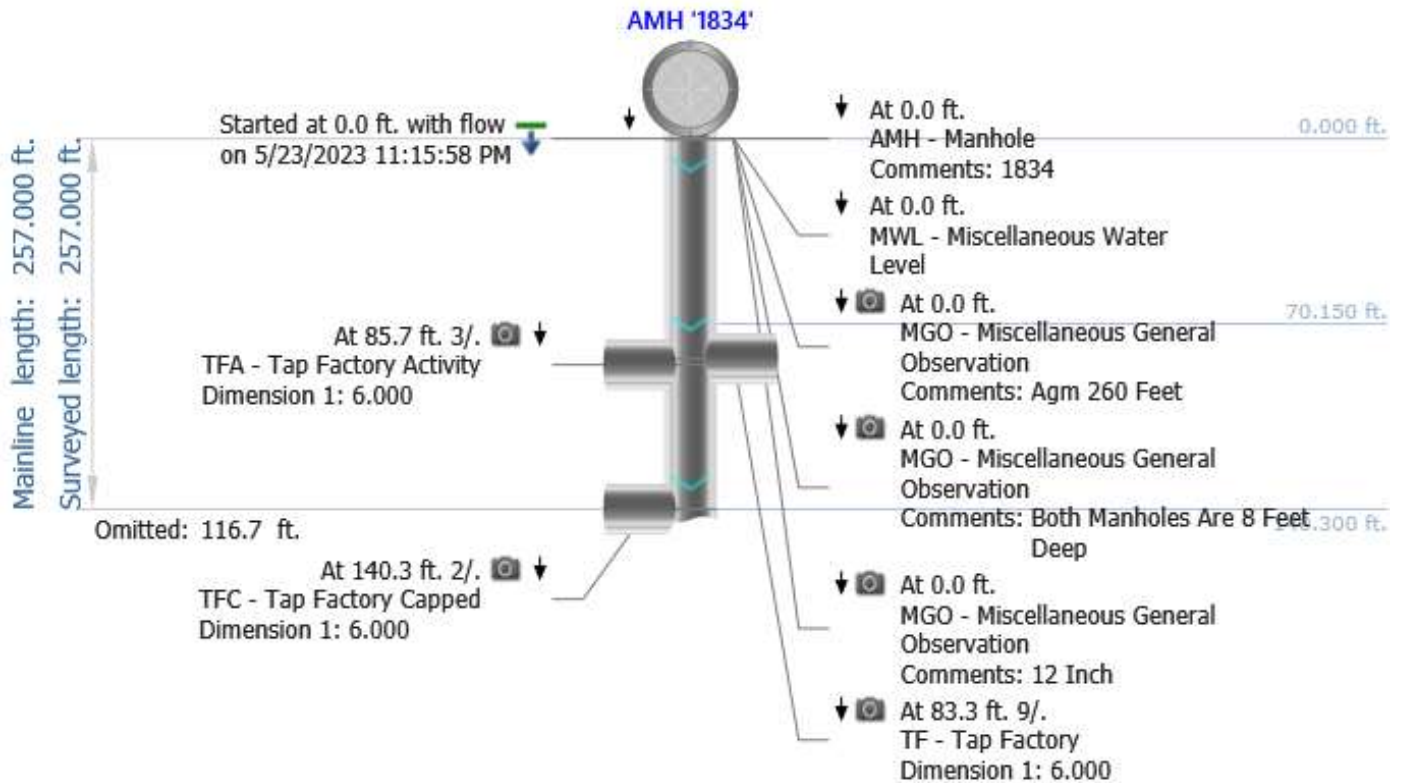

Project name:
**Weston & Sampson -
2319762**

Mainline ID:
1834 - 1833

Start date/time:
5/23/2023 11:15 PM

Direction:
D

Weather:
1

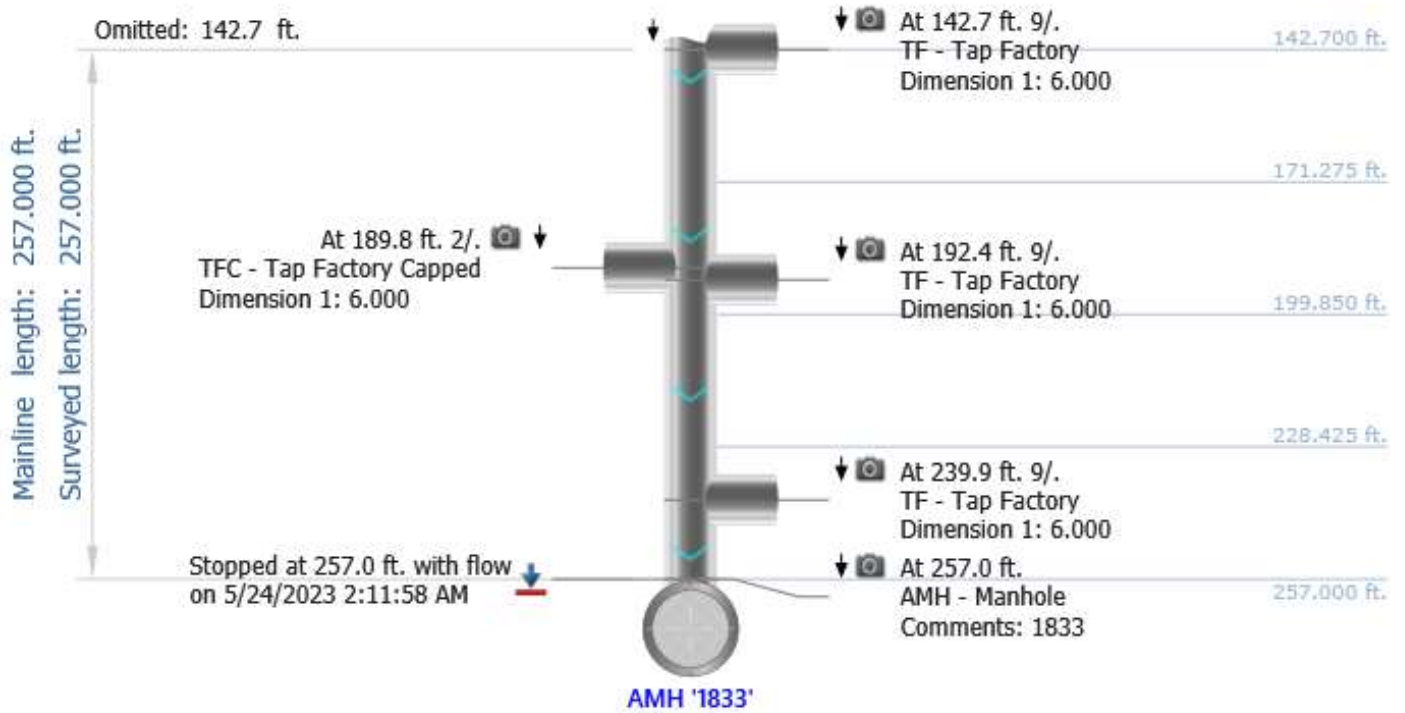



Vortex Services
521 Federal Road
Livermore, ME 04253
(207) 897-3348

Main Inspections Summary

Weston & Sampson - 2319762

Mainline ID	End date/time	Surveyed by	Start MH	Finish MH	Material	Height	Total length	Length
1833 - 1832	5/23/2023 10:23 PM	Mike Swilley	1833	1832	VCP	12 in.	252.000 ft.	252.000 ft.
Sub-Total							252.0 ft.	252.0 ft.
Total							252.0 ft.	252.0 ft.



Vortex Services
 521 Federal Road
 Livermore, ME 04253
 (207) 897-3348

Main Inspections Small Photos and Scoring

Mainline ID: 1833 - 1832	City: Georgetown, SC	Street: Hwy 17	Project name: Weston & Sampson - 2319762
Start date/time: 5/23/2023 9:00 PM	Total length: 252.000 ft.	Weather: 1	Surveyed by: Mike Swilley
Upstream MH No: 1833	Depth US: 8.000 ft.	Downstream MH No: 1832	Depth DS: 8.0 ft.
Shape: C	Material: VCP	Height: 12 in.	Width:
Additional info:			

Scores

Calculated at: **5/24/2023 12:16:41 PM**

Grade	Structural:				O&M:				Overall:	
	Segment Grade	Pipe Rating	Quick Rating	Pipe Rating Index	Segment Grade	Pipe Rating	Quick Rating	Pipe Rating Index	Pipe Rating	Pipe Rating Index
1	0	10	5131	3.3	0	8	3221	2.7	18	3.0
2	2				2					
3	3				6					
4	0				0					
5	5				0					

Observations

Distance	Dir.	Length	From/To	Code	Modifier	Rating	Remarks
0.0 ft.	D		/	AMH			1833
0.0 ft.	D		/	MWL			

Observations

Distance	Dir. Length	From/To Code	Modifier	Rating	Remarks
----------	-------------	--------------	----------	--------	---------

0.0 ft.	D	/	MGO		Both Manholes Are 8 Feet Deep
---------	---	---	-----	--	-------------------------------



0.0 ft.	D	/	MGO		Agm 259 Feet
---------	---	---	-----	--	--------------



0.0 ft.	D	/	MGO		12 Inch
---------	---	---	-----	--	---------



Observations

Distance	Dir.	Length	From/To	Code	Modifier	Rating	Remarks
----------	------	--------	---------	------	----------	--------	---------

35.7 ft. D 2 / TFC



36.9 ft. D 9 / BVV

5



38.1 ft. D 9 / TBI

3

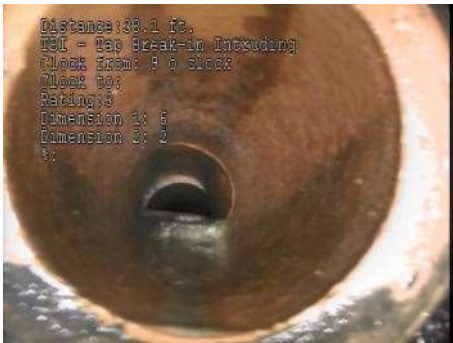

Observations

Distance	Dir.	Length	From/To	Code	Modifier	Rating	Remarks
----------	------	--------	---------	------	----------	--------	---------

101.4 ft. D 2 / TFC



101.5 ft. D / RPR

pvc



104.2 ft. D 12 / TF



Observations

Distance	Dir.	Length	From/To	Code	Modifier	Rating	Remarks
----------	------	--------	---------	------	----------	--------	---------

116.9 ft.	D	12 /	CL			2	
-----------	---	------	----	--	--	----------	--



154.1 ft.	D	2 /	TFC				
-----------	---	-----	-----	--	--	--	--



156.5 ft.	D	9 /	TFD			3	Broken/Debris
-----------	---	-----	-----	--	--	----------	----------------------



Observations

Distance	Dir.	Length	From/To	Code	Modifier	Rating	Remarks
----------	------	--------	---------	------	----------	--------	---------

206.2 ft. D 2 / TFC

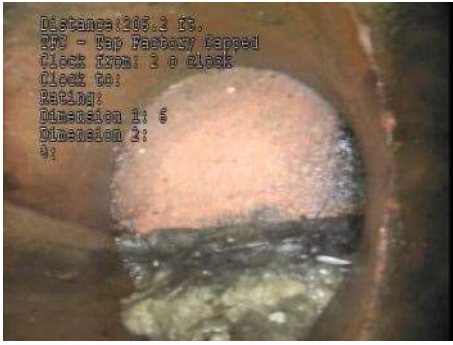

208.9 ft. D 9 / TBI

2



244.8 ft. D 8 / 4 CM

3



Observations

Distance	Dir.	Length	From/To	Code	Modifier	Rating	Remarks
252.0 ft.	D		/	AMH		1832	



Inspection's photos

Main Inspections Pipe Run and Scoring

Project name: Weston & Sampson - 2319762	Mainline ID: 1833 - 1832	City: Georgetown, SC	Street: Hwy 17
Start date/time: 5/23/2023 9:00 PM	Direction: D	Weather: 1	Location code: A
Shape: C	Material: VCP	Height: 12 in.	Width:

Scores

Calculated at: **5/24/2023 12:16:41 PM**

Grade	Structural:				O&M:				Overall:	
	Segment Grade	Pipe Rating	Quick Rating	Pipe Rating Index	Segment Grade	Pipe Rating	Quick Rating	Pipe Rating Index	Pipe Rating	Pipe Rating Index
1	0	10	5131	3.3	0	8	3221	2.7	18	3.0
2	2									
3	3									
4	0									
5	5									

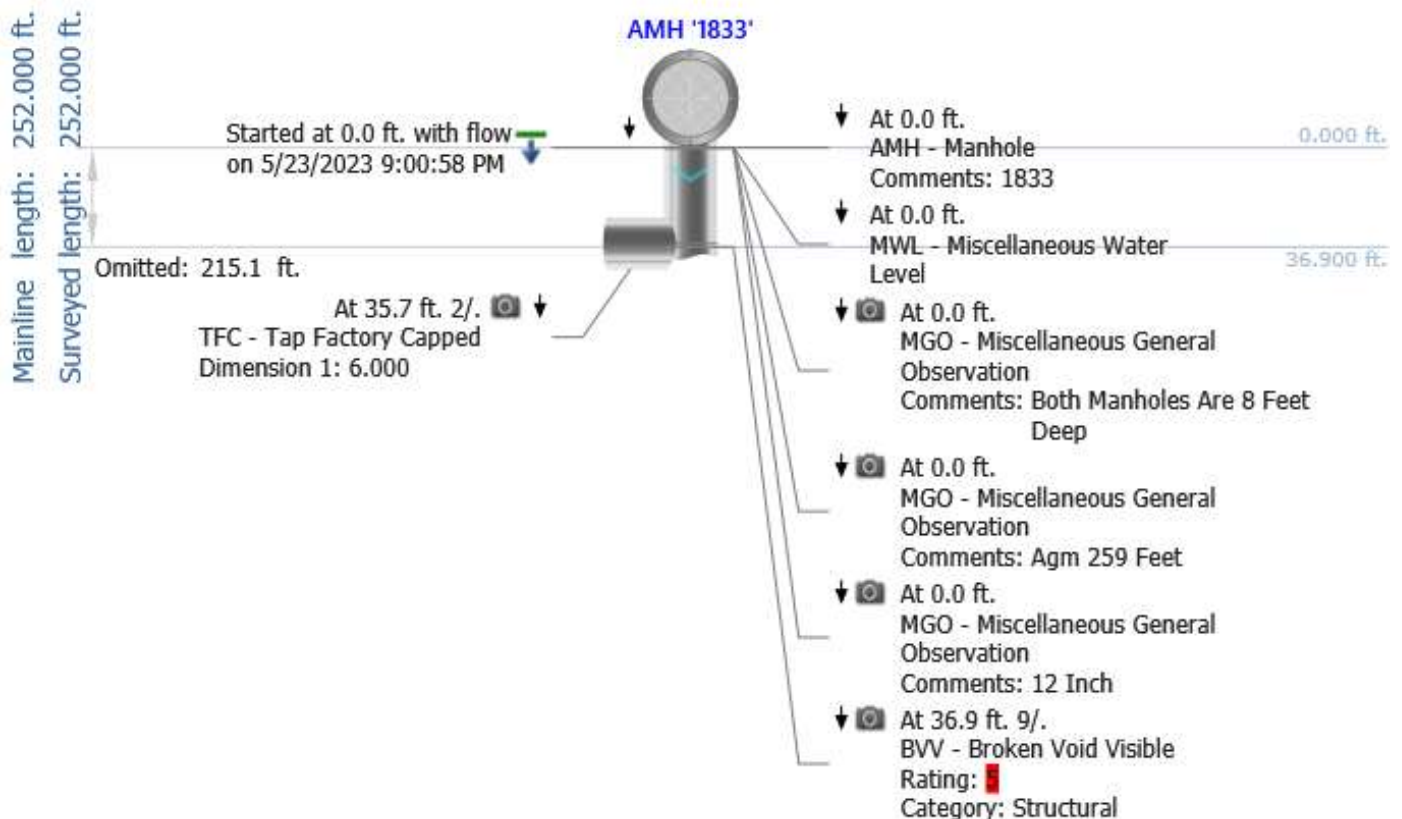

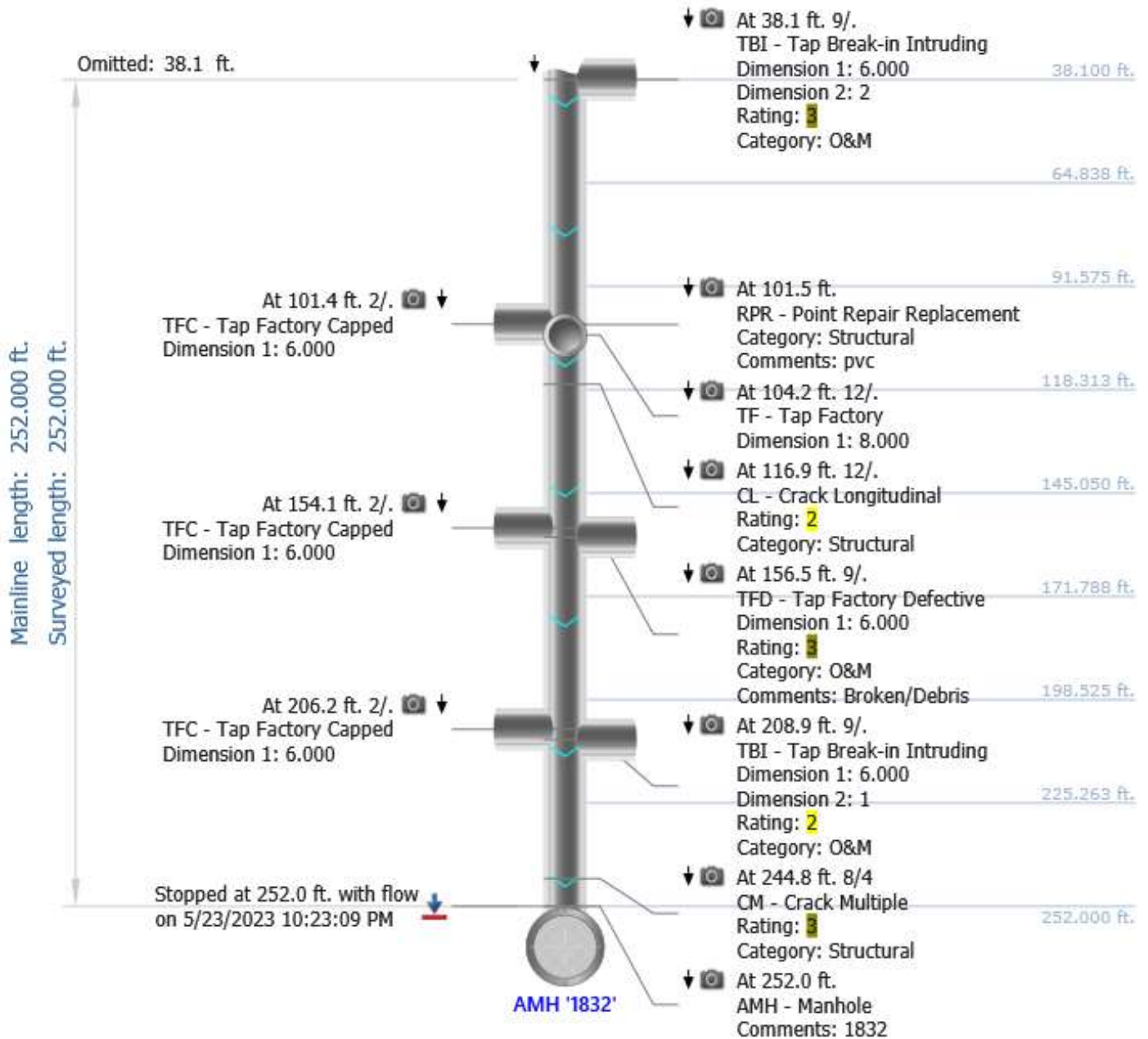



Vortex Services
521 Federal Road
Livermore, ME 04253
(207) 897-3348

Main Inspections Summary

Weston & Sampson - 2319762

Mainline ID	End date/time	Surveyed by	Start MH	Finish MH	Material	Height	Total length	Length	
1832 - 1831	5/23/2023 8:26 PM	Mike Swilley	1832	1831	VCP	12 in.	255.000 ft.	255.000 ft.	
							Sub-Total	255.0 ft.	255.0 ft.
							Total	255.0 ft.	255.0 ft.



Vortex Services
 521 Federal Road
 Livermore, ME 04253
 (207) 897-3348

Main Inspections Small Photos and Scoring

Mainline ID: 1832 - 1831	City: Georgetown, SC	Street: Hwy 17	Project name: Weston & Sampson - 2319762
Start date/time: 5/23/2023 7:50 PM	Total length: 255.000 ft.	Weather: 1	Surveyed by: Mike Swilley
Upstream MH No: 1832	Depth US: 8.0 ft.	Downstream MH No: 1831	Depth DS: 8.000 ft.
Shape: C	Material: VCP	Height: 12 in.	Width:
Additional info:			

Scores

Calculated at: **5/24/2023 12:11:15 PM**

Grade	Structural:				O&M:				Overall:	
	Segment Grade	Pipe Rating	Quick Rating	Pipe Rating Index	Segment Grade	Pipe Rating	Quick Rating	Pipe Rating Index	Pipe Rating	Pipe Rating Index
1	0	18	5242	4.5	0	5	5100	5.0	23	4.6
2	0				0					
3	0				0					
4	8				0					
5	10				5					

Observations

Distance	Dir.	Length	From/To	Code	Modifier	Rating	Remarks
0.0 ft.	D		/	AMH			1832
0.0 ft.	D		/	MWL			

Observations

Distance	Dir. Length	From/To Code	Modifier	Rating	Remarks
----------	-------------	--------------	----------	--------	---------

0.0 ft.	D	/	MGO		Agm 258 Feet
---------	---	---	-----	--	--------------



0.0 ft.	D	/	MGO		Both Manholes Are 8 Feet Deep
---------	---	---	-----	--	-------------------------------



10.0 ft.	D	/	MGO		12 Inch
----------	---	---	-----	--	---------



Observations

Distance	Dir.	Length	From/To	Code	Modifier	Rating	Remarks
----------	------	--------	---------	------	----------	--------	---------

61.8 ft. D 2 / TFC



62.0 ft. D 4 / 8 B

4



64.4 ft. D 10 / TFC



Observations

Distance	Dir.	Length	From/To	Code	Modifier	Rating	Remarks
----------	------	--------	---------	------	----------	--------	---------

118.5 ft.	D		9 / 3	IGJ		5	
-----------	---	--	-------	-----	--	----------	--



```

Distance:118.5 ft.
IGJ - Infiltration Bucket Joint
Clock from: 9 o'clock
Clock to: 9 o'clock
Rating:5
Dimension 1:
Dimension 2:
4:
    
```

132.5 ft.	D		2 /	TFC			
-----------	---	--	-----	-----	--	--	--



```

Distance:132.5 ft.
TFC - Top Factory Flange
Clock from: 3 o'clock
Clock to:
Rating:
Dimension 1: 6
Dimension 2:
4:
    
```

163.4 ft.	D		12 /	RPPD		4	Clay patch, Cracked
-----------	---	--	------	------	--	----------	---------------------



```

Distance:163.4 ft.
RPPD - Paint Repair Patch
Clock from: 12 o'clock
Clock to:
Rating:
Dimension 1:
Dimension 2:
4:
    
```

clay

Observations

Distance	Dir.	Length	From/To Code	Modifier	Rating	Remarks
----------	------	--------	--------------	----------	--------	---------

202.9 ft. D 2 / TFC

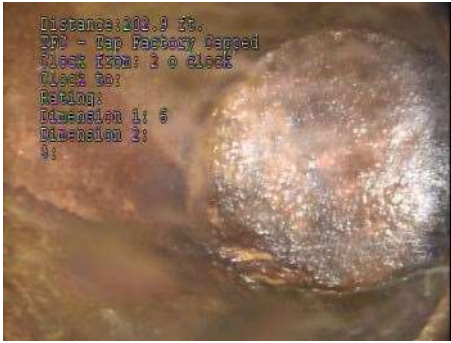

205.4 ft. D 11 / TFA



237.3 ft. D / DR

5



Observations

Distance	Dir.	Length	From/To	Code	Modifier	Rating	Remarks
245.9 ft.	D		/	DR		5	



255.0 ft.	D		/	AMH		1831	
-----------	---	--	---	-----	--	------	--



Inspection's photos

Main Inspections Pipe Run and Scoring

Project name:	Mainline ID:	City:	Street:
Weston & Sampson - 2319762	1832 - 1831	Georgetown, SC	Hwy 17
Start date/time:	Direction:	Weather:	Location code:
5/23/2023 7:50 PM	D	1	A
Shape:	Material:	Height:	Width:
C	VCP	12 in.	

Scores

Calculated at: **5/24/2023 12:11:15 PM**

Grade	Structural:				O&M:				Overall:	
	Segment Grade	Pipe Rating	Quick Rating	Pipe Rating Index	Segment Grade	Pipe Rating	Quick Rating	Pipe Rating Index	Pipe Rating	Pipe Rating Index
1	0	18	5242	4.5	0	5	5100	5.0	23	4.6
2	0									
3	0									
4	8									
5	10									

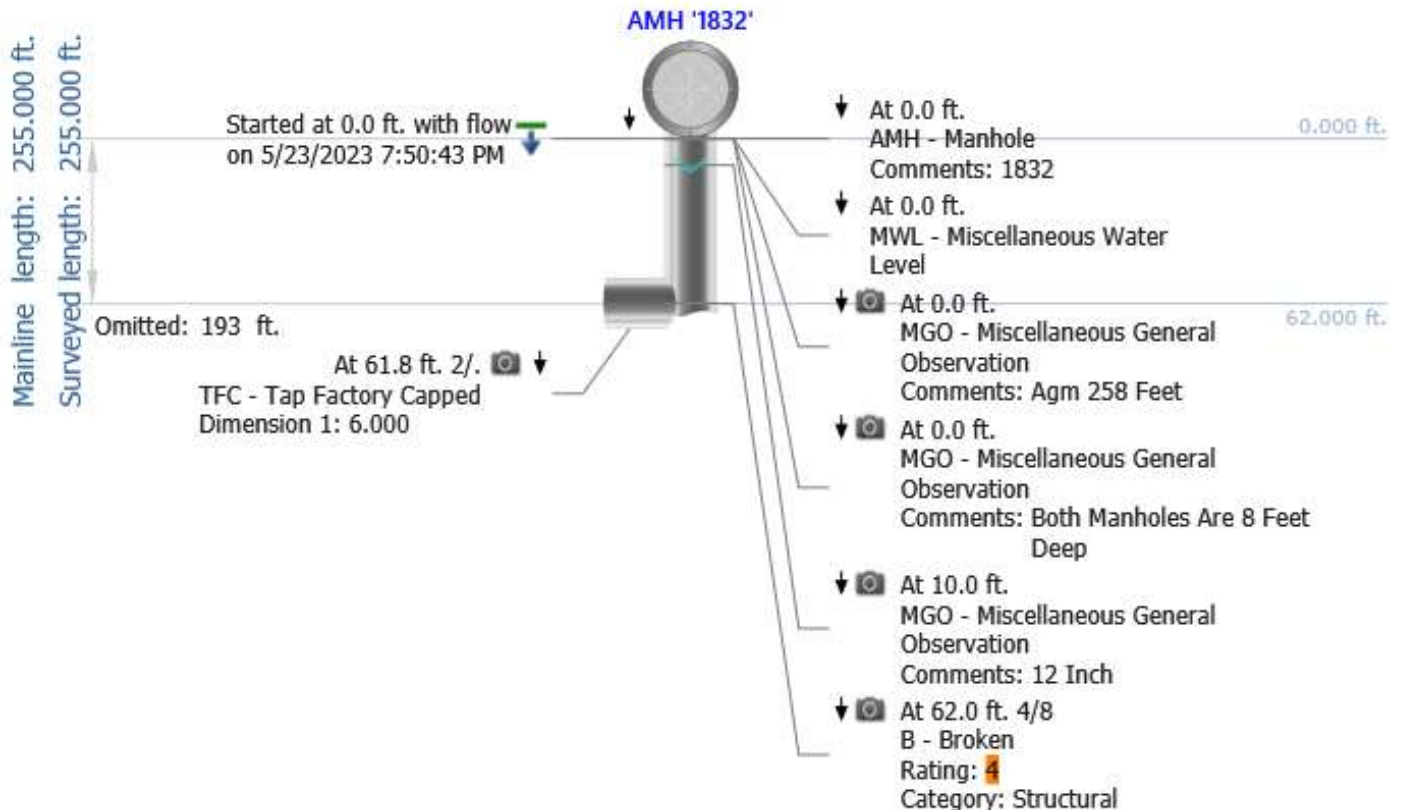

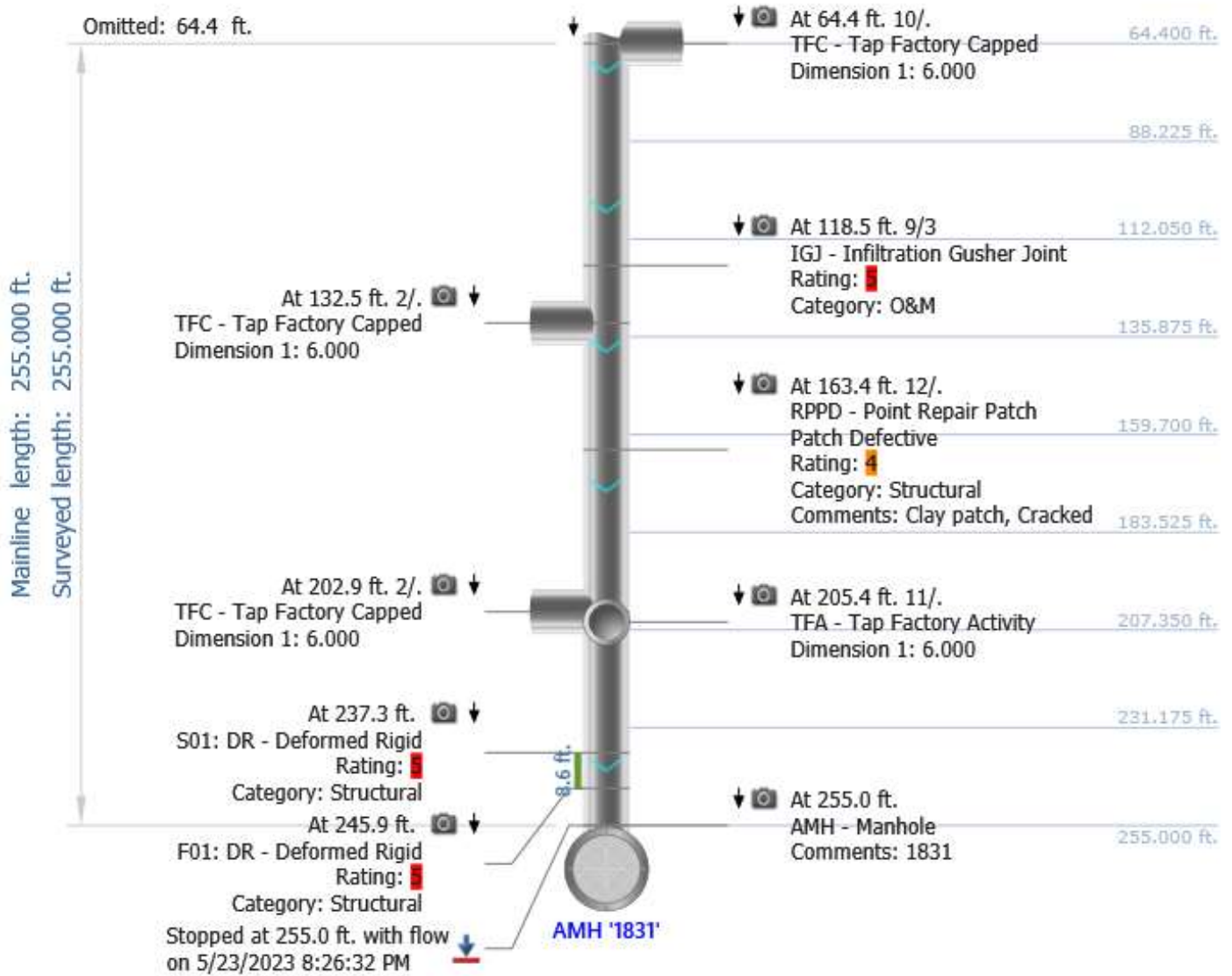



Vortex Services
521 Federal Road
Livermore, ME 04253
(207) 897-3348

Main Inspections Summary

Weston & Sampson - 2319762

Mainline ID	End date/time	Surveyed by	Start MH	Finish MH	Material	Height	Total length	Length	
1831 - 1830	5/23/2023 2:18 AM	Mike Swilley	1831	1830	VCP	12 in.	256.000 ft.	256.000 ft.	
							Sub-Total	256.0 ft.	256.0 ft.
							Total	256.0 ft.	256.0 ft.



Vortex Services
 521 Federal Road
 Livermore, ME 04253
 (207) 897-3348

Main Inspections Small Photos and Scoring

Mainline ID: 1831 - 1830	City: Georgetown, SC	Street: Hwy 17	Project name: Weston & Sampson - 2319762
Start date/time: 5/22/2023 11:54 PM	Total length: 256.000 ft.	Weather: 1	Surveyed by: Mike Swilley
Upstream MH No: 1831	Depth US: 8.000 ft.	Downstream MH No: 1830	Depth DS: 10.000 ft.
Shape: C	Material: VCP	Height: 12 in.	Width:
Additional info:			

Scores



Calculated at: **5/23/2023 5:45:59 PM**

Grade	Structural:				O&M:				Overall:	
	Segment Grade	Pipe Rating	Quick Rating	Pipe Rating Index	Segment Grade	Pipe Rating	Quick Rating	Pipe Rating Index	Pipe Rating	Pipe Rating Index
1	0	4	4100	4.0	0	3	3100	3.0	7	3.5
2	0				0					
3	0				3					
4	4				0					
5	0				0					

Observations

Distance	Dir.	Length	From/To	Code	Modifier	Rating	Remarks
0.0 ft.	D		/	AMH			1831
0.0 ft.	D		/	MWL			

Observations

Distance	Dir. Length	From/To Code	Modifier	Rating	Remarks
0.0 ft.	D	/	MGO		Agm 259 Feet
					
0.0 ft.	D	/	MGO		Upstream Manhole Is 8 Feet Deep. Downstream Manhole Is 10 Feet Deep
					
0.0 ft.	D	/	MGO		12 Inch
					

Observations

Distance	Dir.	Length	From/To	Code	Modifier	Rating	Remarks
----------	------	--------	---------	------	----------	--------	---------

0.0 ft.	D	/	MMC			CP	
---------	---	---	-----	--	--	----	--



6.1 ft.	D	/	MMC			vcp	
---------	---	---	-----	--	--	-----	--



37.5 ft.	D	2 /	TFC				
----------	---	-----	-----	--	--	--	--



Observations

Distance	Dir.	Length	From/To	Code	Modifier	Rating	Remarks
----------	------	--------	---------	------	----------	--------	---------

40.2 ft. D 9 / TF



97.0 ft. D 2 / TFC

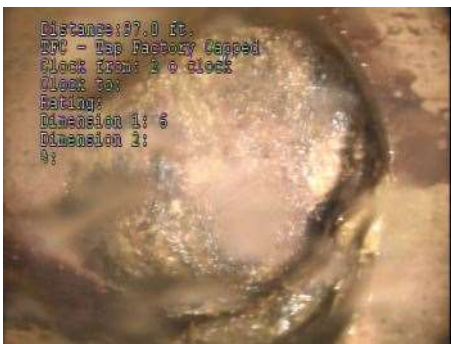

97.6 ft. D 9 / TB



Observations

Distance	Dir.	Length	From/To	Code	Modifier	Rating	Remarks
----------	------	--------	---------	------	----------	--------	---------

99.5 ft. D 10 / TBI

3



166.3 ft. D 2 / TFC



169.1 ft. D 10 / TFC



Observations

Distance	Dir.	Length	From/To	Code	Modifier	Rating	Remarks
----------	------	--------	---------	------	----------	--------	---------

215.2 ft. D 2 / TFC



218.0 ft. D 9 / TF



251.1 ft. D 2 / 7 B

4



Observations

Distance	Dir. Length	From/To Code	Modifier	Rating	Remarks
256.0 ft.	D	/ AMH		1830	



Inspection's photos

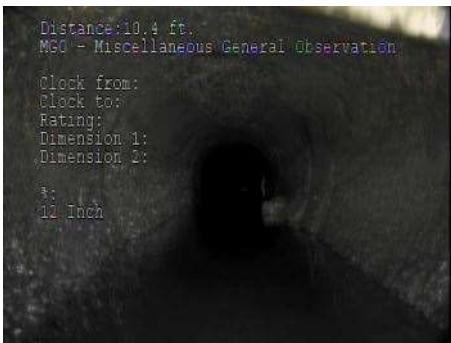

Main Inspections Pipe Run and Scoring

Project name: Weston & Sampson - 2319762	Mainline ID: 1831 - 1830	City: Georgetown, SC	Street: Hwy 17
Start date/time: 5/22/2023 11:54 PM	Direction: D	Weather: 1	Location code: A
Shape: C	Material: VCP	Height: 12 in.	Width:

Scores

Calculated at: **5/23/2023 5:45:59 PM**

Grade	Structural:				O&M:				Overall:	
	Segment Grade	Pipe Rating	Quick Rating	Pipe Rating Index	Segment Grade	Pipe Rating	Quick Rating	Pipe Rating Index	Pipe Rating	Pipe Rating Index
1	0	4	4100	4.0	0	3	3100	3.0	7	3.5
2	0									
3	0									
4	4									
5	0									

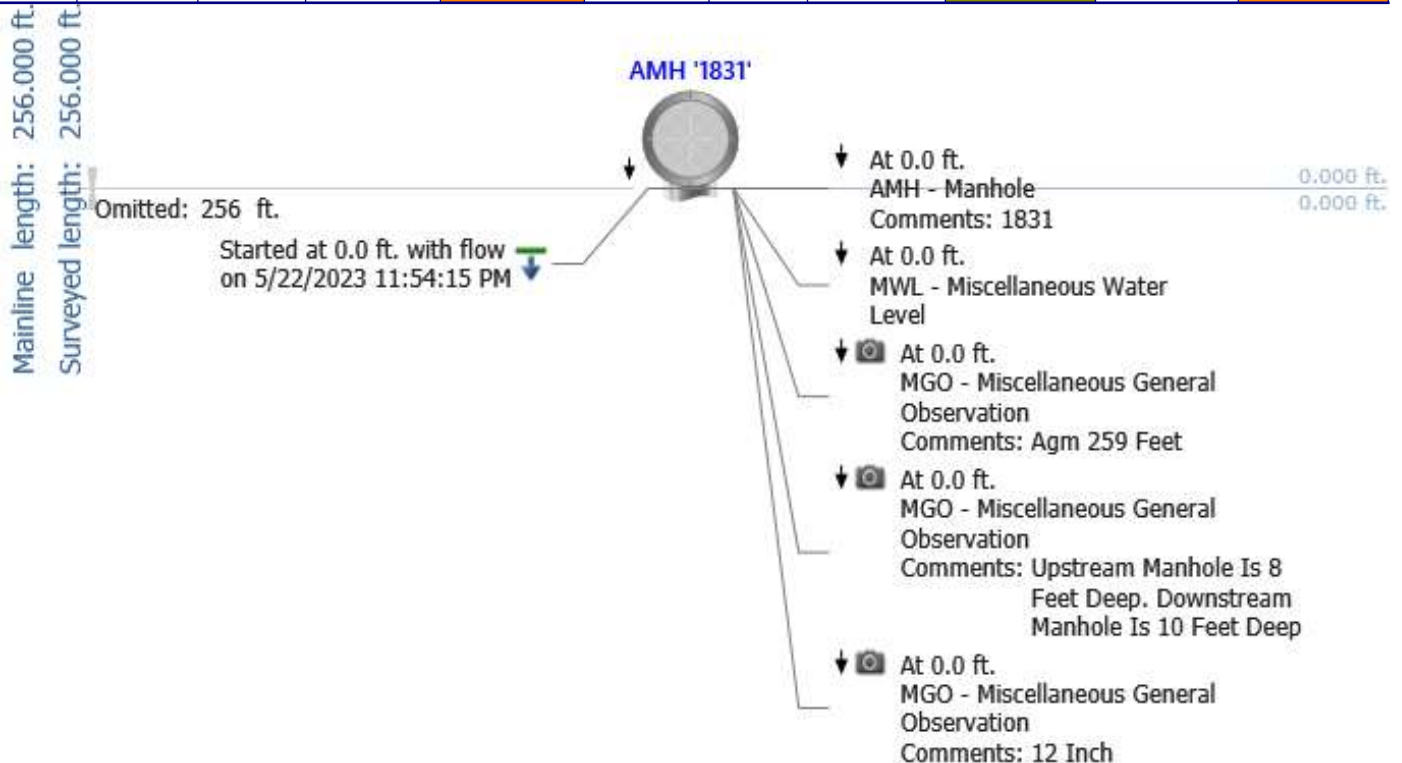

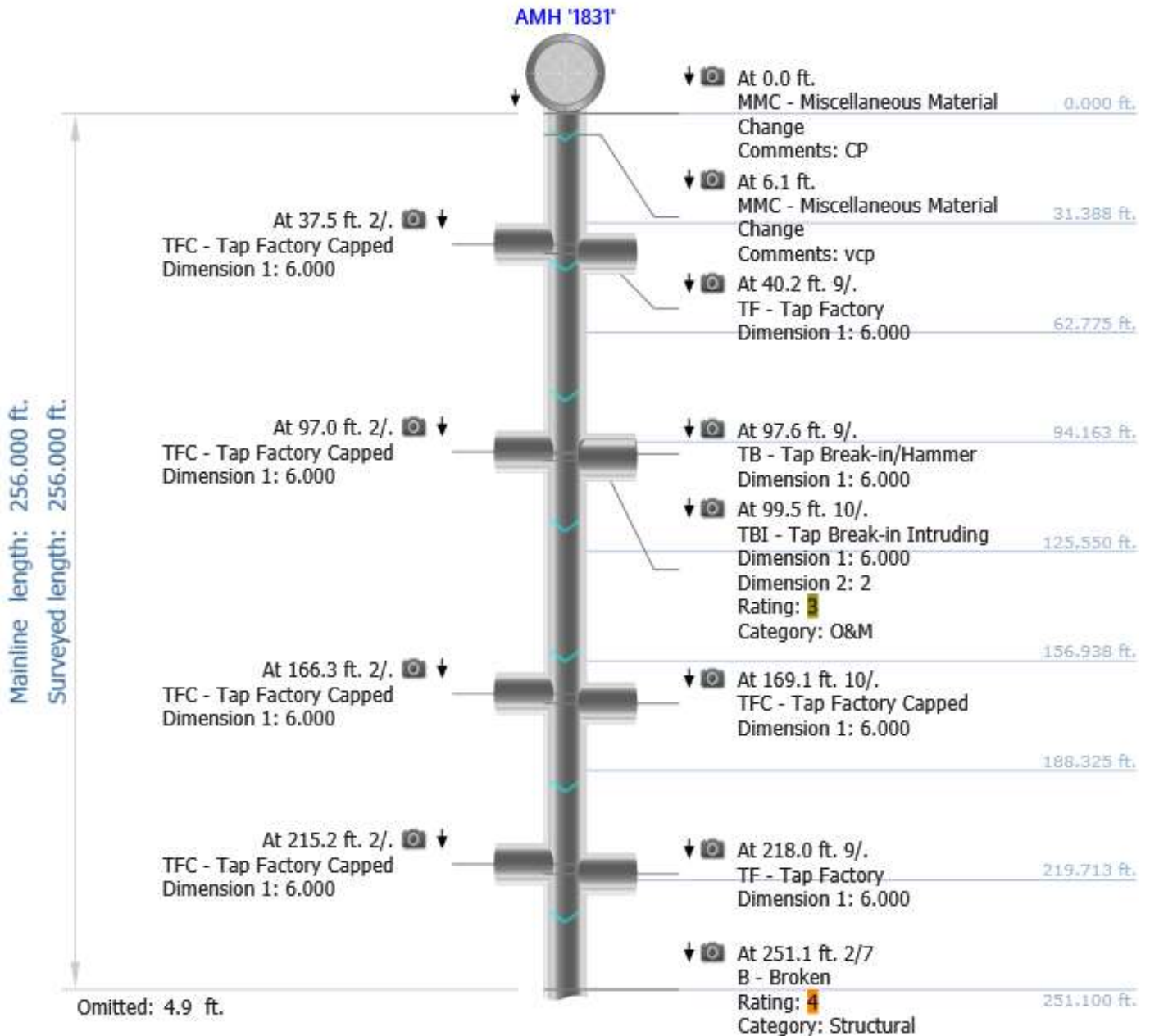

Project name:
**Weston & Sampson -
2319762**

Mainline ID:
1831 - 1830

Start date/time:
5/22/2023 11:54 PM

Direction:
D

Weather:

1

Mainline length: 256.000 ft.
Surveyed length: 256.000 ft.

Omitted: 256 ft.

Stopped at 256.0 ft. with flow
on 5/23/2023 2:18:55 AM

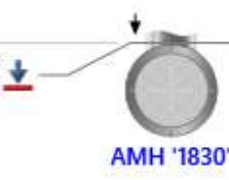

At 256.0 ft.
AMH - Manhole
Comments: 1830

256.000 ft.
256.000 ft.



Vortex Services
521 Federal Road
Livermore, ME 04253
(207) 897-3348

Main Inspections Summary

Weston & Sampson - 2319762

Mainline ID	End date/time	Surveyed by	Start MH	Finish MH	Material	Height	Total length	Length
1830 - 1829	5/22/2023 11:23 PM	Mike Swilley	1830	1829	VCP	12 in.	512.000 ft.	512.000 ft.
Sub-Total							512.0 ft.	512.0 ft.
Total							512.0 ft.	512.0 ft.



Vortex Services
 521 Federal Road
 Livermore, ME 04253
 (207) 897-3348

Main Inspections Small Photos and Scoring

Mainline ID: 1830 - 1829	City: Georgetown, SC	Street: Hwy 17	Project name: Weston & Sampson - 2319762
Start date/time: 5/22/2023 8:59 PM	Total length: 512.000 ft.	Weather: 1	Surveyed by: Mike Swilley
Upstream MH No: 1830	Depth US: 10.000 ft.	Downstream MH No: 1829	Depth DS: 11.000 ft.
Shape: C	Material: VCP	Height: 12 in.	Width:
Additional info:			

Scores



Calculated at: **5/23/2023 5:42:54 PM**

Grade	Structural:				O&M:				Overall:	
	Segment Grade	Pipe Rating	Quick Rating	Pipe Rating Index	Segment Grade	Pipe Rating	Quick Rating	Pipe Rating Index	Pipe Rating	Pipe Rating Index
1	0	80	432E	2.2	0	2	2100	2.0	82	2.2
2	68				2					
3	0				0					
4	12				0					
5	0				0					

Observations

Distance	Dir.	Length	From/To	Code	Modifier	Rating	Remarks
0.0 ft.	D		/	AMH			1830
0.0 ft.	D		/	MWL			

Observations

Distance	Dir. Length	From/To Code	Modifier	Rating	Remarks
0.0 ft.	D	/	MGO		Agm 516 Feet
					
0.0 ft.	D	/	MGO		Upstream Manhole Is 10 Feet Deep. Downstream manhole Is 11 Feet Deep
					
0.0 ft.	D	/	MGO		12 Inch
					

Observations

Distance	Dir.	Length	From/To	Code	Modifier	Rating	Remarks
----------	------	--------	---------	------	----------	--------	---------

46.0 ft. D 2 / TFC



48.6 ft. D 10 / TFC



104.8 ft. D 12 / CL

2



Observations

Distance	Dir.	Length	From/To	Code	Modifier	Rating	Remarks
----------	------	--------	---------	------	----------	--------	---------

118.1 ft. D 2 / TFC



120.5 ft. D 10 / TFC



164.0 ft. D 2 / TFC



Observations

Distance	Dir.	Length	From/To	Code	Modifier	Rating	Remarks
----------	------	--------	---------	------	----------	--------	---------

166.5 ft. D 11 / TF



215.4 ft. D 2 / TFC



218.0 ft. D 11 / TF



Observations

Distance	Dir.	Length	From/To	Code	Modifier	Rating	Remarks
246.8 ft.	D		11 /	H		4	Possible Hammer Tap



267.0 ft.	D		2 /	TFC			
-----------	---	--	-----	-----	--	--	--



269.5 ft.	D		10 /	TFC			
-----------	---	--	------	-----	--	--	--



Observations

Distance	Dir.	Length	From/To	Code	Modifier	Rating	Remarks
----------	------	--------	---------	------	----------	--------	---------

270.2 ft.	D	12 /	CL			2	
-----------	---	------	----	--	--	----------	--



290.6 ft.	D	11 /	TB				
-----------	---	------	----	--	--	--	--



314.5 ft.	D	2 /	TFC				
-----------	---	-----	-----	--	--	--	--



Observations

Distance	Dir.	Length	From/To	Code	Modifier	Rating	Remarks
----------	------	--------	---------	------	----------	--------	---------

316.6 ft. D 10 / TFC



330.0 ft. D 6 / DAZ

2 Concrete



332.1 ft. D 9 / TB



Observations

Distance	Dir.	Length	From/To	Code	Modifier	Rating	Remarks
----------	------	--------	---------	------	----------	--------	---------

388.6 ft. D 2 / TFC



391.2 ft. D 11 / TF



405.8 ft. D 12 / CL

2

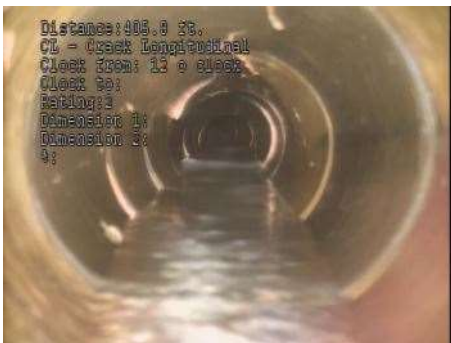

Observations

Distance	Dir.	Length	From/To	Code	Modifier	Rating	Remarks
----------	------	--------	---------	------	----------	--------	---------

407.0 ft. D 10 / B 4



442.5 ft. D 2 / TFC



445.4 ft. D 10 / TFC



Observations

Distance	Dir. Length	From/To Code	Modifier	Rating	Remarks
----------	-------------	--------------	----------	--------	---------

504.9 ft.	D	4 / 8 B		4	
-----------	---	---------	--	----------	--



512.0 ft.	D	/ AMH			1829
-----------	---	-------	--	--	------



Inspection's photos



Main Inspections Pipe Run and Scoring

Project name:	Mainline ID:	City:	Street:
Weston & Sampson - 2319762	1830 - 1829	Georgetown, SC	Hwy 17
Start date/time:	Direction:	Weather:	Location code:
5/22/2023 8:59 PM	D	1	A
Shape:	Material:	Height:	Width:
C	VCP	12 in.	

Scores

Calculated at: **5/23/2023 5:42:54 PM**

Grade	Structural:				O&M:				Overall:	
	Segment Grade	Pipe Rating	Quick Rating	Pipe Rating Index	Segment Grade	Pipe Rating	Quick Rating	Pipe Rating Index	Pipe Rating	Pipe Rating Index
1	0	80	432E	2.2	0	2	2100	2.0	82	2.2
2	68				2					
3	0				0					
4	12				0					
5	0				0					

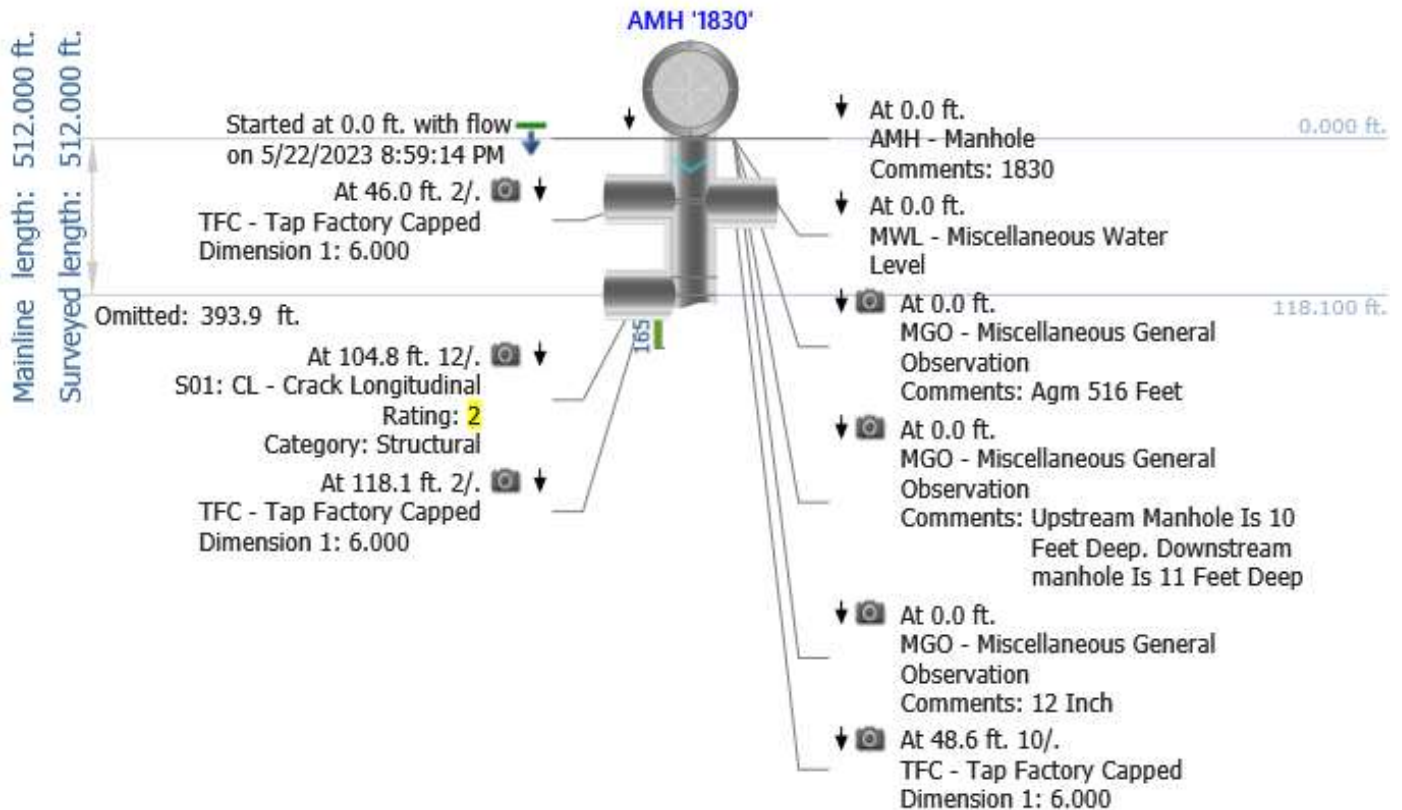

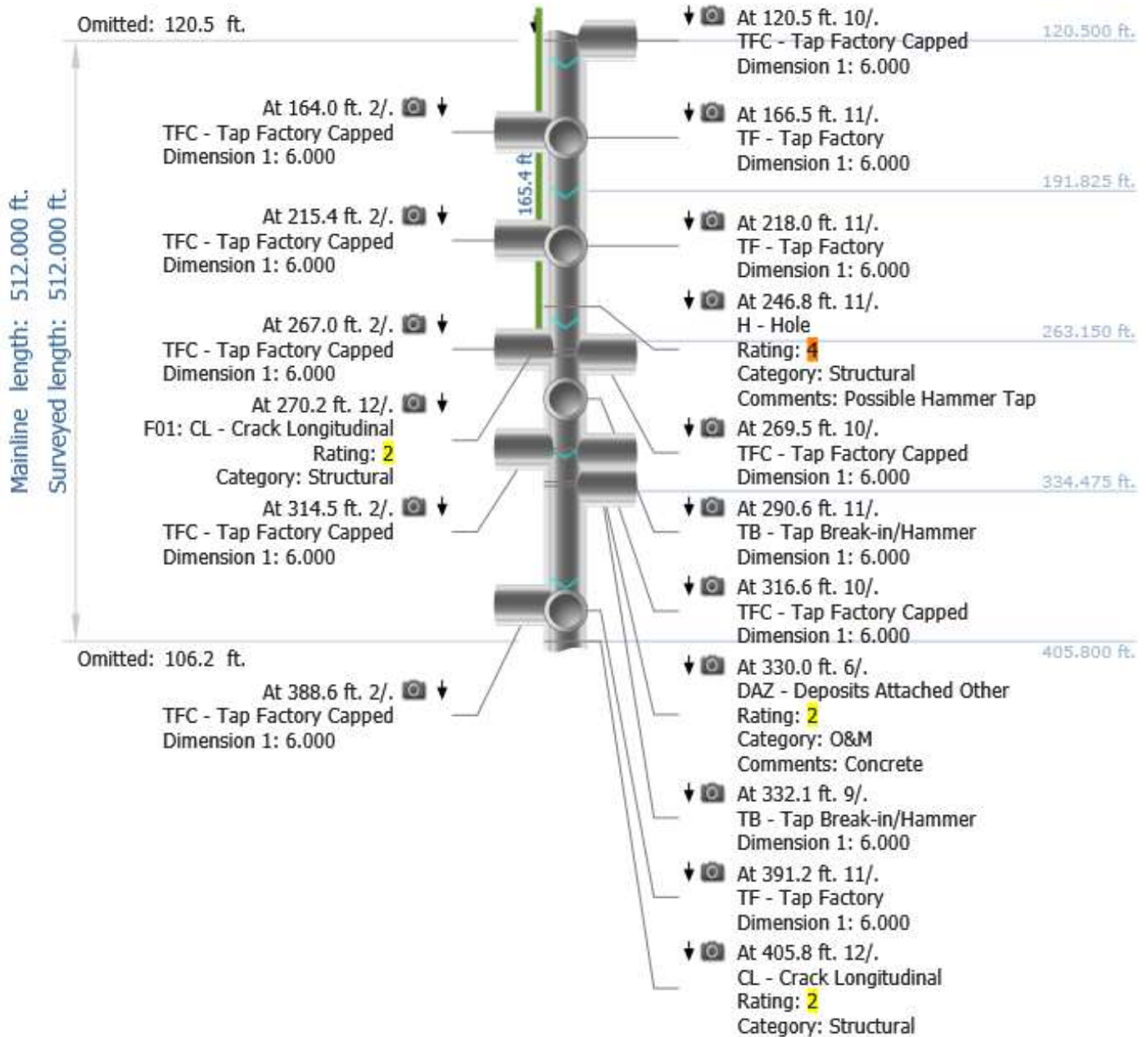

Project name:
**Weston & Sampson -
2319762**

Mainline ID:
1830 - 1829

Start date/time:
5/22/2023 8:59 PM

Direction:
D

Weather:
1

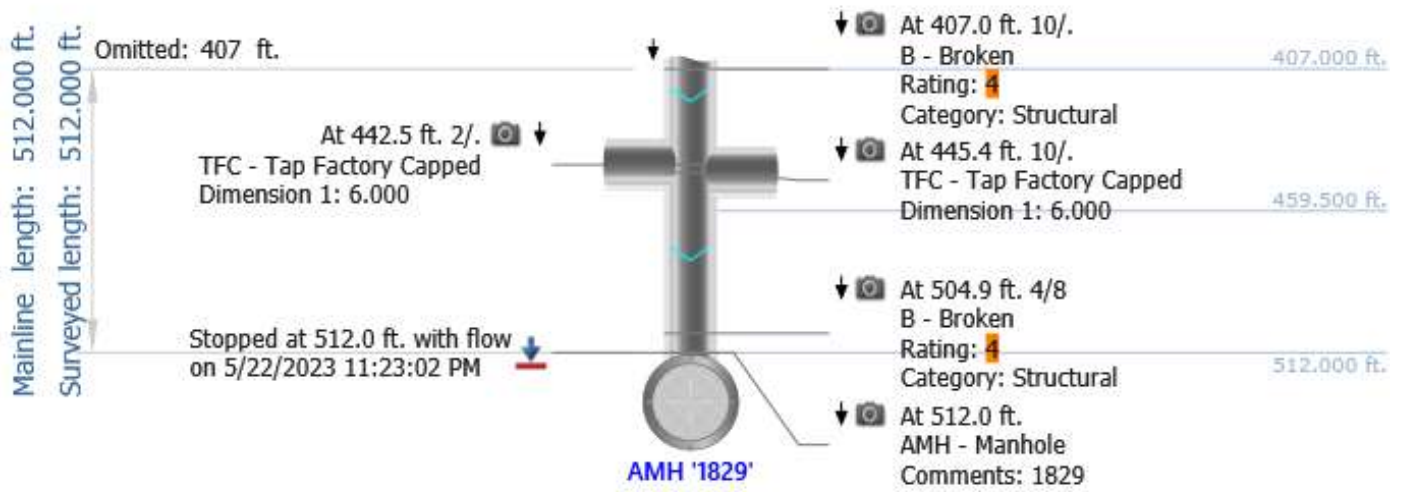



Vortex Services
521 Federal Road
Livermore, ME 04253
(207) 897-3348

Main Inspections Summary

Weston & Sampson - 2319762

Mainline ID	End date/time	Surveyed by	Start MH	Finish MH	Material	Height	Total length	Length
1829 - 1828	5/24/2023 9:00 PM	Mike Swilley	1829	1828	VCP	12 in.	220.000 ft.	220.000 ft.
Sub-Total							220.0 ft.	220.0 ft.
Total							220.0 ft.	220.0 ft.



Vortex Services
 521 Federal Road
 Livermore, ME 04253
 (207) 897-3348

Main Inspections Small Photos and Scoring

Mainline ID: 1829 - 1828	City: Georgetown, SC	Street: Hwy 17	Project name: Weston & Sampson - 2319762
Start date/time: 5/24/2023 2:58 AM	Total length: 220.000 ft.	Weather: 1	Surveyed by: Mike Swilley
Upstream MH No: 1829	Depth US: 11.000 ft.	Downstream MH No: 1828	Depth DS: 13.0 ft.
Shape: C	Material: VCP	Height: 12 in.	Width:
Additional info:			

Scores



Calculated at: **5/30/2023 12:53:09 PM**

Grade	Structural:				O&M:				Overall:	
	Segment Grade	Pipe Rating	Quick Rating	Pipe Rating Index	Segment Grade	Pipe Rating	Quick Rating	Pipe Rating Index	Pipe Rating	Pipe Rating Index
1	0	0	0000	0.0	0	0	0000	0.0	0	0.0
2	0				0					
3	0				0					
4	0				0					
5	0				0					

Observations

Distance	Dir.	Length	From/To	Code	Modifier	Rating	Remarks
0.0 ft.	D		/	AMH			1829
0.0 ft.	D		/	MWL			

Observations

Distance	Dir. Length	From/To Code	Modifier	Rating	Remarks
0.0 ft.	D	/	MGO		Agm 530 Feet
					
0.0 ft.	D	/	MGO		Upstream Manhole Is 11 Feet Deep. Downstream Manhole is 13 Feet Deep
					
12.1 ft.	D	/	MGO		12 Inch
					

Observations

Distance	Dir.	Length	From/To	Code	Modifier	Rating	Remarks
----------	------	--------	---------	------	----------	--------	---------

76.6 ft. D 2 / TFC



79.2 ft. D 10 / TFC



81.1 ft. D 11 / TB



Observations

Distance	Dir.	Length	From/To	Code	Modifier	Rating	Remarks
----------	------	--------	---------	------	----------	--------	---------

88.9 ft. D 2 / TB



118.0 ft. D 10 / TFC



120.5 ft. D 2 / TFC



Observations

Distance	Dir.	Length	From/To	Code	Modifier	Rating	Remarks
----------	------	--------	---------	------	----------	--------	---------

148.6 ft. D 2 / TB



156.6 ft. D 1 / TB



161.9 ft. D 2 / TFC



Observations

Distance	Dir.	Length	From/To	Code	Modifier	Rating	Remarks
----------	------	--------	---------	------	----------	--------	---------

167.2 ft. D 11 / TF



185.7 ft. D 2 / TB



196.3 ft. D 11 / TB



Observations

Distance	Dir.	Length	From/To	Code	Modifier	Rating	Remarks
----------	------	--------	---------	------	----------	--------	---------

208.5 ft. D 10 / TFC



216.1 ft. D 2 / TFC



220.0 ft. D / MSA

Couldnt Finish Video
Due To Mot Issues

Inspection's photos

Main Inspections Pipe Run and Scoring

Project name: Weston & Sampson - 2319762	Mainline ID: 1829 - 1828	City: Georgetown, SC	Street: Hwy 17
Start date/time: 5/24/2023 2:58 AM	Direction: D	Weather: 1	Location code: A
Shape: C	Material: VCP	Height: 12 in.	Width:

Scores

Calculated at: **5/30/2023 12:53:09 PM**

Grade	Structural:				O&M:				Overall:	
	Segment Grade	Pipe Rating	Quick Rating	Pipe Rating Index	Segment Grade	Pipe Rating	Quick Rating	Pipe Rating Index	Pipe Rating	Pipe Rating Index
1	0	0	0000	0.0	0	0	0000	0.0	0	0.0
2	0									
3	0									
4	0									
5	0									

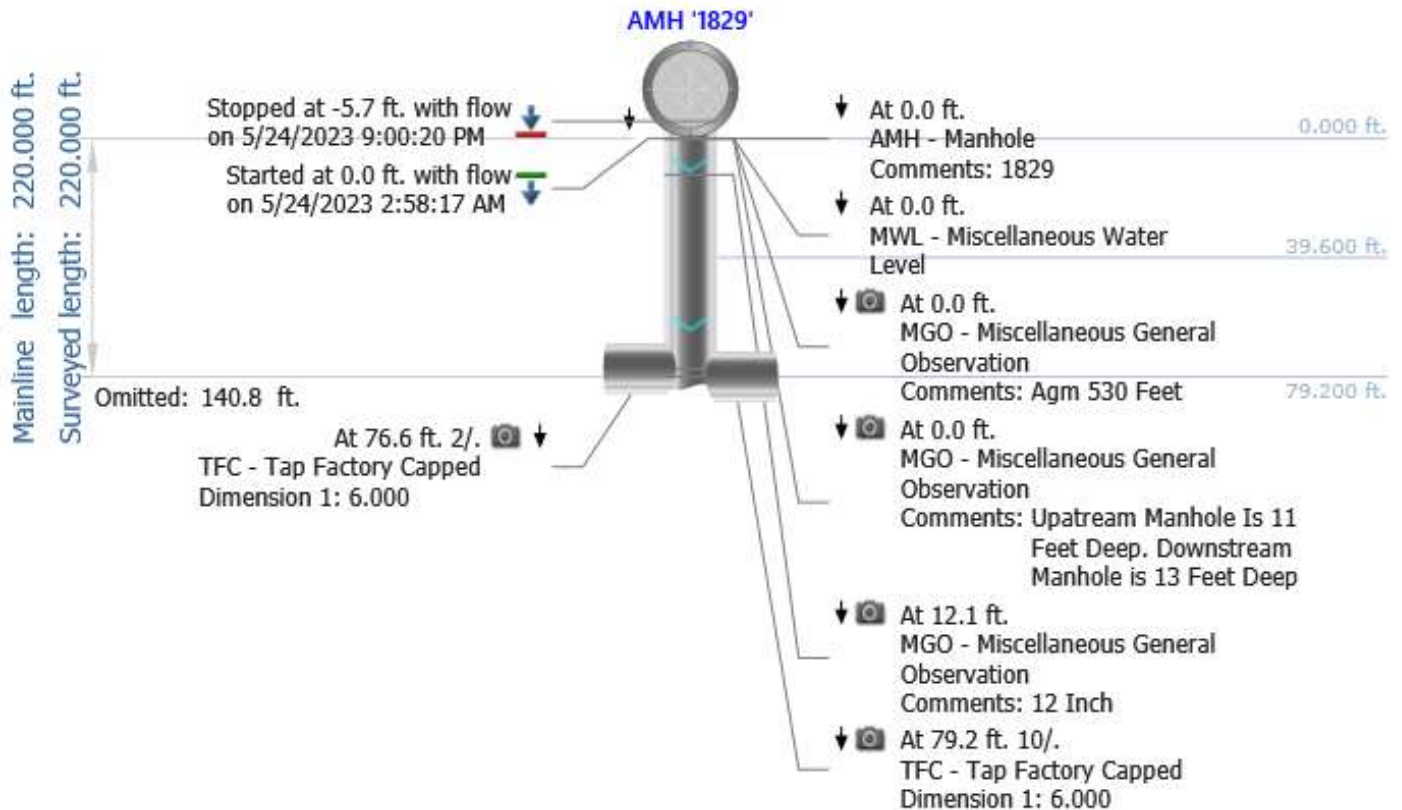

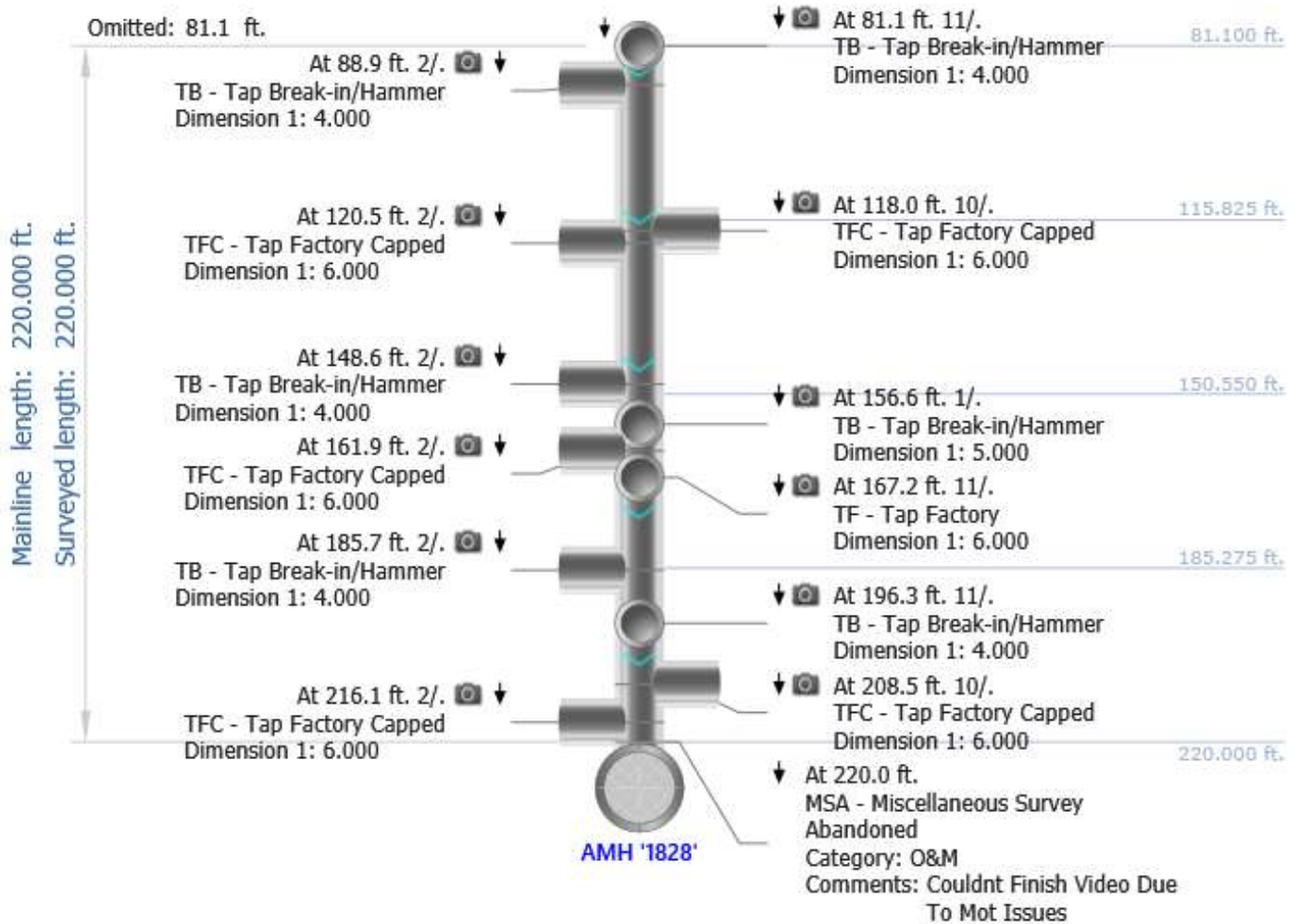



Defect Listing

Pipe Segment Reference 1829_1828	City GEORGETOWN	Street FRASER ST.	Material Vitrified Clay Pipe	Location Code <small>Primary major arterial roads, interstates, numbered roads</small>	Pipe Use Sanitary Sewage Pipe
Upstream MH 1829	Total Length	Year Constructed	Shape Circular	Location Details WINYAH/S FRASER	
Downstream MH 1828	Length surveyed 506.3	Year Renewed	Height 12	Width	Pipe Joint Length

SPR 78	MPR 13	PO Number		Customer CITY OF GEORGETOWN	
SPRI 3.4	MPRI 3.3	Work Order Number		Purpose Maintenance Related	
QSR 524A	QMR 4231				
OPR 91	Surveyed By Eddie Newman	Direction Downstream	Date 08/10/2023		Media label
OPRI 3.4	Certificate Number U-1018-0703003236	Pre-Cleaning Heavy Cleaning	Time 04:38		Weather
Date Cleaned			End Time 05:26		Additional Info

Distance	Condition	Cont. Dfct.	Values			Joint	Clock Position		Grade
			1st	2nd	%		At/From	To	
0	Access Point Manhole					<input type="checkbox"/>			
Remarks: 1829									
0	Miscellaneous Water Level				10	<input type="checkbox"/>			
3.5	Crack Longitudinal	S01				<input checked="" type="checkbox"/>	12		2
Remarks: CRACK STARTS AT MH									
6.9	Crack Longitudinal	F01				<input checked="" type="checkbox"/>	12		2
Remarks: CRACK STARTS AT MH									
28.7	Miscellaneous Water Level				15	<input type="checkbox"/>			
45.9	Miscellaneous Water Level				5	<input type="checkbox"/>			
53.7	Miscellaneous Water Level				10	<input type="checkbox"/>			
60.2	Miscellaneous Water Level Sag				5	<input type="checkbox"/>			2
Remarks: SAG									
74.4	Tap Factory Made Capped		4			<input type="checkbox"/>	1		
76.8	Tap Factory Made Capped		4			<input type="checkbox"/>	11		
78.9	Hole					<input type="checkbox"/>	11		4
Remarks: HOLE OR POSSIBLE LATERAL									
86.4	Hole					<input type="checkbox"/>	1		4
Remarks: HOLE OR POSSIBLE LATERAL									
93.9	Miscellaneous Water Level				10	<input type="checkbox"/>			
114.9	Tap Factory Made Capped		4			<input type="checkbox"/>	11		
Remarks: CAPPED WITH BRICK									
117.3	Tap Factory Activity		4			<input type="checkbox"/>	2		
Remarks: UNKNOWN IF ACTUALLY ACTIVE									
126.5	Fracture Circumferential					<input checked="" type="checkbox"/>	5	7	2
Remarks: FRACTURE IN BOTTOM OF PIPE									
129.3	Miscellaneous Water Level				25	<input type="checkbox"/>			
145.1	Hole					<input type="checkbox"/>	1		4
Remarks: HOLE OR POSSIBEL OLD LATERAL									
152.6	Hole					<input type="checkbox"/>	11		4
Remarks: HOLE OR POSSIBLE OLD LATERAL									
158.1	Tap Factory Made Capped		4			<input type="checkbox"/>	1		
Remarks: CAPPED OFF WITH BRICK									
163.1	Tap Factory Activity		4			<input type="checkbox"/>	11		
165.3	Miscellaneous Water Level				15	<input type="checkbox"/>			
181.1	Hole					<input type="checkbox"/>	1		
Remarks: HOLE OR OLD LATERAL									
191.6	Tap Break-in Activity		4			<input type="checkbox"/>	11		



Defect Listing

Pipe Segment Reference	City	Street	Material	Location Code	Pipe Use
1829_1828	GEORGETOWN	FRASER ST.	Vitrified Clay Pipe		Sanitary Sewage Pipe
Upstream MH 1829	Total Length	Year Constructed	Shape Circular	Location Details WINYAH/S FRASER	
Downstream MH 1828	Length surveyed 506.3	Year Renewed	Height 12	Width	Pipe Joint Length
Remarks: WITH INFILTRATION					
203.6	Tap Factory Made Capped	4	<input type="checkbox"/>	11	
Remarks: CAPPED WITH BRICK					
211.1	Tap Factory Made Capped	4	<input type="checkbox"/>	1	
Remarks: CAPPED WITH BRICK					
223.5	Hole		<input type="checkbox"/>	1	4
Remarks: HOLE OR OLD LATERAL					
230.6	Miscellaneous Camera Underwater		<input type="checkbox"/>		4
249	Tap Factory Made Abandoned	4	<input type="checkbox"/>	1	
Remarks: FILLED WITH UNKNOWN SUBSTANCE					
251.6	Tap Factory Made Capped	4	<input type="checkbox"/>	10	
Remarks: CAPPED WITH BRICK					
272.1	Hole		<input type="checkbox"/>	1	4
Remarks: HOLE OR OLD LATERAL					
285	Hole		<input type="checkbox"/>	11	4
Remarks: HOLE OR OLD LATERAL					
288.6	Crack Circumferential		<input checked="" type="checkbox"/>	3	5 1
Remarks: CRACK AT JOINT					
288.6	Miscellaneous Water Level		35	<input type="checkbox"/>	
291.8	Miscellaneous Camera Underwater		<input type="checkbox"/>		4
Remarks: CAMERA UNDERWATER					
297	Tap Factory Made Capped	4	<input type="checkbox"/>	1	
Remarks: CAPPED WITH BRICK					
308.1	Hole		<input type="checkbox"/>	1	4
Remarks: ;HOLE OR OLD LATERAL					
315	Tap Factory Activity	4	<input type="checkbox"/>	10	
315.2	Hole		<input type="checkbox"/>	11	4
Remarks: HOLE OR OLD LATERAL					
343.5	Hole		<input type="checkbox"/>	11	4
Remarks: HOLE OR OLD LATERAL					
345.2	Tap Factory Made Capped	4	<input type="checkbox"/>	1	
Remarks: CAPPED WITH BRICK					
350.3	Tap Factory Made Capped	4	<input type="checkbox"/>	11	
Remarks: CAPPED DEFECTIVE					
370.7	Tap Factory Activity	4	<input type="checkbox"/>	11	
386.3	Hole		<input type="checkbox"/>	11	4
Remarks: HOLE OR OLD LATERAL					
388.7	Tap Factory Made	4	<input type="checkbox"/>	2	
Remarks: CAPPED WITH BRICK					
393.8	Tap Break-in Activity	4	<input type="checkbox"/>	2	
422.1	Tap Factory Activity	4	<input type="checkbox"/>	10	
Remarks: SMALLER PIPE INSIDE TF					
462.6	Tap Factory Made Capped	4	<input type="checkbox"/>	2	
Remarks: CAPPED WITH BRICK					
472.5	Tap Factory Made Defective	4	<input type="checkbox"/>	9	3
Remarks: INFILTRATION					
474.2	Crack Multiple		<input checked="" type="checkbox"/>	7	2 3
Remarks: MULTIPLE CRACKS					



Defect Listing

Pipe Segment Reference	City	Street	Material	Location Code	Pipe Use				
1829_1828	GEORGETOWN	FRASER ST.	Vitrified Clay Pipe	<small>Primary major arterial roads, interstates, numbered rds</small>	Sanitary Sewage Pipe				
Upstream MH 1829	Total Length	Year Constructed	Shape Circular	Location Details WINYAH/S FRASER					
Downstream MH 1828	Length surveyed 506.3	Year Renewed	Height 12	Width	Pipe Joint Length				
487.2	Crack Longitudinal	S02		<input type="checkbox"/>	12				2
Remarks: CRACK IN TOP OF PIPE									
493.2	Broken Pipe Soil Visible			<input checked="" type="checkbox"/>	8		2		5
Remarks: PIECE OF PIPE MISSING THROUGHOUT MOST OF JOINT WITH SOIL VISIBLE									
505.2	Hole Soil Visible			<input checked="" type="checkbox"/>	8		4		5
Remarks: PIPW IS BROKEN WITH HOLE AND SOIL VISIBLE									
505.2	Joint Offset Large Defective			<input type="checkbox"/>					4
Remarks: PIPE HAS BECOME DISLODGED AT JOINT WITH SOIL VISIBLE									
506.3	Crack Longitudinal	F02		<input type="checkbox"/>	12				2
Remarks: CRACK IN TOP OF PIPE									
506.3	Miscellaneous General Observation			<input type="checkbox"/>					
Remarks: PIPE IS OFFSET SEVERELY NEAR MH CAN NOT PROCEED									
506.3	Miscellaneous Survey Abandoned			<input type="checkbox"/>					
Remarks: END OF SURVEY CAN NOT PROCEED									
506.3	Miscellaneous General Observation			<input type="checkbox"/>					
Remarks: NOTE* POSSIBLE JOLD AT NEXT JOINT ALSO, UNABLE TO PROCEED AT THIS POINT									



Defect Listing Plot

Pipe Segment Reference 1829_1828	City GEORGETOWN	Street FRASER ST.	Material Vitrified Clay Pipe	Location Code <small>Primary major arterial roads, interstates, numbered rd</small>	Pipe Use Sanitary Sewage Pipe
Upstream MH 1829	Total Length	Year Constructed	Shape Circular	Location Details WINYAH/S FRASER	
Downstream MH 1828	Length surveyed 506.3	Year Renewed	Height 12	Width	Pipe Joint Length

SPR 78	MPR 13	PO Number		Customer CITY OF GEORGETOWN	
SPRI 3.4	MPRI 3.3	Work Order Number		Purpose Maintenance Related	
QSR 524A	QMR 4231				
OPR 91	Surveyed By Eddie Newman	Direction Downstream	Date 08/10/2023	Media label	
OPRI 3.4	Certificate Number U-1018-0703003236	Pre-Cleaning Heavy Cleaning	Time 04:38	Weather	
Date Cleaned			End Time 05:26	Additional Info	

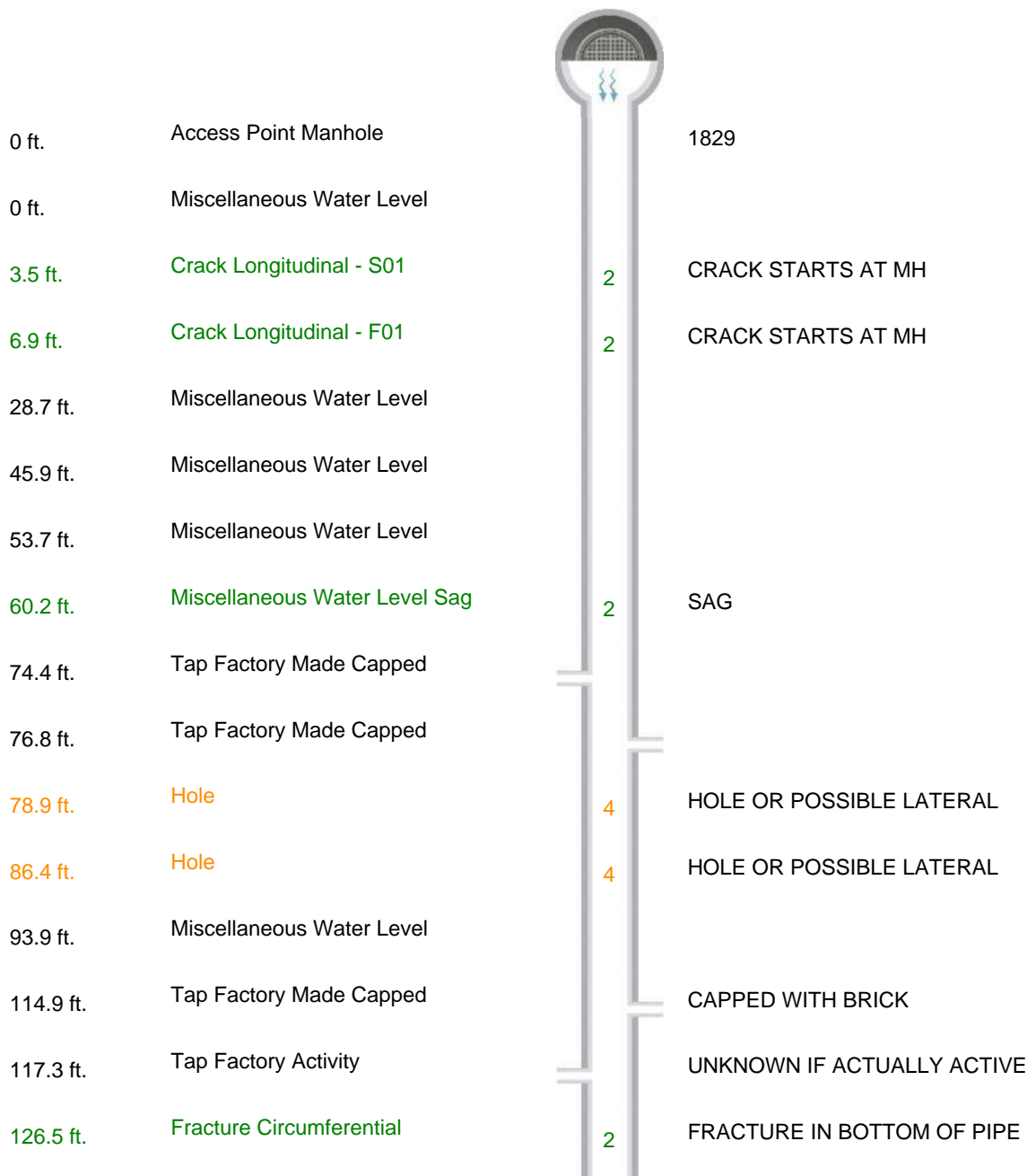



Defect Listing Plot

Pipe Segment Reference 1829_1828	City GEORGETOWN	Street FRASER ST.	Material Vitrified Clay Pipe		Location Code <small>Primary major arterial roads, interstates, numbered rd</small>	Pipe Use Sanitary Sewage Pipe
Upstream MH 1829	Total Length	Year Constructed	Shape Circular		Location Details WINYAH/S FRASER	
Downstream MH 1828	Length surveyed 506.3	Year Renewed	Height 12	Width	Pipe Joint Length	





Defect Listing Plot

Pipe Segment Reference 1829_1828	City GEORGETOWN	Street FRASER ST.	Material Vitrified Clay Pipe	Location Code <small>Primary major arterial roads, interstates, numbered rd</small>	Pipe Use Sanitary Sewage Pipe
Upstream MH 1829	Total Length	Year Constructed	Shape Circular	Location Details WINYAH/S FRASER	
Downstream MH 1828	Length surveyed 506.3	Year Renewed	Height 12	Width	Pipe Joint Length

315.2 ft.	Hole	4	HOLE OR OLD LATERAL
343.5 ft.	Hole	4	HOLE OR OLD LATERAL
345.2 ft.	Tap Factory Made Capped		CAPPED WITH BRICK
350.3 ft.	Tap Factory Made Capped		CAPPED DEFECTIVE
370.7 ft.	Tap Factory Activity		
386.3 ft.	Hole	4	HOLE OR OLD LATERAL
388.7 ft.	Tap Factory Made		CAPPED WITH BRICK
393.8 ft.	Tap Break-in Activity		
422.1 ft.	Tap Factory Activity		SMALLER PIPE INSIDE TF
462.6 ft.	Tap Factory Made Capped		CAPPED WITH BRICK
472.5 ft.	Tap Factory Made Defective	3	INFILTRATION
474.2 ft.	Crack Multiple	3	MULTIPLE CRACKS
487.2 ft.	Crack Longitudinal - S02	2	CRACK IN TOP OF PIPE
493.2 ft.	Broken Pipe Soil Visible	5	PIECE OF PIPE MISSING THROUGHOUT MOST OF JOINT WITH SOIL VISIBLE
505.2 ft.	Hole Soil Visible	5	PIPW IS BROKEN WITH HOLE AND SOIL VISIBLE
505.2 ft.	Joint Offset Large Defective	4	PIPE HAS BECOME DISLODGED AT JOINT WITH SOIL VISIBLE
506.3 ft.	Crack Longitudinal - F02	2	CRACK IN TOP OF PIPE
506.3 ft.	Miscellaneous General Observation		PIPE IS OFFSET SEVERELY NEAR MH CAN NOT PROCEED
506.3 ft.	Miscellaneous Survey Abandoned		END OF SURVEY CAN NOT PROCEED
506.3 ft.	Miscellaneous General Observation		NOTE* POSSIBLE JOLD AT NEXT JOINT ALSO, UNABLE TO PROCEED AT THIS POINT



Defect Listing Plot

Pipe Segment Reference 1829_1828	City GEORGETOWN	Street FRASER ST.	Material Vitrified Clay Pipe		Location Code <small>Primary major arterial roads, interstates, numbered rd</small>	Pipe Use Sanitary Sewage Pipe
Upstream MH 1829	Total Length	Year Constructed	Shape Circular		Location Details WINYAH/S FRASER	
Downstream MH 1828	Length surveyed 506.3	Year Renewed	Height 12	Width	Pipe Joint Length	



1828



4 Image Report

Pipe Segment Reference 1829_1828	City GEORGETOWN	Street FRASER ST.	Material Vitrified Clay Pipe	Location Code <small>Primary major arterial road, interstates, numbered road</small>	Pipe Use Sanitary Sewage Pipe
Upstream MH 1829	Total Length	Year Constructed	Shape Circular	Location Details WINYAH/S FRASER	
Downstream MH 1828	Length surveyed 506.3	Year Renewed	Height 12	Width	Pipe Joint Length



Distance: 0.0 ft. Grade: 0
 Condition: Access Point Manhole
 Remarks: 1829



Distance: 0.0 ft. Grade: 0
 Condition: Miscellaneous Water Level
 Remarks: N/A

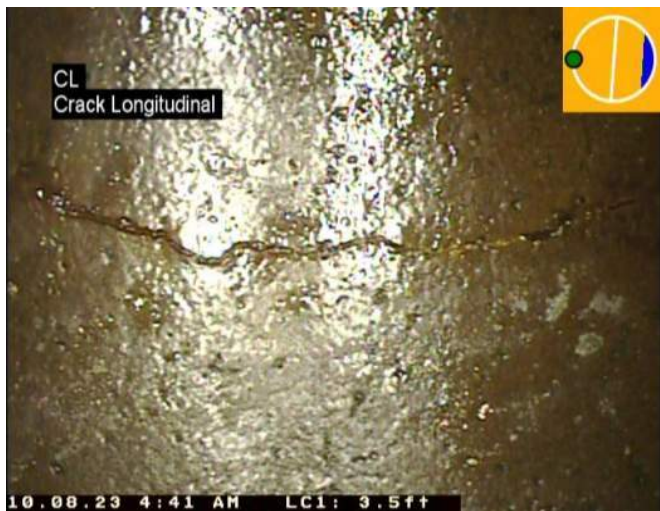

Distance: 3.5 ft. Grade: 2
 Condition: Crack Longitudinal
 Remarks: CRACK STARTS AT MH



Distance: 6.9 ft. Grade: 2
 Condition: Crack Longitudinal
 Remarks: CRACK STARTS AT MH



4 Image Report

Pipe Segment Reference 1829_1828	City GEORGETOWN	Street FRASER ST.	Material Vitrified Clay Pipe	Location Code <small>Primary major arterial roads, interstates, numbered rds</small>	Pipe Use Sanitary Sewage Pipe
Upstream MH 1829	Total Length	Year Constructed	Shape Circular	Location Details WINYAH/S FRASER	
Downstream MH 1828	Length surveyed 506.3	Year Renewed	Height 12	Width	Pipe Joint Length



Distance: 28.7 ft. Grade: 0
 Condition: Miscellaneous Water Level
 Remarks: N/A



Distance: 45.9 ft. Grade: 0
 Condition: Miscellaneous Water Level
 Remarks: N/A



Distance: 53.7 ft. Grade: 0
 Condition: Miscellaneous Water Level
 Remarks: N/A



Distance: 60.2 ft. Grade: 2
 Condition: Miscellaneous Water Level Sag
 Remarks: SAG



4 Image Report

Pipe Segment Reference 1829_1828	City GEORGETOWN	Street FRASER ST.	Material Vitrified Clay Pipe	Location Code <small>Primary major arterial roads, interstates, numbered roads</small>	Pipe Use Sanitary Sewage Pipe
Upstream MH 1829	Total Length	Year Constructed	Shape Circular	Location Details WINYAH/S FRASER	
Downstream MH 1828	Length surveyed 506.3	Year Renewed	Height 12	Width	Pipe Joint Length



Distance: 74.4 ft. Grade: 0
 Condition: Tap Factory Made Capped
 Remarks: N/A



Distance: 76.8 ft. Grade: 0
 Condition: Tap Factory Made Capped
 Remarks: N/A

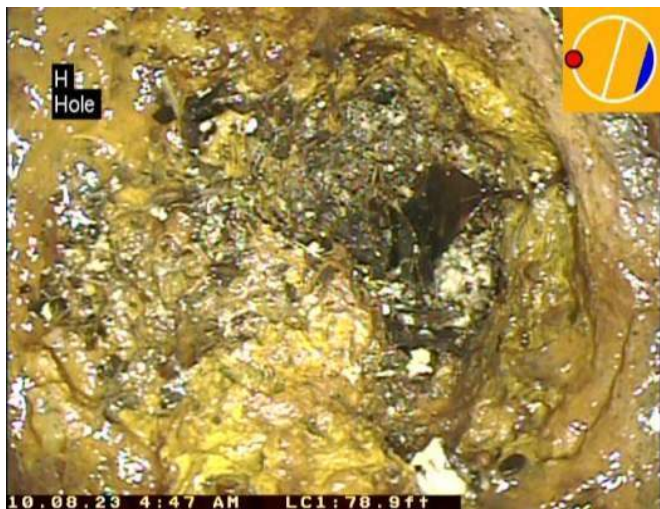

Distance: 78.9 ft. Grade: 4
 Condition: Hole
 Remarks: HOLE OR POSSIBLE LATERAL

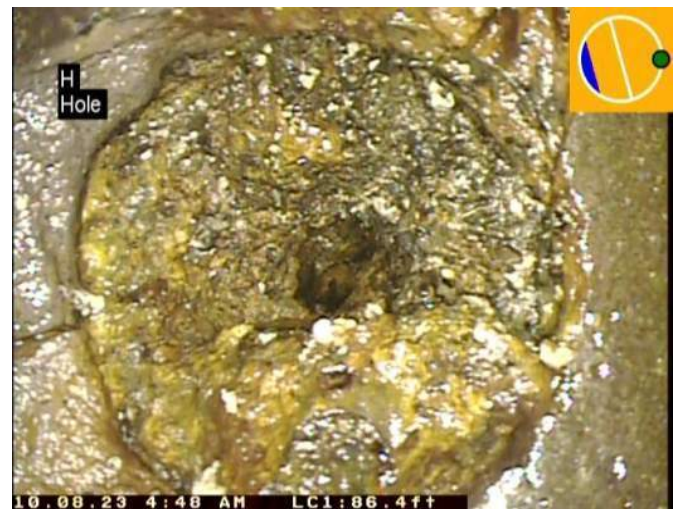

Distance: 86.4 ft. Grade: 4
 Condition: Hole
 Remarks: HOLE OR POSSIBLE LATERAL



4 Image Report

Pipe Segment Reference 1829_1828	City GEORGETOWN	Street FRASER ST.	Material Vitrified Clay Pipe	Location Code <small>Primary major arterial roads, interstates, numbered rds</small>	Pipe Use Sanitary Sewage Pipe
Upstream MH 1829	Total Length	Year Constructed	Shape Circular	Location Details WINYAH/S FRASER	
Downstream MH 1828	Length surveyed 506.3	Year Renewed	Height 12	Width	Pipe Joint Length



CC
Crack Circumferential

10.08.23 4:48 AM LC1:87.0ft

Distance: 93.9 ft. Grade: 0
 Condition: Miscellaneous Water Level
 Remarks: N/A



TFC
Tap Factory Made Capped

10.08.23 4:50 AM LC1:114.9ft

Distance: 114.9 ft. Grade: 0
 Condition: Tap Factory Made Capped
 Remarks: CAPPED WITH BRICK



TFA
Tap Factory Activity

10.08.23 4:51 AM LC1:117.3ft

Distance: 117.3 ft. Grade: 0
 Condition: Tap Factory Activity
 Remarks: UNKNOWN IF ACTUALLY ACTIVE



FC
Fracture Circumferential

10.08.23 4:52 AM LC1:126.6ft

Distance: 126.5 ft. Grade: 2
 Condition: Fracture Circumferential
 Remarks: FRACTURE IN BOTTOM OF PIPE



4 Image Report

Pipe Segment Reference 1829_1828	City GEORGETOWN	Street FRASER ST.	Material Vitrified Clay Pipe	Location Code <small>Primary major arterial roads, interstates, numbered roads</small>	Pipe Use Sanitary Sewage Pipe
Upstream MH 1829	Total Length	Year Constructed	Shape Circular	Location Details WINYAH/S FRASER	
Downstream MH 1828	Length surveyed 506.3	Year Renewed	Height 12	Width	Pipe Joint Length



Distance: 129.3 ft. Grade: 0
 Condition: Miscellaneous Water Level
 Remarks: N/A



Distance: 145.1 ft. Grade: 4
 Condition: Hole
 Remarks: HOLE OR POSSIBEL OLD LATERAL

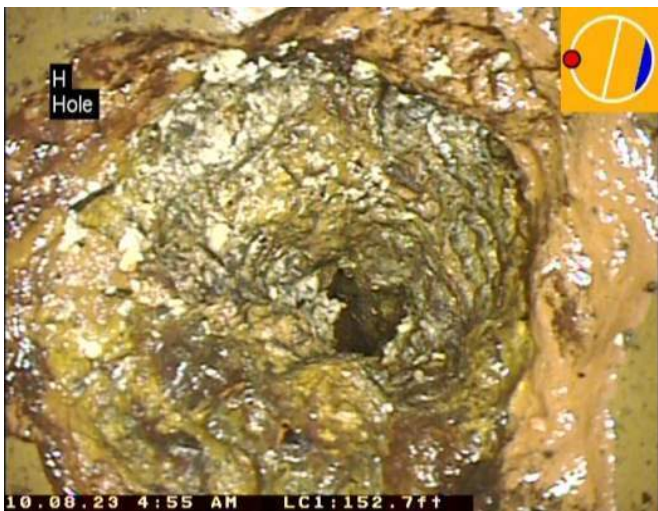

Distance: 152.6 ft. Grade: 4
 Condition: Hole
 Remarks: HOLE OR POSSIBLE OLD LATERAL



Distance: 158.1 ft. Grade: 0
 Condition: Tap Factory Made Capped
 Remarks: CAPPED OFF WITH BRICK



4 Image Report

Pipe Segment Reference 1829_1828	City GEORGETOWN	Street FRASER ST.	Material Vitrified Clay Pipe	Location Code <small>Primary major arterial roads, interstates, numbered rds</small>	Pipe Use Sanitary Sewage Pipe
Upstream MH 1829	Total Length	Year Constructed	Shape Circular	Location Details WINYAH/S FRASER	
Downstream MH 1828	Length surveyed 506.3	Year Renewed	Height 12	Width	Pipe Joint Length



Distance: 163.1 ft. Grade: 0
 Condition: Tap Factory Activity
 Remarks: N/A



Distance: 165.3 ft. Grade: 0
 Condition: Miscellaneous Water Level
 Remarks: N/A



Distance: 181.1 ft. Grade: 4
 Condition: Hole
 Remarks: HOLE OR OLD LATERAL

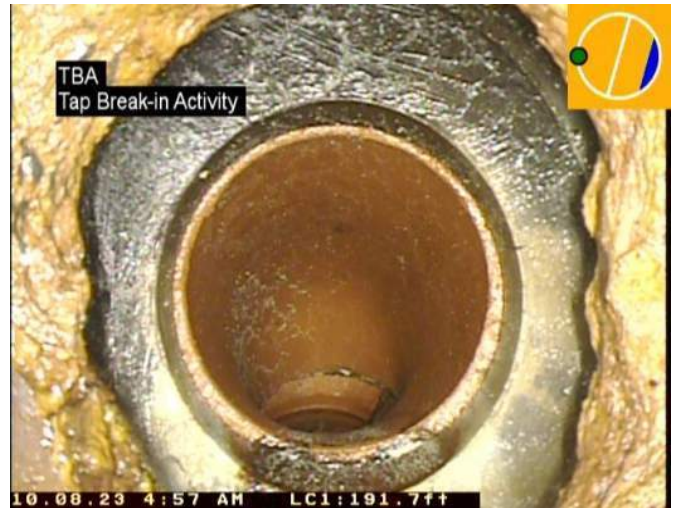

Distance: 191.6 ft. Grade: 0
 Condition: Tap Break-in Activity
 Remarks: WITH INFILTRATION



4 Image Report

Pipe Segment Reference 1829_1828	City GEORGETOWN	Street FRASER ST.	Material Vitrified Clay Pipe	Location Code <small>Primary major arterial roads, interstates, numbered rds</small>	Pipe Use Sanitary Sewage Pipe
Upstream MH 1829	Total Length	Year Constructed	Shape Circular	Location Details WINYAH/S FRASER	
Downstream MH 1828	Length surveyed 506.3	Year Renewed	Height 12	Width	Pipe Joint Length



Distance: 203.6 ft. Grade: 0
 Condition: Tap Factory Made Capped
 Remarks: CAPPED WITH BRICK



Distance: 211.1 ft. Grade: 0
 Condition: Tap Factory Made Capped
 Remarks: CAPPED WITH BRICK



Distance: 223.5 ft. Grade: 4
 Condition: Hole
 Remarks: HOLE OR OLD LATERAL



Distance: 230.6 ft. Grade: 4
 Condition: Miscellaneous Camera Underwater
 Remarks: N/A



4 Image Report

Pipe Segment Reference 1829_1828	City GEORGETOWN	Street FRASER ST.	Material Vitrified Clay Pipe	Location Code <small>Primary major arterial roads, interstates, numbered roads</small>	Pipe Use Sanitary Sewage Pipe
Upstream MH 1829	Total Length	Year Constructed	Shape Circular	Location Details WINYAH/S FRASER	
Downstream MH 1828	Length surveyed 506.3	Year Renewed	Height 12	Width	Pipe Joint Length



Distance: 249.0 ft. **Grade:** 0
Condition: Tap Factory Made Abandoned
Remarks: FILLED WITH UNKNOWN SUBSTANCE



Distance: 251.6 ft. **Grade:** 0
Condition: Tap Factory Made Capped
Remarks: CAPPED WITH BRICK

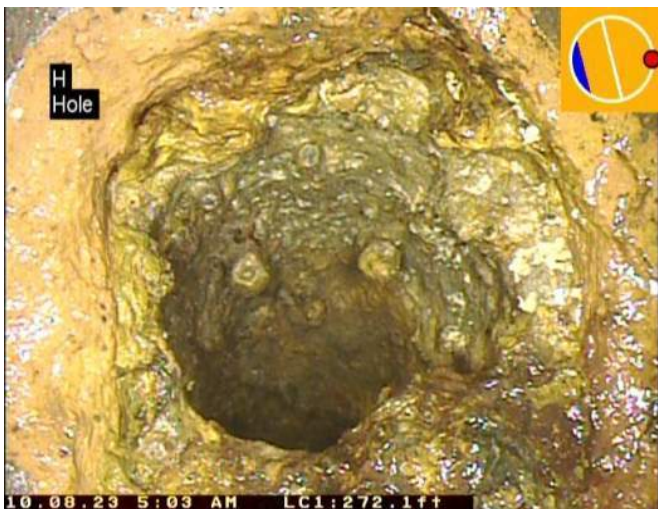

Distance: 272.1 ft. **Grade:** 4
Condition: Hole
Remarks: HOLE OR OLD LATERAL



Distance: 285.0 ft. **Grade:** 4
Condition: Hole
Remarks: HOLE OR OLD LATERAL



4 Image Report

Pipe Segment Reference 1829_1828	City GEORGETOWN	Street FRASER ST.	Material Vitrified Clay Pipe	Location Code <small>Primary major arterial roads, interstates, numbered rds</small>	Pipe Use Sanitary Sewage Pipe
Upstream MH 1829	Total Length	Year Constructed	Shape Circular	Location Details WINYAH/S FRASER	
Downstream MH 1828	Length surveyed 506.3	Year Renewed	Height 12	Width	Pipe Joint Length



Distance: 288.6 ft. Grade: 1
 Condition: Crack Circumferential
 Remarks: CRACK AT JOINT



Distance: 288.6 ft. Grade: 0
 Condition: Miscellaneous Water Level
 Remarks: N/A



Distance: 291.8 ft. Grade: 4
 Condition: Miscellaneous Camera Underwater
 Remarks: CAMERA UNDERWATER



Distance: 297.0 ft. Grade: 0
 Condition: Tap Factory Made Capped
 Remarks: CAPPED WITH BRICK



4 Image Report

Pipe Segment Reference 1829_1828	City GEORGETOWN	Street FRASER ST.	Material Vitrified Clay Pipe	Location Code <small>Primary major arterial roads, interstates, numbered rds</small>	Pipe Use Sanitary Sewage Pipe
Upstream MH 1829	Total Length	Year Constructed	Shape Circular	Location Details WINYAH/S FRASER	
Downstream MH 1828	Length surveyed 506.3	Year Renewed	Height 12	Width	Pipe Joint Length



Distance: 308.1 ft. Grade: 4
 Condition: Hole
 Remarks: ;HOLE OR OLD LATERAL



Distance: 315.0 ft. Grade: 0
 Condition: Tap Factory Activity
 Remarks: N/A



Distance: 315.2 ft. Grade: 4
 Condition: Hole
 Remarks: HOLE OR OLD LATERAL



Distance: 343.5 ft. Grade: 4
 Condition: Hole
 Remarks: HOLE OR OLD LATERAL



4 Image Report

Pipe Segment Reference 1829_1828	City GEORGETOWN	Street FRASER ST.	Material Vitrified Clay Pipe	Location Code <small>Primary major arterial roads, interstates, numbered rds</small>	Pipe Use Sanitary Sewage Pipe
Upstream MH 1829	Total Length	Year Constructed	Shape Circular	Location Details WINYAH/S FRASER	
Downstream MH 1828	Length surveyed 506.3	Year Renewed	Height 12	Width	Pipe Joint Length



Distance: 345.2 ft. Grade: 0
 Condition: Tap Factory Made Capped
 Remarks: CAPPED WITH BRICK

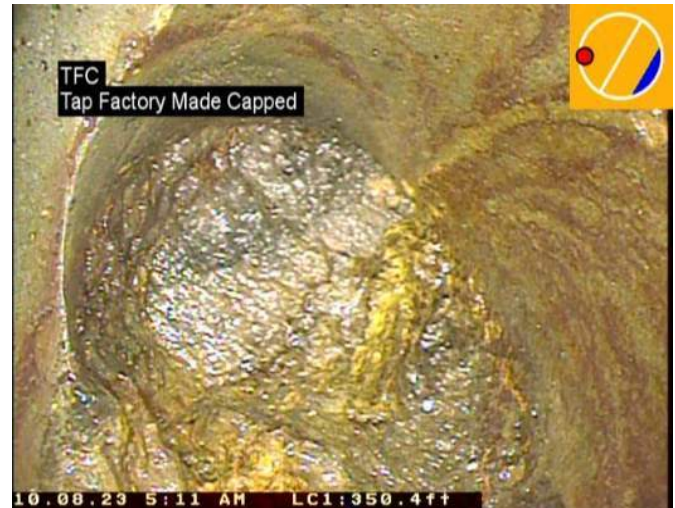

Distance: 350.3 ft. Grade: 0
 Condition: Tap Factory Made Capped
 Remarks: CAPPED DEFECTIVE



Distance: 370.7 ft. Grade: 0
 Condition: Tap Factory Activity
 Remarks: N/A



Distance: 386.3 ft. Grade: 4
 Condition: Hole
 Remarks: HOLE OR OLD LATERAL



4 Image Report

Pipe Segment Reference 1829_1828	City GEORGETOWN	Street FRASER ST.	Material Vitrified Clay Pipe	Location Code <small>Primary major arterial road, interstates, numbered road</small>	Pipe Use Sanitary Sewage Pipe
Upstream MH 1829	Total Length	Year Constructed	Shape Circular	Location Details WINYAH/S FRASER	
Downstream MH 1828	Length surveyed 506.3	Year Renewed	Height 12	Width	Pipe Joint Length



Distance: 388.7 ft. Grade: 0
 Condition: Tap Factory Made
 Remarks: CAPPED WITH BRICK



Distance: 393.8 ft. Grade: 0
 Condition: Tap Break-in Activity
 Remarks: N/A



Distance: 422.1 ft. Grade: 0
 Condition: Tap Factory Activity
 Remarks: SMALLER PIPE INSIDE TF



Distance: 462.6 ft. Grade: 0
 Condition: Tap Factory Made Capped
 Remarks: CAPPED WITH BRICK



4 Image Report

Pipe Segment Reference 1829_1828	City GEORGETOWN	Street FRASER ST.	Material Vitrified Clay Pipe	Location Code <small>Primary major arterial roads, interstates, numbered roads</small>	Pipe Use Sanitary Sewage Pipe
Upstream MH 1829	Total Length	Year Constructed	Shape Circular	Location Details WINYAH/S FRASER	
Downstream MH 1828	Length surveyed 506.3	Year Renewed	Height 12	Width	Pipe Joint Length



Distance: 472.5 ft. **Grade:** 3
Condition: Tap Factory Made Defective
Remarks: INFILTRATION



Distance: 474.2 ft. **Grade:** 3
Condition: Crack Multiple
Remarks: MULTIPLE CRACKS



Distance: 487.2 ft. **Grade:** 2
Condition: Crack Longitudinal
Remarks: CRACK IN TOP OF PIPE



Distance: 493.2 ft. **Grade:** 5
Condition: Broken Pipe Soil Visible
Remarks: PIECE OF PIPE MISSING THROUGHOUT MOST OF JOINT WITH SOIL VISIBLE



4 Image Report

Pipe Segment Reference 1829_1828	City GEORGETOWN	Street FRASER ST.	Material Vitrified Clay Pipe	Location Code <small>Primary major arterial road, interstates, numbered road</small>	Pipe Use Sanitary Sewage Pipe
Upstream MH 1829	Total Length	Year Constructed	Shape Circular	Location Details WINYAH/S FRASER	
Downstream MH 1828	Length surveyed 506.3	Year Renewed	Height 12	Width	Pipe Joint Length



Distance: 505.2 ft. **Grade:** 5
Condition: Hole Soil Visible
Remarks: PIPW IS BROKEN WITH HOLE AND SOIL VISIBLE



Distance: 506.3 ft. **Grade:** 2
Condition: Crack Longitudinal
Remarks: CRACK IN TOP OF PIPE

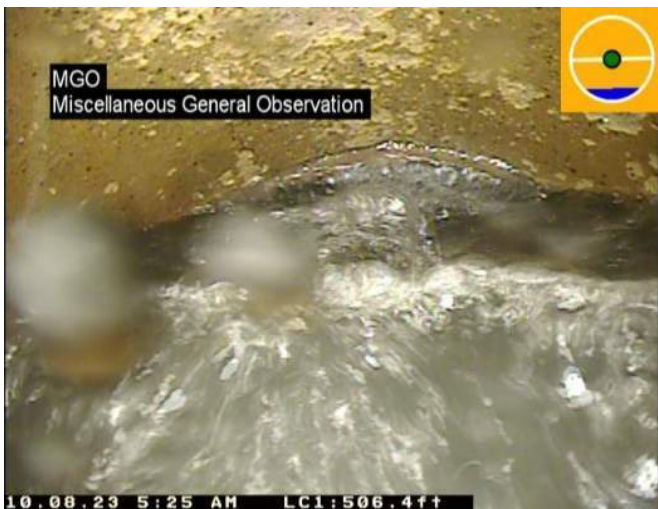

Distance: 506.3 ft. **Grade:** 0
Condition: Miscellaneous General Observation
Remarks: PIPE IS OFFSET SEVERELY NEAR MH CAN NOT PROCEED

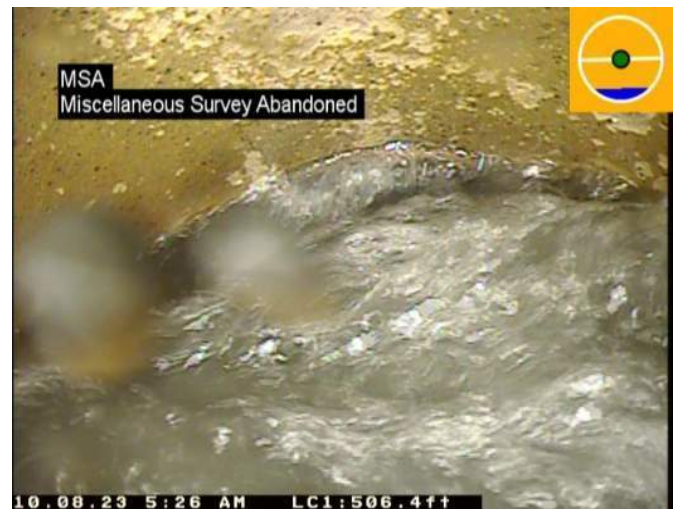

Distance: 506.3 ft. **Grade:** 0
Condition: Miscellaneous Survey Abandoned
Remarks: END OF SURVEY CAN NOT PROCEED



4 Image Report

Pipe Segment Reference 1829_1828	City GEORGETOWN	Street FRASER ST.	Material Vitrified Clay Pipe	Location Code <small>Primary major arterial roads, interstates, numbered rds</small>	Pipe Use Sanitary Sewage Pipe
Upstream MH 1829	Total Length	Year Constructed	Shape Circular	Location Details WINYAH/S FRASER	
Downstream MH 1828	Length surveyed 506.3	Year Renewed	Height 12	Width	Pipe Joint Length



Distance: 505.2 ft. Grade: 4
 Condition: Joint Offset Large Defective
 Remarks: PIPE HAS BECOME DISLODGED AT JOINT WITH SOIL VISIBLE



Distance: 506.3 ft. Grade: 0
 Condition: Miscellaneous General Observation
 Remarks: NOTE* POSSIBLE JOLD AT NEXT JOINT ALSO, UNABLE TO PROCEED AT THIS POINT



Vortex Services
521 Federal Road
Livermore, ME 04253
(207) 897-3348

Main Inspections Summary

Weston & Sampson - 2319762

Mainline ID	End date/time	Surveyed by	Start MH	Finish MH	Material	Height	Total length	Length
2193 - 2194	5/15/2023 7:49 PM	Mike Swilley	2194	2193	VCP	8 in.	25.000 ft.	25.000 ft.
Sub-Total							25.0 ft.	25.0 ft.
Total							25.0 ft.	25.0 ft.



Vortex Services
 521 Federal Road
 Livermore, ME 04253
 (207) 897-3348

Main Inspections Small Photos and Scoring

Mainline ID: 2193 - 2194	City: Georgetown, SC	Street: S Fraiser St	Project name: Weston & Sampson - 2319762
Start date/time: 5/15/2023 7:35 PM	Total length: 25.000 ft.	Weather: 1	Surveyed by: Mike Swilley
Upstream MH No: 2193	Depth US: 4.000 ft.	Downstream MH No: 2194	Depth DS: 4.000 ft.
Shape: C	Material: VCP	Height: 8 in.	Width:
Additional info:			

Scores

Calculated at: **5/16/2023 3:19:37 PM**

Grade	Structural:				O&M:				Overall:	
	Segment Grade	Pipe Rating	Quick Rating	Pipe Rating Index	Segment Grade	Pipe Rating	Quick Rating	Pipe Rating Index	Pipe Rating	Pipe Rating Index
1	0	0	0000	0.0	0	0	0000	0.0	0	0.0
2	0				0					
3	0				0					
4	0				0					
5	0				0					

Observations

Distance	Dir.	Length	From/To	Code	Modifier	Rating	Remarks
0.0 ft.	U		/	AMH			2194
0.0 ft.	U		/	MWL			

Observations

Distance	Dir. Length	From/To Code	Modifier	Rating	Remarks
----------	-------------	--------------	----------	--------	---------

0.0 ft.	U	/	MGO		Agm 29 Feet
---------	---	---	-----	--	--------------------



0.0 ft.	U	/	MGO		8 inch
---------	---	---	-----	--	---------------



0.0 ft.	U	/	MGO		Both Manholes Are 4 Feet Deep
---------	---	---	-----	--	--------------------------------------



Observations

Distance	Dir. Length	From/To Code	Modifier	Rating	Remarks
25.0 ft.	U	/ AMH		2193	



Inspection's photos

Main Inspections Pipe Run and Scoring

Project name:	Mainline ID:	City:	Street:
Weston & Sampson - 2319762	2193 - 2194	Georgetown, SC	S Fraiser St
Start date/time:	Direction:	Weather:	Location code:
5/15/2023 7:35 PM	U	1	B
Shape:	Material:	Height:	Width:
C	VCP	8 in.	

Scores

Calculated at: **5/16/2023 3:19:37 PM**

Grade	Structural:				O&M:				Overall:	
	Segment Grade	Pipe Rating	Quick Rating	Pipe Rating Index	Segment Grade	Pipe Rating	Quick Rating	Pipe Rating Index	Pipe Rating	Pipe Rating Index
1	0	0	0000	0.0	0	0	0000	0.0	0	0.0
2	0									
3	0									
4	0									
5	0									

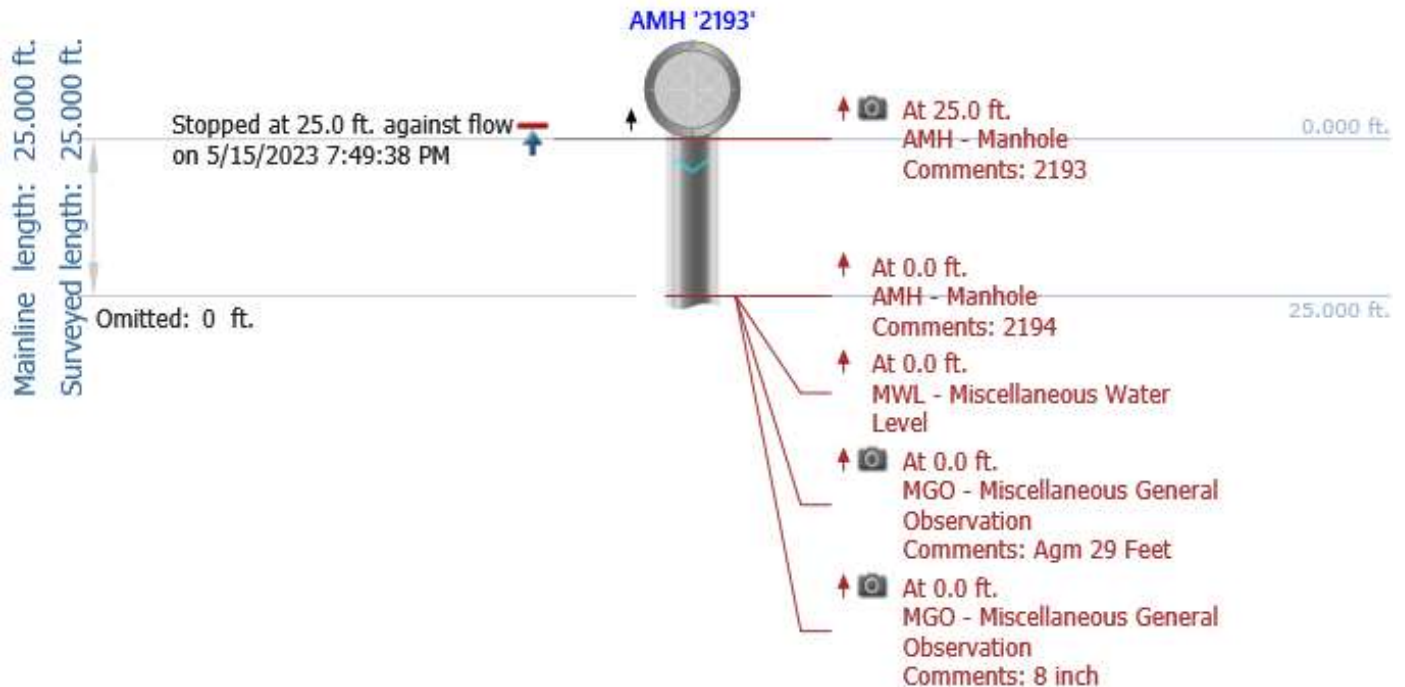

Project name:
**Weston & Sampson -
2319762**

Mainline ID:
2193 - 2194

Start date/time:
5/15/2023 7:35 PM

Direction:
U

Weather:

1

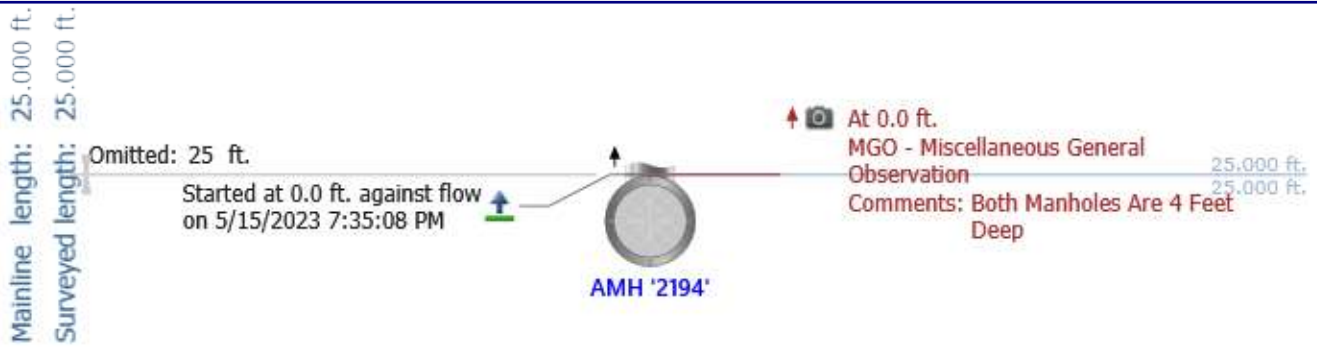



Vortex Services
521 Federal Road
Livermore, ME 04253
(207) 897-3348

Main Inspections Summary

Weston & Sampson - 2319762

Mainline ID	End date/time	Surveyed by	Start MH	Finish MH	Material	Height	Total length	Length
2194 - 1819	5/15/2023 9:20 PM	Mike Swilley	2194	1819	VCP	8 in.	450.000 ft.	450.000 ft.
Sub-Total							450.0 ft.	450.0 ft.
Total							450.0 ft.	450.0 ft.



Vortex Services
 521 Federal Road
 Livermore, ME 04253
 (207) 897-3348

Main Inspections Small Photos and Scoring

Mainline ID: 2194 - 1819	City: Georgetown, SC	Street: S Fraiser St	Project name: Weston & Sampson - 2319762
Start date/time: 5/15/2023 7:52 PM	Total length: 450.000 ft.	Weather: 1	Surveyed by: Mike Swilley
Upstream MH No: 2194	Depth US: 4.000 ft.	Downstream MH No: 1819	Depth DS: 9.000 ft.
Shape: C	Material: VCP	Height: 8 in.	Width:
Additional info:			

Scores



Calculated at: **5/16/2023 3:11:23 PM**

Grade	Structural:				O&M:				Overall:	
	Segment Grade	Pipe Rating	Quick Rating	Pipe Rating Index	Segment Grade	Pipe Rating	Quick Rating	Pipe Rating Index	Pipe Rating	Pipe Rating Index
1	0	3	3100	3.0	0	113	312J	2.0	116	2.0
2	0				110					
3	3				3					
4	0				0					
5	0				0					

Observations

Distance	Dir.	Length	From/To	Code	Modifier	Rating	Remarks
0.0 ft.	D		/	AMH			2194
0.0 ft.	D		/	MWL			

Observations

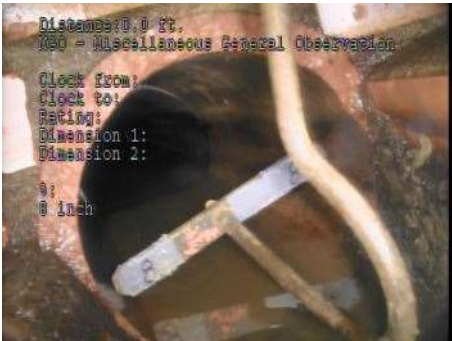
Distance	Dir.	Length	From/To	Code	Modifier	Rating	Remarks
0.0 ft.	D		/	MGO			Agm 458 Feet
							
0.0 ft.	D		/	MGO			Upstream manhole Is 4 Feet Deep. Downstream manhole Is 9 Feet Deep
							
0.0 ft.	D		/	MGO			8 inch
							

Observations

Distance	Dir.	Length	From/To	Code	Modifier	Rating	Remarks
----------	------	--------	---------	------	----------	--------	---------

63.4 ft. D 11 / TF



113.1 ft. D 12 / 5 CM

3



114.7 ft. D 9 / TF



Observations

Distance	Dir.	Length	From/To	Code	Modifier	Rating	Remarks
----------	------	--------	---------	------	----------	--------	---------

145.8 ft. D 10 / 4 DAE

2

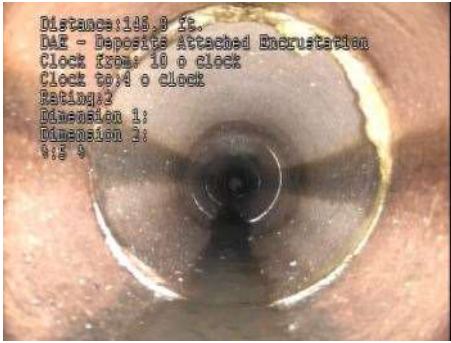

165.8 ft. D 9 / TF



167.0 ft. D 10 / 1 DAE

2



Observations

Distance	Dir. Length	From/To Code	Modifier	Rating	Remarks
----------	-------------	--------------	----------	--------	---------

183.5 ft. D 10 / 3 DAE

2



214.3 ft. D 11 / TF



214.3 ft. D / MGO

**Deposits In Lateral
 Causing 90 Percent
 Blockage**



Observations

Distance	Dir.	Length	From/To	Code	Modifier	Rating	Remarks
----------	------	--------	---------	------	----------	--------	---------

241.4 ft. D 9 / TF



241.4 ft. D 9 / IDL

3



271.5 ft. D 9 / TF



Observations

Distance	Dir.	Length	From/To	Code	Modifier	Rating	Remarks
----------	------	--------	---------	------	----------	--------	---------

271.6 ft.	D		/	MGO			Deposits In Lateral At 9 O'clock. Causing 95 Percent Blockage
-----------	---	--	---	-----	--	--	---

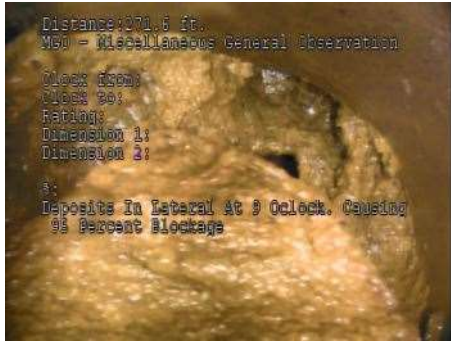

334.9 ft.	D		9 /	TF			
-----------	---	--	-----	----	--	--	--



355.6 ft.	D		11 /	TF			
-----------	---	--	------	----	--	--	--



Observations

Distance	Dir. Length	From/To Code	Modifier	Rating	Remarks
----------	-------------	--------------	----------	--------	---------

397.5 ft. D 9 / TF



449.5 ft. D 10 / 3 DAE

2



450.0 ft. D / AMH

1819



Inspection's photos

Main Inspections Pipe Run and Scoring

Project name:	Mainline ID:	City:	Street:
Weston & Sampson - 2319762	2194 - 1819	Georgetown, SC	S Fraiser St
Start date/time:	Direction:	Weather:	Location code:
5/15/2023 7:52 PM	D	1	
Shape:	Material:	Height:	Width:
C	VCP	8 in.	

Scores

Calculated at: **5/16/2023 3:11:23 PM**

Grade	Structural:				O&M:				Overall:	
	Segment Grade	Pipe Rating	Quick Rating	Pipe Rating Index	Segment Grade	Pipe Rating	Quick Rating	Pipe Rating Index	Pipe Rating	Pipe Rating Index
1	0	3	3100	3.0	0	113	312J	2.0	116	2.0
2	0				110					
3	3				3					
4	0				0					
5	0				0					

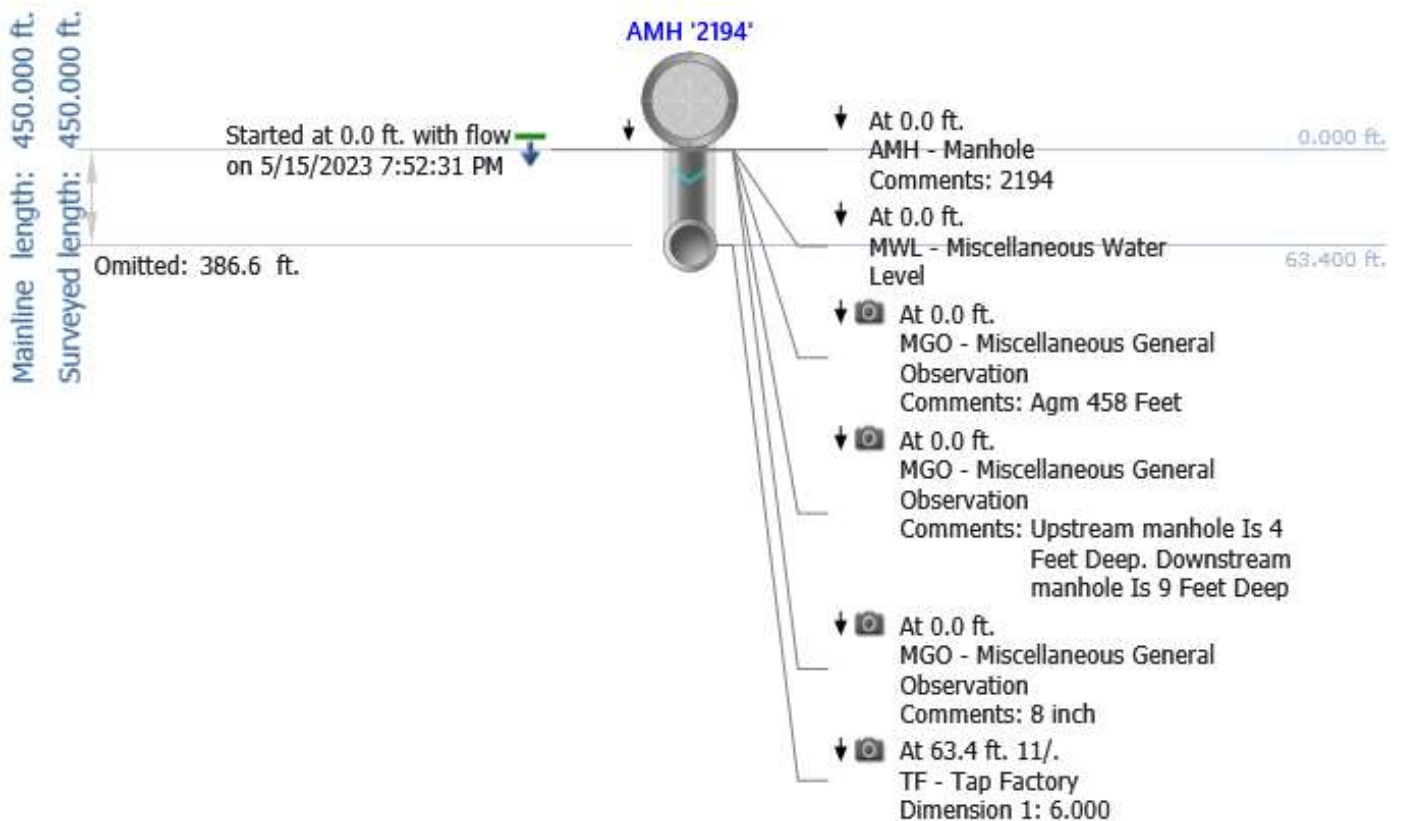

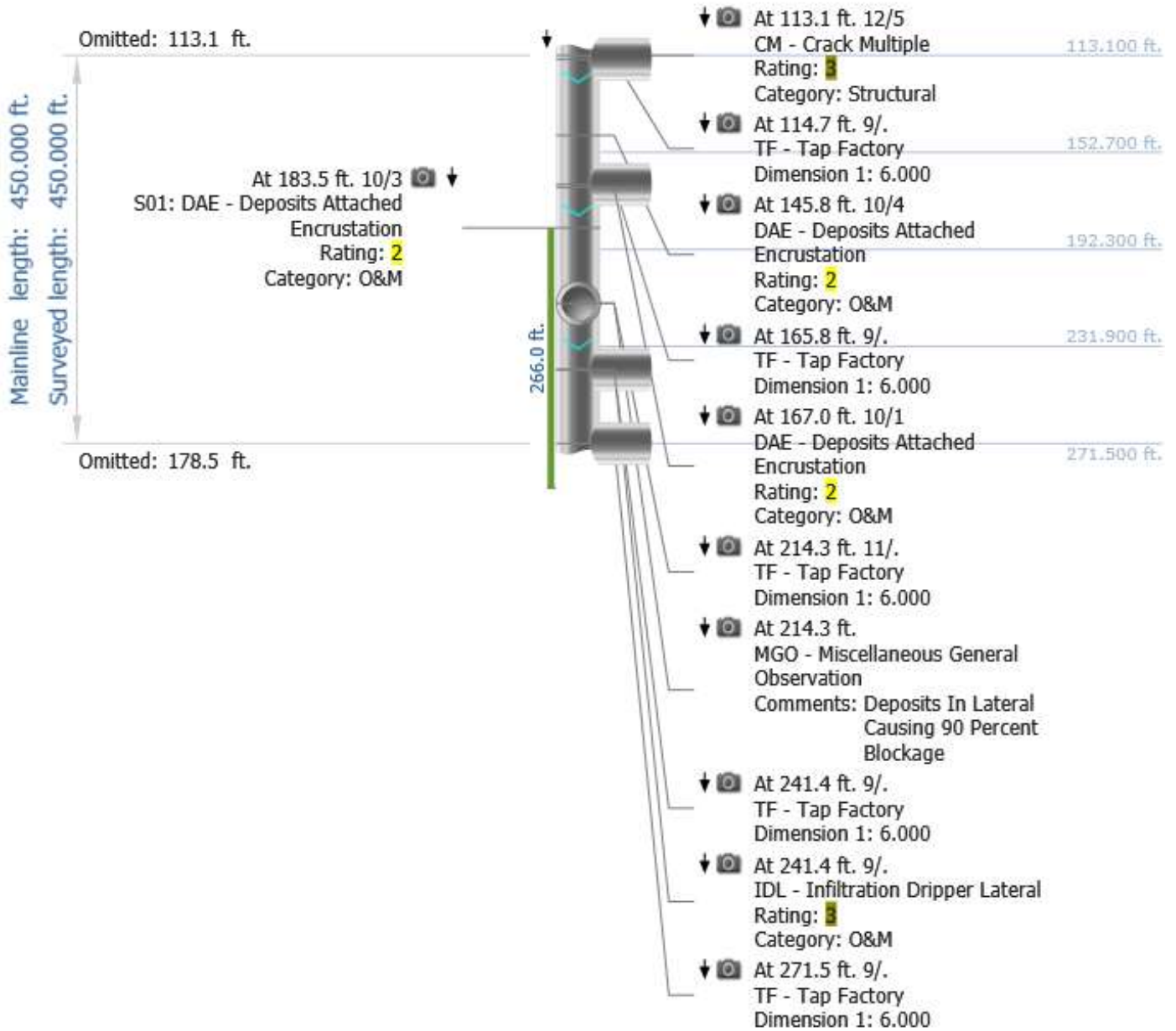

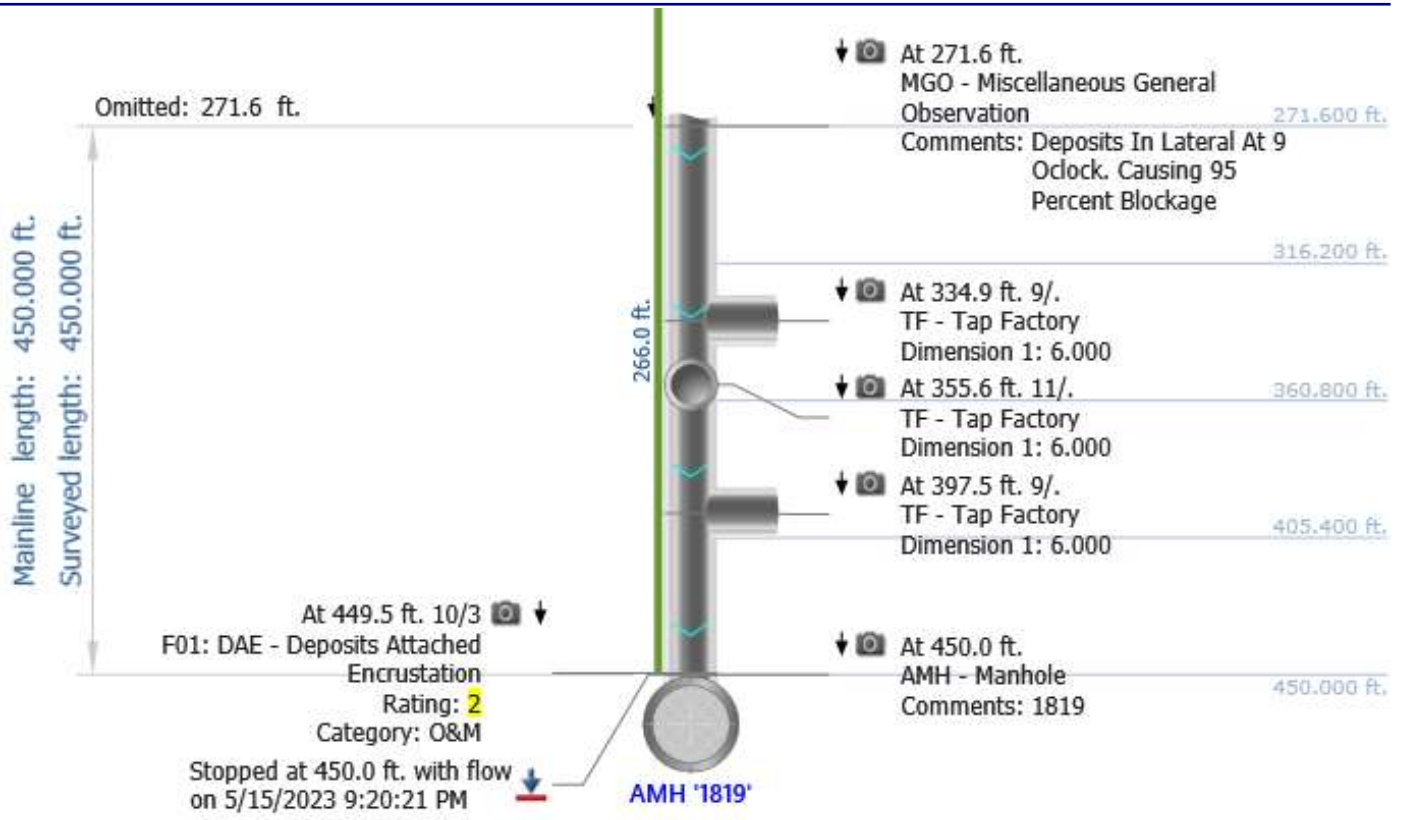



Vortex Services
521 Federal Road
Livermore, ME 04253
(207) 897-3348

Main Inspections Summary

Weston & Sampson - 2319762

Mainline ID	End date/time	Surveyed by	Start MH	Finish MH	Material	Height	Total length	Length
1818 - 1819	5/15/2023 10:28 PM	Mike Swilley	1818	1819	XXX	12 in.	50.000 ft.	50.000 ft.
Sub-Total							50.0 ft.	50.0 ft.
Total							50.0 ft.	50.0 ft.



Vortex Services
 521 Federal Road
 Livermore, ME 04253
 (207) 897-3348

Main Inspections Small Photos and Scoring

Mainline ID: 1818 - 1819	City: Georgetown, SC	Street: Hawkins St	Project name: Weston & Sampson - 2319762
Start date/time: 5/15/2023 9:55 PM	Total length: 50.000 ft.	Weather: 1	Surveyed by: Mike Swilley
Upstream MH No: 1818	Depth US: 10.000 ft.	Downstream MH No: 1819	Depth DS: 9.000 ft.
Shape: C	Material: XXX	Height: 12 in.	Width:
Additional info:			

Scores



Calculated at: **5/16/2023 3:13:23 PM**

Grade	Structural:				O&M:				Overall:	
	Segment Grade	Pipe Rating	Quick Rating	Pipe Rating Index	Segment Grade	Pipe Rating	Quick Rating	Pipe Rating Index	Pipe Rating	Pipe Rating Index
1	0	0	0000	0.0	0	0	0000	0.0	0	0.0
2	0				0					
3	0				0					
4	0				0					
5	0				0					

Observations

Distance	Dir.	Length	From/To	Code	Modifier	Rating	Remarks
0.0 ft.	D		/	AMH			1818
0.0 ft.	D		/	MWL			

Observations

Distance	Dir.	Length	From/To	Code	Modifier	Rating	Remarks
0.0 ft.	D		/	MGO			Agm 51 Feet
							
0.0 ft.	D		/	MGO			Upstream Manhole Is 10 Feet Deep. Downstream Manhole Is 9 Feet Deep
							
0.0 ft.	D		/	MGO			12 Inch
							

Observations

Distance	Dir.	Length	From/To	Code	Modifier	Rating	Remarks
50.0 ft.	D		/	AMH		1819	



Inspection's photos

Main Inspections Pipe Run and Scoring

Project name: Weston & Sampson - 2319762	Mainline ID: 1818 - 1819	City: Georgetown, SC	Street: Hawkins St
Start date/time: 5/15/2023 9:55 PM	Direction: D	Weather: 1	Location code: B
Shape: C	Material: XXX	Height: 12 in.	Width:

Scores

Calculated at: **5/16/2023 3:13:23 PM**

Grade	Structural:				O&M:				Overall:	
	Segment Grade	Pipe Rating	Quick Rating	Pipe Rating Index	Segment Grade	Pipe Rating	Quick Rating	Pipe Rating Index	Pipe Rating	Pipe Rating Index
1	0	0	0000	0.0	0	0	0000	0.0	0	0.0
2	0									
3	0									
4	0									
5	0									

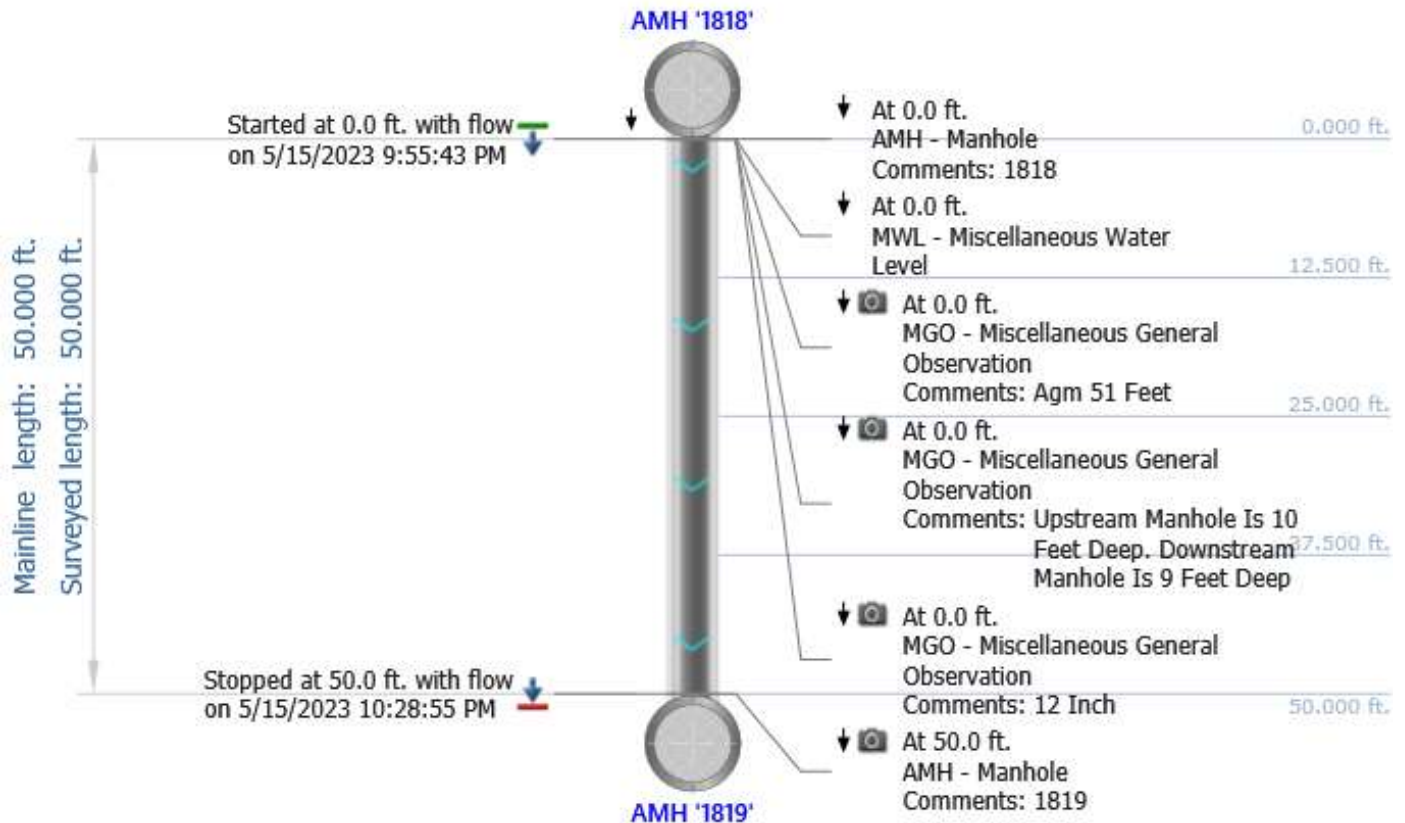



Vortex Services
521 Federal Road
Livermore, ME 04253
(207) 897-3348

Main Inspections Summary

Weston & Sampson - 2319762

Mainline ID	End date/time	Surveyed by	Start MH	Finish MH	Material	Height	Total length	Length	
1819 - 1835	5/15/2023 11:36 PM	Mike Swilley	1819	1835	CAS	12 in.	40.000 ft.	40.000 ft.	
							Sub-Total	40.0 ft.	40.0 ft.
							Total	40.0 ft.	40.0 ft.



Vortex Services
 521 Federal Road
 Livermore, ME 04253
 (207) 897-3348

Main Inspections Small Photos and Scoring

Mainline ID: 1819 - 1835	City: Georgetown, SC	Street: Hawkins St	Project name: Weston & Sampson - 2319762
Start date/time: 5/15/2023 10:30 PM	Total length: 40.000 ft.	Weather: 1	Surveyed by: Mike Swilley
Upstream MH No: 1819	Depth US: 9.000 ft.	Downstream MH No: 1835	Depth DS:
Shape: C	Material: CAS	Height: 12 in.	Width:
Additional info:			

Scores

Calculated at: **5/16/2023 3:14:26 PM**

Grade	Structural:				O&M:				Overall:	
	Segment Grade	Pipe Rating	Quick Rating	Pipe Rating Index	Segment Grade	Pipe Rating	Quick Rating	Pipe Rating Index	Pipe Rating	Pipe Rating Index
1	0	0	0000	0.0	0	0	0000	0.0	0	0.0
2	0				0					
3	0				0					
4	0				0					
5	0				0					

Observations

Distance	Dir.	Length	From/To	Code	Modifier	Rating	Remarks
0.0 ft.	D		/	AMH			1819
0.0 ft.	D		/	MWL			

Observations

Distance	Dir. Length	From/To Code	Modifier	Rating	Remarks
40.0 ft.	D	/ AMH		1835	



Inspection's photos

Main Inspections Pipe Run and Scoring

Project name:	Mainline ID:	City:	Street:
Weston & Sampson - 2319762	1819 - 1835	Georgetown, SC	Hawkins St
Start date/time:	Direction:	Weather:	Location code:
5/15/2023 10:30 PM	D	1	A
Shape:	Material:	Height:	Width:
C	CAS	12 in.	

Scores

Calculated at: **5/16/2023 3:14:26 PM**

Grade	Structural:				O&M:				Overall:	
	Segment Grade	Pipe Rating	Quick Rating	Pipe Rating Index	Segment Grade	Pipe Rating	Quick Rating	Pipe Rating Index	Pipe Rating	Pipe Rating Index
1	0	0	0000	0.0	0	0	0000	0.0	0	0.0
2	0									
3	0									
4	0									
5	0									

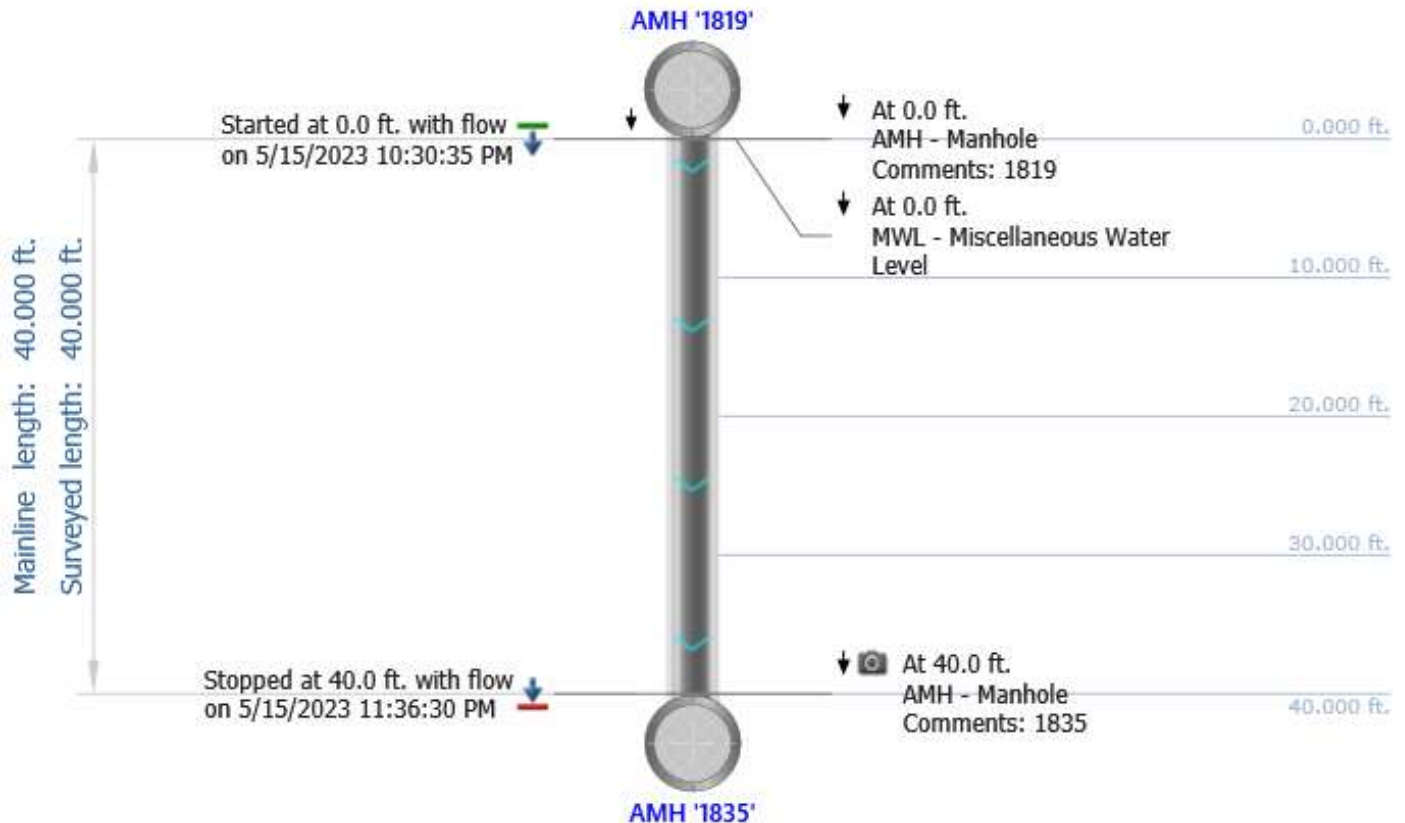



Vortex Services
521 Federal Road
Livermore, ME 04253
(207) 897-3348

Main Inspections Summary

Weston & Sampson - 2319762

Mainline ID	End date/time	Surveyed by	Start MH	Finish MH	Material	Height	Total length	Length
1835 - 1835A	5/16/2023 4:08 AM	Mike Swilley	1835	1835A	VCP	15 in.	61.000 ft.	61.000 ft.
Sub-Total							61.0 ft.	61.0 ft.
Total							61.0 ft.	61.0 ft.



Vortex Services
 521 Federal Road
 Livermore, ME 04253
 (207) 897-3348

Main Inspections Small Photos and Scoring

Mainline ID: 1835 - 1835A	City: Georgetown, SC	Street: Hawkins St	Project name: Weston & Sampson - 2319762
Start date/time: 5/16/2023 1:26 AM	Total length: 61.000 ft.	Weather: 1	Surveyed by: Mike Swilley
Upstream MH No: 1835	Depth US:	Downstream MH No: 1835A	Depth DS:
Shape: C	Material: VCP	Height: 15 in.	Width:
Additional info:			

Scores

Calculated at: **5/16/2023 3:15:34 PM**

Grade	Structural:				O&M:				Overall:	
	Segment Grade	Pipe Rating	Quick Rating	Pipe Rating Index	Segment Grade	Pipe Rating	Quick Rating	Pipe Rating Index	Pipe Rating	Pipe Rating Index
1	0	0	0000	0.0	0	0	0000	0.0	0	0.0
2	0				0					
3	0				0					
4	0				0					
5	0				0					

Observations

Distance	Dir.	Length	From/To	Code	Modifier	Rating	Remarks
0.0 ft.	D		/	AMH			1835
0.0 ft.	D		/	MWL			

Observations

Distance	Dir.	Length	From/To Code	Modifier	Rating	Remarks
61.0 ft.	D		/ AMH			1835A Buried Manhole



Inspection's photos

Main Inspections Pipe Run and Scoring

Project name:	Mainline ID:	City:	Street:
Weston & Sampson - 2319762	1835 - 1835A	Georgetown, SC	Hawkins St
Start date/time:	Direction:	Weather:	Location code:
5/16/2023 1:26 AM	D	1	A
Shape:	Material:	Height:	Width:
C	VCP	15 in.	

Scores

Calculated at: **5/16/2023 3:15:34 PM**

Grade	Structural:				O&M:				Overall:	
	Segment Grade	Pipe Rating	Quick Rating	Pipe Rating Index	Segment Grade	Pipe Rating	Quick Rating	Pipe Rating Index	Pipe Rating	Pipe Rating Index
1	0	0	0000	0.0	0	0	0000	0.0	0	0.0
2	0									
3	0									
4	0									
5	0									

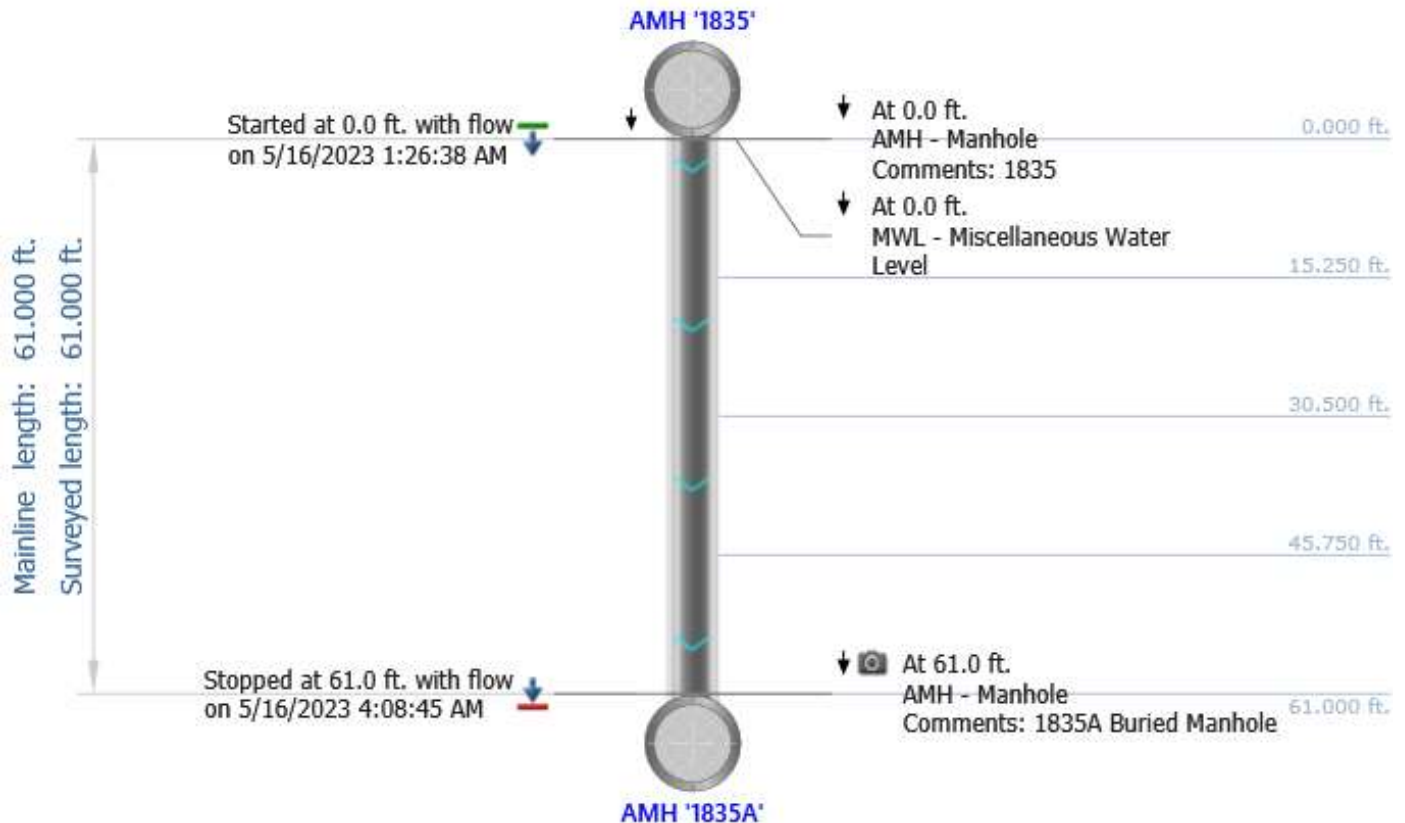



Vortex Services
521 Federal Road
Livermore, ME 04253
(207) 897-3348

Main Inspections Summary

Weston & Sampson - 2319762

Mainline ID	End date/time	Surveyed by	Start MH	Finish MH	Material	Height	Total length	Length
1835A - 1836	5/16/2023 4:53 AM	Mike Swilley	1835A	1836	VCP	15 in.	181.100 ft.	181.100 ft.
Sub-Total							181.1 ft.	181.1 ft.
Total							181.1 ft.	181.1 ft.



Vortex Services
 521 Federal Road
 Livermore, ME 04253
 (207) 897-3348

Main Inspections Small Photos and Scoring

Mainline ID: 1835A - 1836	City: Georgetown, SC	Street: Hwy 17	Project name: Weston & Sampson - 2319762
Start date/time: 5/16/2023 4:09 AM	Total length: 181.100 ft.	Weather: 1	Surveyed by: Mike Swilley
Upstream MH No: 1835A	Depth US:	Downstream MH No: 1836	Depth DS: 10.000 ft.
Shape: C	Material: VCP	Height: 15 in.	Width:
Additional info:			

Scores

Calculated at: **5/30/2023 11:49:36 AM**

Grade	Structural:				O&M:				Overall:	
	Segment Grade	Pipe Rating	Quick Rating	Pipe Rating Index	Segment Grade	Pipe Rating	Quick Rating	Pipe Rating Index	Pipe Rating	Pipe Rating Index
1	0	0	0000	0.0	0	0	0000	0.0	0	0.0
2	0				0					
3	0				0					
4	0				0					
5	0				0					

Observations

Distance	Dir.	Length	From/To	Code	Modifier	Rating	Remarks
0.0 ft.	D		/	AMH			1835A
0.0 ft.	D		/	MWL			

Observations

Distance	Dir.	Length	From/To	Code	Modifier	Rating	Remarks
181.1 ft.	D		/	AMH		1836	



Inspection's photos

Main Inspections Pipe Run and Scoring

Project name:	Mainline ID:	City:	Street:
Weston & Sampson - 2319762	1835A - 1836	Georgetown, SC	Hwy 17
Start date/time:	Direction:	Weather:	Location code:
5/16/2023 4:09 AM	D	1	A
Shape:	Material:	Height:	Width:
C	VCP	15 in.	

Scores

Calculated at: **5/30/2023 11:49:36 AM**

Grade	Structural:				O&M:				Overall:	
	Segment Grade	Pipe Rating	Quick Rating	Pipe Rating Index	Segment Grade	Pipe Rating	Quick Rating	Pipe Rating Index	Pipe Rating	Pipe Rating Index
1	0	0	0000	0.0	0	0	0000	0.0	0	0.0
2	0									
3	0									
4	0									
5	0									

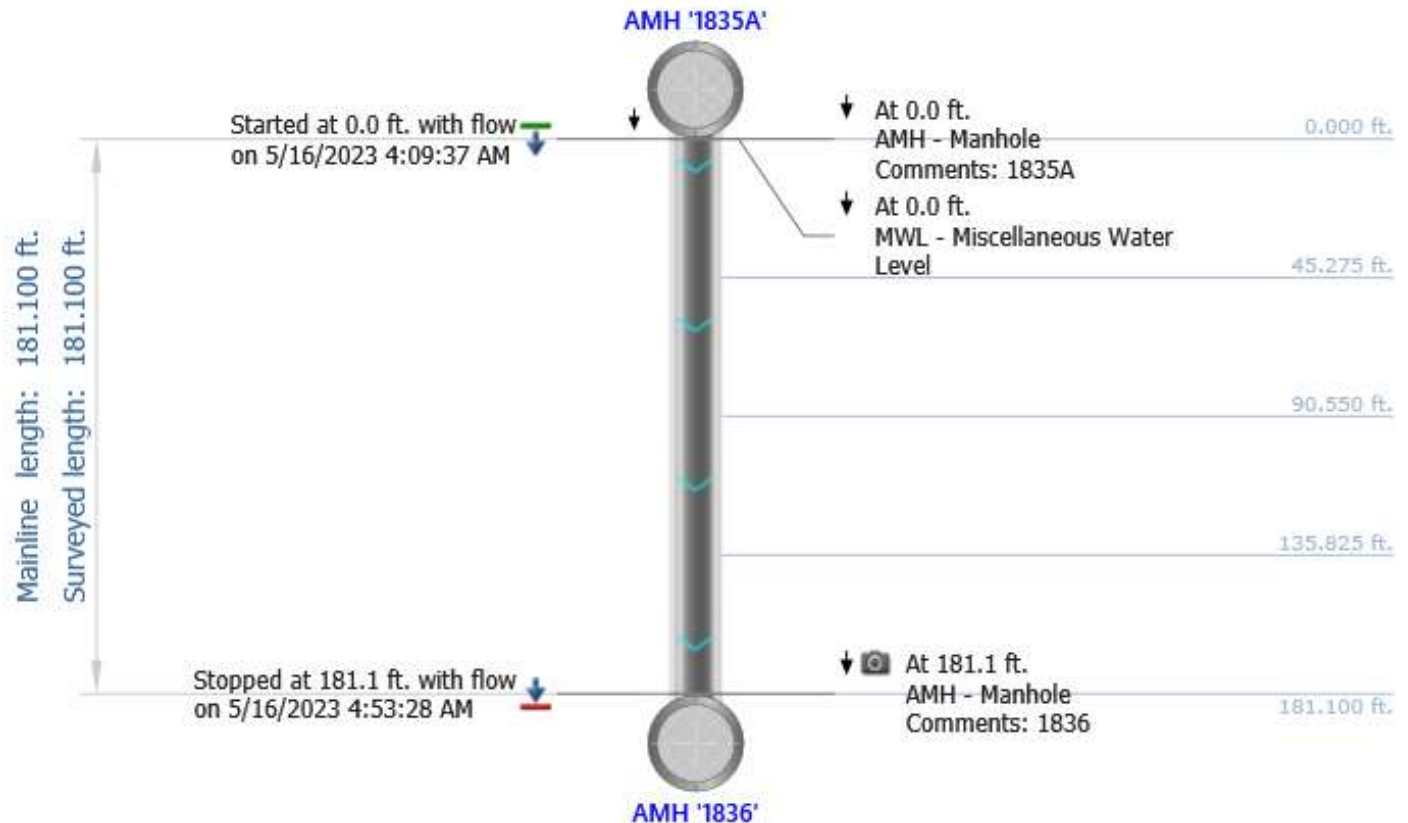



Vortex Services
521 Federal Road
Livermore, ME 04253
(207) 897-3348

Main Inspections Summary

Weston & Sampson - 2319762

Mainline ID	End date/time	Surveyed by	Start MH	Finish MH	Material	Height	Total length	Length
1836 - 1837	5/16/2023 5:35 AM	Mike Swilley	1836	1837	VCP	15 in.	378.000 ft.	378.000 ft.
Sub-Total							378.0 ft.	378.0 ft.
Total							378.0 ft.	378.0 ft.



Vortex Services
 521 Federal Road
 Livermore, ME 04253
 (207) 897-3348

Main Inspections Small Photos and Scoring

Mainline ID: 1836 - 1837	City: Georgetown, SC	Street: Hwy 17	Project name: Weston & Sampson - 2319762
Start date/time: 5/16/2023 4:54 AM	Total length: 378.000 ft.	Weather: 1	Surveyed by: Mike Swilley
Upstream MH No: 1836	Depth US: 10.000 ft.	Downstream MH No: 1837	Depth DS: 10.000 ft.
Shape: C	Material: VCP	Height: 15 in.	Width:
Additional info:			

Scores

Calculated at: **5/30/2023 11:49:19 AM**

Grade	Structural:				O&M:				Overall:	
	Segment Grade	Pipe Rating	Quick Rating	Pipe Rating Index	Segment Grade	Pipe Rating	Quick Rating	Pipe Rating Index	Pipe Rating	Pipe Rating Index
1	0	0	0000	0.0	0	0	0000	0.0	0	0.0
2	0				0					
3	0				0					
4	0				0					
5	0				0					

Observations

Distance	Dir.	Length	From/To	Code	Modifier	Rating	Remarks
0.0 ft.	D		/	AMH			1836
0.0 ft.	D		/	MWL			

Observations

Distance	Dir. Length	From/To Code	Modifier	Rating	Remarks
0.0 ft.	D	/	MGO		Agm 372 Feet



378.0 ft.	D	/	AMH		1837
-----------	---	---	-----	--	------



Inspection's photos

Main Inspections Pipe Run and Scoring

Project name:	Mainline ID:	City:	Street:
Weston & Sampson - 2319762	1836 - 1837	Georgetown, SC	Hwy 17
Start date/time:	Direction:	Weather:	Location code:
5/16/2023 4:54 AM	D	1	A
Shape:	Material:	Height:	Width:
C	VCP	15 in.	

Scores

Calculated at: **5/30/2023 11:49:19 AM**

Grade	Structural:				O&M:				Overall:	
	Segment Grade	Pipe Rating	Quick Rating	Pipe Rating Index	Segment Grade	Pipe Rating	Quick Rating	Pipe Rating Index	Pipe Rating	Pipe Rating Index
1	0	0	0000	0.0	0	0	0000	0.0	0	0.0
2	0									
3	0									
4	0									
5	0									

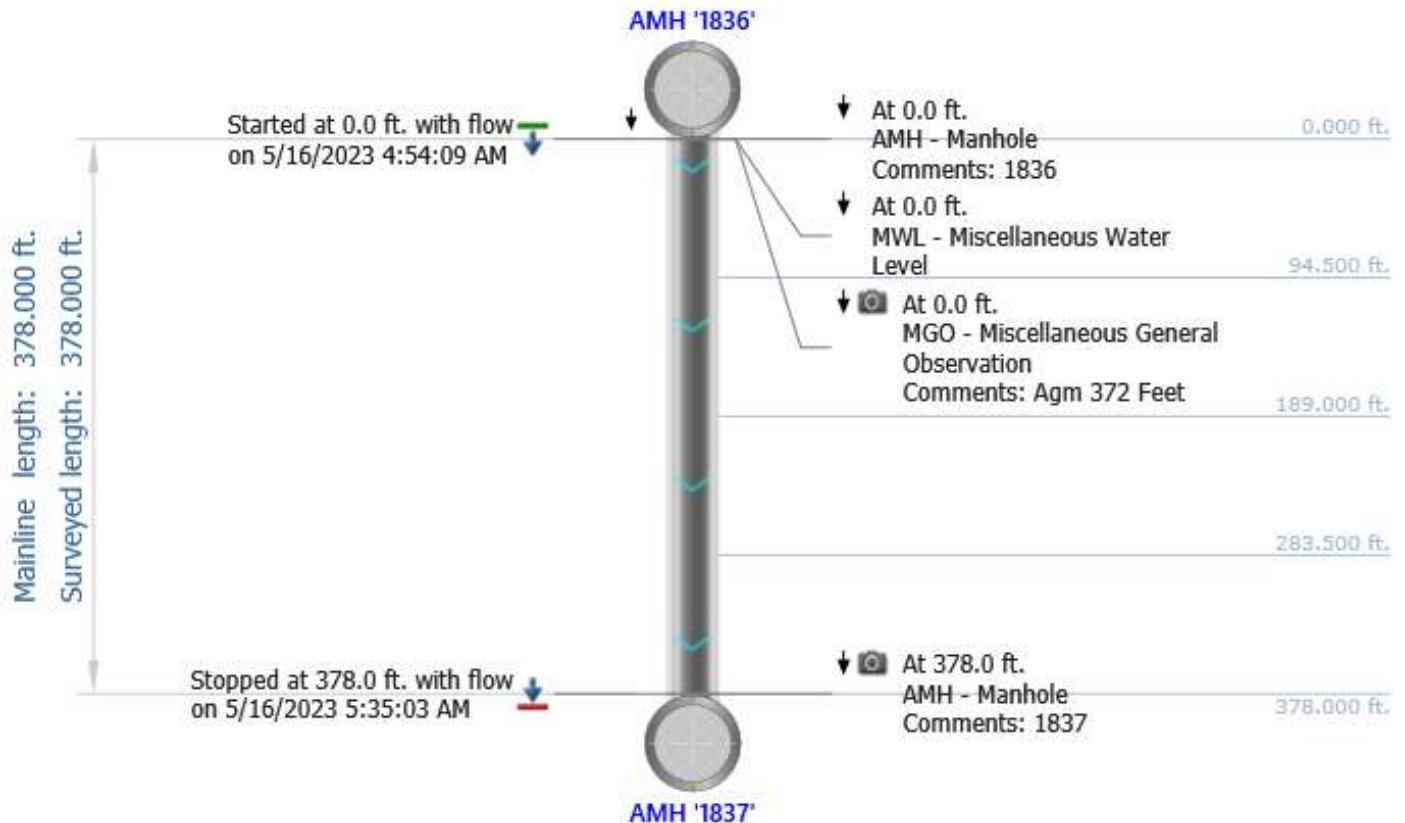



Vortex Services
521 Federal Road
Livermore, ME 04253
(207) 897-3348

Main Inspections Summary

Weston & Sampson - 2319762

Mainline ID	End date/time	Surveyed by	Start MH	Finish MH	Material	Height	Total length	Length	
1837 - 1838	5/16/2023 10:45 PM	Mike Swilley	1837	1838	VCP	15 in.	400.000 ft.	400.000 ft.	
							Sub-Total	400.0 ft.	400.0 ft.
							Total	400.0 ft.	400.0 ft.



Vortex Services
 521 Federal Road
 Livermore, ME 04253
 (207) 897-3348

Main Inspections Small Photos and Scoring

Mainline ID: 1837 - 1838	City: Georgetown, SC	Street: Hwy 17	Project name: Weston & Sampson - 2319762
Start date/time: 5/16/2023 7:17 PM	Total length: 400.000 ft.	Weather: 1	Surveyed by: Mike Swilley
Upstream MH No: 1837	Depth US: 10.000 ft.	Downstream MH No: 1838	Depth DS: 10.000 ft.
Shape: C	Material: VCP	Height: 15 in.	Width:

Additional info:

Scores



Calculated at: **5/30/2023 11:49:03 AM**

Grade	Structural:				O&M:				Overall:	
	Segment Grade	Pipe Rating	Quick Rating	Pipe Rating Index	Segment Grade	Pipe Rating	Quick Rating	Pipe Rating Index	Pipe Rating	Pipe Rating Index
1	0	0	0000	0.0	0	0	0000	0.0	0	0.0
2	0				0					
3	0				0					
4	0				0					
5	0				0					

Observations

Distance	Dir.	Length	From/To	Code	Modifier	Rating	Remarks
0.0 ft.	D		/	AMH			1837
0.0 ft.	D		/	MWL			

Observations

Distance	Dir. Length	From/To Code	Modifier	Rating	Remarks
0.0 ft.	D	/	MGO		Agm 402 Feet
					
0.0 ft.	D	/	MGO		Both Manholes Are 10 Feet Deep
					
0.0 ft.	D	/	MGO		Full Pipe Flow Coming From Paper Mill Possibly. Have To Wait Until Flow Slows Down To Tv
					

Observations

Distance	Dir.	Length	From/To	Code	Modifier	Rating	Remarks
0.0 ft.	D		/	MGO			15 Inch

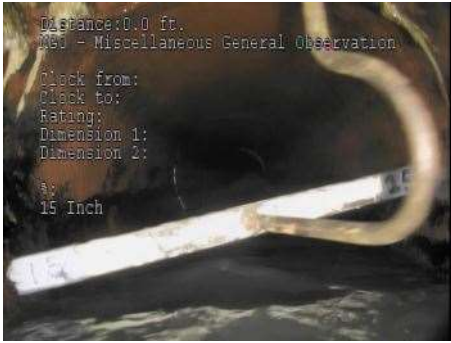

400.0 ft.	D		/	AMH			1838
-----------	---	--	---	-----	--	--	------



Inspection's photos

Main Inspections Pipe Run and Scoring

Project name:	Mainline ID:	City:	Street:
Weston & Sampson - 2319762	1837 - 1838	Georgetown, SC	Hwy 17
Start date/time:	Direction:	Weather:	Location code:
5/16/2023 7:17 PM	D	1	A
Shape:	Material:	Height:	Width:
C	VCP	15 in.	

Scores

Calculated at: **5/30/2023 11:49:03 AM**

Grade	Structural:				O&M:				Overall:	
	Segment Grade	Pipe Rating	Quick Rating	Pipe Rating Index	Segment Grade	Pipe Rating	Quick Rating	Pipe Rating Index	Pipe Rating	Pipe Rating Index
1	0	0	0000	0.0	0	0	0000	0.0	0	0.0
2	0									
3	0									
4	0									
5	0									

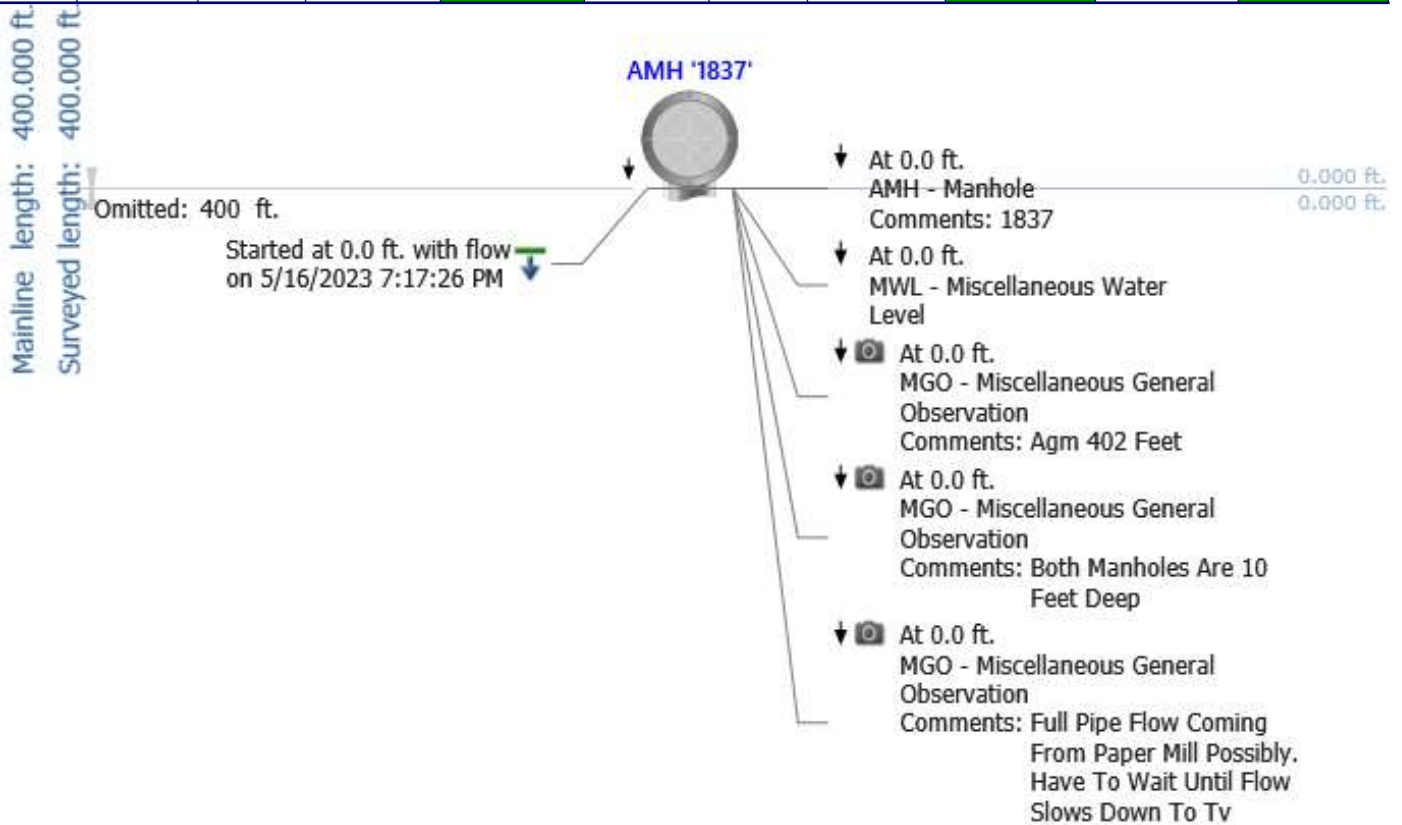

Project name:
**Weston & Sampson -
2319762**

Mainline ID:
1837 - 1838

Start date/time:
5/16/2023 7:17 PM

Direction:
D

Weather:
1

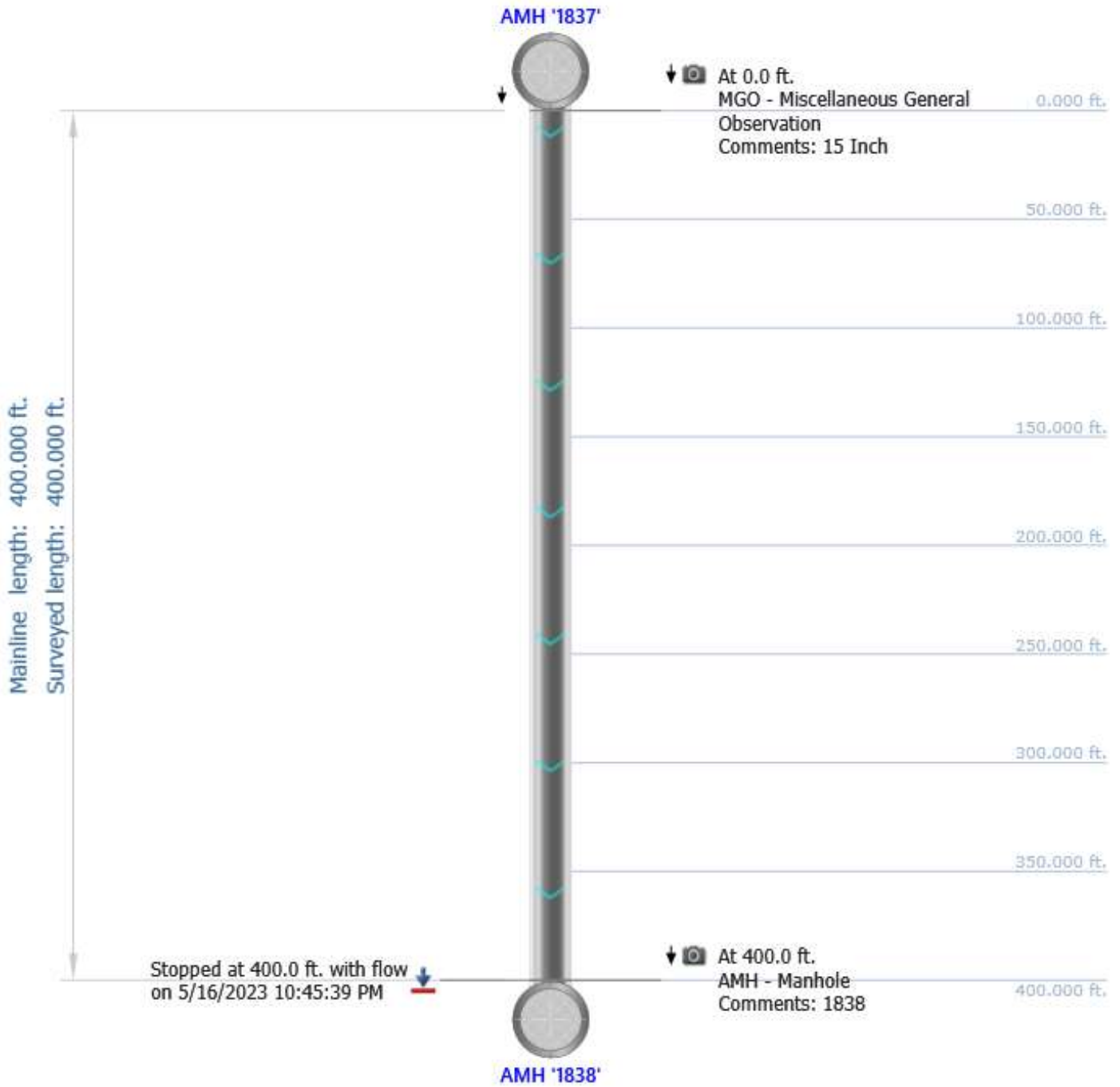



Defect Listing

Pipe Segment Reference 1838_1823	City GEORGETOWN	Street FRASER ST.	Material Vitrified Clay Pipe	Location Code <small>Primary major arterial roads, interstates, numbered rds</small>	Pipe Use Sanitary Sewage Pipe
Upstream MH 1823	Total Length	Year Constructed	Shape Circular	Location Details	
Downstream MH 1838	Length surveyed 30	Year Renewed	Height 8	Width	Pipe Joint Length

SPR 33	MPR 10	PO Number	Customer VORTEX COMPANIES
SPRI 3	MPRI 3.3	Work Order Number	Purpose Maintenance Related
QSR 5138	QMR 4221		Media label
OPR 43	Surveyed By Eddie Newman	Direction Upstream	Date 08/09/2023
OPRI 3.1	Certificate Number U-1018-0703003236	Pre-Cleaning No Pre-Cleaning	Time 21:39
Date Cleaned			End Time 23:03
			Weather
			Additional Info

Distance	Condition	Cont. Dfct.	Values			Joint	Clock Position		Grade
			1st	2nd	%		At/From	To	
0	Access Point Manhole					<input type="checkbox"/>			
Remarks: 1838									
0	Miscellaneous Water Level				10	<input type="checkbox"/>			
5.5	Miscellaneous Water Level Sag				5	<input type="checkbox"/>			2
Remarks: JOINT OFFSET CAUSING SAG									
5.6	Joint Offset Medium					<input type="checkbox"/>			3
Remarks: JOINT HAS OFFSET									
7.8	Miscellaneous Water Level				5	<input type="checkbox"/>			
10.5	Joint Separated Medium					<input type="checkbox"/>			3
Remarks: SEPERATED AT JOINT									
10.5	Miscellaneous Material Change					<input type="checkbox"/>			
Remarks: DUCTILE IRON PIPE STARTS HERE									
11.3	Lining Feature Delaminating	S01				<input checked="" type="checkbox"/>	12	12	3
Remarks: INNER LINER MISSING FROM PIPE WALL									
20.3	Miscellaneous General Observation					<input type="checkbox"/>			
Remarks: APPEARS TO BE BELL AT JOINT AT THE DUCTILE IRON PIPE									
20.3	Miscellaneous Material Change					<input type="checkbox"/>			
Remarks: VITRIFIED CLAY PIPE STARTS AGAIN									
21.6	Crack Multiple					<input type="checkbox"/>	3	6	3
Remarks: CRACK BEFORE JOINT SPLITS									
22.5	Miscellaneous Water Level				25	<input type="checkbox"/>			
Remarks: WATER LEVEL CHANGE AT MMC									
22.5	Joint Offset Medium					<input type="checkbox"/>			3
Remarks: JOINT IS OFFSET AT BREAK									
22.7	Broken Pipe Soil Visible					<input checked="" type="checkbox"/>	1		5
Remarks: PIPE BROKEN AT JOINT WITH SOIL									
22.7	Crack Longitudinal					<input type="checkbox"/>	1		2
Remarks: SMALL CRACK IN PIPE									
24	Tap Break-in/Hammer		4			<input type="checkbox"/>	3		
Remarks: LATERAL WITH GASKET SHOWING									
24	Miscellaneous Camera Underwater					<input type="checkbox"/>			4
Remarks: CAMERA UNDERWATER									
24	Miscellaneous Water Level				50	<input type="checkbox"/>			
Remarks: WATER LEVEL ABOVE CAMERA									
25.5	Miscellaneous General Observation					<input type="checkbox"/>			Page: 1 of 11
Remarks: CAMERA OUT OF WATER									
25.5	Miscellaneous Water Level				45	<input type="checkbox"/>			



Defect Listing

Pipe Segment Reference	City	Street	Material	Location Code	Pipe Use
1838_1823	GEORGETOWN	FRASER ST.	Vitrified Clay Pipe	<small>Primary major arterial roads, interstates, numbered rds</small>	Sanitary Sewage Pipe
Upstream MH 1823	Total Length	Year Constructed	Shape Circular	Location Details	
Downstream MH 1838	Length surveyed 30	Year Renewed	Height 8	Width	Pipe Joint Length
27	Miscellaneous Water Level		50	<input type="checkbox"/>	
27.8	Fracture Circumferential			<input checked="" type="checkbox"/>	3 8 2
Remarks: FRACTURED AT JOINT					
29.1	Miscellaneous Camera Underwater			<input type="checkbox"/>	4
Remarks: CAMERA UNDERWATER BEFORE MH					
30	Lining Feature Delaminating	F01		<input checked="" type="checkbox"/>	12 12 3
Remarks: INNER LINER MISSING FROM PIPE WALL					
30	Access Point Manhole			<input type="checkbox"/>	
Remarks: 1823					



Defect Listing Plot

Pipe Segment Reference 1838_1823	City GEORGETOWN	Street FRASER ST.	Material Vitrified Clay Pipe	Location Code <small>Primary major arterial roads, interstates, numbered rd</small>	Pipe Use Sanitary Sewage Pipe
Upstream MH 1823	Total Length	Year Constructed	Shape Circular	Location Details	
Downstream MH 1838	Length surveyed 30	Year Renewed	Height 8	Width	Pipe Joint Length

SPR 33	MPR 10	PO Number		Customer VORTEX COMPANIES	
SPRI 3	MPRI 3.3	Work Order Number		Purpose Maintenance Related	
QSR 5138	QMR 4221				
OPR 43	Surveyed By Eddie Newman	Direction Upstream	Date 08/09/2023	Media label	
OPRI 3.1	Certificate Number U-1018-0703003236	Pre-Cleaning No Pre-Cleaning	Time 21:39	Weather	
Date Cleaned			End Time 23:03	Additional Info	

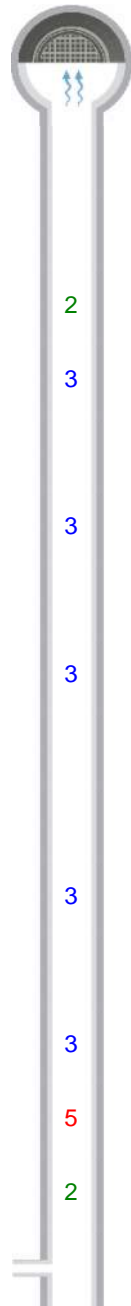

0 ft.	Access Point Manhole		1838
0 ft.	Miscellaneous Water Level		
5.5 ft.	Miscellaneous Water Level Sag	2	JOINT OFFSET CAUSING SAG
5.6 ft.	Joint Offset Medium	3	JOINT HAS OFFSET
7.8 ft.	Miscellaneous Water Level		
10.5 ft.	Joint Separated Medium	3	SEPERATED AT JOINT
10.5 ft.	Miscellaneous Material Change		DUCTILE IRON PIPE STARTS HERE
11.3 ft.	Lining Feature Delaminating - S01	3	INNER LINER MISSING FROM PIPE WALL
20.3 ft.	Miscellaneous General Observation		APPEARS TO BE BELL AT JOINT AT THE DUCTILE IRON PIPE
20.3 ft.	Miscellaneous Material Change		VITRIFIED CLAY PIPE STARTS AGAIN
21.6 ft.	Crack Multiple	3	CRACK BEFORE JOINT SPLITS
22.5 ft.	Miscellaneous Water Level		WATER LEVEL CHANGE AT MMC
22.5 ft.	Joint Offset Medium	3	JOINT IS OFFSET AT BREAK
22.7 ft.	Broken Pipe Soil Visible	5	PIPE BROKEN AT JOINT WITH SOIL
22.7 ft.	Crack Longitudinal	2	SMALL CRACK IN PIPE
24 ft.	Tap Break-in/Hammer		LATERAL WITH GASKET SHOWING



Defect Listing Plot

Pipe Segment Reference 1838_1823	City GEORGETOWN	Street FRASER ST.	Material Vitrified Clay Pipe		Location Code <small>Primary major arterial roads, interstates, numbered rd</small>	Pipe Use Sanitary Sewage Pipe
Upstream MH 1823	Total Length	Year Constructed	Shape Circular		Location Details	
Downstream MH 1838	Length surveyed 30	Year Renewed	Height 8	Width	Pipe Joint Length	

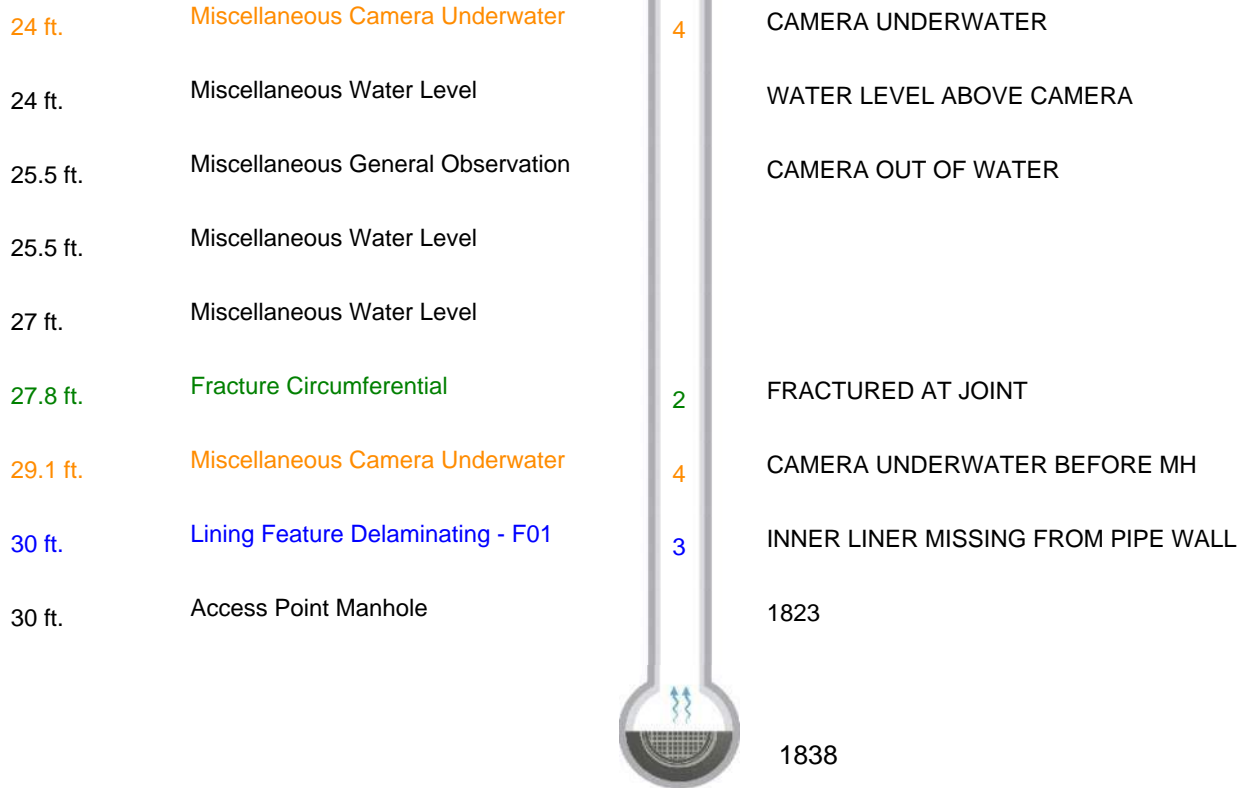



4 Image Report

Pipe Segment Reference 1838_1823	City GEORGETOWN	Street FRASER ST.	Material Vitrified Clay Pipe	Location Code <small>Primary major arterial roads, interstates, numbered rds</small>	Pipe Use Sanitary Sewage Pipe
Upstream MH 1823	Total Length	Year Constructed	Shape Circular	Location Details	
Downstream MH 1838	Length surveyed 30	Year Renewed	Height 8	Width	Pipe Joint Length



Distance: 0.0 ft. Grade: 0
 Condition: Access Point Manhole
 Remarks: 1838



Distance: 0.0 ft. Grade: 0
 Condition: Miscellaneous Water Level
 Remarks: N/A



Distance: 5.6 ft. Grade: 3
 Condition: Joint Offset Medium
 Remarks: JOINT HAS OFFSET



Distance: 7.8 ft. Grade: 0
 Condition: Miscellaneous Water Level
 Remarks: N/A



4 Image Report

Pipe Segment Reference 1838_1823	City GEORGETOWN	Street FRASER ST.	Material Vitrified Clay Pipe	Location Code <small>Primary major arterial roads, interstates, numbered rds</small>	Pipe Use Sanitary Sewage Pipe
Upstream MH 1823	Total Length	Year Constructed	Shape Circular	Location Details	
Downstream MH 1838	Length surveyed 30	Year Renewed	Height 8	Width	Pipe Joint Length



Distance: 5.5 ft. **Grade:** 2
Condition: Miscellaneous Water Level Sag
Remarks: JOINT OFFSET CAUSING SAG



Distance: 10.5 ft. **Grade:** 3
Condition: Joint Separated Medium
Remarks: SEPERATED AT JOINT



Distance: 10.5 ft. **Grade:** 0
Condition: Miscellaneous Material Change
Remarks: DUCTILE IRON PIPE STARTS HERE

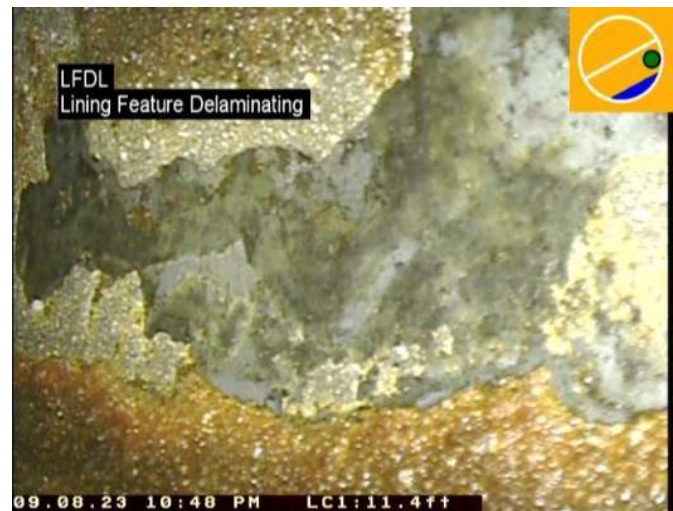

Distance: 11.3 ft. **Grade:** 3
Condition: Lining Feature Delaminating
Remarks: INNER LINER MISSING FROM PIPE WALL



4 Image Report

Pipe Segment Reference 1838_1823	City GEORGETOWN	Street FRASER ST.	Material Vitrified Clay Pipe	Location Code <small>Primary major arterial roads, interstates, numbered roads</small>	Pipe Use Sanitary Sewage Pipe
Upstream MH 1823	Total Length	Year Constructed	Shape Circular	Location Details	
Downstream MH 1838	Length surveyed 30	Year Renewed	Height 8	Width	Pipe Joint Length

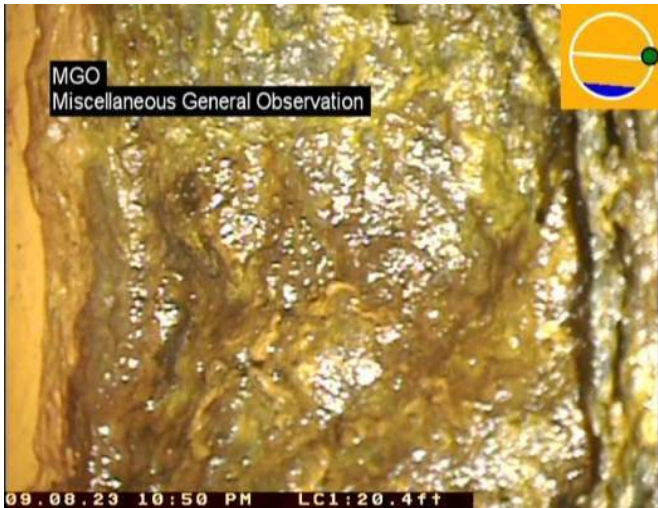

Distance: 20.3 ft. Grade: 0
 Condition: Miscellaneous General Observation
 Remarks: APPEARS TO BE BELL AT JOINT AT THE DUCTILE IRON PIPE



Distance: 20.3 ft. Grade: 0
 Condition: Miscellaneous General Observation
 Remarks: APPEARS TO BE BELL AT JOINT AT THE DUCTILE IRON PIPE



Distance: 20.3 ft. Grade: 0
 Condition: Miscellaneous Material Change
 Remarks: VITRIFIED CLAY PIPE STARTS AGAIN



Distance: 22.5 ft. Grade: 0
 Condition: Miscellaneous Water Level
 Remarks: WATER LEVEL CHANGE AT MMC



4 Image Report

Pipe Segment Reference 1838_1823	City GEORGETOWN	Street FRASER ST.	Material Vitrified Clay Pipe	Location Code <small>Primary major arterial roads, interstates, numbered rds</small>	Pipe Use Sanitary Sewage Pipe
Upstream MH 1823	Total Length	Year Constructed	Shape Circular	Location Details	
Downstream MH 1838	Length surveyed 30	Year Renewed	Height 8	Width	Pipe Joint Length



Distance: 21.6 ft. Grade: 3
 Condition: Crack Multiple
 Remarks: CRACK BEFORE JOINT SPLITS



Distance: 22.7 ft. Grade: 5
 Condition: Broken Pipe Soil Visible
 Remarks: PIPE BROKEN AT JOINT WITH SOIL



Distance: 22.5 ft. Grade: 3
 Condition: Joint Offset Medium
 Remarks: JOINT IS OFFSET AT BREAK



Distance: 22.7 ft. Grade: 2
 Condition: Crack Longitudinal
 Remarks: SMALL CRACK IN PIPE



4 Image Report

Pipe Segment Reference 1838_1823	City GEORGETOWN	Street FRASER ST.	Material Vitrified Clay Pipe	Location Code <small>Primary major arterial roads, interstates, numbered rds</small>	Pipe Use Sanitary Sewage Pipe
Upstream MH 1823	Total Length	Year Constructed	Shape Circular	Location Details	
Downstream MH 1838	Length surveyed 30	Year Renewed	Height 8	Width	Pipe Joint Length



Distance: 24.0 ft. Grade: 0
 Condition: Tap Break-in/Hammer
 Remarks: LATERAL WITH GASKET SHOWING



Distance: 24.0 ft. Grade: 4
 Condition: Miscellaneous Camera Underwater
 Remarks: CAMERA UNDERWATER

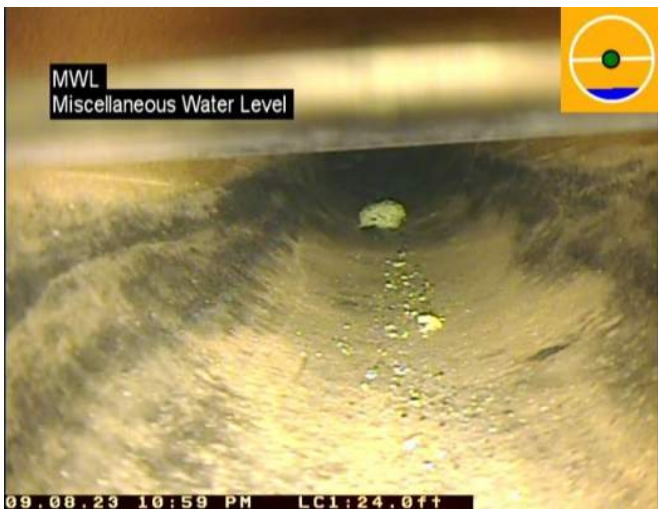

Distance: 24.0 ft. Grade: 0
 Condition: Miscellaneous Water Level
 Remarks: WATER LEVEL ABOVE CAMERA

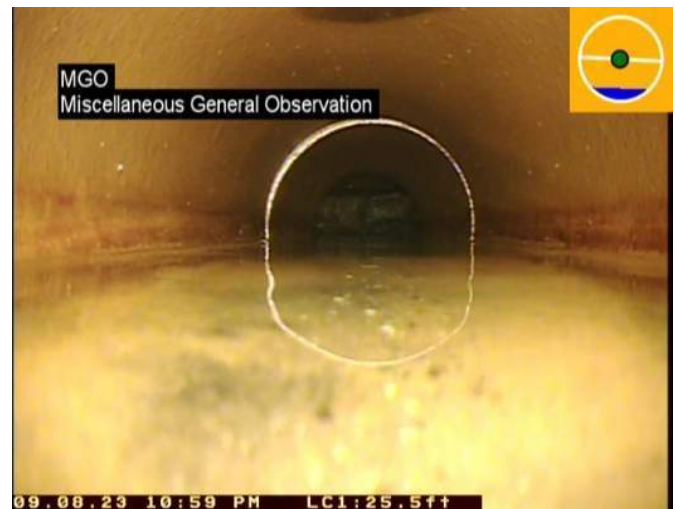

Distance: 25.5 ft. Grade: 0
 Condition: Miscellaneous General Observation
 Remarks: CAMERA OUT OF WATER



4 Image Report

Pipe Segment Reference 1838_1823	City GEORGETOWN	Street FRASER ST.	Material Vitrified Clay Pipe	Location Code <small>Primary major arterial roads, interstates, numbered roads</small>	Pipe Use Sanitary Sewage Pipe
Upstream MH 1823	Total Length	Year Constructed	Shape Circular	Location Details	
Downstream MH 1838	Length surveyed 30	Year Renewed	Height 8	Width	Pipe Joint Length

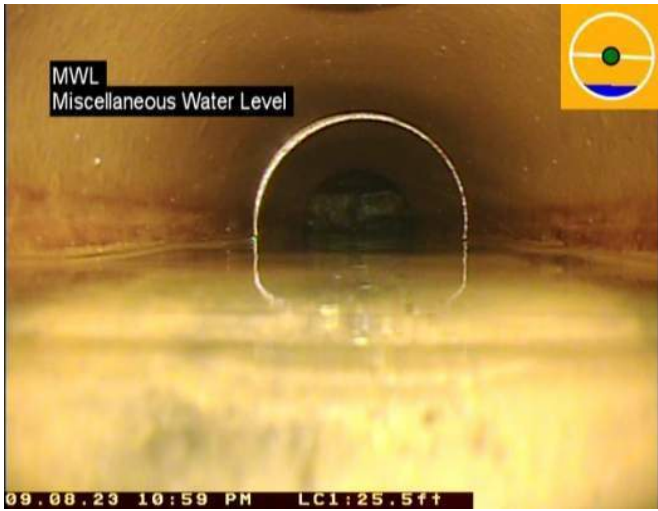

Distance: 25.5 ft. Grade: 0
 Condition: Miscellaneous Water Level
 Remarks: N/A

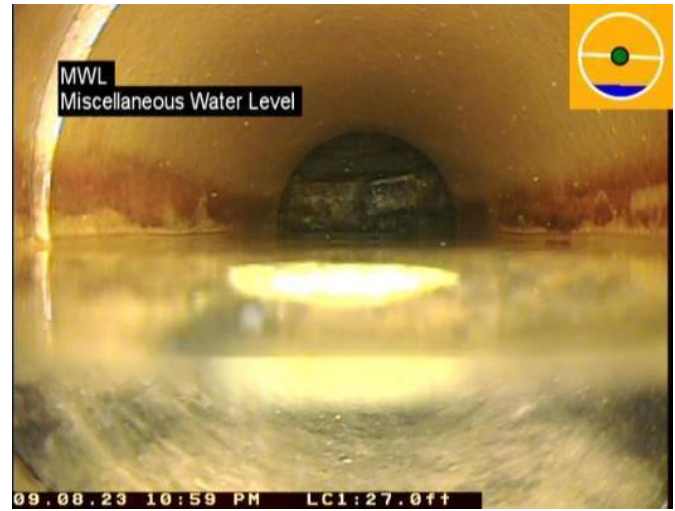

Distance: 27.0 ft. Grade: 0
 Condition: Miscellaneous Water Level
 Remarks: N/A



Distance: 27.8 ft. Grade: 2
 Condition: Fracture Circumferential
 Remarks: FRACTURED AT JOINT



Distance: 29.1 ft. Grade: 4
 Condition: Miscellaneous Camera Underwater
 Remarks: CAMERA UNDERWATER BEFORE MH



4 Image Report

Pipe Segment Reference 1838_1823	City GEORGETOWN	Street FRASER ST.	Material Vitrified Clay Pipe	Location Code <small>Primary major arterial roads, interstates, numbered rds</small>	Pipe Use Sanitary Sewage Pipe
Upstream MH 1823	Total Length	Year Constructed	Shape Circular	Location Details	
Downstream MH 1838	Length surveyed 30	Year Renewed	Height 8	Width	Pipe Joint Length



Distance: 30.0 ft. **Grade:** 3
Condition: Lining Feature Delaminating
Remarks: INNER LINER MISSING FROM PIPE WALL



Distance: 30.0 ft. **Grade:** 0
Condition: Access Point Manhole
Remarks: 1823



Vortex Services
521 Federal Road
Livermore, ME 04253
(207) 897-3348

Main Inspections Summary

Weston & Sampson - 2319762

Mainline ID	End date/time	Surveyed by	Start MH	Finish MH	Material	Height	Total length	Length
1838 - 1839	5/17/2023 1:37 AM	Mike Swilley	1838	1839	VCP	15 in.	400.000 ft.	400.000 ft.
Sub-Total							400.0 ft.	400.0 ft.
Total							400.0 ft.	400.0 ft.



Vortex Services
 521 Federal Road
 Livermore, ME 04253
 (207) 897-3348

Main Inspections Small Photos and Scoring

Mainline ID: 1838 - 1839	City: Georgetown, SC	Street: Hwy 17	Project name: Weston & Sampson - 2319762
Start date/time: 5/16/2023 11:17 PM	Total length: 400.000 ft.	Weather: 1	Surveyed by: Mike Swilley
Upstream MH No: 1838	Depth US: 10.000 ft.	Downstream MH No: 1839	Depth DS: 10.000 ft.
Shape: C	Material: VCP	Height: 15 in.	Width:
Additional info:			

Scores

Calculated at: **5/30/2023 11:48:45 AM**

Grade	Structural:				O&M:				Overall:	
	Segment Grade	Pipe Rating	Quick Rating	Pipe Rating Index	Segment Grade	Pipe Rating	Quick Rating	Pipe Rating Index	Pipe Rating	Pipe Rating Index
1	0	3	3100	3.0	0	0	0000	0.0	3	3.0
2	0				0					
3	3				0					
4	0				0					
5	0				0					

Observations

Distance	Dir.	Length	From/To	Code	Modifier	Rating	Remarks
0.0 ft.	D		/	AMH			1838
0.0 ft.	D		/	MWL			

Observations

Distance	Dir. Length	From/To Code	Modifier	Rating	Remarks
----------	-------------	--------------	----------	--------	---------

0.0 ft.	D	/	MGO		Agm 404 Feet
----------------	----------	----------	------------	--	---------------------

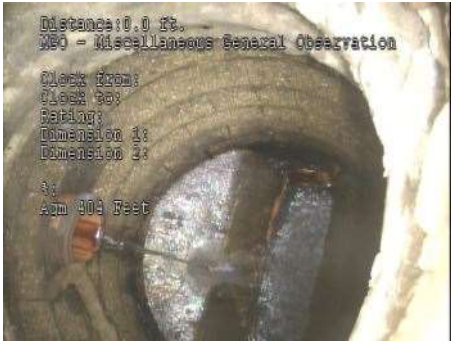

0.0 ft.	D	/	MGO		Both Manholes Are 10 Feet Deep
----------------	----------	----------	------------	--	---------------------------------------



6.0 ft.	D	/	MGO		15 Inch
----------------	----------	----------	------------	--	----------------



Observations

Distance	Dir. Length	From/To Code	Modifier	Rating	Remarks
----------	-------------	--------------	----------	--------	---------

309.9 ft.	D	10 / 2 CM		3	
-----------	---	-----------	--	----------	--

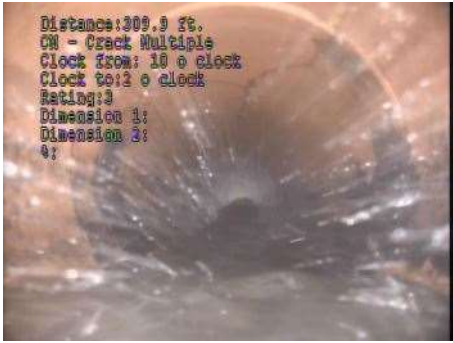

400.0 ft.	D	/ AMH			1839
-----------	---	-------	--	--	------



Inspection's photos

Main Inspections Pipe Run and Scoring

Project name:	Mainline ID:	City:	Street:
Weston & Sampson - 2319762	1838 - 1839	Georgetown, SC	Hwy 17
Start date/time:	Direction:	Weather:	Location code:
5/16/2023 11:17 PM	D	1	A
Shape:	Material:	Height:	Width:
C	VCP	15 in.	

Scores

Calculated at: **5/30/2023 11:48:45 AM**

Grade	Structural:				O&M:				Overall:	
	Segment Grade	Pipe Rating	Quick Rating	Pipe Rating Index	Segment Grade	Pipe Rating	Quick Rating	Pipe Rating Index	Pipe Rating	Pipe Rating Index
1	0	3	3100	3.0	0	0	0000	0.0	3	3.0
2	0									
3	3									
4	0									
5	0									

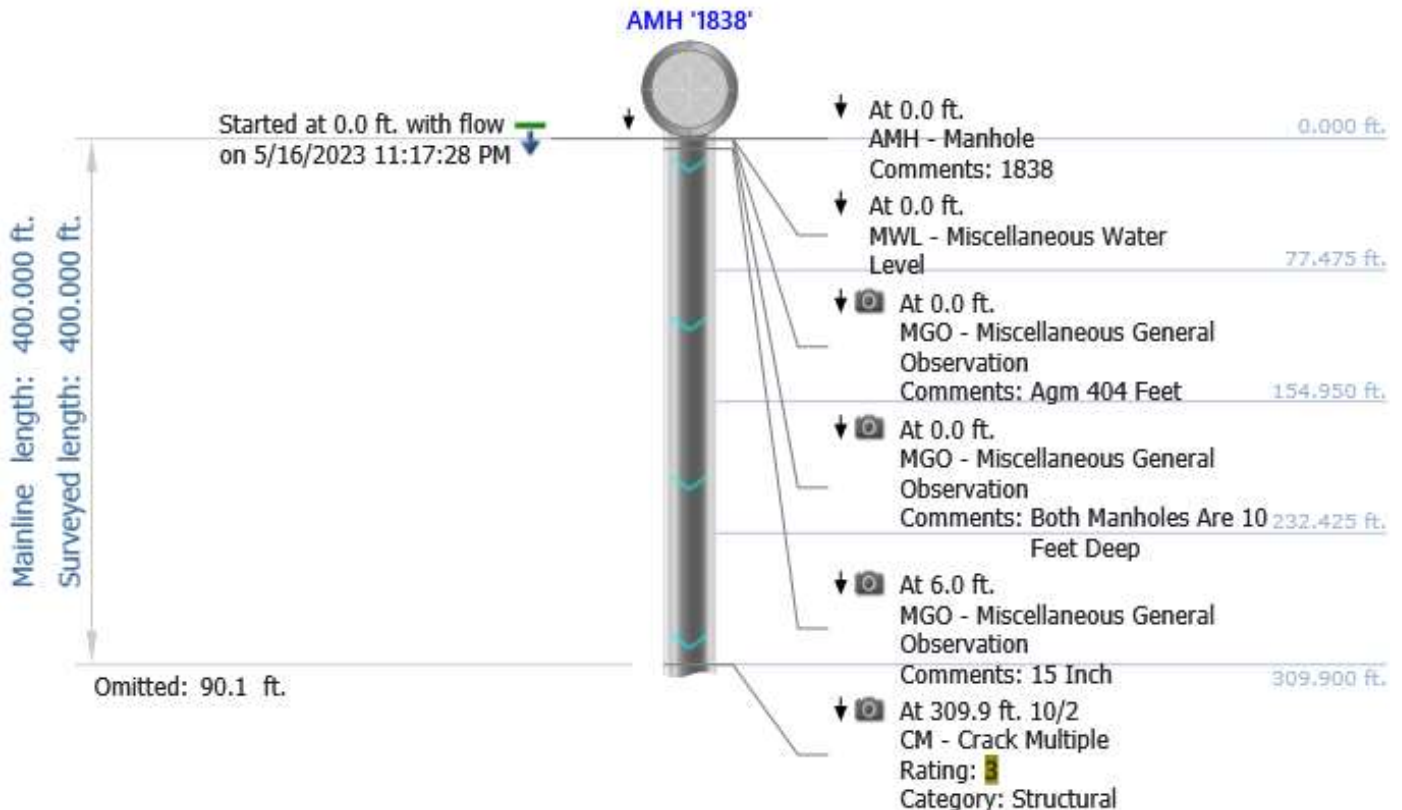

Project name:
**Weston & Sampson -
2319762**

Mainline ID:
1838 - 1839

Start date/time:
5/16/2023 11:17 PM

Direction:
D

Weather:

1

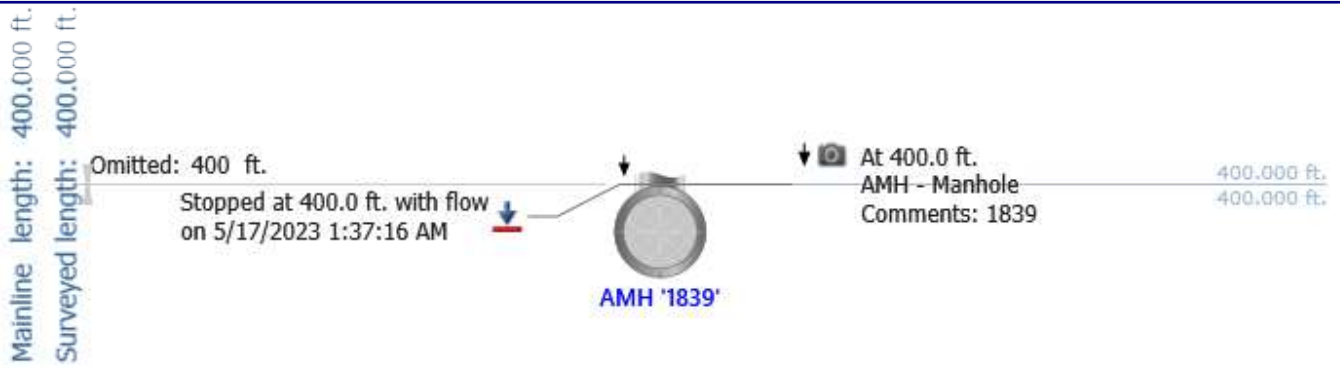



Vortex Services
521 Federal Road
Livermore, ME 04253
(207) 897-3348

Main Inspections Summary

Weston & Sampson - 2319762

Mainline ID	End date/time	Surveyed by	Start MH	Finish MH	Material	Height	Total length	Length	
1839 - 1840	5/17/2023 4:53 AM	Mike Swilley	1839	1840	VCP	15 in.	413.000 ft.	413.000 ft.	
							Sub-Total	413.0 ft.	413.0 ft.
							Total	413.0 ft.	413.0 ft.



Vortex Services
 521 Federal Road
 Livermore, ME 04253
 (207) 897-3348

Main Inspections Small Photos and Scoring

Mainline ID: 1839 - 1840	City: Georgetown, SC	Street: Hwy 17	Project name: Weston & Sampson - 2319762
Start date/time: 5/17/2023 1:40 AM	Total length: 413.000 ft.	Weather: 1	Surveyed by: Mike Swilley
Upstream MH No: 1839	Depth US: 10.000 ft.	Downstream MH No: 1840	Depth DS: 10.000 ft.
Shape: C	Material: VCP	Height: 15 in.	Width:

Additional info:

Scores

Calculated at: **5/30/2023 11:48:29 AM**

Grade	Structural:				O&M:				Overall:	
	Segment Grade	Pipe Rating	Quick Rating	Pipe Rating Index	Segment Grade	Pipe Rating	Quick Rating	Pipe Rating Index	Pipe Rating	Pipe Rating Index
1	0	4	4100	4.0	0	0	0000	0.0	4	4.0
2	0				0					
3	0				0					
4	4				0					
5	0				0					

Observations

Distance	Dir.	Length	From/To	Code	Modifier	Rating	Remarks
0.0 ft.	D		/	AMH			1839
0.0 ft.	D		/	MWL			

Observations

Distance	Dir.	Length	From/To Code	Modifier	Rating	Remarks
----------	------	--------	--------------	----------	--------	---------

110.3 ft. D / MGO Agm 408 Feet

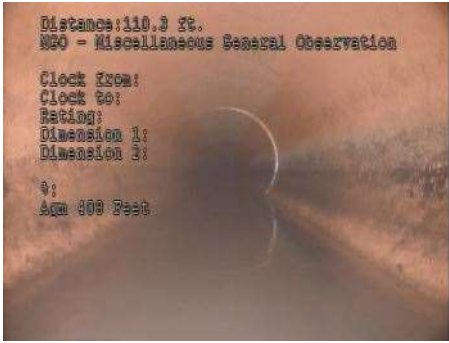

354.4 ft. D / JSL

4



413.0 ft. D / AMH

1840



Inspection's photos

Main Inspections Pipe Run and Scoring

Project name: Weston & Sampson - 2319762	Mainline ID: 1839 - 1840	City: Georgetown, SC	Street: Hwy 17
Start date/time: 5/17/2023 1:40 AM	Direction: D	Weather: 1	Location code: A
Shape: C	Material: VCP	Height: 15 in.	Width:

Scores

Calculated at: **5/30/2023 11:48:29 AM**

Grade	Structural:				O&M:				Overall:	
	Segment Grade	Pipe Rating	Quick Rating	Pipe Rating Index	Segment Grade	Pipe Rating	Quick Rating	Pipe Rating Index	Pipe Rating	Pipe Rating Index
1	0	4	4100	4.0	0	0	0000	0.0	4	4.0
2	0									
3	0									
4	4									
5	0									

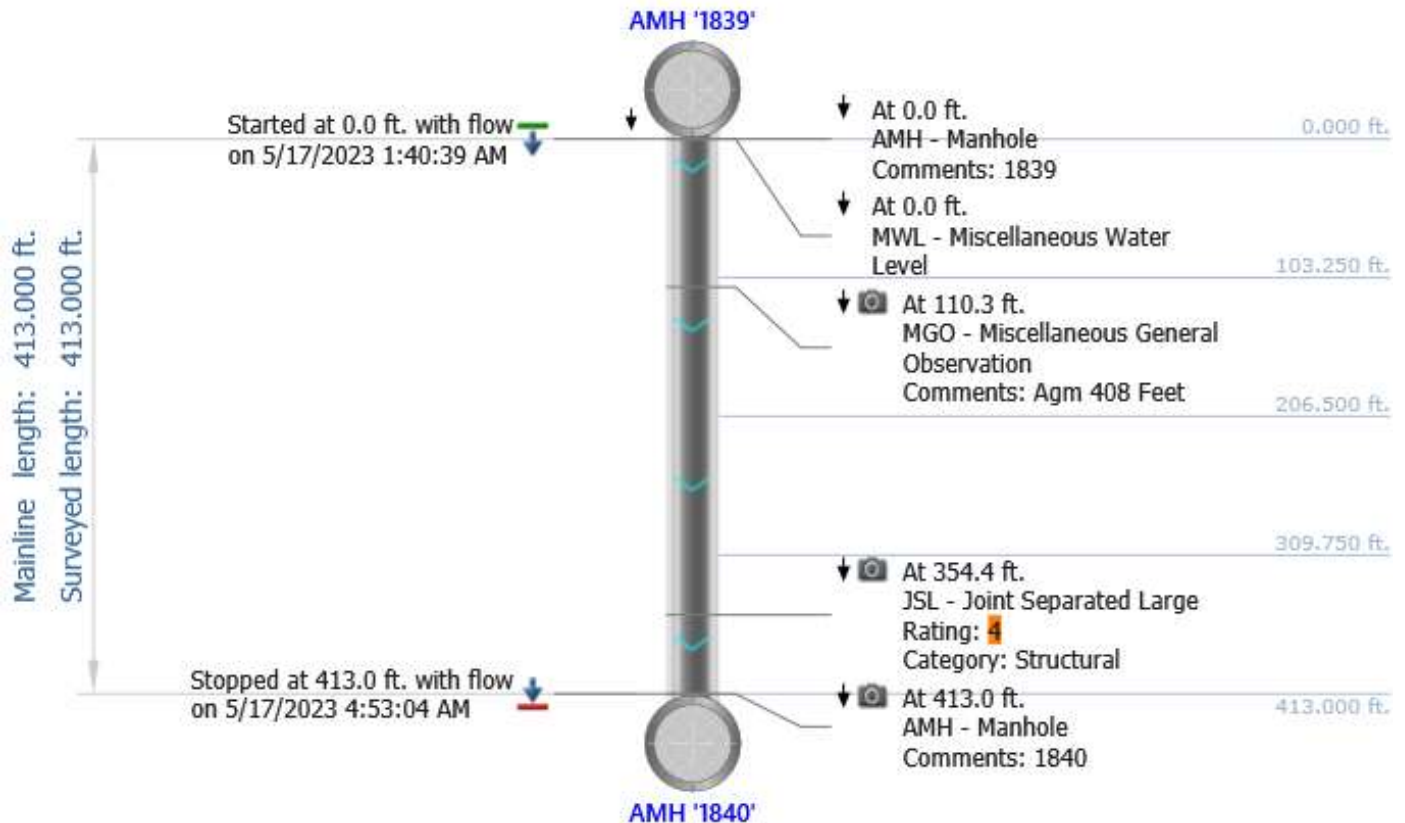



Vortex Services
521 Federal Road
Livermore, ME 04253
(207) 897-3348

Main Inspections Summary

Weston & Sampson - 2319762

Mainline ID	End date/time	Surveyed by	Start MH	Finish MH	Material	Height	Total length	Length
1840 - 1841	5/18/2023 12:36 AM	Mike Swilley	1840	1841	VCP	15 in.	343.000 ft.	343.000 ft.
Sub-Total							343.0 ft.	343.0 ft.
Total							343.0 ft.	343.0 ft.



Vortex Services
 521 Federal Road
 Livermore, ME 04253
 (207) 897-3348

Main Inspections Small Photos and Scoring

Mainline ID: 1840 - 1841	City: Georgetown, SC	Street: Hwy 17	Project name: Weston & Sampson - 2319762
Start date/time: 5/17/2023 7:56 PM	Total length: 343.000 ft.	Weather: 1	Surveyed by: Mike Swilley
Upstream MH No: 1840	Depth US: 10.000 ft.	Downstream MH No: 1841	Depth DS:
Shape: C	Material: VCP	Height: 15 in.	Width:
Additional info:			

Scores

Calculated at: **5/30/2023 11:48:09 AM**

Grade	Structural:				O&M:				Overall:	
	Segment Grade	Pipe Rating	Quick Rating	Pipe Rating Index	Segment Grade	Pipe Rating	Quick Rating	Pipe Rating Index	Pipe Rating	Pipe Rating Index
1	0	0	0000	0.0	0	0	0000	0.0	0	0.0
2	0				0					
3	0				0					
4	0				0					
5	0				0					

Observations

Distance	Dir.	Length	From/To	Code	Modifier	Rating	Remarks
0.0 ft.	D		/	AMH			1840
0.0 ft.	D		/	MWL			

Observations

Distance	Dir. Length	From/To Code	Modifier	Rating	Remarks
----------	-------------	--------------	----------	--------	---------

0.0 ft.	D	/	MGO		Agm 348 Feet
---------	---	---	-----	--	--------------



0.0 ft.	D	/	MGO		Upstream Manhole Is 10 Feet Deep. Downstream manhole Is 13 feet Deep
---------	---	---	-----	--	--



343.0 ft.	D	/	AMH		1841
-----------	---	---	-----	--	------



Inspection's photos

Main Inspections Pipe Run and Scoring

Project name: Weston & Sampson - 2319762	Mainline ID: 1840 - 1841	City: Georgetown, SC	Street: Hwy 17
Start date/time: 5/17/2023 7:56 PM	Direction: D	Weather: 1	Location code: A
Shape: C	Material: VCP	Height: 15 in.	Width:

Scores

Calculated at: **5/30/2023 11:48:09 AM**

Grade	Structural:				O&M:				Overall:	
	Segment Grade	Pipe Rating	Quick Rating	Pipe Rating Index	Segment Grade	Pipe Rating	Quick Rating	Pipe Rating Index	Pipe Rating	Pipe Rating Index
1	0	0	0000	0.0	0	0	0000	0.0	0	0.0
2	0									
3	0									
4	0									
5	0									

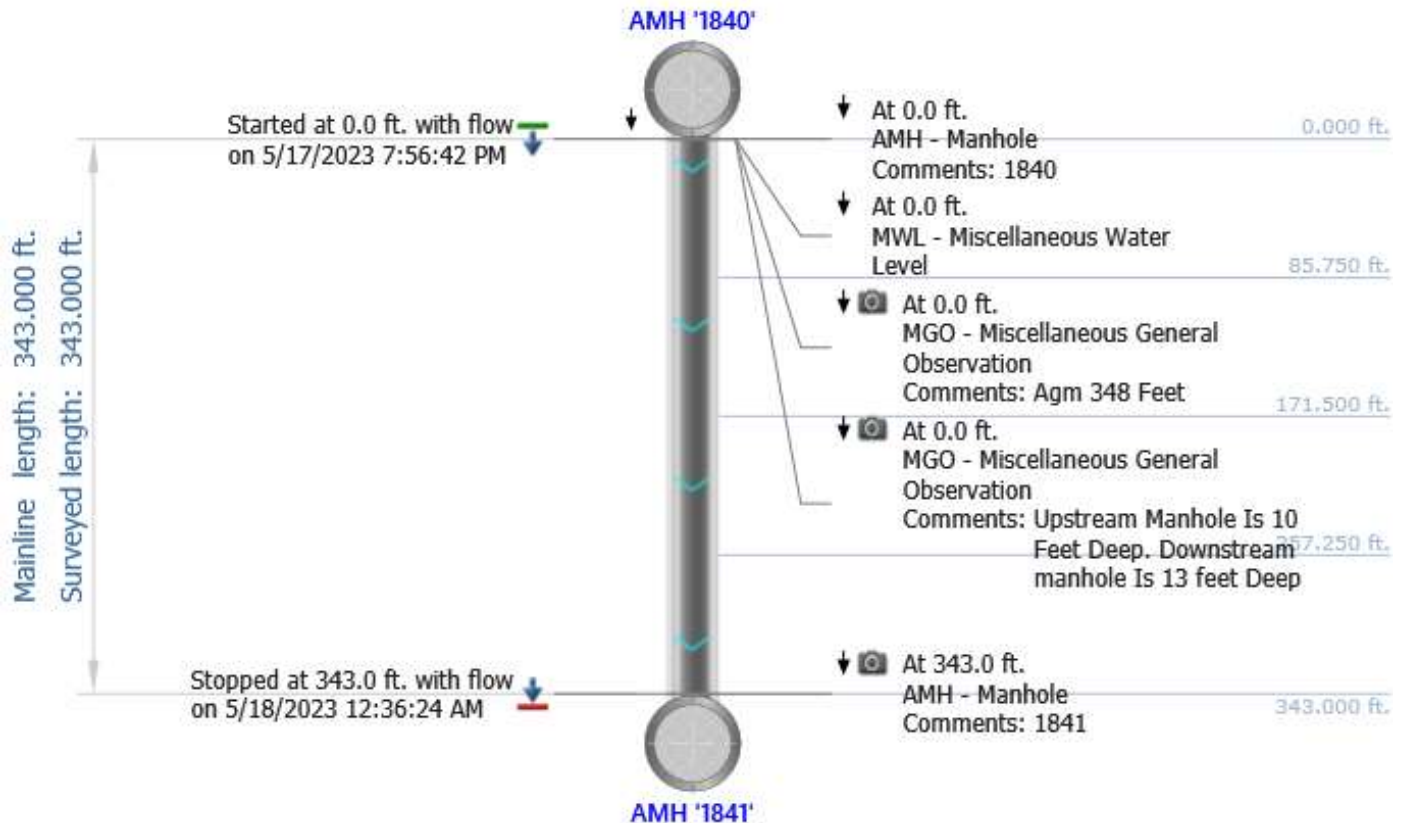



Vortex Services
521 Federal Road
Livermore, ME 04253
(207) 897-3348

Main Inspections Summary

Weston & Sampson - 2319762

Mainline ID	End date/time	Surveyed by	Start MH	Finish MH	Material	Height	Total length	Length
1841 - 1842	5/18/2023 3:12 AM	Mike Swilley	1841	1842	VCP	15 in.	398.000 ft.	398.000 ft.
Sub-Total							398.0 ft.	398.0 ft.
Total							398.0 ft.	398.0 ft.



Vortex Services
 521 Federal Road
 Livermore, ME 04253
 (207) 897-3348

Main Inspections Small Photos and Scoring

Mainline ID: 1841 - 1842	City: Georgetown, SC	Street: Hwy 17	Project name: Weston & Sampson - 2319762
Start date/time: 5/18/2023 12:39 AM	Total length: 398.000 ft.	Weather: 1	Surveyed by: Mike Swilley
Upstream MH No: 1841	Depth US:	Downstream MH No: 1842	Depth DS: 11.000 ft.
Shape: C	Material: VCP	Height: 15 in.	Width:
Additional info:			

Scores

Calculated at: **5/30/2023 11:47:48 AM**

Grade	Structural:				O&M:				Overall:	
	Segment Grade	Pipe Rating	Quick Rating	Pipe Rating Index	Segment Grade	Pipe Rating	Quick Rating	Pipe Rating Index	Pipe Rating	Pipe Rating Index
1	0	0	0000	0.0	0	0	0000	0.0	0	0.0
2	0				0					
3	0				0					
4	0				0					
5	0				0					

Observations

Distance	Dir.	Length	From/To	Code	Modifier	Rating	Remarks
0.0 ft.	D		/	AMH			1841
0.0 ft.	D		/	MWL			

Observations

Distance	Dir. Length	From/To Code	Modifier	Rating	Remarks
----------	-------------	--------------	----------	--------	---------

0.2 ft.	D	/	MGO		Agm 398 Feet
---------	---	---	-----	--	--------------



0.2 ft.	D	/	MGO		Upstream Manhole Is 10 Feet Deep. Downstream is 11 Feet Deep
---------	---	---	-----	--	--



398.0 ft.	D	/	AMH		1842
-----------	---	---	-----	--	------



Inspection's photos

Main Inspections Pipe Run and Scoring

Project name: Weston & Sampson - 2319762	Mainline ID: 1841 - 1842	City: Georgetown, SC	Street: Hwy 17
Start date/time: 5/18/2023 12:39 AM	Direction: D	Weather: 1	Location code: A
Shape: C	Material: VCP	Height: 15 in.	Width:

Scores

Calculated at: **5/30/2023 11:47:48 AM**

Grade	Structural:				O&M:				Overall:	
	Segment Grade	Pipe Rating	Quick Rating	Pipe Rating Index	Segment Grade	Pipe Rating	Quick Rating	Pipe Rating Index	Pipe Rating	Pipe Rating Index
1	0	0	0000	0.0	0	0	0000	0.0	0	0.0
2	0									
3	0									
4	0									
5	0									

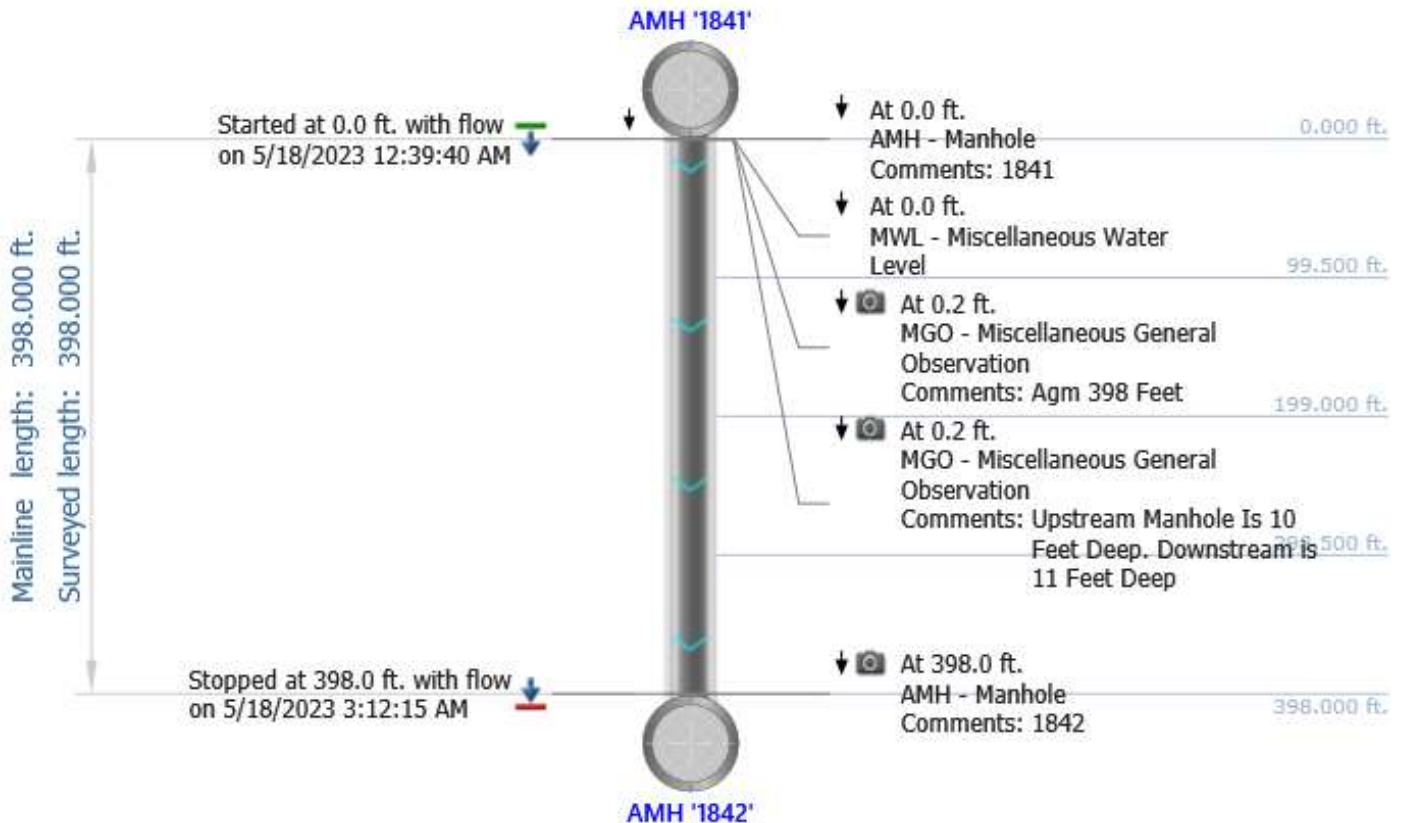



Vortex Services
521 Federal Road
Livermore, ME 04253
(207) 897-3348

Main Inspections Summary

Weston & Sampson - 2319762

Mainline ID	End date/time	Surveyed by	Start MH	Finish MH	Material	Height	Total length	Length	
1842 - 1828	5/18/2023 3:59 AM	Mike Swilley	1842	1828	VCP	15 in.	57.000 ft.	57.000 ft.	
							Sub-Total	57.0 ft.	57.0 ft.
							Total	57.0 ft.	57.0 ft.



Vortex Services
 521 Federal Road
 Livermore, ME 04253
 (207) 897-3348

Main Inspections Small Photos and Scoring

Mainline ID: 1842 - 1828	City: Georgetown, SC	Street: Hwy 17	Project name: Weston & Sampson - 2319762
Start date/time: 5/18/2023 3:55 AM	Total length: 57.000 ft.	Weather: 1	Surveyed by: Mike Swilley
Upstream MH No: 1842	Depth US: 11.000 ft.	Downstream MH No: 1828	Depth DS: 13.0 ft.
Shape: C	Material: VCP	Height: 15 in.	Width:
Additional info:			

Scores

Calculated at: **5/30/2023 11:47:29 AM**

Grade	Structural:				O&M:				Overall:	
	Segment Grade	Pipe Rating	Quick Rating	Pipe Rating Index	Segment Grade	Pipe Rating	Quick Rating	Pipe Rating Index	Pipe Rating	Pipe Rating Index
1	0	0	0000	0.0	0	0	0000	0.0	0	0.0
2	0				0					
3	0				0					
4	0				0					
5	0				0					

Observations

Distance	Dir.	Length	From/To	Code	Modifier	Rating	Remarks
0.0 ft.	D		/	AMH			1842
0.0 ft.	D		/	MWL			

Observations

Distance	Dir. Length	From/To Code	Modifier	Rating	Remarks
0.0 ft.	D	/ MGO			Agm 57 Feet



57.0 ft.	D	/ AMH			1828
----------	---	-------	--	--	------

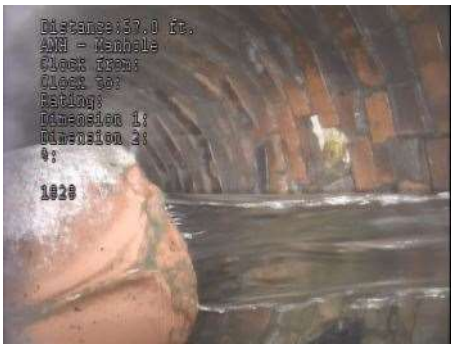

Inspection's photos

Main Inspections Pipe Run and Scoring

Project name:	Mainline ID:	City:	Street:
Weston & Sampson - 2319762	1842 - 1828	Georgetown, SC	Hwy 17
Start date/time:	Direction:	Weather:	Location code:
5/18/2023 3:55 AM	D	1	A
Shape:	Material:	Height:	Width:
C	VCP	15 in.	

Scores

Calculated at: **5/30/2023 11:47:29 AM**

Grade	Structural:				O&M:				Overall:	
	Segment Grade	Pipe Rating	Quick Rating	Pipe Rating Index	Segment Grade	Pipe Rating	Quick Rating	Pipe Rating Index	Pipe Rating	Pipe Rating Index
1	0	0	0000	0.0	0	0	0000	0.0	0	0.0
2	0									
3	0									
4	0									
5	0									

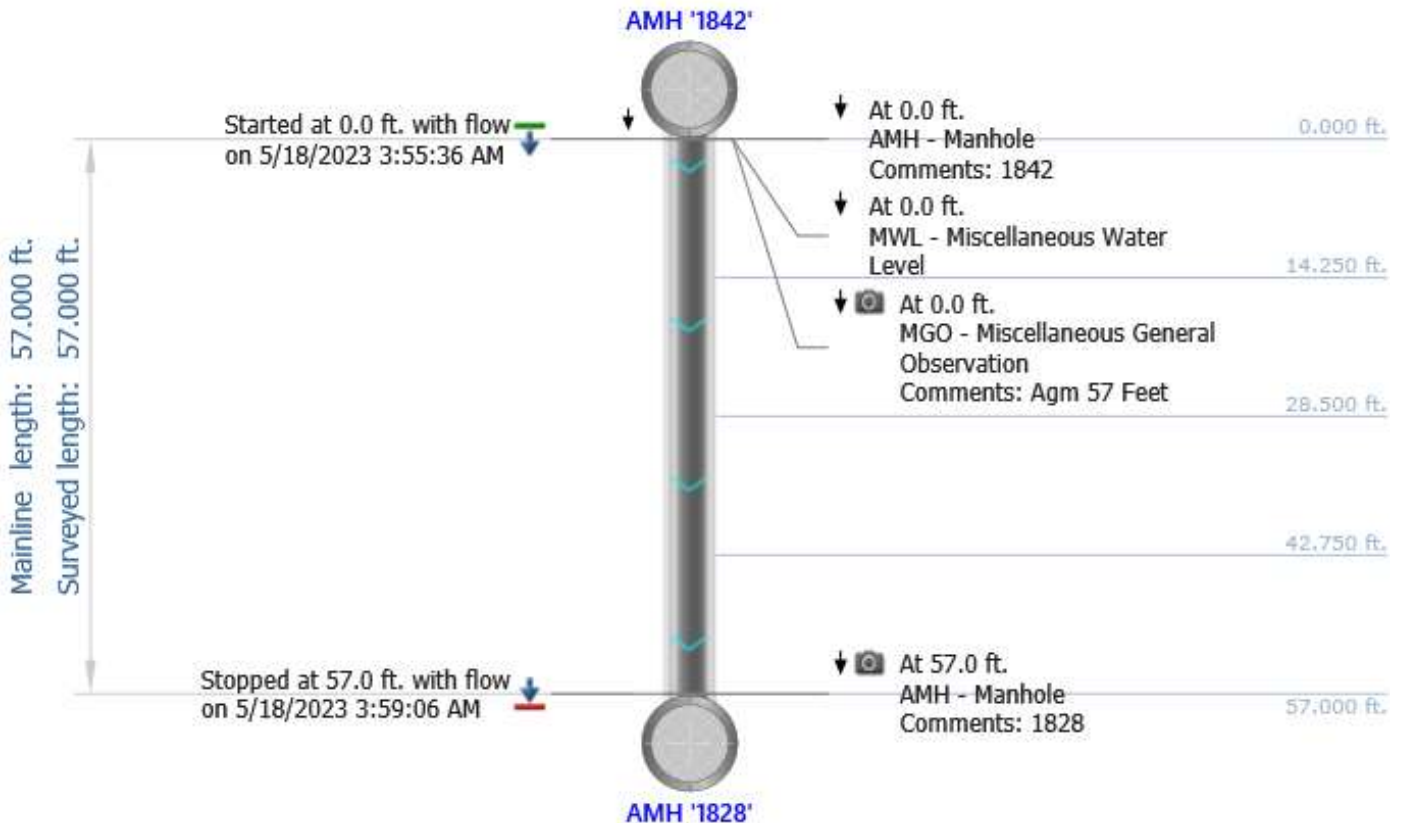

THIS PAGE INTENTIONALLY LEFT BLANK

APPENDIX I

PACP MAIN LINE CCTV REPORTS

THIS PAGE INTENTIONALLY LEFT BLANK



WinCan

Project

Project

Aug 2023 Vortex SC

8/16/2023



Table of Contents

Project
Aug 2023 Vortex SC

8/9/2023

Project Information	P-1
Node Profile	P-2
Node:0;1829	1
Node:0;1823	11
Node:0;1833	20
Node:0;1839	28
Node:0;1837	38
Node:0;1821	50
Node:0;1834	57
Node:0;1828	65
Node:0;1835	73
Node:0;1842	82
Node:0;1831	92
Node:0;1818	101
Node:0;2194	109
Node:0;2193	116
Node:0;1840	125
Node:0;1841	135
Node:0;1830	143
Node:0;1838	154
Node:0;1819	164
Node:0;1832	173



WinCan

Project Information

Project
Aug 2023 Vortex SC

8/9/2023



Node Profile

Project
Aug 2023 Vortex SC

8/9/2023

Nr.	Manhole Number	City	Street	Date
	1829	Georgetown	132 South Fraser Street	8/13/2023
	1823	Georgetown	301-369 South Fraser Street	8/14/2023
	1833	Georgetown	408-422 South Fraser Street	8/9/2023
	1839	Georgetown	311 South Fraser Street	8/14/2023
	1837	Georgetown	423 South Fraser Street	8/9/2023
	1821	Georgetown	507 South Fraser Street	8/14/2023
	1834	Georgetown	508 South Fraser Street	8/14/2023
	1828	Georgetown	Front Street and South Road	8/9/2023
	1835	Georgetown	601 South Fraser Street	8/14/2023
	1842	Georgetown	101 South Fraser Street	8/9/2023
	1831	Georgetown	334 Fraser Street	8/14/2023
	1818	Georgetown	540 South Fraser Street	8/9/2023
	2194	Georgetown	1406 Bourne Street	8/14/2023
	2193	Georgetown	1406 Bourne Street	8/9/2023
	1840	Georgetown	217 South Fraser Street	8/9/2023
	1841	Georgetown	133 South Fraser Street	8/9/2023
	1830	Georgetown	300 South Fraser Street	8/9/2023
	1838	Georgetown	407 South Fraser Street	8/9/2023
	1819	Georgetown	600 South Fraser Street	8/9/2023
	1832	Georgetown	408 South Fraser Street	8/9/2023



Node Inspection - 8/13/2023 - 1829

Date 8/13/2023	Time 22:28	Manhole Number 1829	Access Type Manhole	City Georgetown	Street 132 South Fraser
Surveyed By Matthew Headrick	Certificate Number U-0419-07030528	PO Number	Work Order	Pre-Cleaning No Pre-Cleaning	Sheet Number

General Manhole Information

MH Use	Sanitary	Year Constructed		Year Renewed		Owner	City of Georgetown
Rim to Invert	10.9'	Grade to Invert	10.9'	Rim to Grade	0.0'	Rim to Grade Exposed	0.0'
Surface Type	Asphalt						
Location Code	Light Highway	Location Details					
Additional component information	3						

General Manhole Inspection Information

Date Cleaned		Inspection Level	Level 2	Consequence of Failure	
Customer		Evidence Surcharge	No	Purpose	Routine assessment
Reviewed By	Juan Bedoya	Reviewer Certificate	U-1020-70400280	Weather	Dry
Is Imperial	No	Inspection Status	Remote Inspection	Media Label	WinCan 14.0
Potential for RunOff	None				

Cover

Cover Type	Solid					
Cover Shape	Circular	Cover Size	23.5"	Center Cover Size		Cover Width
Cover Material	Cast Iron	Hole Diameter				Hole Number
Cover Frame fit	Good	Cover Bearing Surface Diameter	23.0"	Cover Bearing Surface Width		
Cover Condition	Sound					

Cover Insert

Cover Insert Type	None	Insert Condition	
-------------------	-------------	------------------	--

Frame

Frame Material	Cast Iron	Frame Bearing Surface Width	0.8"	Frame Bearing Surface Depth	1.0"
Frame Seal Inflow	None	Frame Clear Open Diameter	21.8"	Frame Clear Open Width	
Frame Depth	3.0"	Frame Offset Distance	0.0"		
Frame Condition	Sound				
Seal Condition	Sound				

Chimney

Chimney Present	Yes	Chimney Material 1	Brick	Chimney Material 2	
Chimney Clear Opening	20.6"	Chimney Depth	2.0'	Chimney Infiltration	None
Chimney Condition	Sound	Chimney Lining Interior	None	Chimney Lining Exterior	Not Known

Cone

Cone Type	Conical centered	Cone Material	Brick	Cone Depth	6.4'
Cone Condition	Sound	Cone Lining Interior	None	Cone Lining Exterior	Not Known

Wall

Wall Material	Brick	Wall Diameter	48.0"	Wall By Size	48.0"	Wall Depth	10.2'
Wall Condition	Sound	Wall Lining Exterior	Not Known	Wall Lining Interior	None		

Bench

Bench Condition	Sound	Bench Present	Yes	Bench Material	Brick	Bench Lining	None
-----------------	--------------	---------------	------------	----------------	--------------	--------------	-------------

QSR	QMR	QOR	SPR	MPR	OPR	SPRI	MPRI	OPRI
5145	3122	5145	29.0	12.0	41.0	2.9	1.5	2.3



Node Inspection - 8/13/2023 - 1829

Date 8/13/2023	Time 22:28	Manhole Number 1829	Access Type Manhole	City Georgetown	Street 132 South Fraser
Surveyed By Matthew Headrick	Certificate Number U-0419-07030528	PO Number	Work Order	Pre-Cleaning No Pre-Cleaning	Sheet Number

Channel

Channel Installed	Yes	Channel Material	Brick	Channel Type	Formed
Channel Condition	Sound	Channel Exposure	Fully Opened		

Observations

Nr.	Distance	MACP Code	Observation	Remark
1	1.3'	IW	Infiltration Weeper from 6 o'clock to 7 o'clock, within 8 inch	minor inf at brick
2	1.5'	MML	Missing Mortar Large from 12 o'clock to 12 o'clock	fully exposed bricks with gaps
3	4.8'	MML	Missing Mortar Large from 12 o'clock to 12 o'clock	fully exposed bricks with gaps
4	7.6'	HVV	Hole Void Visible from 2 o'clock to 4 o'clock, within 8 inch	major void, full thickness of wall visible
5	8.6'	MML	Missing Mortar Large from 12 o'clock to 12 o'clock	fully exposed bricks with gaps
6	9.4'	IW	Infiltration Weeper from 12 o'clock to 12 o'clock, within 8 inch	minor infiltration at wall from bricks
7	10.5'	MML	Missing Mortar Large from 12 o'clock to 12 o'clock	fully exposed bricks at bench
8	10.5'	ID	Infiltration Dripper from 12 o'clock to 12 o'clock, within 8 inch	moderate infiltration from bench brick gaps
9	10.7'	MML	Missing Mortar Large from 12 o'clock to 12 o'clock	fully exposed bricks with gaps

Connections

Pipe Number	Rim To Invert	Direction	Clock Position	Shape	Material	Height	Width	Pipe Condition	Seal Condition	Pipe Type	Structure ID	Comments
1	10.9'	Out	6	Circular	Vitrified Clay Pipe	12"	-	Sound	Sound	Gravity Connection		
2	10.9'	In	12	Circular	Vitrified Clay Pipe	12"	-	Sound	Sound	Gravity Connection		
3	10.4'	In	3	Circular	Vitrified Clay Pipe	8"	-	Sound	Defective	Gravity Connection		
4	8.4'	In	3	Circular	Vitrified Clay Pipe	8"	-	Sound	Defective	Gravity Connection		

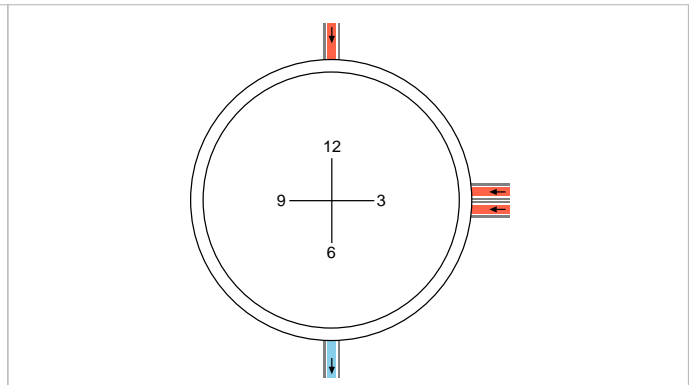
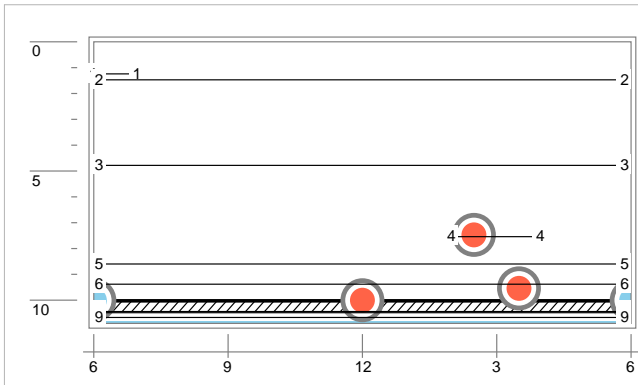

QSR	QMR	QOR	SPR	MPR	OPR	SPRI	MPRI	OPRI
5145	3122	5145	29.0	12.0	41.0	2.9	1.5	2.3



Node 2D Sketch - 8/13/2023 - 1829

Date 8/13/2023	Manhole Number 1829	City Georgetown	Street 132 South Fraser Street	Surveyed By Matthew Headrick
-------------------	------------------------	--------------------	-----------------------------------	---------------------------------

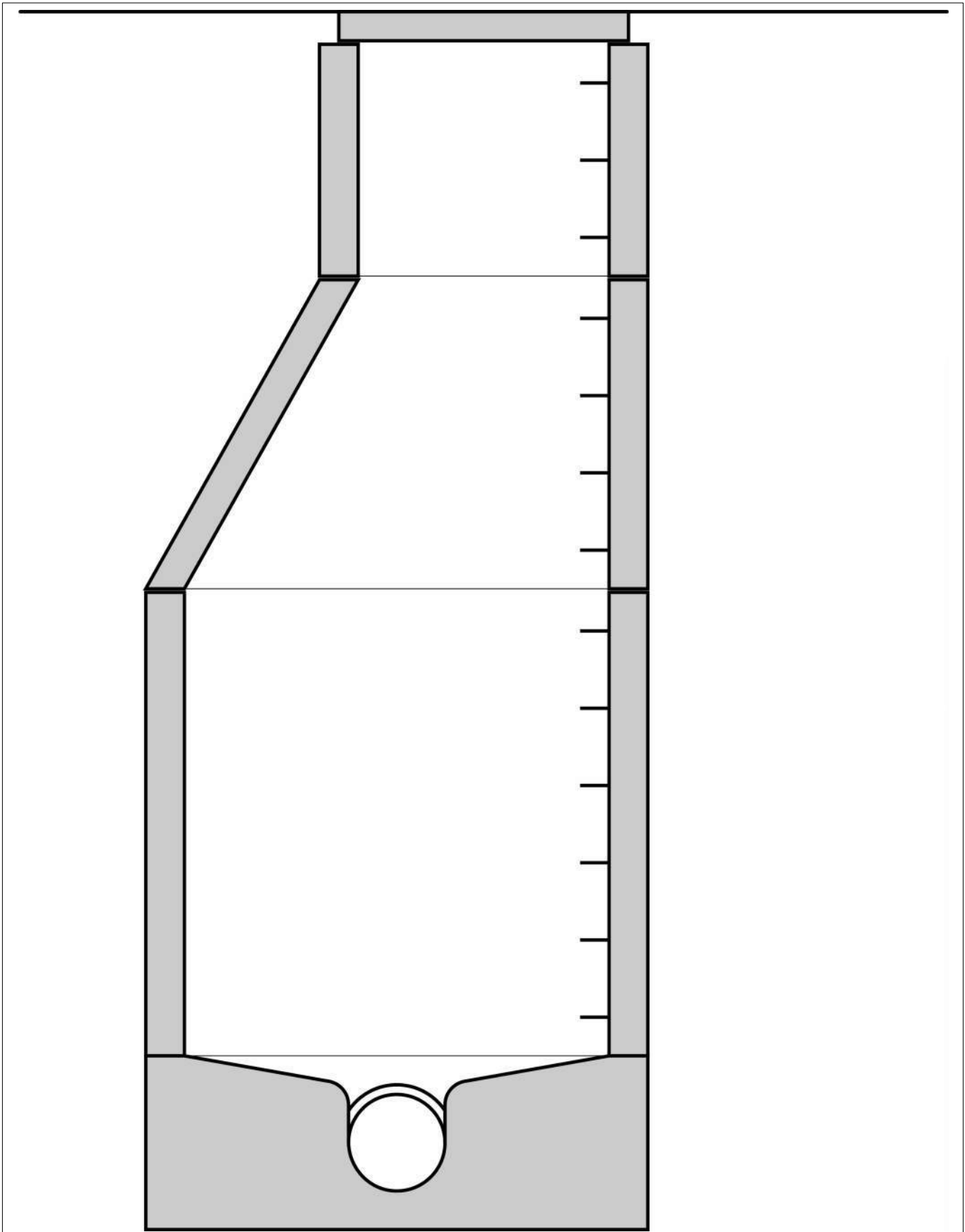



Node Pictures - 8/13/2023 - 1829

Date 8/13/2023	Manhole Number 1829	City Georgetown	Street 132 South Fraser Street	Surveyed By Matthew Headrick
-------------------	------------------------	--------------------	-----------------------------------	---------------------------------



1829b_c3bb5419-4fc2-49bd-9cbb-ae8a522c6251_3b097954-56f3-4b33-9fc7-c80c508f7421_P11.jpg,
1.28
Infiltration Weeper from 6 o'clock to 7 o'clock, within 8 inch



1829b_c3bb5419-4fc2-49bd-9cbb-ae8a522c6251_e2247d21-da48-437d-b0c9-70c0777bef81_P11.jpg,
00:00:10, 1.51
Missing Mortar Large from 12 o'clock to 12 o'clock



Node Pictures - 8/13/2023 - 1829

Date 8/13/2023	Manhole Number 1829	City Georgetown	Street 132 South Fraser Street	Surveyed By Matthew Headrick
-------------------	------------------------	--------------------	-----------------------------------	---------------------------------



1829b_c3bb5419-4fc2-49bd-9cbb-ae8a522c6251_d20457a7-fd48-4840-a563-c6483aa35cbf_P11.jpg,
00:00:21, 4.81
Missing Mortar Large from 12 o'clock to 12 o'clock



1829b_c3bb5419-4fc2-49bd-9cbb-ae8a522c6251_529420aa-6db1-47bc-8ee3-9da21fb0b2d7_P11.jpg,
00:00:32, 7.57
Hole Void Visible from 2 o'clock to 4 o'clock, within 8 inch



Node Pictures - 8/13/2023 - 1829

Date 8/13/2023	Manhole Number 1829	City Georgetown	Street 132 South Fraser Street	Surveyed By Matthew Headrick
-------------------	------------------------	--------------------	-----------------------------------	---------------------------------



1829b_c3bb5419-4fc2-49bd-9cbb-ae8a522c6251_9e8d4b03-b9ec-4381-9e05-22afe383fce8_P11.jpg,
00:00:37, 8.63
Missing Mortar Large from 12 o'clock to 12 o'clock



1829b_c3bb5419-4fc2-49bd-9cbb-ae8a522c6251_e8cafd26-0278-49d6-ae87-3f0214f81d3b_P11.jpg,
00:00:40, 9.39
Infiltration Weeper from 12 o'clock to 12 o'clock, within 8 inch



Node Pictures - 8/13/2023 - 1829

Date 8/13/2023	Manhole Number 1829	City Georgetown	Street 132 South Fraser Street	Surveyed By Matthew Headrick
-------------------	------------------------	--------------------	-----------------------------------	---------------------------------



1829b_c3bb5419-4fc2-49bd-9cbb-ae8a522c6251_5dac7274-bd42-468c-9cd3-1184b31077e1_P11.jpg,
00:00:43, 10.48
Missing Mortar Large from 12 o'clock to 12 o'clock



1829b_c3bb5419-4fc2-49bd-9cbb-ae8a522c6251_fafdea7a-ceca-49f8-a0fe-aca9e9443519_P11.jpg,
00:00:43, 10.53
Infiltration Dropper from 12 o'clock to 12 o'clock, within 8 inch



Node Pictures - 8/13/2023 - 1829

Date 8/13/2023	Manhole Number 1829	City Georgetown	Street 132 South Fraser Street	Surveyed By Matthew Headrick
-------------------	------------------------	--------------------	-----------------------------------	---------------------------------



1829b_c3bb5419-4fc2-49bd-9cbb-ae8a522c6251_f3ab9e9f-2c73-4d4d-b4f0-7177eac04aa9_P11.jpg,
00:00:43, 10.68
Missing Mortar Large from 12 o'clock to 12 o'clock



Node Drawings - 8/13/2023 - 1829

Date 8/13/2023	Manhole Number 1829	City Georgetown	Street 132 South Fraser Street	Surveyed By Matthew Headrick
-------------------	------------------------	--------------------	-----------------------------------	---------------------------------

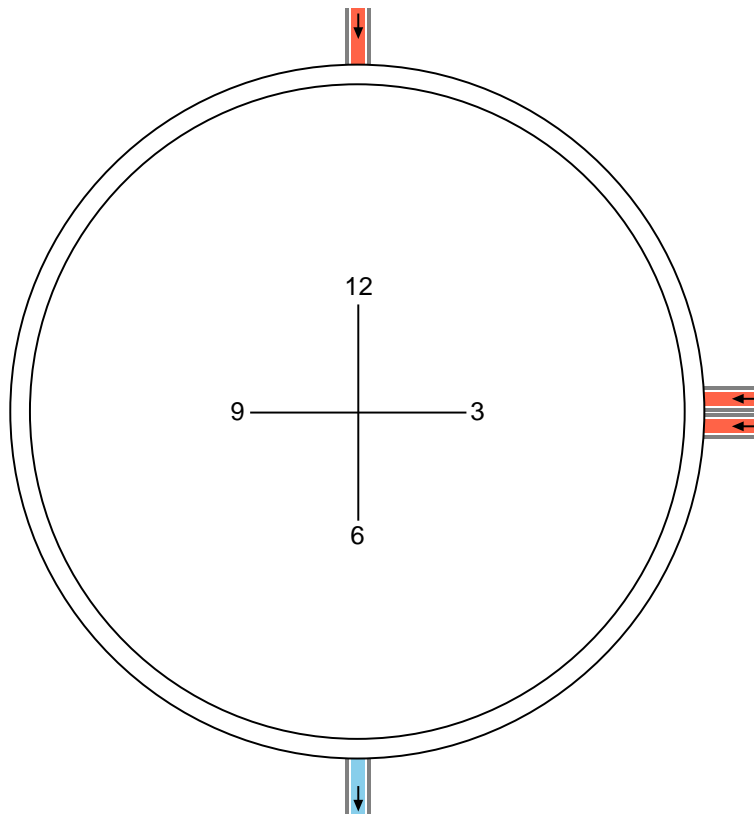
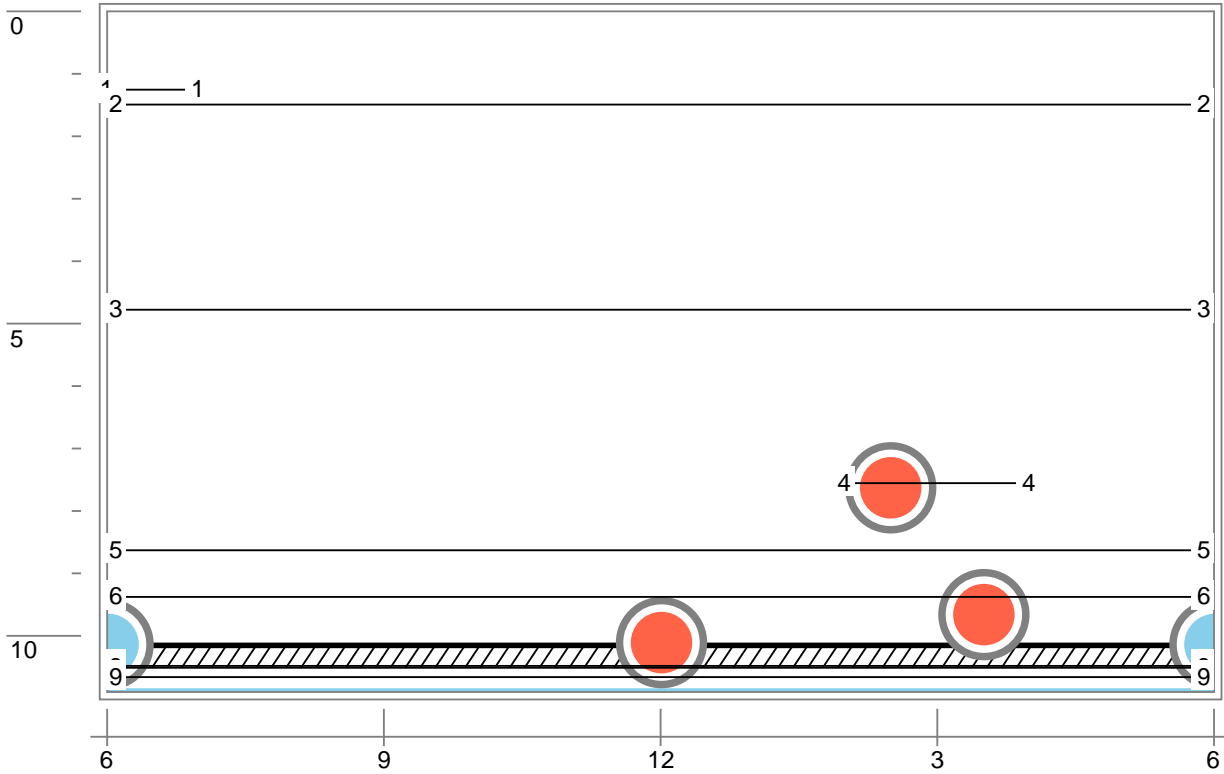



CleverScan - 8/13/2023 - 1829

Date 8/13/2023	Manhole Number 1829	City Georgetown	Street 132 South Fraser Street	Surveyed By Matthew Headrick
-------------------	------------------------	--------------------	-----------------------------------	---------------------------------

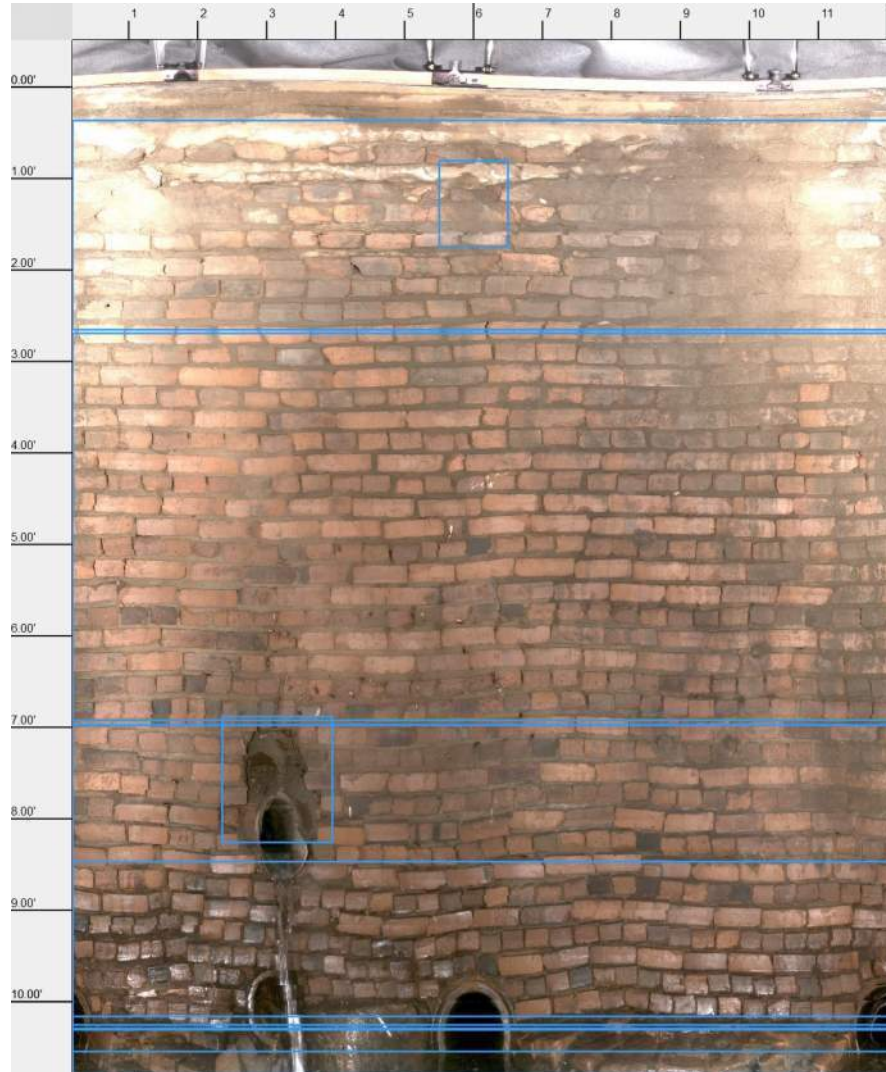



Node Inspection - 8/14/2023 - 1823

Date 8/14/2023	Time 7:42	Manhole Number 1823	Access Type Manhole	City Georgetown	Street 301-369 South Fraser
Surveyed By Matthew Headrick	Certificate Number U-0419-07030528	PO Number	Work Order	Pre-Cleaning No Pre-Cleaning	Sheet Number

General Manhole Information

MH Use Sanitary	Year Constructed	Year Renewed	Owner	City of Georgetown
Rim to Invert 5.1'	Grade to Invert 5.1'	Rim to Grade 0.0'	Rim to Grade Exposed	0.0'
Surface Type Asphalt				
Location Code Alley	Location Details 8' from Rolling Mill Rally Point			
Additional component information				

General Manhole Inspection Information

Date Cleaned	Inspection Level Level 2	Consequence of Failure
Customer	Evidence Surcharge No	Purpose Routine assessment
Reviewed By Juan Bedoya	Reviewer Certificate U-1020-70400280	Weather Dry
Is Imperial No	Inspection Status Remote Inspection	Media Label WinCan 14.0
Potential for RunOff None		

Cover

Cover Type Solid					
Cover Shape Circular	Cover Size 23.5"	Center Cover Size	Cover Width		
Cover Material Cast Iron	Hole Diameter	Hole Number 0			
Cover Frame fit Good	Cover Bearing Surface Diameter 23.0"	Cover Bearing Surface Width			
Cover Condition Sound					

Cover Insert

Cover Insert Type None	Insert Condition
----------------------------------	------------------

Frame

Frame Material Cast Iron	Frame Bearing Surface Width 0.5"	Frame Bearing Surface Depth 1.0"
Frame Seal Inflow None	Frame Clear Open Diameter 22.0"	Frame Clear Open Width
Frame Depth 10.0"	Frame Offset Distance 0.0"	
Frame Condition Corroded		
Seal Condition Sound		

Cone

Cone Type Conical centered	Cone Material Brick	Cone Depth 2.9'
Cone Condition Sound	Cone Lining Interior None	Cone Lining Exterior Not Known

Wall

Wall Material Brick	Wall Diameter 43.3"	Wall By Size 43.3"	Wall Depth 3.9'
Wall Condition Sound	Wall Lining Exterior Not Known	Wall Lining Interior None	

Bench

Bench Condition Sound	Bench Present Yes	Bench Material Brick	Bench Lining None
---------------------------------	-----------------------------	--------------------------------	-----------------------------

Channel

Channel Installed Yes	Channel Material Concrete (cast in place)	Channel Type Formed
Channel Condition Sound	Channel Exposure Fully Opened	

Steps

Step Number 2	Step Material Metal
-------------------------	-------------------------------

QSR	QMR	QOR	SPR	MPR	OPR	SPRI	MPRI	OPRI
4231	2315	4231	17.0	11.0	28.0	2.1	1.4	1.8



Node Inspection - 8/14/2023 - 1823

Date 8/14/2023	Time 7:42	Manhole Number 1823	Access Type Manhole	City Georgetown	Street 301-369 South Fraser
Surveyed By Matthew Headrick	Certificate Number U-0419-07030528	PO Number	Work Order	Pre-Cleaning No Pre-Cleaning	Sheet Number

Observations

Nr.	Distance	MACP Code	Observation	Remark
1	0.9'	MMM	Missing Mortar Medium from 12 o'clock to 12 o'clock	frame seal missing mortar
2	1.9'	MML	Missing Mortar Large from 12 o'clock to 12 o'clock	fully exposed bricks with gaps
3	3.3'	SAV	Surface Damage Aggregate Visible from 12 o'clock to 12 o'clock, within 8 inch	aggregate visible on concrete bricks/blocks
4	3.5'	IS	Infiltration Stain from 12 o'clock to 12 o'clock, within 8 inch	stains at wall>moisture indicative of inflow
5	3.5'	MML	Missing Mortar Large from 12 o'clock to 12 o'clock	fully exposed bricks with gaps
6	4.0'	IW	Infiltration Weeper from 11 o'clock to 1 o'clock, within 8 inch	minor infiltration from bench
7	4.4'	IW	Infiltration Weeper from 6 o'clock to 7 o'clock, within 8 inch	minor infiltration at pipe seal
8	4.4'	DSGV	Deposits Settled Gravel, 15% of cross sectional area from 8 o'clock to 12 o'clock, within 8 inch	settlement in channel

Connections

Pipe Number	Rim To Invert	Direction	Clock Position	Shape	Material	Height	Width	Pipe Condition	Seal Condition	Pipe Type	Structure ID	Comments
1	5.1'	Out	6	Circular	Vitrified Clay Pipe	8"	-	Sound	Sound	Gravity Connection		
2	3.1'	In	7	Circular	Polyvinyl Chloride	6"	-	Sound	Sound	Gravity Connection		
3	3.9'	In	1	Circular	Cast Iron	6"	-	Sound	Sound	Gravity Connection		
4	3.9'	In	2	Circular	Cast Iron	8"	-	Sound	Sound	Gravity Connection		

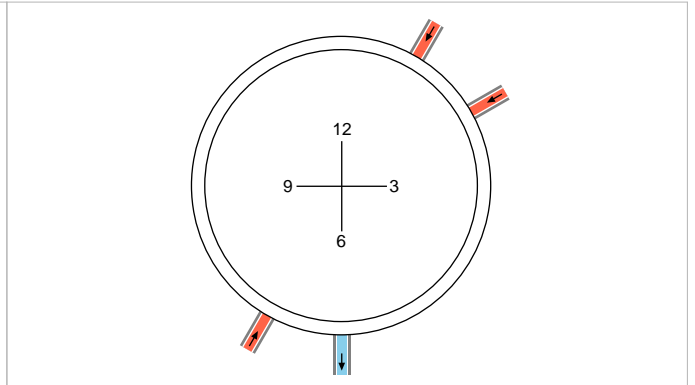
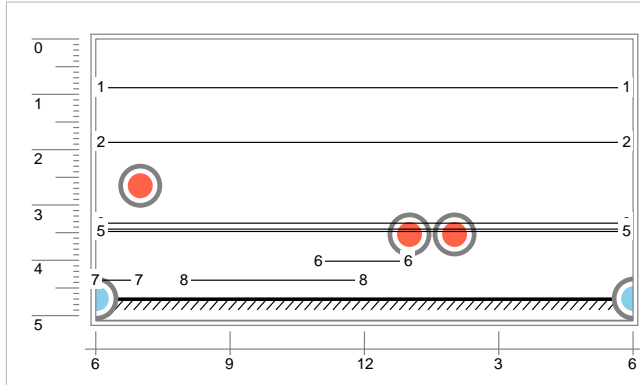

QSR	QMR	QOR	SPR	MPR	OPR	SPRI	MPRI	OPRI
4231	2315	4231	17.0	11.0	28.0	2.1	1.4	1.8



Node 2D Sketch - 8/14/2023 - 1823

Date 8/14/2023	Manhole Number 1823	City Georgetown	Street 301-369 South Fraser	Surveyed By Matthew Headrick
-------------------	------------------------	--------------------	--------------------------------	---------------------------------

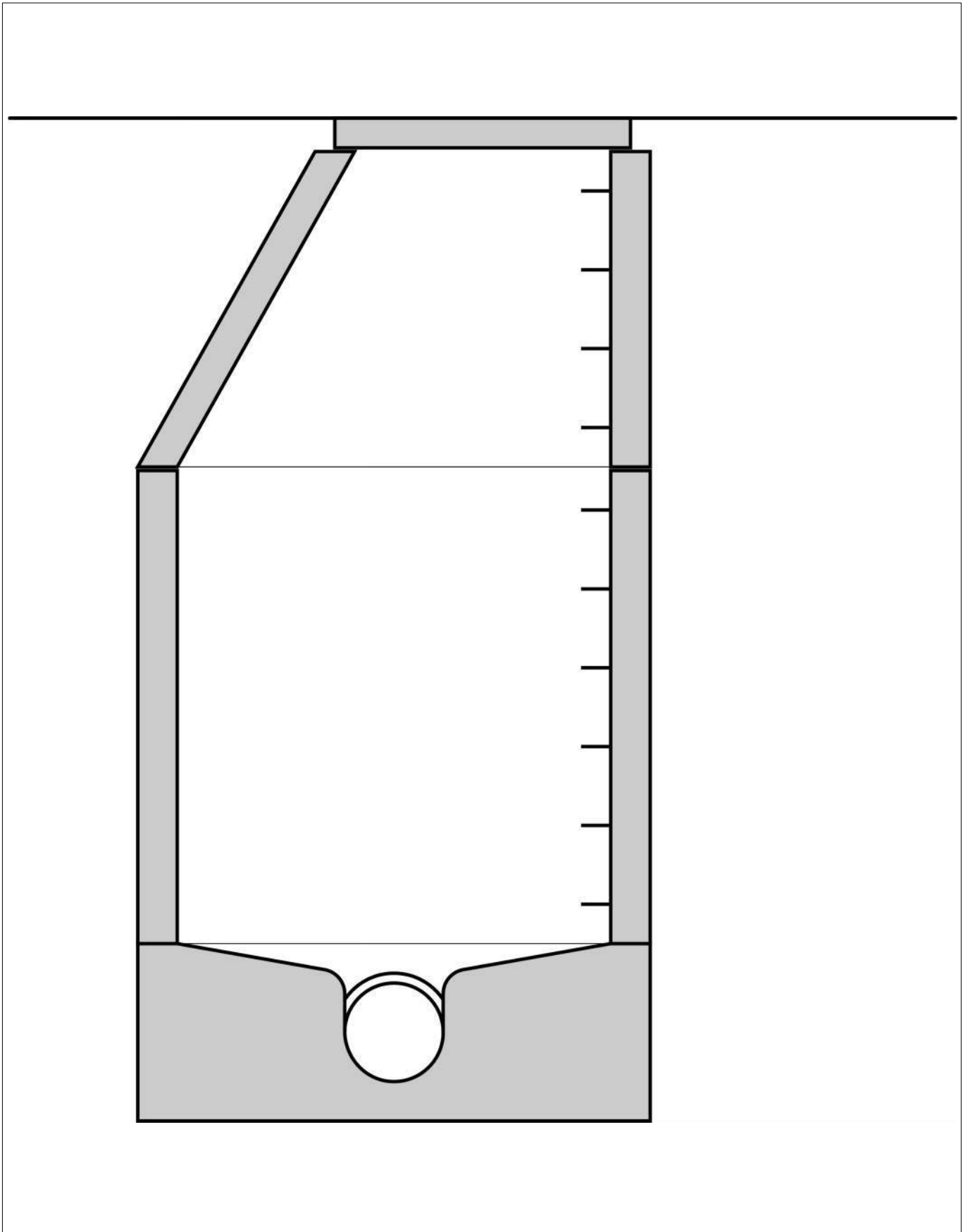



Node Pictures - 8/14/2023 - 1823

Date 8/14/2023	Manhole Number 1823	City Georgetown	Street 301-369 South Fraser	Surveyed By Matthew Headrick
-------------------	------------------------	--------------------	--------------------------------	---------------------------------



1823d_c2435bdb-6471-4a3b-8f5b-2755123d82bf_2abfd172-3343-4967-8249-fb00c0f1d705_P11.jpg,
, 0.89
Missing Mortar Medium from 12 o'clock to 12 o'clock



1823d_c2435bdb-6471-4a3b-8f5b-2755123d82bf_3c920d25-da83-4924-ac81-5fffd8014f1a_P11.jpg,
00:00:10, 1.87
Missing Mortar Large from 12 o'clock to 12 o'clock



Node Pictures - 8/14/2023 - 1823

Date 8/14/2023	Manhole Number 1823	City Georgetown	Street 301-369 South Fraser	Surveyed By Matthew Headrick
-------------------	------------------------	--------------------	--------------------------------	---------------------------------



1823d_c2435bdb-6471-4a3b-8f5b-2755123d82bf_03683b8d-11dc-48d5-bed8-cf54731349bd_P11.jpg,
00:00:12, 3.34

Surface Damage Aggregate Visible from 12 o'clock to 12 o'clock, within 8 inch



1823d_c2435bdb-6471-4a3b-8f5b-2755123d82bf_d6e66fc7-c2a3-4ae1-a821-d9494e359c22_P11.jpg,
00:00:14, 3.45

Infiltration Stain from 12 o'clock to 12 o'clock, within 8 inch



Node Pictures - 8/14/2023 - 1823

Date 8/14/2023	Manhole Number 1823	City Georgetown	Street 301-369 South Fraser	Surveyed By Matthew Headrick
-------------------	------------------------	--------------------	--------------------------------	---------------------------------



1823d_c2435bdb-6471-4a3b-8f5b-2755123d82bf_4fbed3c0-fe61-4052-b7b0-54b3f722a6e9_P11.jpg,
00:00:14, 3.50
Missing Mortar Large from 12 o'clock to 12 o'clock



1823d_c2435bdb-6471-4a3b-8f5b-2755123d82bf_13f7f9e5-b29d-4219-b01c-6b84ab9916f3_P11.jpg,
00:00:15, 4.04
Infiltration Weeper from 11 o'clock to 1 o'clock, within 8 inch



Node Pictures - 8/14/2023 - 1823

Date 8/14/2023	Manhole Number 1823	City Georgetown	Street 301-369 South Fraser	Surveyed By Matthew Headrick
-------------------	------------------------	--------------------	--------------------------------	---------------------------------



1823d_c2435bdb-6471-4a3b-8f5b-2755123d82bf_b0f872e0-40b7-4b28-929d-b62788bbfa20_P11.jpg,
00:00:15, 4.37
Infiltration Weeper from 6 o'clock to 7 o'clock, within 8 inch



1823d_c2435bdb-6471-4a3b-8f5b-2755123d82bf_7b3163da-1179-4d08-8a3e-afb833ffb71f_P11.jpg,
00:00:15, 4.37
Deposits Settled Gravel, 15% of cross sectional area from 8 o'clock to 12 o'clock, within 8 inch



Node Drawings - 8/14/2023 - 1823

Date 8/14/2023	Manhole Number 1823	City Georgetown	Street 301-369 South Fraser	Surveyed By Matthew Headrick
-------------------	------------------------	--------------------	--------------------------------	---------------------------------

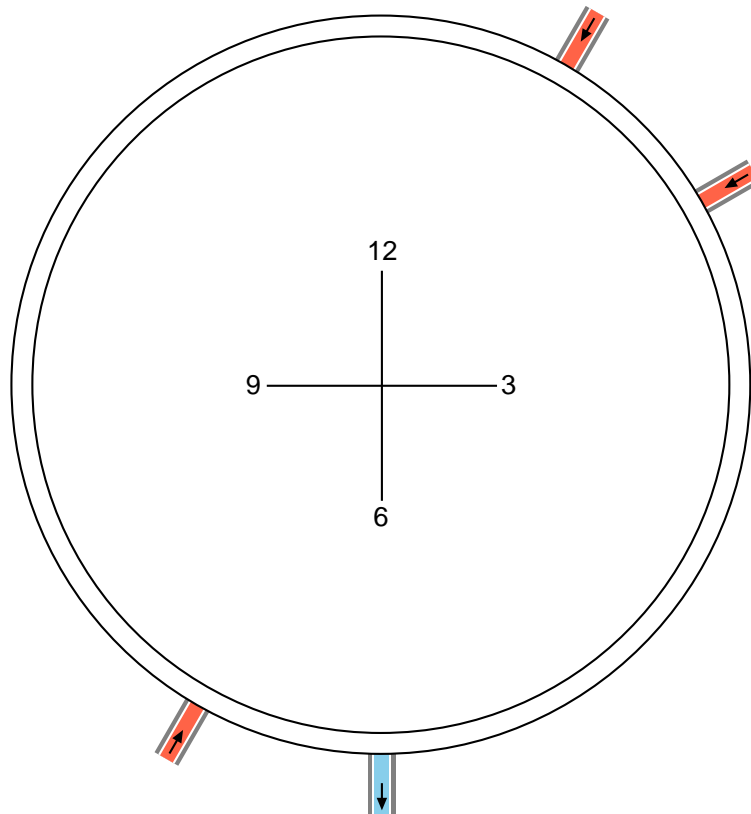
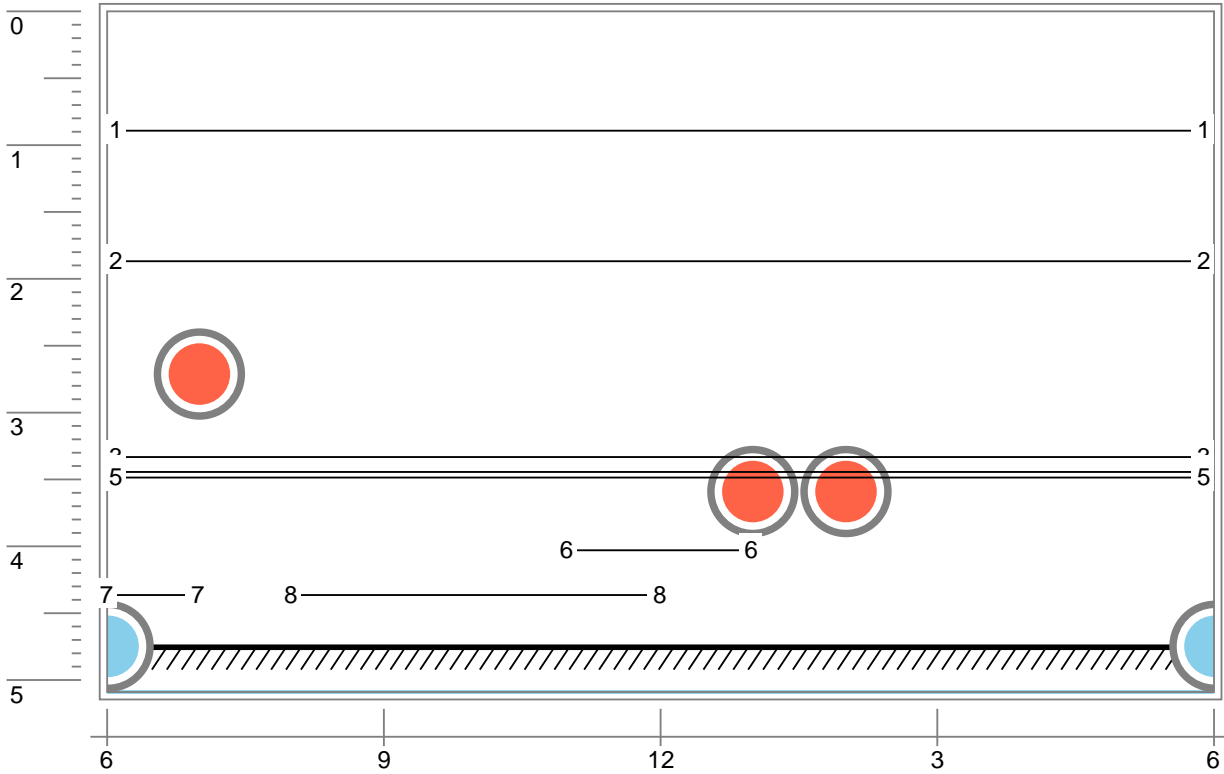



CleverScan - 8/14/2023 - 1823

Date 8/14/2023	Manhole Number 1823	City Georgetown	Street 301-369 South Fraser Street	Surveyed By Matthew Headrick
-------------------	------------------------	--------------------	---------------------------------------	---------------------------------

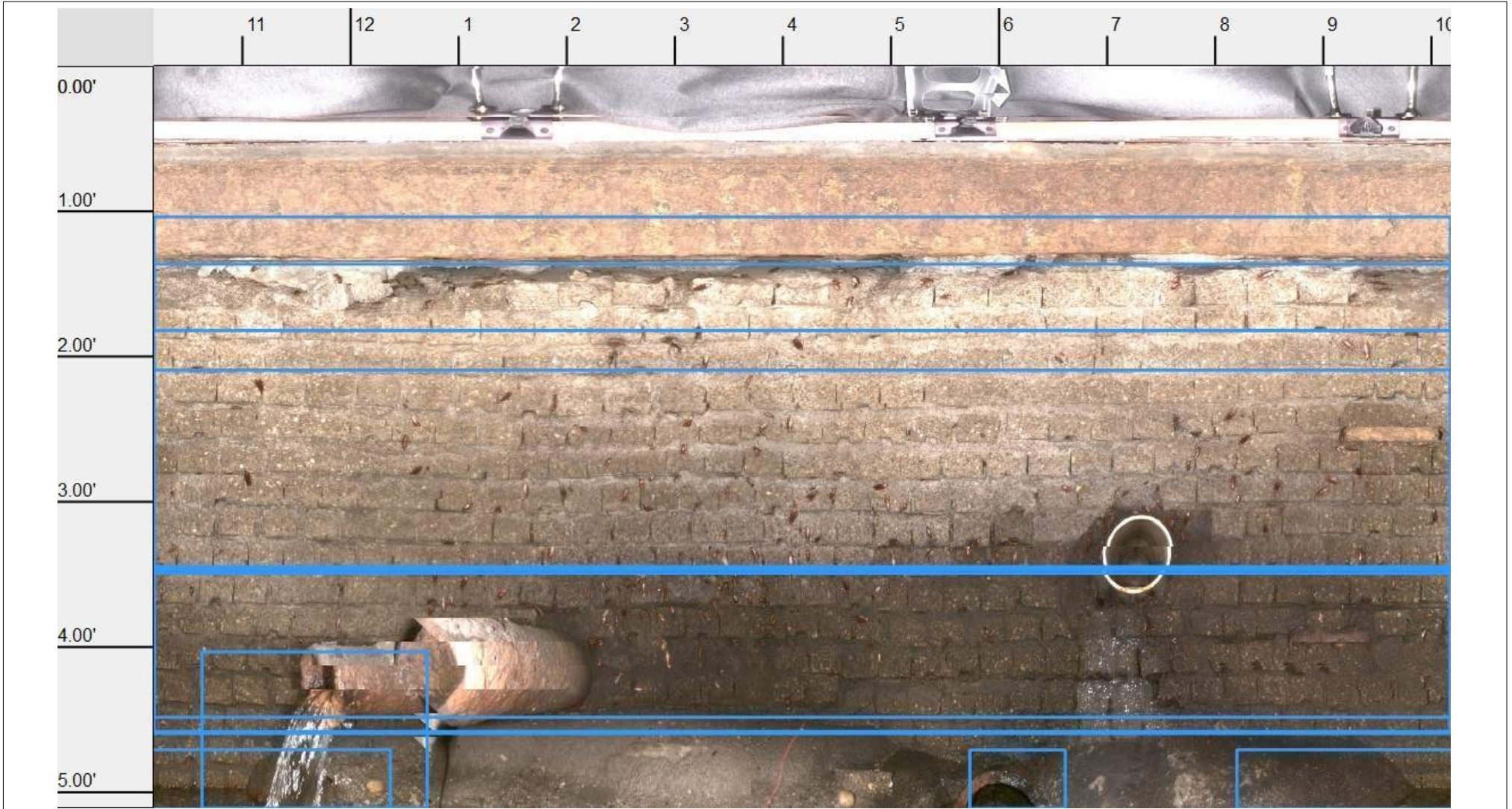



Node Inspection - 8/9/2023 - 1833

Date 8/9/2023	Time 12:02	Manhole Number 1833	Access Type Manhole	City Georgetown	Street 408-422 South Fraser
Surveyed By Matthew Headrick	Certificate Number U-0419-07030528	PO Number	Work Order	Pre-Cleaning No Pre-Cleaning	Sheet Number

General Manhole Information

MH Use Sanitary	Year Constructed	Year Renewed	Owner City of Georgetown
Rim to Invert 8.1'	Grade to Invert 8.1'	Rim to Grade 0.0'	Rim to Grade Exposed 0.0'
Surface Type Asphalt			
Location Code Light Highway	Location Details		
Additional component information			

General Manhole Inspection Information

Date Cleaned	Inspection Level Level 2	Consequence of Failure
Customer	Evidence Surcharge No	Purpose Routine assessment
Reviewed By Juan Bedoya	Reviewer Certificate U-1020-70400280	Weather Dry
Is Imperial No	Inspection Status Remote Inspection	Media Label WinCan 14.0
Potential for RunOff None		

Cover

Cover Type Solid					
Cover Shape Circular	Cover Size 23.5"	Center Cover Size	Cover Width		
Cover Material Cast Iron	Hole Diameter	Hole Number 0			
Cover Frame fit Good	Cover Bearing Surface Diameter 23.0"	Cover Bearing Surface Width			
Cover Condition Sound					

Cover Insert

Cover Insert Type None	Insert Condition
----------------------------------	------------------

Frame

Frame Material Cast Iron	Frame Bearing Surface Width 0.5"	Frame Bearing Surface Depth 1.0"
Frame Seal Inflow None	Frame Clear Open Diameter 22.0"	Frame Clear Open Width
Frame Depth 7.5"	Frame Offset Distance 0.0"	
Frame Condition Corroded		
Seal Condition Sound		

Chimney

Chimney Present Yes	Chimney Material 1 Brick	Chimney Material 2
Chimney Clear Opening 23.1"	Chimney Depth 3.2'	Chimney Infiltration None
Chimney Condition Sound	Chimney Lining Interior None	Chimney Lining Exterior Not Known

Cone

Cone Type Conical centered	Cone Material Brick	Cone Depth 4.7'
Cone Condition Sound	Cone Lining Interior None	Cone Lining Exterior Not Known

Wall

Wall Material Brick	Wall Diameter 50.4"	Wall By Size 50.4"	Wall Depth 7.1'
Wall Condition Sound	Wall Lining Exterior Not Known	Wall Lining Interior None	

Bench

Bench Condition Sound	Bench Present Yes	Bench Material Brick	Bench Lining None
---------------------------------	-----------------------------	--------------------------------	-----------------------------

QSR	QMR	QOR	SPR	MPR	OPR	SPRI	MPRI	OPRI
4414	4116	451A	20.0	10.0	30.0	2.5	1.4	2.0



Node Inspection - 8/9/2023 - 1833

Date 8/9/2023	Time 12:02	Manhole Number 1833	Access Type Manhole	City Georgetown	Street 408-422 South Fraser
Surveyed By Matthew Headrick	Certificate Number U-0419-07030528	PO Number	Work Order	Pre-Cleaning No Pre-Cleaning	Sheet Number

Channel

Channel Installed	Yes	Channel Material	Vitrified Clay	Channel Type	Formed
Channel Condition	Sound	Channel Exposure	Fully Opened		

Observations

Nr.	Distance	MACP Code	Observation	Remark
1	1.7'	MML	Missing Mortar Large from 4 o'clock to 3 o'clock	exposed bricks with gaps
2	3.5'	MML	Missing Mortar Large from 12 o'clock to 12 o'clock	fully exposed bricks with gaps
3	5.7'	MML	Missing Mortar Large from 12 o'clock to 12 o'clock	fully exposed bricks with gaps
4	7.0'	IS	Infiltration Stain from 6 o'clock to 11 o'clock, within 8 inch	inf stains on bench from wall
5	7.4'	MML	Missing Mortar Large from 6 o'clock to 10 o'clock	fully exposed bricks bench
6	7.5'	DSF	Deposits Settled Fine, 45% of cross sectional area from 12 o'clock to 12 o'clock, within 8 inch	settlement in channel

Connections

Pipe Number	Rim To Invert	Direction	Clock Position	Shape	Material	Height	Width	Pipe Condition	Seal Condition	Pipe Type	Structure ID	Comments
1	8.1'	Out	6	Circular	Vitrified Clay Pipe	12"	-	Sound	Sound	Gravity Connection		
2	5.9'	In	9	Circular	Vitrified Clay Pipe	8"	-	Sound	Sound	Gravity Connection		
3	8.1'	In	12	Circular	Vitrified Clay Pipe	12"	-	Sound	Sound	Gravity Connection		

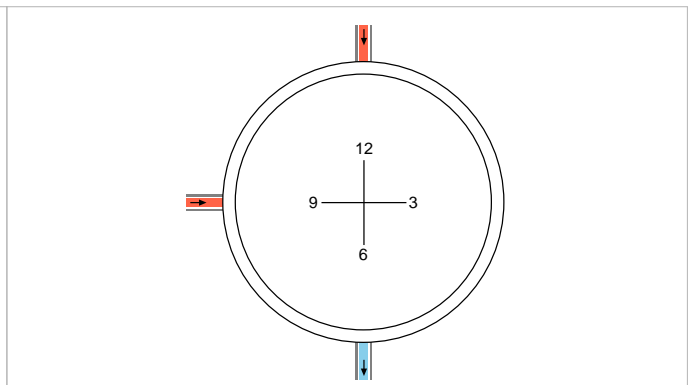
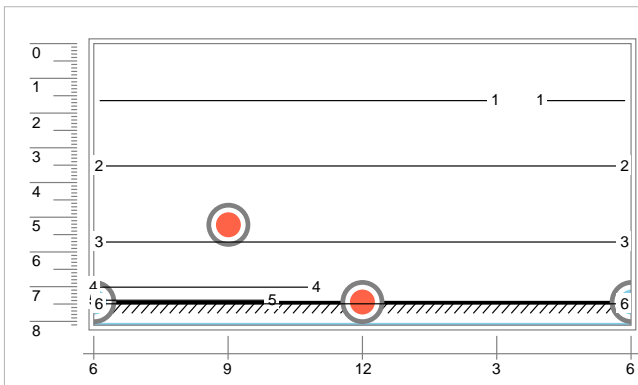

QSR	QMR	QOR	SPR	MPR	OPR	SPRI	MPRI	OPRI
4414	4116	451A	20.0	10.0	30.0	2.5	1.4	2.0



Node 2D Sketch - 8/9/2023 - 1833

Date 8/9/2023	Manhole Number 1833	City Georgetown	Street 408-422 South Fraser	Surveyed By Matthew Headrick
------------------	------------------------	--------------------	--------------------------------	---------------------------------

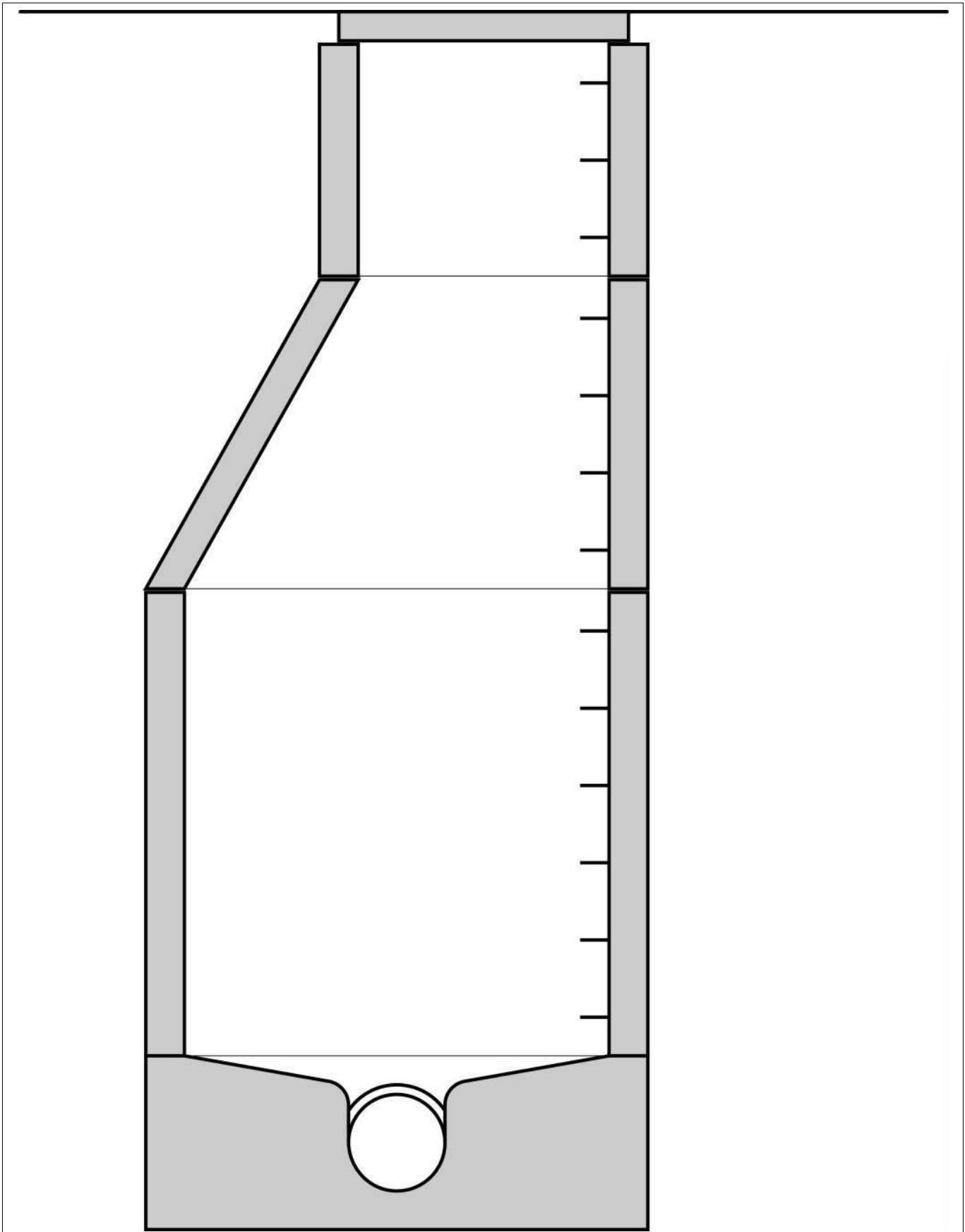



Node Pictures - 8/9/2023 - 1833

Date 8/9/2023	Manhole Number 1833	City Georgetown	Street 408-422 South Fraser	Surveyed By Matthew Headrick
------------------	------------------------	--------------------	--------------------------------	---------------------------------



1833a_415896af-f5e7-4861-970c-902a07ead962_e490ae15-1014-4918-bd9c-91c581413cf2_P11.jpg,
1.65
Missing Mortar Large from 4 o'clock to 3 o'clock



1833a_415896af-f5e7-4861-970c-902a07ead962_4fdf478f-d238-4325-aa4c-e1c799d57fa0_P11.jpg,
00:00:19, 3.55
Missing Mortar Large from 12 o'clock to 12 o'clock



Node Pictures - 8/9/2023 - 1833

Date 8/9/2023	Manhole Number 1833	City Georgetown	Street 408-422 South Fraser	Surveyed By Matthew Headrick
------------------	------------------------	--------------------	--------------------------------	---------------------------------



1833a_415896af-f5e7-4861-970c-902a07ead962_ea4a1f46-26fb-4252-8332-37380d041f3c_P11.jpg,
00:00:27, 5.72
Missing Mortar Large from 12 o'clock to 12 o'clock



1833a_415896af-f5e7-4861-970c-902a07ead962_d9ee26c7-bdf7-4ce9-802e-334e49f7b47d_P11.jpg,
00:00:32, 7.02
Infiltration Stain from 6 o'clock to 11 o'clock, within 8 inch



Node Pictures - 8/9/2023 - 1833

Date 8/9/2023	Manhole Number 1833	City Georgetown	Street 408-422 South Fraser	Surveyed By Matthew Headrick
------------------	------------------------	--------------------	--------------------------------	---------------------------------



1833a_415896af-f5e7-4861-970c-902a07ead962_38c4850f-5e37-4e65-942c-3ee5629b147e_P11.jpg,
00:00:32, 7.40
Missing Mortar Large from 6 o'clock to 10 o'clock



1833a_415896af-f5e7-4861-970c-902a07ead962_67f78bf4-e94b-4f03-8b46-ec002a1f34f9_P11.jpg,
00:00:32, 7.50
Deposits Settled Fine, 45% of cross sectional area from 12 o'clock to 12 o'clock, within 8 inch



Node Drawings - 8/9/2023 - 1833

Date 8/9/2023	Manhole Number 1833	City Georgetown	Street 408-422 South Fraser	Surveyed By Matthew Headrick
------------------	------------------------	--------------------	--------------------------------	---------------------------------

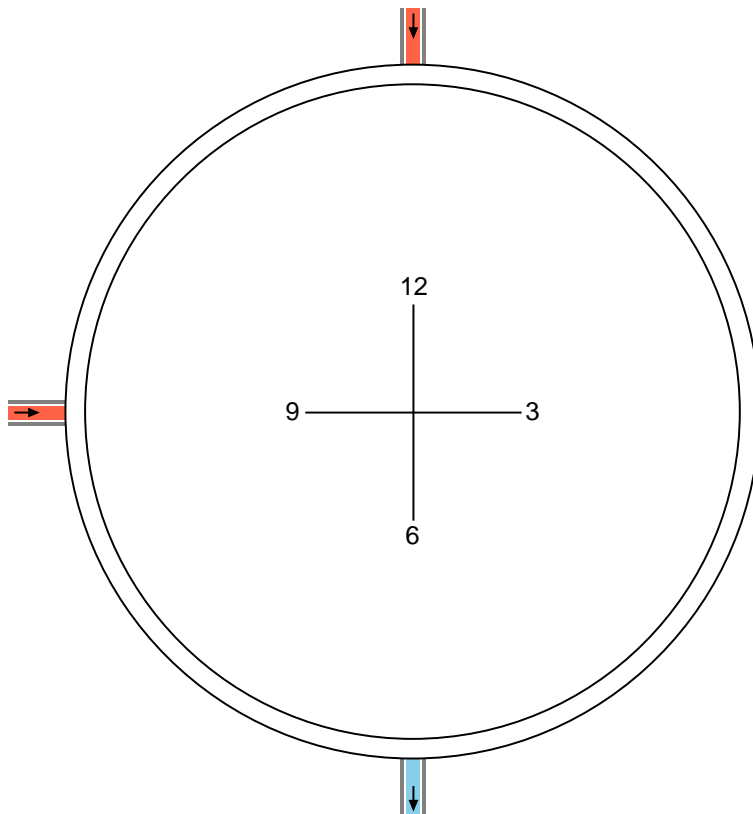
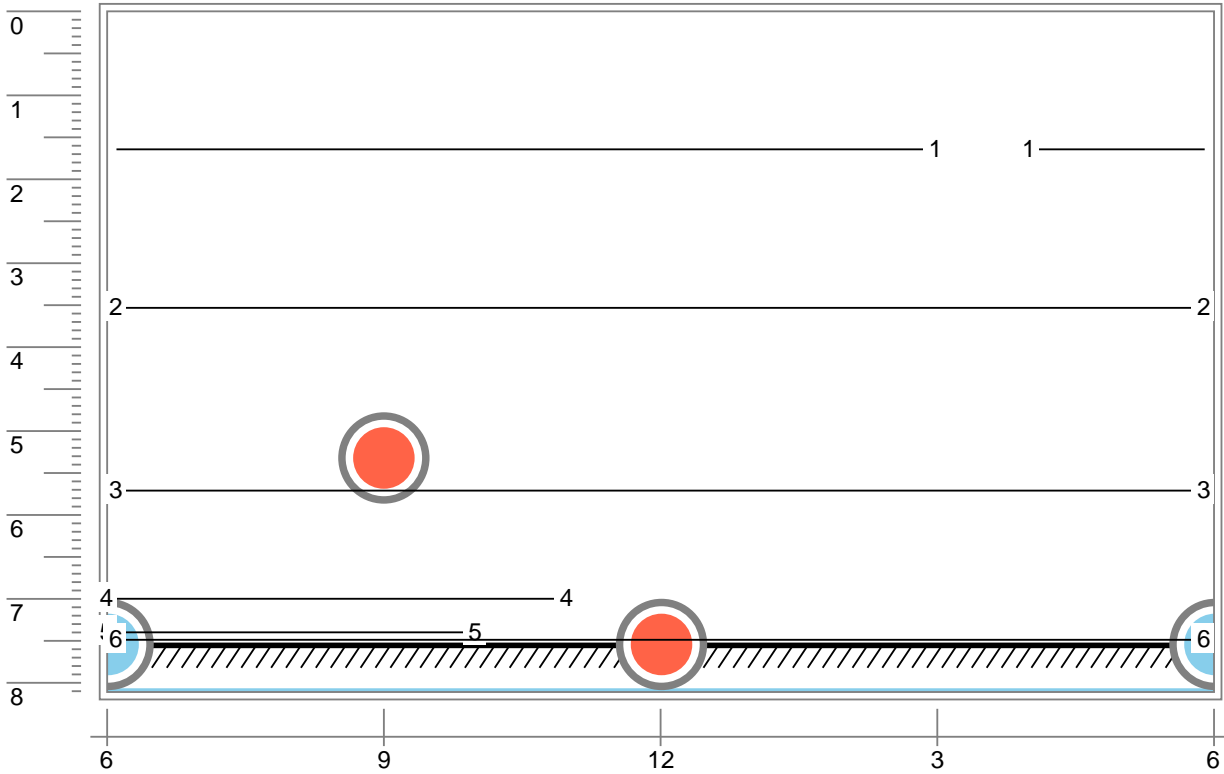



CleverScan - 8/9/2023 - 1833

Date 8/9/2023	Manhole Number 1833	City Georgetown	Street 408-422 South Fraser Street	Surveyed By Matthew Headrick
------------------	------------------------	--------------------	---------------------------------------	---------------------------------

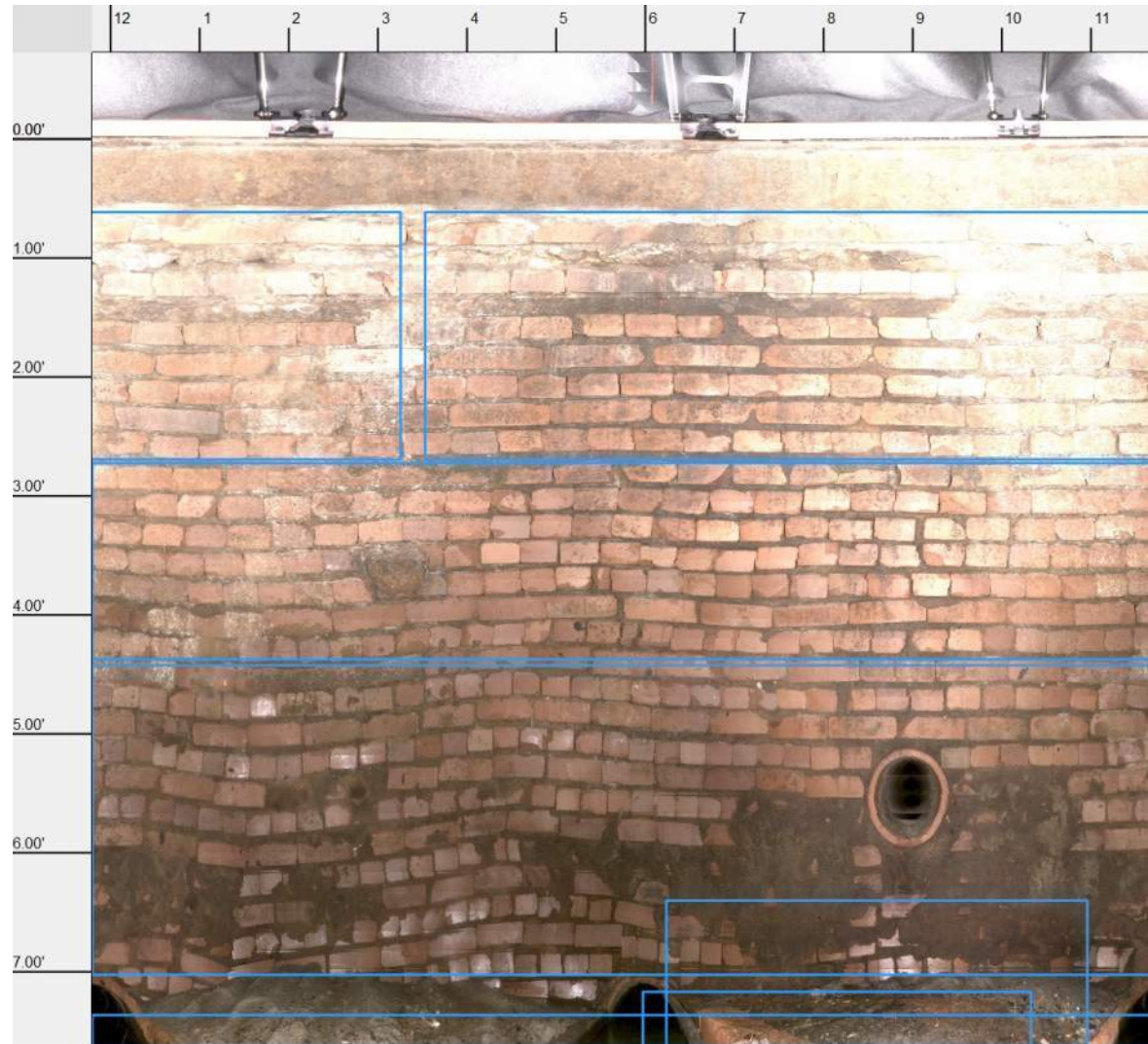



Node Inspection - 8/14/2023 - 1839

Date 8/14/2023	Time 9:43	Manhole Number 1839	Access Type Manhole	City Georgetown	Street 311 South Fraser
Surveyed By Matthew Headrick	Certificate Number U-0419-07030528	PO Number	Work Order	Pre-Cleaning No Pre-Cleaning	Sheet Number

General Manhole Information

MH Use Sanitary	Year Constructed	Year Renewed	Owner	City of Georgetown
Rim to Invert 10.3'	Grade to Invert 10.4'	Rim to Grade -1.0'	Rim to Grade Exposed	0.0'
Surface Type Asphalt				
Location Code Light Highway	Location Details			
Additional component information	Ponding manhole so sinking a bit on 6 o' clock			

General Manhole Inspection Information

Date Cleaned	Inspection Level Level 2	Consequence of Failure
Customer	Evidence Surcharge No	Purpose Routine assessment
Reviewed By Juan Bedoya	Reviewer Certificate U-1020-70400280	Weather Dry
Is Imperial No	Inspection Status Remote Inspection	Media Label WinCan 14.0
Potential for RunOff	Ponding	

Cover

Cover Type Solid					
Cover Shape Circular	Cover Size 23.5"	Center Cover Size	Cover Width		
Cover Material Cast Iron	Hole Diameter	Hole Number 0			
Cover Frame fit Good	Cover Bearing Surface Diameter 23.0"	Cover Bearing Surface Width			
Cover Condition Sound					

Cover Insert

Cover Insert Type None	Insert Condition
----------------------------------	------------------

Frame

Frame Material Cast Iron	Frame Bearing Surface Width 0.5"	Frame Bearing Surface Depth 1.0"
Frame Seal Inflow None	Frame Clear Open Diameter 22.0"	Frame Clear Open Width
Frame Depth 3.0"	Frame Offset Distance 0.0"	
Frame Condition Sound		
Seal Condition Missing		

Chimney

Chimney Present Yes	Chimney Material 1 Brick	Chimney Material 2
Chimney Clear Opening 23.2"	Chimney Depth 1.4'	Chimney Infiltration None
Chimney Condition Sound	Chimney Lining Interior None	Chimney Lining Exterior Not Known

Cone

Cone Type Conical centered	Cone Material Brick	Cone Depth 4.0'
Cone Condition Sound	Cone Lining Interior None	Cone Lining Exterior Not Known

Wall

Wall Material Brick	Wall Diameter 47.4"	Wall By Size 47.4"	Wall Depth 8.8'
Wall Condition Sound	Wall Lining Exterior Not Known	Wall Lining Interior None	

Bench

Bench Condition Sound	Bench Present Yes	Bench Material Concrete (cast in place)	Bench Lining None
---------------------------------	-----------------------------	---	-----------------------------

QSR	QMR	QOR	SPR	MPR	OPR	SPRI	MPRI	OPRI
4431	3123	4432	22.0	15.0	37.0	2.8	1.5	2.1



Node Inspection - 8/14/2023 - 1839

Date 8/14/2023	Time 9:43	Manhole Number 1839	Access Type Manhole	City Georgetown	Street 311 South Fraser
Surveyed By Matthew Headrick	Certificate Number U-0419-07030528	PO Number	Work Order	Pre-Cleaning No Pre-Cleaning	Sheet Number

Channel

Channel Installed	Yes	Channel Material	Vitrified Clay	Channel Type	Pipe
Channel Condition	Sound	Channel Exposure	Fully Opened		

Steps

Step Number	3	Step Material	Metal
-------------	----------	---------------	--------------

Observations

Nr.	Distance	MACP Code	Observation	Remark
1	0.8'	MB	Missing Brick from 3 o'clock to 6 o'clock	missing brick chimney frame join
2	1.0'	MML	Missing Mortar Large from 12 o'clock to 12 o'clock	fully exposed brickwork with gaps
3	2.3'	IS	Infiltration Stain from 12 o'clock to 12 o'clock, within 8 inch	infiltration stains
4	2.8'	MML	Missing Mortar Large from 12 o'clock to 12 o'clock	fully exposed brickwork with gaps
5	4.1'	DAR	Deposits Attached Ragging, 5% of cross sectional area from 8 o'clock to 12 o'clock, within 8 inch	rag on steps > evidence of surcharge condition
6	5.1'	IWC	Infiltration Weeper Connection from 9 o'clock to 11 o'clock, within 8 inch	infiltration at connection seal
7	6.3'	IW	Infiltration Weeper from 1 o'clock to 8 o'clock, within 8 inch	infiltration from bricks
8	6.8'	MML	Missing Mortar Large from 12 o'clock to 12 o'clock	fully exposed brickwork with gaps
9	9.1'	IWC	Infiltration Weeper Connection from 5 o'clock to 7 o'clock, within 8 inch	minor infiltration at connection

Connections

Pipe Number	Rim To Invert	Direction	Clock Position	Shape	Material	Height	Width	Pipe Condition	Seal Condition	Pipe Type	Structure ID	Comments
1	10.3'	Out	6	Circular	Vitrified Clay Pipe	12"	-	Sound	Sound	Gravity Connection		
2	4.7'	In	10	Circular	Vitrified Clay Pipe	6"	-	Sound	Sound	Gravity Connection		
3	10.3'	In	12	Circular	Vitrified Clay Pipe	12"	-	Sound	Sound	Gravity Connection		

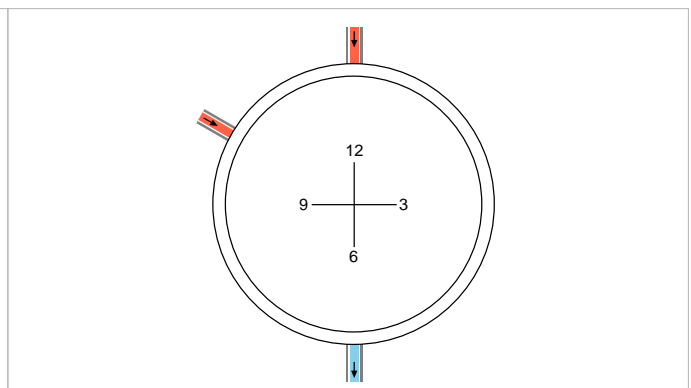
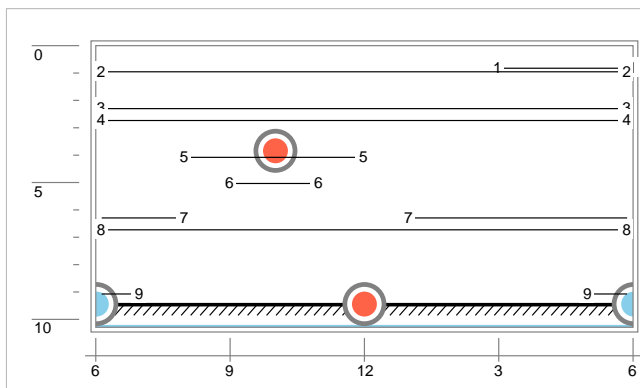

QSR	QMR	QOR	SPR	MPR	OPR	SPRI	MPRI	OPRI
4431	3123	4432	22.0	15.0	37.0	2.8	1.5	2.1



Node 2D Sketch - 8/14/2023 - 1839

Date 8/14/2023	Manhole Number 1839	City Georgetown	Street 311 South Fraser Street	Surveyed By Matthew Headrick
-------------------	------------------------	--------------------	-----------------------------------	---------------------------------

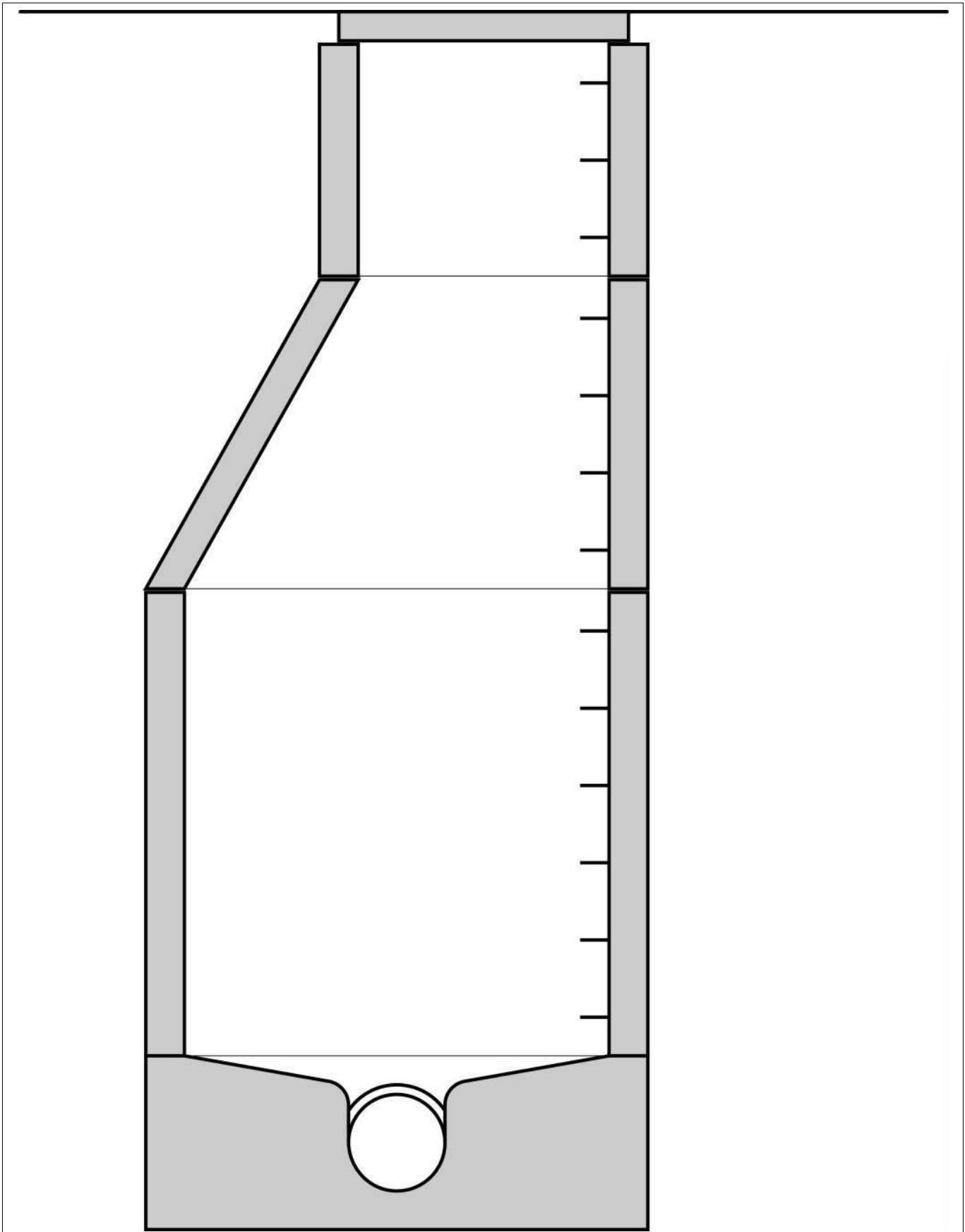



Node Pictures - 8/14/2023 - 1839

Date 8/14/2023	Manhole Number 1839	City Georgetown	Street 311 South Fraser Street	Surveyed By Matthew Headrick
-------------------	------------------------	--------------------	-----------------------------------	---------------------------------



1839_f7a2e778-f07c-460d-8979-384ad1d2d1b3_31e68735-8741-46f8-a0f5-72a580d3aa28_PI1.jpg,
00:00:09, 0.84
Missing Brick from 3 o'clock to 6 o'clock



1839_f7a2e778-f07c-460d-8979-384ad1d2d1b3_f10eed2a-ba9a-477d-b689-5f09c7740fe1_PI1.jpg,
, 0.99
Missing Mortar Large from 12 o'clock to 12 o'clock



Node Pictures - 8/14/2023 - 1839

Date 8/14/2023	Manhole Number 1839	City Georgetown	Street 311 South Fraser Street	Surveyed By Matthew Headrick
-------------------	------------------------	--------------------	-----------------------------------	---------------------------------



1839_f7a2e778-f07c-460d-8979-384ad1d2d1b3_ee7ac1aa-28e5-461c-bbd2-05e6ce6ef2a0_PI1.jpg,
00:00:15, 2.33
Infiltration Stain from 12 o'clock to 12 o'clock, within 8 inch



1839_f7a2e778-f07c-460d-8979-384ad1d2d1b3_2ceee7b3-5cb1-48fb-b1bd-03d0ef3fc47e_PI1.jpg,
00:00:17, 2.77
Missing Mortar Large from 12 o'clock to 12 o'clock



Node Pictures - 8/14/2023 - 1839

Date 8/14/2023	Manhole Number 1839	City Georgetown	Street 311 South Fraser Street	Surveyed By Matthew Headrick
-------------------	------------------------	--------------------	-----------------------------------	---------------------------------



1839_f7a2e778-f07c-460d-8979-384ad1d2d1b3_26e11d77-b5b6-47cb-ba13-ce6b8078be20_P11.jpg,
00:00:22, 4.10
Deposits Attached Ragging, 5% of cross sectional area from 8 o'clock to 12 o'clock, within 8 inch



1839_f7a2e778-f07c-460d-8979-384ad1d2d1b3_02e3030d-803b-4789-b031-fbff11776bf2_P11.jpg,
00:00:26, 5.08
Infiltration Weeper Connection from 9 o'clock to 11 o'clock, within 8 inch



Node Pictures - 8/14/2023 - 1839

Date 8/14/2023	Manhole Number 1839	City Georgetown	Street 311 South Fraser Street	Surveyed By Matthew Headrick
-------------------	------------------------	--------------------	-----------------------------------	---------------------------------



1839_f7a2e778-f07c-460d-8979-384ad1d2d1b3_ebbdf695-60e2-4b49-8316-3a0d50958fff_PI1.jpg,
00:00:31, 6.30
Infiltration Weeper from 1 o'clock to 8 o'clock, within 8 inch



1839_f7a2e778-f07c-460d-8979-384ad1d2d1b3_28c88a54-ab87-4373-9285-fc74b2411704_PI1.jpg,
00:00:33, 6.76
Missing Mortar Large from 12 o'clock to 12 o'clock



Node Pictures - 8/14/2023 - 1839

Date 8/14/2023	Manhole Number 1839	City Georgetown	Street 311 South Fraser Street	Surveyed By Matthew Headrick
-------------------	------------------------	--------------------	-----------------------------------	---------------------------------



1839_f7a2e778-f07c-460d-8979-384ad1d2d1b3_f0b0d505-39c7-45cf-a092-b070cc688200_PI1.jpg,
00:00:43, 9.11
Infiltration Weeper Connection from 5 o'clock to 7 o'clock, within 8 inch



Node Drawings - 8/14/2023 - 1839

Date 8/14/2023	Manhole Number 1839	City Georgetown	Street 311 South Fraser Street	Surveyed By Matthew Headrick
-------------------	------------------------	--------------------	-----------------------------------	---------------------------------

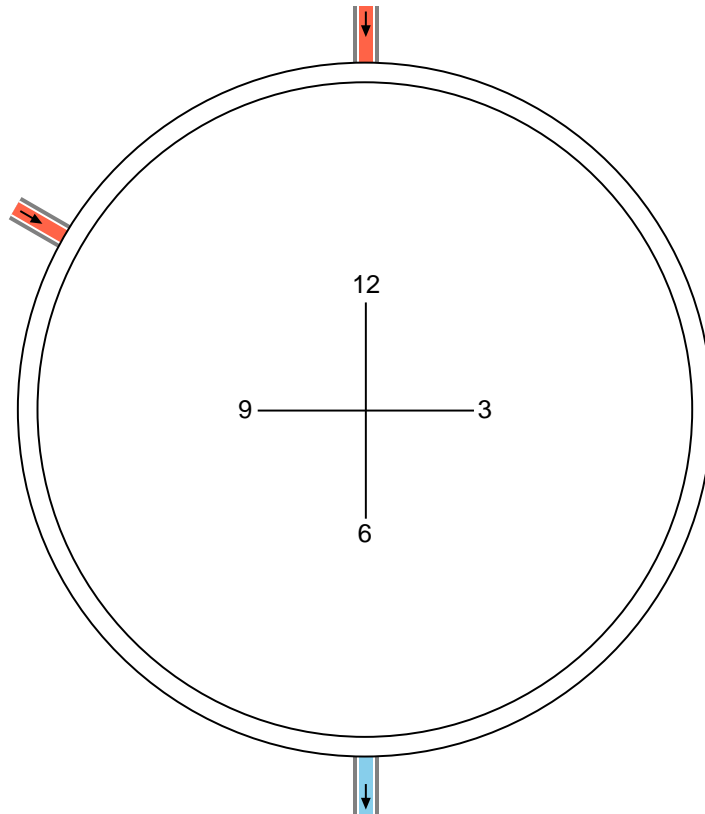
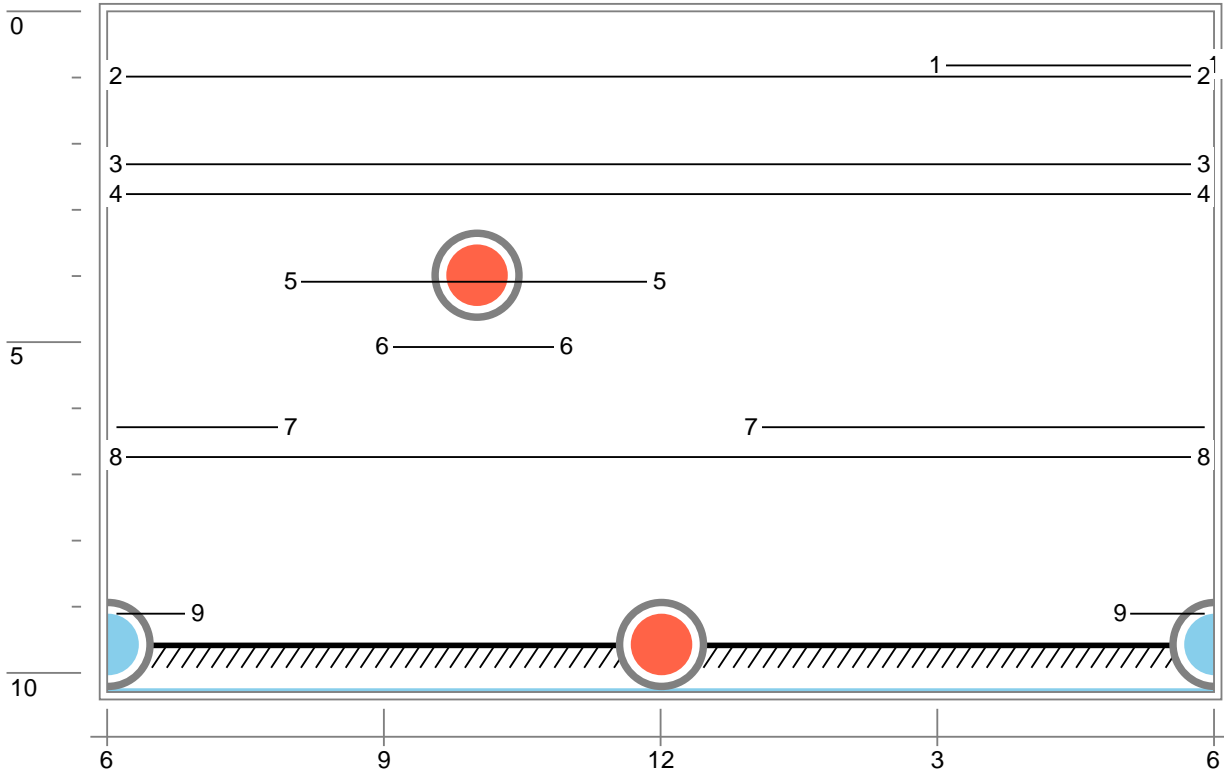



CleverScan - 8/14/2023 - 1839

Date 8/14/2023	Manhole Number 1839	City Georgetown	Street 311 South Fraser Street	Surveyed By Matthew Headrick
-------------------	------------------------	--------------------	-----------------------------------	---------------------------------

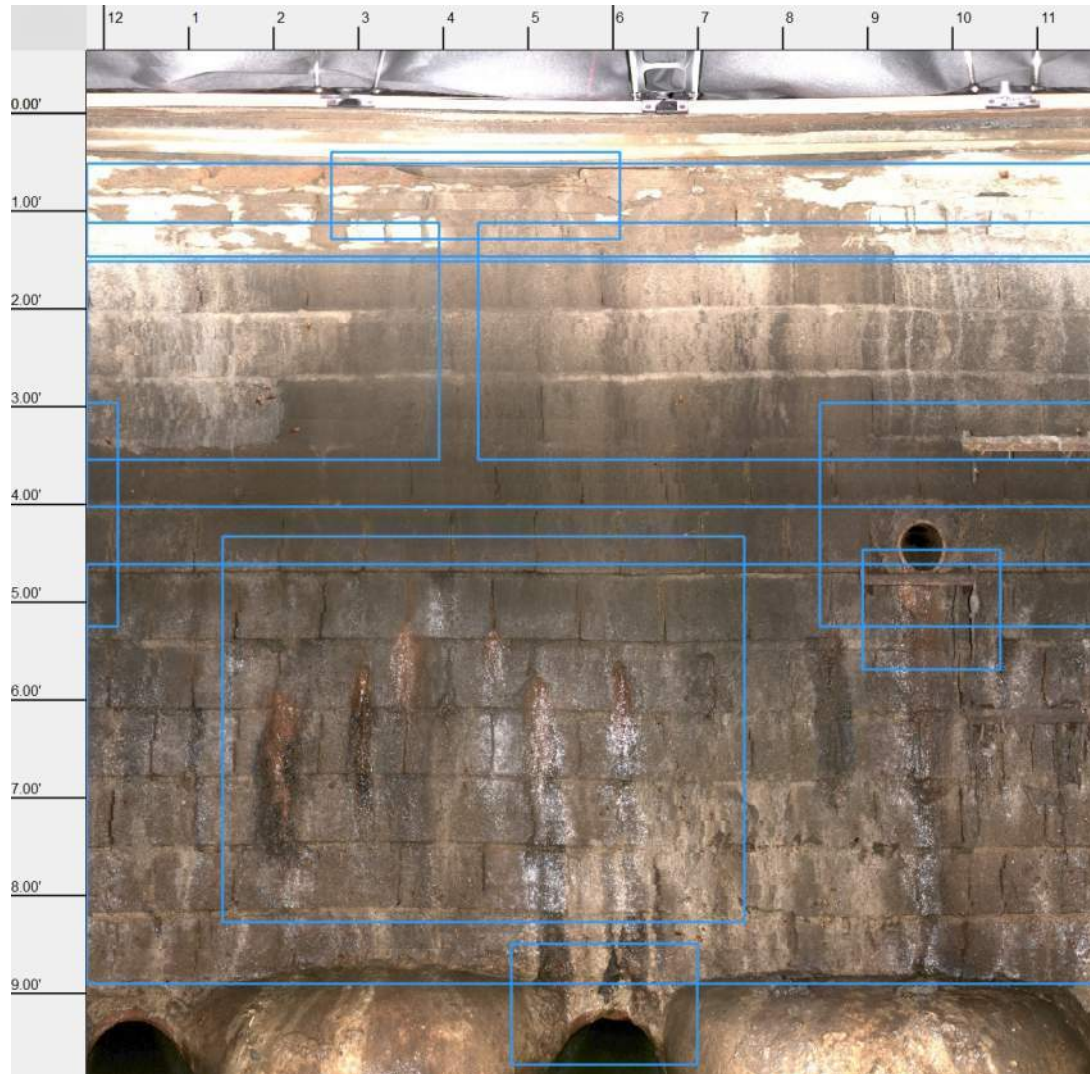



Node Inspection - 8/9/2023 - 1837

Date 8/9/2023	Time 12:02	Manhole Number 1837	Access Type Manhole	City Georgetown	Street 423 South Fraser
Surveyed By Matthew Headrick	Certificate Number U-0419-07030528	PO Number	Work Order	Pre-Cleaning No Pre-Cleaning	Sheet Number

General Manhole Information

MH Use Sanitary	Year Constructed	Year Renewed	Owner City of Georgetown
Rim to Invert 10.1'	Grade to Invert 9.9'	Rim to Grade 1.0'	Rim to Grade Exposed 1.0'
Surface Type Asphalt			
Location Code Light Highway	Location Details		
Additional component information	Look at chimney. Seems like it is sinking		

General Manhole Inspection Information

Date Cleaned	Inspection Level Level 2	Consequence of Failure
Customer	Evidence Surcharge No	Purpose Routine assessment
Reviewed By Juan Bedoya	Reviewer Certificate U-1020-70400280	Weather Dry
Is Imperial No	Inspection Status Remote Inspection	Media Label WinCan 14.0
Potential for RunOff	None	

Cover

Cover Type Solid					
Cover Shape Circular	Cover Size 23.5"	Center Cover Size	Cover Width		
Cover Material Cast Iron	Hole Diameter	Hole Number 0			
Cover Frame fit Good	Cover Bearing Surface Diameter 23.0"	Cover Bearing Surface Width			
Cover Condition Sound					

Cover Insert

Cover Insert Type None	Insert Condition
----------------------------------	------------------

Frame

Frame Material Cast Iron	Frame Bearing Surface Width 0.5"	Frame Bearing Surface Depth 1.0"
Frame Seal Inflow None	Frame Clear Open Diameter 22.0"	Frame Clear Open Width
Frame Depth 3.0"	Frame Offset Distance 0.0"	
Frame Condition Sound		
Seal Condition Missing		

Chimney

Chimney Present Yes	Chimney Material 1 Brick	Chimney Material 2
Chimney Clear Opening 25.0"	Chimney Depth 0.7'	Chimney Infiltration Infil Stained
Chimney Condition Sound	Chimney Lining Interior None	Chimney Lining Exterior Not Known

Cone

Cone Type Conical centered	Cone Material Brick	Cone Depth 3.4'
Cone Condition Sound	Cone Lining Interior None	Cone Lining Exterior Not Known

Wall

Wall Material Brick	Wall Diameter 48.0"	Wall By Size 48.0"	Wall Depth 8.4'
Wall Condition Sound	Wall Lining Exterior Not Known	Wall Lining Interior None	

Bench

Bench Condition Sound	Bench Present Yes	Bench Material Concrete (cast in place)	Bench Lining None
---------------------------------	-----------------------------	---	-----------------------------

QSR	QMR	QOR	SPR	MPR	OPR	SPRI	MPRI	OPRI
4332	3127	4333	23.0	22.0	45.0	2.6	1.7	2.0



Node Inspection - 8/9/2023 - 1837

Date 8/9/2023	Time 12:02	Manhole Number 1837	Access Type Manhole	City Georgetown	Street 423 South Fraser
Surveyed By Matthew Headrick	Certificate Number U-0419-07030528	PO Number	Work Order	Pre-Cleaning No Pre-Cleaning	Sheet Number

Channel

Channel Installed	Yes	Channel Material	Concrete (cast in place)	Channel Type	Formed
Channel Condition	Sound	Channel Exposure	Fully Opened		

Observations

Nr.	Distance	MACP Code	Observation	Remark
1	0.6'	MML	Missing Mortar Large from 12 o'clock to 12 o'clock	Fully exposed bricks with gaps
2	0.7'	DB	Displaced Brick from 6 o'clock to 8 o'clock	missing brick
3	1.1'	IS	Infiltration Stain from 12 o'clock to 12 o'clock, within 8 inch	inflow stains mat chimney cone join
4	2.1'	MML	Missing Mortar Large from 12 o'clock to 12 o'clock	fully exposed bricks with gaps
5	5.0'	DAR	Deposits Attached Ragging, 5% of cross sectional area from 7 o'clock to 10 o'clock, within 8 inch	rags on steps indicative of surcharged condition
6	5.3'	SAV	Surface Damage Aggregate Visible from 12 o'clock to 12 o'clock, within 8 inch	aggregate visible on concrete bricks/blocks
7	6.0'	MML	Missing Mortar Large from 12 o'clock to 12 o'clock	Fully exposed bricks with gaps
8	6.3'	IW	Infiltration Weeper from 10 o'clock to 11 o'clock, within 8 inch	minor inf from pipe seal
9	6.3'	IW	Infiltration Weeper from 5 o'clock to 6 o'clock, within 8 inch	minor inf at wall
10	8.5'	IW	Infiltration Weeper from 1 o'clock to 5 o'clock, within 8 inch	minor infiltration at bench wall join
11	8.6'	IW	Infiltration Weeper from 7 o'clock to 10 o'clock, within 8 inch	minor infiltration at bench wall join
12	8.9'	IW	Infiltration Weeper from 11 o'clock to 1 o'clock, within 8 inch	minor infiltration at pipe seal
13	8.9'	IW	Infiltration Weeper from 5 o'clock to 7 o'clock, within 8 inch	infiltration at pipe seal

Connections

Pipe Number	Rim To Invert	Direction	Clock Position	Shape	Material	Height	Width	Pipe Condition	Seal Condition	Pipe Type	Structure ID	Comments
1	10.1'	Out	6	Circular	Vitrified Clay Pipe	12"	-	Sound	Sound	Gravity Connection		
2	5.7'	In	10	Circular	Vitrified Clay Pipe	8"	-	Sound	Sound	Gravity Connection		
3	10.0'	In	12	Circular	Vitrified Clay Pipe	12"	-	Sound	Sound	Gravity Connection		

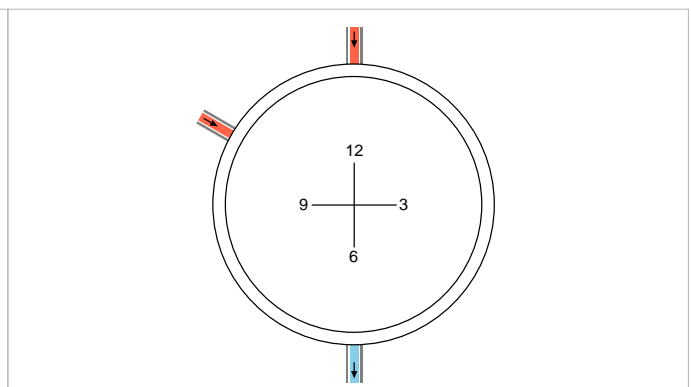
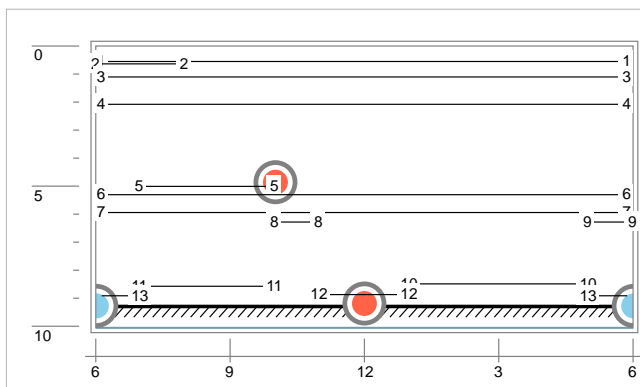

QSR	QMR	QOR	SPR	MPR	OPR	SPRI	MPRI	OPRI
4332	3127	4333	23.0	22.0	45.0	2.6	1.7	2.0



Node 2D Sketch - 8/9/2023 - 1837

Date 8/9/2023	Manhole Number 1837	City Georgetown	Street 423 South Fraser Street	Surveyed By Matthew Headrick
------------------	------------------------	--------------------	-----------------------------------	---------------------------------

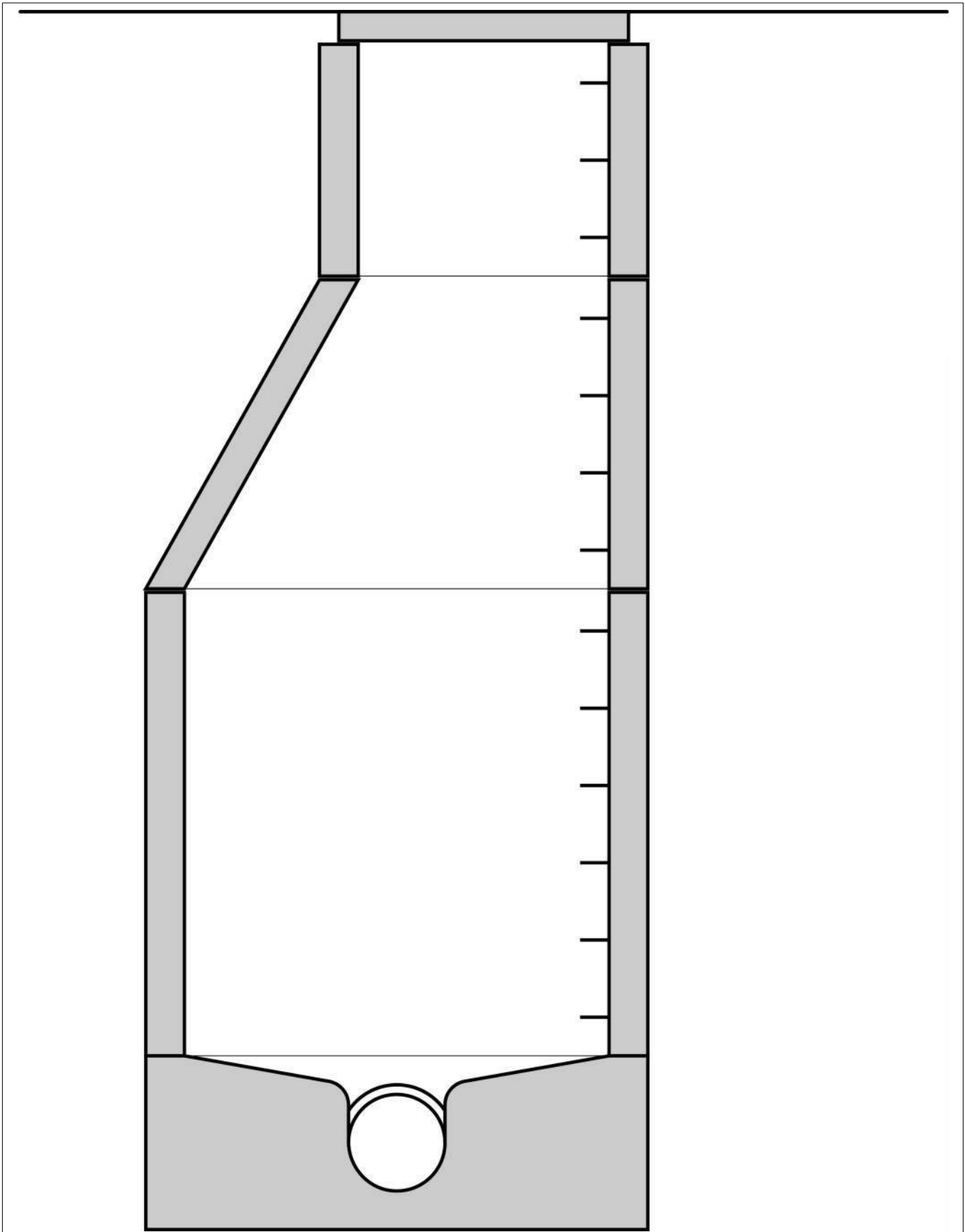



Node Pictures - 8/9/2023 - 1837

Date 8/9/2023	Manhole Number 1837	City Georgetown	Street 423 South Fraser Street	Surveyed By Matthew Headrick
------------------	------------------------	--------------------	-----------------------------------	---------------------------------



1837c_166883a2-6c9f-44dc-8d3b-993be20f6dc6_49d81684-3099-4e55-92f5-afd22f980810_P11.jpg,
00:00:07, 0.58
Missing Mortar Large from 12 o'clock to 12 o'clock



1837c_166883a2-6c9f-44dc-8d3b-993be20f6dc6_f4da2fc8-9b38-41b2-883b-1d13218a253a_P11.jpg,
00:00:00, 0.66
Displaced Brick from 6 o'clock to 8 o'clock



Node Pictures - 8/9/2023 - 1837

Date 8/9/2023	Manhole Number 1837	City Georgetown	Street 423 South Fraser Street	Surveyed By Matthew Headrick
------------------	------------------------	--------------------	-----------------------------------	---------------------------------



1837c_166883a2-6c9f-44dc-8d3b-993be20f6dc6_657e633f-e4e6-4faa-a090-0da65f01be06_P11.jpg,
00:00:09, 1.12
Infiltration Stain from 12 o'clock to 12 o'clock, within 8 inch



1837c_166883a2-6c9f-44dc-8d3b-993be20f6dc6_1649f046-1a82-498d-82e2-e1f4de576c6f_P11.jpg,
00:00:13, 2.11
Missing Mortar Large from 12 o'clock to 12 o'clock



Node Pictures - 8/9/2023 - 1837

Date 8/9/2023	Manhole Number 1837	City Georgetown	Street 423 South Fraser Street	Surveyed By Matthew Headrick
------------------	------------------------	--------------------	-----------------------------------	---------------------------------



1837c_166883a2-6c9f-44dc-8d3b-993be20f6dc6_9705dbdb-6ee7-4b05-98c9-4de012303572_P11.jpg,
00:00:23, 5.04
Deposits Attached Ragging, 5% of cross sectional area from 7 o'clock to 10 o'clock, within 8 inch

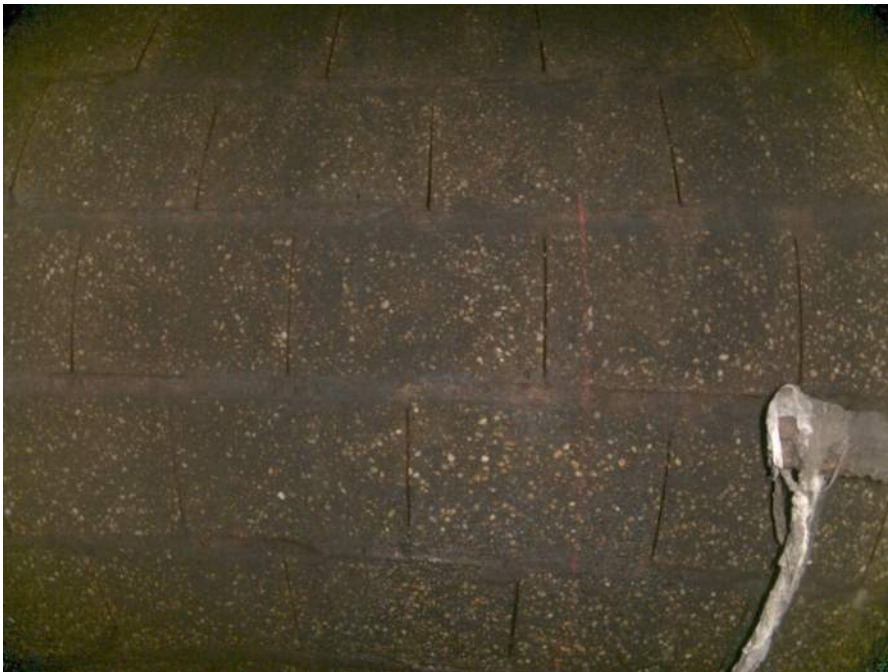

1837c_166883a2-6c9f-44dc-8d3b-993be20f6dc6_4d36e8db-8df6-4395-8a4c-10e185c12b95_P11.jpg,
00:00:24, 5.31
Surface Damage Aggregate Visible from 12 o'clock to 12 o'clock, within 8 inch



Node Pictures - 8/9/2023 - 1837

Date 8/9/2023	Manhole Number 1837	City Georgetown	Street 423 South Fraser Street	Surveyed By Matthew Headrick
------------------	------------------------	--------------------	-----------------------------------	---------------------------------



1837c_166883a2-6c9f-44dc-8d3b-993be20f6dc6_17940cd5-8d60-4c09-a955-64962a677a23_P11.jpg,
00:00:27, 5.97
Missing Mortar Large from 12 o'clock to 12 o'clock



1837c_166883a2-6c9f-44dc-8d3b-993be20f6dc6_18e86ff1-c566-4871-a18d-85e9d3777971_P11.jpg,
00:00:29, 6.29
Infiltration Weeper from 10 o'clock to 11 o'clock, within 8 inch



Node Pictures - 8/9/2023 - 1837

Date 8/9/2023	Manhole Number 1837	City Georgetown	Street 423 South Fraser Street	Surveyed By Matthew Headrick
------------------	------------------------	--------------------	-----------------------------------	---------------------------------



1837c_166883a2-6c9f-44dc-8d3b-993be20f6dc6_6c594d86-7c73-4195-9bc9-07d1a28f67d3_P11.jpg,
00:00:29, 6.32
Infiltration Weeper from 5 o'clock to 6 o'clock, within 8 inch



1837c_166883a2-6c9f-44dc-8d3b-993be20f6dc6_8f20deb1-cfa1-4303-84b8-4d47adbe017c_P11.jpg,
00:00:37, 8.51
Infiltration Weeper from 1 o'clock to 5 o'clock, within 8 inch



Node Pictures - 8/9/2023 - 1837

Date 8/9/2023	Manhole Number 1837	City Georgetown	Street 423 South Fraser Street	Surveyed By Matthew Headrick
------------------	------------------------	--------------------	-----------------------------------	---------------------------------



1837c_166883a2-6c9f-44dc-8d3b-993be20f6dc6_fe294033-28b6-44f4-8a38-8d327567a80b_P11.jpg,
00:00:37, 8.60
Infiltration Weeper from 7 o'clock to 10 o'clock, within 8 inch



1837c_166883a2-6c9f-44dc-8d3b-993be20f6dc6_531288a5-3195-4292-88f6-c4597b920581_P11.jpg,
00:00:37, 8.90
Infiltration Weeper from 11 o'clock to 1 o'clock, within 8 inch



Node Pictures - 8/9/2023 - 1837

Date 8/9/2023	Manhole Number 1837	City Georgetown	Street 423 South Fraser Street	Surveyed By Matthew Headrick
------------------	------------------------	--------------------	-----------------------------------	---------------------------------



1837c_166883a2-6c9f-44dc-8d3b-993be20f6dc6_eae99878-23a6-4d1a-bde4-6169661a4df4_P11.jpg,
00:00:37, 8.92
Infiltration Weeper from 5 o'clock to 7 o'clock, within 8 inch



Node Drawings - 8/9/2023 - 1837

Date 8/9/2023	Manhole Number 1837	City Georgetown	Street 423 South Fraser Street	Surveyed By Matthew Headrick
------------------	------------------------	--------------------	-----------------------------------	---------------------------------

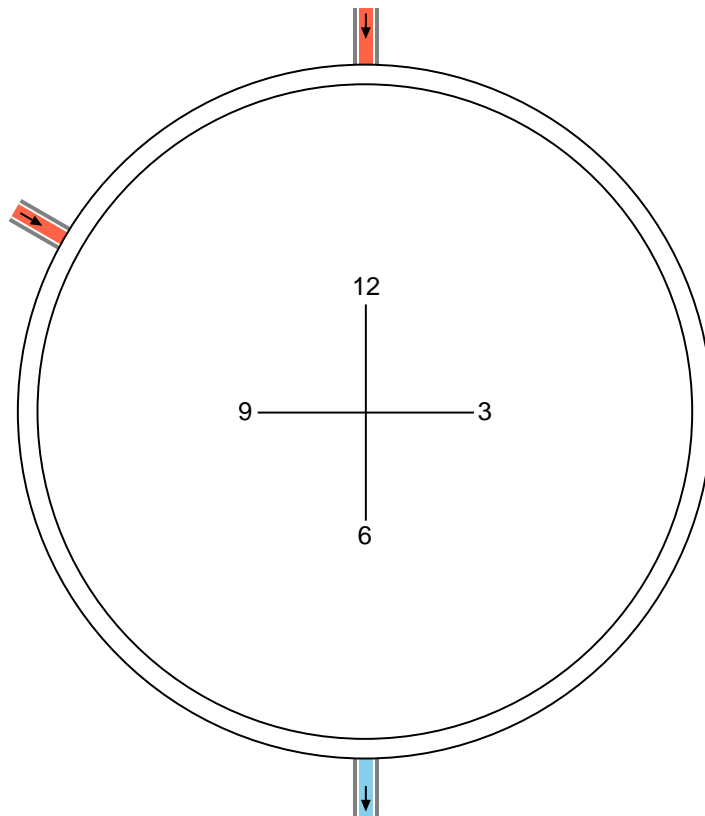
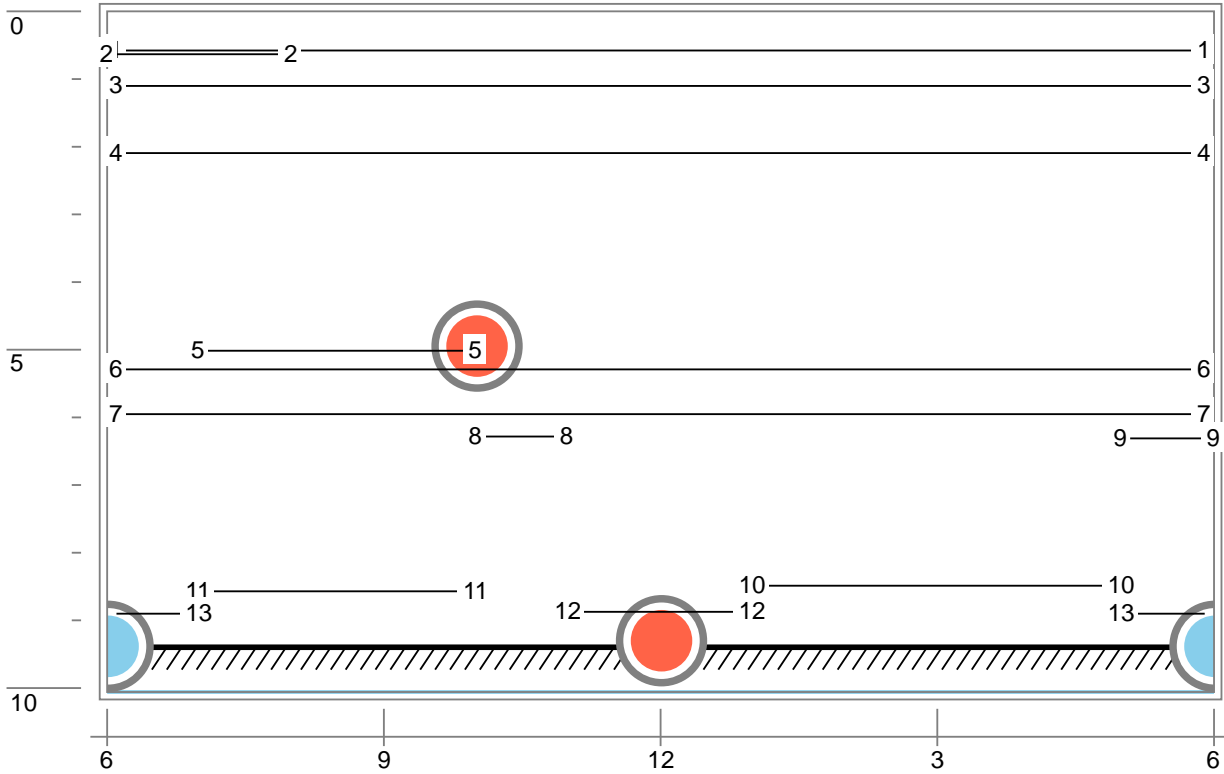



CleverScan - 8/9/2023 - 1837

Date 8/9/2023	Manhole Number 1837	City Georgetown	Street 423 South Fraser Street	Surveyed By Matthew Headrick
------------------	------------------------	--------------------	-----------------------------------	---------------------------------

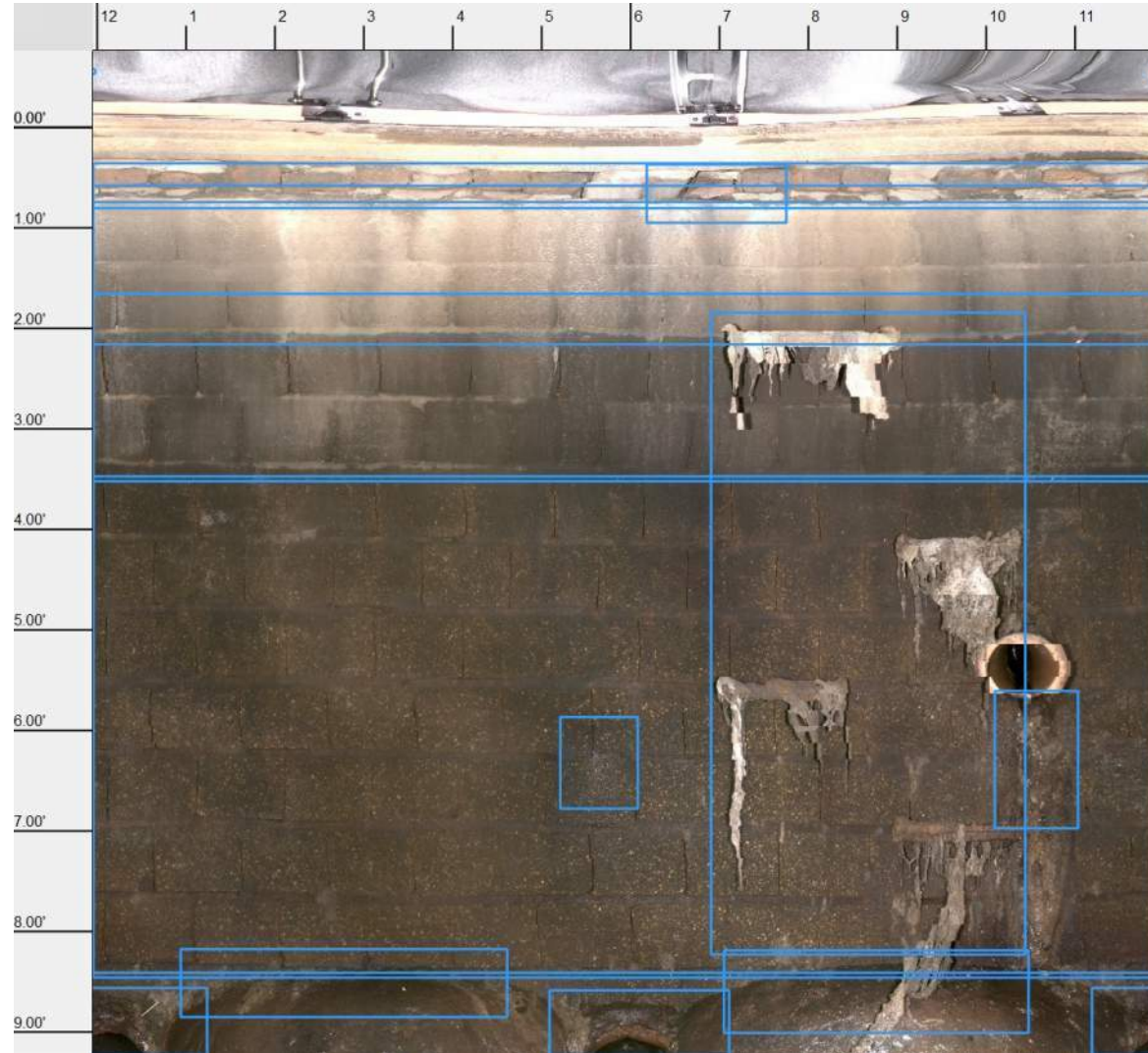



Node Inspection - 8/14/2023 - 1821

Date 8/14/2023	Time 12:38	Manhole Number 1821	Access Type Manhole	City Georgetown	Street 507 South Fraser
Surveyed By Matthew Headrick	Certificate Number U-0419-07030528	PO Number	Work Order	Pre-Cleaning No Pre-Cleaning	Sheet Number

General Manhole Information

MH Use Sanitary	Year Constructed	Year Renewed	Owner City of Georgetown
Rim to Invert 4.2'	Grade to Invert 4.2'	Rim to Grade 0.0'	Rim to Grade Exposed 0.0'
Surface Type Asphalt			
Location Code Light Highway	Location Details		
Additional component information			

General Manhole Inspection Information

Date Cleaned	Inspection Level Level 2	Consequence of Failure
Customer	Evidence Surcharge No	Purpose Routine assessment
Reviewed By Juan Bedoya	Reviewer Certificate U-1020-70400280	Weather Dry
Is Imperial No	Inspection Status Remote Inspection	Media Label WinCan 14.0
Potential for RunOff None		

Cover

Cover Type Solid					
Cover Shape Circular	Cover Size 23.5"	Center Cover Size	Cover Width		
Cover Material Cast Iron	Hole Diameter	Hole Number 0			
Cover Frame fit Good	Cover Bearing Surface Diameter 23.0"	Cover Bearing Surface Width			
Cover Condition Sound					

Cover Insert

Cover Insert Type None	Insert Condition
----------------------------------	------------------

Frame

Frame Material Cast Iron	Frame Bearing Surface Width 0.5"	Frame Bearing Surface Depth 1.0"
Frame Seal Inflow None	Frame Clear Open Diameter 22.0"	Frame Clear Open Width
Frame Depth 3.0"	Frame Offset Distance 0.0"	
Frame Condition Sound		
Seal Condition Sound		

Chimney

Chimney Present Yes	Chimney Material 1 Brick	Chimney Material 2
Chimney Clear Opening 21.6"	Chimney Depth 1.2'	Chimney Infiltration None
Chimney Condition Sound	Chimney Lining Interior None	Chimney Lining Exterior Not Known

Cone

Cone Type Conical centered	Cone Material Brick	Cone Depth 2.7'
Cone Condition Sound	Cone Lining Interior None	Cone Lining Exterior Not Known

Wall

Wall Material Brick	Wall Diameter 42.0"	Wall By Size 42.0"	Wall Depth 3.5'
Wall Condition Sound	Wall Lining Exterior Not Known	Wall Lining Interior None	

Bench

Bench Condition Sound	Bench Present Yes	Bench Material Not Known	Bench Lining None
---------------------------------	-----------------------------	------------------------------------	-----------------------------

QSR	QMR	QOR	SPR	MPR	OPR	SPRI	MPRI	OPRI
4314	5115	5143	16.0	10.0	26.0	2.3	1.7	2.0



Node Inspection - 8/14/2023 - 1821

Date 8/14/2023	Time 12:38	Manhole Number 1821	Access Type Manhole	City Georgetown	Street 507 South Fraser
Surveyed By Matthew Headrick	Certificate Number U-0419-07030528	PO Number	Work Order	Pre-Cleaning No Pre-Cleaning	Sheet Number

Channel

Channel Installed	Yes	Channel Material	Not Known	Channel Type	Formed
Channel Condition	Sound	Channel Exposure	Fully Opened		

Observations

Nr.	Distance	MACP Code	Observation	Remark
1	0.8'	MML	Missing Mortar Large from 1 o'clock to 3 o'clock	Fully exposed brick with gaps
2	2.0'	MML	Missing Mortar Large from 12 o'clock to 12 o'clock	Fully exposed brick with gaps
3	3.0'	MML	Missing Mortar Large from 12 o'clock to 12 o'clock	Fully exposed brick with gaps
4	3.8'	OBN	Obstruction Construction Debris, 35% of cross sectional area from 12 o'clock to 12 o'clock	

Connections

Pipe Number	Rim To Invert	Direction	Clock Position	Shape	Material	Height	Width	Pipe Condition	Seal Condition	Pipe Type	Structure ID	Comments
1	4.2'	Out	6	Circular	Vitrified Clay Pipe	8"	-	Sound	Sound	Gravity Connection		
2	4.0'	In	12	Circular	Vitrified Clay Pipe	6"	-	Sound	Sound	Lateral to Building		
3	4.1'	In	1	Circular	Vitrified Clay Pipe	8"	-	Sound	Sound	Gravity Connection		

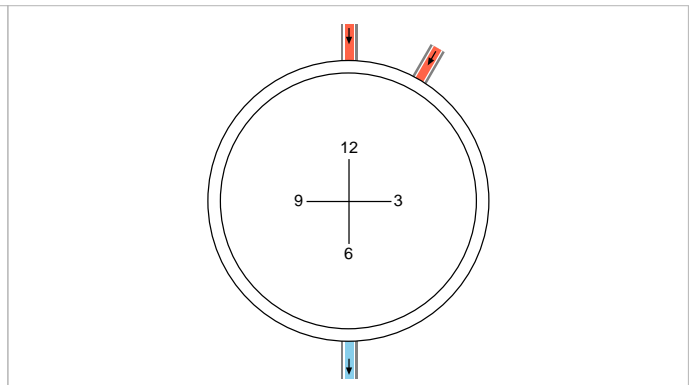
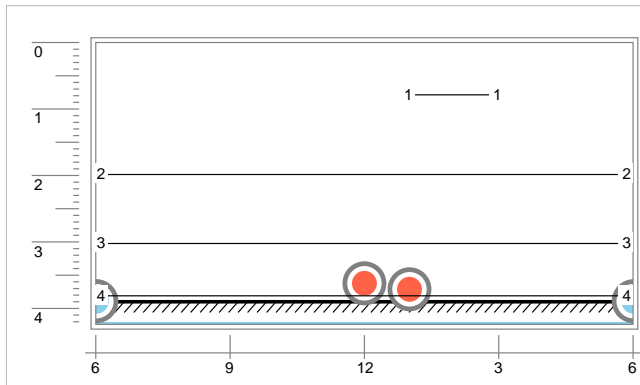

QSR	QMR	QOR	SPR	MPR	OPR	SPRI	MPRI	OPRI
4314	5115	5143	16.0	10.0	26.0	2.3	1.7	2.0



Node 2D Sketch - 8/14/2023 - 1821

Date 8/14/2023	Manhole Number 1821	City Georgetown	Street 507 South Fraser Street	Surveyed By Matthew Headrick
-------------------	------------------------	--------------------	-----------------------------------	---------------------------------

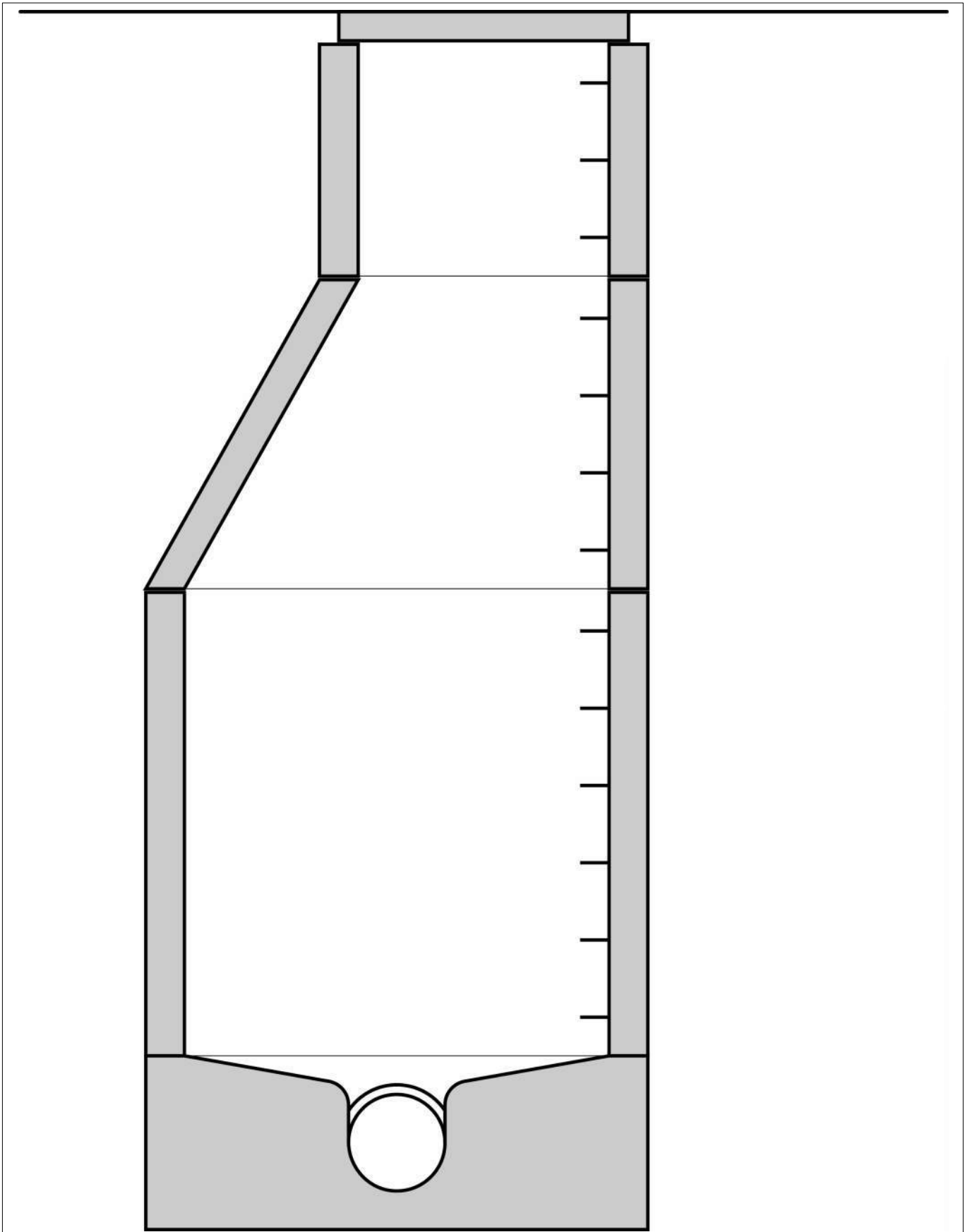



Node Pictures - 8/14/2023 - 1821

Date 8/14/2023	Manhole Number 1821	City Georgetown	Street 507 South Fraser Street	Surveyed By Matthew Headrick
-------------------	------------------------	--------------------	-----------------------------------	---------------------------------



1821_b79fd861-dd10-4846-a6c3-82d3d499c9c7_15c60b1e-ee94-4fb7-ac51-8482027d4423_P11.jpg,
, 0.80
Missing Mortar Large from 1 o'clock to 3 o'clock



1821_b79fd861-dd10-4846-a6c3-82d3d499c9c7_b8dbdadb-54ad-48eb-bc30-e877ffbcd1a4_P11.jpg,
00:00:13, 2.00
Missing Mortar Large from 12 o'clock to 12 o'clock



Node Pictures - 8/14/2023 - 1821

Date 8/14/2023	Manhole Number 1821	City Georgetown	Street 507 South Fraser Street	Surveyed By Matthew Headrick
-------------------	------------------------	--------------------	-----------------------------------	---------------------------------



1821_b79fd861-dd10-4846-a6c3-82d3d499c9c7_b7cfa781-f78c-4dad-bb28-9ce6c40f33d1_PI1.jpg,
00:00:16, 3.04
Missing Mortar Large from 12 o'clock to 12 o'clock



1821_b79fd861-dd10-4846-a6c3-82d3d499c9c7_0bc5d1de-e242-4391-b787-4bef6b28f7b0_PI1.jpg,
00:00:17, 3.83
Obstruction Construction Debris, 35% of cross sectional area from 12 o'clock to 12 o'clock



Node Drawings - 8/14/2023 - 1821

Date 8/14/2023	Manhole Number 1821	City Georgetown	Street 507 South Fraser Street	Surveyed By Matthew Headrick
-------------------	------------------------	--------------------	-----------------------------------	---------------------------------

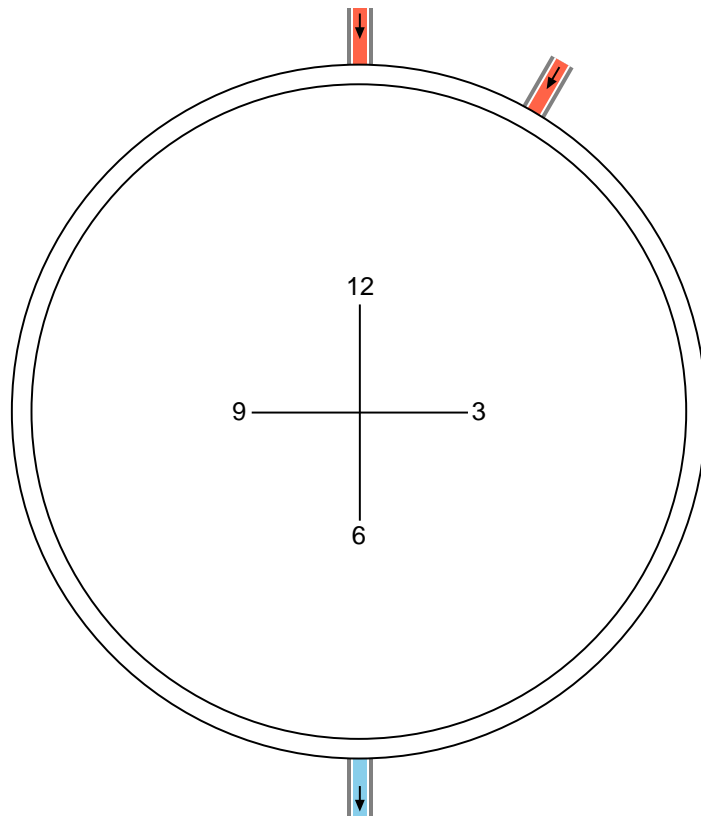
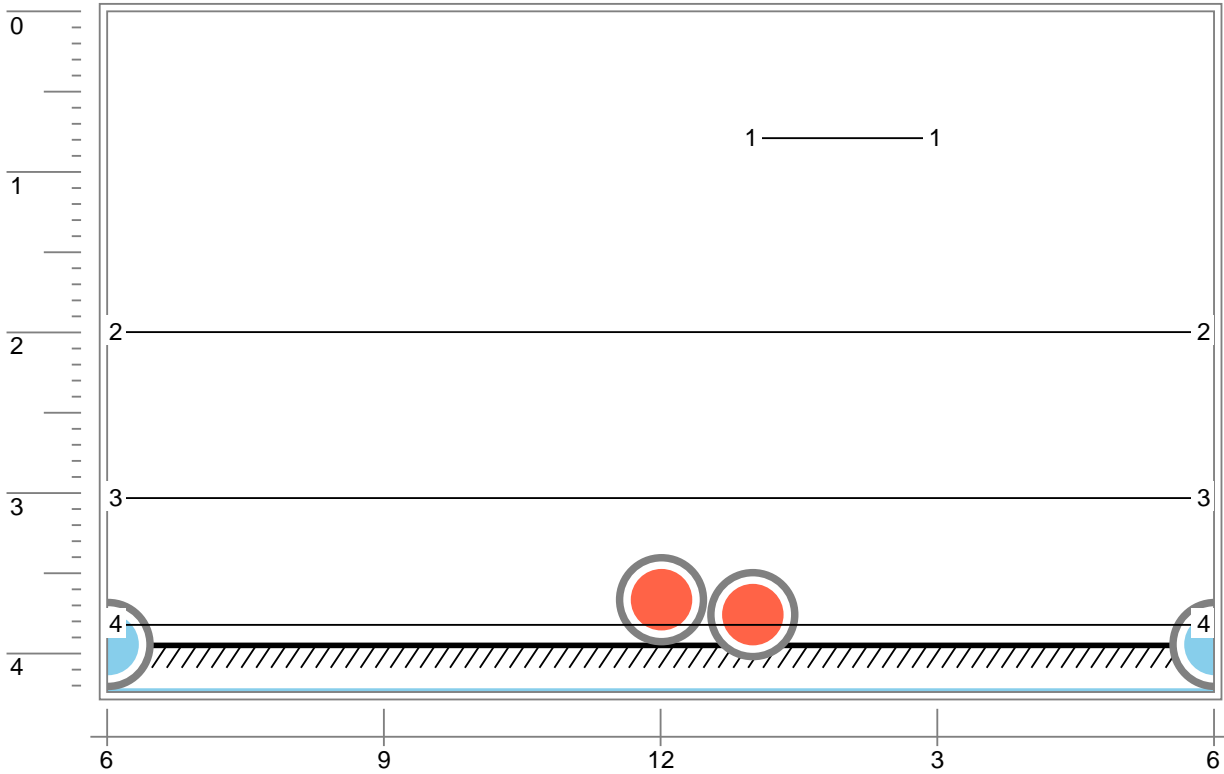



CleverScan - 8/14/2023 - 1821

Date 8/14/2023	Manhole Number 1821	City Georgetown	Street 507 South Fraser Street	Surveyed By Matthew Headrick
-------------------	------------------------	--------------------	-----------------------------------	---------------------------------

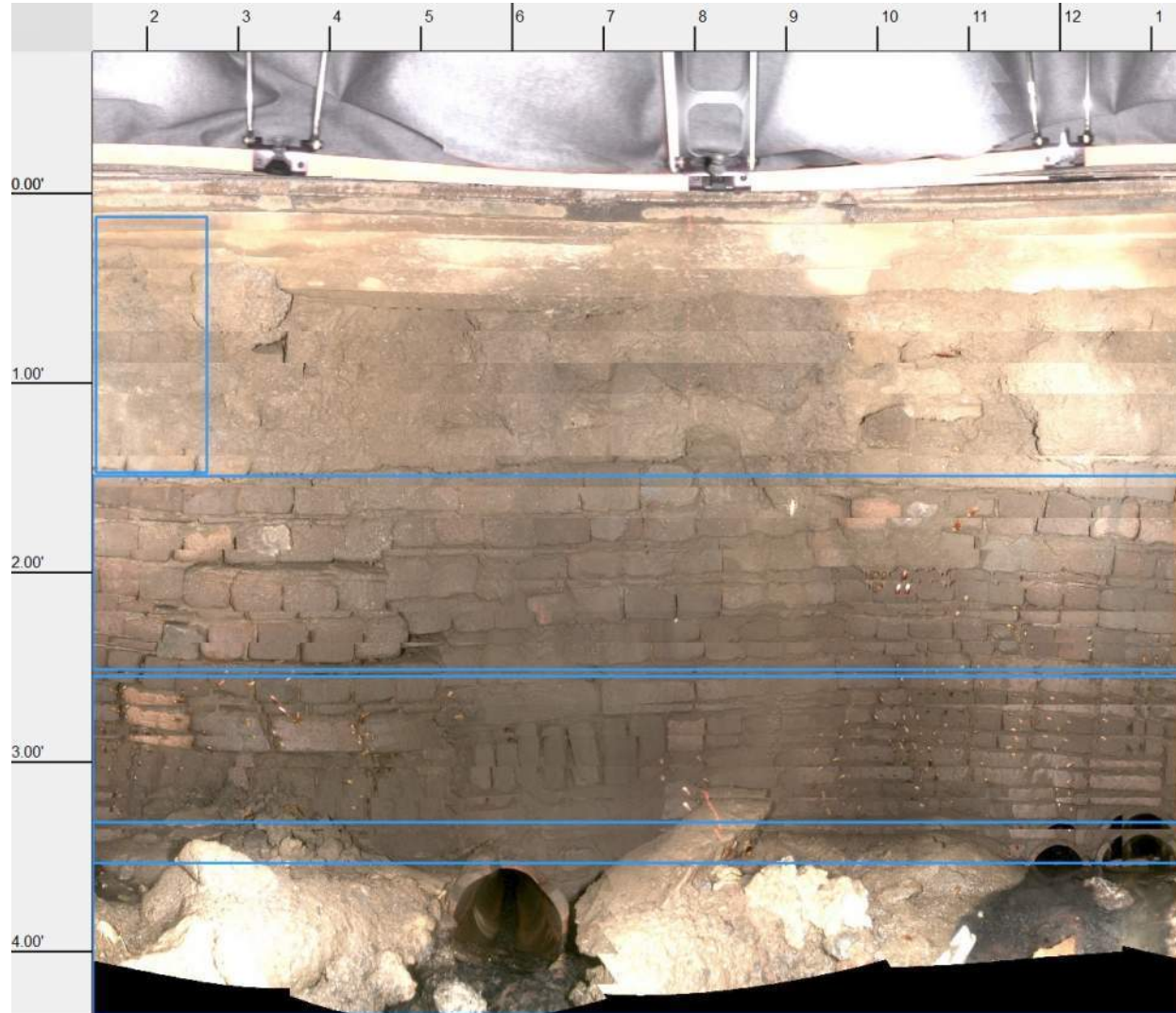



Node Inspection - 8/14/2023 - 1834

Date 8/14/2023	Time 14:23	Manhole Number 1834	Access Type Manhole	City Georgetown	Street 508 South Fraser
Surveyed By Matthew Headrick	Certificate Number U-0419-07030528	PO Number	Work Order	Pre-Cleaning No Pre-Cleaning	Sheet Number

General Manhole Information

MH Use Sanitary	Year Constructed	Year Renewed	Owner City of Georgetown
Rim to Invert 9.0'	Grade to Invert 9.0'	Rim to Grade 0.0'	Rim to Grade Exposed 0.0'
Surface Type Asphalt			
Location Code Light Highway	Location Details		
Additional component information			

General Manhole Inspection Information

Date Cleaned	Inspection Level Level 2	Consequence of Failure
Customer	Evidence Surcharge No	Purpose Routine assessment
Reviewed By Juan Bedoya	Reviewer Certificate U-1020-70400280	Weather Dry
Is Imperial No	Inspection Status Remote Inspection	Media Label WinCan 14.0
Potential for RunOff None		

Cover

Cover Type Solid					
Cover Shape Circular	Cover Size 23.5"	Center Cover Size	Cover Width		
Cover Material Cast Iron	Hole Diameter	Hole Number 0			
Cover Frame fit Good	Cover Bearing Surface Diameter 23.0"	Cover Bearing Surface Width			
Cover Condition Sound					

Cover Insert

Cover Insert Type None	Insert Condition
----------------------------------	------------------

Frame

Frame Material Cast Iron	Frame Bearing Surface Width 0.3"	Frame Bearing Surface Depth 1.0"
Frame Seal Inflow None	Frame Clear Open Diameter 22.3"	Frame Clear Open Width
Frame Depth 8.0"	Frame Offset Distance 0.0"	
Frame Condition Corroded		
Seal Condition Missing		

Chimney

Chimney Present Yes	Chimney Material 1 Brick	Chimney Material 2
Chimney Clear Opening 22.3"	Chimney Depth 2.3'	Chimney Infiltration None
Chimney Condition Sound	Chimney Lining Interior None	Chimney Lining Exterior Not Known

Cone

Cone Type Conical centered	Cone Material Brick	Cone Depth 6.0'
Cone Condition Sound	Cone Lining Interior None	Cone Lining Exterior Not Known

Wall

Wall Material Brick	Wall Diameter 45.3"	Wall By Size 45.3"	Wall Depth 7.4'
Wall Condition Sound	Wall Lining Exterior Not Known	Wall Lining Interior None	

Bench

Bench Condition Sound	Bench Present Yes	Bench Material Concrete (cast in place)	Bench Lining None
---------------------------------	-----------------------------	---	-----------------------------

QSR	QMR	QOR	SPR	MPR	OPR	SPRI	MPRI	OPRI
4332	3122	4333	21.0	11.0	32.0	2.6	1.6	2.1



Node Inspection - 8/14/2023 - 1834

Date 8/14/2023	Time 14:23	Manhole Number 1834	Access Type Manhole	City Georgetown	Street 508 South Fraser
Surveyed By Matthew Headrick	Certificate Number U-0419-07030528	PO Number	Work Order	Pre-Cleaning No Pre-Cleaning	Sheet Number

Channel

Channel Installed	Yes	Channel Material	Concrete (cast in place)	Channel Type	Formed
Channel Condition	Sound	Channel Exposure	Fully Opened		

Steps

Step Number	2	Step Material	
-------------	----------	---------------	--

Observations

Nr.	Distance	MACP Code	Observation	Remark
1	1.5'	MML	Missing Mortar Large from 12 o'clock to 12 o'clock	Fully exposed bricks with big gaps
2	4.0'	MML	Missing Mortar Large from 12 o'clock to 12 o'clock	Fully exposed bricks with gaps
3	6.5'	DB	Displaced Brick from 11 o'clock to 1 o'clock	displaced bricks around pipe seal
4	6.9'	MML	Missing Mortar Large from 12 o'clock to 12 o'clock	Fully exposed bricks with gaps
5	7.6'	IW	Infiltration Weeper from 9 o'clock to 5 o'clock, within 8 inch	infiltration from brick wall
6	8.0'	OBN	Obstruction Construction Debris, 30% of cross sectional area from 10 o'clock to 5 o'clock	debris on bench

Connections

Pipe Number	Rim To Invert	Direction	Clock Position	Shape	Material	Height	Width	Pipe Condition	Seal Condition	Pipe Type	Structure ID	Comments
1	9.0'	Out	6	Circular	Vitrified Clay Pipe	12"	-	Sound	Sound	Gravity Connection		
2	6.1'	In	12	Circular	Vitrified Clay Pipe	8"	-	Sound	Sound	Gravity Connection		
3	7.3'	In	12	Circular	Vitrified Clay Pipe	8"	-	Sound	Sound	Gravity Connection		
4	7.1'	In	3	Circular	Vitrified Clay Pipe	8"	-	Sound	Sound	Gravity Connection		

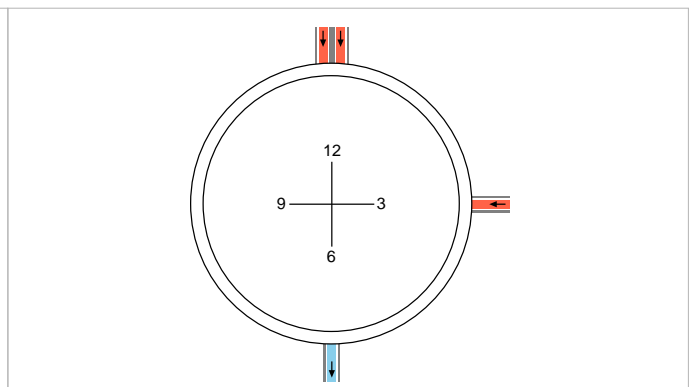
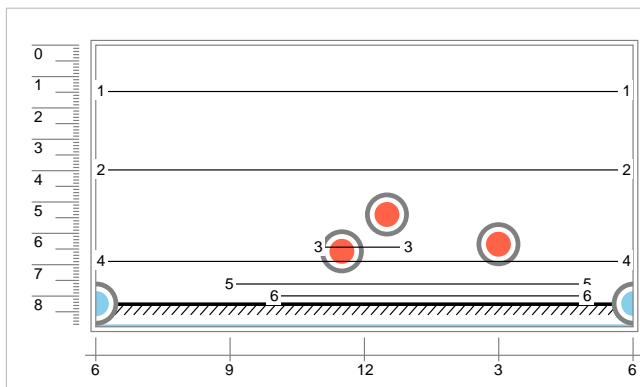

QSR	QMR	QOR	SPR	MPR	OPR	SPRI	MPRI	OPRI
4332	3122	4333	21.0	11.0	32.0	2.6	1.6	2.1



Node 2D Sketch - 8/14/2023 - 1834

Date 8/14/2023	Manhole Number 1834	City Georgetown	Street 508 South Fraser Street	Surveyed By Matthew Headrick
-------------------	------------------------	--------------------	-----------------------------------	---------------------------------

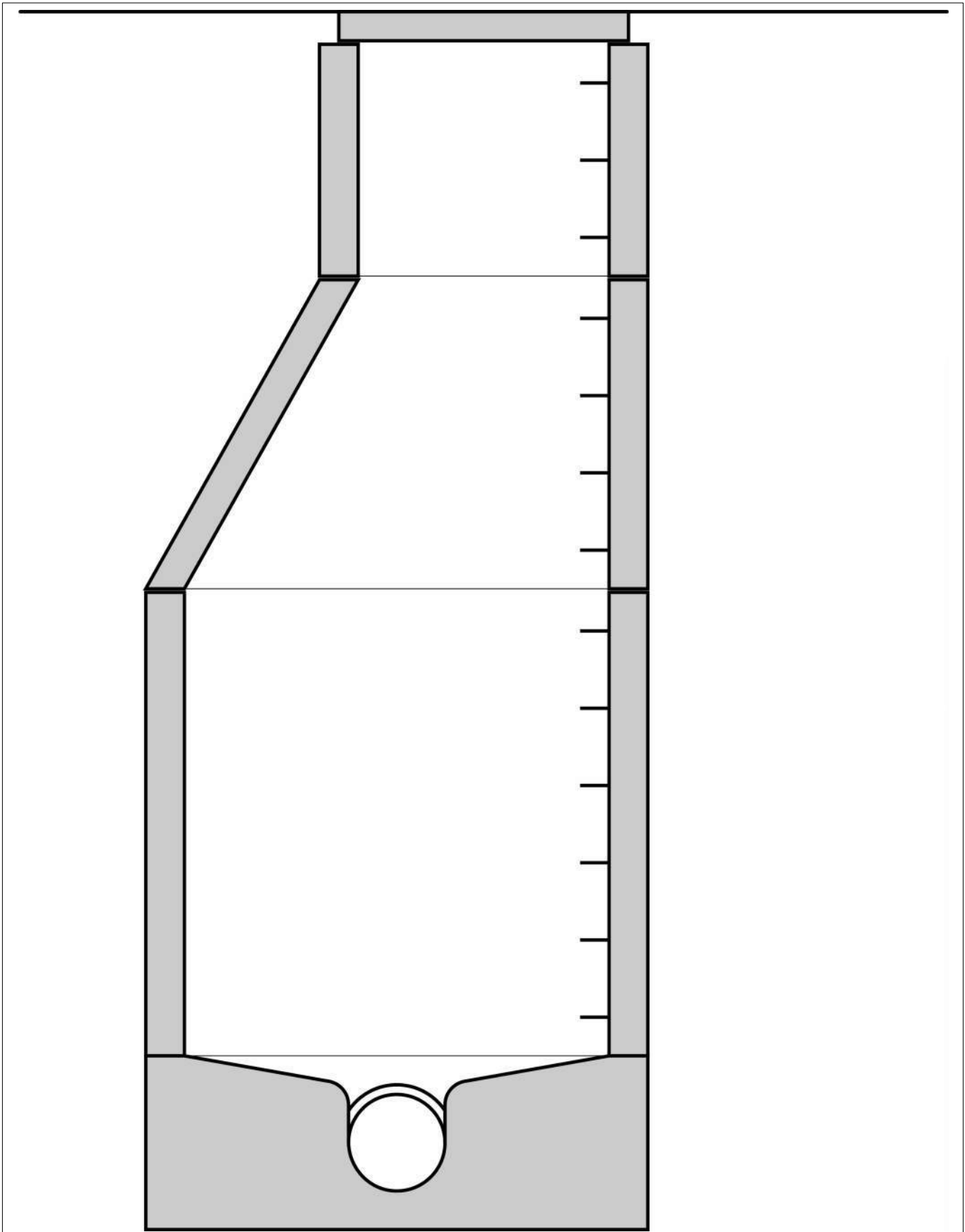



Node Pictures - 8/14/2023 - 1834

Date 8/14/2023	Manhole Number 1834	City Georgetown	Street 508 South Fraser Street	Surveyed By Matthew Headrick
-------------------	------------------------	--------------------	-----------------------------------	---------------------------------



1834b_16edcb0d-7f2c-4b5a-bd27-6b0d1bf9d1bd_3d5f165f-06b8-4857-8369-535a926f5c84_P11.jpg,
, 1.48
Missing Mortar Large from 12 o'clock to 12 o'clock



1834b_16edcb0d-7f2c-4b5a-bd27-6b0d1bf9d1bd_858fbed5-5e08-48eb-856e-6c910e6eeb07_P11.jpg,
00:00:18, 4.00
Missing Mortar Large from 12 o'clock to 12 o'clock



Node Pictures - 8/14/2023 - 1834

Date 8/14/2023	Manhole Number 1834	City Georgetown	Street 508 South Fraser Street	Surveyed By Matthew Headrick
-------------------	------------------------	--------------------	-----------------------------------	---------------------------------



1834b_16edcb0d-7f2c-4b5a-bd27-6b0d1bf9d1bd_28df1de4-7227-40c4-98d3-59bc5e7280d2_P11.jpg,
00:00:27, 6.46
Displaced Brick from 11 o'clock to 1 o'clock



1834b_16edcb0d-7f2c-4b5a-bd27-6b0d1bf9d1bd_b33f93a0-66d3-4a68-be57-658e110c837b_P11.jpg,
00:00:29, 6.90
Missing Mortar Large from 12 o'clock to 12 o'clock



Node Pictures - 8/14/2023 - 1834

Date 8/14/2023	Manhole Number 1834	City Georgetown	Street 508 South Fraser Street	Surveyed By Matthew Headrick
-------------------	------------------------	--------------------	-----------------------------------	---------------------------------



1834b_16edcb0d-7f2c-4b5a-bd27-6b0d1bf9d1bd_988d04c8-f11c-4480-860f-6154cb292fd8_P11.jpg,
00:00:32, 7.63
Infiltration Weeper from 9 o'clock to 5 o'clock, within 8 inch



1834b_16edcb0d-7f2c-4b5a-bd27-6b0d1bf9d1bd_e218bb93-14c1-4f86-9c8f-5284944152be_P11.jpg,
00:00:34, 8.00
Obstruction Construction Debris, 30% of cross sectional area from 10 o'clock to 5 o'clock



Node Drawings - 8/14/2023 - 1834

Date 8/14/2023	Manhole Number 1834	City Georgetown	Street 508 South Fraser Street	Surveyed By Matthew Headrick
-------------------	------------------------	--------------------	-----------------------------------	---------------------------------

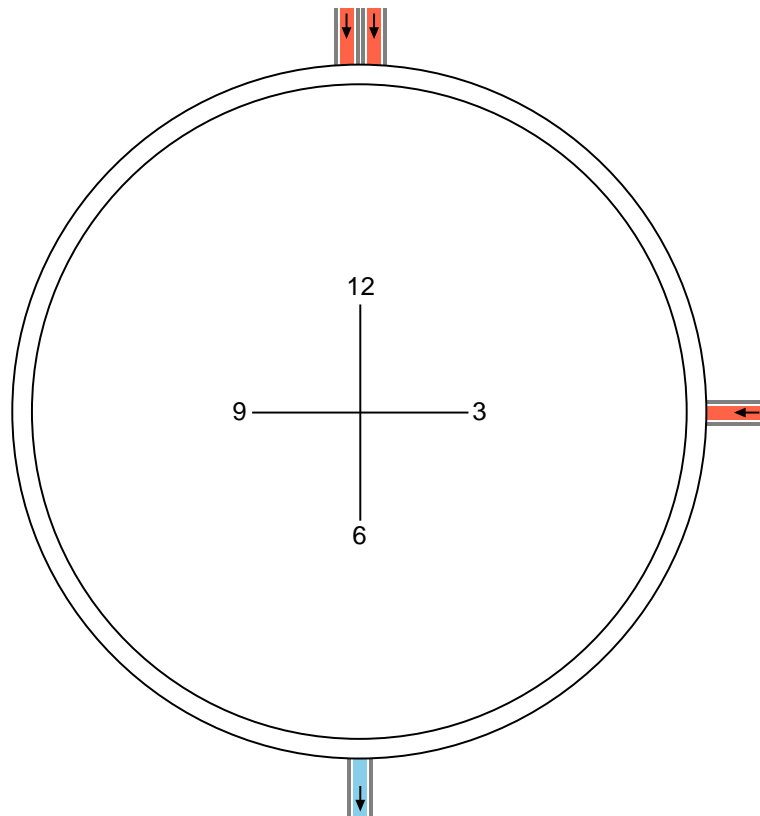
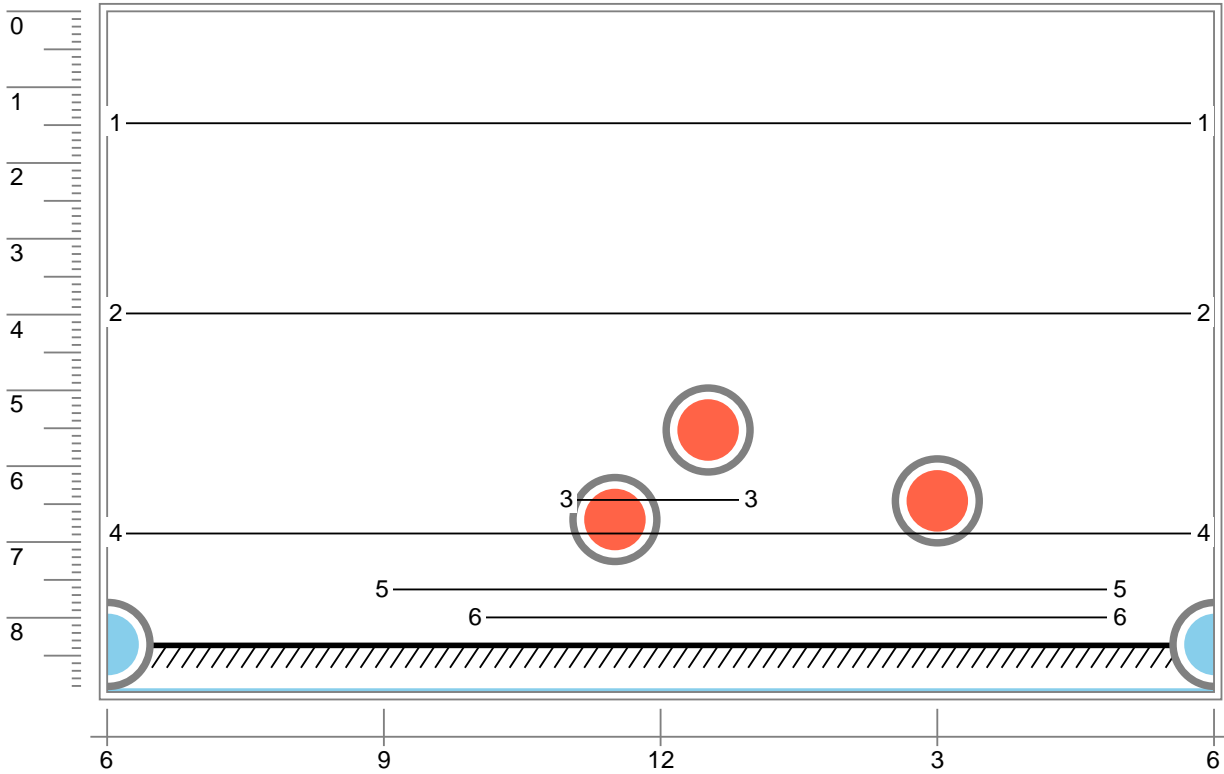



CleverScan - 8/14/2023 - 1834

Date 8/14/2023	Manhole Number 1834	City Georgetown	Street 508 South Fraser Street	Surveyed By Matthew Headrick
-------------------	------------------------	--------------------	-----------------------------------	---------------------------------

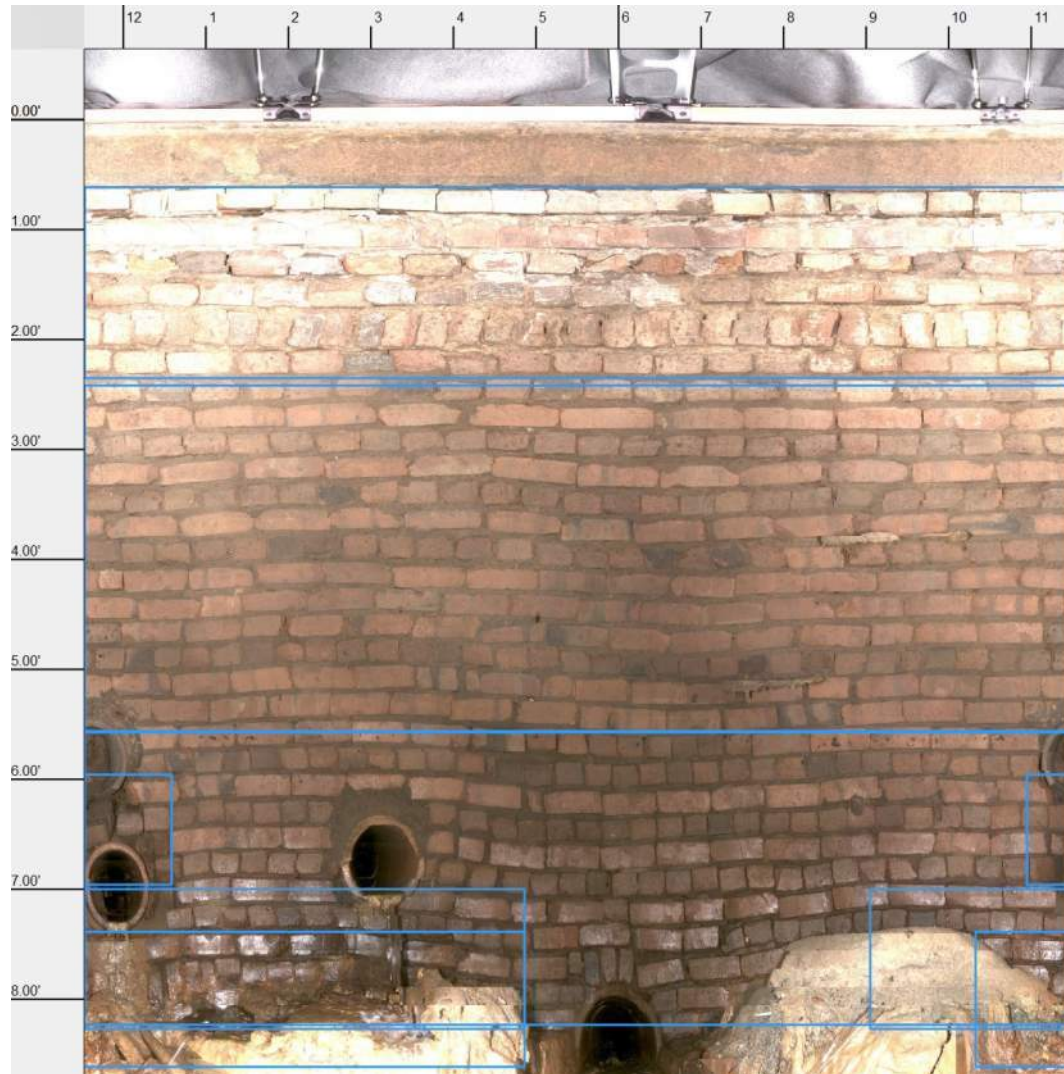



Node Inspection - 8/9/2023 - 1828

Date 8/9/2023	Time 12:03	Manhole Number 1828	Access Type Manhole	City Georgetown	Street Front Street and
Surveyed By Matthew Headrick	Certificate Number U-0419-07030528	PO Number	Work Order	Pre-Cleaning No Pre-Cleaning	Sheet Number

General Manhole Information

MH Use Sanitary	Year Constructed	Year Renewed	Owner	City of Georgetown
Rim to Invert 11.6'	Grade to Invert 11.6'	Rim to Grade 0.0'	Rim to Grade Exposed	0.0'
Surface Type Asphalt				
Location Code Light Highway	Location Details			
Additional component information	MH Surcharged> Scan incomplete> Outlet not visible			

General Manhole Inspection Information

Date Cleaned	Inspection Level Level 2	Consequence of Failure
Customer	Evidence Surcharge No	Purpose Routine assessment
Reviewed By Juan Bedoya	Reviewer Certificate U-1020-70400280	Weather Dry
Is Imperial No	Inspection Status Remote Inspection	Media Label WinCan 14.0
Potential for RunOff	None	

Cover

Cover Type Solid					
Cover Shape Circular	Cover Size 23.5"	Center Cover Size	Cover Width		
Cover Material Cast Iron	Hole Diameter	Hole Number		0	
Cover Frame fit Good	Cover Bearing Surface Diameter	23.0"	Cover Bearing Surface Width		
Cover Condition Sound					

Cover Insert

Cover Insert Type None	Insert Condition
----------------------------------	------------------

Frame

Frame Material Cast Iron	Frame Bearing Surface Width 0.5"	Frame Bearing Surface Depth 1.0"
Frame Seal Inflow None	Frame Clear Open Diameter 22.0"	Frame Clear Open Width
Frame Depth 8.0"	Frame Offset Distance 0.0"	
Frame Condition Corroded		
Seal Condition Missing		

Chimney

Chimney Present Yes	Chimney Material 1 Brick	Chimney Material 2
Chimney Clear Opening 27.0"	Chimney Depth 5.4'	Chimney Infiltration None
Chimney Condition Sound	Chimney Lining Interior None	Chimney Lining Exterior Not Known

Cone

Cone Type Conical centered	Cone Material Brick	Cone Depth 7.7'
Cone Condition Defective	Cone Lining Interior None	Cone Lining Exterior Not Known

Wall

Wall Material Brick	Wall Diameter 45.6"	Wall By Size 45.6"	Wall Depth 11.6'
Wall Condition Sound	Wall Lining Exterior Not Known	Wall Lining Interior None	

Observations

Nr.	Distance	MACP Code	Observation	Remark				
1	3.0'	MML	Missing Mortar Large from 12 o'clock to 12 o'clock	Fully exposed bricks with gaps				
2	6.6'	MML	Missing Mortar Large from 12 o'clock to 12 o'clock	Fully exposed bricks with gaps				
QSR	QMR	QOR	SPR	MPR	OPR	SPRI	MPRI	OPRI
4332	3114	4333	21.0	7.0	28.0	2.6	1.4	2.2



Node Inspection - 8/9/2023 - 1828

Date 8/9/2023	Time 12:03	Manhole Number 1828	Access Type Manhole	City Georgetown	Street Front Street and
Surveyed By Matthew Headrick	Certificate Number U-0419-07030528	PO Number	Work Order	Pre-Cleaning No Pre-Cleaning	Sheet Number

Observations

Nr.	Distance	MACP Code	Observation	Remark
3	6.9'	BSV	Broken Soil Visible, 18inch defective, 18inch intrusion at 1 o'clock, within 8 inch, Start	soil visible
4	8.2'	DB	Displaced Brick from 8 o'clock to 11 o'clock	displaced bricks
5	9.5'	MML	Missing Mortar Large from 12 o'clock to 12 o'clock	Fully exposed bricks with gaps

Connections

Pipe Number	Rim To Invert	Direction	Clock Position	Shape	Material	Height	Width	Pipe Condition	Seal Condition	Pipe Type	Structure ID	Comments
1	11.6'	Out	6	Circular	Not Known	-	-	Sound	Sound	Gravity Connection		Under water, not visible
2	10.9'	In	8	Circular	Vitrified Clay Pipe	15"	-	Sound	Sound	Gravity Connection		
3	7.5'	In	9	Circular	Vitrified Clay Pipe	15"	-	Sound	Sound	Gravity Connection		
4	7.0'	In	12	Circular	Vitrified Clay Pipe	8"	-	Sound	Defective	Gravity Connection		
5	9.2'	In	2	Circular	Vitrified Clay Pipe	12"	-	Sound	Defective	Gravity Connection		

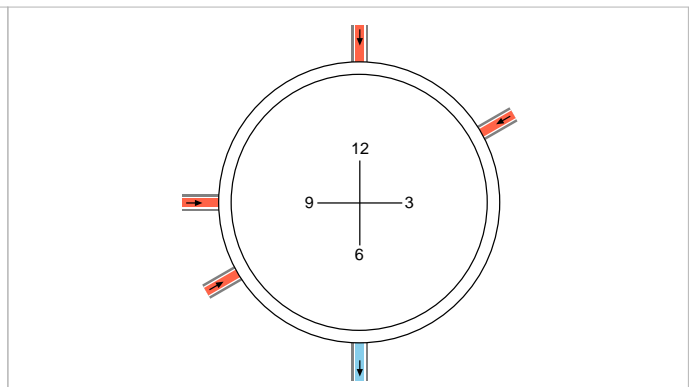
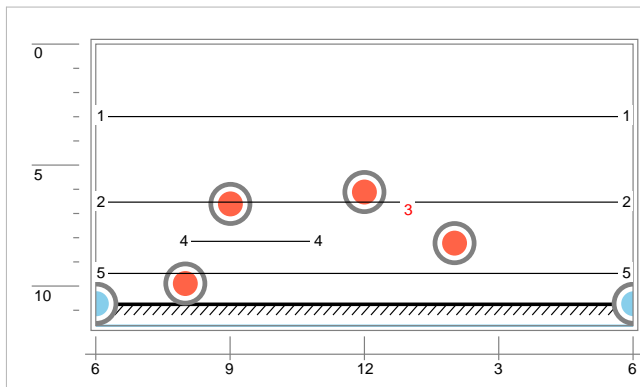

QSR	QMR	QOR	SPR	MPR	OPR	SPRI	MPRI	OPRI
4332	3114	4333	21.0	7.0	28.0	2.6	1.4	2.2



Node 2D Sketch - 8/9/2023 - 1828

Date 8/9/2023	Manhole Number 1828	City Georgetown	Street Front Street and South	Surveyed By Matthew Headrick
------------------	------------------------	--------------------	----------------------------------	---------------------------------

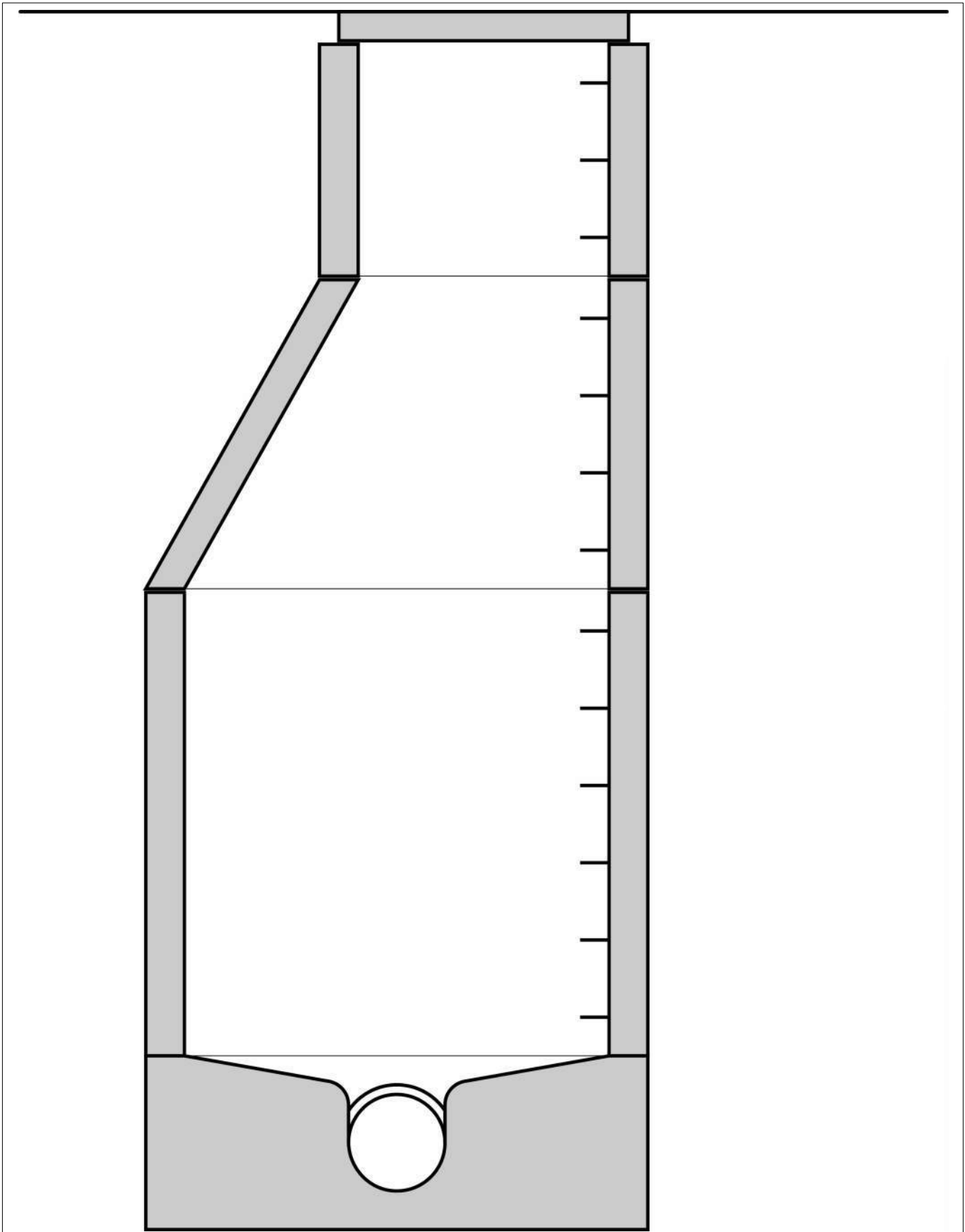



Node Pictures - 8/9/2023 - 1828

Date 8/9/2023	Manhole Number 1828	City Georgetown	Street Front Street and South	Surveyed By Matthew Headrick
------------------	------------------------	--------------------	----------------------------------	---------------------------------



1828b_5154b3dc-7153-4625-bad4-be8d5b792f69_af14e9ce-43e7-4d78-b89c-bf5f5b97d8ee_P11.jpg, 3.02
Missing Mortar Large from 12 o'clock to 12 o'clock



1828b_5154b3dc-7153-4625-bad4-be8d5b792f69_edb4c192-5e6a-4281-8e16-ea99f963de5c_P11.jpg, 00:00:32, 6.58
Missing Mortar Large from 12 o'clock to 12 o'clock



Node Pictures - 8/9/2023 - 1828

Date 8/9/2023	Manhole Number 1828	City Georgetown	Street Front Street and South	Surveyed By Matthew Headrick
------------------	------------------------	--------------------	----------------------------------	---------------------------------



1828b_5154b3dc-7153-4625-bad4-be8d5b792f69_3173cf7b-f6db-4944-a0d7-c17632622fc9_P11.jpg,
00:00:33, 6.91
Broken Soil Visible, 18inch defective, 18inch intrusion at 1 o'clock, within 8 inch, Start



1828b_5154b3dc-7153-4625-bad4-be8d5b792f69_a9eef5b8-2357-475d-a879-3b8cd9676573_P11.jpg,
00:00:39, 8.18
Displaced Brick from 8 o'clock to 11 o'clock



Node Pictures - 8/9/2023 - 1828

Date 8/9/2023	Manhole Number 1828	City Georgetown	Street Front Street and South	Surveyed By Matthew Headrick
------------------	------------------------	--------------------	----------------------------------	---------------------------------



1828b_5154b3dc-7153-4625-bad4-be8d5b792f69_bcfea9bc-7934-4eb7-bd36-91ffe877c936_P11.jpg,
00:00:44, 9.50
Missing Mortar Large from 12 o'clock to 12 o'clock



Node Drawings - 8/9/2023 - 1828

Date 8/9/2023	Manhole Number 1828	City Georgetown	Street Front Street and South	Surveyed By Matthew Headrick
------------------	------------------------	--------------------	----------------------------------	---------------------------------

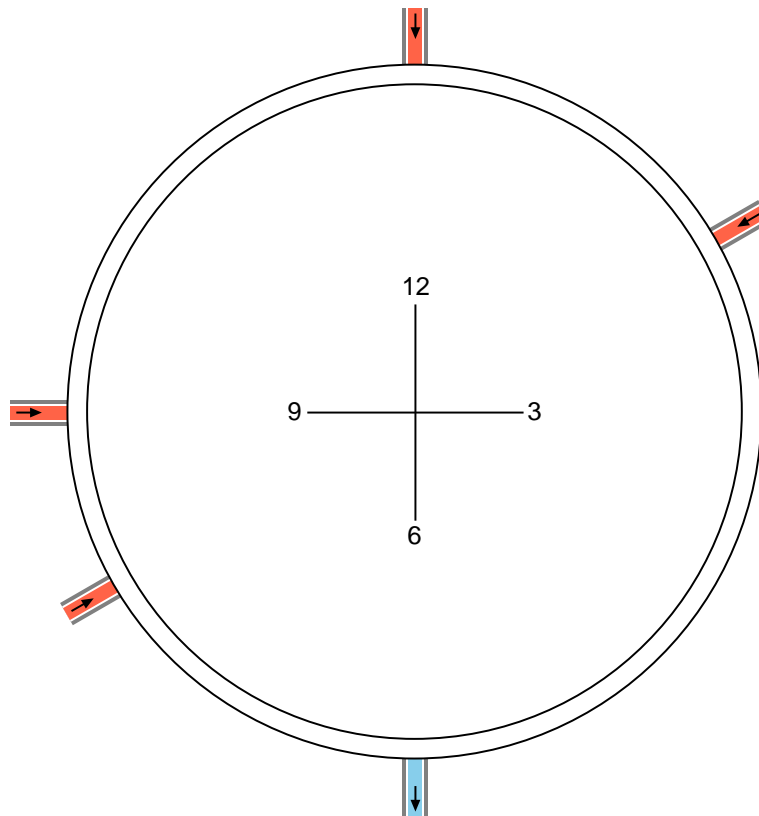
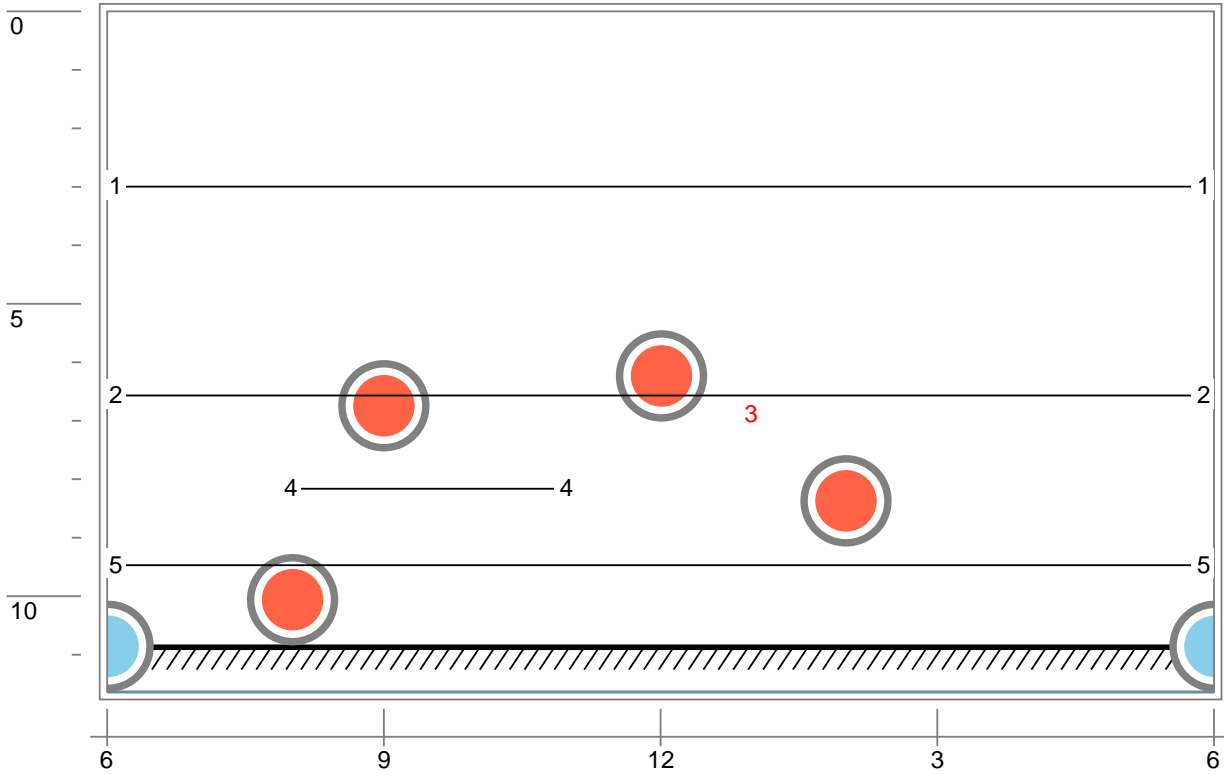



CleverScan - 8/9/2023 - 1828

Date 8/9/2023	Manhole Number 1828	City Georgetown	Street Front Street and South Road	Surveyed By Matthew Headrick
------------------	------------------------	--------------------	---------------------------------------	---------------------------------

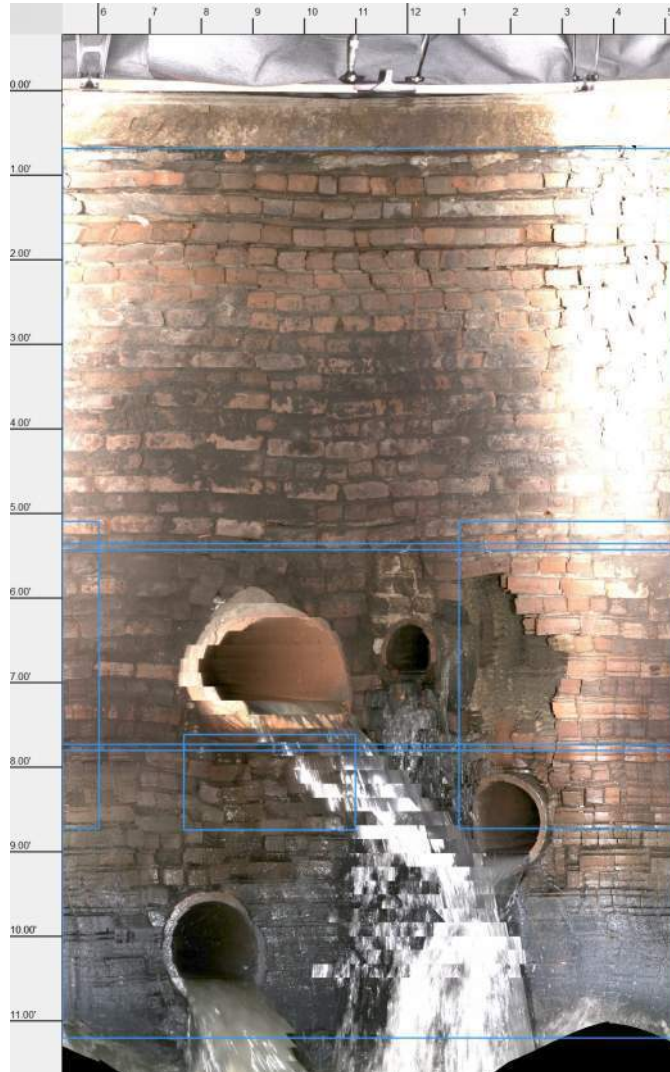



Node Inspection - 8/14/2023 - 1835

Date 8/14/2023	Time 16:59	Manhole Number 1835	Access Type Manhole	City Georgetown	Street 601 South Fraser
Surveyed By Matthew Headrick	Certificate Number U-0419-07030528	PO Number	Work Order	Pre-Cleaning No Pre-Cleaning	Sheet Number

General Manhole Information

MH Use Sanitary	Year Constructed	Year Renewed	Owner City of Georgetown
Rim to Invert 9.5'	Grade to Invert 9.5'	Rim to Grade 0.0'	Rim to Grade Exposed 0.0'
Surface Type Asphalt			
Location Code Light Highway	Location Details		
Additional component information			

General Manhole Inspection Information

Date Cleaned	Inspection Level Level 2	Consequence of Failure
Customer	Evidence Surcharge No	Purpose Routine assessment
Reviewed By Juan Bedoya	Reviewer Certificate U-1020-70400280	Weather Dry
Is Imperial No	Inspection Status Remote Inspection	Media Label WinCan 14.0
Potential for RunOff None		

Cover

Cover Type Solid					
Cover Shape Circular	Cover Size 23.6"	Center Cover Size	Cover Width		
Cover Material Cast Iron	Hole Diameter	Hole Number 0			
Cover Frame fit Good	Cover Bearing Surface Diameter 23.0"	Cover Bearing Surface Width			
Cover Condition Sound					

Cover Insert

Cover Insert Type None	Insert Condition
----------------------------------	------------------

Frame

Frame Material Cast Iron	Frame Bearing Surface Width 0.8"	Frame Bearing Surface Depth 1.0"
Frame Seal Inflow None	Frame Clear Open Diameter 22.0"	Frame Clear Open Width
Frame Depth 8.0"	Frame Offset Distance 0.0"	
Frame Condition Sound		
Seal Condition Missing		

Chimney

Chimney Present Yes	Chimney Material 1 Brick	Chimney Material 2
Chimney Clear Opening 22.3"	Chimney Depth 0.9'	Chimney Infiltration None
Chimney Condition Sound	Chimney Lining Interior None	Chimney Lining Exterior Not Known

Cone

Cone Type Conical centered	Cone Material Brick	Cone Depth 3.5'
Cone Condition Sound	Cone Lining Interior None	Cone Lining Exterior Not Known

Wall

Wall Material Brick	Wall Diameter 54.0"	Wall By Size 54.0"	Wall Depth 8.3'
Wall Condition Sound	Wall Lining Exterior Not Known	Wall Lining Interior None	

Bench

Bench Condition Sound	Bench Present Yes	Bench Material Concrete (cast in place)	Bench Lining None
---------------------------------	-----------------------------	---	-----------------------------

QSR	QMR	QOR	SPR	MPR	OPR	SPRI	MPRI	OPRI
4231	3121	4232	16.0	10.0	26.0	2.3	1.4	1.9



Node Inspection - 8/14/2023 - 1835

Date 8/14/2023	Time 16:59	Manhole Number 1835	Access Type Manhole	City Georgetown	Street 601 South Fraser
Surveyed By Matthew Headrick	Certificate Number U-0419-07030528	PO Number	Work Order	Pre-Cleaning No Pre-Cleaning	Sheet Number

Channel

Channel Installed	Yes	Channel Material	Concrete (cast in place)	Channel Type	Formed
Channel Condition	Sound	Channel Exposure	Fully Opened		

Steps

Step Number	2	Step Material	
-------------	----------	---------------	--

Observations

Nr.	Distance	MACP Code	Observation	Remark
1	0.9'	MML	Missing Mortar Large from 12 o'clock to 11 o'clock, Start	Fully exposed bricks with gaps
2	2.3'	MML	Missing Mortar Large from 12 o'clock to 12 o'clock	Fully exposed bricks with gaps
3	2.8'	MGO	Miscellaneous General Observation	steel step corroded
4	4.3'	SAV	Surface Damage Aggregate Visible from 12 o'clock to 12 o'clock, within 8 inch	aggregate visible on concrete bricks/blocks
5	5.5'	MML	Missing Mortar Large from 12 o'clock to 12 o'clock	Fully exposed bricks with gaps
6	6.6'	IW	Infiltration Weeper from 12 o'clock to 12 o'clock, within 8 inch	infiltration throughout wall within 8" all around
7	7.0'	DAR	Deposits Attached Ragging, 5% of cross sectional area from 2 o'clock to 6 o'clock, within 8 inch	deposits on bench

Connections

Pipe Number	Rim To Invert	Direction	Clock Position	Shape	Material	Height	Width	Pipe Condition	Seal Condition	Pipe Type	Structure ID	Comments
1	9.5'	Out	6	Circular	Vitrified Clay Pipe	15"	-	Sound	Sound	Gravity Connection		
2	9.0'	In	9	Circular	Vitrified Clay Pipe	15"	-	Sound	Sound	Gravity Connection		
3	5.4'	In	12	Circular	Vitrified Clay Pipe	8"	-	Sound	Sound	Gravity Connection		
4	8.8'	In	3	Circular	Vitrified Clay Pipe	15"	-	Sound	Sound	Gravity Connection		

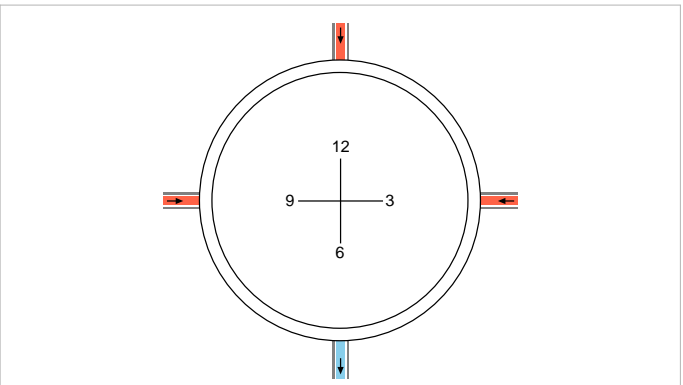
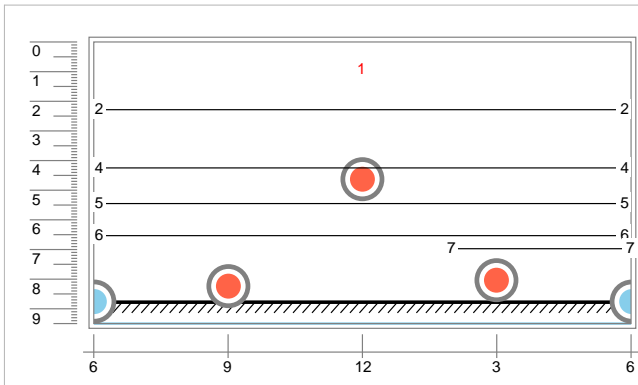

QSR	QMR	QOR	SPR	MPR	OPR	SPRI	MPRI	OPRI
4231	3121	4232	16.0	10.0	26.0	2.3	1.4	1.9



Node 2D Sketch - 8/14/2023 - 1835

Date 8/14/2023	Manhole Number 1835	City Georgetown	Street 601 South Fraser Street	Surveyed By Matthew Headrick
-------------------	------------------------	--------------------	-----------------------------------	---------------------------------

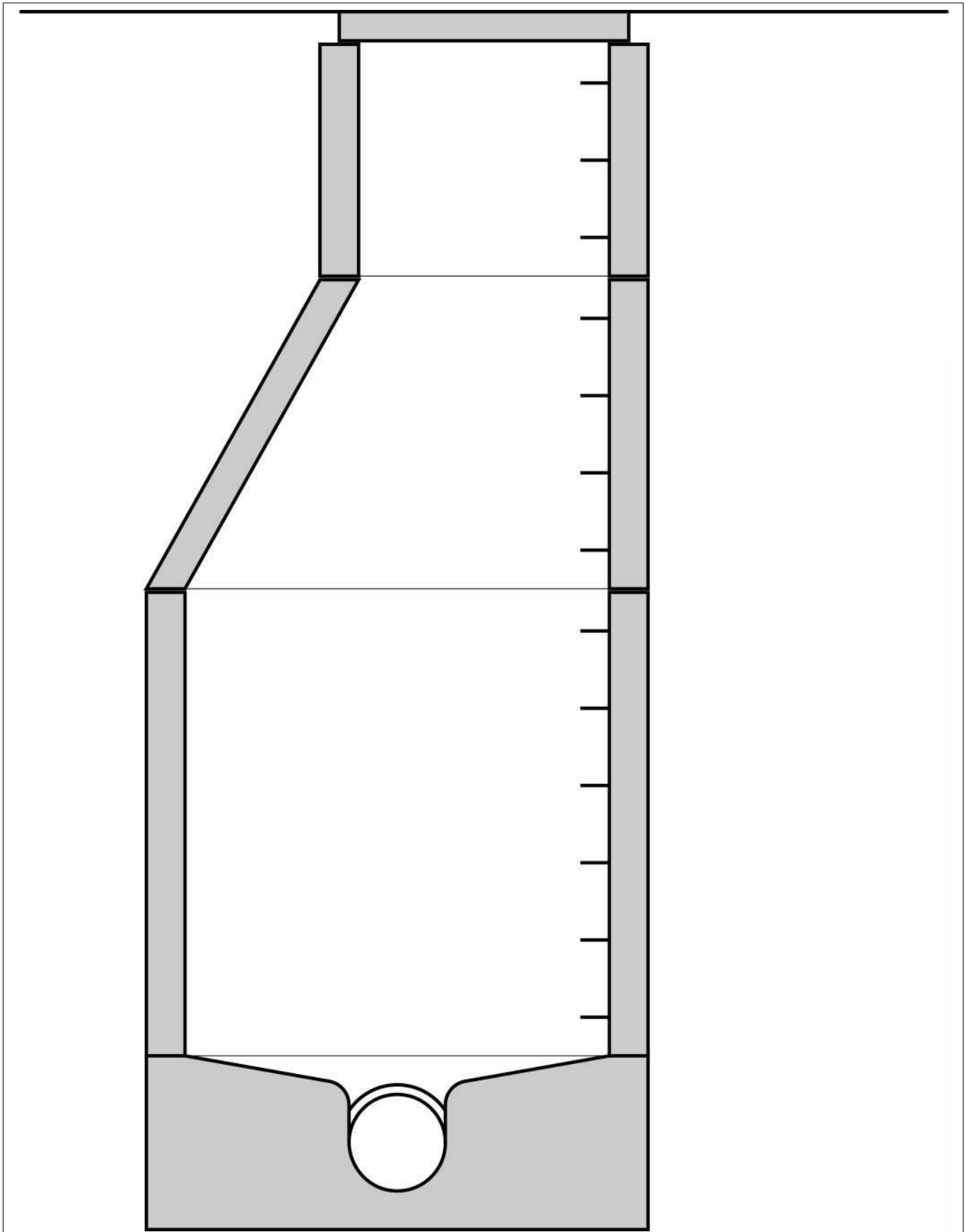



Node Pictures - 8/14/2023 - 1835

Date 8/14/2023	Manhole Number 1835	City Georgetown	Street 601 South Fraser Street	Surveyed By Matthew Headrick
-------------------	------------------------	--------------------	-----------------------------------	---------------------------------



1835c_f2d6f72e-14ab-43ef-906b-8e360bc88926_92e8571e-9460-4688-88e8-b2a276872e7c_P11.jpg,
, 0.94
Missing Mortar Large from 12 o'clock to 11 o'clock, Start



1835c_f2d6f72e-14ab-43ef-906b-8e360bc88926_c2591e1a-3356-420c-b13d-3df3d302536e_P11.jpg,
00:00:13, 2.32
Missing Mortar Large from 12 o'clock to 12 o'clock



Node Pictures - 8/14/2023 - 1835

Date 8/14/2023	Manhole Number 1835	City Georgetown	Street 601 South Fraser Street	Surveyed By Matthew Headrick
-------------------	------------------------	--------------------	-----------------------------------	---------------------------------



1835c_f2d6f72e-14ab-43ef-906b-8e360bc88926_cfb6e32-1441-4e55-ab7f-60a705a670fd_PI1.jpg,
00:00:15, 2.77
Miscellaneous General Observation



1835c_f2d6f72e-14ab-43ef-906b-8e360bc88926_e8a7c4a0-bf72-4c2e-9871-44d321ec9f86_PI1.jpg,
00:00:21, 4.27
Surface Damage Aggregate Visible from 12 o'clock to 12 o'clock, within 8 inch



Node Pictures - 8/14/2023 - 1835

Date 8/14/2023	Manhole Number 1835	City Georgetown	Street 601 South Fraser Street	Surveyed By Matthew Headrick
-------------------	------------------------	--------------------	-----------------------------------	---------------------------------



1835c_f2d6f72e-14ab-43ef-906b-8e360bc88926_f8f971ba-6780-4a33-823f-3022d1b31921_P11.jpg,
00:00:25, 5.46
Missing Mortar Large from 12 o'clock to 12 o'clock



1835c_f2d6f72e-14ab-43ef-906b-8e360bc88926_b3a93ac4-f918-4e68-95ed-4a09c6c64798_P11.jpg,
00:00:29, 6.57
Infiltration Weeper from 12 o'clock to 12 o'clock, within 8 inch



Node Pictures - 8/14/2023 - 1835

Date 8/14/2023	Manhole Number 1835	City Georgetown	Street 601 South Fraser Street	Surveyed By Matthew Headrick
-------------------	------------------------	--------------------	-----------------------------------	---------------------------------



1835c_f2d6f72e-14ab-43ef-906b-8e360bc88926_591172c5-468d-4e0c-a783-9c27bbd0c414_P11.jpg,
00:00:31, 7.01
Deposits Attached Ragging, 5% of cross sectional area from 2 o'clock to 6 o'clock, within 8 inch



Node Drawings - 8/14/2023 - 1835

Date 8/14/2023	Manhole Number 1835	City Georgetown	Street 601 South Fraser Street	Surveyed By Matthew Headrick
-------------------	------------------------	--------------------	-----------------------------------	---------------------------------

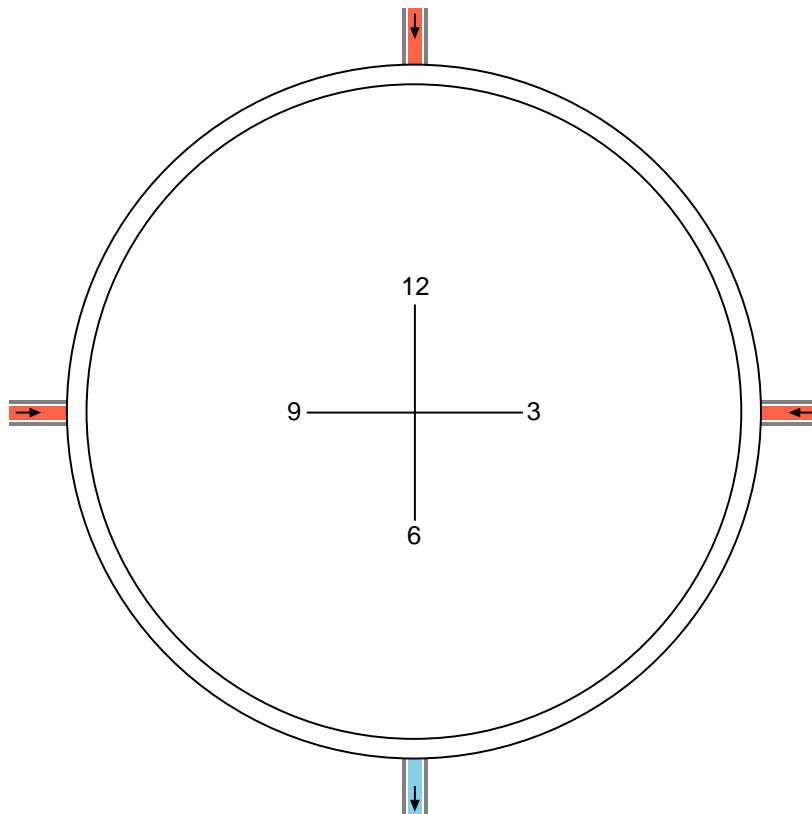
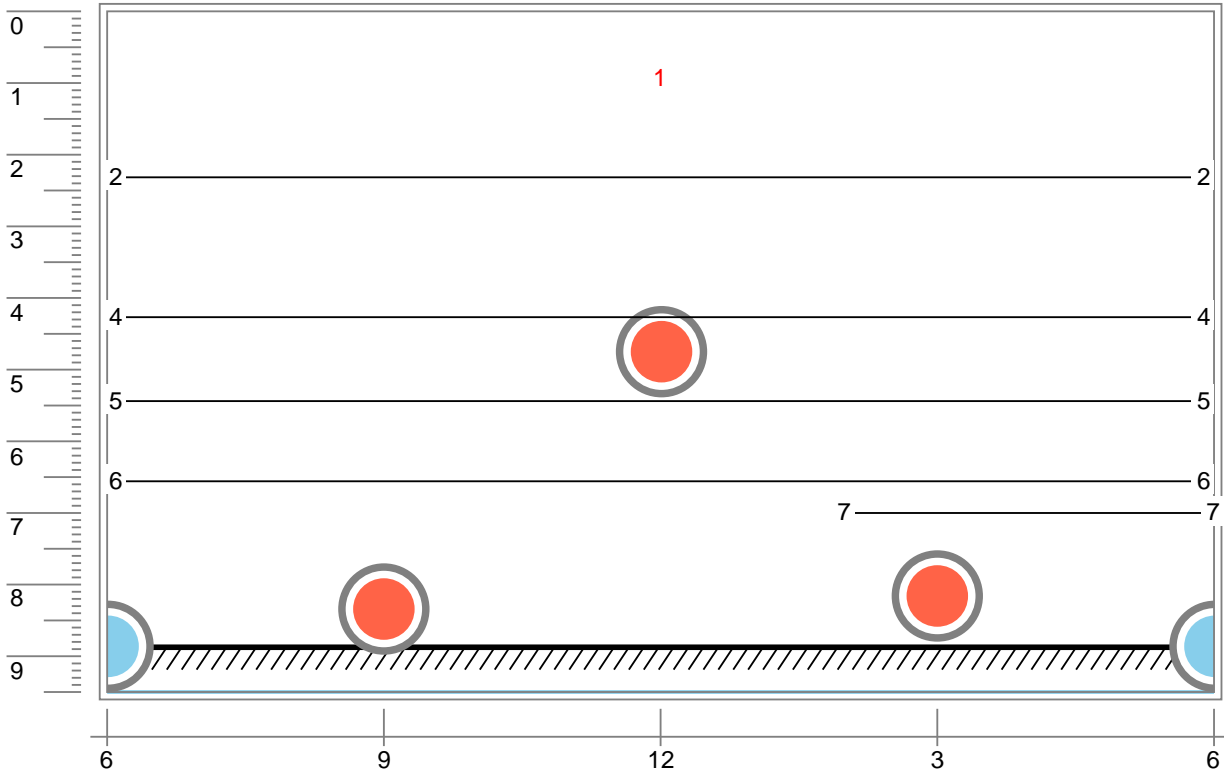



CleverScan - 8/14/2023 - 1835

Date 8/14/2023	Manhole Number 1835	City Georgetown	Street 601 South Fraser Street	Surveyed By Matthew Headrick
-------------------	------------------------	--------------------	-----------------------------------	---------------------------------





Node Inspection - 8/9/2023 - 1842

Date 8/9/2023	Time 12:01	Manhole Number 1842	Access Type Manhole	City Georgetown	Street 101 South Fraser
Surveyed By Matthew Headrick	Certificate Number U-0419-07030528	PO Number	Work Order	Pre-Cleaning No Pre-Cleaning	Sheet Number

General Manhole Information

MH Use	Sanitary	Year Constructed		Year Renewed		Owner	City of Georgetown
Rim to Invert	10.0'	Grade to Invert	10.0'	Rim to Grade	0.0'	Rim to Grade Exposed	0.0'
Surface Type	Asphalt						
Location Code	Light Highway	Location Details					
Additional component information							

General Manhole Inspection Information

Date Cleaned		Inspection Level	Level 2	Consequence of Failure	
Customer		Evidence Surcharge	No	Purpose	Routine assessment
Reviewed By	Juan Bedoya	Reviewer Certificate	U-1020-70400280	Weather	Dry
Is Imperial	No	Inspection Status	Remote Inspection	Media Label	WinCan 14.0
Potential for RunOff	None				

Cover

Cover Type	Solid						
Cover Shape	Circular	Cover Size	23.5"	Center Cover Size		Cover Width	
Cover Material	Cast Iron	Hole Diameter				Hole Number	0
Cover Frame fit	Good	Cover Bearing Surface Diameter	23.0"	Cover Bearing Surface Width			
Cover Condition	Sound						

Cover Insert

Cover Insert Type	None	Insert Condition	
-------------------	-------------	------------------	--

Frame

Frame Material	Cast Iron	Frame Bearing Surface Width	0.5"	Frame Bearing Surface Depth	0.8"
Frame Seal Inflow	None	Frame Clear Open Diameter	31.5"	Frame Clear Open Width	
Frame Depth	2.5"	Frame Offset Distance	0.0"		
Frame Condition	Sound				
Seal Condition	Missing				

Chimney

Chimney Present	Yes	Chimney Material 1	Brick	Chimney Material 2	
Chimney Clear Opening	24.0"	Chimney Depth	1.4'	Chimney Infiltration	Infil Stained
Chimney Condition	Sound	Chimney Lining Interior	None	Chimney Lining Exterior	Not Known

Cone

Cone Type	Conical centered	Cone Material	Brick	Cone Depth	3.9'
Cone Condition	Sound	Cone Lining Interior	None	Cone Lining Exterior	Not Known

Wall

Wall Material	Brick	Wall Diameter	48.0"	Wall By Size	48.0"	Wall Depth	9.4'
Wall Condition	Sound	Wall Lining Exterior	Not Known	Wall Lining Interior	None		

Bench

Bench Condition	Sound	Bench Present	Yes	Bench Material	Concrete (cast in place)	Bench Lining	None
-----------------	--------------	---------------	------------	----------------	---------------------------------	--------------	-------------

QSR	QMR	QOR	SPR	MPR	OPR	SPRI	MPRI	OPRI
4331	3123	4332	20.0	15.0	35.0	2.5	1.5	1.9



Node Inspection - 8/9/2023 - 1842

Date 8/9/2023	Time 12:01	Manhole Number 1842	Access Type Manhole	City Georgetown	Street 101 South Fraser
Surveyed By Matthew Headrick	Certificate Number U-0419-07030528	PO Number	Work Order	Pre-Cleaning No Pre-Cleaning	Sheet Number

Channel

Channel Installed	Yes	Channel Material	Not Known	Channel Type	Formed
Channel Condition	Sound	Channel Exposure	Fully Opened		

Steps

Step Number	4	Step Material	
-------------	----------	---------------	--

Observations

Nr.	Distance	MACP Code	Observation	Remark
1	1.0'	MML	Missing Mortar Large from 12 o'clock to 12 o'clock	Fully exposed bricks with gaps
2	2.4'	IS	Infiltration Stain from 8 o'clock to 5 o'clock, within 8 inch	infiltration stains from chimney cone join
3	2.6'	MML	Missing Mortar Large from 12 o'clock to 12 o'clock	Fully exposed bricks with gaps
4	5.5'	DAR	Deposits Attached Ragging, 5% of cross sectional area from 11 o'clock to 2 o'clock, within 8 inch	rag on steps indicative of surcharge conditions
5	6.4'	SAV	Surface Damage Aggregate Visible from 12 o'clock to 12 o'clock, within 8 inch	aggregate visible on concrete bricks/blocks
6	6.7'	MML	Missing Mortar Large from 12 o'clock to 12 o'clock	Fully exposed bricks with gaps
7	8.7'	IW	Infiltration Weeper from 10 o'clock to 12 o'clock, within 8 inch	infiltration from pipe seal
8	8.9'	IW	Infiltration Weeper from 4 o'clock to 6 o'clock, within 8 inch	minor infiltration 2 points at wall
9	9.5'	OBN	Obstruction Construction Debris, 5% of cross sectional area from 7 o'clock to 9 o'clock	debris on bench

Connections

Pipe Number	Rim To Invert	Direction	Clock Position	Shape	Material	Height	Width	Pipe Condition	Seal Condition	Pipe Type	Structure ID	Comments
1	10.0'	Out	6	Circular	Vitrified Clay Pipe	12"	-	Sound	Sound	Gravity Connection		
2	9.8'	In	12	Circular	Vitrified Clay Pipe	12"	-	Sound	Sound	Gravity Connection		

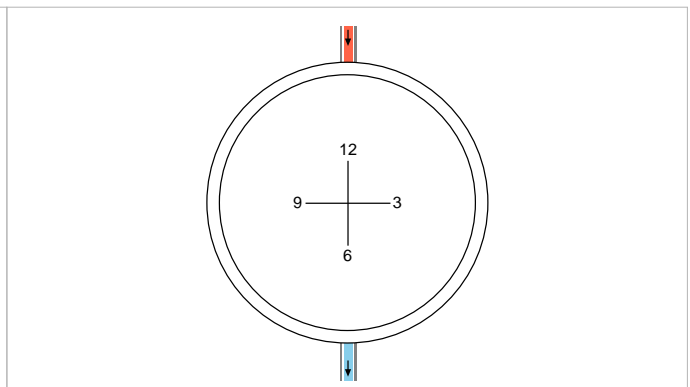
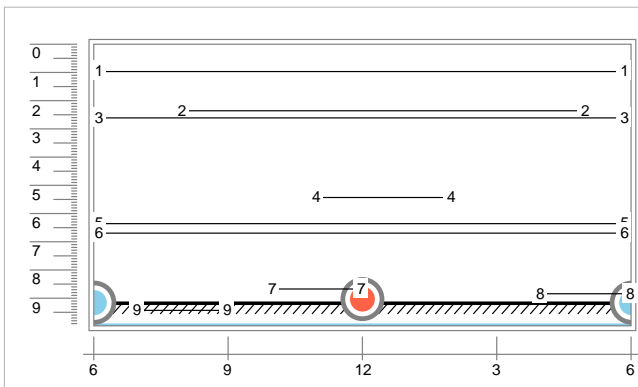

QSR	QMR	QOR	SPR	MPR	OPR	SPRI	MPRI	OPRI
4331	3123	4332	20.0	15.0	35.0	2.5	1.5	1.9



Node 2D Sketch - 8/9/2023 - 1842

Date 8/9/2023	Manhole Number 1842	City Georgetown	Street 101 South Fraser Street	Surveyed By Matthew Headrick
------------------	------------------------	--------------------	-----------------------------------	---------------------------------

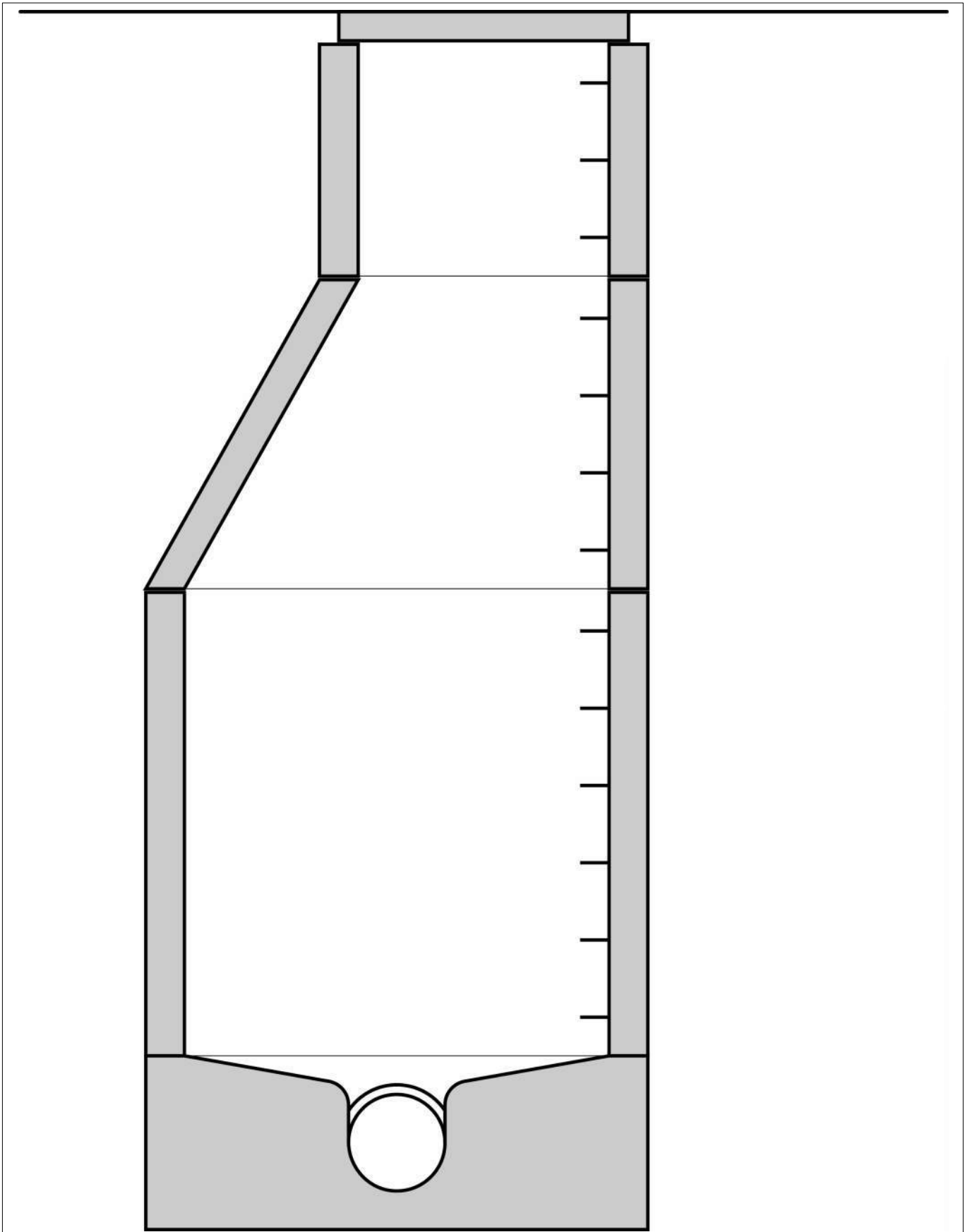



Node Pictures - 8/9/2023 - 1842

Date 8/9/2023	Manhole Number 1842	City Georgetown	Street 101 South Fraser Street	Surveyed By Matthew Headrick
------------------	------------------------	--------------------	-----------------------------------	---------------------------------



1842_98b1de5e-0e50-41ed-b476-ff581fdb636e_6e4dd29f-ca9b-4492-8423-80415962fdbb_PI1.jpg,
00:00:10, 1.00
Missing Mortar Large from 12 o'clock to 12 o'clock



1842_98b1de5e-0e50-41ed-b476-ff581fdb636e_aa2a85a8-e416-49a8-9ee1-a1520a8a9a6f_PI1.jpg,
00:00:17, 2.39
Infiltration Stain from 8 o'clock to 5 o'clock, within 8 inch



Node Pictures - 8/9/2023 - 1842

Date 8/9/2023	Manhole Number 1842	City Georgetown	Street 101 South Fraser Street	Surveyed By Matthew Headrick
------------------	------------------------	--------------------	-----------------------------------	---------------------------------



1842_98b1de5e-0e50-41ed-b476-ff581fdb636e_6920a2a8-262a-48f1-bd0b-801a4acf77ef_PI1.jpg,
00:00:18, 2.64
Missing Mortar Large from 12 o'clock to 12 o'clock



1842_98b1de5e-0e50-41ed-b476-ff581fdb636e_59d47be1-5aec-4a1d-aa9f-42075eb1f695_PI1.jpg,
, 5.45
Deposits Attached Ragging, 5% of cross sectional area from 11 o'clock to 2 o'clock, within 8
inch



Node Pictures - 8/9/2023 - 1842

Date 8/9/2023	Manhole Number 1842	City Georgetown	Street 101 South Fraser Street	Surveyed By Matthew Headrick
------------------	------------------------	--------------------	-----------------------------------	---------------------------------



1842_98b1de5e-0e50-41ed-b476-ff581fdb636e_ec832979-62f8-4c91-8da5-8ac031d99ae4_PI1.jpg,
00:00:32, 6.40
Surface Damage Aggregate Visible from 12 o'clock to 12 o'clock, within 8 inch



1842_98b1de5e-0e50-41ed-b476-ff581fdb636e_dcbefd8a-b7e6-401c-9a30-5acdf49e2291_PI1.jpg,
00:00:33, 6.73
Missing Mortar Large from 12 o'clock to 12 o'clock



Node Pictures - 8/9/2023 - 1842

Date 8/9/2023	Manhole Number 1842	City Georgetown	Street 101 South Fraser Street	Surveyed By Matthew Headrick
------------------	------------------------	--------------------	-----------------------------------	---------------------------------



1842_98b1de5e-0e50-41ed-b476-ff581fdb636e_bb003c6b-c5eb-4aa5-a173-ba34dc52eeb9_PI1.jpg,
00:00:42, 8.72
Infiltration Weeper from 10 o'clock to 12 o'clock, within 8 inch



1842_98b1de5e-0e50-41ed-b476-ff581fdb636e_20bb308d-109f-4d91-8794-926c0ba74d99_PI1.jpg,
00:00:42, 8.87
Infiltration Weeper from 4 o'clock to 6 o'clock, within 8 inch



Node Pictures - 8/9/2023 - 1842

Date 8/9/2023	Manhole Number 1842	City Georgetown	Street 101 South Fraser Street	Surveyed By Matthew Headrick
------------------	------------------------	--------------------	-----------------------------------	---------------------------------



1842_98b1de5e-0e50-41ed-b476-ff581fdb636e_da26af56-9524-4d1f-8dc6-a1a065c0e713_P11.jpg,
00:00:43, 9.47
Obstruction Construction Debris, 5% of cross sectional area from 7 o'clock to 9 o'clock



Node Drawings - 8/9/2023 - 1842

Date 8/9/2023	Manhole Number 1842	City Georgetown	Street 101 South Fraser Street	Surveyed By Matthew Headrick
------------------	------------------------	--------------------	-----------------------------------	---------------------------------

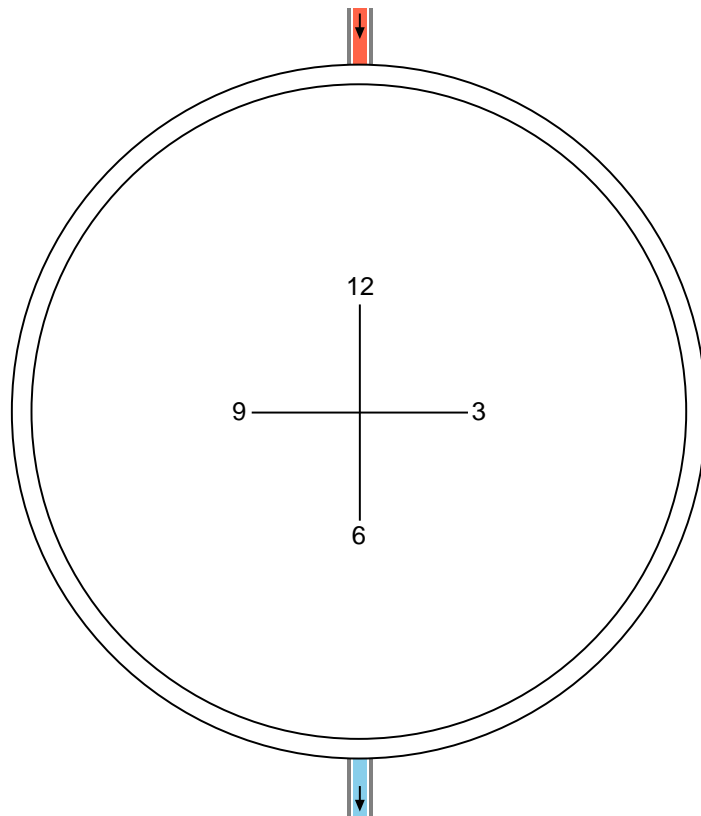
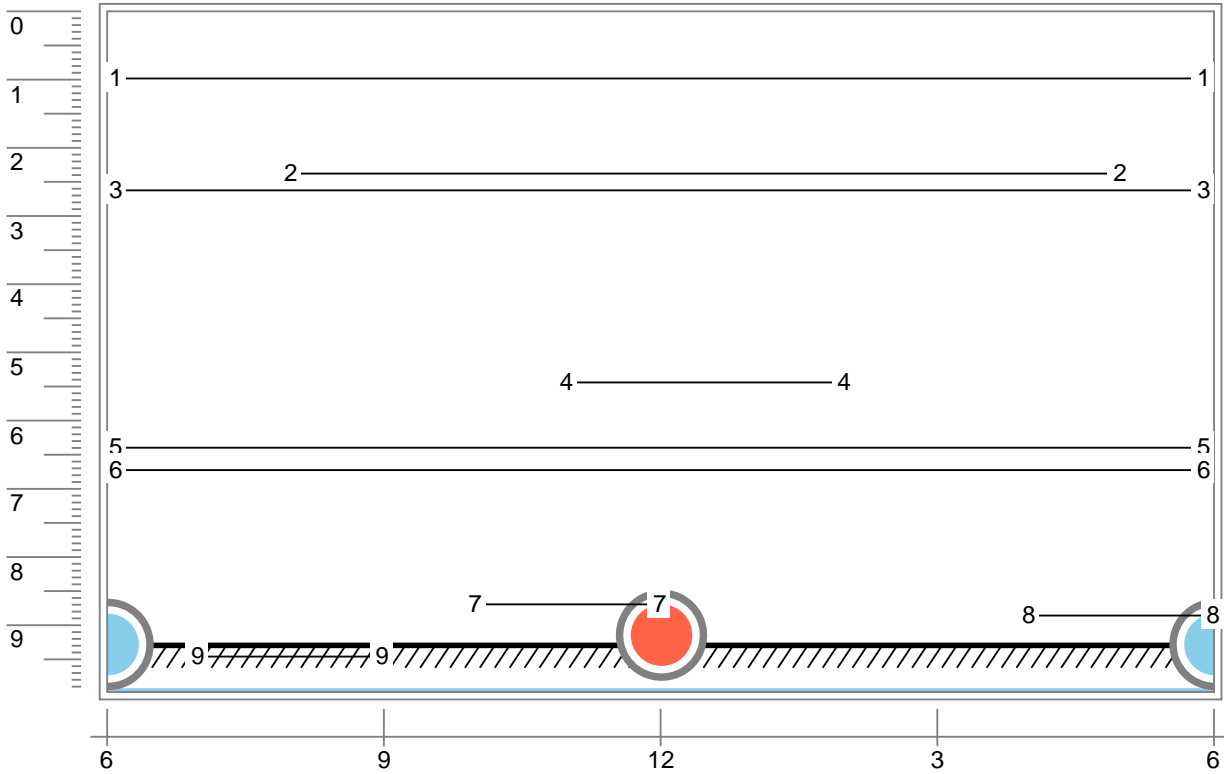



CleverScan - 8/9/2023 - 1842

Date 8/9/2023	Manhole Number 1842	City Georgetown	Street 101 South Fraser Street	Surveyed By Matthew Headrick
------------------	------------------------	--------------------	-----------------------------------	---------------------------------

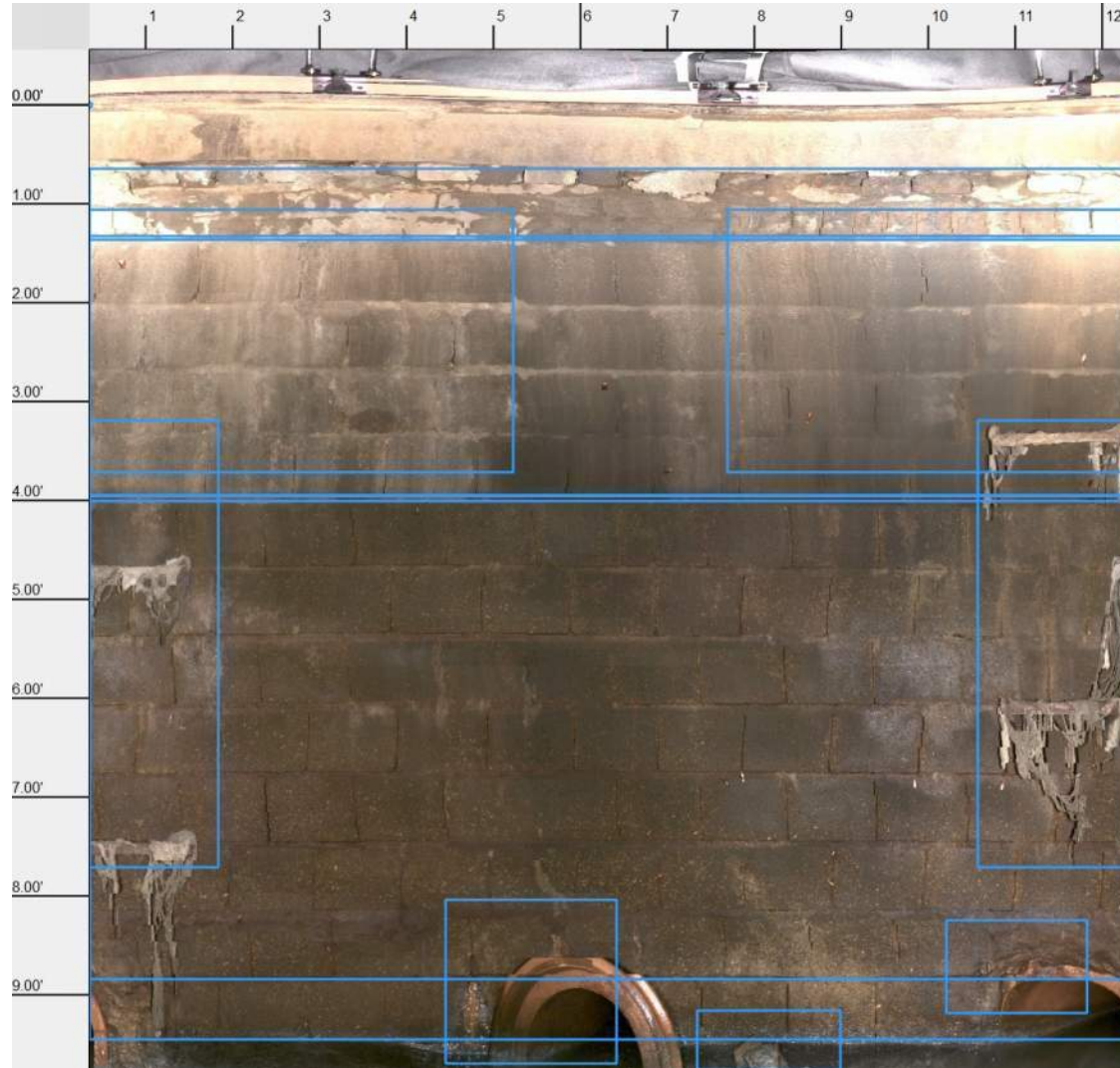



Node Inspection - 8/14/2023 - 1831

Date 8/14/2023	Time 20:35	Manhole Number 1831	Access Type Manhole	City Georgetown	Street 334 Fraser Street
Surveyed By Matthew Headrick	Certificate Number U-0419-07030528	PO Number	Work Order	Pre-Cleaning No Pre-Cleaning	Sheet Number

General Manhole Information

MH Use	Sanitary	Year Constructed		Year Renewed		Owner	City of Georgetown
Rim to Invert	8.0'	Grade to Invert	8.0'	Rim to Grade	0.0'	Rim to Grade Exposed	0.0'
Surface Type	Asphalt						
Location Code	Light Highway	Location Details					
Additional component information							

General Manhole Inspection Information

Date Cleaned		Inspection Level	Level 2	Consequence of Failure	
Customer		Evidence Surcharge	No	Purpose	Routine assessment
Reviewed By	Juan Bedoya	Reviewer Certificate	U-1020-70400280	Weather	Dry
Is Imperial	No	Inspection Status	Remote Inspection	Media Label	WinCan 14.0
Potential for RunOff	Ponding				

Cover

Cover Type	Solid						
Cover Shape	Circular	Cover Size	34.1"	Center Cover Size		Cover Width	
Cover Material	Cast Iron	Hole Diameter				Hole Number	0
Cover Frame fit	Good	Cover Bearing Surface Diameter	34.0"	Cover Bearing Surface Width			
Cover Condition	Sound						

Cover Insert

Cover Insert Type	None	Insert Condition	
-------------------	-------------	------------------	--

Frame

Frame Material	Cast Iron	Frame Bearing Surface Width	1.0"	Frame Bearing Surface Depth	1.5"
Frame Seal Inflow	None	Frame Clear Open Diameter	31.5"	Frame Clear Open Width	
Frame Depth	3.0"	Frame Offset Distance	0.0"		
Frame Condition	Sound				
Seal Condition	Missing				

Chimney

Chimney Present	Yes	Chimney Material 1	Brick	Chimney Material 2	
Chimney Clear Opening	24.0"	Chimney Depth	2.6'	Chimney Infiltration	None
Chimney Condition	Sound	Chimney Lining Interior	None	Chimney Lining Exterior	Not Known

Cone

Cone Type	Conical centered	Cone Material	Brick	Cone Depth	4.1'
Cone Condition	Sound	Cone Lining Interior	None	Cone Lining Exterior	Not Known

Wall

Wall Material	Brick	Wall Diameter	48.0"	Wall By Size	48.0"	Wall Depth	7.0'
Wall Condition	Sound	Wall Lining Exterior	Not Known	Wall Lining Interior	None		

Bench

Bench Condition	Sound	Bench Present	Yes	Bench Material	Concrete (cast in place)	Bench Lining	None
-----------------	--------------	---------------	------------	----------------	---------------------------------	--------------	-------------

QSR	QMR	QOR	SPR	MPR	OPR	SPRI	MPRI	OPRI
4331	3121	4332	18.0	12.0	30.0	2.6	1.3	1.9



Node Inspection - 8/14/2023 - 1831

Date 8/14/2023	Time 20:35	Manhole Number 1831	Access Type Manhole	City Georgetown	Street 334 Fraser Street
Surveyed By Matthew Headrick	Certificate Number U-0419-07030528	PO Number	Work Order	Pre-Cleaning No Pre-Cleaning	Sheet Number

Channel

Channel Installed	Yes	Channel Material	Vitrified Clay	Channel Type	Pipe
Channel Condition	Sound	Channel Exposure	Fully Opened		

Steps

Step Number	2	Step Material	Metal
-------------	----------	---------------	--------------

Observations

Nr.	Distance	MACP Code	Observation	Remark
1	1.5'	MML	Missing Mortar Large from 12 o'clock to 12 o'clock	vfully exposed bricks with gaps
2	1.5'	IS	Infiltration Stain from 7 o'clock to 2 o'clock, within 8 inch	stains inf
3	3.2'	MML	Missing Mortar Large from 12 o'clock to 12 o'clock	fully exposed bricks with gaps
4	5.5'	MML	Missing Mortar Large from 12 o'clock to 12 o'clock	fully exposed bricks with gaps
5	6.2'	IW	Infiltration Weeper from 1 o'clock to 9 o'clock, within 8 inch	minor infiltration from bricks
6	6.8'	IS	Infiltration Stain from 7 o'clock to 12 o'clock, within 8 inch	stained brick
7	7.0'	OBN	Obstruction Construction Debris, 5% of cross sectional area from 1 o'clock to 4 o'clock	rocks on bench
8	7.3'	SAP	Surface Damage Aggregate Projecting from 11 o'clock to 2 o'clock, within 8 inch, Start	

Connections

Pipe Number	Rim To Invert	Directio	Clock Position	Shape	Material	Height	Width	Pipe Condition	Seal Condition	Pipe Type	Structure ID	Comments
1	8.0'	Out	6	Circular	Vitrified Clay Pipe	12"	-	Sound	Sound	Gravity Connection		
2	5.3'	In	9	Circular	Vitrified Clay Pipe	8"	-	Sound	Sound	Gravity Connection		
3	7.9'	In	12	Circular	Vitrified Clay Pipe	12"	-	Sound	Sound	Gravity Connection		

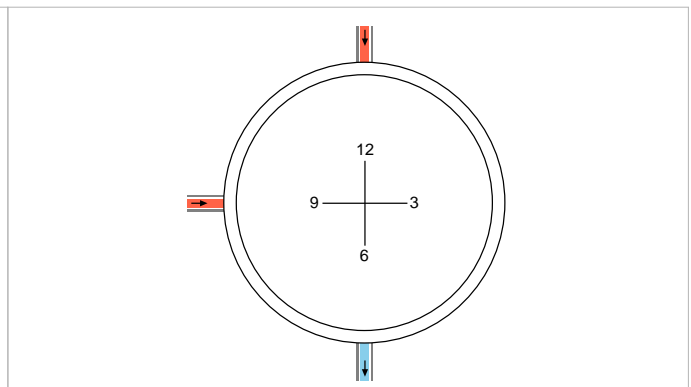
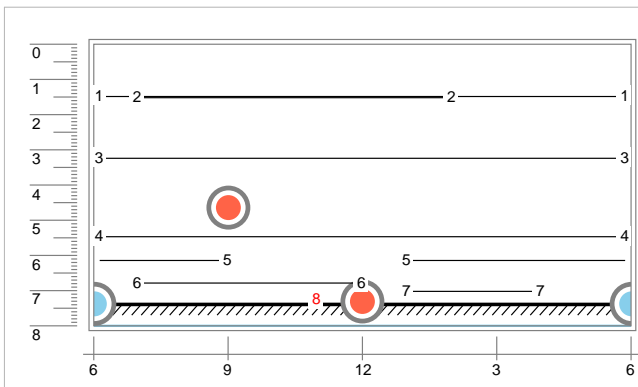

QSR	QMR	QOR	SPR	MPR	OPR	SPRI	MPRI	OPRI
4331	3121	4332	18.0	12.0	30.0	2.6	1.3	1.9



Node 2D Sketch - 8/14/2023 - 1831

Date 8/14/2023	Manhole Number 1831	City Georgetown	Street 334 Fraser Street	Surveyed By Matthew Headrick
-------------------	------------------------	--------------------	-----------------------------	---------------------------------

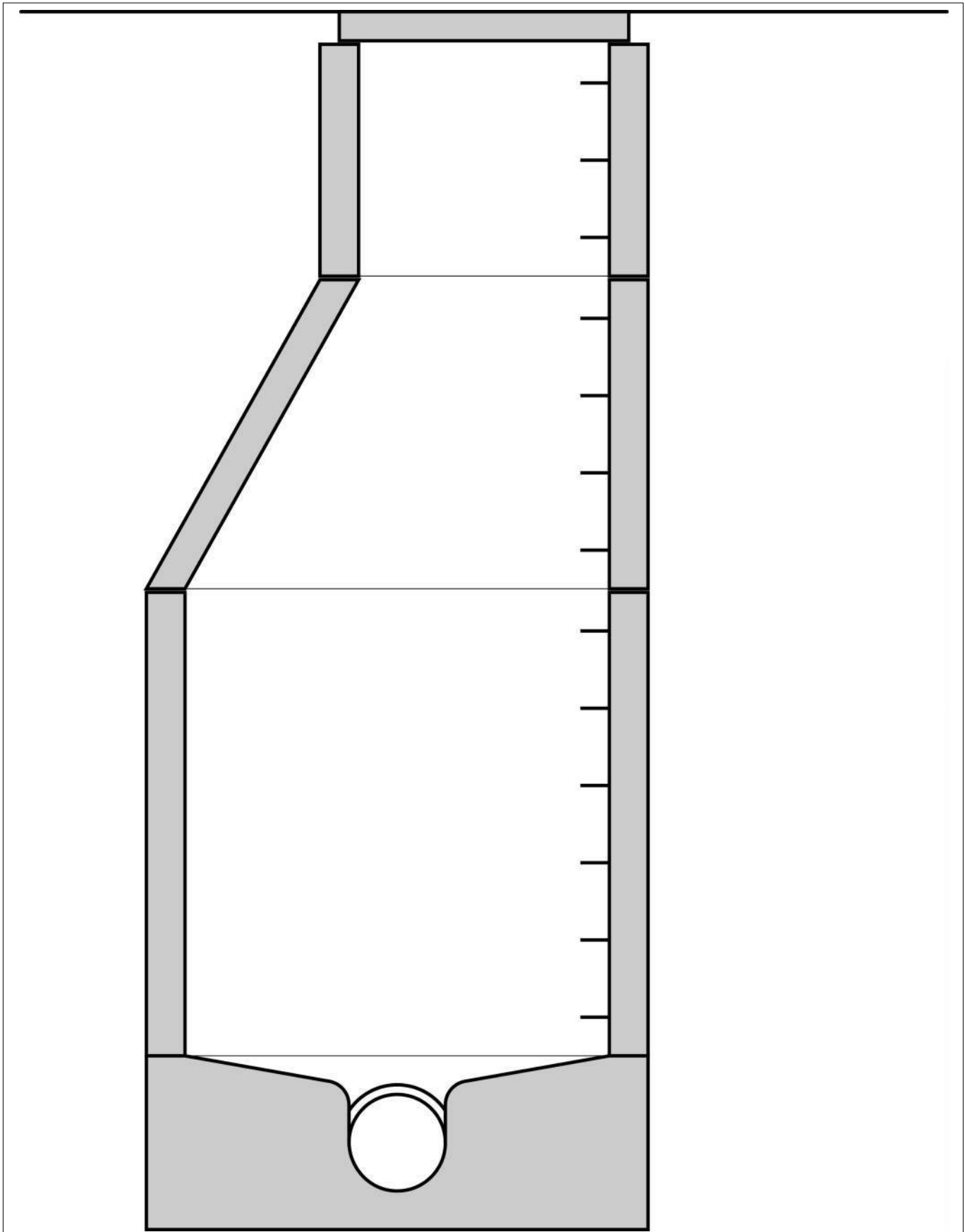



Node Pictures - 8/14/2023 - 1831

Date 8/14/2023	Manhole Number 1831	City Georgetown	Street 334 Fraser Street	Surveyed By Matthew Headrick
-------------------	------------------------	--------------------	-----------------------------	---------------------------------



1831_511dce6f-34cf-4134-8589-97e8cd9b2803_08a2a119-0b33-4ac0-aeaf-df97445384cd_PI1.jpg,
, 1.49
Missing Mortar Large from 12 o'clock to 12 o'clock



1831_511dce6f-34cf-4134-8589-97e8cd9b2803_88dfd25-526c-4368-a44f-9a542564fddd_PI1.jpg,
00:00:12, 1.54
Infiltration Stain from 7 o'clock to 2 o'clock, within 8 inch



Node Pictures - 8/14/2023 - 1831

Date 8/14/2023	Manhole Number 1831	City Georgetown	Street 334 Fraser Street	Surveyed By Matthew Headrick
-------------------	------------------------	--------------------	-----------------------------	---------------------------------



1831_511dce6f-34cf-4134-8589-97e8cd9b2803_25daea92-acd2-4201-a301-2eaaa0f1d117_P11.jpg,
00:00:18, 3.24
Missing Mortar Large from 12 o'clock to 12 o'clock



1831_511dce6f-34cf-4134-8589-97e8cd9b2803_367c9464-e72c-4588-83a0-4bdce23a220f_P11.jpg,
00:00:27, 5.49
Missing Mortar Large from 12 o'clock to 12 o'clock



Node Pictures - 8/14/2023 - 1831

Date 8/14/2023	Manhole Number 1831	City Georgetown	Street 334 Fraser Street	Surveyed By Matthew Headrick
-------------------	------------------------	--------------------	-----------------------------	---------------------------------



1831_511dce6f-34cf-4134-8589-97e8cd9b2803_68fc3d96-c177-4386-b216-8c69251a096f_P11.jpg,
00:00:30, 6.18
Infiltration Weeper from 1 o'clock to 9 o'clock, within 8 inch



1831_511dce6f-34cf-4134-8589-97e8cd9b2803_ad7a6b38-3803-4d93-8950-c59468f78ae6_P11.jpg,
00:00:32, 6.81
Infiltration Stain from 7 o'clock to 12 o'clock, within 8 inch



Node Pictures - 8/14/2023 - 1831

Date 8/14/2023	Manhole Number 1831	City Georgetown	Street 334 Fraser Street	Surveyed By Matthew Headrick
-------------------	------------------------	--------------------	-----------------------------	---------------------------------



1831_511dce6f-34cf-4134-8589-97e8cd9b2803_f6d5ccc0-e1d8-4e3e-8fe5-b6471e9965fe_PI1.jpg,
00:00:33, 7.05
Obstruction Construction Debris, 5% of cross sectional area from 1 o'clock to 4 o'clock



1831_511dce6f-34cf-4134-8589-97e8cd9b2803_26edafcf-9755-414d-ac9d-c19aa6e5a345_PI1.jpg,
00:00:33, 7.29
Surface Damage Aggregate Projecting from 11 o'clock to 2 o'clock, within 8 inch, Start



Node Drawings - 8/14/2023 - 1831

Date
8/14/2023

Manhole Number
1831

City
Georgetown

Street
334 Fraser Street

Surveyed By
Matthew Headrick

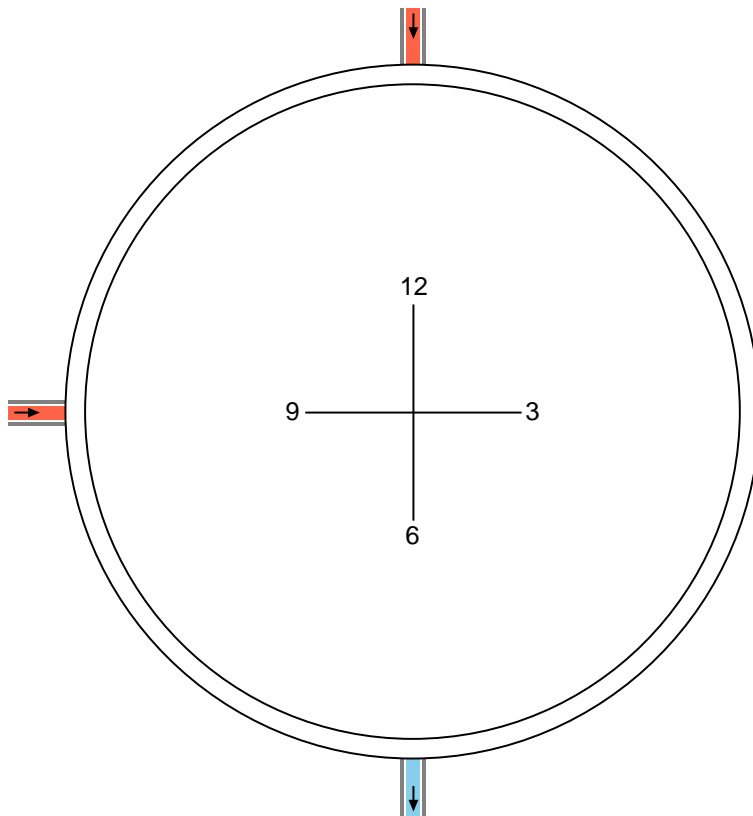
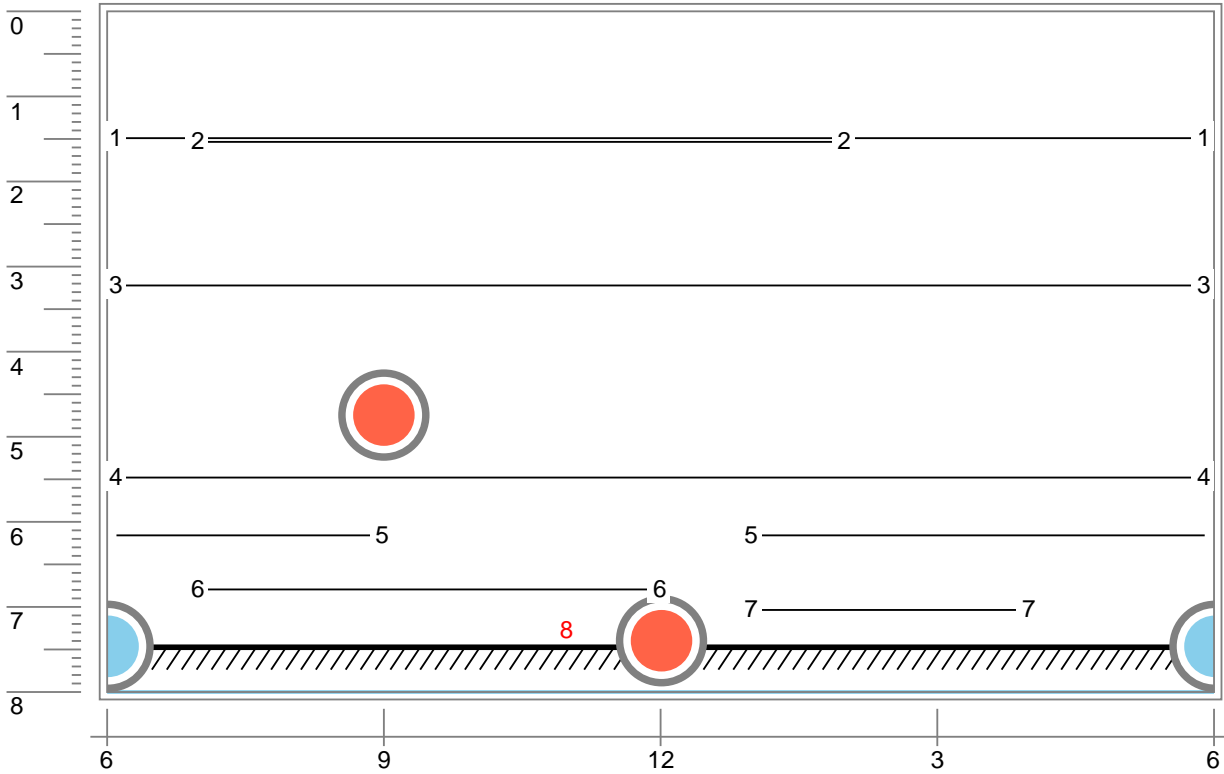



CleverScan - 8/14/2023 - 1831

Date 8/14/2023	Manhole Number 1831	City Georgetown	Street 334 Fraser Street	Surveyed By Matthew Headrick
-------------------	------------------------	--------------------	-----------------------------	---------------------------------

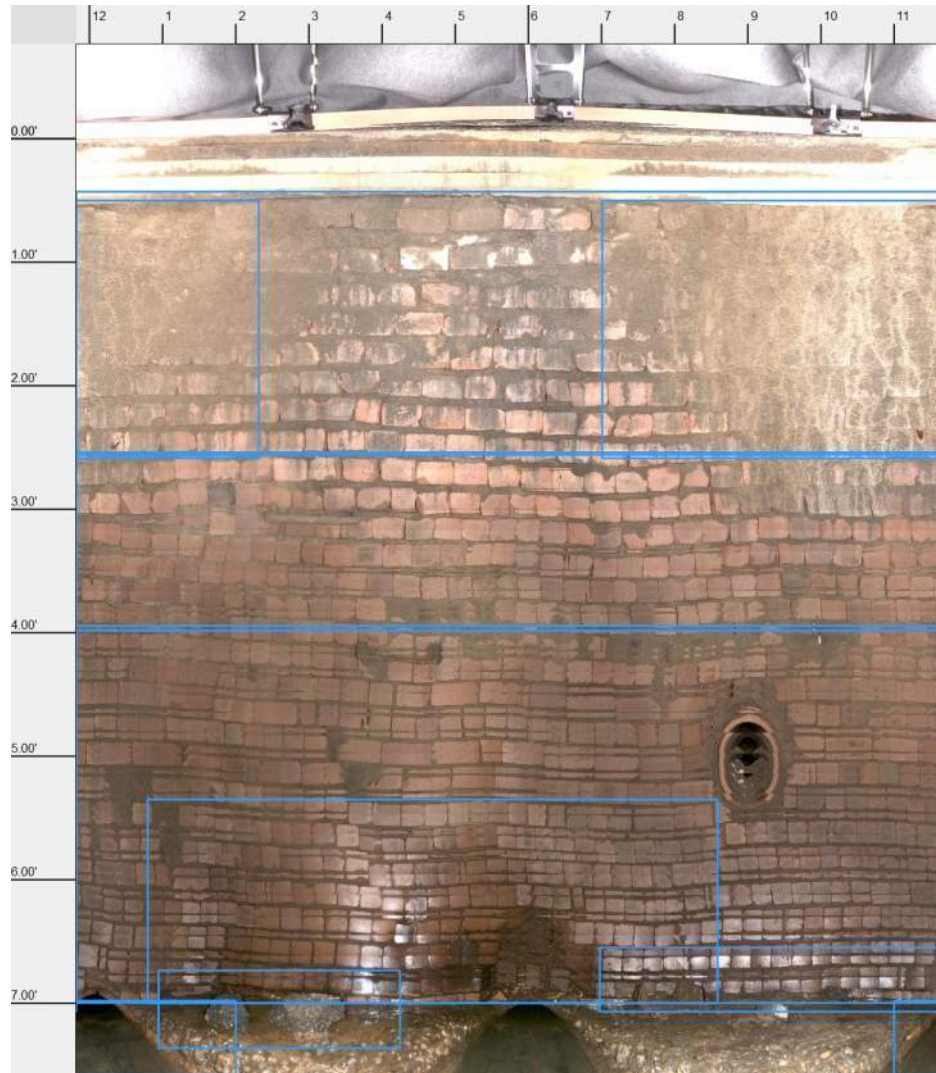



Node Inspection - 8/9/2023 - 1818

Date 8/9/2023	Time 10:49	Manhole Number 1818	Access Type Manhole	City Georgetown	Street 540 South Fraser
Surveyed By Matthew Headrick	Certificate Number U-0419-07030528	PO Number	Work Order	Pre-Cleaning No Pre-Cleaning	Sheet Number

General Manhole Information

MH Use Sanitary	Year Constructed	Year Renewed	Owner City of Georgetown
Rim to Invert 9.6'	Grade to Invert 9.6'	Rim to Grade 0.0'	Rim to Grade Exposed 0.0'
Surface Type Asphalt			
Location Code Light Highway	Location Details		
Additional component information			

General Manhole Inspection Information

Date Cleaned	Inspection Level Level 2	Consequence of Failure
Customer	Evidence Surcharge No	Purpose Routine assessment
Reviewed By Juan Bedoya	Reviewer Certificate U-1020-70400280	Weather Dry
Is Imperial No	Inspection Status Remote Inspection	Media Label WinCan 14.0
Potential for RunOff None		

Cover

Cover Type Solid					
Cover Shape Circular	Cover Size 23.5"	Center Cover Size	Cover Width		
Cover Material Cast Iron	Hole Diameter	Hole Number 0			
Cover Frame fit Good	Cover Bearing Surface Diameter 23.0"	Cover Bearing Surface Width			
Cover Condition Sound					

Cover Insert

Cover Insert Type None	Insert Condition
----------------------------------	------------------

Frame

Frame Material Cast Iron	Frame Bearing Surface Width 1.5"	Frame Bearing Surface Depth 1.0"
Frame Seal Inflow None	Frame Clear Open Diameter 22.0"	Frame Clear Open Width
Frame Depth 3.0"	Frame Offset Distance 0.0"	
Frame Condition Sound		
Seal Condition Missing		

Chimney

Chimney Present Yes	Chimney Material 1 Brick	Chimney Material 2
Chimney Clear Opening 22.0"	Chimney Depth 2.8'	Chimney Infiltration Infil Stained
Chimney Condition Sound	Chimney Lining Interior None	Chimney Lining Exterior Not Known

Cone

Cone Type Conical centered	Cone Material Brick	Cone Depth 5.8'
Cone Condition Sound	Cone Lining Interior None	Cone Lining Exterior Not Known

Wall

Wall Material Brick	Wall Diameter 45.8"	Wall By Size 45.8"	Wall Depth 8.7'
Wall Condition Sound	Wall Lining Exterior Not Known	Wall Lining Interior None	

Bench

Bench Condition Sound	Bench Present Yes	Bench Material Concrete (cast in place)	Bench Lining None
---------------------------------	-----------------------------	---	-----------------------------

QSR	QMR	QOR	SPR	MPR	OPR	SPRI	MPRI	OPRI
4331	3222	4333	18.0	13.0	31.0	2.6	1.9	2.2



Node Inspection - 8/9/2023 - 1818

Date 8/9/2023	Time 10:49	Manhole Number 1818	Access Type Manhole	City Georgetown	Street 540 South Fraser
Surveyed By Matthew Headrick	Certificate Number U-0419-07030528	PO Number	Work Order	Pre-Cleaning No Pre-Cleaning	Sheet Number

Channel

Channel Installed	Yes	Channel Material	Vitrified Clay	Channel Type	Pipe
Channel Condition	Sound	Channel Exposure	Fully Opened		

Observations

Nr.	Distance	MACP Code	Observation	Remark
1	1.8'	MML	Missing Mortar Large from 12 o'clock to 12 o'clock	fully exposed brick with gaps
2	4.2'	MML	Missing Mortar Large from 12 o'clock to 12 o'clock	fully exposed brick with gaps
3	6.2'	ID	Infiltration Dripper from 12 o'clock to 2 o'clock, within 8 inch	infiltration from pipe seal
4	7.2'	MML	Missing Mortar Large from 12 o'clock to 12 o'clock	fully exposed brick with gaps
5	8.1'	IW	Infiltration Weeper from 5 o'clock to 7 o'clock, within 8 inch	infiltration from bricks
6	8.7'	IS	Infiltration Stain from 7 o'clock to 12 o'clock, within 8 inch	inf stains

Connections

Pipe Number	Rim To Invert	Direction	Clock Position	Shape	Material	Height	Width	Pipe Condition	Seal Condition	Pipe Type	Structure ID	Comments
1	9.6'	In	6	Circular	Vitrified Clay Pipe	12"	-	Sound	Sound	Gravity Connection		
2	9.6'	In	9	Circular	Vitrified Clay Pipe	12"	-	Sound	Sound	Gravity Connection		
3	5.2'	In	1	Circular	Vitrified Clay Pipe	8"	-	Sound	Sound	Gravity Connection		
4	8.9'	In	1	Circular	Vitrified Clay Pipe	8"	-	Sound	Sound	Gravity Connection		

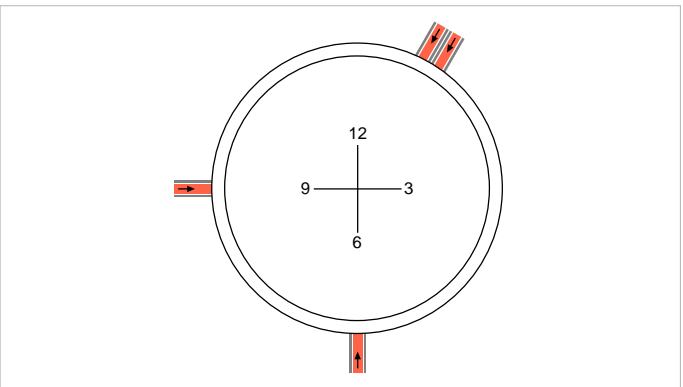
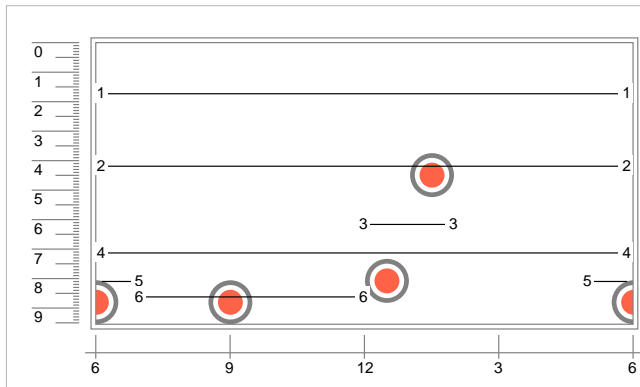

QSR	QMR	QOR	SPR	MPR	OPR	SPRI	MPRI	OPRI
4331	3222	4333	18.0	13.0	31.0	2.6	1.9	2.2



Node 2D Sketch - 8/9/2023 - 1818

Date 8/9/2023	Manhole Number 1818	City Georgetown	Street 540 South Fraser Street	Surveyed By Matthew Headrick
------------------	------------------------	--------------------	-----------------------------------	---------------------------------

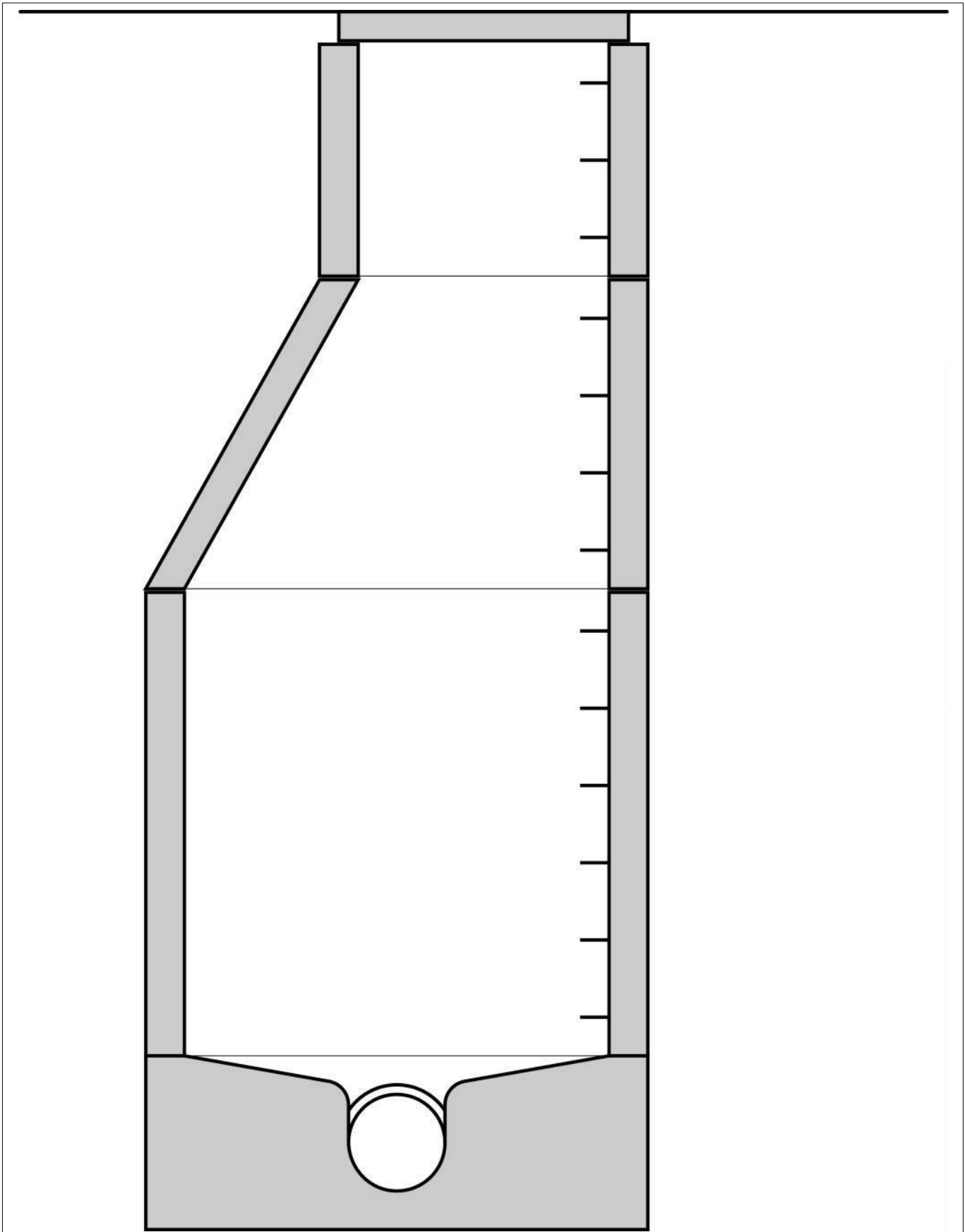



Node Pictures - 8/9/2023 - 1818

Date 8/9/2023	Manhole Number 1818	City Georgetown	Street 540 South Fraser Street	Surveyed By Matthew Headrick
------------------	------------------------	--------------------	-----------------------------------	---------------------------------



1818_a75925b2-5868-48ca-b1fe-f6e00ecc4562_2fa619db-9017-4731-8de7-af26d82f40cc_P11.jpg,
1.76
Missing Mortar Large from 12 o'clock to 12 o'clock



1818_a75925b2-5868-48ca-b1fe-f6e00ecc4562_f686146f-7c19-45e6-84c8-ca697ba48ffe_P11.jpg,
00:00:19, 4.21
Missing Mortar Large from 12 o'clock to 12 o'clock



Node Pictures - 8/9/2023 - 1818

Date 8/9/2023	Manhole Number 1818	City Georgetown	Street 540 South Fraser Street	Surveyed By Matthew Headrick
------------------	------------------------	--------------------	-----------------------------------	---------------------------------



1818_a75925b2-5868-48ca-b1fe-f6e00ecc4562_5ad39124-75a8-4790-880a-2cad4d512614_P11.jpg,
00:00:27, 6.17
Infiltration Dripper from 12 o'clock to 2 o'clock, within 8 inch



1818_a75925b2-5868-48ca-b1fe-f6e00ecc4562_dd159dc7-5399-49fc-888f-b48a01663db8_P11.jpg,
00:00:31, 7.17
Missing Mortar Large from 12 o'clock to 12 o'clock



Node Pictures - 8/9/2023 - 1818

Date 8/9/2023	Manhole Number 1818	City Georgetown	Street 540 South Fraser Street	Surveyed By Matthew Headrick
------------------	------------------------	--------------------	-----------------------------------	---------------------------------



1818_a75925b2-5868-48ca-b1fe-f6e0ecc4562_e8967312-3d74-46f8-a9cd-e2c4d6f5cb14_P11.jpg,
00:00:35, 8.12
Infiltration Weeper from 5 o'clock to 7 o'clock, within 8 inch



1818_a75925b2-5868-48ca-b1fe-f6e0ecc4562_8e3fa862-3c75-4213-aac0-620618a96e8d_P11.jpg,
00:00:36, 8.66
Infiltration Stain from 7 o'clock to 12 o'clock, within 8 inch



Node Drawings - 8/9/2023 - 1818

Date 8/9/2023	Manhole Number 1818	City Georgetown	Street 540 South Fraser Street	Surveyed By Matthew Headrick
------------------	------------------------	--------------------	-----------------------------------	---------------------------------

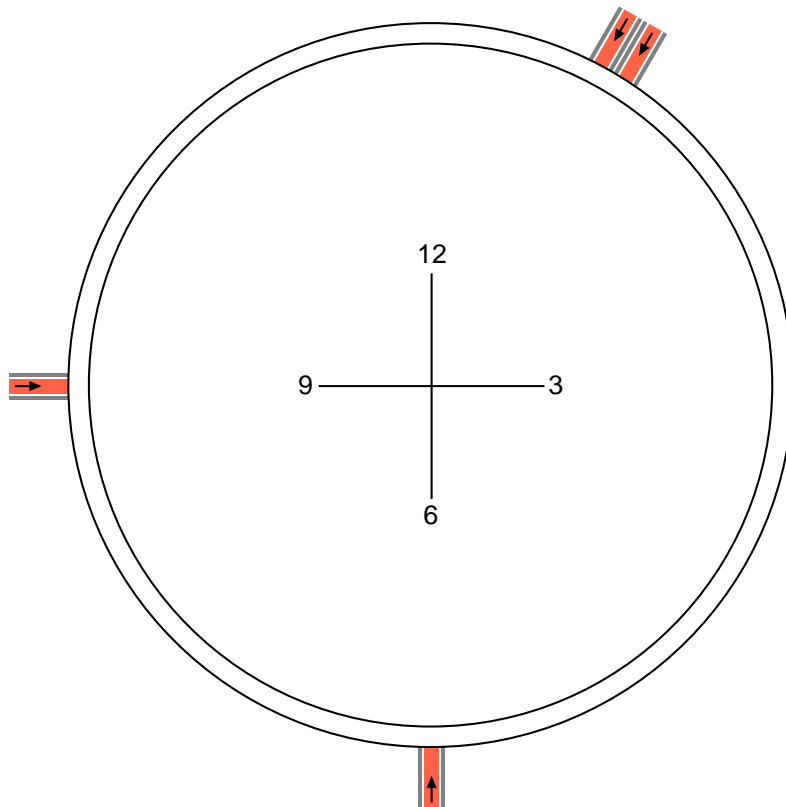
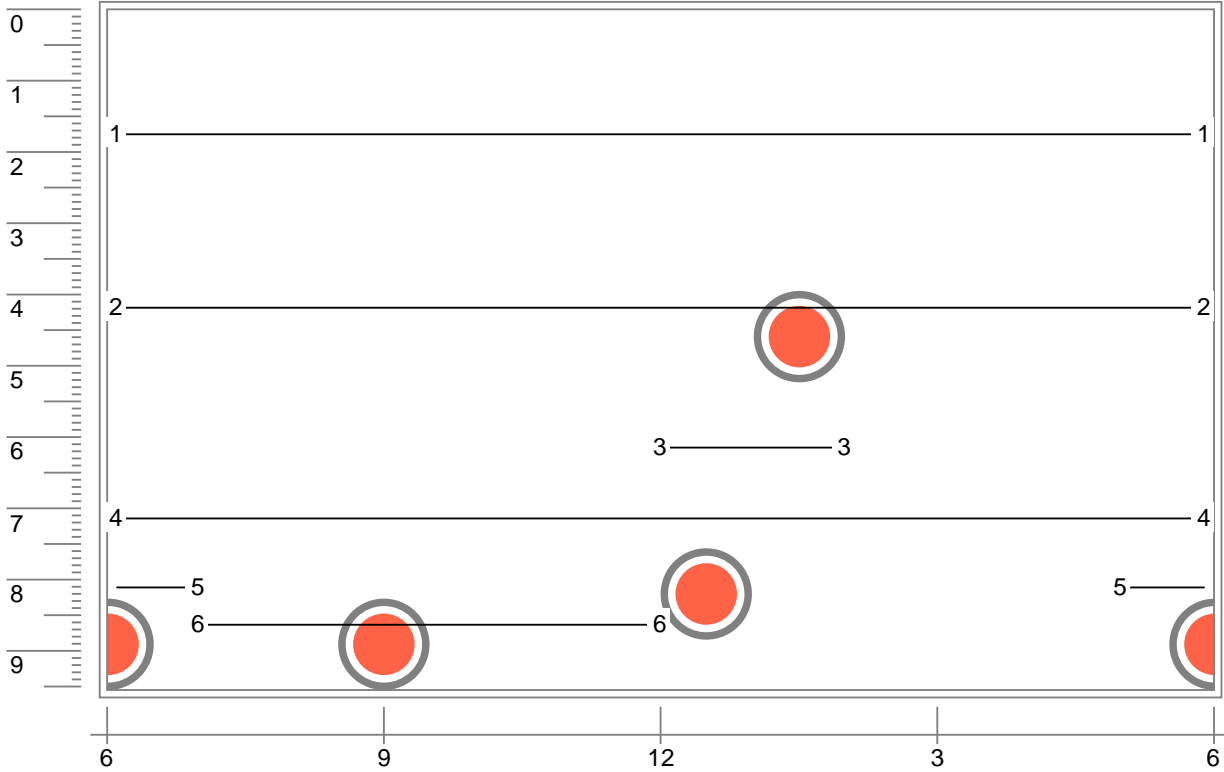



CleverScan - 8/9/2023 - 1818

Date 8/9/2023	Manhole Number 1818	City Georgetown	Street 540 South Fraser Street	Surveyed By Matthew Headrick
------------------	------------------------	--------------------	-----------------------------------	---------------------------------

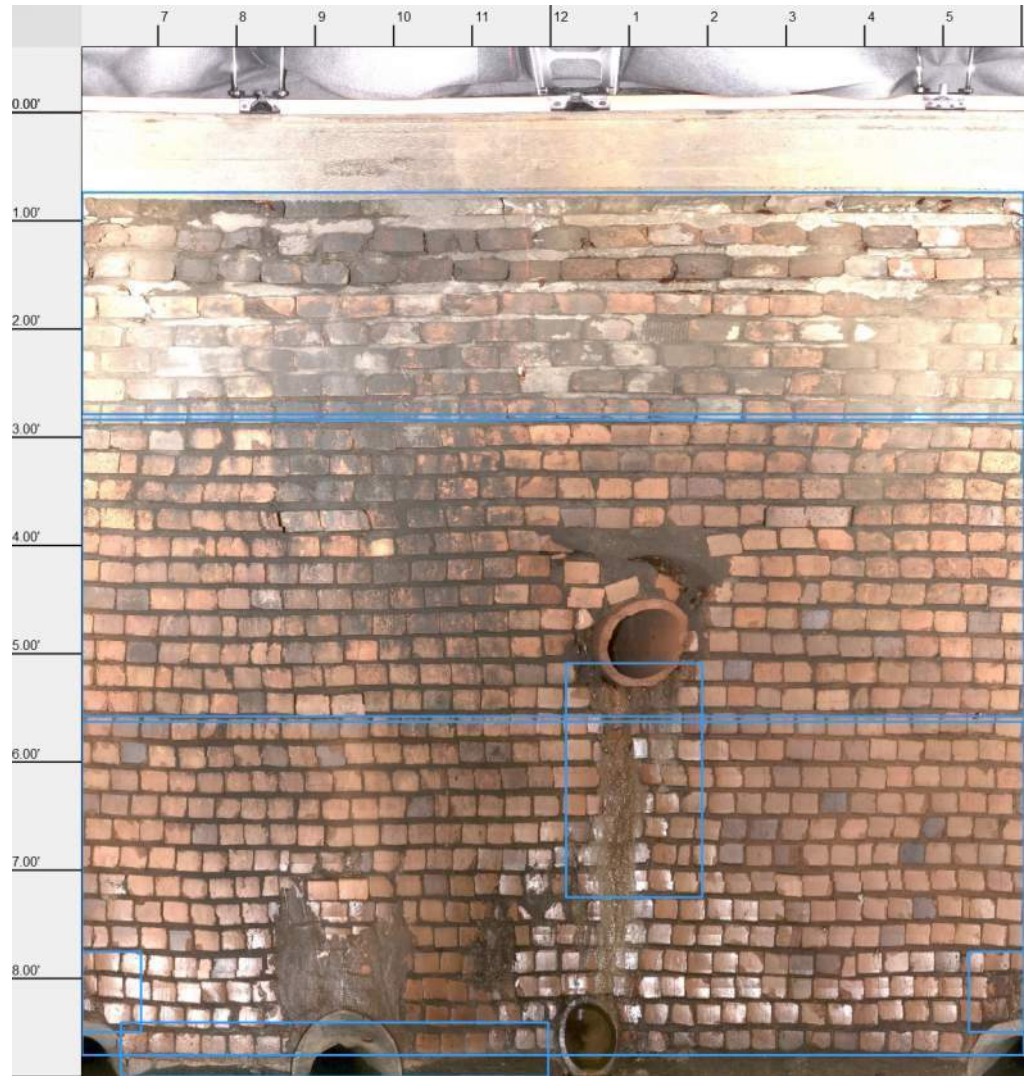



Node Inspection - 8/14/2023 - 2194

Date 8/14/2023	Time 22:11	Manhole Number 2194	Access Type Manhole	City Georgetown	Street 1406 Bourne Street
Surveyed By Matthew Headrick	Certificate Number U-0419-07030528	PO Number	Work Order	Pre-Cleaning No Pre-Cleaning	Sheet Number

General Manhole Information

MH Use Sanitary	Year Constructed	Year Renewed	Owner City of Georgetown
Rim to Invert 4.2'	Grade to Invert 4.2'	Rim to Grade 0.0'	Rim to Grade Exposed 0.0'
Surface Type Asphalt	Location Code Light Highway		
Location Code	Location Details 24' East of MH 2193	Additional component information	

General Manhole Inspection Information

Date Cleaned	Inspection Level Level 2	Consequence of Failure
Customer	Evidence Surcharge No	Purpose Routine assessment
Reviewed By Juan Bedoya	Reviewer Certificate U-1020-70400280	Weather Dry
Is Imperial No	Inspection Status Remote Inspection	Media Label WinCan 14.0
Potential for RunOff None		

Cover

Cover Type Solid	Cover Shape Circular	Cover Size 34.1"	Center Cover Size	Cover Width
Cover Material Cast Iron	Hole Diameter	Hole Number 0	Cover Frame fit Good	
Cover Bearing Surface Diameter	22.0"	Cover Bearing Surface Width	Cover Condition Sound	

Cover Insert

Cover Insert Type None	Insert Condition
----------------------------------	------------------

Frame

Frame Material Cast Iron	Frame Bearing Surface Width 0.5"	Frame Bearing Surface Depth 1.0"
Frame Seal Inflow None	Frame Clear Open Diameter 22.5"	Frame Clear Open Width
Frame Depth 8.0"	Frame Offset Distance 0.0"	
Frame Condition Sound	Seal Condition Missing	

Chimney

Chimney Present Yes	Chimney Material 1 Brick	Chimney Material 2
Chimney Clear Opening 22.8"	Chimney Depth 1.4'	Chimney Infiltration None
Chimney Condition Sound	Chimney Lining Interior None	Chimney Lining Exterior Not Known

Cone

Cone Type Conical centered	Cone Material Brick	Cone Depth 2.9'
Cone Condition Sound	Cone Lining Interior None	Cone Lining Exterior Not Known

Wall

Wall Material Brick	Wall Diameter 44.3"	Wall By Size 44.3"	Wall Depth 3.4'
Wall Condition Sound	Wall Lining Exterior Not Known	Wall Lining Interior None	

Bench

Bench Condition Sound	Bench Present Yes	Bench Material Concrete (cast in place)	Bench Lining None
---------------------------------	-----------------------------	---	-----------------------------

QSR	QMR	QOR	SPR	MPR	OPR	SPRI	MPRI	OPRI
4232	3121	4233	17.0	9.0	26.0	2.4	1.5	2.0



Node Inspection - 8/14/2023 - 2194

Date 8/14/2023	Time 22:11	Manhole Number 2194	Access Type Manhole	City Georgetown	Street 1406 Bourne Street
Surveyed By Matthew Headrick	Certificate Number U-0419-07030528	PO Number	Work Order	Pre-Cleaning No Pre-Cleaning	Sheet Number

Channel

Channel Installed	Yes	Channel Material	Concrete (cast in place)	Channel Type	Formed
Channel Condition	Sound	Channel Exposure	Fully Opened		

Observations

Nr.	Distance	MACP Code	Observation	Remark
1	0.7'	MMM	Missing Mortar Medium from 12 o'clock to 12 o'clock	minor brick showing
2	2.0'	MML	Missing Mortar Large from 12 o'clock to 12 o'clock	fully exposed bricks open gaps
3	3.2'	MML	Missing Mortar Large from 12 o'clock to 12 o'clock	fully exposed bricks open gaps
4	3.7'	DSGV	Deposits Settled Gravel, 30% of cross sectional area from 9 o'clock to 2 o'clock, within 8 inch	deposits on bench

Connections

Pipe Number	Rim To Invert	Direction	Clock Position	Shape	Material	Height	Width	Pipe Condition	Seal Condition	Pipe Type	Structure ID	Comments
1	4.2'	Out	6	Circular	Vitrified Clay Pipe	8"	-	Sound	Sound	Gravity Connection		
2	3.9'	In	9	Circular	Vitrified Clay Pipe	6"	-	Sound	Sound	Lateral to Building		
3	4.0'	In	2	Circular	Vitrified Clay Pipe	6"	-	Sound	Sound	Lateral to Building		

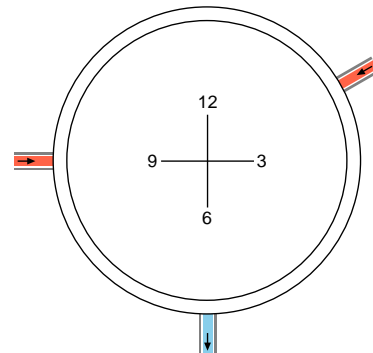
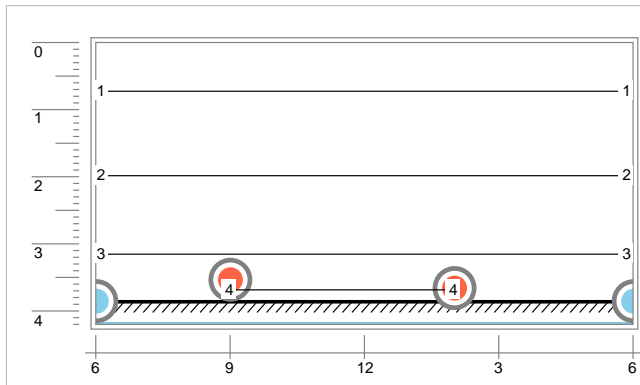

QSR	QMR	QOR	SPR	MPR	OPR	SPRI	MPRI	OPRI
4232	3121	4233	17.0	9.0	26.0	2.4	1.5	2.0



Node 2D Sketch - 8/14/2023 - 2194

Date 8/14/2023	Manhole Number 2194	City Georgetown	Street 1406 Bourne Street	Surveyed By Matthew Headrick
-------------------	------------------------	--------------------	------------------------------	---------------------------------

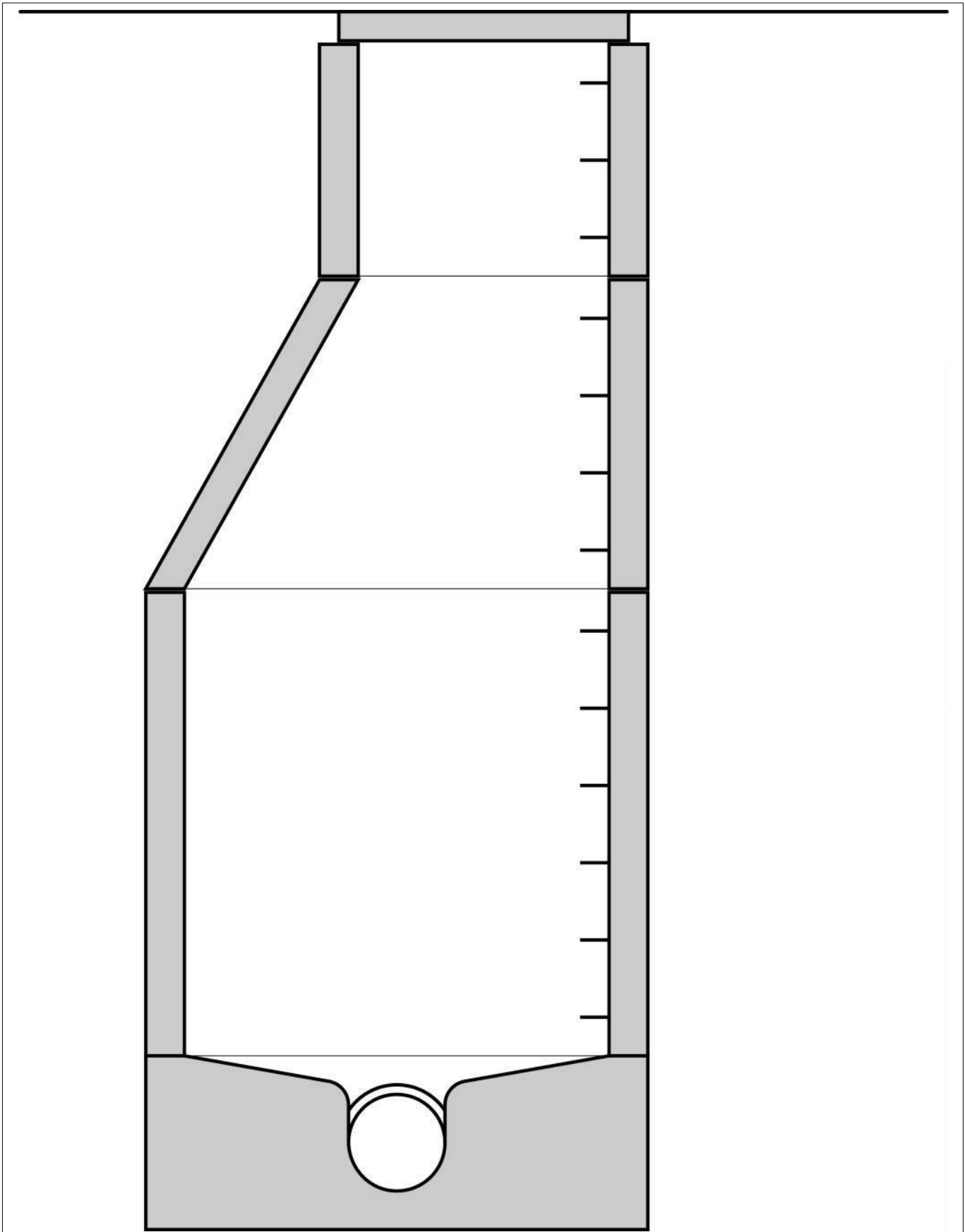



Node Pictures - 8/14/2023 - 2194

Date 8/14/2023	Manhole Number 2194	City Georgetown	Street 1406 Bourne Street	Surveyed By Matthew Headrick
-------------------	------------------------	--------------------	------------------------------	---------------------------------



2194_1962243a-d72d-4c62-9e3a-2c87a26c1c57_aeb8bf8d-f294-49aa-a231-debc66a1da36_P11.jpg,
, 0.73
Missing Mortar Medium from 12 o'clock to 12 o'clock



2194_1962243a-d72d-4c62-9e3a-2c87a26c1c57_f68e1b1f-3d93-4c0c-8e24-01f9fd97e403_P11.jpg,
00:00:15, 1.99
Missing Mortar Large from 12 o'clock to 12 o'clock



Node Pictures - 8/14/2023 - 2194

Date 8/14/2023	Manhole Number 2194	City Georgetown	Street 1406 Bourne Street	Surveyed By Matthew Headrick
-------------------	------------------------	--------------------	------------------------------	---------------------------------



2194_1962243a-d72d-4c62-9e3a-2c87a26c1c57_382482e7-71a6-48b7-908e-3d8be0875e4c_P11.jpg,
00:00:19, 3.16
Missing Mortar Large from 12 o'clock to 12 o'clock



2194_1962243a-d72d-4c62-9e3a-2c87a26c1c57_80c86366-c9e9-43ae-8397-d26630ffeced_P11.jpg,
00:00:20, 3.69
Deposits Settled Gravel, 30% of cross sectional area from 9 o'clock to 2 o'clock, within 8 inch



Node Drawings - 8/14/2023 - 2194

Date 8/14/2023	Manhole Number 2194	City Georgetown	Street 1406 Bourne Street	Surveyed By Matthew Headrick
-------------------	------------------------	--------------------	------------------------------	---------------------------------

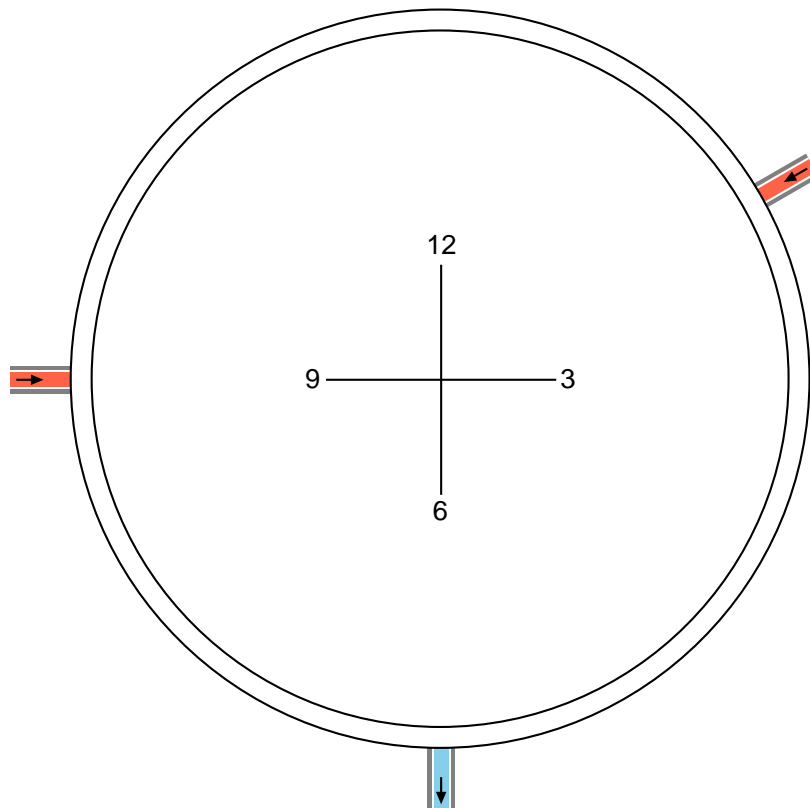
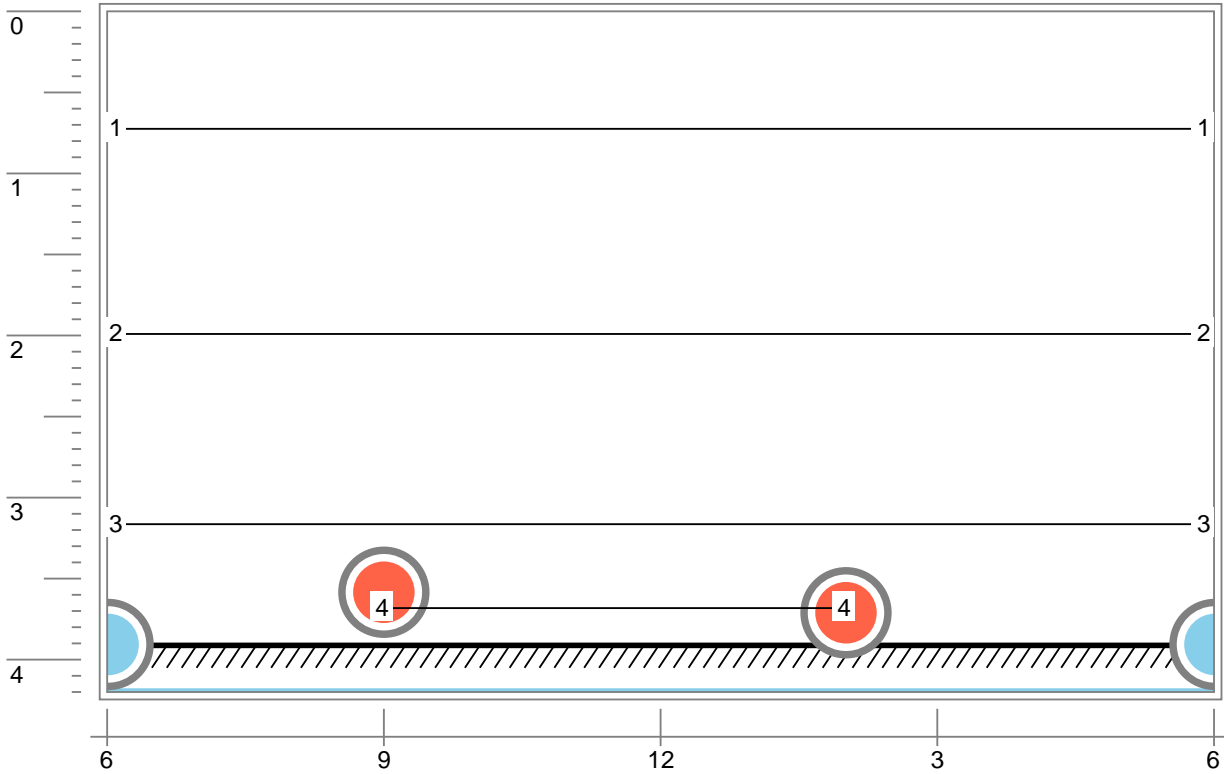



CleverScan - 8/14/2023 - 2194

Date 8/14/2023	Manhole Number 2194	City Georgetown	Street 1406 Bourne Street	Surveyed By Matthew Headrick
-------------------	------------------------	--------------------	------------------------------	---------------------------------

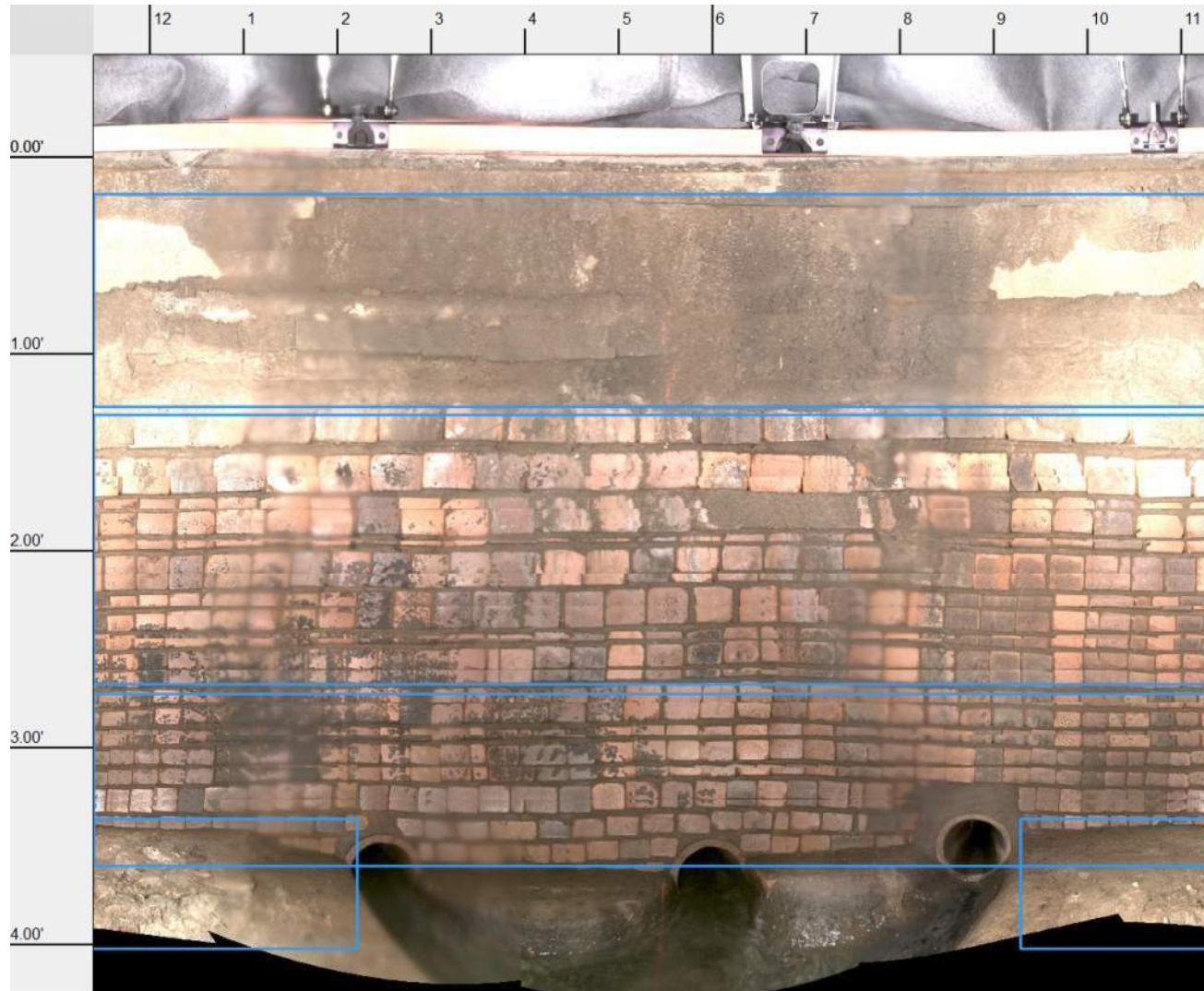



Node Inspection - 8/9/2023 - 2193

Date 8/9/2023	Time 11:53	Manhole Number 2193	Access Type Manhole	City Georgetown	Street 1406 Bourne Street
Surveyed By Matthew Headrick	Certificate Number U-0419-07030528	PO Number	Work Order	Pre-Cleaning No Pre-Cleaning	Sheet Number

General Manhole Information

MH Use Sanitary	Year Constructed	Year Renewed	Owner City of Georgetown
Rim to Invert 4.53 m	Grade to Invert 4.53 m	Rim to Grade 0.00 m	Rim to Grade Exposed 0.50 m
Surface Type Asphalt			
Location Code Light Highway	Location Details 24' East of MH 2194		
Additional component information	Frame is defective		

General Manhole Inspection Information

Date Cleaned	Inspection Level Level 2	Consequence of Failure
Customer	Evidence Surcharge No	Purpose Routine assessment
Reviewed By Juan Bedoya	Reviewer Certificate U-1020-70400280	Weather Dry
Is Imperial No	Inspection Status Remote Inspection	Media Label WinCan 14.0
Potential for RunOff	None	

Cover

Cover Type Solid					
Cover Shape Circular	Cover Size 24 mm	Center Cover Size	Cover Width		
Cover Material Cast Iron	Hole Diameter	Hole Number 0			
Cover Frame fit Good	Cover Bearing Surface Diameter 34 mm	Cover Bearing Surface Width			
Cover Condition Sound					

Cover Insert

Cover Insert Type None	Insert Condition
----------------------------------	------------------

Frame

Frame Material Cast Iron	Frame Bearing Surface Width 1 mm	Frame Bearing Surface Depth 1 mm
Frame Seal Inflow None	Frame Clear Open Diameter 22 mm	Frame Clear Open Width
Frame Depth 8 mm	Frame Offset Distance 2 mm	
Frame Condition Corroded, Broken		
Seal Condition Missing		

Chimney

Chimney Present Yes	Chimney Material 1 Brick	Chimney Material 2
Chimney Clear Opening 22 mm	Chimney Depth 1.52 m	Chimney Infiltration None
Chimney Condition Sound	Chimney Lining Interior None	Chimney Lining Exterior Not Known

Cone

Cone Type Conical centered	Cone Material Brick	Cone Depth 2.70 m
Cone Condition Sound	Cone Lining Interior None	Cone Lining Exterior Not Known

Wall

Wall Material Brick	Wall Diameter 44 mm	Wall By Size 44 mm	Wall Depth 3.37 m
Wall Condition Sound	Wall Lining Exterior Not Known	Wall Lining Interior None	

Bench

Bench Condition Sound	Bench Present Yes	Bench Material Brick	Bench Lining None
---------------------------------	-----------------------------	--------------------------------	-----------------------------

QSR	QMR	QOR	SPR	MPR	OPR	SPRI	MPRI	OPRI
5143	3122	5143	27.0	13.0	40.0	3.4	1.4	2.4



Node Inspection - 8/9/2023 - 2193

Date 8/9/2023	Time 11:53	Manhole Number 2193	Access Type Manhole	City Georgetown	Street 1406 Bourne Street
Surveyed By Matthew Headrick	Certificate Number U-0419-07030528	PO Number	Work Order	Pre-Cleaning No Pre-Cleaning	Sheet Number

Channel

Channel Installed	Yes	Channel Material	Brick	Channel Type	Formed
Channel Condition	Sound	Channel Exposure	Fully Opened		

Observations

Nr.	Distance	MACP Code	Observation	Remark
1	1.12 m	MML	Missing Mortar Large from 12 o'clock to 12 o'clock	Fully exposed bricks with gaps
2	2.15 m	MML	Missing Mortar Large from 12 o'clock to 12 o'clock	Fully exposed bricks with gaps
3	3.06 m	IW	Infiltration Weeper from 11 o'clock to 3 o'clock, within 8 inch	infiltration from brick joints
4	3.25 m	MML	Missing Mortar Large from 12 o'clock to 12 o'clock	Fully exposed bricks with gaps
5	3.42 m	IW	Infiltration Weeper from 4 o'clock to 11 o'clock, within 8 inch	infiltration from brick joints
6	3.75 m	DSF	Deposits Settled Fine, 5% of cross sectional area from 12 o'clock to 12 o'clock, within 8 inch	on bench
7	3.80 m	DAGS	Deposits Attached Grease, 5% of cross sectional area from 5 o'clock to 7 o'clock, within 8 inch	on pipe and bench
8	3.83 m	MMM	Missing Mortar Medium from 12 o'clock to 12 o'clock	exosed bricks on bench

Connections

Pipe Number	Rim To Invert	Direction	Clock Position	Shape	Material	Height	Width	Pipe Condition	Seal Condition	Pipe Type	Structure ID	Comments
1	4.53 m	Out	6	Circular	Vitrified Clay Pipe	8 mm	-	Sound	Sound	Gravity Connection		
2	3.13 m	In	7	Circular	Polyvinyl Chloride	4 mm	-	Sound	Sound	Lateral to Building		
3	4.06 m	In	10	Circular	Vitrified Clay Pipe	8 mm	-	Sound	Sound	Gravity Connection		
4	3.54 m	In	2	Circular	Vitrified Clay Pipe	4 mm	-	Sound	Sound	Lateral to Building		
5	3.69 m	In	4	Circular	Vitrified Clay Pipe	4 mm	-	Sound	Sound	Lateral to Building		
6	2.19 m	In	5	Circular	Polyvinyl Chloride	6 mm	-	Sound	Sound	Lateral to Building		

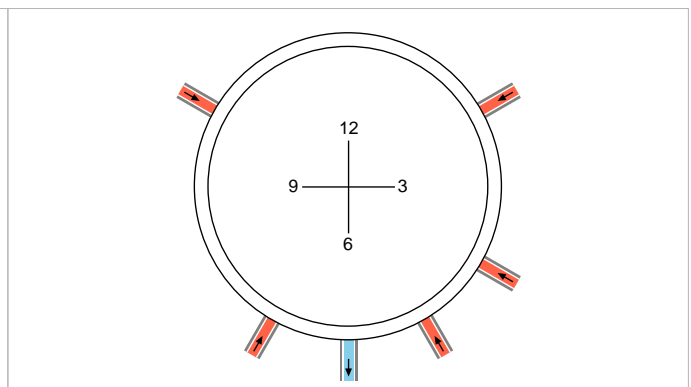
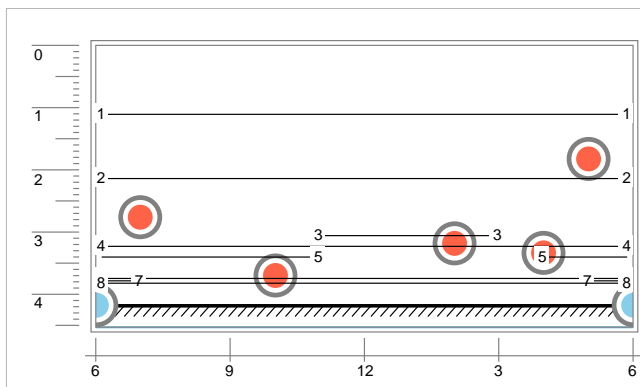

QSR	QMR	QOR	SPR	MPR	OPR	SPRI	MPRI	OPRI
5143	3122	5143	27.0	13.0	40.0	3.4	1.4	2.4



Node 2D Sketch - 8/9/2023 - 2193

Date 8/9/2023	Manhole Number 2193	City Georgetown	Street 1406 Bourne Street	Surveyed By Matthew Headrick
------------------	------------------------	--------------------	------------------------------	---------------------------------

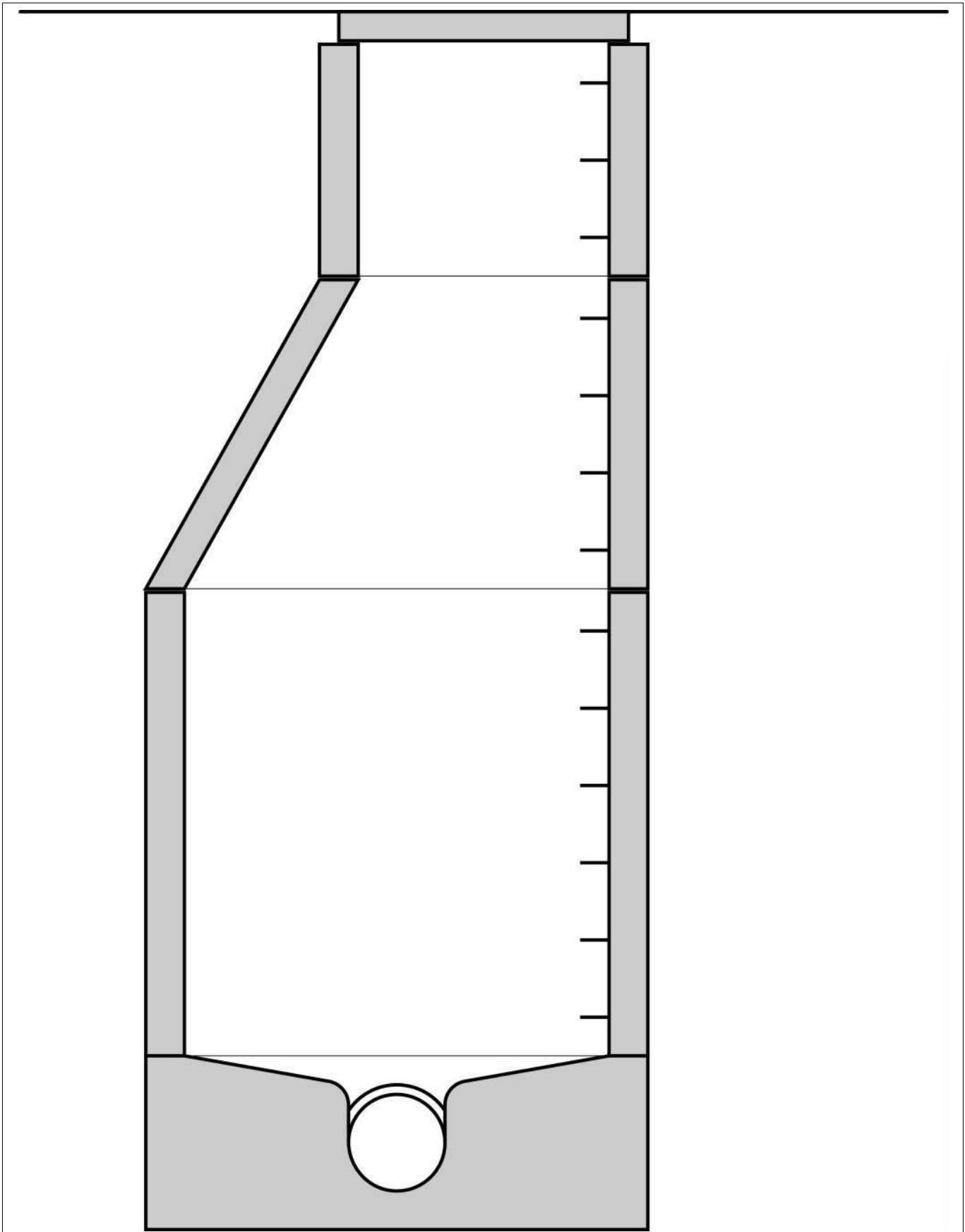



Node Pictures - 8/9/2023 - 2193

Date 8/9/2023	Manhole Number 2193	City Georgetown	Street 1406 Bourne Street	Surveyed By Matthew Headrick
------------------	------------------------	--------------------	------------------------------	---------------------------------



2193c_2b27c63e-1844-43c6-8c49-44849fa40c9a_27231513-463e-40f2-a886-37276c3d5b57_P11.jpg,
1.12
Missing Mortar Large from 12 o'clock to 12 o'clock



2193c_2b27c63e-1844-43c6-8c49-44849fa40c9a_7338876b-4b2d-4dae-8d83-3970418e4892_P11.jpg,
00:00:14, 2.15
Missing Mortar Large from 12 o'clock to 12 o'clock



Node Pictures - 8/9/2023 - 2193

Date 8/9/2023	Manhole Number 2193	City Georgetown	Street 1406 Bourne Street	Surveyed By Matthew Headrick
------------------	------------------------	--------------------	------------------------------	---------------------------------



2193c_2b27c63e-1844-43c6-8c49-44849fa40c9a_f01e8115-6d9e-48aa-8948-beff3c204241_P11.jpg,
00:00:17, 3.06
Infiltration Weeper from 11 o'clock to 3 o'clock, within 8 inch



2193c_2b27c63e-1844-43c6-8c49-44849fa40c9a_40c119e6-e6b7-45ce-9ad4-8e93fa226faa_P11.jpg,
00:00:17, 3.25
Missing Mortar Large from 12 o'clock to 12 o'clock



Node Pictures - 8/9/2023 - 2193

Date 8/9/2023	Manhole Number 2193	City Georgetown	Street 1406 Bourne Street	Surveyed By Matthew Headrick
------------------	------------------------	--------------------	------------------------------	---------------------------------



2193c_2b27c63e-1844-43c6-8c49-44849fa40c9a_db133c1a-727c-427a-9ae2-24e83ae66ad0_P11.jpg,
00:00:17, 3.42
Infiltration Weeper from 4 o'clock to 11 o'clock, within 8 inch



2193c_2b27c63e-1844-43c6-8c49-44849fa40c9a_ca3636fc-c371-4c76-a7b1-b6d39cd72e45_P11.jpg,
00:00:17, 3.75
Deposits Settled Fine, 5% of cross sectional area from 12 o'clock to 12 o'clock, within 8 inch



Node Pictures - 8/9/2023 - 2193

Date 8/9/2023	Manhole Number 2193	City Georgetown	Street 1406 Bourne Street	Surveyed By Matthew Headrick
------------------	------------------------	--------------------	------------------------------	---------------------------------



2193c_2b27c63e-1844-43c6-8c49-44849fa40c9a_6167233f-25d9-4a6c-8135-a91386f86965_P11.jpg,
00:00:17, 3.80
Deposits Attached Grease, 5% of cross sectional area from 5 o'clock to 7 o'clock, within 8 inch



2193c_2b27c63e-1844-43c6-8c49-44849fa40c9a_64fc95ca-fdb3-46c0-8178-6593d18247cb_P11.jpg,
00:00:17, 3.83
Missing Mortar Medium from 12 o'clock to 12 o'clock



Node Drawings - 8/9/2023 - 2193

Date 8/9/2023	Manhole Number 2193	City Georgetown	Street 1406 Bourne Street	Surveyed By Matthew Headrick
------------------	------------------------	--------------------	------------------------------	---------------------------------

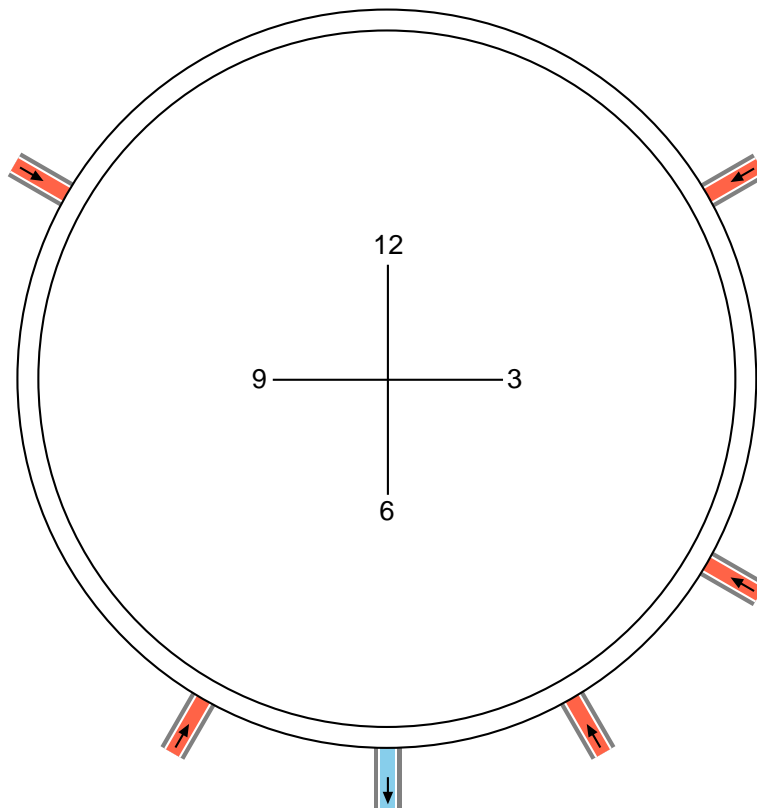
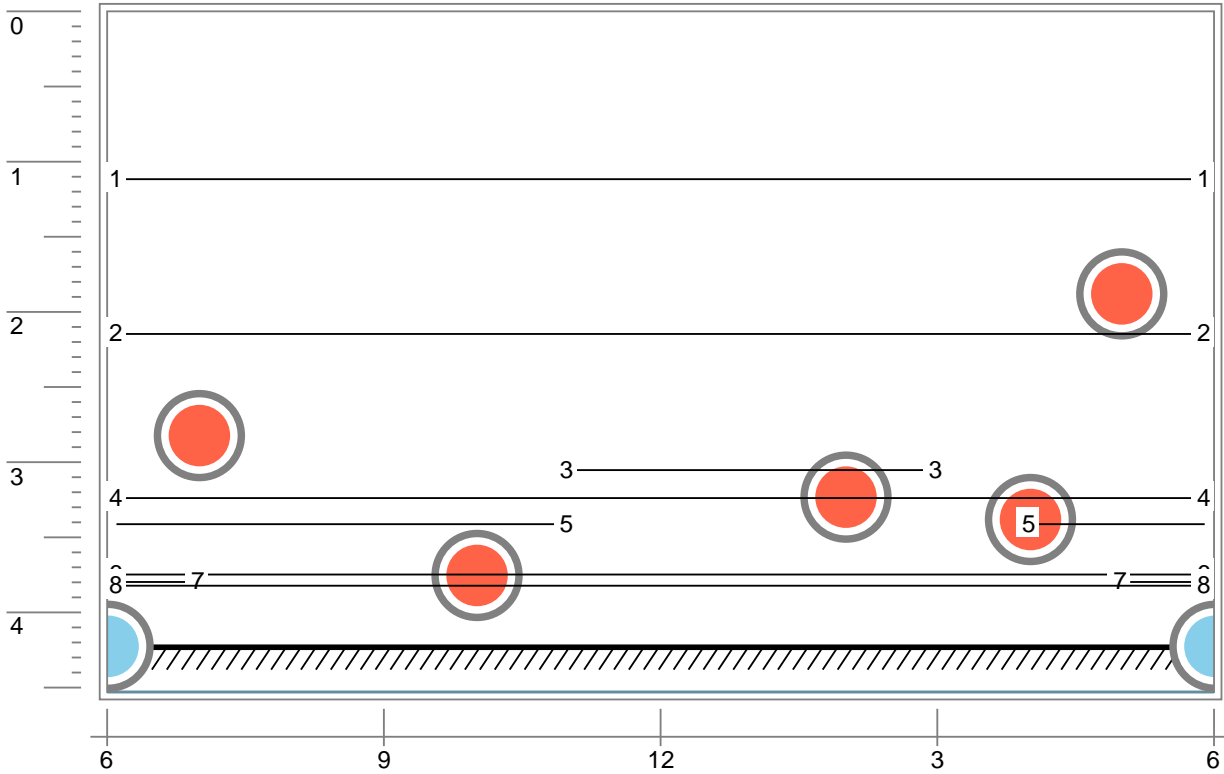



CleverScan - 8/9/2023 - 2193

Date 8/9/2023	Manhole Number 2193	City Georgetown	Street 1406 Bourne Street	Surveyed By Matthew Headrick
------------------	------------------------	--------------------	------------------------------	---------------------------------

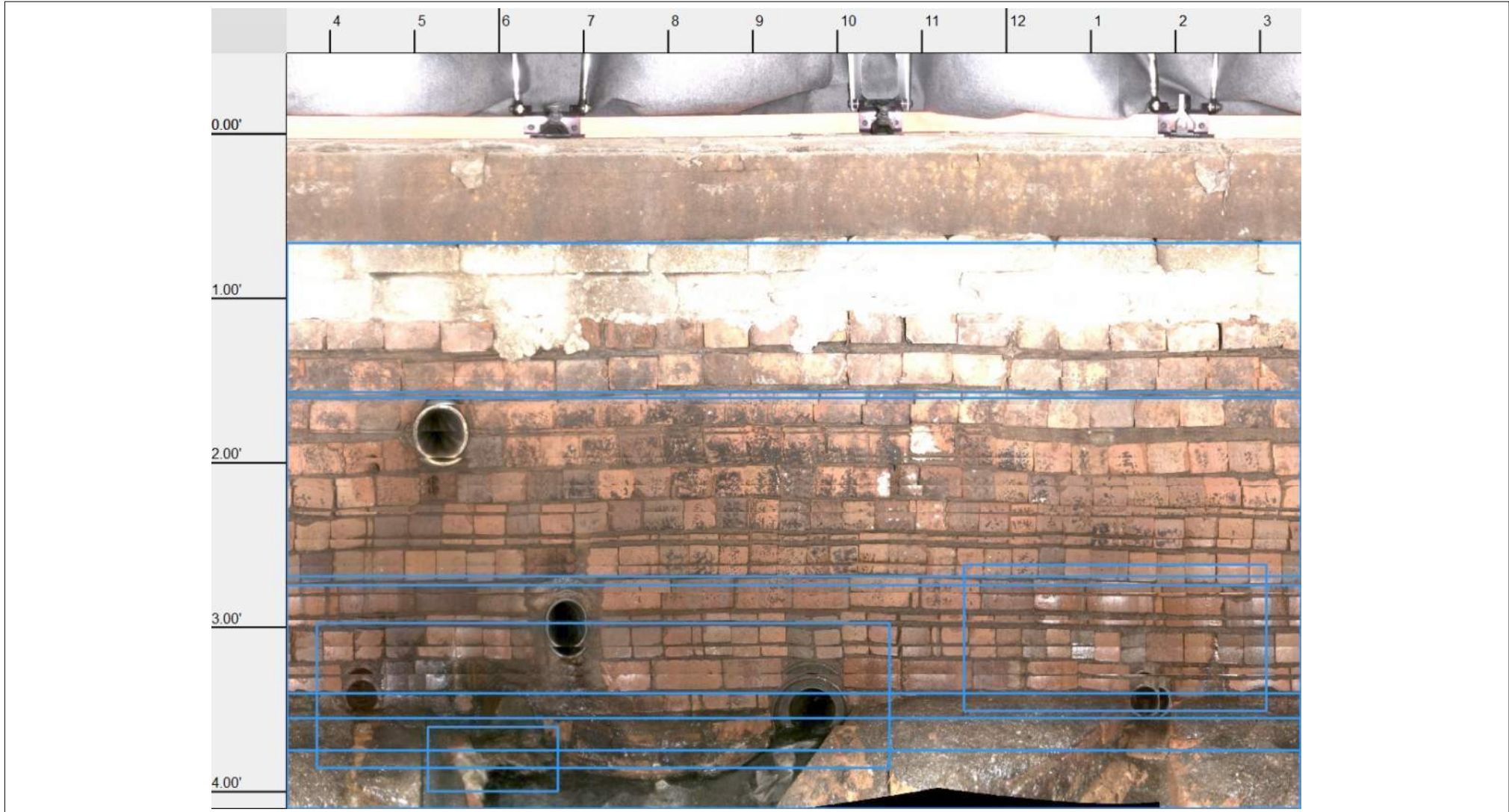



Node Inspection - 8/9/2023 - 1840

Date 8/9/2023	Time 12:01	Manhole Number 1840	Access Type Manhole	City Georgetown	Street 217 South Fraser
Surveyed By Matthew Headrick	Certificate Number U-0419-07030528	PO Number	Work Order	Pre-Cleaning No Pre-Cleaning	Sheet Number

General Manhole Information

MH Use Sanitary	Year Constructed	Year Renewed	Owner City of Georgetown
Rim to Invert 12.0'	Grade to Invert 11.9'	Rim to Grade 1.0'	Rim to Grade Exposed 1.0'
Surface Type Asphalt			
Location Code Light Highway	Location Details		
Additional component information	Ponding 1"		

General Manhole Inspection Information

Date Cleaned	Inspection Level Level 2	Consequence of Failure
Customer	Evidence Surcharge No	Purpose Routine assessment
Reviewed By Juan Bedoya	Reviewer Certificate U-1020-70400280	Weather Dry
Is Imperial No	Inspection Status Remote Inspection	Media Label WinCan 14.0
Potential for RunOff	Ponding	

Cover

Cover Type Solid					
Cover Shape Circular	Cover Size 23.5"	Center Cover Size	Cover Width		
Cover Material Cast Iron	Hole Diameter	Hole Number 0			
Cover Frame fit Good	Cover Bearing Surface Diameter 23.0"	Cover Bearing Surface Width			
Cover Condition Sound					

Cover Insert

Cover Insert Type None	Insert Condition
----------------------------------	------------------

Frame

Frame Material Cast Iron	Frame Bearing Surface Width 0.8"	Frame Bearing Surface Depth 1.0"
Frame Seal Inflow None	Frame Clear Open Diameter 22.0"	Frame Clear Open Width
Frame Depth 3.0"	Frame Offset Distance 0.0"	
Frame Condition Sound		
Seal Condition Sound		

Chimney

Chimney Present Yes	Chimney Material 1 Brick	Chimney Material 2
Chimney Clear Opening 19.7"	Chimney Depth 1.8'	Chimney Infiltration Infil Stained
Chimney Condition Sound	Chimney Lining Interior None	Chimney Lining Exterior Not Known

Cone

Cone Type Conical centered	Cone Material Brick	Cone Depth 3.8'
Cone Condition Sound	Cone Lining Interior None	Cone Lining Exterior Not Known

Wall

Wall Material Brick	Wall Diameter 48.0"	Wall By Size 48.0"	Wall Depth 10.6'
Wall Condition Sound	Wall Lining Exterior Not Known	Wall Lining Interior None	

Bench

Bench Condition Sound	Bench Present Yes	Bench Material Concrete (cast in place)	Bench Lining None
---------------------------------	-----------------------------	---	-----------------------------

QSR	QMR	QOR	SPR	MPR	OPR	SPRI	MPRI	OPRI
4231	2317	4231	17.0	13.0	30.0	2.1	1.3	1.7



Node Inspection - 8/9/2023 - 1840

Date 8/9/2023	Time 12:01	Manhole Number 1840	Access Type Manhole	City Georgetown	Street 217 South Fraser
Surveyed By Matthew Headrick	Certificate Number U-0419-07030528	PO Number	Work Order	Pre-Cleaning No Pre-Cleaning	Sheet Number

Channel

Channel Installed	Yes	Channel Material	Vitrified Clay	Channel Type	Formed
Channel Condition	Sound	Channel Exposure	Fully Opened		

Observations

Nr.	Distance	MACP Code	Observation	Remark
1	1.1'	MMM	Missing Mortar Medium from 12 o'clock to 12 o'clock	exposed bricks
2	3.0'	IS	Infiltration Stain from 9 o'clock to 2 o'clock, within 8 inch	stains from chimney cone join
3	3.2'	MML	Missing Mortar Large from 12 o'clock to 12 o'clock	exposed blocks
4	7.1'	IS	Infiltration Stain from 10 o'clock to 8 o'clock, within 8 inch	minor infiltration stains
5	7.3'	DAR	Deposits Attached Ragging, 5% of cross sectional area from 9 o'clock to 12 o'clock, within 8 inch	rag deposits indicative of surcharged conditions
6	7.3'	SAV	Surface Damage Aggregate Visible from 12 o'clock to 12 o'clock, within 8 inch	aggregate visible on concrete bricks/blocks
7	7.8'	MML	Missing Mortar Large from 12 o'clock to 12 o'clock	exposed blocks
8	8.6'	IW	Infiltration Weeper from 11 o'clock to 12 o'clock, within 8 inch	minor infiltration wall
9	8.7'	IW	Infiltration Weeper from 1 o'clock to 4 o'clock, within 8 inch	minor infiltration wall
10	10.9'	MGO	Miscellaneous General Observation	hole in bench from upper inlet flow

Connections

Pipe Number	Rim To Invert	Directio	Clock Position	Shape	Material	Height	Width	Pipe Condition	Seal Condition	Pipe Type	Structure ID	Comments
1	12.0'	Out	6	Circular	Vitrified Clay Pipe	12"	-	Sound	Sound	Gravity Connection		
2	7.5'	In	9	Circular	Vitrified Clay Pipe	8"	-	Sound	Sound	Gravity Connection		
3	12.0'	In	12	Circular	Vitrified Clay Pipe	12"	-	Sound	Sound	Gravity Connection		

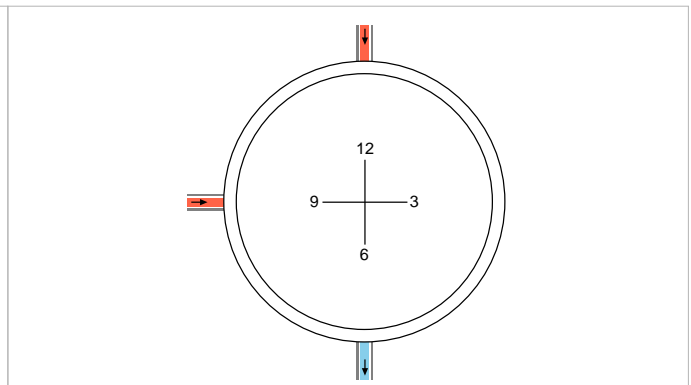
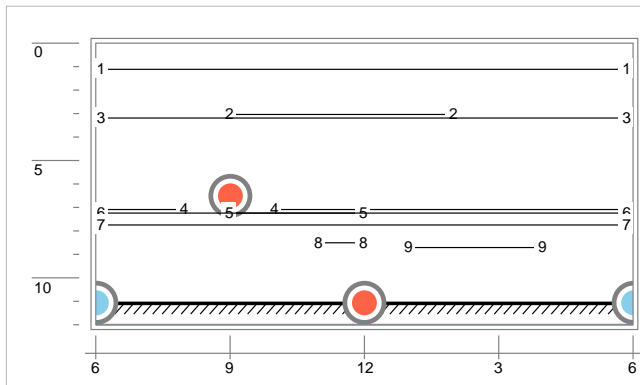

QSR	QMR	QOR	SPR	MPR	OPR	SPRI	MPRI	OPRI
4231	2317	4231	17.0	13.0	30.0	2.1	1.3	1.7



Node 2D Sketch - 8/9/2023 - 1840

Date 8/9/2023	Manhole Number 1840	City Georgetown	Street 217 South Fraser Street	Surveyed By Matthew Headrick
------------------	------------------------	--------------------	-----------------------------------	---------------------------------

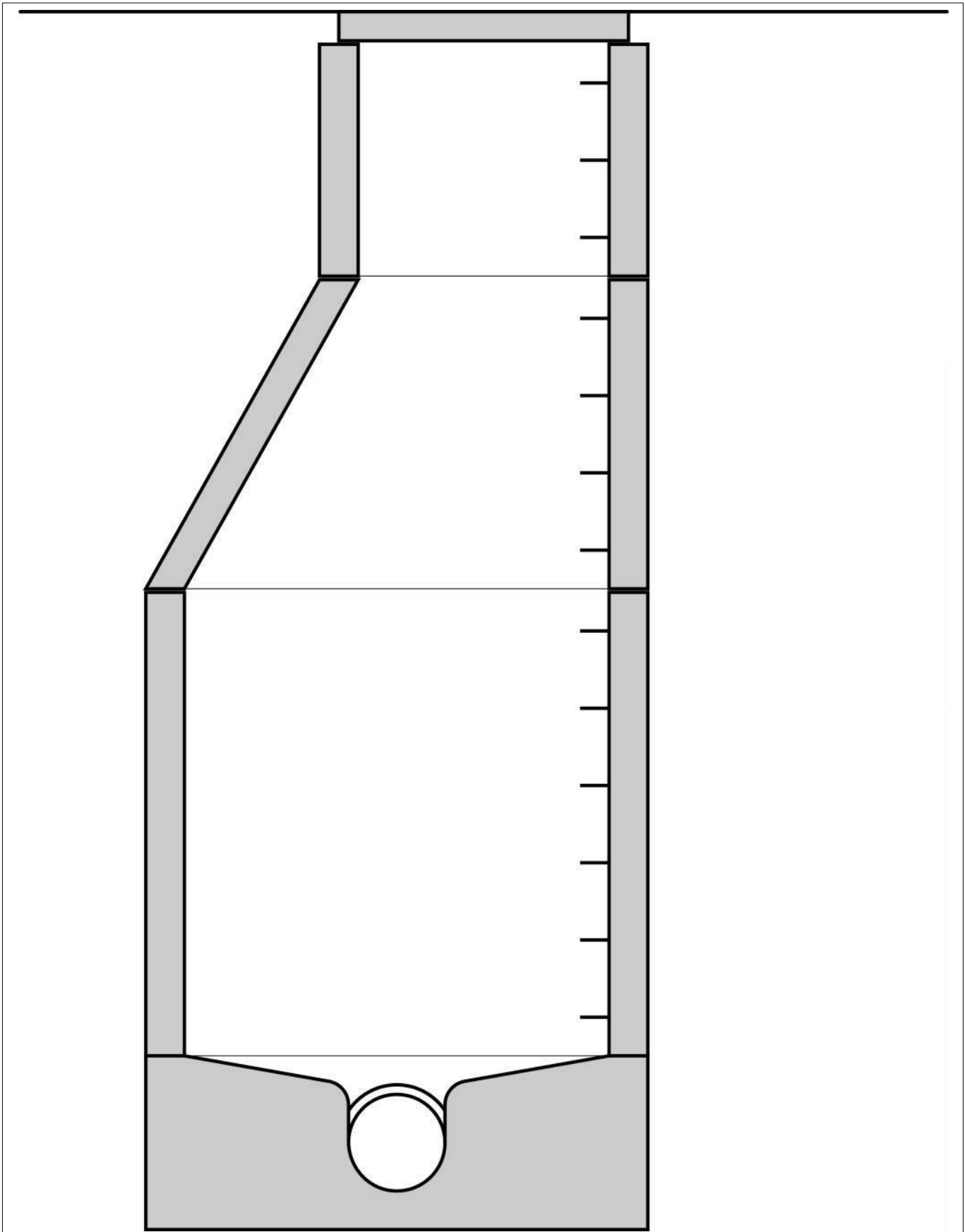



Node Pictures - 8/9/2023 - 1840

Date 8/9/2023	Manhole Number 1840	City Georgetown	Street 217 South Fraser Street	Surveyed By Matthew Headrick
------------------	------------------------	--------------------	-----------------------------------	---------------------------------



1840b_b7eec4bd-8b4a-4779-9657-5106bc04b13d_7555dfaa-36ec-44d8-94fd-88d879b45a7c_P11.jpg,
00:00:08, 1.15
Missing Mortar Medium from 12 o'clock to 12 o'clock



1840b_b7eec4bd-8b4a-4779-9657-5106bc04b13d_ebc59ab5-135d-41b7-a25a-f94a7cc157d3_P11.jpg,
, 3.05
Infiltration Stain from 9 o'clock to 2 o'clock, within 8 inch



Node Pictures - 8/9/2023 - 1840

Date 8/9/2023	Manhole Number 1840	City Georgetown	Street 217 South Fraser Street	Surveyed By Matthew Headrick
------------------	------------------------	--------------------	-----------------------------------	---------------------------------



1840b_b7eec4bd-8b4a-4779-9657-5106bc04b13d_b3bd481c-4d93-4b3a-82bb-d7009eb967ba_P11.jpg,
00:00:15, 3.19
Missing Mortar Large from 12 o'clock to 12 o'clock



1840b_b7eec4bd-8b4a-4779-9657-5106bc04b13d_0bacfebb-7abc-441d-9d7c-0f90eb9de052_P11.jpg,
00:00:30, 7.10
Infiltration Stain from 10 o'clock to 8 o'clock, within 8 inch



Node Pictures - 8/9/2023 - 1840

Date 8/9/2023	Manhole Number 1840	City Georgetown	Street 217 South Fraser Street	Surveyed By Matthew Headrick
------------------	------------------------	--------------------	-----------------------------------	---------------------------------



1840b_b7eec4bd-8b4a-4779-9657-5106bc04b13d_35529e95-0a62-48f8-98e8-335a84118c73_P11.jpg,
00:00:31, 7.26
Deposits Attached Ragging, 5% of cross sectional area from 9 o'clock to 12 o'clock, within 8 inch



1840b_b7eec4bd-8b4a-4779-9657-5106bc04b13d_66d9a5cb-d985-4416-addd-6f90bc001a71_P11.jpg,
00:00:33, 7.78
Missing Mortar Large from 12 o'clock to 12 o'clock



Node Pictures - 8/9/2023 - 1840

Date 8/9/2023	Manhole Number 1840	City Georgetown	Street 217 South Fraser Street	Surveyed By Matthew Headrick
------------------	------------------------	--------------------	-----------------------------------	---------------------------------



1840b_b7eec4bd-8b4a-4779-9657-5106bc04b13d_7d43213e-f383-41b4-bd9d-7330807a6025_P11.jpg,
00:00:36, 8.56
Infiltration Weeper from 11 o'clock to 12 o'clock, within 8 inch



1840b_b7eec4bd-8b4a-4779-9657-5106bc04b13d_f2959d06-e2b7-4c56-8149-9d52cb0888f3_P11.jpg,
00:00:37, 8.74
Infiltration Weeper from 1 o'clock to 4 o'clock, within 8 inch



Node Pictures - 8/9/2023 - 1840

Date 8/9/2023	Manhole Number 1840	City Georgetown	Street 217 South Fraser Street	Surveyed By Matthew Headrick
------------------	------------------------	--------------------	-----------------------------------	---------------------------------



1840b_b7eec4bd-8b4a-4779-9657-5106bc04b13d_5eb2e798-3750-4a48-b41c-f86bfa1e25bc_P11.jpg,
00:00:46, 10.92

Miscellaneous General Observation



Node Drawings - 8/9/2023 - 1840

Date 8/9/2023	Manhole Number 1840	City Georgetown	Street 217 South Fraser Street	Surveyed By Matthew Headrick
------------------	------------------------	--------------------	-----------------------------------	---------------------------------

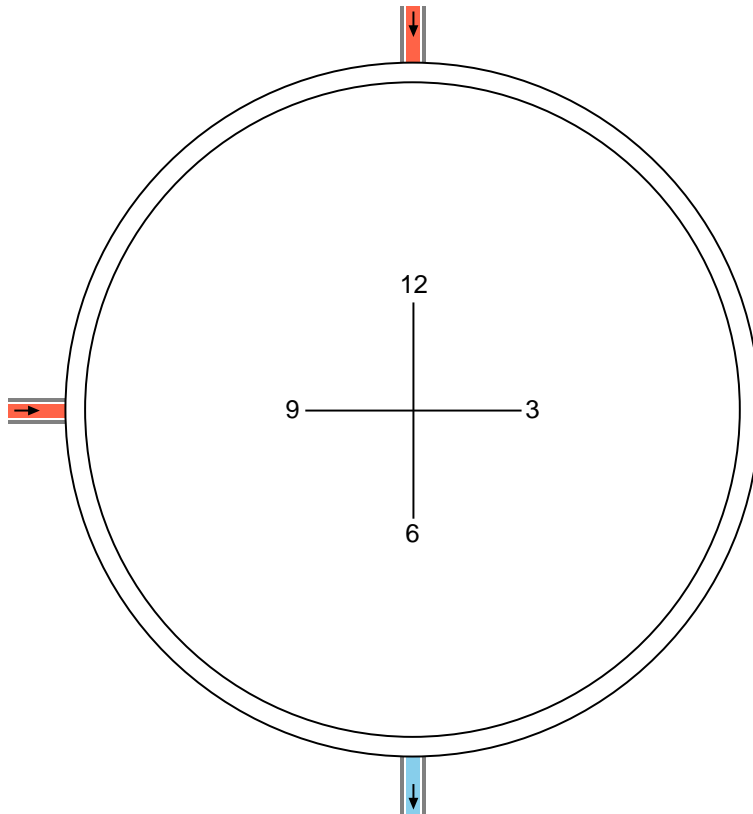
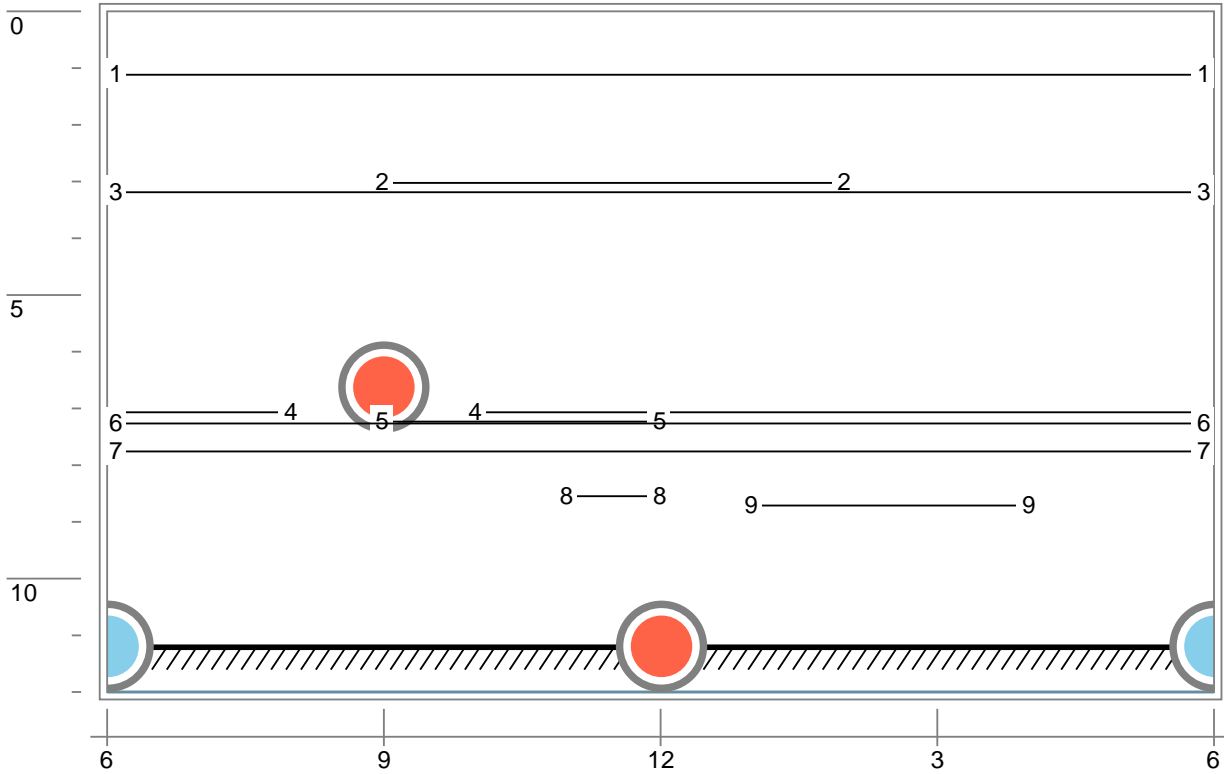



CleverScan - 8/9/2023 - 1840

Date 8/9/2023	Manhole Number 1840	City Georgetown	Street 217 South Fraser Street	Surveyed By Matthew Headrick
-------------------------	-------------------------------	---------------------------	--	--

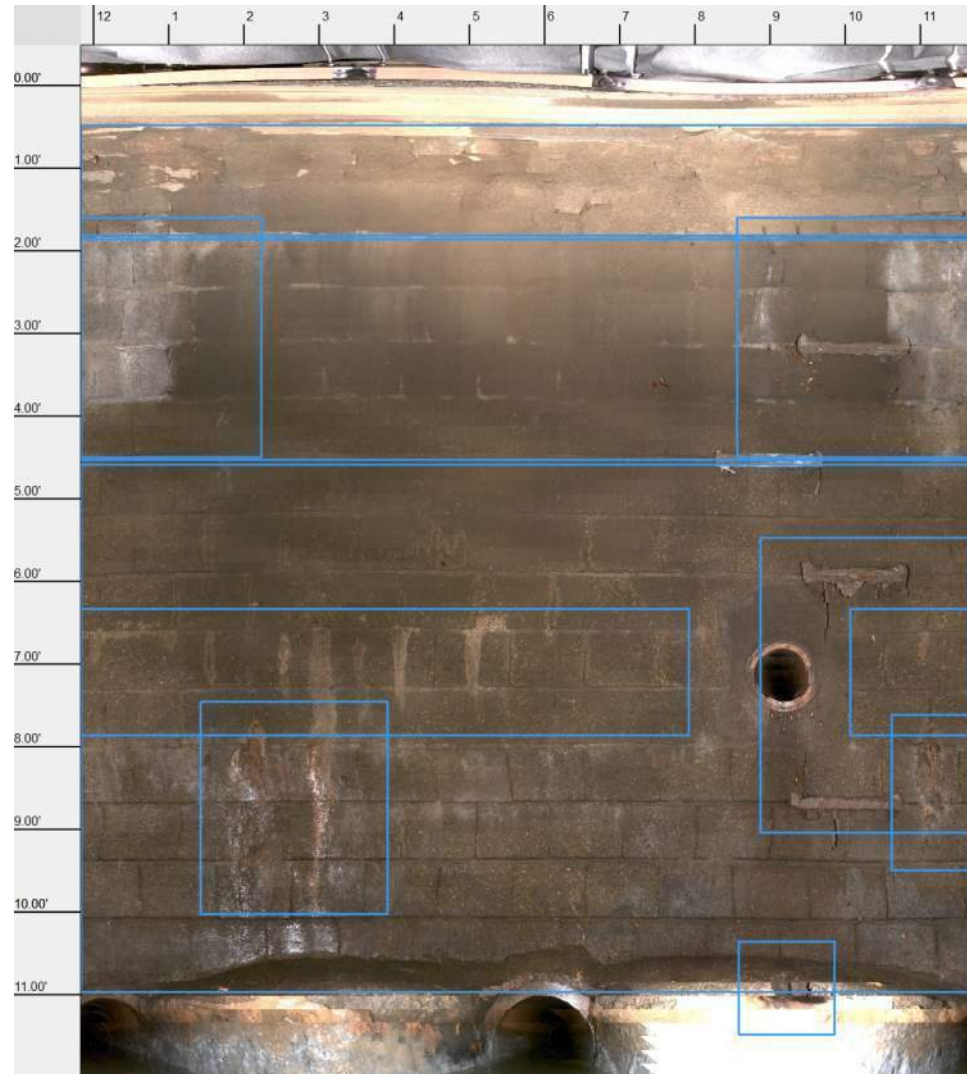



Node Inspection - 8/9/2023 - 1841

Date 8/9/2023	Time 12:01	Manhole Number 1841	Access Type Manhole	City Georgetown	Street 133 South Fraser
Surveyed By Matthew Headrick	Certificate Number U-0419-07030528	PO Number	Work Order	Pre-Cleaning No Pre-Cleaning	Sheet Number

General Manhole Information

MH Use	Sanitary	Year Constructed		Year Renewed		Owner	City of Georgetown
Rim to Invert	13.3 ' 	Grade to Invert	12.8 ' 	Rim to Grade	-0.5 ' 	Rim to Grade Exposed	0.0 '
Surface Type	Asphalt						
Location Code	Light Highway	Location Details					
Additional component information							

General Manhole Inspection Information

Date Cleaned		Inspection Level	Level 2	Consequence of Failure	
Customer		Evidence Surcharge	No	Purpose	Routine assessment
Reviewed By	Juan Bedoya	Reviewer Certificate	U-1020-70400280	Weather	Dry
Is Imperial	No	Inspection Status	Remote Inspection	Media Label	WinCan 14.0
Potential for RunOff	None				

Cover

Cover Type	Solid						
Cover Shape	Circular	Cover Size	23.5 " 	Center Cover Size		Cover Width	
Cover Material	Cast Iron	Hole Diameter				Hole Number	0
Cover Frame fit	Oversized	Cover Bearing Surface Diameter	34.0 " 	Cover Bearing Surface Width			
Cover Condition	Sound						

Cover Insert

Cover Insert Type	None	Insert Condition	
-------------------	-------------	------------------	--

Frame

Frame Material	Cast Iron	Frame Bearing Surface Width	0.5 " 	Frame Bearing Surface Depth	0.0 "
Frame Seal Inflow	None	Frame Clear Open Diameter	22.0 " 	Frame Clear Open Width	
Frame Depth	3.5 " 	Frame Offset Distance	0.0 " 		
Frame Condition	Sound				
Seal Condition	Sound				

Chimney

Chimney Present	Yes	Chimney Material 1	Brick	Chimney Material 2	
Chimney Clear Opening	24.0 " 	Chimney Depth	1.7 ' 	Chimney Infiltration	None
Chimney Condition	Sound	Chimney Lining Interior	None	Chimney Lining Exterior	Not Known

Cone

Cone Type	Conical centered	Cone Material	Brick	Cone Depth	3.6 '
Cone Condition	Sound	Cone Lining Interior	None	Cone Lining Exterior	Not Known

Wall

Wall Material	Brick	Wall Diameter	48.0 " 	Wall By Size	48.0 " 	Wall Depth	11.7 '
Wall Condition	Sound	Wall Lining Exterior	Not Known	Wall Lining Interior	None		

Bench

Bench Condition	Sound	Bench Present	Yes	Bench Material	Concrete (cast in place)	Bench Lining	None
-----------------	--------------	---------------	------------	----------------	---------------------------------	--------------	-------------

QSR	QMR	QOR	SPR	MPR	OPR	SPRI	MPRI	OPRI
5141	5116	5241	19.0	11.0	30.0	2.1	1.6	1.9



Node Inspection - 8/9/2023 - 1841

Date 8/9/2023	Time 12:01	Manhole Number 1841	Access Type Manhole	City Georgetown	Street 133 South Fraser
Surveyed By Matthew Headrick	Certificate Number U-0419-07030528	PO Number	Work Order	Pre-Cleaning No Pre-Cleaning	Sheet Number

Channel

Channel Installed	Yes	Channel Material	Vitrified Clay	Channel Type	Pipe
Channel Condition	Sound	Channel Exposure	Fully Opened		

Steps

Step Number	7	Step Material	Metal
-------------	----------	---------------	--------------

Observations

Nr.	Distance	MACP Code	Observation	Remark
1	1.0'	MMS	Missing Mortar Small from 1 o'clock to 6 o'clock	minor brick exposure
2	2.4'	MML	Missing Mortar Large from 12 o'clock to 11 o'clock, Start	exposed blocks
3	2.4'	IS	Infiltration Stain from 12 o'clock to 10 o'clock, within 8 inch	inf stains from chimney cone join
4	7.1'	DAR	Deposits Attached Ragging, 5% of cross sectional area from 8 o'clock to 12 o'clock, within 8 inch	rags indicative of surcharged conditions
5	7.6'	MML	Missing Mortar Large from 12 o'clock to 12 o'clock	exposed blocks
6	9.7'	SAV	Surface Damage Aggregate Visible from 12 o'clock to 12 o'clock, within 8 inch	aggregate visible on concrete bricks/blocks
7	9.8'	SAV	Surface Damage Aggregate Visible from 12 o'clock to 12 o'clock, within 8 inch	visible aggregate in concrete blocks

Connections

Pipe Number	Rim To Invert	Direction	Clock Position	Shape	Material	Height	Width	Pipe Condition	Seal Condition	Pipe Type	Structure ID	Comments
1	13.3'	Out	6	Circular	Vitrified Clay Pipe	12"	-	Sound	Sound	Gravity Connection		
2	13.2'	In	12	Circular	Vitrified Clay Pipe	12"	-	Sound	Sound	Gravity Connection		

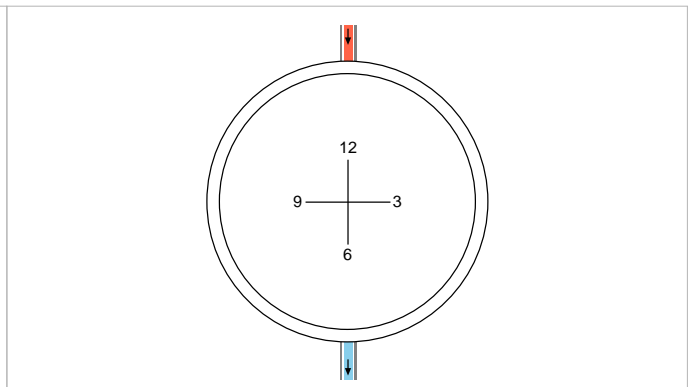
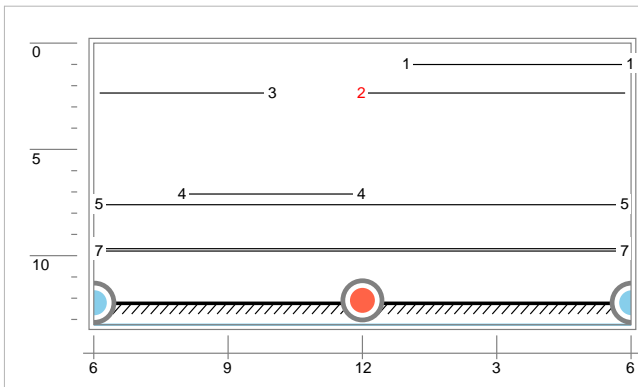

QSR	QMR	QOR	SPR	MPR	OPR	SPRI	MPRI	OPRI
5141	5116	5241	19.0	11.0	30.0	2.1	1.6	1.9



Node 2D Sketch - 8/9/2023 - 1841

Date 8/9/2023	Manhole Number 1841	City Georgetown	Street 133 South Fraser Street	Surveyed By Matthew Headrick
------------------	------------------------	--------------------	-----------------------------------	---------------------------------

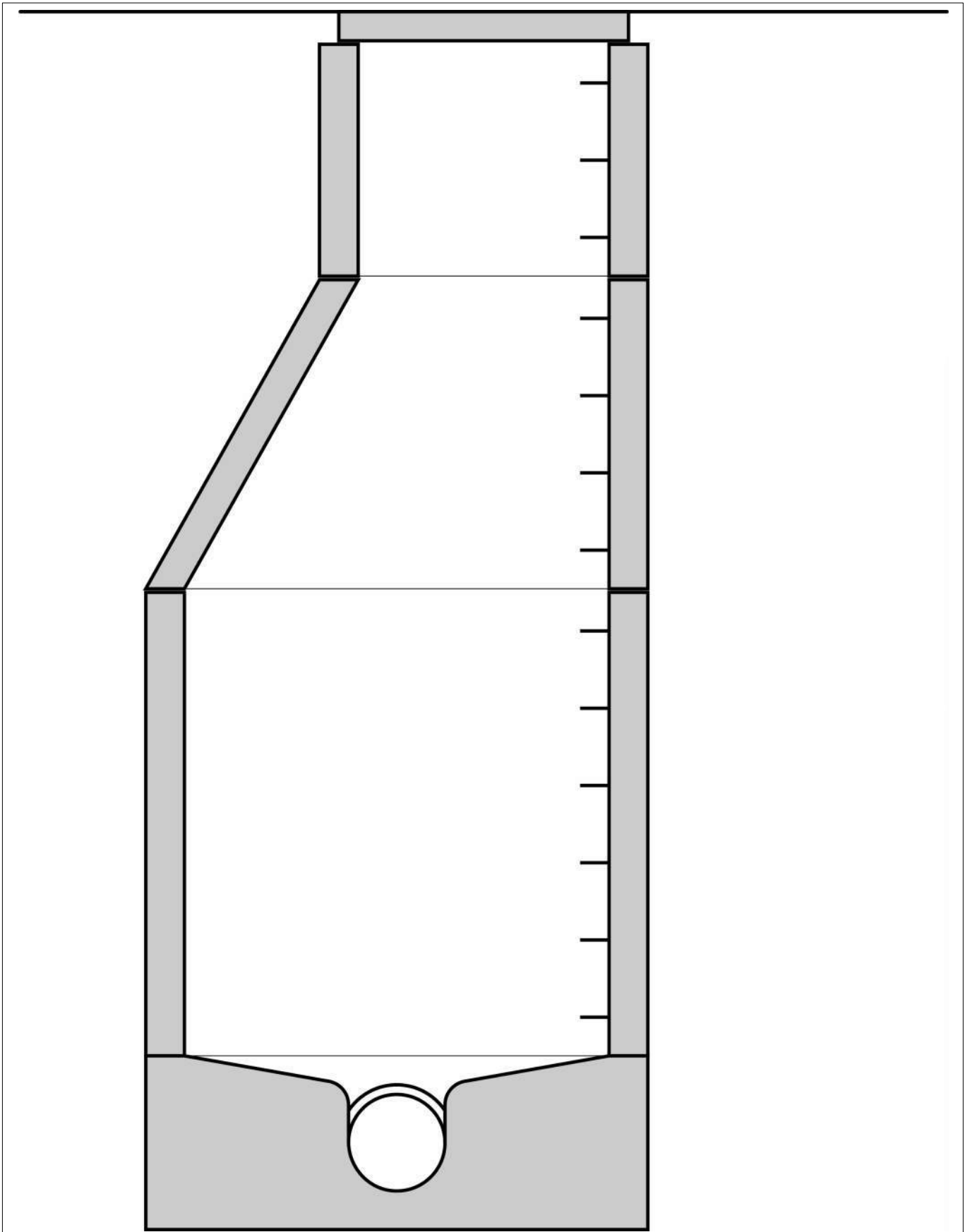



Node Pictures - 8/9/2023 - 1841

Date 8/9/2023	Manhole Number 1841	City Georgetown	Street 133 South Fraser Street	Surveyed By Matthew Headrick
-------------------------	-------------------------------	---------------------------	--	--



1841a_7e3e94ed-5602-4c81-88a8-bfb0bb428782_5ec9646d-4da9-4be7-a8c7-3f5e4dbdd8f5_PL11.jpg,
00:00:08, 1.01
Missing Mortar Small from 1 o'clock to 6 o'clock



1841a_7e3e94ed-5602-4c81-88a8-bfb0bb428782_49b19cba-c025-49c9-8b0e-801e87cd9422_PL11.jpg,
00:00:13, 2.38
Missing Mortar Large from 12 o'clock to 11 o'clock, Start



Node Pictures - 8/9/2023 - 1841

Date 8/9/2023	Manhole Number 1841	City Georgetown	Street 133 South Fraser Street	Surveyed By Matthew Headrick
------------------	------------------------	--------------------	-----------------------------------	---------------------------------



1841a_7e3e94ed-5602-4c81-88a8-bfb0bb428782_641b5ecd-14ad-4f0e-ad71-51baa60bf26d_P11.jpg,
, 2.40
Infiltration Stain from 12 o'clock to 10 o'clock, within 8 inch



1841a_7e3e94ed-5602-4c81-88a8-bfb0bb428782_daacd105-63d3-4004-8c79-a586eef84f9f_P11.jpg,
00:00:30, 7.10
Deposits Attached Ragging, 5% of cross sectional area from 8 o'clock to 12 o'clock, within 8
inch



Node Pictures - 8/9/2023 - 1841

Date 8/9/2023	Manhole Number 1841	City Georgetown	Street 133 South Fraser Street	Surveyed By Matthew Headrick
------------------	------------------------	--------------------	-----------------------------------	---------------------------------



1841a_7e3e94ed-5602-4c81-88a8-bfb0bb428782_51c81039-b210-414f-a942-c3150f368998_P11.jpg,
00:00:33, 7.62
Missing Mortar Large from 12 o'clock to 12 o'clock



1841a_7e3e94ed-5602-4c81-88a8-bfb0bb428782_0c78dd5f-e3c7-4c72-9611-2f16527626f1_P11.jpg,
00:00:42, 9.84
Surface Damage Aggregate Visible from 12 o'clock to 12 o'clock, within 8 inch



Node Drawings - 8/9/2023 - 1841

Date 8/9/2023	Manhole Number 1841	City Georgetown	Street 133 South Fraser Street	Surveyed By Matthew Headrick
------------------	------------------------	--------------------	-----------------------------------	---------------------------------

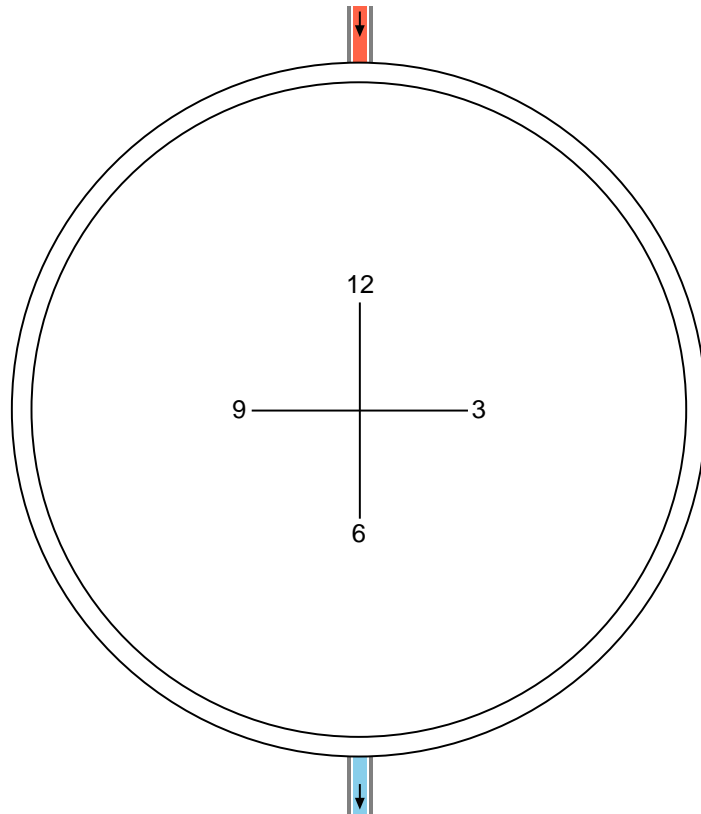
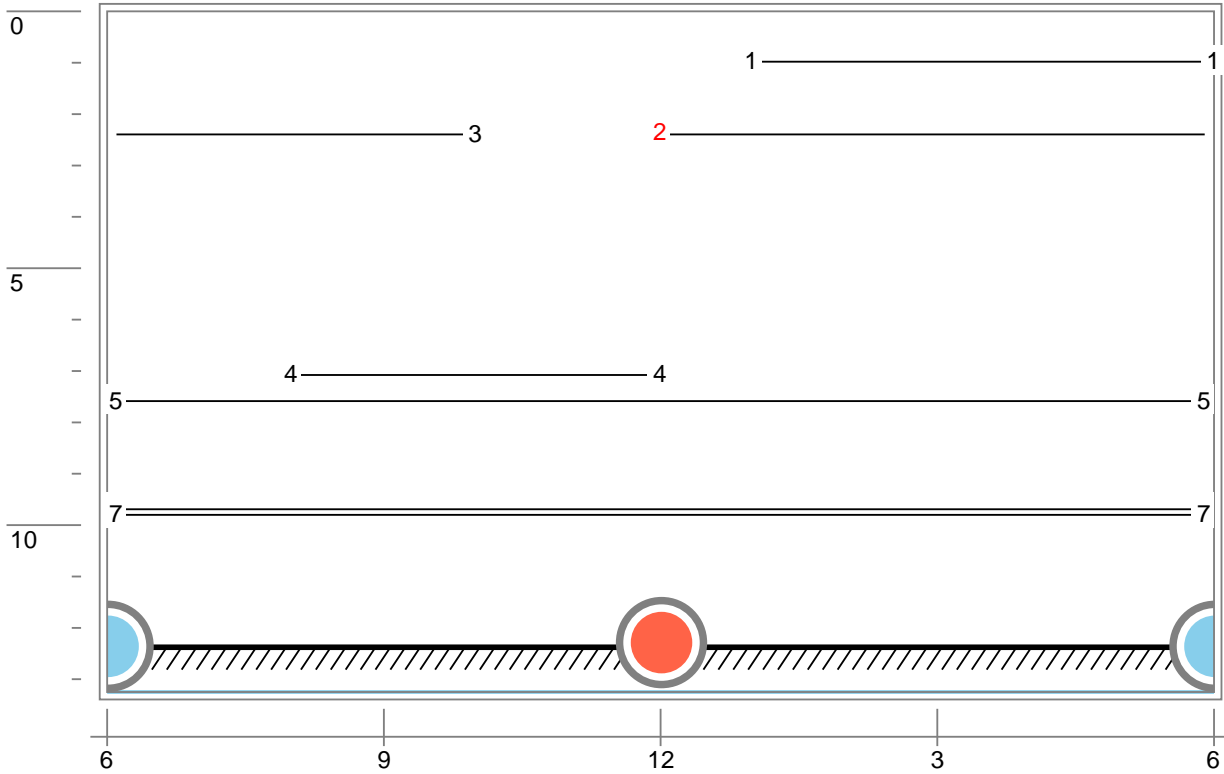



CleverScan - 8/9/2023 - 1841

Date 8/9/2023	Manhole Number 1841	City Georgetown	Street 133 South Fraser Street	Surveyed By Matthew Headrick
------------------	------------------------	--------------------	-----------------------------------	---------------------------------

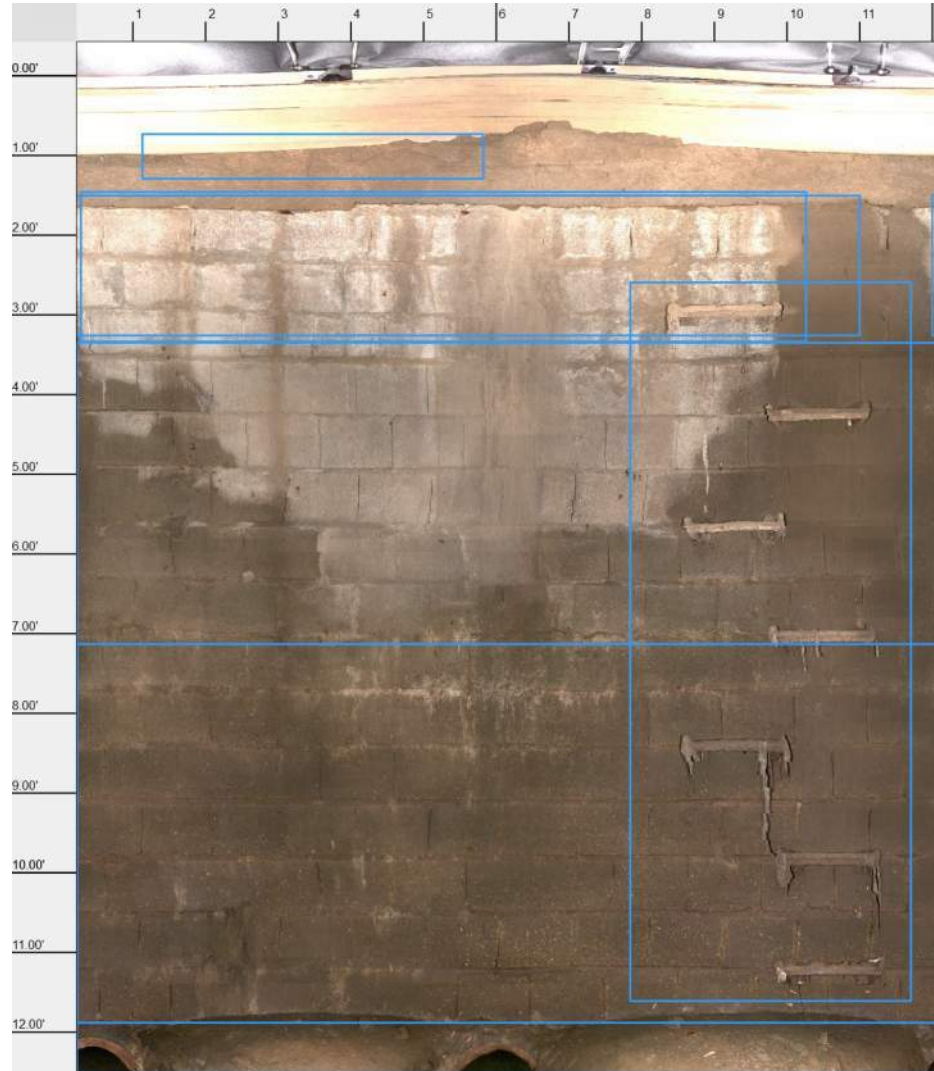



Node Inspection - 8/9/2023 - 1830

Date 8/9/2023	Time 12:02	Manhole Number 1830	Access Type Manhole	City Georgetown	Street 300 South Fraser
Surveyed By Matthew Headrick	Certificate Number U-0419-07030528	PO Number	Work Order	Pre-Cleaning No Pre-Cleaning	Sheet Number

General Manhole Information

MH Use Sanitary	Year Constructed	Year Renewed	Owner City of Georgetown
Rim to Invert 9.3'	Grade to Invert 9.3'	Rim to Grade 0.0'	Rim to Grade Exposed 0.0'
Surface Type Asphalt			
Location Code Light Highway	Location Details		
Additional component information			

General Manhole Inspection Information

Date Cleaned	Inspection Level Level 2	Consequence of Failure
Customer	Evidence Surcharge No	Purpose Routine assessment
Reviewed By Juan Bedoya	Reviewer Certificate U-1020-70400280	Weather Dry
Is Imperial No	Inspection Status Remote Inspection	Media Label WinCan 14.0
Potential for RunOff None		

Cover

Cover Type Solid					
Cover Shape Circular	Cover Size 34.1"	Center Cover Size	Cover Width		
Cover Material Cast Iron	Hole Diameter	Hole Number 0			
Cover Frame fit Good	Cover Bearing Surface Diameter 34.0"	Cover Bearing Surface Width			
Cover Condition Sound					

Cover Insert

Cover Insert Type None	Insert Condition
----------------------------------	------------------

Frame

Frame Material Cast Iron	Frame Bearing Surface Width 1.0"	Frame Bearing Surface Depth 1.5"
Frame Seal Inflow None	Frame Clear Open Diameter 31.5"	Frame Clear Open Width
Frame Depth 4.0"	Frame Offset Distance 0.0"	
Frame Condition Sound		
Seal Condition Sound		

Chimney

Chimney Present Yes	Chimney Material 1 Brick	Chimney Material 2
Chimney Clear Opening 22.7"	Chimney Depth 1.1'	Chimney Infiltration None
Chimney Condition Sound	Chimney Lining Interior None	Chimney Lining Exterior Not Known

Cone

Cone Type Conical centered	Cone Material Brick	Cone Depth 7.7'
Cone Condition Sound	Cone Lining Interior None	Cone Lining Exterior Not Known

Wall

Wall Material Brick	Wall Diameter 47.4"	Wall By Size 47.4"	Wall Depth 8.2'
Wall Condition Sound	Wall Lining Exterior Not Known	Wall Lining Interior None	

Bench

Bench Condition Sound	Bench Present Yes	Bench Material Concrete (cast in place)	Bench Lining Not Known
---------------------------------	-----------------------------	---	----------------------------------

QSR	QMR	QOR	SPR	MPR	OPR	SPRI	MPRI	OPRI
5142	2316	5142	26.0	12.0	38.0	2.6	1.3	2.0



Node Inspection - 8/9/2023 - 1830

Date 8/9/2023	Time 12:02	Manhole Number 1830	Access Type Manhole	City Georgetown	Street 300 South Fraser
Surveyed By Matthew Headrick	Certificate Number U-0419-07030528	PO Number	Work Order	Pre-Cleaning No Pre-Cleaning	Sheet Number

Channel

Channel Installed	Yes	Channel Material	Brick	Channel Type	Formed
Channel Condition	Sound	Channel Exposure	Fully Opened		

Observations

Nr.	Distance	MACP Code	Observation	Remark
1	0.7'	MMM	Missing Mortar Medium from 12 o'clock to 12 o'clock	chimney rough
2	3.1'	IS	Infiltration Stain from 4 o'clock to 9 o'clock, within 8 inch	inf stains from chimney cone join
3	3.3'	MGO	Miscellaneous General Observation	defective step
4	4.4'	MML	Missing Mortar Large from 12 o'clock to 12 o'clock	fully exposed bricks
5	6.7'	HSV	Hole Soil Visible from 8 o'clock to 10 o'clock, within 8 inch	soil visible around inlet
6	6.8'	MMM	Missing Mortar Medium from 2 o'clock to 4 o'clock	missing mortar around pipe seal
7	7.8'	IW	Infiltration Weeper from 12 o'clock to 12 o'clock, within 8 inch	infiltration from bricks all around wall
8	7.9'	DB	Displaced Brick from 5 o'clock to 7 o'clock	displaced brick wall
9	8.3'	MML	Missing Mortar Large from 12 o'clock to 12 o'clock	fully exposed bricks
10	8.5'	OBN	Obstruction Construction Debris, 35% of cross sectional area from 1 o'clock to 10 o'clock	debris on bench
11	8.8'	DSF	Deposits Settled Fine, 15% of cross sectional area from 12 o'clock to 12 o'clock, within 8 inch	settlement inside channel

Connections

Pipe Number	Rim To Invert	Direction	Clock Position	Shape	Material	Height	Width	Pipe Condition	Seal Condition	Pipe Type	Structure ID	Comments
1	9.3'	Out	6	Circular	Vitrified Clay Pipe	12"	-	Sound	Sound	Gravity Connection		
2	7.2'	In	9	Circular	Vitrified Clay Pipe	8"	-	Sound	Sound	Gravity Connection		
3	9.2'	In	12	Circular	Vitrified Clay Pipe	12"	-	Sound	Sound	Gravity Connection		
4	7.1'	In	3	Circular	Vitrified Clay Pipe	8"	-	Sound	Sound	Gravity Connection		

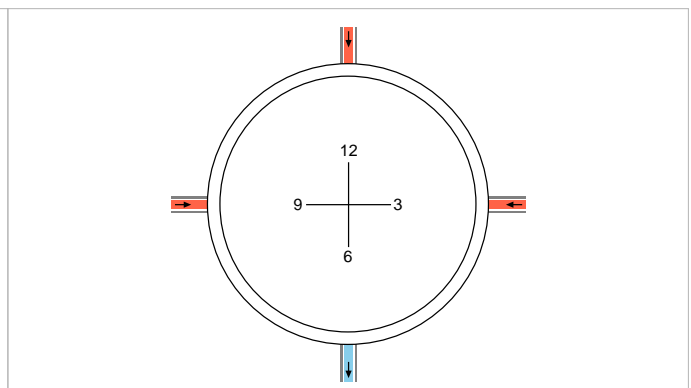
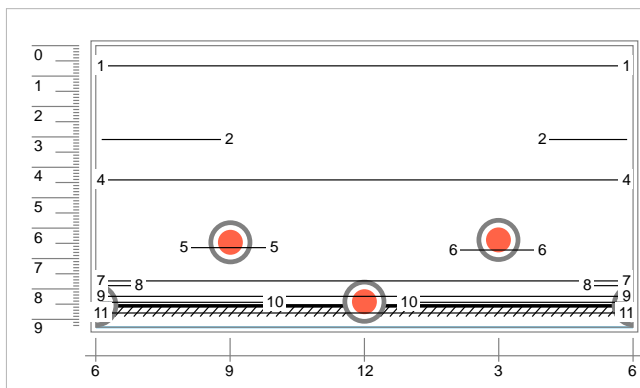

QSR	QMR	QOR	SPR	MPR	OPR	SPRI	MPRI	OPRI
5142	2316	5142	26.0	12.0	38.0	2.6	1.3	2.0



Node 2D Sketch - 8/9/2023 - 1830

Date 8/9/2023	Manhole Number 1830	City Georgetown	Street 300 South Fraser Street	Surveyed By Matthew Headrick
------------------	------------------------	--------------------	-----------------------------------	---------------------------------

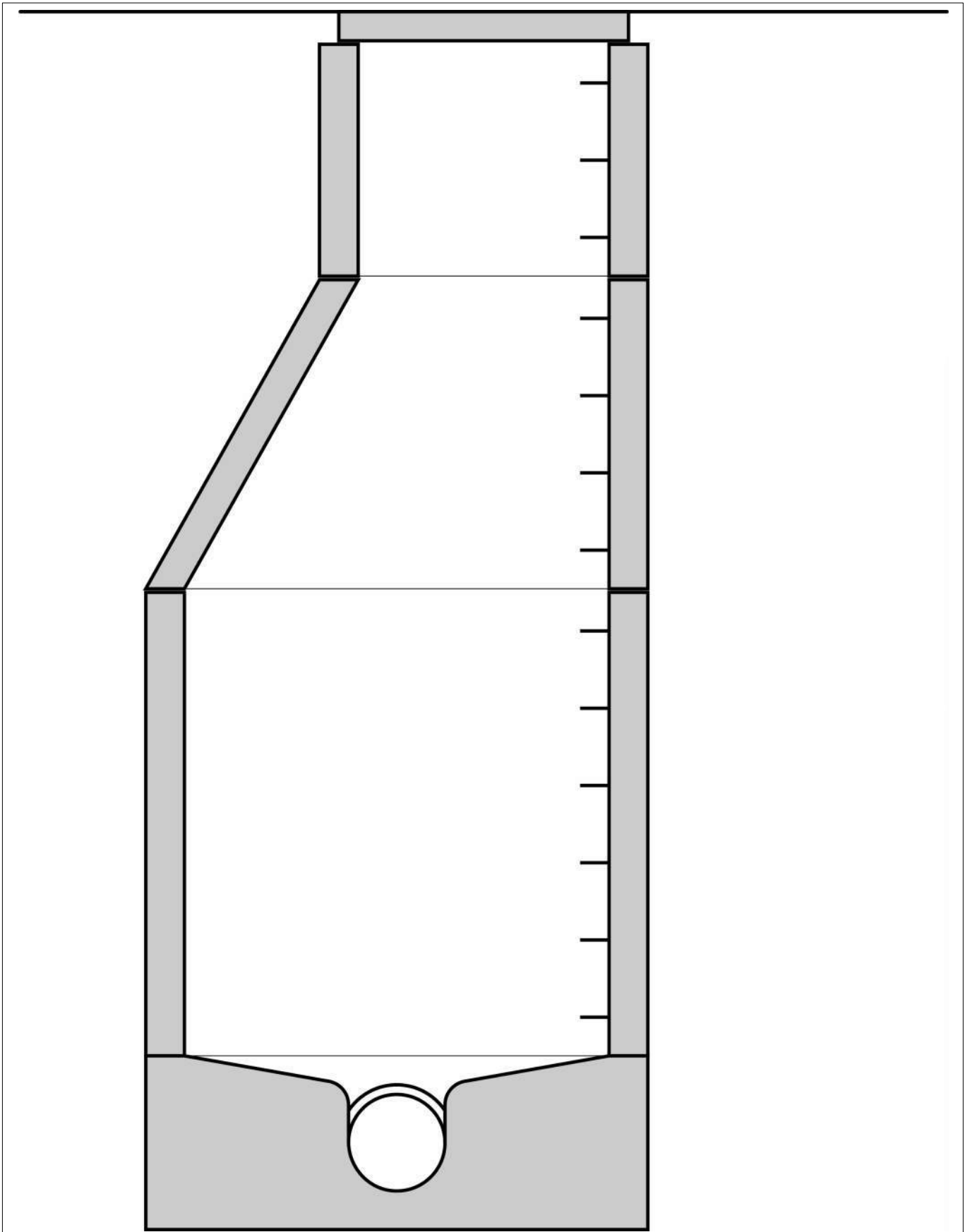



Node Pictures - 8/9/2023 - 1830

Date 8/9/2023	Manhole Number 1830	City Georgetown	Street 300 South Fraser Street	Surveyed By Matthew Headrick
------------------	------------------------	--------------------	-----------------------------------	---------------------------------



1830_f8e692ed-45a5-4111-be6d-dbb6437dd8b2_978e29b1-d29c-43a2-9208-b804c66c84c3_P11.jpg,
00:00:07, 0.67
Missing Mortar Medium from 12 o'clock to 12 o'clock



1830_f8e692ed-45a5-4111-be6d-dbb6437dd8b2_f26ac0c9-3f10-4b31-9cd6-9eb7d445b966_P11.jpg,
00:00:17, 3.09
Infiltration Stain from 4 o'clock to 9 o'clock, within 8 inch



Node Pictures - 8/9/2023 - 1830

Date 8/9/2023	Manhole Number 1830	City Georgetown	Street 300 South Fraser Street	Surveyed By Matthew Headrick
------------------	------------------------	--------------------	-----------------------------------	---------------------------------



1830_f8e692ed-45a5-4111-be6d-dbb6437dd8b2_0016bcb7-df9f-4f72-ba9f-52369976c4fd_PI1.jpg, 3.28

Miscellaneous General Observation



1830_f8e692ed-45a5-4111-be6d-dbb6437dd8b2_9d177fd4-8179-4e78-b67a-dd1ee6fb6fce_PI1.jpg, 00:00:22, 4.42

Missing Mortar Large from 12 o'clock to 12 o'clock



Node Pictures - 8/9/2023 - 1830

Date 8/9/2023	Manhole Number 1830	City Georgetown	Street 300 South Fraser Street	Surveyed By Matthew Headrick
------------------	------------------------	--------------------	-----------------------------------	---------------------------------



1830_f8e692ed-45a5-4111-be6d-dbb6437dd8b2_de081dc9-a855-40d9-ab49-9ba9a0eef9e8_P11.jpg,
00:00:32, 6.65
Hole Soil Visible from 8 o'clock to 10 o'clock, within 8 inch



1830_f8e692ed-45a5-4111-be6d-dbb6437dd8b2_0cb77971-2dac-4139-a4e2-6617e6a83616_P11.jpg,
00:00:32, 6.76
Missing Mortar Medium from 2 o'clock to 4 o'clock



Node Pictures - 8/9/2023 - 1830

Date 8/9/2023	Manhole Number 1830	City Georgetown	Street 300 South Fraser Street	Surveyed By Matthew Headrick
------------------	------------------------	--------------------	-----------------------------------	---------------------------------



1830_f8e692ed-45a5-4111-be6d-dbb6437dd8b2_d363373a-311b-4f24-a0ef-09d577813ae1_P11.jpg,
00:00:37, 7.77
Infiltration Weeper from 12 o'clock to 12 o'clock, within 8 inch



1830_f8e692ed-45a5-4111-be6d-dbb6437dd8b2_e7ceb1d1-5301-4ee2-b6a3-deb392ea1197_P11.jpg,
00:00:38, 7.93
Displaced Brick from 5 o'clock to 7 o'clock



Node Pictures - 8/9/2023 - 1830

Date 8/9/2023	Manhole Number 1830	City Georgetown	Street 300 South Fraser Street	Surveyed By Matthew Headrick
------------------	------------------------	--------------------	-----------------------------------	---------------------------------



1830_f8e692ed-45a5-4111-be6d-dbb6437dd8b2_0017aeda-f63f-406e-b9a0-11021f9f5edf_PI1.jpg,
00:00:40, 8.26
Missing Mortar Large from 12 o'clock to 2 o'clock



1830_f8e692ed-45a5-4111-be6d-dbb6437dd8b2_3adc60c1-ed59-466f-9d64-e0d2b984441e_PI1.jpg,
00:00:40, 8.48
Obstruction Construction Debris, 35% of cross sectional area from 1 o'clock to 10 o'clock



Node Pictures - 8/9/2023 - 1830

Date 8/9/2023	Manhole Number 1830	City Georgetown	Street 300 South Fraser Street	Surveyed By Matthew Headrick
------------------	------------------------	--------------------	-----------------------------------	---------------------------------



1830_f8e692ed-45a5-4111-be6d-dbb6437dd8b2_09a3541c-4a16-43e5-a383-d82113518f21_P11.jpg,
00:00:40, 8.82
Deposits Settled Fine, 15% of cross sectional area from 12 o'clock to 12 o'clock, within 8 inch



Node Drawings - 8/9/2023 - 1830

Date 8/9/2023	Manhole Number 1830	City Georgetown	Street 300 South Fraser Street	Surveyed By Matthew Headrick
------------------	------------------------	--------------------	-----------------------------------	---------------------------------

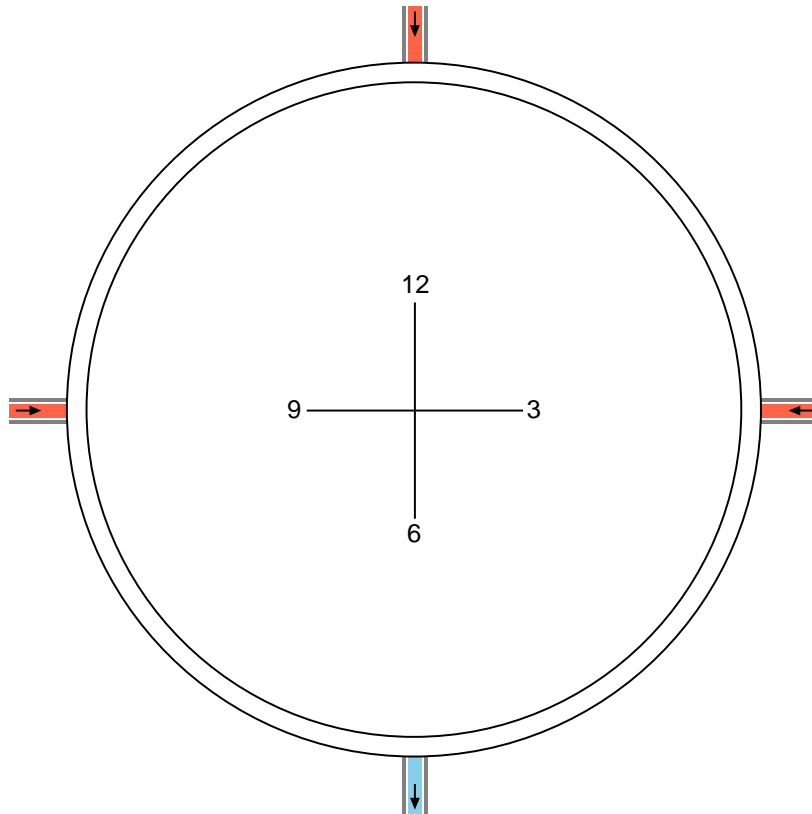
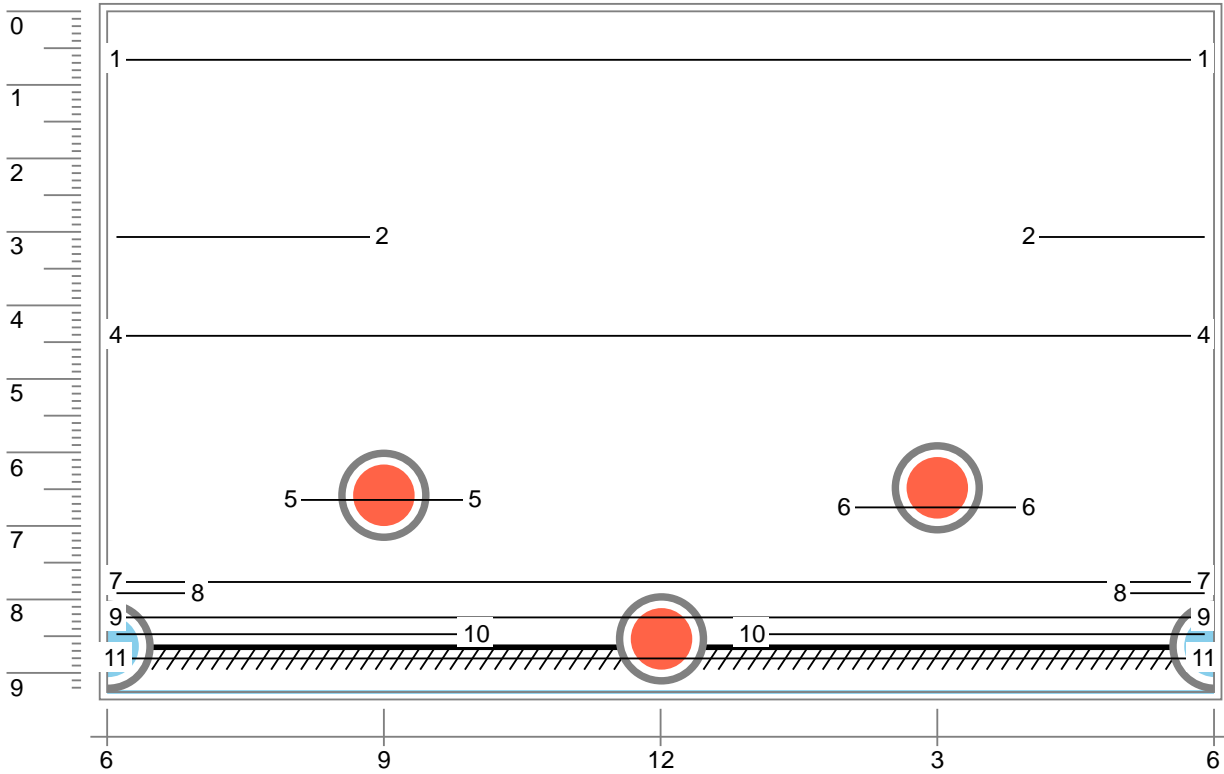



CleverScan - 8/9/2023 - 1830

Date 8/9/2023	Manhole Number 1830	City Georgetown	Street 300 South Fraser Street	Surveyed By Matthew Headrick
------------------	------------------------	--------------------	-----------------------------------	---------------------------------

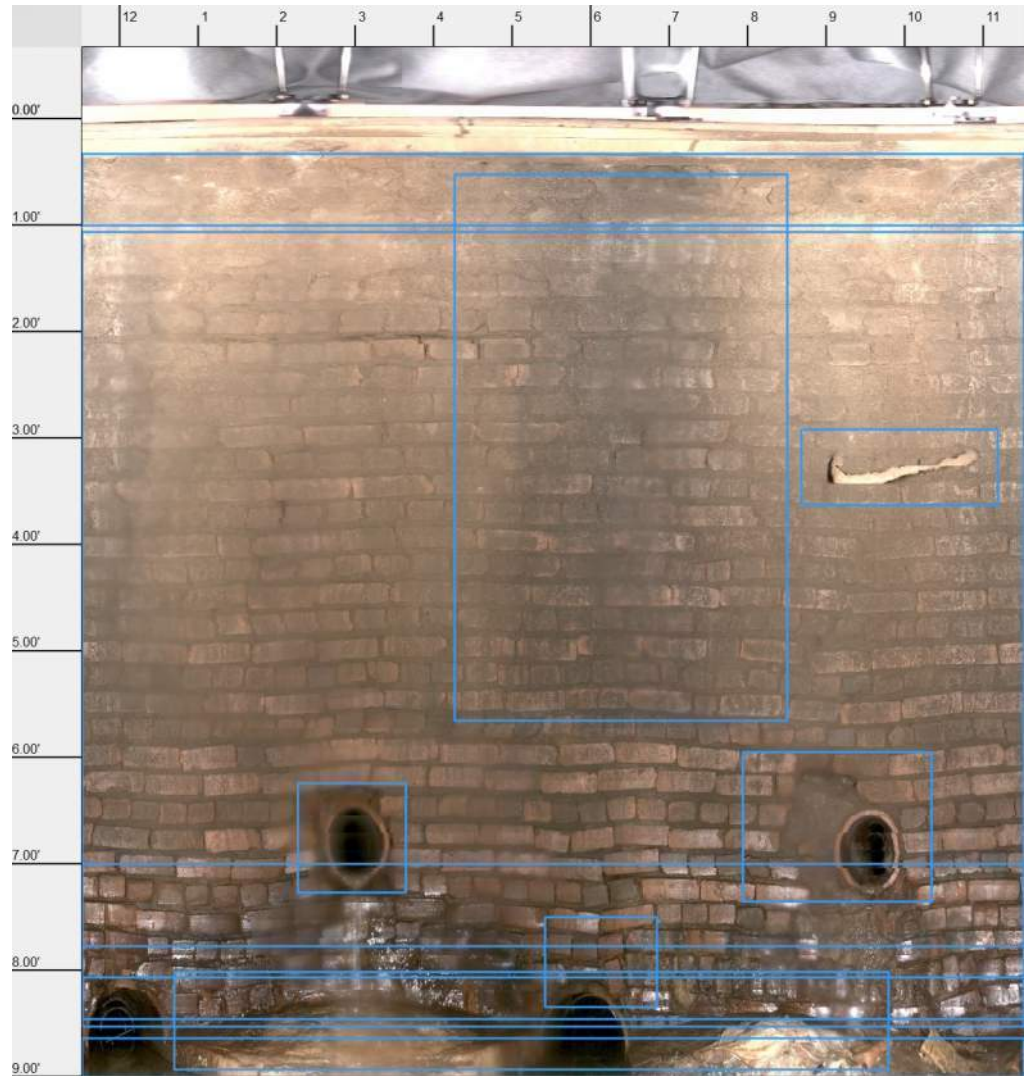



Node Inspection - 8/9/2023 - 1838

Date 8/9/2023	Time 12:02	Manhole Number 1838	Access Type Manhole	City Georgetown	Street 407 South Fraser
Surveyed By Matthew Headrick	Certificate Number U-0419-07030528	PO Number	Work Order	Pre-Cleaning No Pre-Cleaning	Sheet Number

General Manhole Information

MH Use Sanitary	Year Constructed	Year Renewed	Owner	City of Georgetown
Rim to Invert 9.9'	Grade to Invert 9.9'	Rim to Grade 0.0'	Rim to Grade Exposed	0.0'
Surface Type Asphalt				
Location Code Light Highway	Location Details			
Additional component information	Needs replaced ASAP. Lid too small and going to fall in.			

General Manhole Inspection Information

Date Cleaned	Inspection Level Level 2	Consequence of Failure
Customer	Evidence Surcharge No	Purpose Routine assessment
Reviewed By Juan Bedoya	Reviewer Certificate U-1020-70400280	Weather Dry
Is Imperial No	Inspection Status Remote Inspection	Media Label WinCan 14.0
Potential for RunOff	None	

Cover

Cover Type Solid					
Cover Shape Circular	Cover Size 23.5"	Center Cover Size	Cover Width		
Cover Material Cast Iron	Hole Diameter	Hole Number		0	
Cover Frame fit Undersized	Cover Bearing Surface Diameter 23.0"	Cover Bearing Surface Width			
Cover Condition Corroded					

Cover Insert

Cover Insert Type None	Insert Condition
----------------------------------	------------------

Frame

Frame Material Cast Iron	Frame Bearing Surface Width 0.3"	Frame Bearing Surface Depth 2.0"
Frame Seal Inflow None	Frame Clear Open Diameter 22.5"	Frame Clear Open Width
Frame Depth 7.0"	Frame Offset Distance 0.0"	
Frame Condition Corroded		
Seal Condition Sound		

Chimney

Chimney Present Yes	Chimney Material 1 Brick	Chimney Material 2
Chimney Clear Opening 22.3"	Chimney Depth 1.4'	Chimney Infiltration Infil Stained
Chimney Condition Sound	Chimney Lining Interior None	Chimney Lining Exterior Not Known

Cone

Cone Type Conical centered	Cone Material Brick	Cone Depth 4.0'
Cone Condition Sound	Cone Lining Interior None	Cone Lining Exterior Not Known

Wall

Wall Material Brick	Wall Diameter 48.0"	Wall By Size 48.0"	Wall Depth 8.1'
Wall Condition Sound	Wall Lining Exterior Not Known	Wall Lining Interior None	

Bench

Bench Condition Sound	Bench Present Yes	Bench Material Concrete (cast in place)	Bench Lining None
---------------------------------	-----------------------------	---	-----------------------------

QSR	QMR	QOR	SPR	MPR	OPR	SPRI	MPRI	OPRI
5144	5123	5244	28.0	16.0	44.0	2.8	1.8	2.3



Node Inspection - 8/9/2023 - 1838

Date 8/9/2023	Time 12:02	Manhole Number 1838	Access Type Manhole	City Georgetown	Street 407 South Fraser
Surveyed By Matthew Headrick	Certificate Number U-0419-07030528	PO Number	Work Order	Pre-Cleaning No Pre-Cleaning	Sheet Number

Channel

Channel Installed	Yes	Channel Material	Vitrified Clay	Channel Type	Pipe
Channel Condition	Sound	Channel Exposure	Fully Opened		

Steps

Step Number	3	Step Material	Metal
-------------	----------	---------------	--------------

Observations

Nr.	Distance	MACP Code	Observation	Remark
1	1.0'	MML	Missing Mortar Large from 12 o'clock to 12 o'clock	fully exposed bricks with gaps
2	1.5'	IS	Infiltration Stain from 12 o'clock to 12 o'clock, within 8 inch	infiltration stains from chimney cone join
3	2.7'	MML	Missing Mortar Large from 12 o'clock to 12 o'clock	fully exposed blocks with gaps
4	4.9'	DAR	Deposits Attached Ragging, 5% of cross sectional area from 6 o'clock to 8 o'clock, within 8 inch	rags indicative of surcharged conditions
5	6.1'	SAV	Surface Damage Aggregate Visible from 12 o'clock to 12 o'clock, within 8 inch	visible aggregate at all wall blocks
6	6.1'	MML	Missing Mortar Large from 12 o'clock to 12 o'clock	fully exposed blocks with gaps
7	8.4'	CL	Crack Longitudinal at 7 o'clock, within 8 inch	cracked bench
8	8.4'	IW	Infiltration Weeper from 5 o'clock to 7 o'clock, within 8 inch	minor infiltraton above inlet
9	8.5'	IW	Infiltration Weeper from 12 o'clock to 1 o'clock, within 8 inch	minor infiltration above inlet

Connections

Pipe Number	Rim To Invert	Direction	Clock Position	Shape	Material	Height	Width	Pipe Condition	Seal Condition	Pipe Type	Structure ID	Comments
1	9.9'	Out	6	Circular	Vitrified Clay Pipe	12"	-	Sound	Sound	Gravity Connection		
2	5.3'	In	9	Circular	Vitrified Clay Pipe	8"	-	Sound	Sound	Gravity Connection		
3	9.9'	In	1	Circular	Vitrified Clay Pipe	12"	-	Sound	Sound	Gravity Connection		

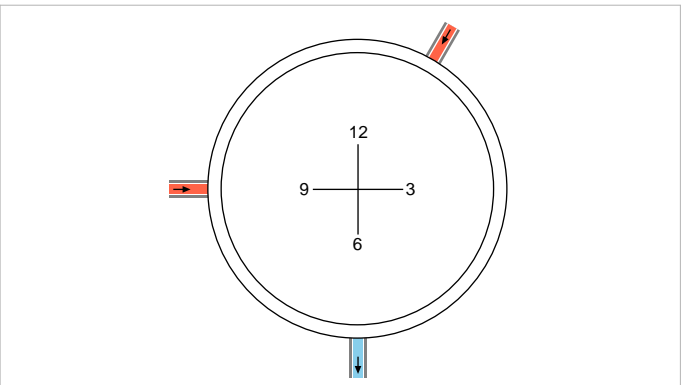
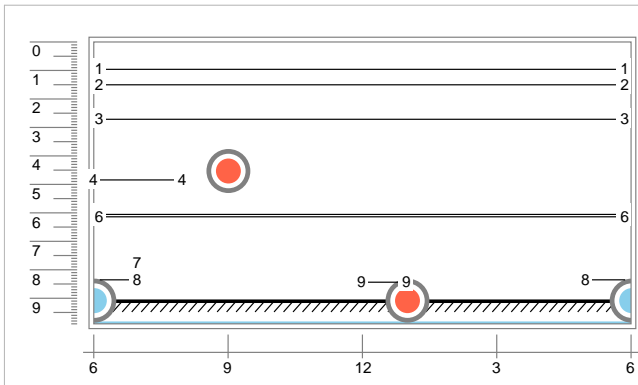

QSR	QMR	QOR	SPR	MPR	OPR	SPRI	MPRI	OPRI
5144	5123	5244	28.0	16.0	44.0	2.8	1.8	2.3



Node 2D Sketch - 8/9/2023 - 1838

Date 8/9/2023	Manhole Number 1838	City Georgetown	Street 407 South Fraser Street	Surveyed By Matthew Headrick
------------------	------------------------	--------------------	-----------------------------------	---------------------------------

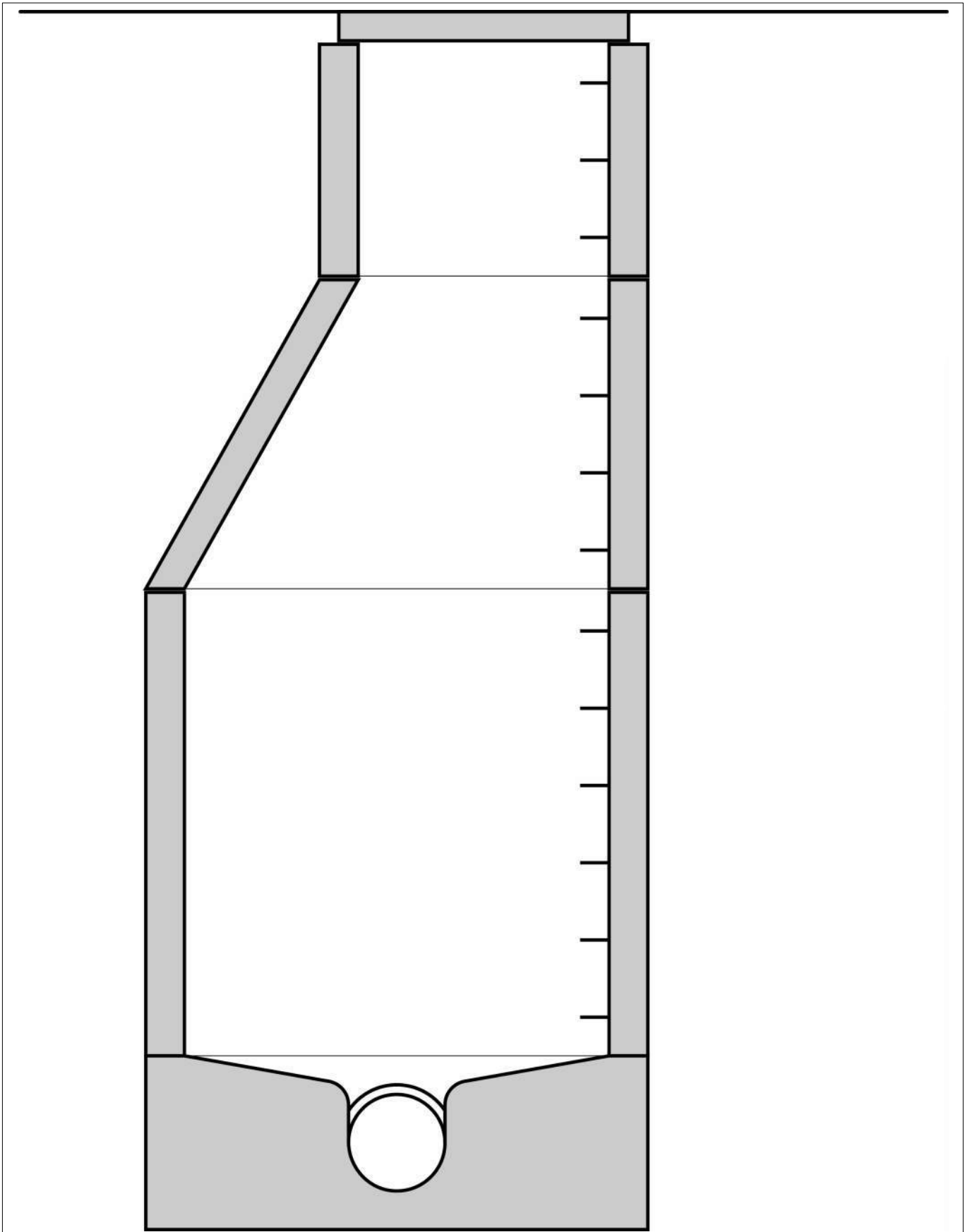



Node Pictures - 8/9/2023 - 1838

Date 8/9/2023	Manhole Number 1838	City Georgetown	Street 407 South Fraser Street	Surveyed By Matthew Headrick
------------------	------------------------	--------------------	-----------------------------------	---------------------------------



1838_4d464b94-a957-4557-a7ae-8bb14bf4d783_cce063f1-45ad-4048-bcad-c59e8cfe279b_P11.jpg,
00:00:08, 0.96
Missing Mortar Large from 12 o'clock to 12 o'clock



1838_4d464b94-a957-4557-a7ae-8bb14bf4d783_e2af839c-408d-41e6-99c2-131845b5d5b6_P11.jpg,
, 1.51
Infiltration Stain from 12 o'clock to 12 o'clock, within 8 inch



Node Pictures - 8/9/2023 - 1838

Date 8/9/2023	Manhole Number 1838	City Georgetown	Street 407 South Fraser Street	Surveyed By Matthew Headrick
------------------	------------------------	--------------------	-----------------------------------	---------------------------------



1838_4d464b94-a957-4557-a7ae-8bb14bf4d783_e264c322-c1cf-4ac7-a7cc-1ded439b5dae_P11.jpg,
00:00:15, 2.72
Missing Mortar Large from 12 o'clock to 12 o'clock



1838_4d464b94-a957-4557-a7ae-8bb14bf4d783_2af9f40c-8e6b-4a28-8936-9ca041e50edf_P11.jpg,
00:00:23, 4.86
Deposits Attached Ragging, 5% of cross sectional area from 6 o'clock to 8 o'clock, within 8 inch



Node Pictures - 8/9/2023 - 1838

Date 8/9/2023	Manhole Number 1838	City Georgetown	Street 407 South Fraser Street	Surveyed By Matthew Headrick
------------------	------------------------	--------------------	-----------------------------------	---------------------------------



1838_4d464b94-a957-4557-a7ae-8bb14bf4d783_b3954de8-385d-4369-9bee-3867a1223ba2_P11.jpg,
00:00:28, 6.10
Surface Damage Aggregate Visible from 12 o'clock to 12 o'clock, within 8 inch



1838_4d464b94-a957-4557-a7ae-8bb14bf4d783_5c5b9007-ca65-4280-add5-f176f9132037_P11.jpg,
00:00:28, 6.15
Missing Mortar Large from 12 o'clock to 12 o'clock



Node Pictures - 8/9/2023 - 1838

Date 8/9/2023	Manhole Number 1838	City Georgetown	Street 407 South Fraser Street	Surveyed By Matthew Headrick
------------------	------------------------	--------------------	-----------------------------------	---------------------------------

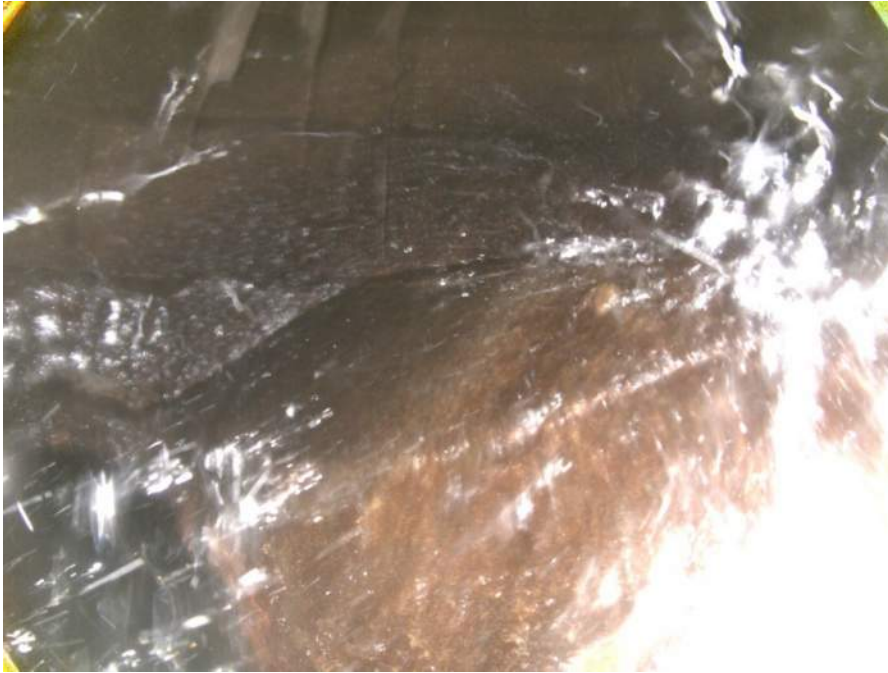

1838_4d464b94-a957-4557-a7ae-8bb14bf4d783_04cfbab0-958e-48d8-82d2-5ef393c965f4_PI1.jpg,
00:00:38, 8.37
Crack Longitudinal at 7 o'clock, within 8 inch



1838_4d464b94-a957-4557-a7ae-8bb14bf4d783_bcf02ece-7deb-4f88-be2a-457d033fda34_PI1.jpg,
00:00:38, 8.39
Infiltration Weeper from 5 o'clock to 7 o'clock, within 8 inch



Node Pictures - 8/9/2023 - 1838

Date 8/9/2023	Manhole Number 1838	City Georgetown	Street 407 South Fraser Street	Surveyed By Matthew Headrick
------------------	------------------------	--------------------	-----------------------------------	---------------------------------

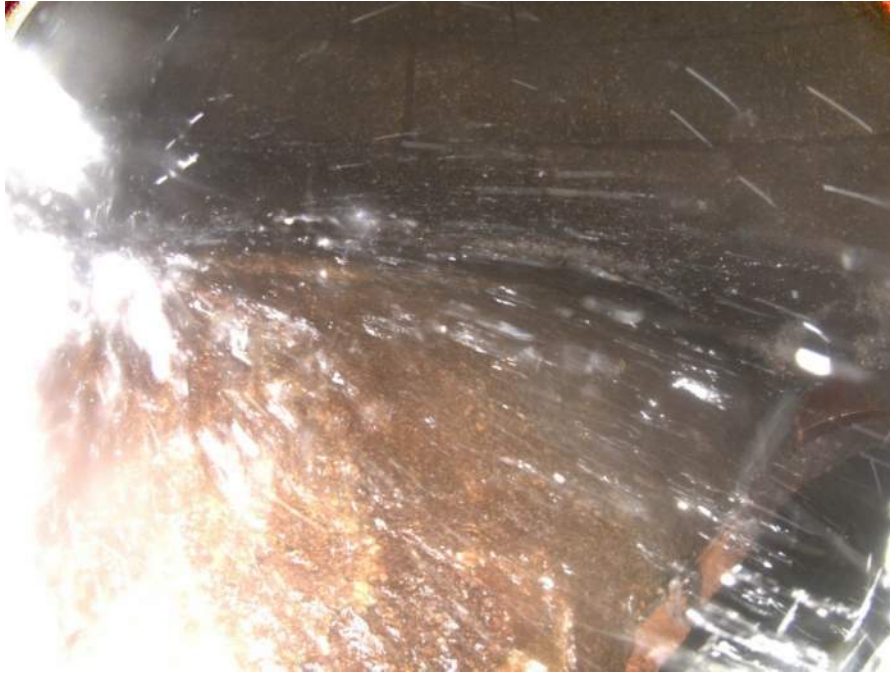

1838_4d464b94-a957-4557-a7ae-8bb14bf4d783_8215d7ef-ee63-4f71-aeed-bba2ebaa76ec_P11.jpg,
00:00:38, 8.46
Infiltration Weeper from 12 o'clock to 1 o'clock, within 8 inch



Node Drawings - 8/9/2023 - 1838

Date
8/9/2023

Manhole Number
1838

City
Georgetown

Street
407 South Fraser Street

Surveyed By
Matthew Headrick

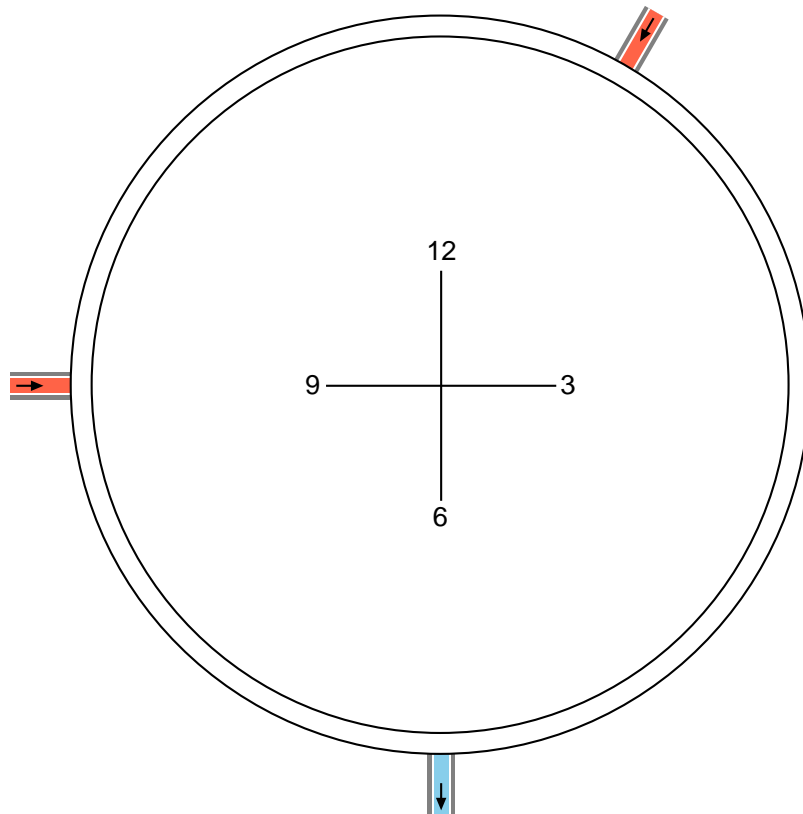
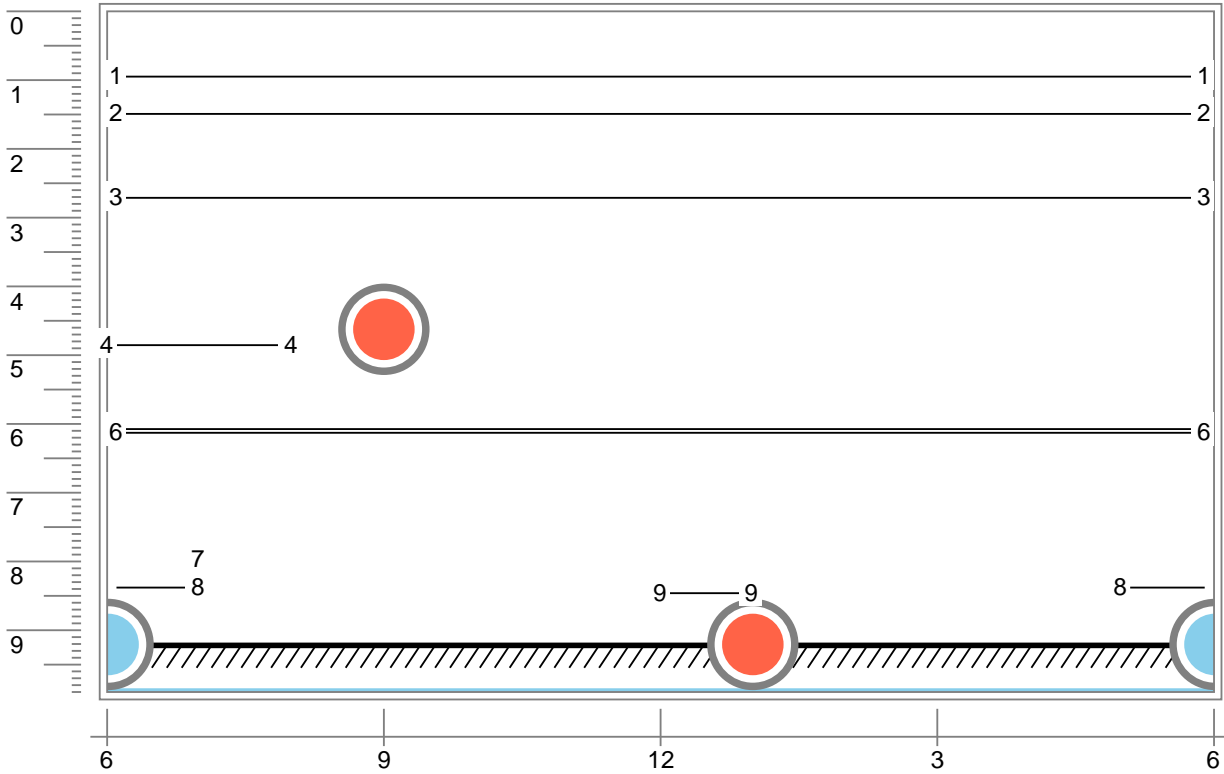



CleverScan - 8/9/2023 - 1838

Date 8/9/2023	Manhole Number 1838	City Georgetown	Street 407 South Fraser Street	Surveyed By Matthew Headrick
------------------	------------------------	--------------------	-----------------------------------	---------------------------------

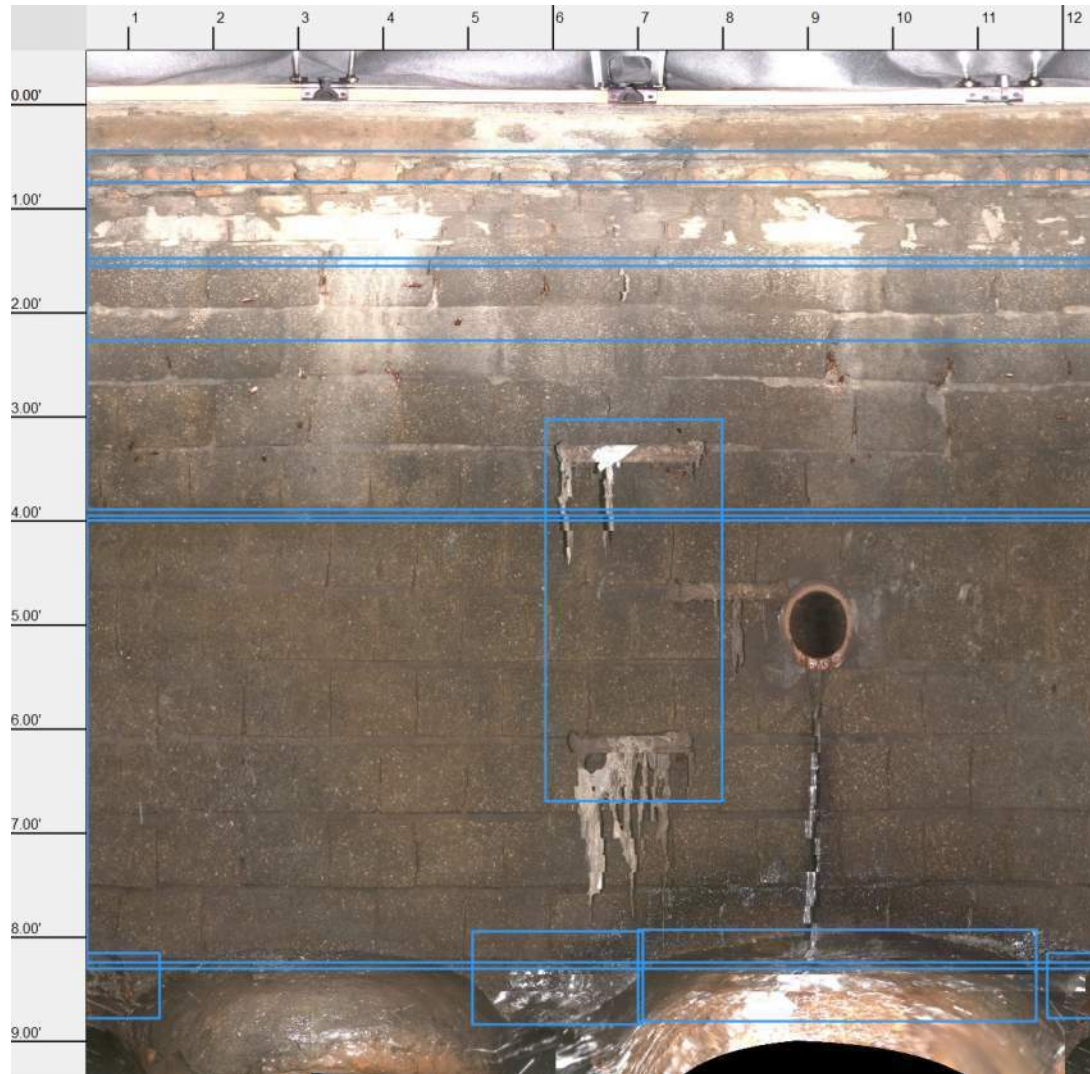



Node Inspection - 8/9/2023 - 1819

Date 8/9/2023	Time 12:03	Manhole Number 1819	Access Type Manhole	City Georgetown	Street 600 South Fraser
Surveyed By Matthew Headrick	Certificate Number U-0419-07030528	PO Number	Work Order	Pre-Cleaning No Pre-Cleaning	Sheet Number

General Manhole Information

MH Use Sanitary	Year Constructed	Year Renewed	Owner City of Georgetown
Rim to Invert 9.8'	Grade to Invert 9.8'	Rim to Grade 0.0'	Rim to Grade Exposed 0.0'
Surface Type Asphalt			
Location Code Light Highway	Location Details		
Additional component information			

General Manhole Inspection Information

Date Cleaned	Inspection Level Level 2	Consequence of Failure
Customer	Evidence Surcharge No	Purpose Routine assessment
Reviewed By Juan Bedoya	Reviewer Certificate U-1020-70400280	Weather Dry
Is Imperial No	Inspection Status Remote Inspection	Media Label WinCan 14.0
Potential for RunOff None		

Cover

Cover Type Solid					
Cover Shape Circular	Cover Size 23.5"	Center Cover Size	Cover Width		
Cover Material Cast Iron	Hole Diameter	Hole Number 0			
Cover Frame fit Good	Cover Bearing Surface Diameter 23.0"	Cover Bearing Surface Width			
Cover Condition Sound					

Cover Insert

Cover Insert Type None	Insert Condition
----------------------------------	------------------

Frame

Frame Material Cast Iron	Frame Bearing Surface Width 0.5"	Frame Bearing Surface Depth 1.0"
Frame Seal Inflow None	Frame Clear Open Diameter 22.0"	Frame Clear Open Width
Frame Depth 3.0"	Frame Offset Distance 0.0"	
Frame Condition Sound		
Seal Condition Missing		

Chimney

Chimney Present Yes	Chimney Material 1 Brick	Chimney Material 2
Chimney Clear Opening 25.6"	Chimney Depth 1.6'	Chimney Infiltration Infil Stained
Chimney Condition Sound	Chimney Lining Interior None	Chimney Lining Exterior Not Known

Cone

Cone Type Conical centered	Cone Material Brick	Cone Depth 5.5'
Cone Condition Sound	Cone Lining Interior None	Cone Lining Exterior Not Known

Wall

Wall Material Brick	Wall Diameter 45.9"	Wall By Size 45.9"	Wall Depth 8.0'
Wall Condition Sound	Wall Lining Exterior Not Known	Wall Lining Interior None	

Bench

Bench Condition Sound	Bench Present Yes	Bench Material Brick	Bench Lining None
---------------------------------	-----------------------------	--------------------------------	-----------------------------

QSR	QMR	QOR	SPR	MPR	OPR	SPRI	MPRI	OPRI
4331	3124	4332	20.0	15.0	35.0	2.5	1.7	2.1



Node Inspection - 8/9/2023 - 1819

Date 8/9/2023	Time 12:03	Manhole Number 1819	Access Type Manhole	City Georgetown	Street 600 South Fraser
Surveyed By Matthew Headrick	Certificate Number U-0419-07030528	PO Number	Work Order	Pre-Cleaning No Pre-Cleaning	Sheet Number

Channel

Channel Installed	Yes	Channel Material	Concrete (cast in place)	Channel Type	Formed
Channel Condition	Sound	Channel Exposure	Fully Opened		

Observations

Nr.	Distance	MACP Code	Observation	Remark
1	1.1'	MML	Missing Mortar Large from 12 o'clock to 12 o'clock	Fully exposed bricks with gaps
2	1.9'	IS	Infiltration Stain from 12 o'clock to 12 o'clock, within 8 inch	infiltration stains from chimney cone joint
3	3.6'	MML	Missing Mortar Large from 12 o'clock to 12 o'clock	Fully exposed bricks with gaps
4	6.4'	IW	Infiltration Weeper from 11 o'clock to 3 o'clock, within 8 inch	very minor infiltration from wall bricks
5	7.0'	MML	Missing Mortar Large from 12 o'clock to 12 o'clock	Fully exposed bricks with gaps
6	8.0'	IW	Infiltration Weeper from 5 o'clock to 7 o'clock, within 8 inch	minor infiltration from pipe seal
7	8.6'	DSZ	Deposits Settled Other, 35% of cross sectional area from 9 o'clock to 3 o'clock, within 8 inch	deposits on bench
8	8.6'	MMS	Missing Mortar Small from 3 o'clock to 9 o'clock	minor brick exposure bench

Connections

Pipe Number	Rim To Invert	Direction	Clock Position	Shape	Material	Height	Width	Pipe Condition	Seal Condition	Pipe Type	Structure ID	Comments
1	9.8'	Out	6	Circular	Cast Iron	15"	-	Sound	Sound	Gravity Connection		
2	8.7'	In	9	Circular	Vitrified Clay Pipe	8"	-	Sound	Sound	Gravity Connection		
3	8.8'	In	3	Circular	Vitrified Clay Pipe	12"	-	Sound	Sound	Gravity Connection		

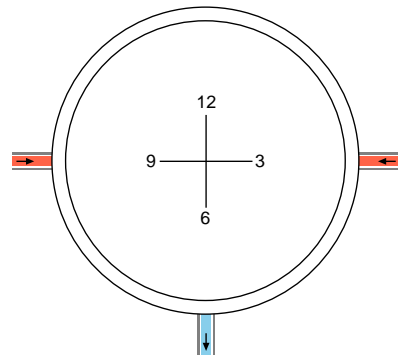
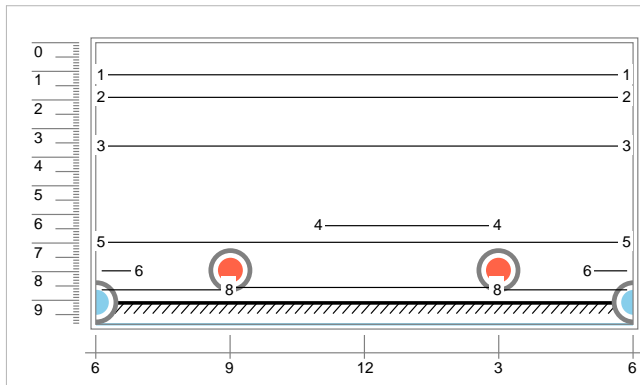

QSR	QMR	QOR	SPR	MPR	OPR	SPRI	MPRI	OPRI
4331	3124	4332	20.0	15.0	35.0	2.5	1.7	2.1



Node 2D Sketch - 8/9/2023 - 1819

Date 8/9/2023	Manhole Number 1819	City Georgetown	Street 600 South Fraser Street	Surveyed By Matthew Headrick
------------------	------------------------	--------------------	-----------------------------------	---------------------------------

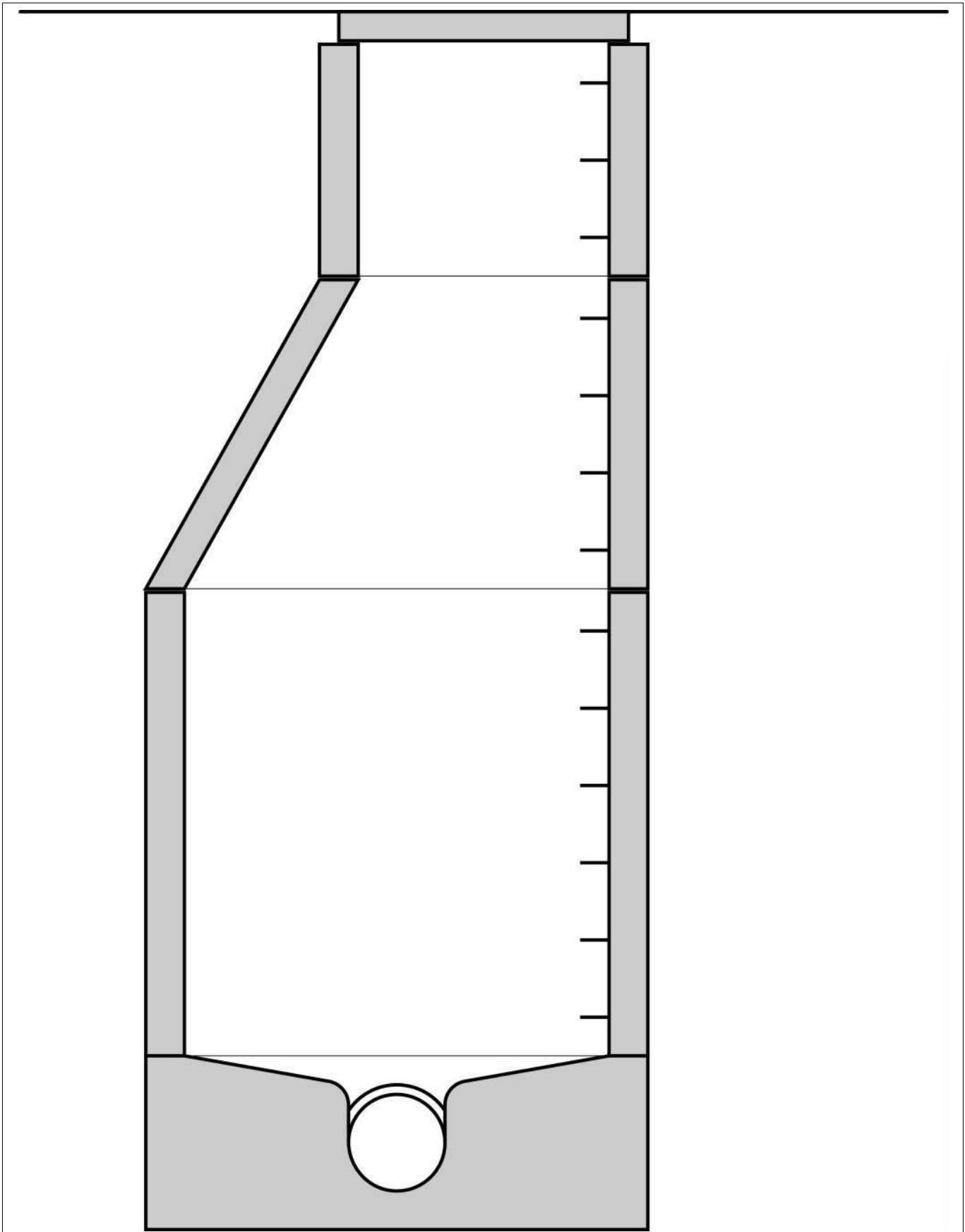



Node Pictures - 8/9/2023 - 1819

Date 8/9/2023	Manhole Number 1819	City Georgetown	Street 600 South Fraser Street	Surveyed By Matthew Headrick
------------------	------------------------	--------------------	-----------------------------------	---------------------------------



1819_3d72062a-4862-48ce-be8e-7bbe04d95bb2_4dd14b71-64fa-4846-b986-3e011a3effe3_P11.jpg,
00:00:09, 1.12
Missing Mortar Large from 12 o'clock to 12 o'clock



1819_3d72062a-4862-48ce-be8e-7bbe04d95bb2_603a522c-9262-4b30-a481-701e95f23165_P11.jpg,
, 1.93
Infiltration Stain from 12 o'clock to 12 o'clock, within 8 inch



Node Pictures - 8/9/2023 - 1819

Date 8/9/2023	Manhole Number 1819	City Georgetown	Street 600 South Fraser Street	Surveyed By Matthew Headrick
------------------	------------------------	--------------------	-----------------------------------	---------------------------------



1819_3d72062a-4862-48ce-be8e-7bbe04d95bb2_032d7f95-1b7c-47a9-8899-107e5eae3b48_P11.jpg,
00:00:18, 3.65
Missing Mortar Large from 12 o'clock to 12 o'clock



1819_3d72062a-4862-48ce-be8e-7bbe04d95bb2_49e29911-486c-4574-8c37-30f56f9aaa5d_P11.jpg,
00:00:30, 6.41
Infiltration Weeper from 11 o'clock to 3 o'clock, within 8 inch



Node Pictures - 8/9/2023 - 1819

Date 8/9/2023	Manhole Number 1819	City Georgetown	Street 600 South Fraser Street	Surveyed By Matthew Headrick
------------------	------------------------	--------------------	-----------------------------------	---------------------------------



1819_3d72062a-4862-48ce-be8e-7bbe04d95bb2_9da08c23-6361-4752-b91f-34d64f0347f5_P11.jpg,
00:00:32, 7.00
Missing Mortar Large from 12 o'clock to 12 o'clock



1819_3d72062a-4862-48ce-be8e-7bbe04d95bb2_00b5059a-7ab1-4e45-9d64-250f6cb011a2_P11.jpg,
00:00:36, 8.01
Infiltration Weeper from 5 o'clock to 7 o'clock, within 8 inch



Node Pictures - 8/9/2023 - 1819

Date 8/9/2023	Manhole Number 1819	City Georgetown	Street 600 South Fraser Street	Surveyed By Matthew Headrick
------------------	------------------------	--------------------	-----------------------------------	---------------------------------



1819_3d72062a-4862-48ce-be8e-7bbe04d95bb2_bdad6f71-750a-47c5-9c9e-cf68ca13fd8e_P11.jpg,
00:00:36, 8.57
Deposits Settled Other, 35% of cross sectional area from 9 o'clock to 3 o'clock, within 8 inch



1819_3d72062a-4862-48ce-be8e-7bbe04d95bb2_f70a0414-0ff6-4f34-b025-c17650aa6690_P11.jpg,
00:00:36, 8.64
Missing Mortar Small from 3 o'clock to 9 o'clock



Node Drawings - 8/9/2023 - 1819

Date 8/9/2023	Manhole Number 1819	City Georgetown	Street 600 South Fraser Street	Surveyed By Matthew Headrick
------------------	------------------------	--------------------	-----------------------------------	---------------------------------

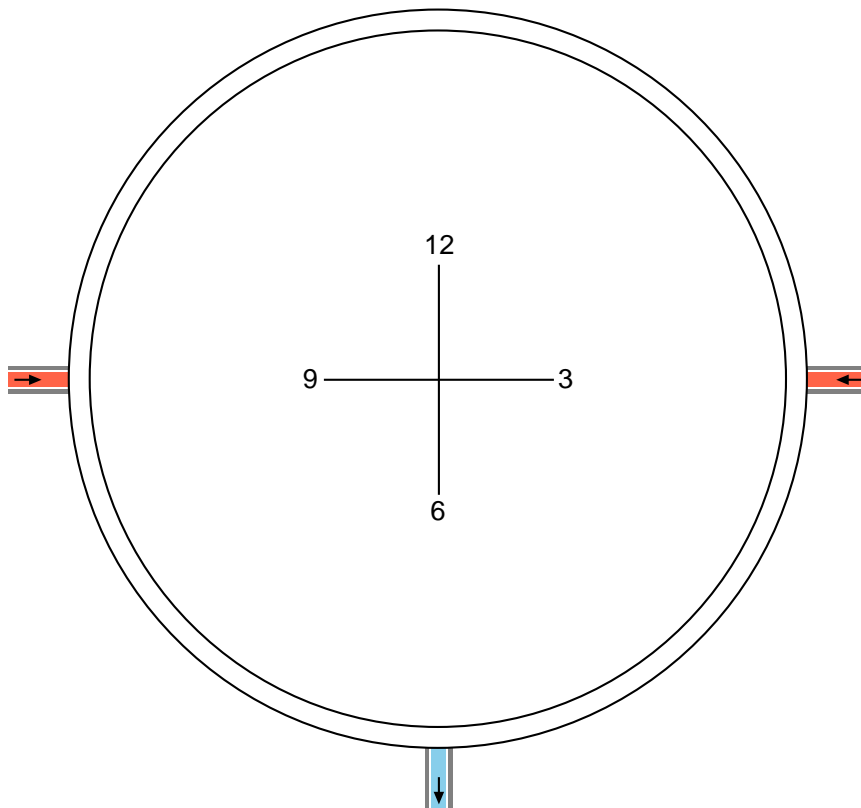
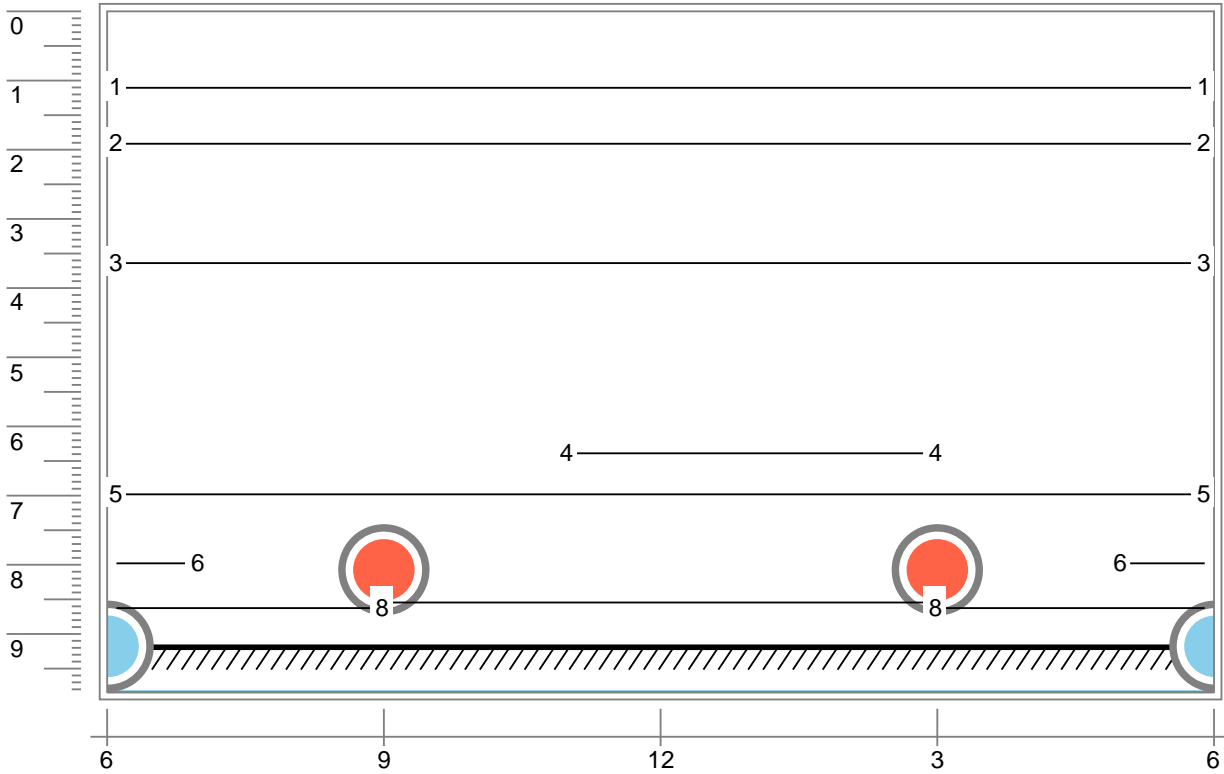



CleverScan - 8/9/2023 - 1819

Date 8/9/2023	Manhole Number 1819	City Georgetown	Street 600 South Fraser Street	Surveyed By Matthew Headrick
------------------	------------------------	--------------------	-----------------------------------	---------------------------------

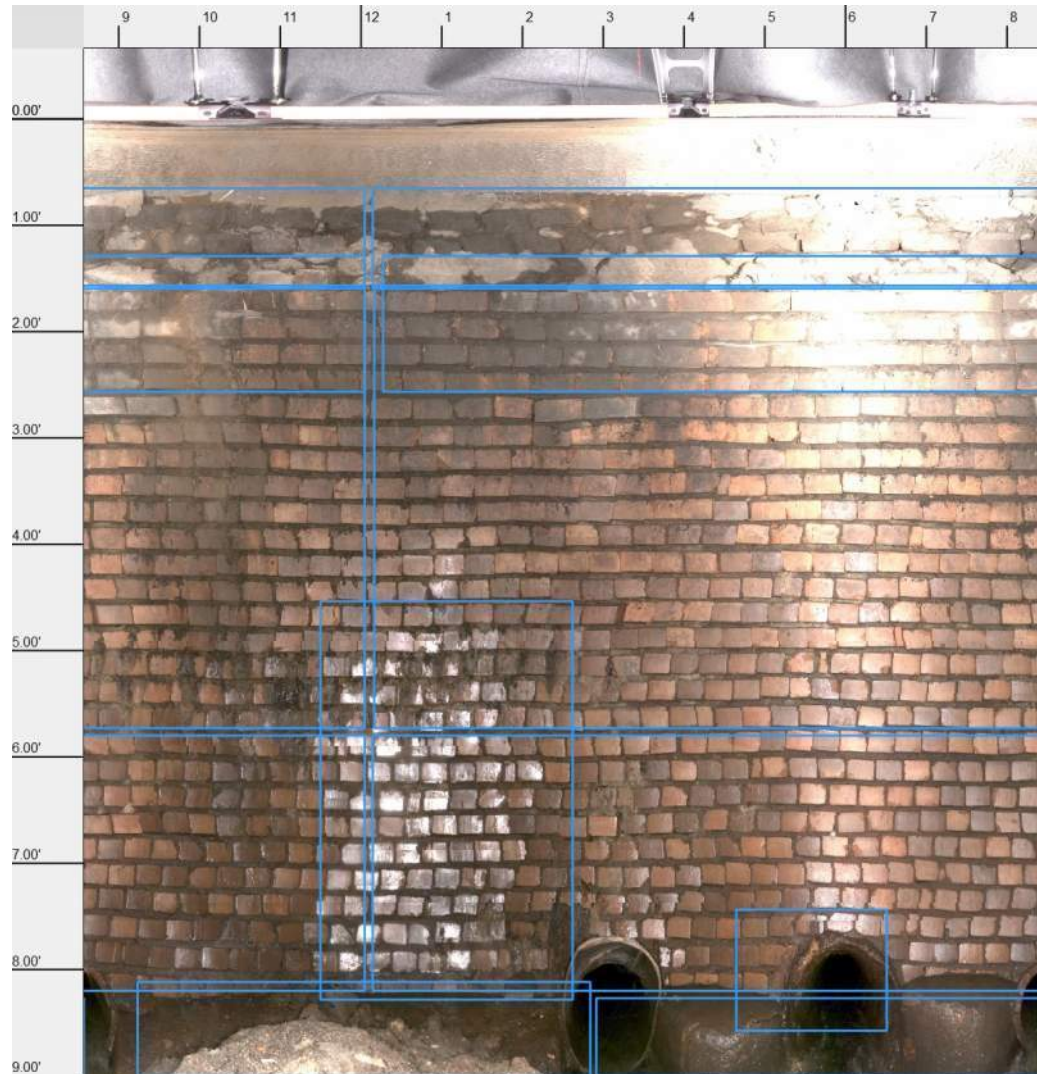



Node Inspection - 8/9/2023 - 1832

Date 8/9/2023	Time 12:02	Manhole Number 1832	Access Type Manhole	City Georgetown	Street 408 South Fraser
Surveyed By Matthew Headrick	Certificate Number U-0419-07030528	PO Number	Work Order	Pre-Cleaning No Pre-Cleaning	Sheet Number

General Manhole Information

MH Use Sanitary	Year Constructed	Year Renewed	Owner City of Georgetown
Rim to Invert 8.0'	Grade to Invert 8.0'	Rim to Grade 0.0'	Rim to Grade Exposed 0.3'
Surface Type Asphalt			
Location Code Light Highway	Location Details		
Additional component information			

General Manhole Inspection Information

Date Cleaned	Inspection Level Level 2	Consequence of Failure
Customer	Evidence Surcharge No	Purpose Routine assessment
Reviewed By Juan Bedoya	Reviewer Certificate U-1020-70400280	Weather Dry
Is Imperial No	Inspection Status Remote Inspection	Media Label WinCan 14.0
Potential for RunOff None		

Cover

Cover Type Solid					
Cover Shape Circular	Cover Size 23.5"	Center Cover Size	Cover Width		
Cover Material Cast Iron	Hole Diameter	Hole Number 0			
Cover Frame fit Good	Cover Bearing Surface Diameter 23.0"	Cover Bearing Surface Width			
Cover Condition Sound					

Cover Insert

Cover Insert Type None	Insert Condition
----------------------------------	------------------

Frame

Frame Material Cast Iron	Frame Bearing Surface Width 0.5"	Frame Bearing Surface Depth 1.0"
Frame Seal Inflow None	Frame Clear Open Diameter 22.0"	Frame Clear Open Width
Frame Depth 7.5"	Frame Offset Distance 0.0"	
Frame Condition Sound		
Seal Condition Sound		

Chimney

Chimney Present Yes	Chimney Material 1 Brick	Chimney Material 2
Chimney Clear Opening 22.5"	Chimney Depth 3.0'	Chimney Infiltration Infil Stained
Chimney Condition Sound	Chimney Lining Interior None	Chimney Lining Exterior Not Known

Cone

Cone Type Conical centered	Cone Material Brick	Cone Depth 6.9'
Cone Condition Sound	Cone Lining Interior None	Cone Lining Exterior Not Known

Wall

Wall Material Brick	Wall Diameter 46.4"	Wall By Size 46.4"	Wall Depth 7.3'
Wall Condition Sound	Wall Lining Exterior Not Known	Wall Lining Interior None	

Bench

Bench Condition Sound	Bench Present Yes	Bench Material Brick	Bench Lining None
---------------------------------	-----------------------------	--------------------------------	-----------------------------

QSR	QMR	QOR	SPR	MPR	OPR	SPRI	MPRI	OPRI
4331	2115	4331	19.0	7.0	26.0	2.4	1.2	1.9



Node Inspection - 8/9/2023 - 1832

Date 8/9/2023	Time 12:02	Manhole Number 1832	Access Type Manhole	City Georgetown	Street 408 South Fraser
Surveyed By Matthew Headrick	Certificate Number U-0419-07030528	PO Number	Work Order	Pre-Cleaning No Pre-Cleaning	Sheet Number

Channel

Channel Installed	Yes	Channel Material	Brick	Channel Type	Formed
Channel Condition	Sound	Channel Exposure	Fully Opened		

Observations

Nr.	Distance	MACP Code	Observation	Remark
1	1.8'	MML	Missing Mortar Large from 12 o'clock to 12 o'clock	Fully exposed bricks with gaps
2	2.8'	IS	Infiltration Stain from 11 o'clock to 5 o'clock, within 8 inch	inf stains from chimney
3	4.5'	MGO	Miscellaneous General Observation	old steps corroded
4	4.9'	MML	Missing Mortar Large from 12 o'clock to 12 o'clock	Fully exposed bricks with gaps
5	6.8'	MGO	Miscellaneous General Observation	plugged inlet
6	7.2'	MML	Missing Mortar Large from 12 o'clock to 12 o'clock	Fully exposed bricks with gaps
7	7.7'	MMM	Missing Mortar Medium from 12 o'clock to 12 o'clock	exposed bricks channel

Connections

Pipe Number	Rim To Invert	Direction	Clock Position	Shape	Material	Height	Width	Pipe Condition	Seal Condition	Pipe Type	Structure ID	Comments
1	8.0'	Out	6	Circular	Vitrified Clay Pipe	12"	-	Sound	Sound	Gravity Connection		
2	7.9'	In	9	Circular	Vitrified Clay Pipe	6"	-	Sound	Sound	Lateral to Building		
3	8.0'	In	12	Circular	Vitrified Clay Pipe	8"	-	Sound	Sound	Gravity Connection		
4	7.2'	In	3	Circular	Vitrified Clay Pipe	8"	-	Sound	Sound	Other		Capped

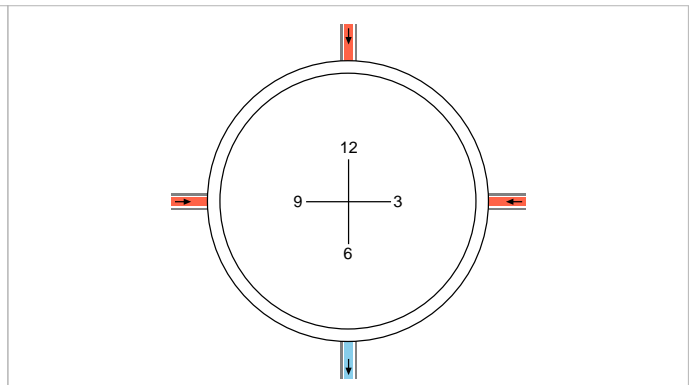
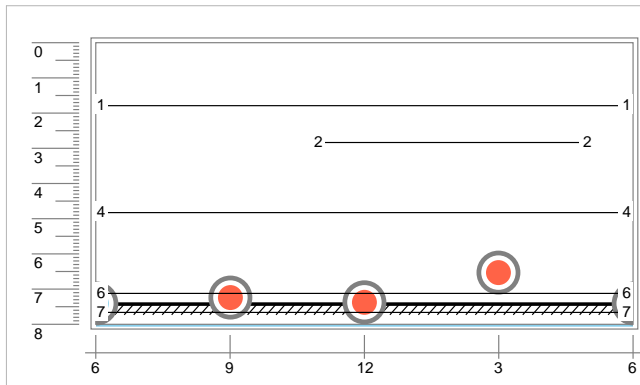

QSR	QMR	QOR	SPR	MPR	OPR	SPRI	MPRI	OPRI
4331	2115	4331	19.0	7.0	26.0	2.4	1.2	1.9



Node 2D Sketch - 8/9/2023 - 1832

Date 8/9/2023	Manhole Number 1832	City Georgetown	Street 408 South Fraser Street	Surveyed By Matthew Headrick
------------------	------------------------	--------------------	-----------------------------------	---------------------------------

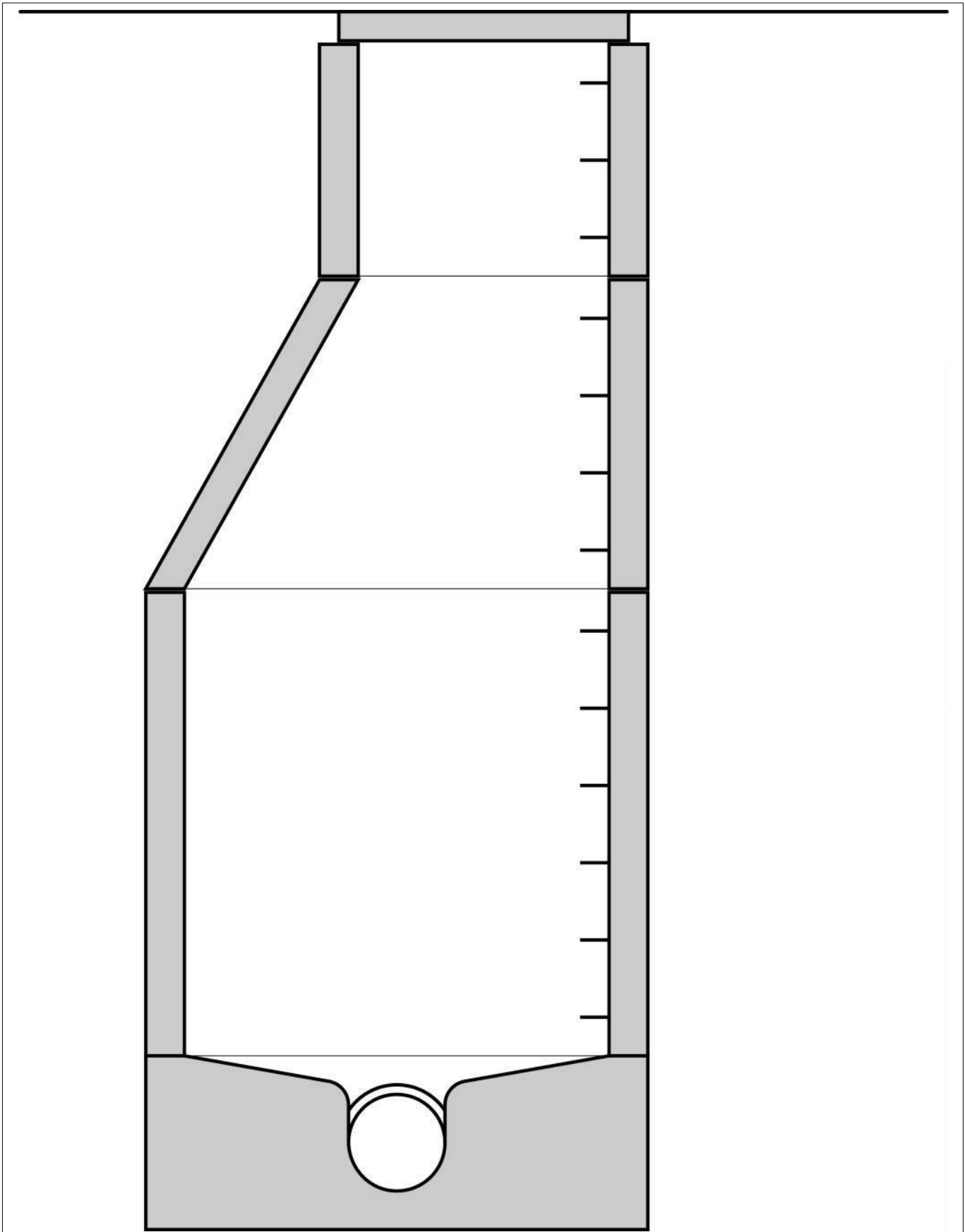



Node Pictures - 8/9/2023 - 1832

Date 8/9/2023	Manhole Number 1832	City Georgetown	Street 408 South Fraser Street	Surveyed By Matthew Headrick
------------------	------------------------	--------------------	-----------------------------------	---------------------------------



1832_5c717e28-5342-43ea-a091-aed22e190ee5_3cf15600-ec26-4327-815b-692ad98783b9_P11.jpg,
00:00:00, 1.82
Missing Mortar Large from 12 o'clock to 12 o'clock



1832_5c717e28-5342-43ea-a091-aed22e190ee5_2baee998-b878-45fc-a1c0-24d43f548fb2_P11.jpg,
00:00:00, 2.84
Infiltration Stain from 11 o'clock to 5 o'clock, within 8 inch



Node Pictures - 8/9/2023 - 1832

Date 8/9/2023	Manhole Number 1832	City Georgetown	Street 408 South Fraser Street	Surveyed By Matthew Headrick
------------------	------------------------	--------------------	-----------------------------------	---------------------------------



1832_5c717e28-5342-43ea-a091-aed22e190ee5_2c709237-18b7-481c-b843-aaf7a60c70ee_P11.jpg, 4.52

Miscellaneous General Observation



1832_5c717e28-5342-43ea-a091-aed22e190ee5_ca2d7aa5-d2c8-43d0-95f6-b989466c98d8_P11.jpg, 00:00:00, 4.86

Missing Mortar Large from 12 o'clock to 12 o'clock



Node Pictures - 8/9/2023 - 1832

Date 8/9/2023	Manhole Number 1832	City Georgetown	Street 408 South Fraser Street	Surveyed By Matthew Headrick
------------------	------------------------	--------------------	-----------------------------------	---------------------------------



1832_5c717e28-5342-43ea-a091-aed22e190ee5_bb63e00e-7a3a-44b5-ad2a-8020162f9ced_P11.jpg,
00:00:00, 6.83
Miscellaneous General Observation



1832_5c717e28-5342-43ea-a091-aed22e190ee5_6c1efc1e-0984-40af-82c8-62d31a60d6ca_P11.jpg,
00:00:00, 7.15
Missing Mortar Large from 12 o'clock to 12 o'clock



Node Pictures - 8/9/2023 - 1832

Date 8/9/2023	Manhole Number 1832	City Georgetown	Street 408 South Fraser Street	Surveyed By Matthew Headrick
------------------	------------------------	--------------------	-----------------------------------	---------------------------------



1832_5c717e28-5342-43ea-a091-aed22e190ee5_5c9301a7-40d7-4e29-bed0-567614a4fd1c_P11.jpg,
00:00:00, 7.68
Missing Mortar Medium from 12 o'clock to 12 o'clock



Node Drawings - 8/9/2023 - 1832

Date 8/9/2023	Manhole Number 1832	City Georgetown	Street 408 South Fraser Street	Surveyed By Matthew Headrick
------------------	------------------------	--------------------	-----------------------------------	---------------------------------

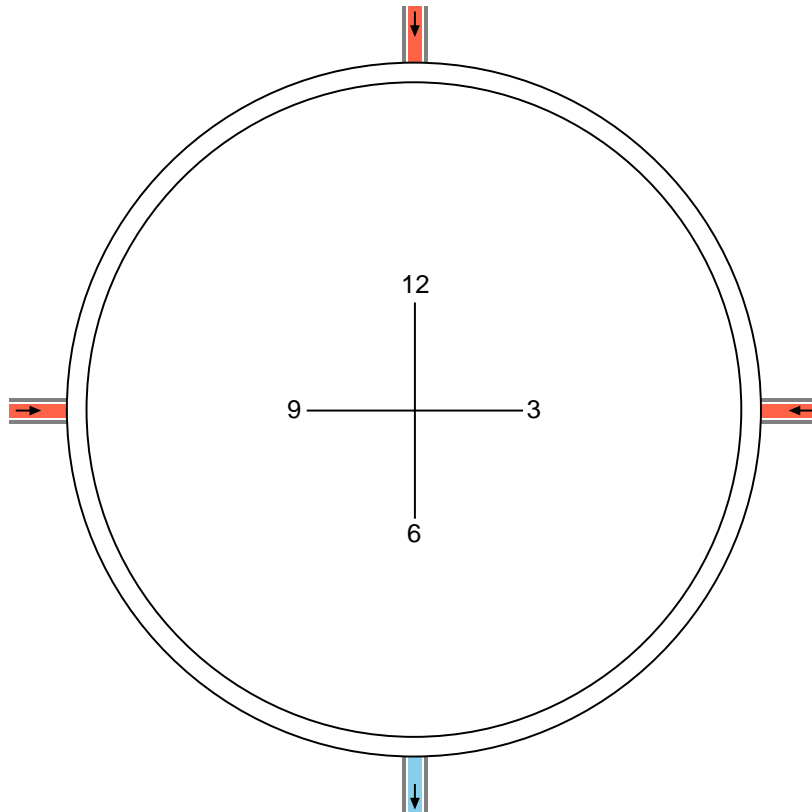
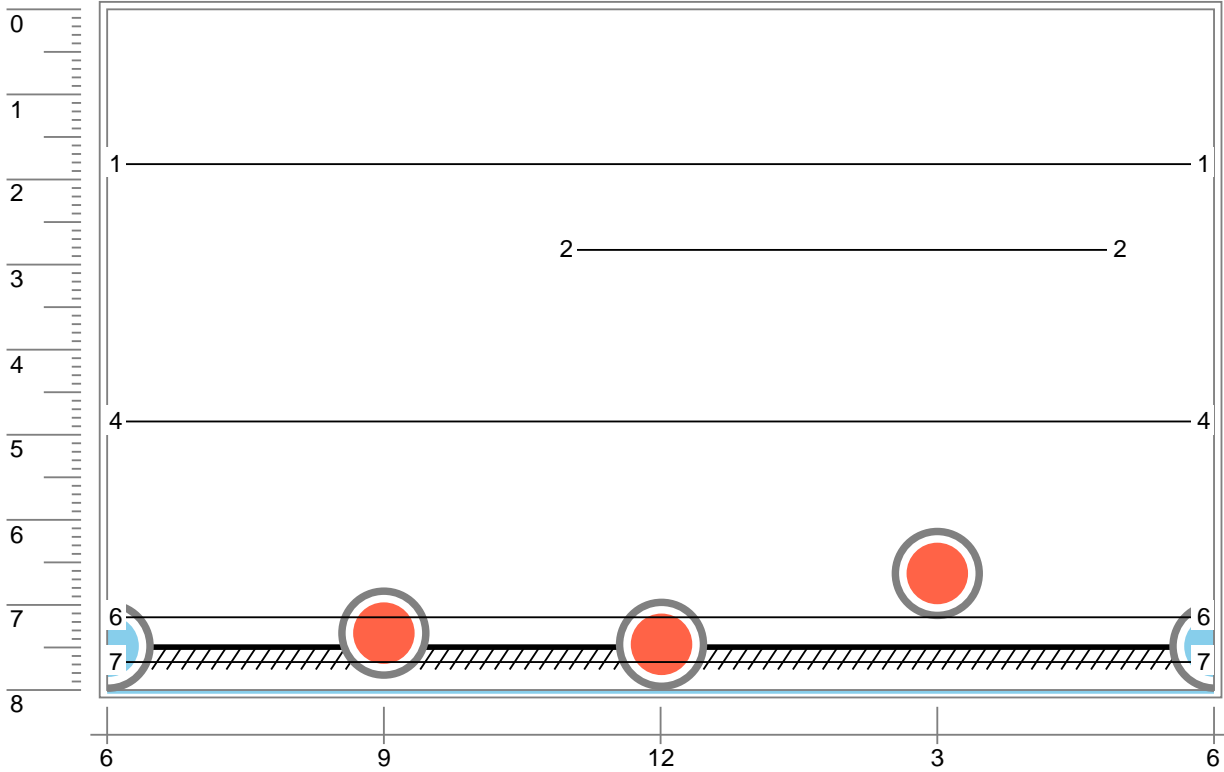



CleverScan - 8/9/2023 - 1832

Date 8/9/2023	Manhole Number 1832	City Georgetown	Street 408 South Fraser Street	Surveyed By Matthew Headrick
------------------	------------------------	--------------------	-----------------------------------	---------------------------------

