



DEPARTMENT OF THE ARMY
U.S. ARMY CORPS OF ENGINEERS, CHARLESTON DISTRICT
69A HAGOOD AVENUE
CHARLESTON, SC 29403-5107

October 20, 2022

Regulatory Division

Mr. Russell Cornette, Jr.
Town of Summerville
200 S. Main St.
Summerville, South Carolina 29483

Dear Mr. Cornette, Jr.:

This is in response to a Pre-Construction Notification (PCN) (SAC-2018-01003) received on March 4, 2022, and considered complete on March 4, 2022. In submitting the PCN, you requested verification the proposed project is authorized by a Department of the Army (DA) Nationwide Permit (NWP).

The work affecting waters of the United States is part of an overall project known as North Maple Street Widening and Improvements. The activities in waters of the United States include performing mechanized land-clearing, excavation, placing fill material, and replacing an existing culvert in waters of the U. S. The project involves impacts to not more than 0.31 acre of waters of the United States. Specifically, this letter authorizes impacts to 0.30 acre of wetlands for road widening and 134 linear feet and 0.006 acre of a tributary for replacement of an existing culvert. The Corps acknowledges that the applicant has completed mitigation requirements by providing proof of purchase of 3.13 wetland credits from the Caton Creek Mitigation Bank dated November 29, 2018. The project is located along North Maple Street in Summerville, Dorchester County, South Carolina (Latitude: 33.0314 °, Longitude: -80.1908 °). The PCN also includes the following supplemental information:

- a. Drawing sheets 1-15 of 15 titled "S-131 (North Maple Street) Widening Project" and dated May 29, 2018.
- b. A mitigation plan/statement titled "Appendix A-Mitigation Credit Purchase Certification" and dated November 29, 2018.
- c. A delineation of wetlands, other special aquatic sites, and other waters (SAC-2015-00517, verified by letter dated August 25, 2015, and SAC-2018-01003, verified by letter dated August 27, 2018).

Based on a review of the PCN, including the supplemental information indicated above, the Corps has determined the proposed activity will result in minimal individual and cumulative adverse environmental effects and is not contrary to the public interest.

Furthermore, the activity meets the terms and conditions of NWP 14 Linear Transportation Projects.

For this authorization to remain valid, the project must comply with the enclosed NWP General Conditions, Charleston District Regional Conditions, and the following special conditions:

- a. **That prior to beginning the authorized work the permittee must obtain and provide the Corps with a copy of all appropriate state certifications and/or authorizations (e.g., Coastal Zone Management Act concurrence, State Navigable Waters Permit, etc.). This PROVISIONAL NWP is NOT VALID until the permittee obtains and provides the requisite state certification(s) and/or authorization(s) in accordance with this special condition.**
- b. **That impacts to aquatic areas do not exceed those specified in the above mentioned PCN, including any supplemental information or revised permit drawings that were submitted to the Corps by the permittee.**
- c. **That the construction, use, and maintenance of the authorized activity is in accordance with the information given in the PCN, including the supplemental information listed above, and is subject to any conditions or restrictions imposed by this letter.**
- d. **That the permittee shall submit the attached signed compliance certification to the Corps within 30 days following completion of the authorized work.**
- e. **That the permittee shall use only clean fill material obtained from an upland source.**
- f. **That the permittee shall incorporate Best Management Practices (BMPs) during construction to protect adjacent wetlands and Waters of the United States from sediment and erosion during construction. BMPs to be utilized, independently or in combination, may include but are not limited to; erosion control matting, mulch, silt fences, sediment tubes, and other devices. BMPs shall be maintained until the fill material is stabilized.**

This verification is valid until March 14, 2026, unless the district engineer modifies, suspends, or revokes the NWP authorization in accordance with 33 CFR 330.5(d). If prior to this date, the NWP authorization is reissued without modification or the activity complies with any subsequent modification of the NWP authorization, the verification continues to remain valid until March 14, 2026. If you commence, or are under contract to commence this activity before the NWP expires, or the NWP is modified, suspended, or revoked by the Chief of Engineers or division engineer in accordance with 33 CFR

330.5(b) or (c), respectively, in such a way that the activity would no longer comply with the terms and conditions of the NWP, you will have 12 months after the date the NWP expires or is modified, suspended, or revoked, to complete the activity under the present terms and conditions of this NWP.

This NWP is verified based on information you provided. It is your responsibility to read the attached NWP(s) along with the General, Regional, and Special Conditions before you begin work. If you determine your project will not be able to meet the NWP and the conditions, you must contact the Corps before you proceed. Enclosed you will also find a copy of the Section 401 Water Quality Certification, which are conditions of your authorization under Nationwide Permit NWP 14 Linear Transportation Projects. If you have questions concerning compliance with the conditions of the 401 certification or Coastal Zone Management concurrence, you should contact the South Carolina Department of Health and Environmental Control (SCDHEC).

In all future correspondence, please refer to file number SAC-2018-01003. A copy of this letter is forwarded to State and/or Federal agencies for their information. If you have any questions, please contact Carl A.L. Johnson, Project Manager, at (803) 253-3904, or by email at Carl.A.Johnson@usace.army.mil.

Sincerely,



Chelsea B. Fannin
Team Lead

Attachments

- Permit Drawings
- NWP 14 Linear Transportation Projects
- Nationwide Permit General Conditions
- Nationwide Permit Regional Conditions
- 401 Water Quality Certification
- Compliance Certification Form

Copies Furnished:

Mr. Edward Smail
Michael Baker International
3820 Faber Place Drive Suite 100
North Charleston, South Carolina 29405
ESmail@mbakerintl.com

SC DHEC - Bureau of Water
2600 Bull Street
Columbia, South Carolina 29201
WQCWetlands@dhec.sc.gov

SC DHEC - OCRM
1362 McMillan Avenue, Suite 400
North Charleston, South Carolina 29405
OCRMPermitting@dhec.sc.gov

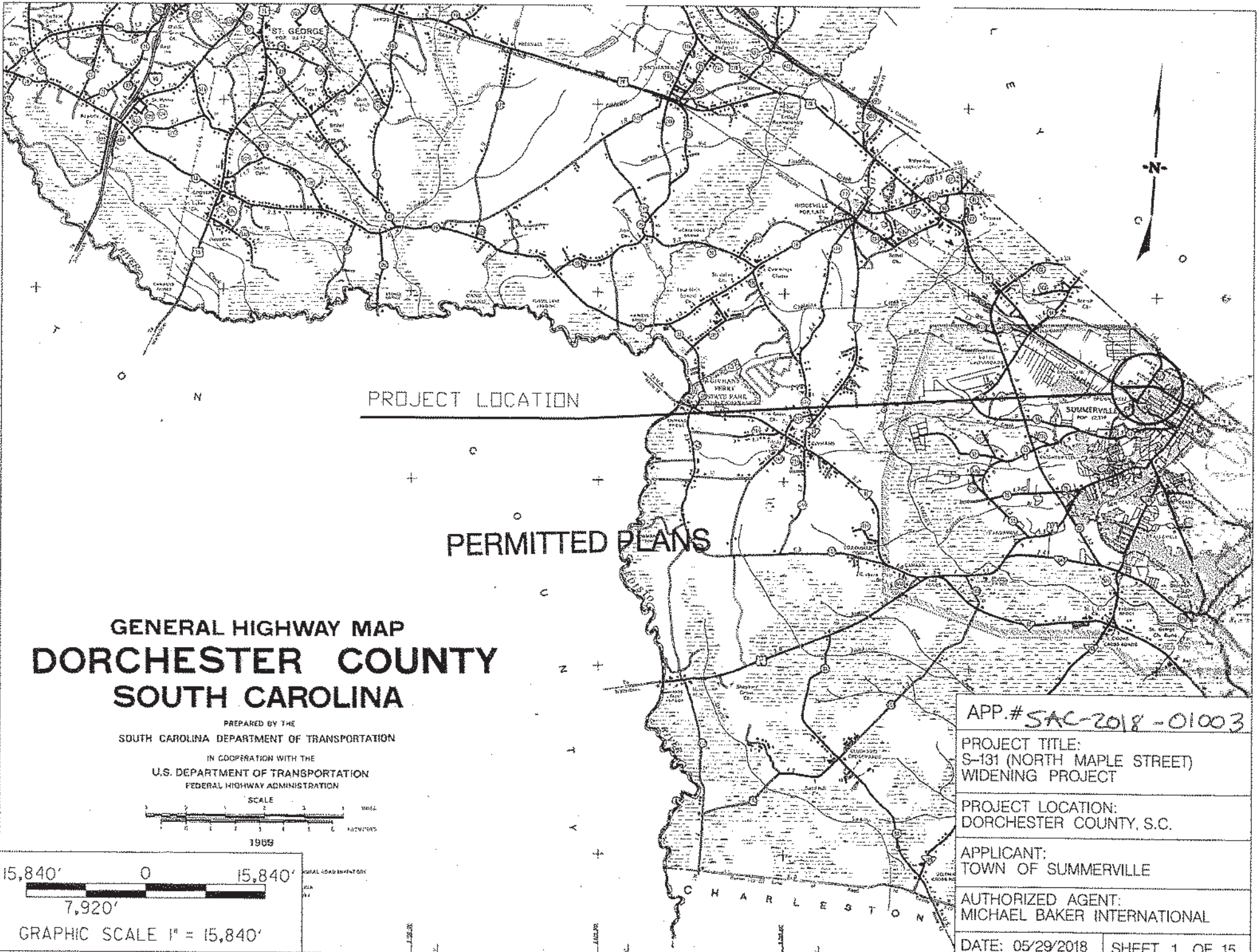

PROJECT LOCATION

PERMITTED PLANS

GENERAL HIGHWAY MAP DORCHESTER COUNTY SOUTH CAROLINA

PREPARED BY THE
SOUTH CAROLINA DEPARTMENT OF TRANSPORTATION
IN COOPERATION WITH THE
U.S. DEPARTMENT OF TRANSPORTATION
FEDERAL HIGHWAY ADMINISTRATION

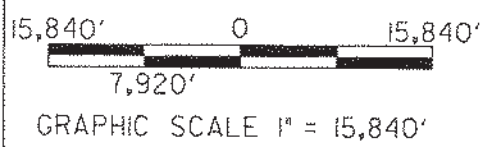
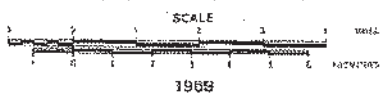

APP.# SAC-2018-01003	
PROJECT TITLE: S-131 (NORTH MAPLE STREET) WIDENING PROJECT	
PROJECT LOCATION: DORCHESTER COUNTY, S.C.	
APPLICANT: TOWN OF SUMMERVILLE	
AUTHORIZED AGENT: MICHAEL BAKER INTERNATIONAL	
DATE: 05/29/2018	SHEET 1 OF 15

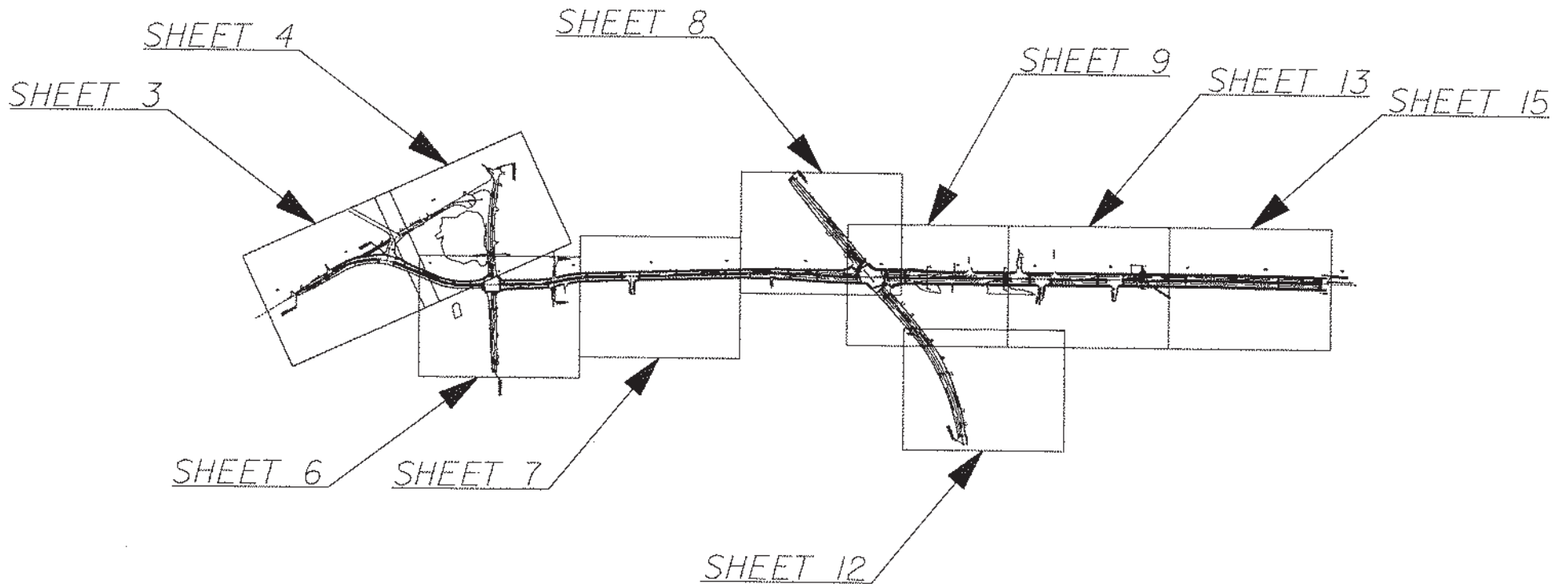

PERMITTED PLANS

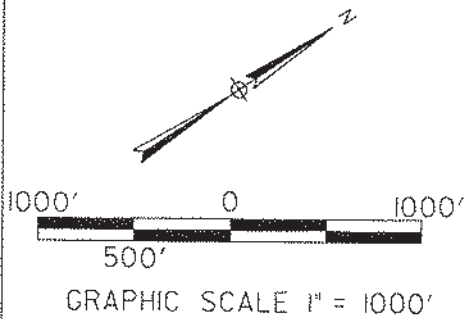

APP.# SAC-2018-01003	
PROJECT TITLE: S-131 (NORTH MAPLE STREET) WIDENING PROJECT	
PROJECT LOCATION: DORCHESTER COUNTY, S.C.	
APPLICANT: TOWN OF SUMMERVILLE	
AUTHORIZED AGENT: MICHAEL BAKER INTERNATIONAL	
DATE: 05/29/2018	SHEET 2 OF 15

NOTE: NO WETLAND IMPACTS THIS SHEET

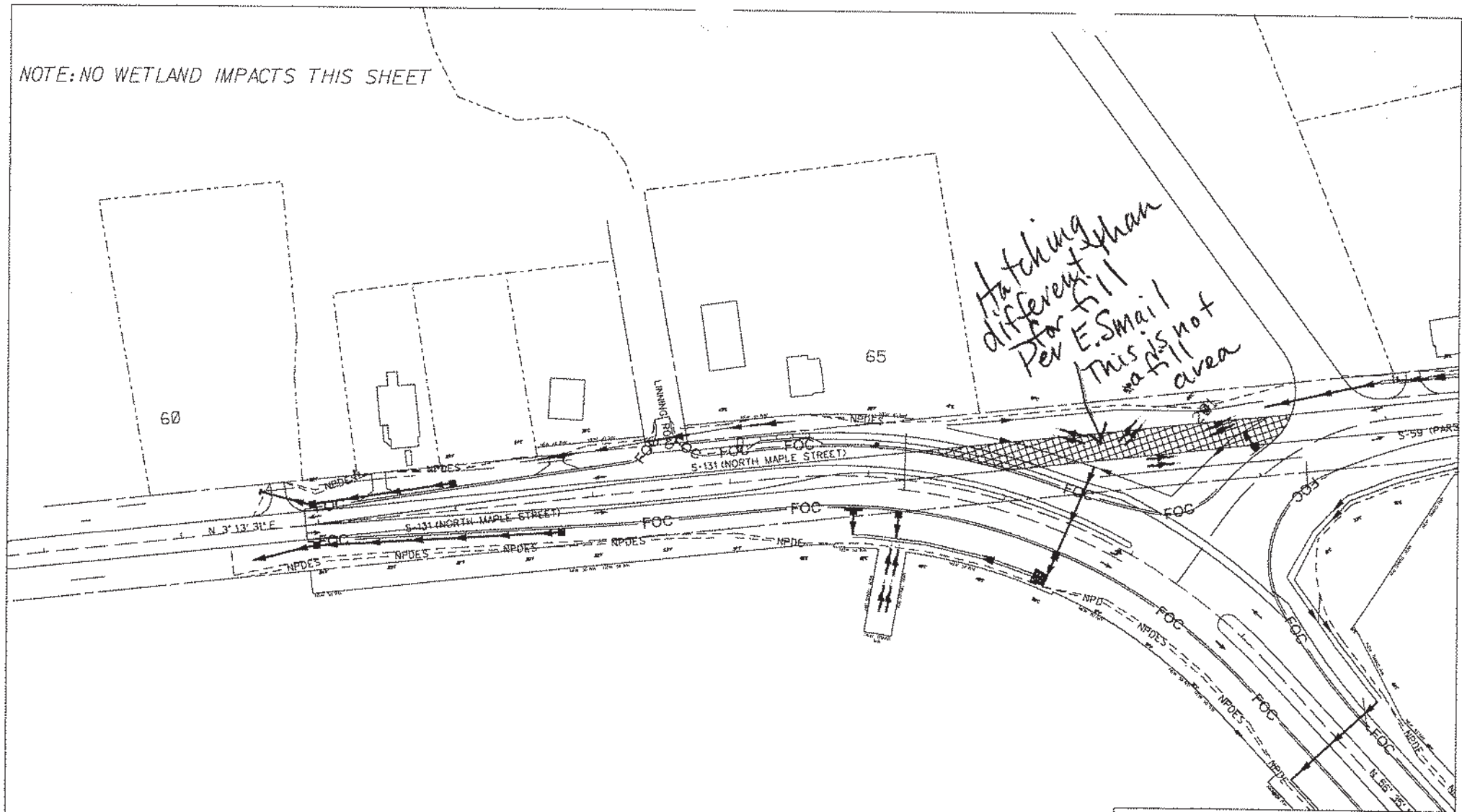

PERMITTED PLANS

APP.# SAC-2018-01003



PROJECT TITLE:
S-131 (NORTH MAPLE STREET)
WIDENING PROJECT

PROJECT LOCATION:
DORCHESTER COUNTY, S.C.

APPLICANT:
TOWN OF SUMMERVILLE

AUTHORIZED AGENT:
MICHAEL BAKER INTERNATIONAL

DATE: 05/29/2018 | SHEET 3 OF 15

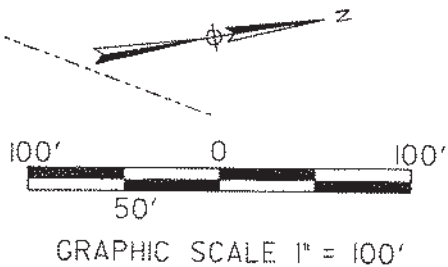

-  - DENOTES FILL IMPACTS
-  - DENOTES CLEAR IMPACTS
-  - DENOTES EXCAVATE IMPACTS

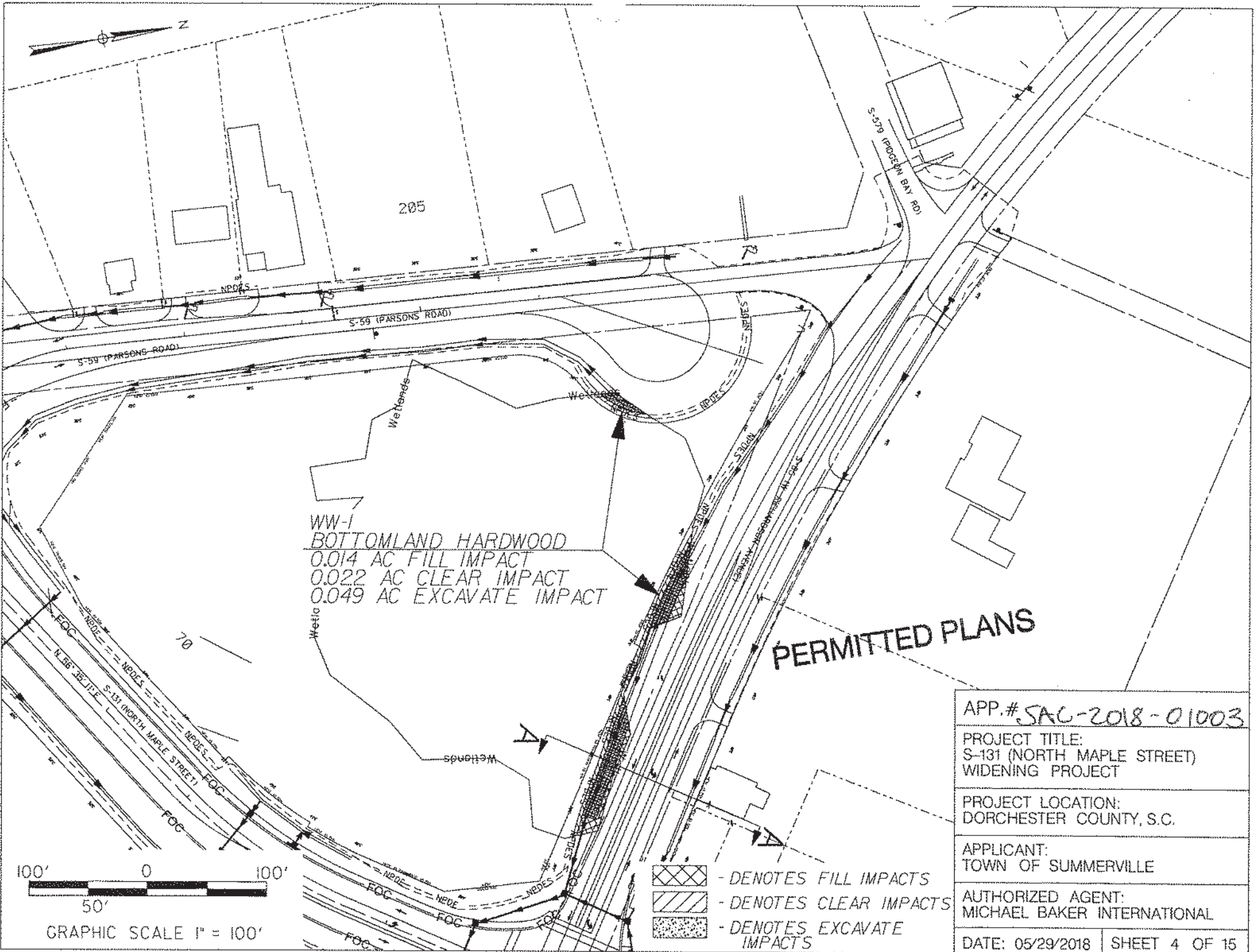



WW-1
 BOTTOMLAND HARDWOOD
 0.014 AC FILL IMPACT
 0.022 AC CLEAR IMPACT
 0.049 AC EXCAVATE IMPACT

PERMITTED PLANS

-  - DENOTES FILL IMPACTS
-  - DENOTES CLEAR IMPACTS
-  - DENOTES EXCAVATE IMPACTS

APP.# SAC-2018-01003

PROJECT TITLE:
 S-131 (NORTH MAPLE STREET)
 WIDENING PROJECT

PROJECT LOCATION:
 DORCHESTER COUNTY, S.C.

APPLICANT:
 TOWN OF SUMMERVILLE

AUTHORIZED AGENT:
 MICHAEL BAKER INTERNATIONAL

DATE: 05/29/2018 | SHEET 4 OF 15

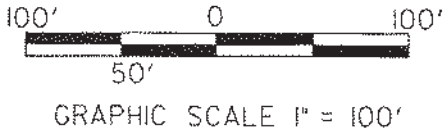

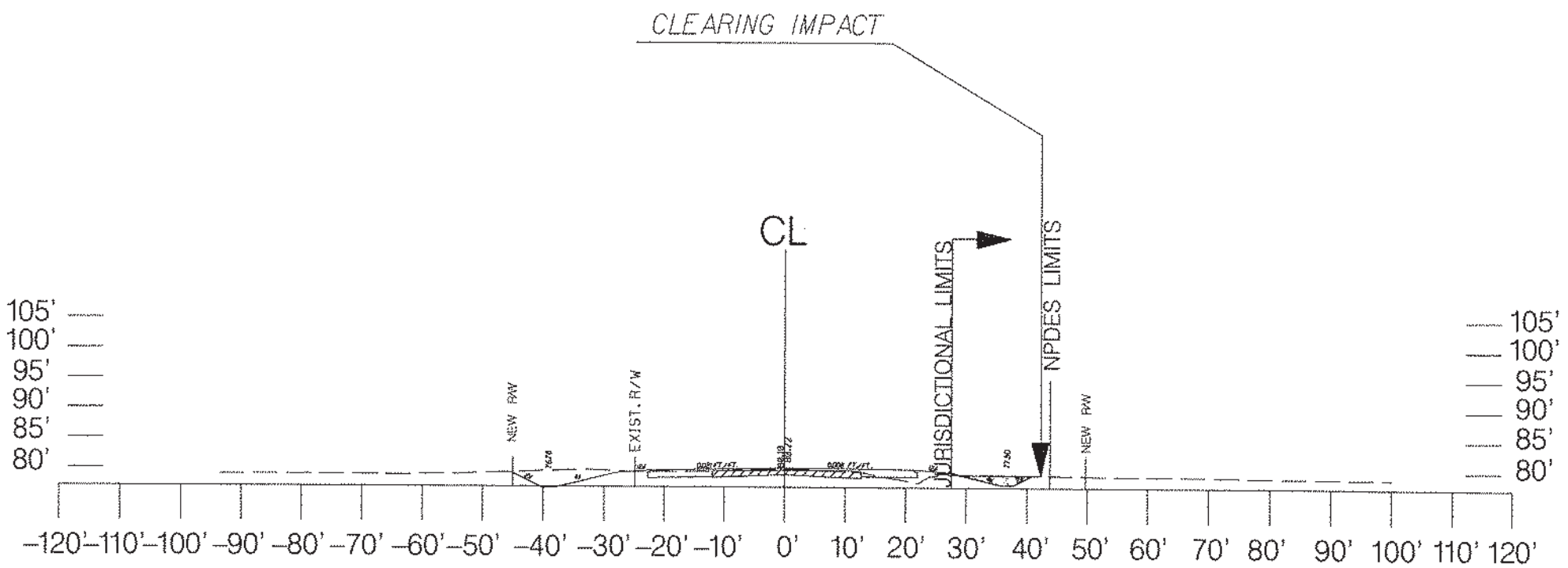

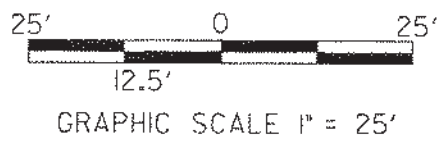

A - A
 STATION 309.00 + 00

PERMITTED PLANS



-  - DENOTES FILL IMPACTS
-  - DENOTES CLEAR IMPACTS
-  - DENOTES EXCAVATE IMPACTS

APP.# SAC-2018-01003	
PROJECT TITLE: S-131 (NORTH MAPLE STREET) WIDENING PROJECT	
PROJECT LOCATION: DORCHESTER COUNTY, S.C.	
APPLICANT: TOWN OF SUMMERVILLE	
AUTHORIZED AGENT: MICHAEL BAKER INTERNATIONAL	
DATE: 05/29/2018	SHEET 5 OF 15

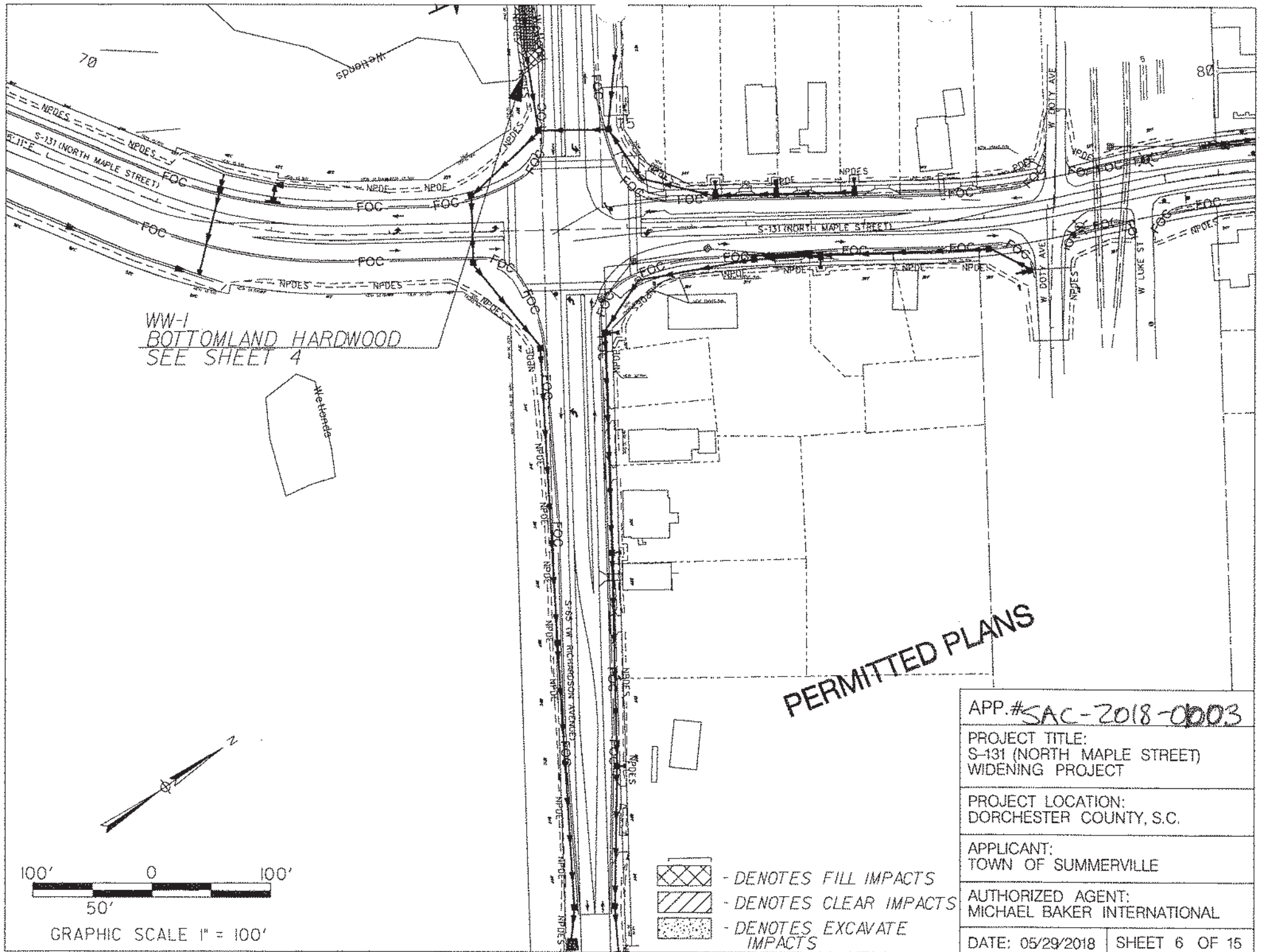

WW-1
 BOTTOMLAND HARDWOOD
 SEE SHEET 4

PERMITTED PLANS

APP.# SAC-2018-0003	
PROJECT TITLE: S-131 (NORTH MAPLE STREET) WIDENING PROJECT	
PROJECT LOCATION: DORCHESTER COUNTY, S.C.	
APPLICANT: TOWN OF SUMMERVILLE	
AUTHORIZED AGENT: MICHAEL BAKER INTERNATIONAL	
DATE: 05/29/2018	SHEET 6 OF 15

- DENOTES FILL IMPACTS
- DENOTES CLEAR IMPACTS
- DENOTES EXCAVATE IMPACTS

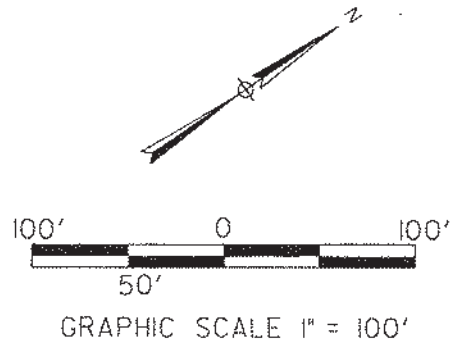

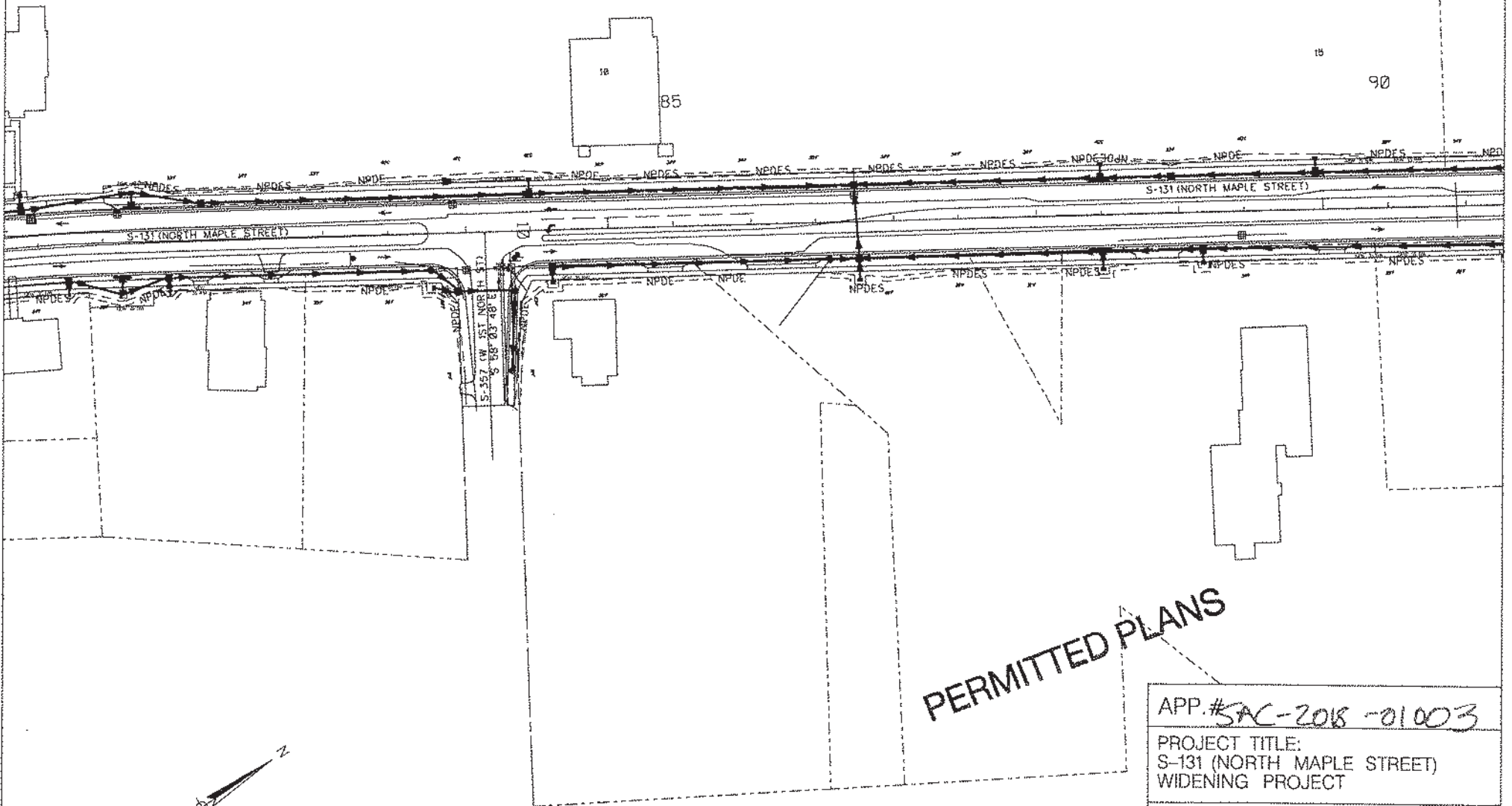

NOTE: NO WETLAND IMPACTS THIS SHEET

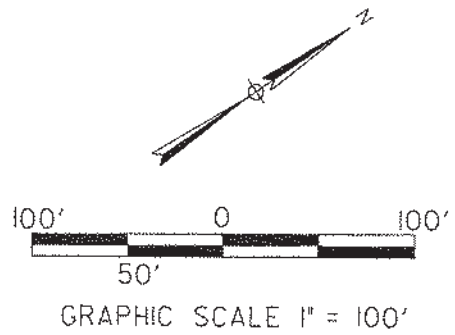

PERMITTED PLANS



-  - DENOTES FILL IMPACTS
-  - DENOTES CLEAR IMPACTS
-  - DENOTES EXCAVATE IMPACTS

APP. # SAC-2018-01003	
PROJECT TITLE: S-131 (NORTH MAPLE STREET) WIDENING PROJECT	
PROJECT LOCATION: DORCHESTER COUNTY, S.C.	
APPLICANT: TOWN OF SUMMERVILLE	
AUTHORIZED AGENT: MICHAEL BAKER INTERNATIONAL	
DATE: 05/29/2018	SHEET 7 OF 15

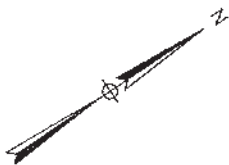

NOTE: NO WETLAND IMPACTS THIS SHEET

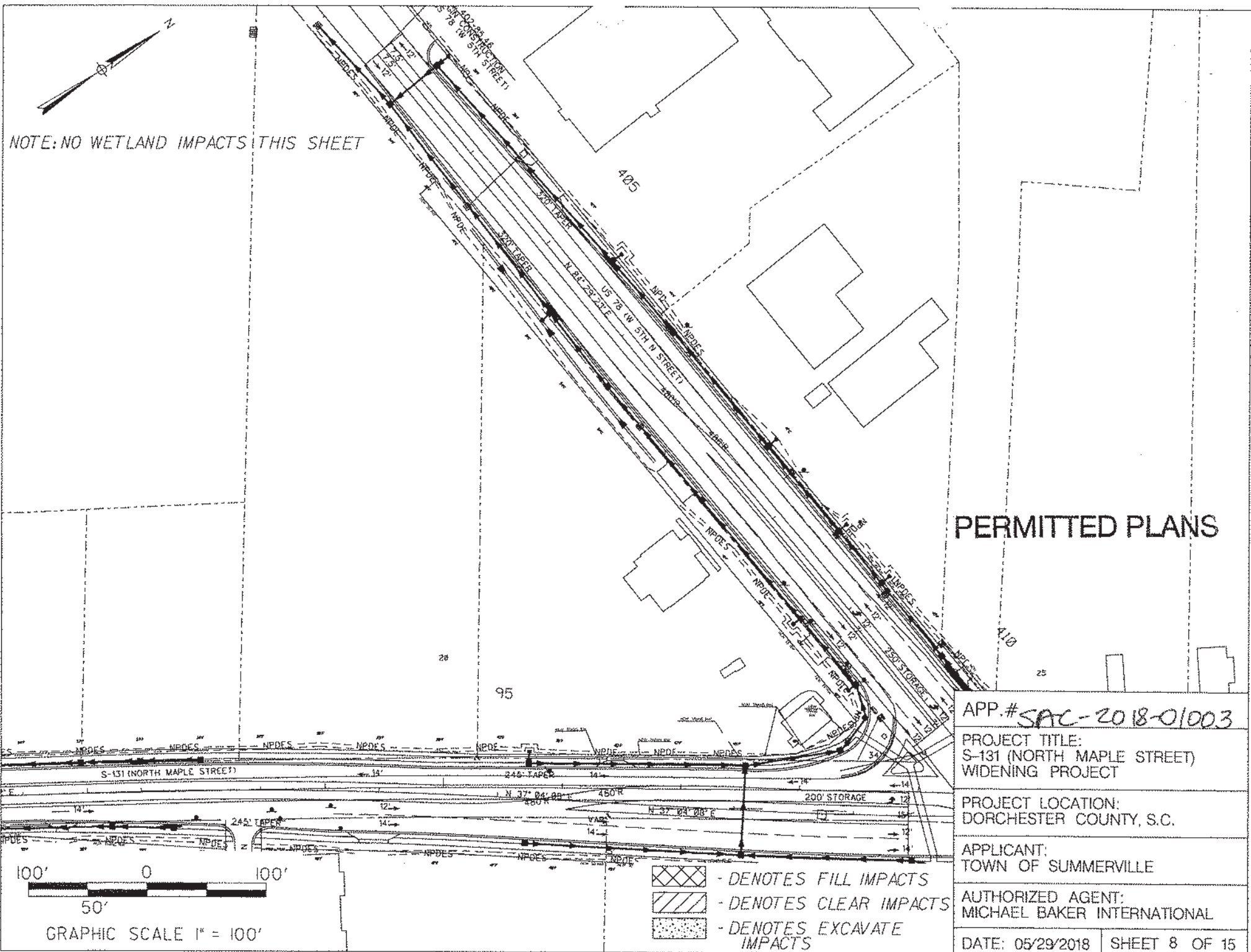

PERMITTED PLANS

APP.# SAC-2018-01003

PROJECT TITLE:
S-131 (NORTH MAPLE STREET)
WIDENING PROJECT

PROJECT LOCATION:
DORCHESTER COUNTY, S.C.



APPLICANT:
TOWN OF SUMMERVILLE

AUTHORIZED AGENT:
MICHAEL BAKER INTERNATIONAL

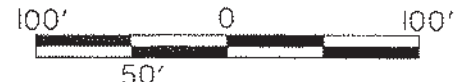
DATE: 05/29/2018 | SHEET 8 OF 15



GRAPHIC SCALE 1" = 100'

-  - DENOTES FILL IMPACTS
-  - DENOTES CLEAR IMPACTS
-  - DENOTES EXCAVATE IMPACTS

WA-3
 BOTTOMLAND HARDWOOD
 0.06 AC FILL IMPACT
 0.02 AC CLEAR IMPACT

WA-2
 BOTTOMLAND HARDWOOD
 0.09 AC FILL IMPACT
 0.02 AC CLEAR IMPACT
 (THIS SHEET)

PERMITTED PLANS

APP.# SAC-2018-01003

PROJECT TITLE:
 S-131 (NORTH MAPLE STREET)
 WIDENING PROJECT

PROJECT LOCATION:
 DORCHESTER COUNTY, S.C.



APPLICANT:
 TOWN OF SUMMERVILLE

AUTHORIZED AGENT:
 MICHAEL BAKER INTERNATIONAL

DATE: 05/29/2018 | SHEET 9 OF 15



GRAPHIC SCALE 1" = 100'

-  - DENOTES FILL IMPACTS
-  - DENOTES CLEAR IMPACTS
-  - DENOTES EXCAVATE IMPACTS

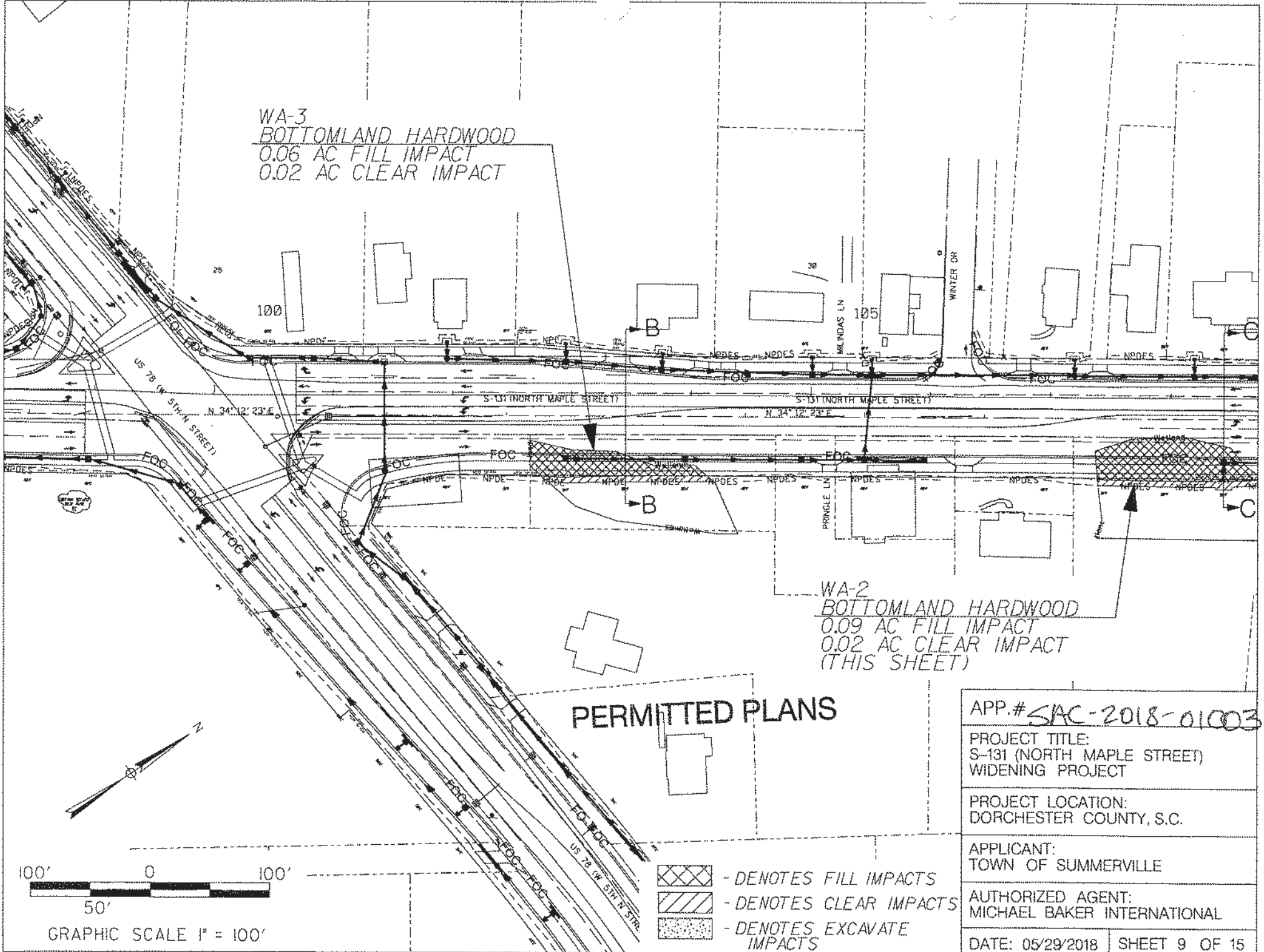

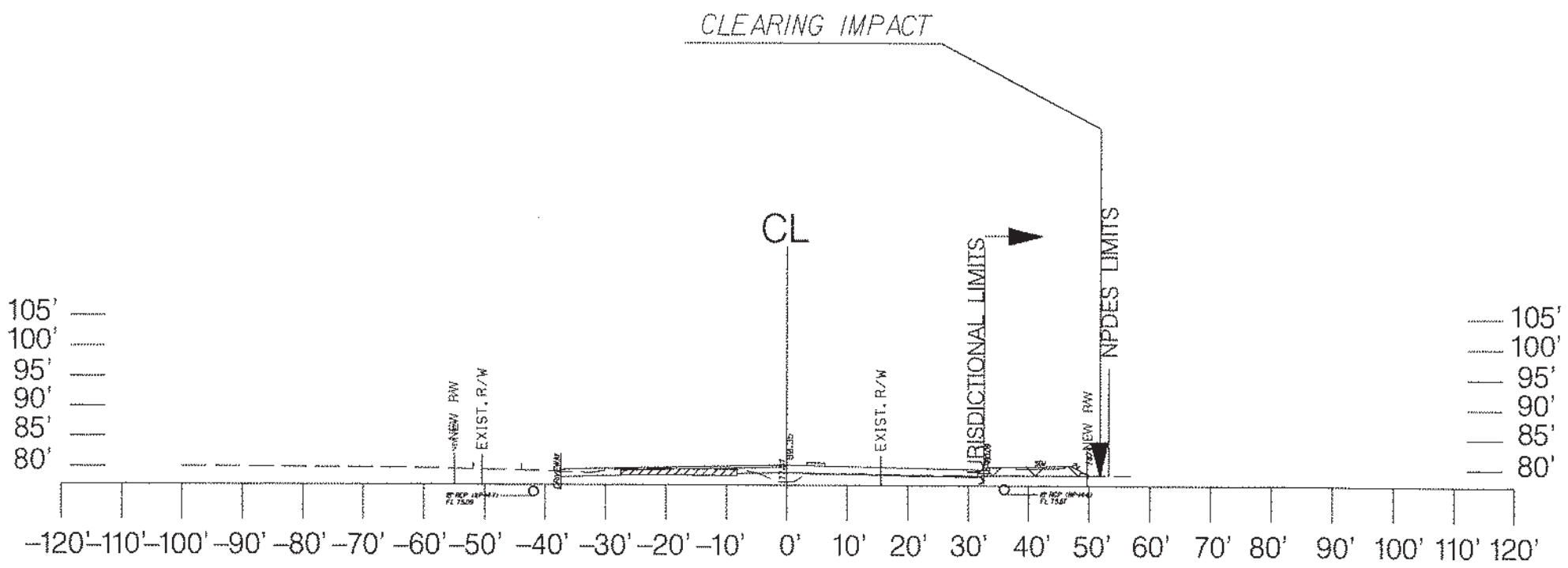

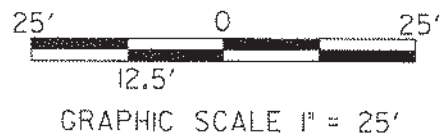

B - B
STATION 103.00 + 00

PERMITTED PLANS



-  - DENOTES FILL IMPACTS
-  - DENOTES CLEAR IMPACTS
-  - DENOTES EXCAVATE IMPACTS

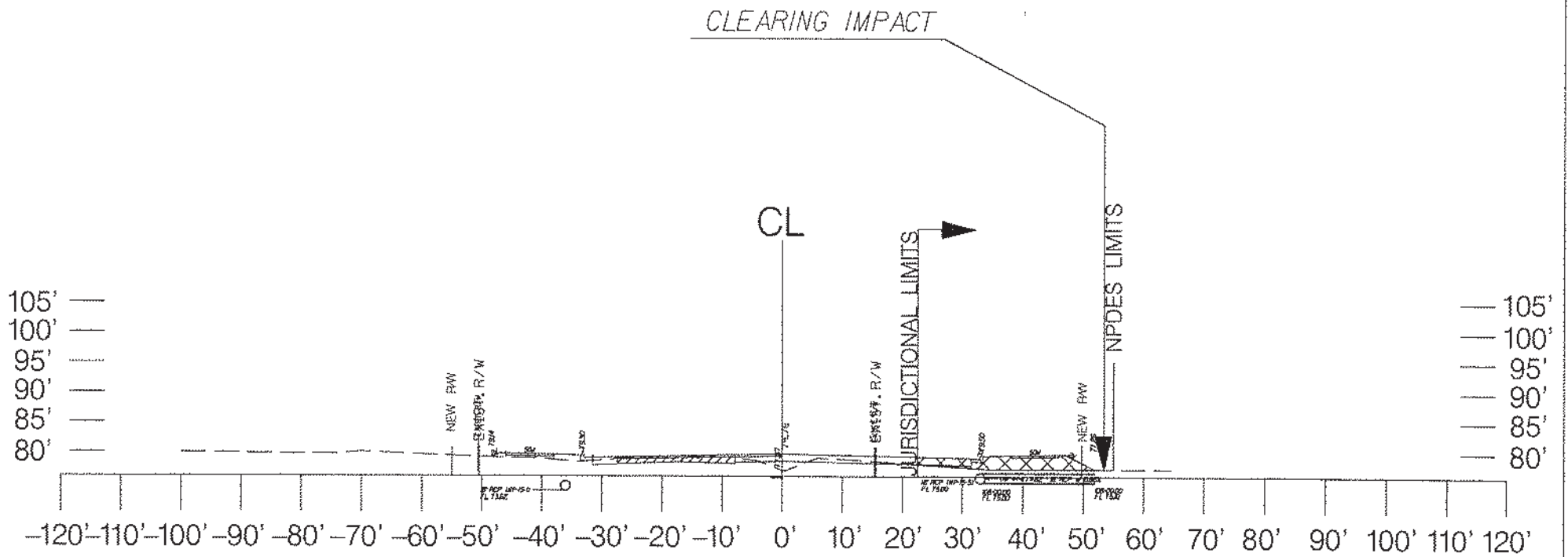

APP.# SAC-2018-01003	
PROJECT TITLE: S-131 (NORTH MAPLE STREET) WIDENING PROJECT	
PROJECT LOCATION: DORCHESTER COUNTY, S.C.	
APPLICANT: TOWN OF SUMMERVILLE	
AUTHORIZED AGENT: MICHAEL BAKER INTERNATIONAL	
DATE: 05/29/2018	SHEET 10 OF 15

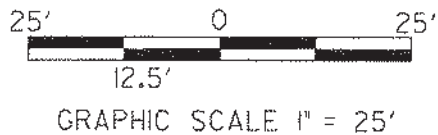

C - C
STATION 108.00 + 00

PERMITTED PLANS



-  - DENOTES FILL IMPACTS
-  - DENOTES CLEAR IMPACTS
-  - DENOTES EXCAVATE IMPACTS

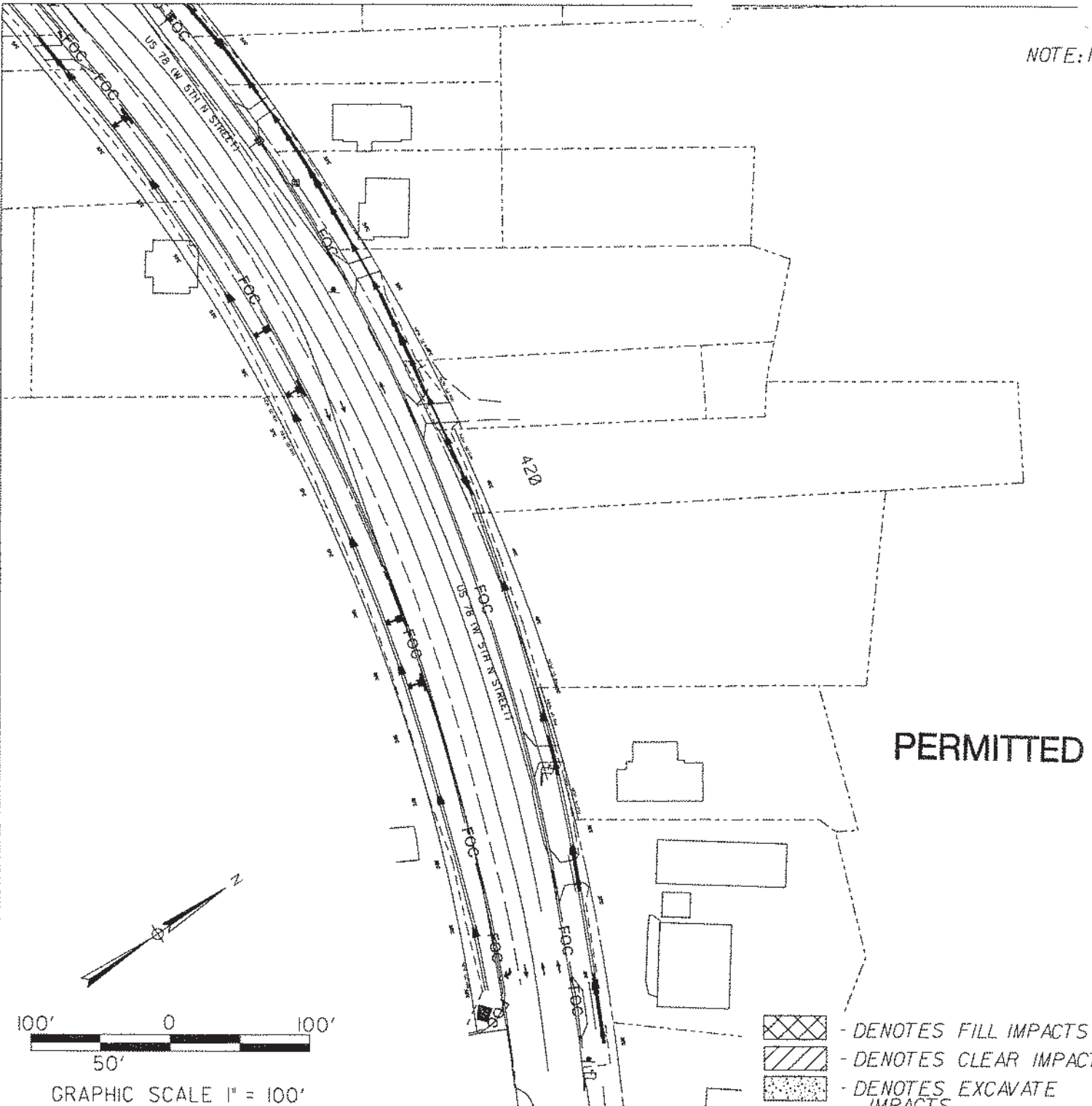

APP.# SAC-2018-01003	
PROJECT TITLE: S-131 (NORTH MAPLE STREET) WIDENING PROJECT	
PROJECT LOCATION: DORCHESTER COUNTY, S.C.	
APPLICANT: TOWN OF SUMMERVILLE	
AUTHORIZED AGENT: MICHAEL BAKER INTERNATIONAL	
DATE: 05/29/2018	SHEET 11 OF 15

NOTE: NO WETLAND IMPACTS THIS SHEET



PERMITTED PLANS

APP.# SAC-2018 D1003	
PROJECT TITLE: S-131 (NORTH MAPLE STREET) WIDENING PROJECT	
PROJECT LOCATION: DORCHESTER COUNTY, S.C.	
APPLICANT: TOWN OF SUMMERVILLE	
AUTHORIZED AGENT: MICHAEL BAKER INTERNATIONAL	
DATE: 05/29/2018	SHEET 12 OF 15

-  - DENOTES FILL IMPACTS
-  - DENOTES CLEAR IMPACTS
-  - DENOTES EXCAVATE IMPACTS

WA-1
 BOTTOMLAND HARDWOOD
 0.01 AC FILL IMPACT
 0.02 AC CLEAR IMPACT
 0.005 AC EXCAVATE IMPACT
 (THIS SHEET)

S-1
 PERENNIAL STREAM
 134.0 LF PIPE IMPACT

WA-2
 BOTTOMLAND HARDWOOD
 0.001 AC FILL IMPACT
 0.003 AC CLEAR IMPACT
 (THIS SHEET)

NORTH MAPLE STA 118+00.00 TO STA 128+00.00
 IS SHOWN AS PROVIDED IN CONSTRUCTION PLANS.
 NORTH MAPLE IS PLANNED TO BE OPEN TO CONSTRUCTION
 TOPO TO BE UPDATED AT THE AS-BUILT
 SURVEY DATA IS RECEIVED.

PERMITTED PLANS

APP. # SAC 2018-01003

PROJECT TITLE:
 S-131 (NORTH MAPLE STREET)
 WIDENING PROJECT

PROJECT LOCATION:
 DORCHESTER COUNTY, S.C.

APPLICANT:
 TOWN OF SUMMERVILLE

AUTHORIZED AGENT:
 MICHAEL BAKER INTERNATIONAL

DATE: 05/29/2018 | SHEET 13 OF 15

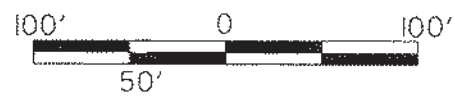
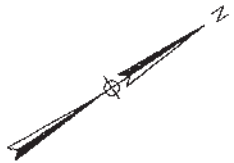
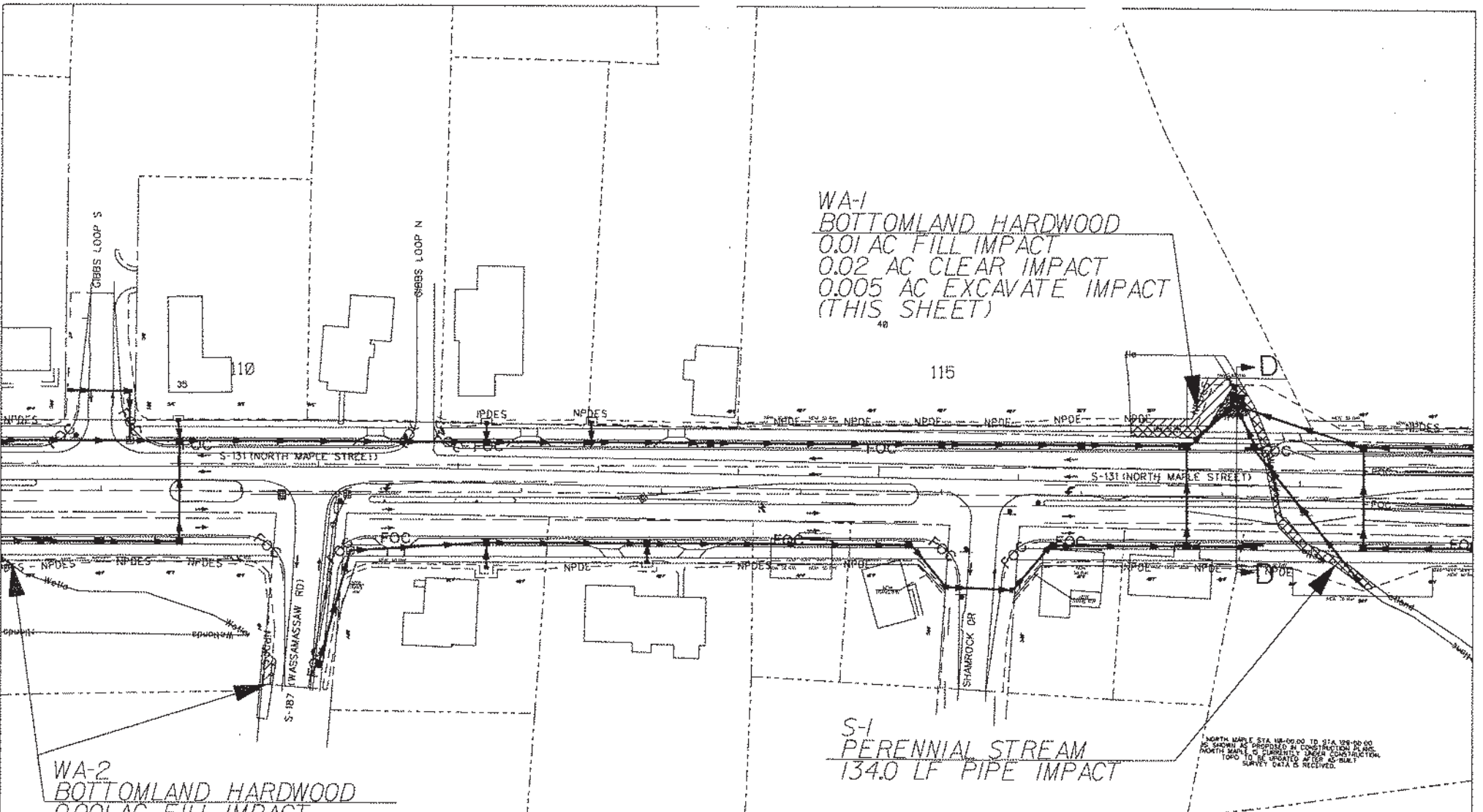

GRAPHIC SCALE 1" = 100'

- DENOTES FILL IMPACTS
- DENOTES CLEAR IMPACTS
- DENOTES EXCAVATE IMPACTS

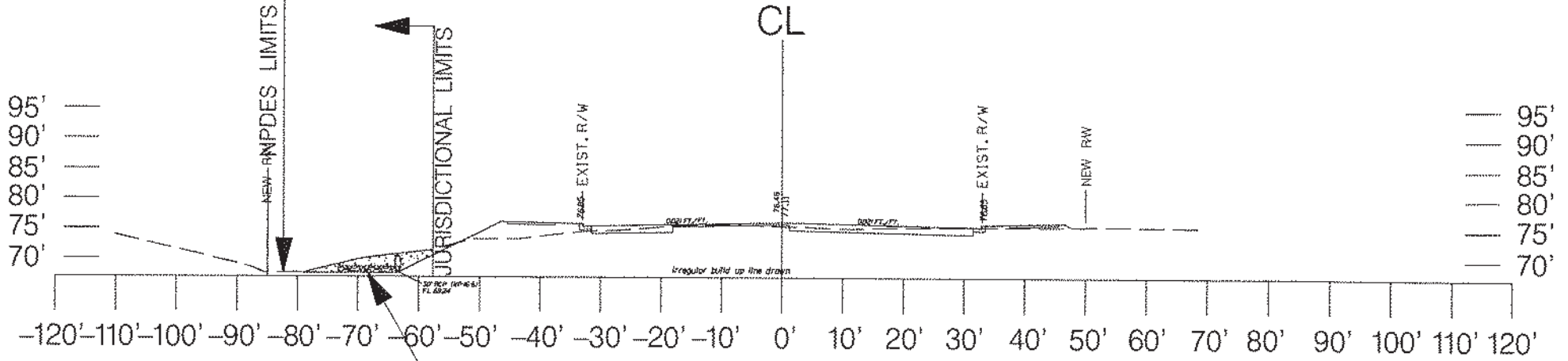

CLEARING IMPACT



D - D
STATION 117.00 + 10.00

RIPRAP PLACEMENT

PERMITTED PLANS

-  - DENOTES FILL IMPACTS
-  - DENOTES CLEAR IMPACTS
-  - DENOTES EXCAVATE IMPACTS

APP.# <i>SAC-2018-01003</i>	
PROJECT TITLE: S-131 (NORTH MAPLE STREET) WIDENING PROJECT	
PROJECT LOCATION: DORCHESTER COUNTY, S.C.	
APPLICANT: TOWN OF SUMMERVILLE	
AUTHORIZED AGENT: MICHAEL BAKER INTERNATIONAL	
DATE: 05/29/2018	SHEET 14 OF 15

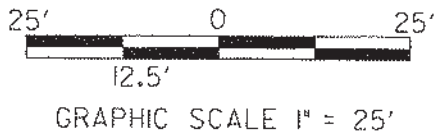

NOTE: NO WETLAND IMPACTS THIS SHEET

120

125

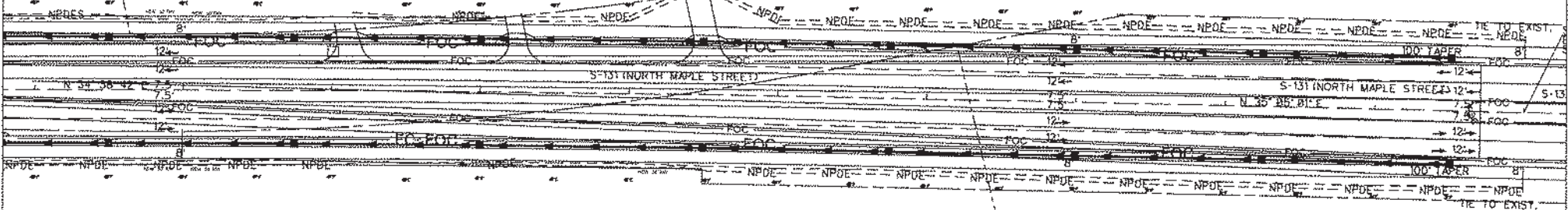



NORTH MAPLE STA. 120+00.00 TO STA. 125+00.00
 IS SHOWN AS PROPOSED BY CONSTRUCTION PLANS.
 NORTH MAPLE IS CLASSIFIED AS OPEN SPACE.
 THIS IS TO BE REVERTED AFTER 30-DAY
 SURVEY DATA IS RECEIVED.

NORTH MAPLE STA.
 IS SHOWN AS OPEN
 SPACE.
 THIS IS TO BE
 REVERTED AFTER
 30-DAY SURVEY.

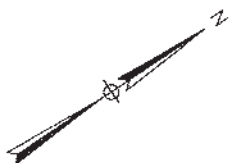
PERMITTED PLANS



GRAPHIC SCALE 1" = 100'

-  - DENOTES FILL IMPACTS
-  - DENOTES CLEAR IMPACTS
-  - DENOTES EXCAVATE IMPACTS

APP.# SAC-2018-01003	
PROJECT TITLE: S-131 (NORTH MAPLE STREET) WIDENING PROJECT	
PROJECT LOCATION: DORCHESTER COUNTY, S.C.	
APPLICANT: TOWN OF SUMMERVILLE	
AUTHORIZED AGENT: MICHAEL BAKER INTERNATIONAL	
DATE: 05/29/2018	SHEET 15 OF 15

14. Linear Transportation Projects. Activities required for crossings of waters of the United States associated with the construction, expansion, modification, or improvement of linear transportation projects (e.g., roads, highways, railways, trails, driveways, airport runways, and taxiways) in waters of the United States. For linear transportation projects in non-tidal waters, the discharge of dredged or fill material cannot cause the loss of greater than 1/2-acre of waters of the United States. For linear transportation projects in tidal waters, the discharge of dredged or fill material cannot cause the loss of greater than 1/3-acre of waters of the United States. Any stream channel modification, including bank stabilization, is limited to the minimum necessary to construct or protect the linear transportation project; such modifications must be in the immediate vicinity of the project.

This NWP also authorizes temporary structures, fills, and work, including the use of temporary mats, necessary to construct the linear transportation project. Appropriate measures must be taken to maintain normal downstream flows and minimize flooding to the maximum extent practicable, when temporary structures, work, and discharges of dredged or fill material, including cofferdams, are necessary for construction activities, access fills, or dewatering of construction sites. Temporary fills must consist of materials, and be placed in a manner, that will not be eroded by expected high flows. Temporary fills must be removed in their entirety and the affected areas returned to pre-construction elevations. The areas affected by temporary fills must be revegetated, as appropriate.

This NWP cannot be used to authorize non-linear features commonly associated with transportation projects, such as vehicle maintenance or storage buildings, parking lots, train stations, or aircraft hangars.

Notification: The permittee must submit a pre-construction notification to the district engineer prior to commencing the activity if: (1) the loss of waters of the United States exceeds 1/10-acre; or (2) there is a discharge of dredged or fill material in a special aquatic site, including wetlands. (See general condition 32.) (Authorities: Sections 10 and 404)

Note 1: For linear transportation projects crossing a single waterbody more than one time at separate and distant locations, or multiple waterbodies at separate and distant locations, each crossing is considered a single and complete project for purposes of NWP authorization. Linear transportation projects must comply with 33 CFR 330.6(d).

Note 2: Some discharges of dredged or fill material for the construction of farm roads or forest roads, or temporary roads for moving mining equipment, may qualify for an exemption under Section 404(f) of the Clean Water Act (see 33 CFR 323.4).

Note 3: For NWP 14 activities that require pre-construction notification, the PCN must include any other NWP(s), regional general permit(s), or individual permit(s) used or intended to be used to authorize any part of the proposed project or any related activity, including other separate and distant crossings that require Department of the Army

authorization but do not require pre-construction notification (see paragraph (b)(4) of general condition 32). The district engineer will evaluate the PCN in accordance with Section D, "District Engineer's Decision." The district engineer may require mitigation to ensure that the authorized activity results in no more than minimal individual and cumulative adverse environmental effects (see general condition 23).

Nationwide Permit General Conditions

Note: To qualify for NWP authorization, the prospective permittee must comply with the following general conditions, as applicable, in addition to any regional or case-specific conditions imposed by the division engineer or district engineer. Prospective permittees should contact the appropriate Corps district office to determine if regional conditions have been imposed on an NWP. Prospective permittees should also contact the appropriate Corps district office to determine the status of Clean Water Act Section 401 water quality certification and/or Coastal Zone Management Act consistency for an NWP. Every person who may wish to obtain permit authorization under one or more NWPs, or who is currently relying on an existing or prior permit authorization under one or more NWPs, has been and is on notice that all of the provisions of 33 CFR 330.1 through 330.6 apply to every NWP authorization. Note especially 33 CFR 330.5 relating to the modification, suspension, or revocation of any NWP authorization.

1. Navigation. (a) No activity may cause more than a minimal adverse effect on navigation.

(b) Any safety lights and signals prescribed by the U.S. Coast Guard, through regulations or otherwise, must be installed and maintained at the permittee's expense on authorized facilities in navigable waters of the United States.

(c) The permittee understands and agrees that, if future operations by the United States require the removal, relocation, or other alteration, of the structure or work herein authorized, or if, in the opinion of the Secretary of the Army or his or her authorized representative, said structure or work shall cause unreasonable obstruction to the free navigation of the navigable waters, the permittee will be required, upon due notice from the Corps of Engineers, to remove, relocate, or alter the structural work or obstructions caused thereby, without expense to the United States. No claim shall be made against the United States on account of any such removal or alteration.

2. Aquatic Life Movements. No activity may substantially disrupt the necessary life cycle movements of those species of aquatic life indigenous to the waterbody, including those species that normally migrate through the area, unless the activity's primary purpose is to impound water. All permanent and temporary crossings of waterbodies shall be suitably culverted, bridged, or otherwise designed and constructed to maintain low flows to sustain the movement of those aquatic species. If a bottomless culvert cannot be used, then the crossing should be designed and constructed to minimize adverse effects to aquatic life movements.

3. Spawning Areas. Activities in spawning areas during spawning seasons must be avoided to the maximum extent practicable. Activities that result in the physical destruction (e.g., through excavation, fill, or downstream smothering by substantial turbidity) of an important spawning area are not authorized.

4. Migratory Bird Breeding Areas. Activities in waters of the United States that serve as breeding areas for migratory birds must be avoided to the maximum extent practicable.

5. Shellfish Beds. No activity may occur in areas of concentrated shellfish populations, unless the activity is directly related to a shellfish harvesting activity authorized by NWP 4 and 48, or is a shellfish seeding or habitat restoration activity authorized by NWP 27.

6. Suitable Material. No activity may use unsuitable material (e.g., trash, debris, car bodies, asphalt, etc.). Material used for construction or discharged must be free from toxic pollutants in toxic amounts (see section 307 of the Clean Water Act).

7. Water Supply Intakes. No activity may occur in the proximity of a public water supply intake, except where the activity is for the repair or improvement of public water supply intake structures or adjacent bank stabilization.

8. Adverse Effects From Impoundments. If the activity creates an impoundment of water, adverse effects to the aquatic system due to accelerating the passage of water, and/or restricting its flow must be minimized to the maximum extent practicable.

9. Management of Water Flows. To the maximum extent practicable, the pre-construction course, condition, capacity, and location of open waters must be maintained for each activity, including stream channelization, storm water management activities, and temporary and permanent road crossings, except as provided below. The activity must be constructed to withstand expected high flows. The activity must not restrict or impede the passage of normal or high flows, unless the primary purpose of the activity is to impound water or manage high flows. The activity may alter the pre-construction course, condition, capacity, and location of open waters if it benefits the aquatic environment (e.g., stream restoration or relocation activities).

10. Fills Within 100-Year Floodplains. The activity must comply with applicable FEMA-approved state or local floodplain management requirements.

11. Equipment. Heavy equipment working in wetlands or mudflats must be placed on mats, or other measures must be taken to minimize soil disturbance.

12. Soil Erosion and Sediment Controls. Appropriate soil erosion and sediment controls must be used and maintained in effective operating condition during construction, and all exposed soil and other fills, as well as any work below the ordinary high water mark or high tide line, must be permanently stabilized at the earliest practicable date. Permittees are encouraged to perform work within waters of the United States during periods of low-flow or no-flow, or during low tides.

13. Removal of Temporary Structures and Fills. Temporary structures must be removed, to the maximum extent practicable, after their use has been discontinued.

Temporary fills must be removed in their entirety and the affected areas returned to pre-construction elevations. The affected areas must be revegetated, as appropriate.

14. Proper Maintenance. Any authorized structure or fill shall be properly maintained, including maintenance to ensure public safety and compliance with applicable NWP general conditions, as well as any activity-specific conditions added by the district engineer to an NWP authorization.

15. Single and Complete Project. The activity must be a single and complete project. The same NWP cannot be used more than once for the same single and complete project.

16. Wild and Scenic Rivers. (a) No NWP activity may occur in a component of the National Wild and Scenic River System, or in a river officially designated by Congress as a “study river” for possible inclusion in the system while the river is in an official study status, unless the appropriate Federal agency with direct management responsibility for such river, has determined in writing that the proposed activity will not adversely affect the Wild and Scenic River designation or study status.

(b) If a proposed NWP activity will occur in a component of the National Wild and Scenic River System, or in a river officially designated by Congress as a “study river” for possible inclusion in the system while the river is in an official study status, the permittee must submit a pre-construction notification (see general condition 32). The district engineer will coordinate the PCN with the Federal agency with direct management responsibility for that river. Permittees shall not begin the NWP activity until notified by the district engineer that the Federal agency with direct management responsibility for that river has determined in writing that the proposed NWP activity will not adversely affect the Wild and Scenic River designation or study status.

(c) Information on Wild and Scenic Rivers may be obtained from the appropriate Federal land management agency responsible for the designated Wild and Scenic River or study river (e.g., National Park Service, U.S. Forest Service, Bureau of Land Management, U.S. Fish and Wildlife Service). Information on these rivers is also available at: <http://www.rivers.gov/>.

17. Tribal Rights. No activity or its operation may impair reserved tribal rights, including, but not limited to, reserved water rights and treaty fishing and hunting rights.

18. Endangered Species. (a) No activity is authorized under any NWP which is likely to directly or indirectly jeopardize the continued existence of a threatened or endangered species or a species proposed for such designation, as identified under the Federal Endangered Species Act (ESA), or which will directly or indirectly destroy or adversely modify designated critical habitat or critical habitat proposed for such designation. No activity is authorized under any NWP which “may affect” a listed species or critical habitat, unless ESA section 7 consultation addressing the consequences of the proposed activity on listed species or critical habitat has been completed. See 50 CFR

402.02 for the definition of “effects of the action” for the purposes of ESA section 7 consultation, as well as 50 CFR 402.17, which provides further explanation under ESA section 7 regarding “activities that are reasonably certain to occur” and “consequences caused by the proposed action.”

(b) Federal agencies should follow their own procedures for complying with the requirements of the ESA (see 33 CFR 330.4(f)(1)). If pre-construction notification is required for the proposed activity, the Federal permittee must provide the district engineer with the appropriate documentation to demonstrate compliance with those requirements. The district engineer will verify that the appropriate documentation has been submitted. If the appropriate documentation has not been submitted, additional ESA section 7 consultation may be necessary for the activity and the respective federal agency would be responsible for fulfilling its obligation under section 7 of the ESA.

(c) Non-federal permittees must submit a pre-construction notification to the district engineer if any listed species (or species proposed for listing) or designated critical habitat (or critical habitat proposed such designation) might be affected or is in the vicinity of the activity, or if the activity is located in designated critical habitat or critical habitat proposed for such designation, and shall not begin work on the activity until notified by the district engineer that the requirements of the ESA have been satisfied and that the activity is authorized. For activities that might affect Federally-listed endangered or threatened species (or species proposed for listing) or designated critical habitat (or critical habitat proposed for such designation), the pre-construction notification must include the name(s) of the endangered or threatened species (or species proposed for listing) that might be affected by the proposed activity or that utilize the designated critical habitat (or critical habitat proposed for such designation) that might be affected by the proposed activity. The district engineer will determine whether the proposed activity “may affect” or will have “no effect” to listed species and designated critical habitat and will notify the non-Federal applicant of the Corps’ determination within 45 days of receipt of a complete pre-construction notification. For activities where the non-Federal applicant has identified listed species (or species proposed for listing) or designated critical habitat (or critical habitat proposed for such designation) that might be affected or is in the vicinity of the activity, and has so notified the Corps, the applicant shall not begin work until the Corps has provided notification that the proposed activity will have “no effect” on listed species (or species proposed for listing or designated critical habitat (or critical habitat proposed for such designation), or until ESA section 7 consultation or conference has been completed. If the non-Federal applicant has not heard back from the Corps within 45 days, the applicant must still wait for notification from the Corps.

(d) As a result of formal or informal consultation or conference with the FWS or NMFS the district engineer may add species-specific permit conditions to the NWP.

(e) Authorization of an activity by an NWP does not authorize the “take” of a threatened or endangered species as defined under the ESA. In the absence of separate authorization (e.g., an ESA Section 10 Permit, a Biological Opinion with “incidental take”

provisions, etc.) from the FWS or the NMFS, the Endangered Species Act prohibits any person subject to the jurisdiction of the United States to take a listed species, where "take" means to harass, harm, pursue, hunt, shoot, wound, kill, trap, capture, or collect, or to attempt to engage in any such conduct. The word "harm" in the definition of "take" means an act which actually kills or injures wildlife. Such an act may include significant habitat modification or degradation where it actually kills or injures wildlife by significantly impairing essential behavioral patterns, including breeding, feeding or sheltering.

(f) If the non-federal permittee has a valid ESA section 10(a)(1)(B) incidental take permit with an approved Habitat Conservation Plan for a project or a group of projects that includes the proposed NWP activity, the non-federal applicant should provide a copy of that ESA section 10(a)(1)(B) permit with the PCN required by paragraph (c) of this general condition. The district engineer will coordinate with the agency that issued the ESA section 10(a)(1)(B) permit to determine whether the proposed NWP activity and the associated incidental take were considered in the internal ESA section 7 consultation conducted for the ESA section 10(a)(1)(B) permit. If that coordination results in concurrence from the agency that the proposed NWP activity and the associated incidental take were considered in the internal ESA section 7 consultation for the ESA section 10(a)(1)(B) permit, the district engineer does not need to conduct a separate ESA section 7 consultation for the proposed NWP activity. The district engineer will notify the non-federal applicant within 45 days of receipt of a complete pre-construction notification whether the ESA section 10(a)(1)(B) permit covers the proposed NWP activity or whether additional ESA section 7 consultation is required.

(g) Information on the location of threatened and endangered species and their critical habitat can be obtained directly from the offices of the FWS and NMFS or their world wide web pages at <http://www.fws.gov/> or <http://www.fws.gov/ipac> and <http://www.nmfs.noaa.gov/pr/species/esa/> respectively.

19. Migratory Birds and Bald and Golden Eagles. The permittee is responsible for ensuring that an action authorized by an NWP complies with the Migratory Bird Treaty Act and the Bald and Golden Eagle Protection Act. The permittee is responsible for contacting the appropriate local office of the U.S. Fish and Wildlife Service to determine what measures, if any, are necessary or appropriate to reduce adverse effects to migratory birds or eagles, including whether "incidental take" permits are necessary and available under the Migratory Bird Treaty Act or Bald and Golden Eagle Protection Act for a particular activity.

20. Historic Properties. (a) No activity is authorized under any NWP which may have the potential to cause effects to properties listed, or eligible for listing, in the National Register of Historic Places until the requirements of Section 106 of the National Historic Preservation Act (NHPA) have been satisfied.

(b) Federal permittees should follow their own procedures for complying with the requirements of section 106 of the National Historic Preservation Act (see 33 CFR

330.4(g)(1)). If pre-construction notification is required for the proposed NWP activity, the Federal permittee must provide the district engineer with the appropriate documentation to demonstrate compliance with those requirements. The district engineer will verify that the appropriate documentation has been submitted. If the appropriate documentation is not submitted, then additional consultation under section 106 may be necessary. The respective federal agency is responsible for fulfilling its obligation to comply with section 106.

(c) Non-federal permittees must submit a pre-construction notification to the district engineer if the NWP activity might have the potential to cause effects to any historic properties listed on, determined to be eligible for listing on, or potentially eligible for listing on the National Register of Historic Places, including previously unidentified properties. For such activities, the pre-construction notification must state which historic properties might have the potential to be affected by the proposed NWP activity or include a vicinity map indicating the location of the historic properties or the potential for the presence of historic properties. Assistance regarding information on the location of, or potential for, the presence of historic properties can be sought from the State Historic Preservation Officer, Tribal Historic Preservation Officer, or designated tribal representative, as appropriate, and the National Register of Historic Places (see 33 CFR 330.4(g)). When reviewing pre-construction notifications, district engineers will comply with the current procedures for addressing the requirements of section 106 of the National Historic Preservation Act. The district engineer shall make a reasonable and good faith effort to carry out appropriate identification efforts commensurate with potential impacts, which may include background research, consultation, oral history interviews, sample field investigation, and/or field survey. Based on the information submitted in the PCN and these identification efforts, the district engineer shall determine whether the proposed NWP activity has the potential to cause effects on the historic properties. Section 106 consultation is not required when the district engineer determines that the activity does not have the potential to cause effects on historic properties (see 36 CFR 800.3(a)). Section 106 consultation is required when the district engineer determines that the activity has the potential to cause effects on historic properties. The district engineer will conduct consultation with consulting parties identified under 36 CFR 800.2(c) when he or she makes any of the following effect determinations for the purposes of section 106 of the NHPA: no historic properties affected, no adverse effect, or adverse effect.

(d) Where the non-Federal applicant has identified historic properties on which the proposed NWP activity might have the potential to cause effects and has so notified the Corps, the non-Federal applicant shall not begin the activity until notified by the district engineer either that the activity has no potential to cause effects to historic properties or that NHPA section 106 consultation has been completed. For non-federal permittees, the district engineer will notify the prospective permittee within 45 days of receipt of a complete pre-construction notification whether NHPA section 106 consultation is required. If NHPA section 106 consultation is required, the district engineer will notify the non-Federal applicant that he or she cannot begin the activity until section 106

consultation is completed. If the non-Federal applicant has not heard back from the Corps within 45 days, the applicant must still wait for notification from the Corps.

(e) Prospective permittees should be aware that section 110k of the NHPA (54 U.S.C. 306113) prevents the Corps from granting a permit or other assistance to an applicant who, with intent to avoid the requirements of section 106 of the NHPA, has intentionally significantly adversely affected a historic property to which the permit would relate, or having legal power to prevent it, allowed such significant adverse effect to occur, unless the Corps, after consultation with the Advisory Council on Historic Preservation (ACHP), determines that circumstances justify granting such assistance despite the adverse effect created or permitted by the applicant. If circumstances justify granting the assistance, the Corps is required to notify the ACHP and provide documentation specifying the circumstances, the degree of damage to the integrity of any historic properties affected, and proposed mitigation. This documentation must include any views obtained from the applicant, SHPO/THPO, appropriate Indian tribes if the undertaking occurs on or affects historic properties on tribal lands or affects properties of interest to those tribes, and other parties known to have a legitimate interest in the impacts to the permitted activity on historic properties.

21. Discovery of Previously Unknown Remains and Artifacts. Permittees that discover any previously unknown historic, cultural or archeological remains and artifacts while accomplishing the activity authorized by an NWP, they must immediately notify the district engineer of what they have found, and to the maximum extent practicable, avoid construction activities that may affect the remains and artifacts until the required coordination has been completed. The district engineer will initiate the Federal, Tribal, and state coordination required to determine if the items or remains warrant a recovery effort or if the site is eligible for listing in the National Register of Historic Places.

22. Designated Critical Resource Waters. Critical resource waters include, NOAA-managed marine sanctuaries and marine monuments, and National Estuarine Research Reserves. The district engineer may designate, after notice and opportunity for public comment, additional waters officially designated by a state as having particular environmental or ecological significance, such as outstanding national resource waters or state natural heritage sites. The district engineer may also designate additional critical resource waters after notice and opportunity for public comment.

(a) Discharges of dredged or fill material into waters of the United States are not authorized by NWPs 7, 12, 14, 16, 17, 21, 29, 31, 35, 39, 40, 42, 43, 44, 49, 50, 51, 52, 57 and 58 for any activity within, or directly affecting, critical resource waters, including wetlands adjacent to such waters.

(b) For NWPs 3, 8, 10, 13, 15, 18, 19, 22, 23, 25, 27, 28, 30, 33, 34, 36, 37, 38, and 54, notification is required in accordance with general condition 32, for any activity proposed by permittees in the designated critical resource waters including wetlands adjacent to those waters. The district engineer may authorize activities under these NWPs only

after she or he determines that the impacts to the critical resource waters will be no more than minimal.

23. Mitigation. The district engineer will consider the following factors when determining appropriate and practicable mitigation necessary to ensure that the individual and cumulative adverse environmental effects are no more than minimal:

(a) The activity must be designed and constructed to avoid and minimize adverse effects, both temporary and permanent, to waters of the United States to the maximum extent practicable at the project site (i.e., on site).

(b) Mitigation in all its forms (avoiding, minimizing, rectifying, reducing, or compensating for resource losses) will be required to the extent necessary to ensure that the individual and cumulative adverse environmental effects are no more than minimal.

(c) Compensatory mitigation at a minimum one-for-one ratio will be required for all wetland losses that exceed 1/10-acre and require pre-construction notification, unless the district engineer determines in writing that either some other form of mitigation would be more environmentally appropriate or the adverse environmental effects of the proposed activity are no more than minimal, and provides an activity-specific waiver of this requirement. For wetland losses of 1/10-acre or less that require pre-construction notification, the district engineer may determine on a case-by-case basis that compensatory mitigation is required to ensure that the activity results in only minimal adverse environmental effects.

(d) Compensatory mitigation at a minimum one-for-one ratio will be required for all losses of stream bed that exceed 3/100-acre and require pre-construction notification, unless the district engineer determines in writing that either some other form of mitigation would be more environmentally appropriate or the adverse environmental effects of the proposed activity are no more than minimal, and provides an activity-specific waiver of this requirement. This compensatory mitigation requirement may be satisfied through the restoration or enhancement of riparian areas next to streams in accordance with paragraph (e) of this general condition. For losses of stream bed of 3/100-acre or less that require pre-construction notification, the district engineer may determine on a case-by-case basis that compensatory mitigation is required to ensure that the activity results in only minimal adverse environmental effects. Compensatory mitigation for losses of streams should be provided, if practicable, through stream rehabilitation, enhancement, or preservation, since streams are difficult-to-replace resources (see 33 CFR 332.3(e)(3)).

(e) Compensatory mitigation plans for NWP activities in or near streams or other open waters will normally include a requirement for the restoration or enhancement, maintenance, and legal protection (e.g., conservation easements) of riparian areas next to open waters. In some cases, the restoration or maintenance/protection of riparian areas may be the only compensatory mitigation required. If restoring riparian areas involves planting vegetation, only native species should be planted. The width of the

required riparian area will address documented water quality or aquatic habitat loss concerns. Normally, the riparian area will be 25 to 50 feet wide on each side of the stream, but the district engineer may require slightly wider riparian areas to address documented water quality or habitat loss concerns. If it is not possible to restore or maintain/protect a riparian area on both sides of a stream, or if the waterbody is a lake or coastal waters, then restoring or maintaining/protecting a riparian area along a single bank or shoreline may be sufficient. Where both wetlands and open waters exist on the project site, the district engineer will determine the appropriate compensatory mitigation (e.g., riparian areas and/or wetlands compensation) based on what is best for the aquatic environment on a watershed basis. In cases where riparian areas are determined to be the most appropriate form of minimization or compensatory mitigation, the district engineer may waive or reduce the requirement to provide wetland compensatory mitigation for wetland losses.

(f) Compensatory mitigation projects provided to offset losses of aquatic resources must comply with the applicable provisions of 33 CFR part 332.

(1) The prospective permittee is responsible for proposing an appropriate compensatory mitigation option if compensatory mitigation is necessary to ensure that the activity results in no more than minimal adverse environmental effects. For the NWP, the preferred mechanism for providing compensatory mitigation is mitigation bank credits or in-lieu fee program credits (see 33 CFR 332.3(b)(2) and (3)). However, if an appropriate number and type of mitigation bank or in-lieu credits are not available at the time the PCN is submitted to the district engineer, the district engineer may approve the use of permittee-responsible mitigation.

(2) The amount of compensatory mitigation required by the district engineer must be sufficient to ensure that the authorized activity results in no more than minimal individual and cumulative adverse environmental effects (see 33 CFR 330.1(e)(3)). (See also 33 CFR 332.3(f).)

(3) Since the likelihood of success is greater and the impacts to potentially valuable uplands are reduced, aquatic resource restoration should be the first compensatory mitigation option considered for permittee-responsible mitigation.

(4) If permittee-responsible mitigation is the proposed option, the prospective permittee is responsible for submitting a mitigation plan. A conceptual or detailed mitigation plan may be used by the district engineer to make the decision on the NWP verification request, but a final mitigation plan that addresses the applicable requirements of 33 CFR 332.4(c)(2) through (14) must be approved by the district engineer before the permittee begins work in waters of the United States, unless the district engineer determines that prior approval of the final mitigation plan is not practicable or not necessary to ensure timely completion of the required compensatory mitigation (see 33 CFR 332.3(k)(3)). If permittee-responsible mitigation is the proposed option, and the proposed compensatory mitigation site is located on land in which another federal agency holds an easement, the district engineer will coordinate with that federal agency

to determine if proposed compensatory mitigation project is compatible with the terms of the easement.

(5) If mitigation bank or in-lieu fee program credits are the proposed option, the mitigation plan needs to address only the baseline conditions at the impact site and the number of credits to be provided (see 33 CFR 332.4(c)(1)(ii)).

(6) Compensatory mitigation requirements (e.g., resource type and amount to be provided as compensatory mitigation, site protection, ecological performance standards, monitoring requirements) may be addressed through conditions added to the NWP authorization, instead of components of a compensatory mitigation plan (see 33 CFR 332.4(c)(1)(ii)).

(g) Compensatory mitigation will not be used to increase the acreage losses allowed by the acreage limits of the NWPs. For example, if an NWP has an acreage limit of 1/2-acre, it cannot be used to authorize any NWP activity resulting in the loss of greater than 1/2-acre of waters of the United States, even if compensatory mitigation is provided that replaces or restores some of the lost waters. However, compensatory mitigation can and should be used, as necessary, to ensure that an NWP activity already meeting the established acreage limits also satisfies the no more than minimal impact requirement for the NWPs.

(h) Permittees may propose the use of mitigation banks, in-lieu fee programs, or permittee-responsible mitigation. When developing a compensatory mitigation proposal, the permittee must consider appropriate and practicable options consistent with the framework at 33 CFR 332.3(b). For activities resulting in the loss of marine or estuarine resources, permittee-responsible mitigation may be environmentally preferable if there are no mitigation banks or in-lieu fee programs in the area that have marine or estuarine credits available for sale or transfer to the permittee. For permittee-responsible mitigation, the special conditions of the NWP verification must clearly indicate the party or parties responsible for the implementation and performance of the compensatory mitigation project, and, if required, its long-term management.

(i) Where certain functions and services of waters of the United States are permanently adversely affected by a regulated activity, such as discharges of dredged or fill material into waters of the United States that will convert a forested or scrub-shrub wetland to a herbaceous wetland in a permanently maintained utility line right-of-way, mitigation may be required to reduce the adverse environmental effects of the activity to the no more than minimal level.

24. Safety of Impoundment Structures. To ensure that all impoundment structures are safely designed, the district engineer may require non-Federal applicants to demonstrate that the structures comply with established state or federal, dam safety criteria or have been designed by qualified persons. The district engineer may also require documentation that the design has been independently reviewed by similarly qualified persons, and appropriate modifications made to ensure safety.

25. Water Quality. (a) Where the certifying authority (state, authorized tribe, or EPA, as appropriate) has not previously certified compliance of an NWP with CWA section 401, a CWA section 401 water quality certification for the proposed discharge must be obtained or waived (see 33 CFR 330.4(c)). If the permittee cannot comply with all of the conditions of a water quality certification previously issued by certifying authority for the issuance of the NWP, then the permittee must obtain a water quality certification or waiver for the proposed discharge in order for the activity to be authorized by an NWP.

(b) If the NWP activity requires pre-construction notification and the certifying authority has not previously certified compliance of an NWP with CWA section 401, the proposed discharge is not authorized by an NWP until water quality certification is obtained or waived. If the certifying authority issues a water quality certification for the proposed discharge, the permittee must submit a copy of the certification to the district engineer. The discharge is not authorized by an NWP until the district engineer has notified the permittee that the water quality certification requirement has been satisfied by the issuance of a water quality certification or a waiver.

(c) The district engineer or certifying authority may require additional water quality management measures to ensure that the authorized activity does not result in more than minimal degradation of water quality.

26. Coastal Zone Management. In coastal states where an NWP has not previously received a state coastal zone management consistency concurrence, an individual state coastal zone management consistency concurrence must be obtained, or a presumption of concurrence must occur (see 33 CFR 330.4(d)). If the permittee cannot comply with all of the conditions of a coastal zone management consistency concurrence previously issued by the state, then the permittee must obtain an individual coastal zone management consistency concurrence or presumption of concurrence in order for the activity to be authorized by an NWP. The district engineer or a state may require additional measures to ensure that the authorized activity is consistent with state coastal zone management requirements.

27. Regional and Case-By-Case Conditions. The activity must comply with any regional conditions that may have been added by the Division Engineer (see 33 CFR 330.4(e)) and with any case specific conditions added by the Corps or by the state, Indian Tribe, or U.S. EPA in its CWA section 401 Water Quality Certification, or by the state in its Coastal Zone Management Act consistency determination.

28. Use of Multiple Nationwide Permits. The use of more than one NWP for a single and complete project is authorized, subject to the following restrictions:

(a) If only one of the NWPs used to authorize the single and complete project has a specified acreage limit, the acreage loss of waters of the United States cannot exceed the acreage limit of the NWP with the highest specified acreage limit. For example, if a road crossing over tidal waters is constructed under NWP 14, with associated bank

stabilization authorized by NWP 13, the maximum acreage loss of waters of the United States for the total project cannot exceed 1/3-acre.

(b) If one or more of the NWPs used to authorize the single and complete project has specified acreage limits, the acreage loss of waters of the United States authorized by those NWPs cannot exceed their respective specified acreage limits. For example, if a commercial development is constructed under NWP 39, and the single and complete project includes the filling of an upland ditch authorized by NWP 46, the maximum acreage loss of waters of the United States for the commercial development under NWP 39 cannot exceed 1/2-acre, and the total acreage loss of waters of United States due to the NWP 39 and 46 activities cannot exceed 1 acre.

29. Transfer of Nationwide Permit Verifications. If the permittee sells the property associated with a nationwide permit verification, the permittee may transfer the nationwide permit verification to the new owner by submitting a letter to the appropriate Corps district office to validate the transfer. A copy of the nationwide permit verification must be attached to the letter, and the letter must contain the following statement and signature:

“When the structures or work authorized by this nationwide permit are still in existence at the time the property is transferred, the terms and conditions of this nationwide permit, including any special conditions, will continue to be binding on the new owner(s) of the property. To validate the transfer of this nationwide permit and the associated liabilities associated with compliance with its terms and conditions, have the transferee sign and date below.”

(Transferee)

(Date)

30. Compliance Certification. Each permittee who receives an NWP verification letter from the Corps must provide a signed certification documenting completion of the authorized activity and implementation of any required compensatory mitigation. The success of any required permittee-responsible mitigation, including the achievement of ecological performance standards, will be addressed separately by the district engineer. The Corps will provide the permittee the certification document with the NWP verification letter. The certification document will include:

(a) A statement that the authorized activity was done in accordance with the NWP authorization, including any general, regional, or activity-specific conditions;

(b) A statement that the implementation of any required compensatory mitigation was completed in accordance with the permit conditions. If credits from a mitigation bank or in-lieu fee program are used to satisfy the compensatory mitigation requirements, the certification must include the documentation required by 33 CFR 332.3(l)(3) to confirm that the permittee secured the appropriate number and resource type of credits; and

(c) The signature of the permittee certifying the completion of the activity and mitigation.

The completed certification document must be submitted to the district engineer within 30 days of completion of the authorized activity or the implementation of any required compensatory mitigation, whichever occurs later.

31. Activities Affecting Structures or Works Built by the United States. If an NWP activity also requires review by, or permission from, the Corps pursuant to 33 U.S.C. 408 because it will alter or temporarily or permanently occupy or use a U.S. Army Corps of Engineers (USACE) federally authorized Civil Works project (a "USACE project"), the prospective permittee must submit a pre-construction notification. See paragraph (b)(10) of general condition 32. An activity that requires section 408 permission and/or review is not authorized by an NWP until the appropriate Corps office issues the section 408 permission or completes its review to alter, occupy, or use the USACE project, and the district engineer issues a written NWP verification.

32. Pre-Construction Notification. (a) *Timing*. Where required by the terms of the NWP, the prospective permittee must notify the district engineer by submitting a pre-construction notification (PCN) as early as possible. The district engineer must determine if the PCN is complete within 30 calendar days of the date of receipt and, if the PCN is determined to be incomplete, notify the prospective permittee within that 30 day period to request the additional information necessary to make the PCN complete. The request must specify the information needed to make the PCN complete. As a general rule, district engineers will request additional information necessary to make the PCN complete only once. However, if the prospective permittee does not provide all of the requested information, then the district engineer will notify the prospective permittee that the PCN is still incomplete and the PCN review process will not commence until all of the requested information has been received by the district engineer. The prospective permittee shall not begin the activity until either:

(1) He or she is notified in writing by the district engineer that the activity may proceed under the NWP with any special conditions imposed by the district or division engineer; or

(2) 45 calendar days have passed from the district engineer's receipt of the complete PCN and the prospective permittee has not received written notice from the district or division engineer. However, if the permittee was required to notify the Corps pursuant to general condition 18 that listed species or critical habitat might be affected or are in the vicinity of the activity, or to notify the Corps pursuant to general condition 20 that the activity might have the potential to cause effects to historic properties, the permittee

cannot begin the activity until receiving written notification from the Corps that there is “no effect” on listed species or “no potential to cause effects” on historic properties, or that any consultation required under Section 7 of the Endangered Species Act (see 33 CFR 330.4(f)) and/or section 106 of the National Historic Preservation Act (see 33 CFR 330.4(g)) has been completed. If the proposed activity requires a written waiver to exceed specified limits of an NWP, the permittee may not begin the activity until the district engineer issues the waiver. If the district or division engineer notifies the permittee in writing that an individual permit is required within 45 calendar days of receipt of a complete PCN, the permittee cannot begin the activity until an individual permit has been obtained. Subsequently, the permittee’s right to proceed under the NWP may be modified, suspended, or revoked only in accordance with the procedure set forth in 33 CFR 330.5(d)(2).

(b) *Contents of Pre-Construction Notification:* The PCN must be in writing and include the following information:

(1) Name, address and telephone numbers of the prospective permittee;

(2) Location of the proposed activity;

(3) Identify the specific NWP or NWP(s) the prospective permittee wants to use to authorize the proposed activity;

(4) (i) A description of the proposed activity; the activity’s purpose; direct and indirect adverse environmental effects the activity would cause, including the anticipated amount of loss of wetlands, other special aquatic sites, and other waters expected to result from the NWP activity, in acres, linear feet, or other appropriate unit of measure; a description of any proposed mitigation measures intended to reduce the adverse environmental effects caused by the proposed activity; and any other NWP(s), regional general permit(s), or individual permit(s) used or intended to be used to authorize any part of the proposed project or any related activity, including other separate and distant crossings for linear projects that require Department of the Army authorization but do not require pre-construction notification. The description of the proposed activity and any proposed mitigation measures should be sufficiently detailed to allow the district engineer to determine that the adverse environmental effects of the activity will be no more than minimal and to determine the need for compensatory mitigation or other mitigation measures.

(ii) For linear projects where one or more single and complete crossings require pre-construction notification, the PCN must include the quantity of anticipated losses of wetlands, other special aquatic sites, and other waters for each single and complete crossing of those wetlands, other special aquatic sites, and other waters (including those single and complete crossings authorized by an NWP but do not require PCNs). This information will be used by the district engineer to evaluate the cumulative adverse environmental effects of the proposed linear project, and does not change those non-PCN NWP activities into NWP PCNs.

(iii) Sketches should be provided when necessary to show that the activity complies with the terms of the NWP. (Sketches usually clarify the activity and when provided results in a quicker decision. Sketches should contain sufficient detail to provide an illustrative description of the proposed activity (e.g., a conceptual plan), but do not need to be detailed engineering plans);

(5) The PCN must include a delineation of wetlands, other special aquatic sites, and other waters, such as lakes and ponds, and perennial and intermittent streams, on the project site. Wetland delineations must be prepared in accordance with the current method required by the Corps. The permittee may ask the Corps to delineate the special aquatic sites and other waters on the project site, but there may be a delay if the Corps does the delineation, especially if the project site is large or contains many wetlands, other special aquatic sites, and other waters. Furthermore, the 45-day period will not start until the delineation has been submitted to or completed by the Corps, as appropriate;

(6) If the proposed activity will result in the loss of greater than 1/10-acre of wetlands or 3/100-acre of stream bed and a PCN is required, the prospective permittee must submit a statement describing how the mitigation requirement will be satisfied, or explaining why the adverse environmental effects are no more than minimal and why compensatory mitigation should not be required. As an alternative, the prospective permittee may submit a conceptual or detailed mitigation plan.

(7) For non-federal permittees, if any listed species (or species proposed for listing) or designated critical habitat (or critical habitat proposed for such designation) might be affected or is in the vicinity of the activity, or if the activity is located in designated critical habitat (or critical habitat proposed for such designation), the PCN must include the name(s) of those endangered or threatened species (or species proposed for listing) that might be affected by the proposed activity or utilize the designated critical habitat (or critical habitat proposed for such designation) that might be affected by the proposed activity. For NWP activities that require pre-construction notification, Federal permittees must provide documentation demonstrating compliance with the Endangered Species Act;

(8) For non-federal permittees, if the NWP activity might have the potential to cause effects to a historic property listed on, determined to be eligible for listing on, or potentially eligible for listing on, the National Register of Historic Places, the PCN must state which historic property might have the potential to be affected by the proposed activity or include a vicinity map indicating the location of the historic property. For NWP activities that require pre-construction notification, Federal permittees must provide documentation demonstrating compliance with section 106 of the National Historic Preservation Act;

(9) For an activity that will occur in a component of the National Wild and Scenic River System, or in a river officially designated by Congress as a "study river" for possible

inclusion in the system while the river is in an official study status, the PCN must identify the Wild and Scenic River or the “study river” (see general condition 16); and

(10) For an NWP activity that requires permission from, or review by, the Corps pursuant to 33 U.S.C. 408 because it will alter or temporarily or permanently occupy or use a U.S. Army Corps of Engineers federally authorized civil works project, the pre-construction notification must include a statement confirming that the project proponent has submitted a written request for section 408 permission from, or review by, the Corps office having jurisdiction over that USACE project.

(c) *Form of Pre-Construction Notification:* The nationwide permit pre-construction notification form (Form ENG 6082) should be used for NWP PCNs. A letter containing the required information may also be used. Applicants may provide electronic files of PCNs and supporting materials if the district engineer has established tools and procedures for electronic submittals.

(d) *Agency Coordination:* (1) The district engineer will consider any comments from Federal and state agencies concerning the proposed activity’s compliance with the terms and conditions of the NWPs and the need for mitigation to reduce the activity’s adverse environmental effects so that they are no more than minimal.

(2) Agency coordination is required for: (i) all NWP activities that require pre-construction notification and result in the loss of greater than 1/2-acre of waters of the United States; (ii) NWP 13 activities in excess of 500 linear feet, fills greater than one cubic yard per running foot, or involve discharges of dredged or fill material into special aquatic sites; and (iii) NWP 54 activities in excess of 500 linear feet, or that extend into the waterbody more than 30 feet from the mean low water line in tidal waters or the ordinary high water mark in the Great Lakes.

(3) When agency coordination is required, the district engineer will immediately provide (e.g., via e-mail, facsimile transmission, overnight mail, or other expeditious manner) a copy of the complete PCN to the appropriate Federal or state offices (FWS, state natural resource or water quality agency, EPA, and, if appropriate, the NMFS). With the exception of NWP 37, these agencies will have 10 calendar days from the date the material is transmitted to notify the district engineer via telephone, facsimile transmission, or e-mail that they intend to provide substantive, site-specific comments. The comments must explain why the agency believes the adverse environmental effects will be more than minimal. If so contacted by an agency, the district engineer will wait an additional 15 calendar days before making a decision on the pre-construction notification. The district engineer will fully consider agency comments received within the specified time frame concerning the proposed activity’s compliance with the terms and conditions of the NWPs, including the need for mitigation to ensure that the net adverse environmental effects of the proposed activity are no more than minimal. The district engineer will provide no response to the resource agency, except as provided below. The district engineer will indicate in the administrative record associated with each pre-construction notification that the resource agencies’ concerns were

considered. For NWP 37, the emergency watershed protection and rehabilitation activity may proceed immediately in cases where there is an unacceptable hazard to life or a significant loss of property or economic hardship will occur. The district engineer will consider any comments received to decide whether the NWP 37 authorization should be modified, suspended, or revoked in accordance with the procedures at 33 CFR 330.5.

(4) In cases of where the prospective permittee is not a Federal agency, the district engineer will provide a response to NMFS within 30 calendar days of receipt of any Essential Fish Habitat conservation recommendations, as required by section 305(b)(4)(B) of the Magnuson-Stevens Fishery Conservation and Management Act.

(5) Applicants are encouraged to provide the Corps with either electronic files or multiple copies of pre-construction notifications to expedite agency coordination.

District Engineer's Decision

1. In reviewing the PCN for the proposed activity, the district engineer will determine whether the activity authorized by the NWP will result in more than minimal individual or cumulative adverse environmental effects or may be contrary to the public interest. If a project proponent requests authorization by a specific NWP, the district engineer should issue the NWP verification for that activity if it meets the terms and conditions of that NWP, unless he or she determines, after considering mitigation, that the proposed activity will result in more than minimal individual and cumulative adverse effects on the aquatic environment and other aspects of the public interest and exercises discretionary authority to require an individual permit for the proposed activity. For a linear project, this determination will include an evaluation of the single and complete crossings of waters of the United States that require PCNs to determine whether they individually satisfy the terms and conditions of the NWP(s), as well as the cumulative effects caused by all of the crossings of waters of the United States authorized by an NWP. If an applicant requests a waiver of an applicable limit, as provided for in NWPs 13, 36, or 54, the district engineer will only grant the waiver upon a written determination that the NWP activity will result in only minimal individual and cumulative adverse environmental effects.

2. When making minimal adverse environmental effects determinations the district engineer will consider the direct and indirect effects caused by the NWP activity. He or she will also consider the cumulative adverse environmental effects caused by activities authorized by an NWP and whether those cumulative adverse environmental effects are no more than minimal. The district engineer will also consider site specific factors, such as the environmental setting in the vicinity of the NWP activity, the type of resource that will be affected by the NWP activity, the functions provided by the aquatic resources that will be affected by the NWP activity, the degree or magnitude to which the aquatic resources perform those functions, the extent that aquatic resource functions will be lost as a result of the NWP activity (e.g., partial or complete loss), the duration of the adverse effects (temporary or permanent), the importance of the aquatic resource

functions to the region (e.g., watershed or ecoregion), and mitigation required by the district engineer. If an appropriate functional or condition assessment method is available and practicable to use, that assessment method may be used by the district engineer to assist in the minimal adverse environmental effects determination. The district engineer may add case-specific special conditions to the NWP authorization to address site-specific environmental concerns.

3. If the proposed activity requires a PCN and will result in a loss of greater than 1/10-acre of wetlands or 3/100-acre of stream bed, the prospective permittee should submit a mitigation proposal with the PCN. Applicants may also propose compensatory mitigation for NWP activities with smaller impacts, or for impacts to other types of waters. The district engineer will consider any proposed compensatory mitigation or other mitigation measures the applicant has included in the proposal in determining whether the net adverse environmental effects of the proposed activity are no more than minimal. The compensatory mitigation proposal may be either conceptual or detailed. If the district engineer determines that the activity complies with the terms and conditions of the NWP and that the adverse environmental effects are no more than minimal, after considering mitigation, the district engineer will notify the permittee and include any activity-specific conditions in the NWP verification the district engineer deems necessary. Conditions for compensatory mitigation requirements must comply with the appropriate provisions at 33 CFR 332.3(k). The district engineer must approve the final mitigation plan before the permittee commences work in waters of the United States, unless the district engineer determines that prior approval of the final mitigation plan is not practicable or not necessary to ensure timely completion of the required compensatory mitigation. If the prospective permittee elects to submit a compensatory mitigation plan with the PCN, the district engineer will expeditiously review the proposed compensatory mitigation plan. The district engineer must review the proposed compensatory mitigation plan within 45 calendar days of receiving a complete PCN and determine whether the proposed mitigation would ensure that the NWP activity results in no more than minimal adverse environmental effects. If the net adverse environmental effects of the NWP activity (after consideration of the mitigation proposal) are determined by the district engineer to be no more than minimal, the district engineer will provide a timely written response to the applicant. The response will state that the NWP activity can proceed under the terms and conditions of the NWP, including any activity-specific conditions added to the NWP authorization by the district engineer.

4. If the district engineer determines that the adverse environmental effects of the proposed activity are more than minimal, then the district engineer will notify the applicant either: (a) that the activity does not qualify for authorization under the NWP and instruct the applicant on the procedures to seek authorization under an individual permit; (b) that the activity is authorized under the NWP subject to the applicant's submission of a mitigation plan that would reduce the adverse environmental effects so that they are no more than minimal; or (c) that the activity is authorized under the NWP with specific modifications or conditions. Where the district engineer determines that mitigation is required to ensure no more than minimal adverse environmental effects, the activity will be authorized within the 45-day PCN period (unless additional time is

required to comply with general conditions 18, 20, and/or 31), with activity-specific conditions that state the mitigation requirements. The authorization will include the necessary conceptual or detailed mitigation plan or a requirement that the applicant submit a mitigation plan that would reduce the adverse environmental effects so that they are no more than minimal. When compensatory mitigation is required, no work in waters of the United States may occur until the district engineer has approved a specific mitigation plan or has determined that prior approval of a final mitigation plan is not practicable or not necessary to ensure timely completion of the required compensatory mitigation.

Further Information

1. District engineers have authority to determine if an activity complies with the terms and conditions of an NWP.
2. NWPs do not obviate the need to obtain other federal, state, or local permits, approvals, or authorizations required by law.
3. NWPs do not grant any property rights or exclusive privileges.
4. NWPs do not authorize any injury to the property or rights of others.
5. NWPs do not authorize interference with any existing or proposed Federal project (see general condition 31).

Nationwide Permit Definitions

Best management practices (BMPs): Policies, practices, procedures, or structures implemented to mitigate the adverse environmental effects on surface water quality resulting from development. BMPs are categorized as structural or non-structural.

Compensatory mitigation: The restoration (re-establishment or rehabilitation), establishment (creation), enhancement, and/or in certain circumstances preservation of aquatic resources for the purposes of offsetting unavoidable adverse impacts which remain after all appropriate and practicable avoidance and minimization has been achieved.

Currently serviceable: Useable as is or with some maintenance, but not so degraded as to essentially require reconstruction.

Direct effects: Effects that are caused by the activity and occur at the same time and place.

Discharge: The term “discharge” means any discharge of dredged or fill material into waters of the United States.

Ecological reference: A model used to plan and design an aquatic habitat and riparian area restoration, enhancement, or establishment activity under NWP 27. An ecological reference may be based on the structure, functions, and dynamics of an aquatic habitat type or a riparian area type that currently exists in the region where the proposed NWP 27 activity is located. Alternatively, an ecological reference may be based on a conceptual model for the aquatic habitat type or riparian area type to be restored, enhanced, or established as a result of the proposed NWP 27 activity. An ecological reference takes into account the range of variation of the aquatic habitat type or riparian area type in the region.

Enhancement: The manipulation of the physical, chemical, or biological characteristics of an aquatic resource to heighten, intensify, or improve a specific aquatic resource function(s). Enhancement results in the gain of selected aquatic resource function(s), but may also lead to a decline in other aquatic resource function(s). Enhancement does not result in a gain in aquatic resource area.

Establishment (creation): The manipulation of the physical, chemical, or biological characteristics present to develop an aquatic resource that did not previously exist at an upland site. Establishment results in a gain in aquatic resource area.

High Tide Line: The line of intersection of the land with the water's surface at the maximum height reached by a rising tide. The high tide line may be determined, in the absence of actual data, by a line of oil or scum along shore objects, a more or less continuous deposit of fine shell or debris on the foreshore or berm, other physical markings or characteristics, vegetation lines, tidal gages, or other suitable means that delineate the general height reached by a rising tide. The line encompasses spring high tides and other high tides that occur with periodic frequency but does not include storm surges in which there is a departure from the normal or predicted reach of the tide due to the piling up of water against a coast by strong winds such as those accompanying a hurricane or other intense storm.

Historic Property: Any prehistoric or historic district, site (including archaeological site), building, structure, or other object included in, or eligible for inclusion in, the National Register of Historic Places maintained by the Secretary of the Interior. This term includes artifacts, records, and remains that are related to and located within such properties. The term includes properties of traditional religious and cultural importance to an Indian tribe or Native Hawaiian organization and that meet the National Register criteria (36 CFR part 60).

Independent utility: A test to determine what constitutes a single and complete non-linear project in the Corps Regulatory Program. A project is considered to have independent utility if it would be constructed absent the construction of other projects in the project area. Portions of a multi-phase project that depend upon other phases of the project do not have independent utility. Phases of a project that would be constructed even if the other phases were not built can be considered as separate single and complete projects with independent utility.

Indirect effects: Effects that are caused by the activity and are later in time or farther removed in distance, but are still reasonably foreseeable.

Loss of waters of the United States: Waters of the United States that are permanently adversely affected by filling, flooding, excavation, or drainage because of the regulated activity. The loss of stream bed includes the acres of stream bed that are permanently adversely affected by filling or excavation because of the regulated activity. Permanent adverse effects include permanent discharges of dredged or fill material that change an aquatic area to dry land, increase the bottom elevation of a waterbody, or change the use of a waterbody. The acreage of loss of waters of the United States is a threshold measurement of the impact to jurisdictional waters or wetlands for determining whether a project may qualify for an NWP; it is not a net threshold that is calculated after considering compensatory mitigation that may be used to offset losses of aquatic functions and services. Waters of the United States temporarily filled, flooded, excavated, or drained, but restored to pre-construction contours and elevations after construction, are not included in the measurement of loss of waters of the United States. Impacts resulting from activities that do not require Department of the Army authorization, such as activities eligible for exemptions under section 404(f) of the Clean Water Act, are not considered when calculating the loss of waters of the United States.

Navigable waters: Waters subject to section 10 of the Rivers and Harbors Act of 1899. These waters are defined at 33 CFR part 329.

Non-tidal wetland: A non-tidal wetland is a wetland that is not subject to the ebb and flow of tidal waters. Non-tidal wetlands contiguous to tidal waters are located landward of the high tide line (i.e., spring high tide line).

Open water: For purposes of the NWPs, an open water is any area that in a year with normal patterns of precipitation has water flowing or standing above ground to the extent that an ordinary high water mark can be determined. Aquatic vegetation within the area of flowing or standing water is either non-emergent, sparse, or absent. Vegetated shallows are considered to be open waters. Examples of “open waters” include rivers, streams, lakes, and ponds.

Ordinary High Water Mark: The term ordinary high water mark means that line on the shore established by the fluctuations of water and indicated by physical characteristics such as a clear, natural line impressed on the bank, shelving, changes in the character of soil, destruction of terrestrial vegetation, the presence of litter and debris, or other appropriate means that consider the characteristics of the surrounding areas.

Perennial stream: A perennial stream has surface water flowing continuously year-round during a typical year.

Practicable: Available and capable of being done after taking into consideration cost, existing technology, and logistics in light of overall project purposes.

Pre-construction notification: A request submitted by the project proponent to the Corps for confirmation that a particular activity is authorized by nationwide permit. The request may be a permit application, letter, or similar document that includes information about the proposed work and its anticipated environmental effects. Pre-construction notification may be required by the terms and conditions of a nationwide permit, or by regional conditions. A pre-construction notification may be voluntarily submitted in cases where pre-construction notification is not required and the project proponent wants confirmation that the activity is authorized by nationwide permit.

Preservation: The removal of a threat to, or preventing the decline of, aquatic resources by an action in or near those aquatic resources. This term includes activities commonly associated with the protection and maintenance of aquatic resources through the implementation of appropriate legal and physical mechanisms. Preservation does not result in a gain of aquatic resource area or functions.

Re-establishment: The manipulation of the physical, chemical, or biological characteristics of a site with the goal of returning natural/historic functions to a former aquatic resource. Re-establishment results in rebuilding a former aquatic resource and results in a gain in aquatic resource area and functions.

Rehabilitation: The manipulation of the physical, chemical, or biological characteristics of a site with the goal of repairing natural/historic functions to a degraded aquatic resource. Rehabilitation results in a gain in aquatic resource function, but does not result in a gain in aquatic resource area.

Restoration: The manipulation of the physical, chemical, or biological characteristics of a site with the goal of returning natural/historic functions to a former or degraded aquatic resource. For the purpose of tracking net gains in aquatic resource area, restoration is divided into two categories: re-establishment and rehabilitation.

Riffle and pool complex: Riffle and pool complexes are special aquatic sites under the 404(b)(1) Guidelines. Riffle and pool complexes sometimes characterize steep gradient sections of streams. Such stream sections are recognizable by their hydraulic characteristics. The rapid movement of water over a coarse substrate in riffles results in a rough flow, a turbulent surface, and high dissolved oxygen levels in the water. Pools are deeper areas associated with riffles. A slower stream velocity, a streaming flow, a smooth surface, and a finer substrate characterize pools.

Riparian areas: Riparian areas are lands next to streams, lakes, and estuarine-marine shorelines. Riparian areas are transitional between terrestrial and aquatic ecosystems, through which surface and subsurface hydrology connects riverine, lacustrine, estuarine, and marine waters with their adjacent wetlands, non-wetland waters, or uplands. Riparian areas provide a variety of ecological functions and services and help improve or maintain local water quality. (See general condition 23.)

Shellfish seeding: The placement of shellfish seed and/or suitable substrate to increase shellfish production. Shellfish seed consists of immature individual shellfish or individual shellfish attached to shells or shell fragments (i.e., spat on shell). Suitable substrate may consist of shellfish shells, shell fragments, or other appropriate materials placed into waters for shellfish habitat.

Single and complete linear project: A linear project is a project constructed for the purpose of getting people, goods, or services from a point of origin to a terminal point, which often involves multiple crossings of one or more waterbodies at separate and distant locations. The term “single and complete project” is defined as that portion of the total linear project proposed or accomplished by one owner/developer or partnership or other association of owners/developers that includes all crossings of a single water of the United States (i.e., a single waterbody) at a specific location. For linear projects crossing a single or multiple waterbodies several times at separate and distant locations, each crossing is considered a single and complete project for purposes of NWP authorization. However, individual channels in a braided stream or river, or individual arms of a large, irregularly shaped wetland or lake, etc., are not separate waterbodies, and crossings of such features cannot be considered separately.

Single and complete non-linear project: For non-linear projects, the term “single and complete project” is defined at 33 CFR 330.2(i) as the total project proposed or accomplished by one owner/developer or partnership or other association of owners/developers. A single and complete non-linear project must have independent utility (see definition of “independent utility”). Single and complete non-linear projects may not be “piecemealed” to avoid the limits in an NWP authorization.

Stormwater management: Stormwater management is the mechanism for controlling stormwater runoff for the purposes of reducing downstream erosion, water quality degradation, and flooding and mitigating the adverse effects of changes in land use on the aquatic environment.

Stormwater management facilities: Stormwater management facilities are those facilities, including but not limited to, stormwater retention and detention ponds and best management practices, which retain water for a period of time to control runoff and/or improve the quality (i.e., by reducing the concentration of nutrients, sediments, hazardous substances and other pollutants) of stormwater runoff.

Stream bed: The substrate of the stream channel between the ordinary high water marks. The substrate may be bedrock or inorganic particles that range in size from clay to boulders. Wetlands contiguous to the stream bed, but outside of the ordinary high water marks, are not considered part of the stream bed.

Stream channelization: The manipulation of a stream’s course, condition, capacity, or location that causes more than minimal interruption of normal stream processes. A channelized jurisdictional stream remains a water of the United States.

Structure: An object that is arranged in a definite pattern of organization. Examples of structures include, without limitation, any pier, boat dock, boat ramp, wharf, dolphin, weir, boom, breakwater, bulkhead, revetment, riprap, jetty, artificial island, artificial reef, permanent mooring structure, power transmission line, permanently moored floating vessel, piling, aid to navigation, or any other manmade obstacle or obstruction.

Tidal wetland: A tidal wetland is a jurisdictional wetland that is inundated by tidal waters. Tidal waters rise and fall in a predictable and measurable rhythm or cycle due to the gravitational pulls of the moon and sun. Tidal waters end where the rise and fall of the water surface can no longer be practically measured in a predictable rhythm due to masking by other waters, wind, or other effects. Tidal wetlands are located channelward of the high tide line.

Tribal lands: Any lands title to which is either: 1) held in trust by the United States for the benefit of any Indian tribe or individual; or 2) held by any Indian tribe or individual subject to restrictions by the United States against alienation.

Tribal rights: Those rights legally accruing to a tribe or tribes by virtue of inherent sovereign authority, unextinguished aboriginal title, treaty, statute, judicial decisions, executive order or agreement, and that give rise to legally enforceable remedies.

Vegetated shallows: Vegetated shallows are special aquatic sites under the 404(b)(1) Guidelines. They are areas that are permanently inundated and under normal circumstances have rooted aquatic vegetation, such as seagrasses in marine and estuarine systems and a variety of vascular rooted plants in freshwater systems.

Waterbody: For purposes of the NWP, a waterbody is a "water of the United States." If a wetland is adjacent to a waterbody determined to be a water of the United States, that waterbody and any adjacent wetlands are considered together as a single aquatic unit (see 33 CFR 328.4(c)(2)).



DEPARTMENT OF THE ARMY
CORPS OF ENGINEERS, CHARLESTON DISTRICT
69A HAGOOD AVENUE
CHARLESTON, SOUTH CAROLINA 29403-5107

FINAL REGIONAL CONDITIONS FOR THE 2021 NATIONWIDE PERMITS IN CHARLESTON DISTRICT (SAC)

Effective Date for Modified Regional Conditions for 16 NWP: January 19, 2022
Effective Date for Regional Conditions for 41 NWP: February 25, 2022
Expiration Date for Regional Conditions for All NWP: March 14, 2026

This Regional Condition document supersedes all prior Regional Condition documents for the Charleston District.

A. BACKGROUND/APPLICABILITY

1. The following regional conditions have been approved by the Division Engineer for the South Atlantic Division (SAD) for use in the Charleston District (SAC) for the following Nationwide Permits (NWP):
 - a. The NWP published in the January 13, 2021 Federal Register (86 FR 2744) announcing the reissuance of twelve (12) existing NWP (that is, NWP 12, 21, 29, 39, 40, 42, 43, 44, 48, 50, 51, and 52) and issuance of four (4) new NWP (that is, NWP 55, 56, 57, and 58), as well as the reissuance of NWP general conditions and definitions with some modifications. These 16 NWP were effective on March 15, 2021 and will expire on March 14, 2026; and
 - b. The NWP published in the December 27, 2021 Federal Register (86 FR 73522) announcing the reissuance of the remaining unmodified forty (40) existing NWP (that is, NWP 1, 2, 3, 4, 5, 6, 7, 8, 9, 10, 11, 13, 14, 15, 16, 17, 18, 19, 20, 22, 23, 24, 25, 27, 28, 30, 31, 32, 33, 34, 35, 36, 37, 38, 41, 45, 46, 49, 53, and 54) and issuance of one (1) new NWP (that is, NWP 59). At this time, NWP 26 and 47 are reserved. These 41 NWP will be effective as of February 25, 2022 and will expire on March 14, 2026.
2. Status of Activities Under Prior NWP and/or Regional Conditions.
 - i. 16 NWP: The modified regional conditions that were issued on January 19, 2022 and are incorporated in this document **supersede** the previous regional conditions that were approved for the 16 NWP that went into effect on March 15, 2021, **except** for the following scenarios:
 1. NWP verification letters for one or more of the 16 NWP that were issued **prior** to January 19, 2022; or

2021-2022 NWP REGIONAL CONDITIONS FOR CHARLESTON DISTRICT (SAC)

2. NWP activities that do not require a pre-construction notification (PCN)¹, are covered by one or more of the 16 NWPs, and have either commenced, are under contract to commence, or have been completed **prior** to January 19, 2022.
 - ii. 40 NWPs: For information about whether an activity can continue under the 2017 versions of the 40 existing NWPs (for example, the status of prior permit verifications and pre-construction notifications) and, accordingly, the 2017 Regional Conditions, see the discussion in the Reissuance and Modification of Nationwide Permits at 86 FR 73522 in Section I.D. on page 73525 or contact the Charleston District Regulatory Office directly.
3. The following regional conditions will provide additional protection for the aquatic environment that is necessary to ensure that the NWPs authorize only those activities with no more than minimal adverse environmental effects.
4. As specified, under NWP General Condition 27, Regional and Case-By-Case Conditions: The activity must comply with any regional conditions that may have been added by the Division Engineer (see 33 CFR 330.4(e)) and with any case-specific conditions added by the Corps or by the state, Indian Tribe, or U.S. EPA in its Section 401 Water Quality Certification, or by the state in its Coastal Zone Management Act consistency determination.

B. EXCLUDED WATERS AND/OR AREAS

Not applicable.

C. REGIONAL CONDITIONS APPLICABLE TO ALL NWPs

1. Use of nationwide permits does not preclude requirements to obtain all other applicable Federal, State, county, and local government authorizations.
2. NWP activities are not authorized in areas known or suspected to have sediment contamination, with the exception of the following: (1) activities authorized by NWP 38; (2) activities authorized by NWP 53 when used in combination with NWP 38; (3) sediment sampling for dredging projects authorized by NWP 6; and (4) activities authorized by NWP 20.
3. For all proposed activities, both temporary and permanent, that would be located within a FEMA designated floodway, the prospective permittee must submit a PCN to the District Engineer in accordance with General Condition 32.

¹ The acronym "PCN" used throughout this document refers to *Pre-Construction Notification*, as defined in NWP General Condition 32.

2021-2022 NWP REGIONAL CONDITIONS FOR CHARLESTON DISTRICT (SAC)

4. For all NWPs, the prospective permittee must submit a PCN to the District Engineer in accordance with General Conditions 31 and 32, for any activity that would be located in or adjacent to an authorized USACE Civil Works project, including Federal Navigation projects:
 - a. **USACE Civil Works projects:** Buck Creek in Horry County, Eagle Creek in Dorchester County, Kingstree Branch in Williamsburg County, Sawmill Branch in Berkeley and Dorchester Counties, Scotts Creek in Newberry County, Socastee Creek in Horry County and Turkey Creek in Sumter County, Wilson Branch in Chesterfield County, Edisto River in Orangeburg and Dorchester Counties, North Edisto River in Aitken and Orangeburg Counties, Folly Beach in Charleston County, Hunting Island Beach, waste water treatment plant and water line in Beaufort County, Myrtle Beach in Georgetown and Horry County, Pawleys Island Beach in Georgetown County, Edisto Island Beach in Charleston County, Crab Bank in Charleston County, Morris Island Lighthouse in Charleston County, Miller Corner Disposal area Phragmites Control in Georgetown County, Cape Marsh Management area (Santee Coastal Reserve) in Charleston County, Murphy Island in Charleston County, Pocolaligo River and Swamp in Clarendon and Sumter Counties, Pinopolis Dam in Berkeley County, Battery Pringle in Charleston County, Castle Pinckney in Charleston County, Pompion Hill Chapel along the Cooper River in Berkeley County, Drayton Hall in Charleston County, Indian Bluff in Orangeburg County, Singleton Swash at Shore Drive in Horry County, Turkey Creek Bridge at Pineview Drive in Lancaster, Big Dutchman Creek Bridge at West Oak Drive in Rock Hill, SC, Calabash Branch Bridge at Tom Joye Road in Clover, Blue Branch Bridge at Fortanberry Road in Gaffney, Glenn Creek Bridge at Sulphur Springs Road in Spartanburg County, Cow Castle Creek (Bowman) in Orangeburg County, Cowpen Swamp at Simpson Creek in Horry County, Crabtree Swamp in Horry County, Saluda River (North, South, and Middle Fork) in Greenville County, Shot Pouch Creek in Sumter County, Simpson Creek in Horry County, and Todd Swamp in Horry County.
 - b. **Defined Federal Navigation projects:** Ashley River (0.5 miles east of Hwy 7 bridge downstream to the Atlantic Intracoastal Waterway (AIWW)), Atlantic Intracoastal Waterway ((AIWW) GA/SC line to SC/NC line), Brookgreen Garden Canal, Calabash Creek, Charleston Harbor (including the Cooper River, Town Creek, Shem Creek to Coleman Blvd and Mount Pleasant Channel), Folly River, Georgetown Harbor (Winyah Bay, Sampit River and Bypass Channel), Jeremy Creek, Little River Inlet, Murrells Inlet (Main Creek), Port Royal Harbor, Shipyard River, Savannah River (Below Augusta) and Town Creek McClellanville (i.e., Five Fathoms Creek, AIWW to Bulls Bay).
 - c. **Undefined Federal Navigation projects:** Adams Creek, Archers Creek (From intersection with Beaufort River for 2 miles), Edisto River (River mile 0.00 to 175.0), Great Pee Dee River (Waccamaw River via Bull Creek then to

2021-2022 NWP REGIONAL CONDITIONS FOR CHARLESTON DISTRICT (SAC)

Smith Mills, then to Cheraw), Lynches River/Clark Creek (Clark Creek to Lynches River, River Mile 0.0 to 56.0), Mingo Creek (to Hemmingway Bridge), Salkehatchie River (5 miles above Toby's Bluff to Hickory Hill, River mile 20.4 to 62.3), Santee River (Closed to navigation at mile 87 (Santee Dam)), Waccamaw River (river mile 0.0 to 90 (state line)), Wateree River (Mouth to Camden), and Village Creek (Morgan River to Porpoise Fish Co., 2.2 miles).

5. For all proposed activities that would be located in or adjacent to an authorized Federal Navigation project, as referenced in Regional Condition C.4.b, the project drawings must include the following information: (1) State Plane Coordinates (NAD 1983) for a minimum of two corners of each structure or fill where it is closest to the Federal channel; (2) the distance from the watermost edge of the proposed structure or fill to the nearest edge of the Federal channel; and (3) Mean Low Water line and the Mean High Water line.
6. For all NWPs requiring a PCN and when the activity involves the discharge of dredged or fill material into waters of the U.S. associated with mechanized land clearing that results in the permanent conversion of forested or scrub-shrub wetlands to herbaceous wetlands, the PCN should include the following information: (1) a written description and/or drawings of the proposed conversion activity and (2) acreage of the permanent conversion.

D. REGIONAL CONDITIONS APPLICABLE TO SPECIFIC NWPs

1. For NWP 3, paragraph (a) activities, the prospective permittee must submit a PCN to the District Engineer in accordance with General Condition #32 for the repair, rehabilitation or replacement of existing utility lines, which include electric lines and/or telecommunication lines, constructed over navigable waters of the United States (i.e., Section 10 waters), and existing utility lines, electric lines, telecommunication lines and/or pipelines routed in or under navigable waters of the United States (i.e., Section 10 waters), even if no discharge of dredged or fill material occurs.
2. For NWP 3, the prospective permittee must submit a PCN to the District Engineer in accordance with General Condition 32, for maintenance activities related to stormwater management that would occur in tidal waters, including tidal wetlands.
3. For NWPs 3, 11, 12, 13, 14, 15, 20, 22, 33, 57, 58, and 59, temporary structures, fills, and/or work, including the use of temporary mats, are authorized for the minimum amount of time necessary to accomplish the work, which shall not exceed a period of 180 days without additional Corps approval. **However, temporary sidecast material authorized by NWPs 12, 57, or 58 cannot ever exceed a period of 180 days.** The temporary structures, fills, and/or work, including the use of temporary mats, shall be removed as soon as the work is

2021-2022 NWP REGIONAL CONDITIONS FOR CHARLESTON DISTRICT (SAC)

complete and the disturbed areas be restored to pre-construction contours and conditions. The temporary mats include timber mats, metal, synthetic and/or artificial mats, or other materials that may serve the purpose of mats.

4. For NWPs 3, 11, 12, 13, 14, 15, 20, 22, 33, 57, 58 and 59 that require PCNs and when the activity involves temporary structures, fills, and/or work, including the use of temporary mats, the PCN should include the following information: (1) a written description and/or drawings of the proposed temporary activities that will be used during project construction; (2) the timeframe that the proposed temporary activities will be in place; and (3) specifications of how pre-construction contours will be re-established and verified after construction. Temporary mats include timber mats, metal, synthetic and/or artificial mats, or other materials that may serve the purpose of mats.
5. For NWPs 7, 12, 14, 16, 17, 21, 29, 31, 35, 39, 40, 42, 43, 44, 49, 50, 51, 52, 57 and 58 in accordance with General Condition 22(a) and for NWPs 3, 8, 10, 13, 15, 18, 19, 22, 23, 25, 27, 28, 30, 33, 34, 36, 37, 38 and 54, in accordance with General Condition 22(b), the ACE Basin National Estuarine Research Reserve and the North Inlet Winyah Bay National Estuarine Research Reserve are Designated Critical Resource Waters. Activities described in the NWPs listed herein are subject to the limitations and/or PCN requirements listed in General Condition 22 (a) and (b).
6. For NWPs 7 and 58 activities that involve intake structures, the associated intake structure must be screened to prevent entrainment of juvenile and larval organisms, and the inflow velocity of the associated intake structures cannot exceed 0.5 feet/second.
7. For NWPs 12, 57 and 58 activities that involve horizontal directional drilling beneath navigable waters of the United States (i.e., Section 10 waters), the PCN should include a proposed remediation plan (i.e., frac-out plan).
8. For NWPs 12, 14, 29, 39, 46, 51, 52, 57 and 58 activities that involve crossings, all culverts must be adequately sized to maintain flow. For these activities that require submittal of a PCN, the PCN should include the minimum size of and number of culvert/pipes that are proposed.
9. For NWPs 12, 14, 18, 43, 51, 57 and 58, the prospective permittee must submit a PCN to the District Engineer in accordance with General Condition #32, for activities that involve the loss of greater than 0.005 acre of stream bed.
10. For NWPs 12, 14, 18, 21, 29, 39, 40, 42, 43, 44, 50, 51, 52, 57, 58 and 59, activities that involve the loss of greater than 0.005 acre of stream bed, compensatory mitigation will be required and the PCN should include a compensatory mitigation plan.

2021-2022 NWP REGIONAL CONDITIONS FOR CHARLESTON DISTRICT (SAC)

11. For NWPs 12, 14, 18, 21, 27, 29, 39, 40, 42, 43, 44, 50, 51, 52, 57, 58, and 59, the discharge cannot cause the loss of greater than 0.05 acre of stream bed.
12. For NWPs 29 and 39, the discharges of dredged or fill material for the construction of stormwater management facilities in perennial streams are not authorized.
13. For NWP 33, the prospective permittee must submit a PCN to the District Engineer, in accordance with General Condition #32, for temporary construction, access, and dewatering activities that impact greater than 0.1 acre of non-tidal waters of the United States, including wetlands. In addition, the PCN should include a restoration plan.
14. For existing NWP 48 activities that involve changing from bottom culture to floating or suspended culture OR proposed NWP 48 activities that involve floating or suspended culture, the prospective permittee must submit a PCN to the District Engineer in accordance with General Condition #32.
15. For proposed NWP 48 activities involving floating or suspended culture and/or proposed NWPs 55 and 56 activities that will occur adjacent to property that is not owned by the prospective permittee, the PCN should include the following information:
 - a. A map or depiction that shows the adjacent property(ies) and adjacent property owners' contact information. Note: This information may be obtained online from the applicable county's tax information pages.
 - b. A signed letter(s) of "no objection" to the proposed mariculture activity from each of the adjacent property owner(s). Each letter shall include the name, mailing address, property address, property Tax Map Parcel (TMS) number, and signature of the property owner. Or, if the prospective permittee is unable to obtain a letter(s) of "no objection", the Corps will notify the adjacent property owner(s) of the proposed project by letter wherein the adjacent property owner will be given 15 days to provide comments.
16. For NWP 53, the PCN should include a Tier I evaluation, in accordance with the Inland Testing Manual, for the project area immediately upstream of the low-head dam. If the Tier I evaluation indicates contaminated sediments are present, a Tier II evaluation may be required.
17. The prospective permittee is advised of the following for activities under any NWP for which (1) the 401 Water Quality Certifications (WQC) were denied (see F.1.a), and/or (2) activities under the NWP were found to be inconsistent with the S.C. Coastal Zone Management Program and, therefore, concurrence with the Coastal Zone Consistency determination was denied (see F.2.a), and/or (3) the

2021-2022 NWP REGIONAL CONDITIONS FOR CHARLESTON DISTRICT (SAC)

proposed activity is located in one of the “Critical Areas” of the Coastal Zone (see F.3):

- a. For NWPs 12, 14, 16, 17, 21, 23, 29, 34, 39, 44, 46, 49, 50, 54, 57, 58 and 59 where WQC was denied, the prospective permittee should provide to the Corps a copy of the Individual WQC or evidence demonstrating a waiver was granted.
- b. For NWPs 12, 14, 16, 17, 21, 23, 24, 29, 34, 35, 39, 42, 44, 46, 49, 50, 51, 55, 56, 57, 58 and 59 where concurrence with the Coastal Zone Consistency was denied, the prospective permittee should provide to the Corps a copy of the Individual CZC Concurrence or presumed concurrence for the proposed activity.
- c. For all NWPs in any of the “Critical Areas” of the Coastal Zone, an Individual Critical Area permit is required (see F.3). Therefore, the prospective permittee should provide a copy of the Individual Critical Area permit to the Corps for the proposed activity.

Note: For WQC conditions on activities under NWPs 43, 51, and 52, see F.1.b. For Coastal Zone Consistency conditions on activities under NWPs 43 and 52, see F.2.b.

18. For NWPs 12, 57 and 58, the prospective permittee must submit a PCN to the District Engineer in accordance with General Condition 32 if the activity involves the discharge of dredged or fill material into waters of the U.S. associated with mechanized land clearing that results in the permanent conversion of forested or scrub-shrub wetlands to herbaceous wetlands for a maintained right-of-way.

E. ACTIVITY SPECIFIC REGIONAL CONDITIONS

Not applicable.

F. SECTION 401 WATER QUALITY CERTIFICATION (WQC) AND/OR COASTAL ZONE MANAGEMENT ACT (CZMA) CONSISTENCY DETERMINATION SUMMARY AND APPLICABLE CONDITIONS

1. Water Quality Certification (WQC)

a. WQC Denied

The Water Quality Certifications (WQC) for the following NWPs are denied; therefore, an Individual WQC, or evidence demonstrating a waiver was granted, from the South Carolina Department of Health and Environmental Control (SCDHEC) will be required for authorization under these NWPs:

2021-2022 NWP REGIONAL CONDITIONS FOR CHARLESTON DISTRICT (SAC)

NWPs 12, 14, 16, 17, 21, 23, 29, 34, 39, 44, 46, 49, 50, 54, 57, 58 and 59.

b. **WQC Granted With Conditions**

The following WQC Conditions, as stated in the SCDHEC's Notice of Department Decision dated November 25, 2020, are also considered 2021 NWP Regional Conditions:

- i. For NWP 43, "Activities authorized by this certification are limited to maintenance of existing facilities, such as stormwater ponds, detention and retention basins, water control structures, outfall structures, emergency spillways, and existing ponds, that are proposed for use as water quantity or volume control. This NWP cannot be used for existing ponds that are proposed to be converted into water quality treatment facilities, such as sediment basins, sediment traps, or other similar structures."
- ii. For NWP 51, "This NWP is not certified for activities that cause the loss of more than 300 linear feet of stream bed."
- iii. For NWP 52, "This NWP is not certified for activities that cause the loss of more than 300 linear feet of stream bed."

c. **WQC Granted Without Conditions**

The WQCs for NWPs 3, 4, 5, 6, 7, 13, 15, 18, 19, 20, 22, 25, 27, 30, 31, 32, 33, 36, 37, 38, 40, 41, 42, 45, 48 and 53 were granted without conditions.

d. **No WQC Required**

NWPs 1, 2, 8, 9, 10, 11, 24, 28, 35, 55 and 56 do not require WQCs.

2. **Coastal Zone Consistency (CZC)**

a. **CZC Concurrence Denied**

The following NWPs were found to be inconsistent with the S.C. Coastal Zone Management Program; thus, the CZC concurrence is denied and an Individual CZC concurrence, or presumed concurrence for the proposed activity, will be required for these NWPs:

NWPs 12, 14, 16, 17, 21, 23, 24, 29, 34, 35, 39, 42, 44, 46, 49, 50, 51, 54, 55, 56, 57, 58 and 59.

b. **CZC Concurrence Granted With Conditions**

2021-2022 NWP REGIONAL CONDITIONS FOR CHARLESTON DISTRICT (SAC)

The following CZC Conditions, as stated in the SCDHEC's Notice of Department Decision dated November 25, 2020, are also considered 2021 NWP Regional Conditions:

- i. For NWP 43, "Activities authorized by this certification are limited to maintenance of existing facilities, such as stormwater ponds, detention and retention basins, water control structures, outfall structures, emergency spillways, and existing ponds that are proposed for use as water quantity or volume control. This NWP cannot be used for existing ponds that are proposed to be converted into water quality treatment facilities such as sediment basins, sediment traps, or other similar structures."
- ii. For NWP 52, "This NWP is not certified for activities that cause the loss of more than 300 linear feet of stream bed."

c. **CZC Concurrence Granted Without Conditions**

The CZCs for NWPs 1, 2, 3, 4, 5, 6, 7, 8, 9, 10, 11, 13, 15, 18, 19, 20, 22, 25, 27, 28, 30, 31, 32, 33, 36, 37, 38, 40, 41, 45, 48 and 53 were granted without conditions.

d. **No CZC required**

Not applicable.

3. **Coastal Zone Consistency (CZC) General Condition**

The following CZC General Condition, as stated in the SCDHEC 401/CZC Letter dated December 14, 2020, is considered a 2021 NWP Regional Condition:

For all NWPs, "Activities in the Critical Areas (as defined in 48-39-10, R 30.1(D) and R 30.10) require a direct permit from SCDHEC OCRM. SCDHEC OCRM's action on direct critical areas permits will serve as the consistency determination for the critical area activity."

G. **DISTRICT POINT OF CONTACT**

Tracy D. Sanders
USACE- Charleston District
69A Hagood Avenue
Charleston, South Carolina 29403
843-329-8044
Tracy.d.sanders@usace.army.mil
SAC.RD.Charleston@usace.army.mil



October 5, 2022

Russell Cornette, Town of Summerville
200 S. Main Street
Summerville, SC 29483

Re: Certification in Accordance with Section 401 of the Clean Water Act, as amended and the Coastal Zone Management Program (48-39-10 et. seq., and 15 CFR 930)

Russell Cornette, Town of Summerville

Rumphs Hill Creek/Sawmill Branch
Dorchester County
P/N: SAC 2018-01003

Dear Sir or Madam:

The South Carolina Department of Health and Environmental Control (DHEC) has reviewed plans for this project and determined there is a reasonable assurance that the proposed project will be conducted in a manner consistent with the Certification requirements of Section 401 of the Federal Clean Water Act, as amended, and the Coastal Zone Management Act (48-39-10 et. seq., and 15 CFR 930).

In accordance with the provisions of Section 401, we certify that this project, subject to the indicated conditions, is consistent with applicable provisions of 303 of the Federal Clean Water Act, as amended. We also certify that there are no applicable effluent limitations under Sections 301(b) and 302, and that there are no applicable standards under Sections 306 and 307.

This certification is subject to the following conditions:

401 Water Quality Certification Conditions:

1. The applicant must implement best management practices that will minimize erosion and migration of sediments on and off the project site during and after construction. These practices should include the use of appropriate grading and sloping techniques, mulches, hay bales, silt fences, or other devices capable of preventing erosion, migration of sediments, and bank failure. All disturbed land surfaces and sloped areas affected by the project must be stabilized.
2. All necessary measures must be taken to prevent oil, tar, trash, debris and other pollutants from entering the adjacent waters or wetlands.
3. Only clean earthen material free of all potential sources of pollution may be used as fill in the aquatic impact area.
4. Areas proposed for clearing should be stabilized with a native vegetative cover and allowed to revegetate with natural wetland emergent or scrub-shrub vegetation where possible. Maintenance in these areas should be conducted via hand clearing rather

than with chemicals to reduce the potential for contamination and negative impacts on aquatic resources. If chemicals are used, a 50-foot buffer between wetlands should be established where no herbicide treatments would be allowed.

5. Prior to the initiation of wetland impacts, the applicant must mitigate for these impacts by purchasing 3.13 compensatory wetland mitigation credits from an approved mitigation bank and provide SCDHEC with proof of credit purchase prior to construction.

Coastal Zone Consistency Conditions:

1. In the event that any historic or cultural resources and/or archaeological materials are found during the course of work, the applicant must notify the State Historic Preservation Office and the South Carolina Institute of Archaeology and Anthropology. Historic and cultural resources consist of those sites listed in the National Register of Historic Places and those sites that are eligible for the National Register. Archaeological materials consist of any items, fifty years old or older, which were made or used by man. These items include, but are not limited to, stone project points (arrowheads), ceramic sherds, bricks, worked wood, bone and stone, metal and glass objects, and human skeletal material.
2. Mitigation for the impacts to 0.3 acres of wetlands will be provided through the purchase of 3.13 credits from an approved mitigation bank. The proof of purchase of the 3.13 mitigation credits must be submitted to the Department prior to beginning work on the project.
3. To prevent potential harm to the State endangered Rafinesque's big-eared bat (*Corynorhinus rafinesquii*), land clearing activities must be conducted during the inactive season (November 15th through March 31st). Should avoidance of clearing activities during this period of time not be feasible, then surveys for maternity roost trees and colonies must be performed.
4. A survey for maternity roost trees be performed prior to any clearing activity from April 1 through November 14th to avoid and minimize potential impacts. Suitable habitat includes that of black gum (*Nyssa sylvatica*) and water tupelo (*Nyssa aquatic*) stands, bald cypress (*Taxodium distichum*) swamp forests, maritime forests, and hardwood or mixed mature forested bottomlands (Cochran 1999, Hofmann et al. 1999, Lance et al. 2001, Gooding and Langford 2004, Trousdale and Beckett 2005). Trees standing 59 to 82 feet tall with large cavities, defined as 3.6 feet tall by 1.2 feet wide, should be surveyed to determine maternity roost occupancy May 1st to July 31st (Mirowsky 1998, Gooding and Langford 2004, Trousdale and Beckett 2005, Carver and Ashley 2008).
5. Please note Rafinesque's big-eared bat maternity colonies will utilize multiple maternity roost trees in an area (Gooding and Langford 2004, Trousdale and Beckett 2005, Johnson and Lacki 2011, Trousdale 2011); therefore, an avoidance window for disturbance and destruction from May 1st to July 31st for all large cavity trees (as

defined above) found within 1,000 feet of the occupied cavity tree should also be observed (Johnson et al. 2012).

6. In the event maternity colonies are found, the Department and SCDNR should be notified and an avoidance window for disturbance and destruction of roost trees from May 1st to July 31st should be followed.
7. All construction BMPs must be installed, inspected and maintained to hold sediment onsite and to protect any adjacent or downstream wetlands and waters through the life of the project. Upon completion of construction activities, all disturbed (includes undeveloped) areas, including those impacted for access, must be immediately stabilized.
8. The project must be fully consistent with local zoning and comprehensive plans prior to work being conducted.

DHEC reserves the right to impose additional conditions on this Certification to respond to unforeseen, specific problems that might arise and to take any enforcement action necessary to ensure compliance with State water quality standards.

Sincerely,

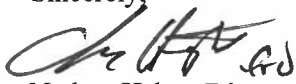

Nathan Haber, Director
Division of Water Quality
Bureau of Water

Permit Number: _____

Name of Permittee: _____

Date of Issuance: _____

Upon completion of the activity authorized by this permit and any mitigation required by the permit, sign this certification and return it to the following address:

U.S. Army Corps of Engineers
Regulatory Division
69A Hagood Avenue
Charleston, South Carolina 29403-5107

Please note that your permitted activity is subject to a compliance inspection by an U.S. Army Corps of Engineers representative. If you fail to comply with this permit you are subject to permit suspension, modification, or revocation.

=====

I hereby certify that the work authorized by the above referenced permit has been completed in accordance with the terms and conditions of the said permit, and required mitigation was completed in accordance with the permit conditions.

Signature of Permittee