

MULTI-SITE ROOF REPLACEMENT PROJECT CONTRACT

Multi-Site Roof Replacement Project (the “**Contract**”) is entered between the Village of Buffalo Grove (hereinafter the “**Village**” or “**Owner**”), an Illinois home-rule unit of government, and Filotto Roofing, Inc. an [Illinois Roofing Co.] (hereinafter the “**Contractor**”) on this 19 day of September, 2023 (the “**Effective Date**”). The Village and the Contractor are hereinafter sometimes collectively referred to as the “**Parties**” and individually as a “**Party**”.

RECITALS

WHEREAS, the Village has solicited bids for the Work (defined below), Contractor has submitted a bid for the Work and Village has selected Contractor for the Work based on their bid; and

WHEREAS, the Contractor wishes to enter into this Contract with the Village and the Village wishes to enter into this Contract with the Contractor for the Work;

NOW THEREFORE, for and in consideration of the mutual covenants and promises herein contained, the adequacy and sufficiency of which are hereby acknowledged by the Parties, it is agreed as follows:

ARTICLE I - WORK TO BE DONE BY THE CONTRACTOR

The Village does hereby hire and contract with the Contractor to provide all the labor, equipment, materials and/or services described more thoroughly on Contract **Exhibit A** (the “**Work**”) which is incorporated into the Contract by this reference.

ARTICLE II - CONTRACT DOCUMENTS

The following exhibits are attached hereto and incorporated herein by this reference:

- Contract Exhibit A – Description of the Work**
- Contract Exhibit B – Schedule of Prices**
- Contract Exhibit C – Performance Bond**
- Contract Exhibit D – Partial Lien Waiver**
- Contract Exhibit E – Final Lien Waiver**

If any term or provision of this Contract shall conflict with any term or provision of the exhibits referenced above, the terms and provisions of the exhibit shall control.

ARTICLE III - CONTRACT AMOUNT

The Village agrees to pay the Contractor for the proper and timely performance of the Work in strict accordance with this Contract as detailed in **Contract Exhibit B** (the “**Schedule of Prices**”) Unless explicitly provided otherwise in this Contract, the detailed sums shall be the full and exclusive compensation owed to the Contractor for the Work; and Contractor may not seek additional payments from the Village.

The Village of Buffalo Grove reserves the right to reject a proposed price increase and terminate the Contract.

ARTICLE IV – APPLICATION FOR PAYMENT

The Contractor shall be paid at most once a month and only after providing the Village the following:

1. An executed and notarized Contractor's Sworn Statement in a form similar to AIA G702 or AIA G703;
2. Either a partial or final lien waiver from every subcontractor, sub-subcontractor, or materialman in substantially the same form as attached here as **Contract Exhibit D** and **Contract Exhibit E**;
3. Certified payroll necessary for the Prevailing Wage Act; and

All payments under this Contract must be approved by the Village's Board at regularly scheduled meetings. The Village reserves the right to request any receipts, invoices, proof of payments as the Village, in its sole discretion, may deem necessary to justify the payment requested *prior* to paying the requested payment. The Contractor shall furnish with his final application for payment a Final Lien Waiver from itself and, if not already provided, from every subcontractor and materialman of the Work.

The Contractor acknowledges that the Village is a unit of local government and that all payments under the Contract are subject to the Local Government Prompt Payment Act, 50 ILCS 505 et seq. To that extent, the Village shall have forty-five calendar (45) days from receipt of a bill or invoice to pay the same before it is considered late under the Contract. Interest, if any, charged for any late payments will be subject to the interest rate caps specified in the Prompt Payment Act.

ARTICLE V – CONTRACT TIME

The Contractor shall fully, and not substantially, complete all the Work and the Work shall be accepted by the Director of Public Works, provided that acceptance by the Director of Public Works shall not be unreasonably delayed, on or before 2/2/2024 (**Timeframe noted in the schedule of prices "Construction Schedule"**)

If the Contractor shall fail to complete the work within the Contract Time which shall include any proper extension granted by the Village, the Contractor shall pay to the Village an amount equal to **Seven Hundred Fifty dollars (\$750)** per calendar day for each day past the Contract Time until final acceptance by the Village, as liquidated damages and not as a penalty.

Termination of Contract. The Contract may be terminated, in whole or in part, by either party if the other party substantially fails to fulfill its obligations under the Contract through no fault of the terminating party; or the Village may terminate the Contract, in whole or in part, for its convenience. However, no such termination may be affected unless the terminating party gives the other party: (1) not less than thirty (30) calendar days written notice by certified mail of intent to terminate, and (2) an opportunity for a meeting with the terminating party before termination.

ARTICLE VI – PERFORMANCE BOND

The Contractor shall provide the Village with a performance bond in substantially the same form as on **Contract Exhibit C** (the "**Performance Bond**") prior to Contractor beginning any Work and within 10 calendar days of the Notice of Award sent to the Contractor.

ARTICLE VII – ACCIDENT PREVENTION

The Contractor shall exercise every precaution at all times to protect itself, the property of the Village and the property of others. The safety provision of all applicable laws and ordinances shall be strictly observed by the Contractor at all times. Any practice deemed hazardous or dangerous by the Director of Public Works or his authorized representatives shall be immediately discontinued by the Contractor upon receipt of instructions from the Director of Public Works or his authorized representatives. To the fullest extent permitted by law, the Contractor shall be solely responsible for all safety-related matters.

ARTICLE VIII – INDEMNIFICATION

To the fullest extent permitted by law, the Contractor agrees to defend, pay on behalf of, indemnify, and hold harmless the Village, its elected and appointed officials, agents, employees and volunteers and others working on behalf of the Village against any and all claims, demands, suits or loss, including all costs connected therewith, and for any damages which may be asserted, claimed or recovered against or from the Village, its elected and appointed officials, agents, employees and volunteers and others working on behalf of the Village, by reason of personal injury, including bodily injury and death, and/or property damage, whether damage to property of the Village or of a third party, including loss of use thereof, which arises out of or is in any way connected or associated with the Contract and the Work.

ARTICLE IX – INSURANCE

Contractor shall procure and maintain, for the duration of the Contract and any maintenance period, insurance against claims for injuries to persons or damages to property, which may arise from or in connection with the performance of the work hereunder by the Contractor, his agents, representatives, employees or subcontractors.

A. Minimum Scope of Insurance: Coverage shall be at least as broad as:

Insurance Services Office Commercial General Liability occurrence form CG 0001 with the Village of Buffalo Grove named as additional insured on a primary and non-contributory basis. This primary, non-contributory additional insured coverage shall be confirmed through the following required policy endorsements: ISO Additional Insured Endorsement CG 20 10 or CG 20 26 and CG 20 01 04 13

1. Insurance Services Office Commercial General Liability occurrence form CG 0001 with the Village named as additional insured, on a form at least as broad as the ISO Additional Insured Endorsement CG 2010 and CG 2026
2. Insurance Service Office Business Auto Liability coverage form number CA 0001, Symbol 01 "Any Auto."
3. Workers' Compensation as required by the Labor Code of the State of Illinois and Employers' Liability insurance.
4. Owners and Contractors Protective Liability (OCP) policy with the Village of Buffalo Grove as insured.
5. Builder Risk Property Coverage with Village as loss payee

B. Minimum Limits of Insurance: Contractor shall maintain limits no less than:

1. Commercial General Liability: \$1,000,000 combined single limit per occurrence for bodily injury, personal injury and property damage. The general aggregate shall be twice the required occurrence limit. Minimum General Aggregate shall be no less than \$2,000,000 or a project/contract specific aggregate of \$1,000,000.
2. Business Automobile Liability: \$1,000,000 combined single limit per accident for bodily injury and property damage.
3. Workers' Compensation and Employers' Liability: Workers' Compensation coverage with statutory limits and Employers' Liability limits of \$500,000 per accident.
4. Owners and Contractors Protective Liability (OCP): \$1,000,000 combined single limit per occurrence for bodily injury and property damage.
5. Builder's Risk: Shall insure against "All Risk" of physical damage, including water damage (flood and hydrostatic pressure not excluded), on a completed replacement cost basis.

C. Deductibles and Self-Insured Retentions

Any deductibles or self-insured retentions must be declared to and approved by the Village. At the option of the Village, either: the insurer shall reduce or eliminate such deductibles or self-insured retentions as it respects the Village, its officials, agents, employees and volunteers; or the Contractor shall procure a bond guaranteeing payment of losses and related investigation, claim administration and defense expenses.

D. Other Insurance Provisions

The policies are to contain, or be endorsed to contain, the following provisions:

1. General Liability and Automobile Liability Coverages:
 - a. The Village, its officials, agents, employees and volunteers are to be covered as insureds as respects: liability arising out of activities performed by or on behalf of the Contractor; products and completed operations of the Contractor; premises owned, leased or used by the Contractor; or automobiles owned, leased, hired or borrowed by the Contractor. The coverage shall contain no special limitations on the scope of protection afforded to the Village, its officials, agents, employees and volunteers.
2. The Contractor's insurance coverage shall be primary and non-contributory as respects the Village, its officials, agents, employees and volunteers. Any insurance or self-insurance maintained by the Village, its officials, agents, employees and volunteers shall be excess of Contractor's insurance and shall not contribute with it.
3. Any failure to comply with reporting provisions of the policies shall not affect coverage provided to the Village, its officials, agents, employees and volunteers.
4. The Contractor's insurance shall contain a Severability of Interests/Cross Liability clause or language stating that Contractor's insurance shall apply separately to each insured against whom claim is made or suit is brought, except with respect to the limits of the insurer's liability.
5. If any commercial general liability insurance is being provided under an excess or umbrella liability policy that does not "follow form," then the Contractor shall be required to name the Village, its officials, employees, agents and volunteers as additional insureds
6. All general liability coverages shall be provided on an occurrence policy form. Claims-made general liability policies will not be accepted.
7. The contractor and all subcontractors hereby agree to waive any limitation as to the amount of contribution recoverable against them by the Village. This specifically includes any limitation imposed by any state statute, regulation, or case law including any Workers' Compensation Act provision that applies a limitation to the amount recoverable in contribution such as Kotecki v. Cyclops Welding.

E. All Coverages:

1. No Waiver. Under no circumstances shall the Village be deemed to have waived any of the insurance requirements of this Contract by any act or omission, including, but not limited to:
 - a. Allowing work by Contractor or any subcontractor to start before receipt of Certificates of Insurance and Additional Insured Endorsements.
 - b. Failure to examine, or to demand correction of any deficiency, of any Certificate of Insurance and Additional Insured Endorsement received.
2. Each insurance policy required shall have the Village expressly endorsed onto the policy as a Cancellation Notice Recipient. Should any of the policies be cancelled before the expiration date thereof, notice will be delivered in accordance with the policy provisions.

F. Acceptability of Insurers

Insurance is to be placed with insurers with a Best's rating of no less than A-, VII and licensed to do business in the State of Illinois.

G. Verification of Coverage

Contractor shall furnish the Village with certificates of insurance naming the Village, its officials, agents, employees, and volunteers as additional insured's and with original endorsements, affecting coverage required herein. The certificates and endorsements for each insurance policy are to be signed by a person authorized by that insurer to bind coverage on its behalf. The certificates and endorsements are to be received and approved by the Village before any work commences. The Village reserves the right to request full certified copies of the insurance policies and endorsements.

The Certificate of Insurance shall state the Village of Buffalo Grove has been endorsed as an "additional insured" by the Vendor's insurance carrier. Specifically, this Certificate must include the following language: **"The Village of Buffalo Grove, and it's respective elected and appointed officials, employees, agents, consultants, attorneys and representatives, are, and have been endorsed, as an additional insured under the above reference policy number _____ on a primary and non-contributory basis for general liability and automobile liability coverage for the duration of the agreement term."**

H. Subcontractors

Contractor shall include all subcontractors as insured's under its policies or shall furnish separate certificates and endorsements for each subcontractor. All coverage's for subcontractors shall be subject to all of the requirements stated herein.

I. Assumption of Liability

The contractor assumes liability for all injury to or death of any person or persons including employees of the contractor, any subcontractor, any supplier or any other person and assumes liability for all damage to property sustained by any person or persons occasioned by or in any way arising out of any work performed pursuant to the Contract.

J. Workers' Compensation and Employers' Liability Coverage

The insurer shall agree to waive all rights of subrogation against the Village of Buffalo Grove, its officials, employees, agents and volunteers for losses arising from work performed by Contractor for the municipality.

K. Failure to Comply

In the event the Contractor fails to obtain or maintain any insurance coverage's required under this contract, The Village may purchase such insurance coverage's and charge the expense thereof to the Contractor.

ARTICLE X – CERTIFICATE OF AUTHORITY AND SURETY CERTIFICATE

The Contractor shall furnish the Village with a current Certificate of Authority or Surety Certificate issued by the Illinois Department of Insurance for the bonding company and insurance company they are using. In lieu of a Certificate of Authority or Surety Certificate, the Contractor may provide certificate of good standing from the Illinois Department of Insurance's website.

ARTICLE XI – COPYRIGHTS AND LICENSES

The Contractor agrees that all documents of any kind whatsoever, and in whatever medium expressed, prepared by the Contractor and the Contractor's consultants in connection with the Work (collectively, the "**Documents**") or otherwise pursuant to this Contract and all rights therein (including trademarks, trade names, rights or use, copyrights and/or other proprietary rights) shall be and remain the sole property of the Village (regardless of whether the Village or the Contractor terminates this Contract for any reason whatsoever). The Contractor hereby agrees that the Documents are or shall be deemed to be "Works for Hire" within the meaning of Section 101 of the Copyright Act, and the Contractor hereby assigns to the Village all right, title and interest therein. Notwithstanding, the Contractor shall indemnify and hold harmless the Village, its appointed and elected officials, employees, agents and volunteers from and against all claims, damages, losses, and expenses (including attorneys' fees and court and arbitration costs) arising out of any infringement of patent rights or copyrights incident to the Documents and the Work.

ARTICLE XII – NOTICE

All notices, demands, requests, consents, approvals and other communications required or permitted to be given hereunder (a “**Notice**”) shall be in writing and shall be deemed effective three (3) business days after mailing if mailed by certified mail with return receipt requested and immediately if served personally, and shall be addressed to the following:

IF TO THE VILLAGE: Village of Buffalo Grove
51 Raupp Blvd
Buffalo Grove, IL 60089
ATTN: Director of Public Works

IF TO THE CONTRACTOR: Filotto Roofing, Inc.
2111 OAKLAND AVE.
CREST HILL, IL 60403
ATTN: KEVIN FILOTTO

ARTICLE XIII – CHANGE ORDERS

If the Village requests any change to the Work the Village shall do so by delivering Notice of the same to the Contractor and the change requested by the Village shall be effective upon receipt of the Notice by the Contractor. The Contractor may propose a change to the Work by delivering Notice of the proposed change along with a description of the changes full effect on the Work to the Village; provided, such requested change shall not be deemed accepted until the Village has delivered to the Contractor Notice of the same. Prior to approving a proposed change to the Work by the Contractor, the Village may request such additional documentation as it deems necessary to investigate the proposed change. The Contractor shall be responsible for informing all its employees and subcontractors of any changes to the Work, whether such change is requested by the Contractor or the Village.

ARTICLE XIV – NOTICE OF STARTING WORK

The Contractor shall provide Notice to the Village prior to the Contractor, or its employees or subcontractors, starting the Work or any phase of the Work.

ARTICLE XV – SEQUENCE OF THE WORK

The Director of Public Works shall have the power to direct the order and sequence of the Work. On any major portion of the Work, all accessories shall be set coincident with the main construction. Payment for major portions of the Work may be withheld until proper completion of accessories.

ARTICLE XVI – SUPERVISION

The Director of Public Works shall have override power to superintend and direct the Work, and the Contractor shall perform all of the Work herein specified to the satisfaction, approval and acceptance of the Director of Public Works. The Contractor shall have at all times a competent foreman or superintendent at the Work's site, who shall have full authority to act for the Contractor and to receive and execute orders from the Director of Public Works, and any instructions given to such superintendent or person, executing work for the Contractor, shall be binding on the Contractor as though it was personally given to the Contractor.

ARTICLE XVII – STANDARD OF WORK AND WORKERS

The Contractor shall employ competent staff and shall discharge, at the request of the Director of Public Works, any incompetent, unfaithful, abusive or disorderly workers in its employ. Where experts or skilled workers must be employed, only expert or skilled workers shall be employed.

ARTICLE XVIII – CONDITIONS OF THE WORK SITE

The Contractor shall provide and maintain such sanitary accommodations for the use of its employees as may be necessary to comply with the State and local Board of Health requirements. Public nuisances will not be permitted. The Contractor shall leave said Work's site(s) in the best possible condition to the complete satisfaction of the Director of Public Works. No vehicles of any kind shall be placed, parked, or operated upon any grass areas at any time except as authorized by the Director of Public Works or his authorized representative. Further, the Contractor shall exercise every precaution for the protection of all persons and all property. The safety provisions of all-applicable laws and ordinances shall be strictly observed. Any practice hazardous in the opinion of the Director of Public Works or his authorized representatives shall be immediately discontinued by the Contractor upon his receipt of instructions from the Director of Public Works or his authorized representative. To the maximum extent permitted by law, the Contractor shall be responsible for all safety-related matters.

ARTICLE XIX – WARRANTY PERIOD

All material and workmanship shall be warranted and guaranteed according to manufacturer's recommendation after inspection and approval by the Director of Public Works or his designated representative. All work performed by the Contractor shall be warranted by the Contractor following completion and final acceptance of the Work for a period of twenty four (24) months from the date of final, and not substantial, completion.

ARTICLE XX – ACCIDENTS

In the event of any accident of any kind that involves the general public or property of the Village or a third party, the Contractor shall immediately notify the Director of Public Works by phone as well as provide Notice of the same. The Notice shall include a full accounting of all details of the accident. The Contractor shall furnish the Village with copies of all reports of such accidents at the same time that the reports are forwarded to any other interested parties.

ARTICLE XXI – NO ASSIGNMENT

If the Contractor sublets or assigns any part of the Work then the Contractor shall not under any circumstances be relieved of its liabilities hereunder. All transactions of the Village shall be with the Contractor. Subcontractors shall be recognized only in the capacity of employees or workmen and shall be subject to the same requirements as to character and competence. The Contractor shall not assign, transfer, convey, sell or otherwise dispose of the whole or any part of this Contract to any person, firm or corporation without written consent of the Director of Public Works or his authorized representative.

ARTICLE XXII – DEFAULT

The following shall constitute a default an “**Event of Default**” by the Contractor under this Contract:

- A. If the Contractor shall fail to strictly observe or perform one or more of the terms, conditions, covenants and agreements of this Contract;
- B. If there shall be placed on any property owned by the Village any mechanics’, materialmens’ or suppliers’ lien;
- C. If there shall be instituted any proceeding against the Contractor seeking liquidation, dissolution or similar relief and the same shall not be dismissed within forty-five (45) calendar days;
- D. If there shall be appointed any trustee, receiver or liquidator of the Contractor and such appointment shall not have been vacated within forty-five (45) calendar days; and
- E. If the Contractor fails to maintain or obtain any and all permits, licenses and the like, if any, required by the Village, State or Federal governments for the Work.

Upon any Event of Default the Village shall have the option of (i) terminating the Contract; (ii) pursuing any remedy available to it at law or in equity; or (iii) pursuing both simultaneously. In addition, upon an Event of Default, the Village may withhold payments due to the Contractor until it has hired a replacement of the Contractor and deducted all costs of hiring a replacement.

ARTICLE XXIII – DELAYS

The Contractor shall not be liable in damages for delays in performance when such delay is the result of fire, flood, strike, acts of God, or by any other circumstances which are beyond the control of the Contractor; provided, however, under such circumstances the Village may, at its option, cancel the Contract.

ARTICLE XXIV – COMPLIANCE WITH LAWS

The Contractor shall comply with all applicable laws, regulations and rules promulgated by any federal, state, local, or other governmental authority or regulatory body pertaining to all aspects of the Work, now in effect, or which may become in effect during the performance of the Work. The scope of the laws, regulations, and rules referred to in this paragraph includes, but is in no way limited to, the Illinois Human Rights Act, Illinois Equal Pay Act of 2003, Occupational Safety & Health Act along with the standards and regulations promulgated pursuant thereto (including but not limited to those safety requirements involving work on elevated platforms), all forms of traffic regulations, public utility, Interstate and Intrastate Commerce Commission regulations, Workers’ Compensation Laws, Public Construction Bond Act, Public Works Preference Act, Employment of Illinois Workers

on Public Works Act, USA Security Act, federal Social Security Act (and any of its titles), and any other law, rule or regulation of the Illinois Department of Labor, Department of Transportation, Illinois Environmental Protection Act, Illinois Department of Natural Resources, Illinois Department of Human Rights, Human Rights Commission, EEOC, and the Village of Buffalo Grove. Notwithstanding the following, the Contractor shall particularly note that:

A. NO DISCRIMINATION – The Contractor shall comply with the provisions of the Illinois Public Works Employment Discrimination Act and the Illinois Human Rights Act/Equal Opportunity Clause which, pursuant to Illinois law, are deemed to be part of this Contract.

B. FREEDOM OF INFORMATION - The Contractor agrees to furnish all documentation related to the Contract, the Work and any documentation related to the Village required under an Illinois Freedom of Information Act (ILCS 140/1 et. seq.) (“FOIA”) request within five (5) calendar days after the Village issues Notice of such request to the Contractor. The Contractor agrees to defend, indemnify and hold harmless the Village, and agrees to pay all reasonable costs connected therewith (including, but not limited to attorney’s and witness fees, filing fees and any other expenses) for the Village to defend any and all causes, actions, causes of action, disputes, prosecutions, or conflicts arising from Contractor’s actual or alleged violation of FOIA or the Contractor’s failure to furnish all documentation related to a FOIA request within five (5) calendar days after Notice from the Village for the same. Furthermore, should the Contractor request that the Village utilize a lawful exemption under FOIA in relation to any FOIA request thereby denying that request, Contractor agrees to pay all costs connected therewith (such as attorneys' and witness fees, filing fees and any other expenses) to defend the denial of the request. This defense shall include, but not be limited to, any challenged or appealed denials of FOIA requests to either the Illinois Attorney General or a court of competent jurisdiction.

C. ILLINOIS WORKERS ON PUBLIC WORKS ACT - To the extent applicable, the Contractor shall comply with the Illinois Workers on Public Works Act, 30 ILCS 570/1 et seq., and shall provide to the Village any supporting documentation necessary to show such compliance.

D. NOT A BLOCKED PERSON - The Contractor affirms and covenants that neither the Contractor nor any individual employed by the Contractor for this Work or under this Contract is a person forbidden from doing business with a unit of local government under Executive Order No. 13224 (Sept 23, 2001), 66 Fed.Reg. 49,079 (Sept 23, 2001) or is a person registered on the Specially Designated Nationals and Blocked Persons List. The Contractor shall indemnify the Village from all costs associated with failure to comply with this paragraph.

E. SUBSTANCE ABUSE PREVENTION ON PUBLIC WORKS ACT - The Contractor knows, understands and acknowledges its obligations under the Substance Abuse Prevention on Public Works Act (820 ILCS 265/1 et seq.), and shall comply and require all subcontractors and lower tiered contractors to comply with the requirements and provisions thereof.

F. PREVAILING WAGE ACT - The Village is an Illinois unit of local government and the Work hereunder is subject to the Illinois Prevailing Wage Act, 820 ILCS 130/0.01, etseq.

Pursuant to PA 100-1177 the Illinois Department of Labor (IDOL) has activated an electronic database (Payroll Portal) capable of accepting and retaining certified payrolls submitted under the State of Illinois Prevailing Wage Act (820 ILCS/130/1). All contractors and subcontractors completing work for the Village of Buffalo Grove pursuant to the Act must submit all certified payroll through the IDOL Payroll Portal.

Consequently, the Contractor and each subcontractor shall submit with their application for payment(s) the email certification received from their IDOL Payroll Portal submittal with each of their pay requests. Any delay in processing the payments due to a lack of aforementioned email certification shall not be an event of default by the Village and shall not excuse any delay by the Contractor who shall proceed with the Work as if no delay in payment has occurred. The Contractor and Village shall agree to take any further steps not outlined above to ensure compliance with the Prevailing Wage Act. Upon two business days’ Notice, the Contractor and each subcontractor shall make available to the Village their records to confirm compliance with the Prevailing Wage

Act. Finally, to ensure compliance with Prevailing Wage Act, the Contractor and each subcontractor shall keep for a period of not less than 5 years after the Work has been completed records of all laborers, mechanics, and other workers employed by them for the Work; the records shall include each worker's name, address, telephone number, classification or classifications, the hourly wages paid in each period, the number of hours worked each day, the starting and ending times of work each day and, when available, last four digits of the social security number.

Current rates can be located on the Illinois Department of Labor website.

<https://www2.illinois.gov/idol/Laws-Rules/CONMED/Pages/Rates.aspx>

ARTICLE XXV – NO WAIVER OF RIGHTS

A waiver by the Village of any Event of Default or any term of provision of this Contract shall not be a waiver of the same Event of Default, another Event of Default or any other term or provision of this Contract.

ARTICLE XXVI – CONTROLLING LAW AND VENUE

This Contract is entered into in the State of Illinois, for work to be performed in the State of Illinois and shall be governed by and construed in accordance with the laws of the State of Illinois. Any legal matters or dispute shall be resolved in the Circuit Court of Cook County and the Parties hereby submit to the jurisdiction of such Circuit Court. This Contract shall be construed without regard to any presumption or other rule requiring construction against the Party causing the Contract to be drafted.

ARTICLE XXVII – MISCELLANEOUS

- A. AMENDMENT** – This Contract may be amended only in writing executed by both Parties.
- B. NO RECORDING** – This Contract, or a memorandum thereof, may not be recorded in any form by either Party. If either Party records this Contract, or a memorandum thereof, they shall immediately file a release of the same.
- C. COUNTERPARTS** – This Contract may be executed by the Parties in any any number of counterparts, each of which shall be deemed an original, but all of which together shall constitute an original instrument.
- D. SECTION HEADINGS** – The headings in the Contract are intended for convenience only and shall not be taken into consideration in any construction or interpretation of the Contract.
- E. NO THIRD-PARTY BENEFICIARIES** – This Contract does not confer any rights or benefits on any third party.
- F. BINDING EFFECT** – This Contract shall be binding and inure to the benefit of the Parties hereto, their respective legal representatives, heirs and successors-in-interest.
- G. ENTIRE AGREEMENT** – This Contract supersedes all prior agreements and understandings and constitutes the entire understanding between the Parties relating to the subject matter hereof.
- H. SEVERABILITY** - If any term, condition or provision of the Contract is adjudicated invalid or unenforceable, the remainder of the Contract shall not be affected and shall remain in full force and effect, to the fullest extent permitted by law.

- I. **TORT IMMUNITY DEFENSES** - Nothing contained in this Contract is intended to constitute nor shall constitute a waiver of the rights, defenses, and immunities provided or available to the Village under the Local Governmental and Governmental Employees Tort Immunity Act, 745 ILCS 10 *et seq.*
- J. **CALENDAR DAYS AND TIME.** Unless otherwise provided in this Contract, any reference in this Contract to "day" or "days" shall mean calendar days and not business days. If the date for giving of any notice required to be given, or the performance of any obligation, under this Contract falls on a Saturday, Sunday or federal holiday, then the notice or obligation may be given or performed on the next business day after that Saturday, Sunday or federal holiday.
- K. **COUNTERPARTS** – This Contract may be executed by the Parties in any number of counterparts, each of which shall be deemed an original, but all of which together shall constitute an original instrument.

IN WITNESS WHEREOF, the Parties hereto have caused the Contract to be executed as of the Effective Date.

Village of Buffalo Grove,
an Illinois home-rule unit of government

By: 
Name: Dane Bragg
Title: Village Manager

Company Filotto Roofing, Inc.
[An Illinois Roofing company]

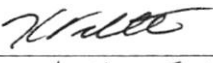
By: 
Name: KEVIN FILOTTO
Title: Vice President

CONTRACT EXHIBIT C – PERFORMANCE BOND
FORM OF PERFORMANCE BOND

Bond Number: 2554435

KNOW ALL MEN BY THESE PRESENTS, That Filotto Roofing, Inc. (the “**Principal**”) and West Bend Mutual Insurance Company (the “**Surety**”), are held and firmly bound unto the Village of Buffalo Grove, an Illinois home-rule unit of government (the “**Village**”), the full and just sum of Seventy-Four Thousand Four Hundred Dollars and 00/100 (\$ 74,400.00) in lawful money of the UNITED STATES OF AMERICA as herein provided.

THE CONDITION OF THIS OBLIGATION is such that the Principal and Surety agree to bind themselves, their successors, assigns, executors, heirs and administrators, jointly and severally, for the full and faithful performance of the Work as defined in that particular Multi Site Roof Replacement Project contract between Principal and the Village dated 19th day of September, 2023, (hereinafter referred to as the “**Contract**”), a copy of which is attached and incorporated by reference as though fully set forth herein.

NOW THE CONDITIONS OF THIS OBLIGATION ARE SUCH that if the said Principal (i) shall in all respects keep and perform all the undertakings, covenants, terms, conditions and agreements of the Contract; (ii) shall pay all sums of money due or to become due, for any labor, materials, apparatus, fixtures or equipment furnished for the Work provided in said Contract; and (iii) shall remove and replace any defects in workmanship or materials which may be apparent or may develop within the ARTICLE XIX – WARRANTY PERIOD of the Contract, then this obligation shall be null and void; otherwise it shall remain in full force and effect.

And the said Surety, for value received, hereby stipulates and agrees that no change, extension of time, alteration or addition to the terms of the Contract or the Work thereunder shall in any way affect its obligation on this Bond, and it does hereby waive notice of any such change, extension of time, alteration or addition to the terms of the Contract or to the Work.

IN WITNESS WHEREOF, we have hereunto set our hands and sea 19th day of September 2023.

SURETY - West Bend Mutual Insurance Company

PRINCIPAL - Filotto Roofing, Inc.

By: Rachel Hernandez
Name: Rachel Hernandez
Title: Attorney-in-Fact

By: Kevin Filotto
Name: KEVIN FILOTTO
Title: VICE PRESIDENT

ATTEST

ATTEST

By: Donna Dorman
Donna Dorman

By: Marie T. Gutierrez
MARIE T. GUTIERREZ

NOTE: Date of Bond must not be prior to date of Contract.
If Contractor is Partnership, all partners should execute Bond.
IMPORTANT: Surety companies executing Bonds must appear on the Treasury Departments most current list (Circular 570 as amended) and be authorized to transact business in the state where the Work is located.

ss

STATE OF ILLINOIS

COUNTY OF DuPage

I, Ann Marie Waters Notary Public of Cook County, in the State of Illinois do hereby certify that Rachel Hernandez Attorney-in-Fact, of the West Bend Mutual Insurance Company who is personally known to me to be the same person whose name is subscribed to the foregoing instrument, appeared before me this day in person, and acknowledged that she signed, sealed and delivered said instrument, for and on behalf of the West Bend Mutual Insurance Company for the used and purposes therein set forth.

Given under my hand and notarial seal at my office in the City of Naperville in said County, this 19th day of September A.D., 2023.

Ann Marie Waters

(Notary Public)

Ann Marie Waters

My Commission expires: 07/05/2025

Notary Seal:

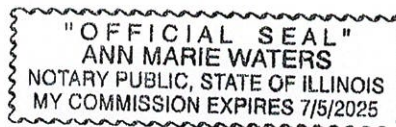



THE SILVER LINING®

Bond No. 2554435

POWER OF ATTORNEY

Know all men by these Presents, That West Bend Mutual Insurance Company, a corporation having its principal office in the City of West Bend, Wisconsin does make, constitute and appoint:

Rachel Hernandez

lawful Attorney(s)-in-fact, to make, execute, seal and deliver for and on its behalf as surety and as its act and deed any and all bonds, undertakings and contracts of suretyship, provided that no bond or undertaking or contract of suretyship executed under this authority shall exceed in amount the sum of:

Twenty Million Dollars (\$20,000,000)

This Power of Attorney is granted and is signed and sealed by facsimile under and by the authority of the following Resolution adopted by the Board of Directors of West Bend Mutual Insurance Company at a meeting duly called and held on the 21st day of December, 1999.

Appointment of Attorney-In-Fact. The president or any vice president, or any other officer of West Bend Mutual Insurance Company may appoint by written certificate Attorneys-In-Fact to act on behalf of the company in the execution of and attesting of bonds and undertakings and other written obligatory instruments of like nature. The signature of any officer authorized hereby and the corporate seal may be affixed by facsimile to any such power of attorney or to any certificate relating therefore and any such power of attorney or certificate bearing such facsimile signatures or facsimile seal shall be valid and binding upon the company, and any such power so executed and certified by facsimile signatures and facsimile seal shall be valid and binding upon the company in the future with respect to any bond or undertaking or other writing obligatory in nature to which it is attached. Any such appointment may be revoked, for cause, or without cause, by any said officer at any time.

In witness whereof, the West Bend Mutual Insurance Company has caused these presents to be signed by its president undersigned and its corporate seal to be hereto duly attested by its secretary this 17th day of August, 2021.

Attest Christopher C. Zwygart
Christopher C. Zwygart
Secretary



Kevin A. Steiner
Chief Executive Officer/President

State of Wisconsin
County of Washington

On the 17th day of August, 2021, before me personally came Kevin A. Steiner, to me known being by duly sworn, did depose and say that he resides in the County of Washington, State of Wisconsin; that he is the President of West Bend Mutual Insurance Company, the corporation described in and which executed the above instrument; that he knows the seal of the said corporation; that the seal affixed to said instrument is such corporate seal; that it was so affixed by order of the board of directors of said corporation and that he signed his name thereto by like order.



Matthew E. Carlton
Senior Corporate Attorney
Notary Public, Washington Co., WI
My Commission is Permanent

The undersigned, duly elected to the office stated below, now the incumbent in West Bend Mutual Insurance Company, a Wisconsin corporation authorized to make this certificate, Do Hereby Certify that the foregoing attached Power of Attorney remains in full force effect and has not been revoked and that the Resolution of the Board of Directors, set forth in the Power of Attorney is now in force.

Signed and sealed at West Bend, Wisconsin this 19th day of September, 2023.



Heather Dunn
Vice President - Chief Financial Officer

Notice: Any questions concerning this Power of Attorney may be directed to the Bond Manager at West Bend Mutual Insurance Company.

CONTRACT EXHIBIT D – PARTIAL LIEN WAIVER

PARTIAL LIEN WAIVER

STATE OF ILLINOIS

COUNTY OF _____

TO WHOM IT MAY CONCERN:

WHEREAS the undersigned has been employed by _____ to furnish _____ for the premises known as _____ of which _____ is the owner. THE undersigned, for and in consideration of \$ _____

) Dollars, and other good and valuable considerations, the receipt whereof is hereby acknowledged, do(es) hereby waive and release any and all lien or claim of, or right to, lien, under the statutes of the State of Illinois, relating to mechanics' liens, with respect to and on said above-described premises, and the improvements thereon, and on the material, fixtures, apparatus or machinery furnished, and on the moneys, funds or other considerations due or to become due from the owner, on account of all labor, services, material, fixtures, apparatus or machinery, furnished to this date by the undersigned for the above-described premises, INCLUDING EXTRAS.*

DATE _____ COMPANY NAME _____ ADDRESS _____ SIGNATURE AND TITLE _____

*EXTRAS INCLUDE BUT ARE NOT LIMITED TO CHANGE ORDERS, BOTH ORAL AND WRITTEN, TO THE CONTRACT

CONTRACTOR'S AFFIDAVIT

STATE OF ILLINOIS

COUNTY OF _____

TO WHOM IT MAY CONCERN:

THE UNDERSIGNED, (NAME) _____ BEING DULY SWORN, DEPOSES AND SAYS THAT HE OR SHE IS (POSITION) _____ OF (COMPANY NAME) _____ WHO IS THE CONTRACTOR FURNISHING _____ WORK ON THE BUILDING LOCATED AT _____ OWNED BY _____

That the total amount of the contract including extras* is \$ _____ on which he or she has received payment of \$ _____ prior to this payment. That all waivers are true, correct and genuine and delivered unconditionally and that there is no claim either legal or equitable to defeat the validity of said waivers. That the following are the names and addresses of all parties who have furnished or delivered material or labor, or both, for said work and all parties having contracts or sub contracts for specific portions of said work or for material entering into the construction thereof and the amount due or to become due to each, and that the items mentioned include all labor and material required to complete said work according to plans and specifications:

Table with 6 columns: NAMES AND ADDRESSES, WHAT FOR, CONTRACT PRICE (INCLUDE EXTRAS)*, AMOUNT PAID, THIS PAYMENT, BALANCE DUE. Includes a total row for labor and material.

That there are no other contracts for said work outstanding, and that there is nothing due or to become due to any person for material, labor or other work of any kind done or to be done upon or in connection with said work other than above stated.

DATE _____ SIGNATURE: _____ SUBSCRIBED AND SWORN TO BEFORE ME THIS _____ DAY OF _____

*EXTRAS INCLUDE BUT ARE NOT LIMITED TO CHANGE ORDERS, BOTH ORAL AND WRITTEN, TO THE CONTRACT.

NOTARY PUBLIC

CONTRACT EXHIBIT A – DESCRIPTION OF THE WORK

[Description of the Work]



IRS

Industrial Roofing Services, Inc.

13000 West Silver Spring Drive

Butler, Wisconsin 53007

Phone: (262) 432-0500

Fax: (262) 432-0504

www.irsroof.com

TECHNICAL SPECIFICATIONS

for

MULTI-SITE ROOF REPLACEMENT PROJECT

FOUR (4) SEPARATE BUILDINGS

IRS JOB# 18190

Located in

BUFFALO GROVE, ILLINOIS

Prepared for

Mr. Nickelos Smith
Building Maintenance Manager

Village of Buffalo Grove
50 Raupp Boulevard
Buffalo Grove, IL 60089

June 26, 2023

TABLE OF CONTENTS

DIVISION 00 – Procurement and Contracting Requirements	Pages To
00 21 13 – Special Instructions to Bidders	2
DIVISION 1 - General Requirements	Pages To
01 11 00 – Summary of Work.....	3
01 25 00 – Applications for Payment.....	2
01 30 00 – Alternates, Allowances and Substitutions.....	3
01 31 19 – Project Meetings	2
01 33 00 – Submittal Procedures.....	2
01 40 00 – Quality Control	2
01 50 00 – Site Conditions and Controls.....	3
01 60 00 – Materials and Equipment.....	2
01 70 00 – Contract Close-out and Warranties	2
01 74 29 – Grounds Repair.....	5
DIVISION 6 - Wood and Plastic	Pages To
06 10 53 – Miscellaneous Rough Carpentry	3
DIVISION 7 - Thermal and Moisture Protection	Pages To
07 31 13 – Fiberglass-Reinforced Asphalt Shingles.....	9
07 62 00 – Sheet Metal Flashing and Trim	7

APPENDICES

DRAWINGS:

- A0 - COVER SHEET
- A4.0 - 511 N. ARLINGTON - ROOF SPECIFICATION
- A4.1 - 345 ARLINGTON - ROOF SPECIFICATION
- A4.2 - 525 N. ARLINGTON - ROOF SPECIFICATION
- A4.3 - 109 DEERFIELD - ROOF SPECIFICATION
- A5.0 - ROOF LAYOUTS
- A6.0 - PERIMETER DETAILS
- A6.1 - PERIMETER DETAILS
- A7.0 - TYPICAL DETAILS
- A8.0 - PENETRATION DETAILS
- A8.1 - PENETRATION DETAIL
- A9.0 - SHEET METAL DETAILS

- END OF TABLE OF CONTENTS -

SPECIAL INSTRUCTIONS TO BIDDERS

PART 1 - GENERAL

1.01 EXAMINATION OF CONTRACT DOCUMENTS AND SITE CONDITIONS

- A. Each Bidder is responsible for the following:
1. Careful and diligent review by a competent person of each part of the Contract Documents, including the Divisions of the Specifications and parts of the Drawings that are not directly applicable to the Work on which the Bidder is submitting its bid. By submitting its bid, each Bidder represents and agrees, based upon its careful and diligent review of the Contract Documents, that it is not aware of any conflicts, inconsistencies, errors or omissions in the Contract Documents for which it has not notified the Design Professional in writing at least 7 days prior to the bid opening. If there are any such conflicts, inconsistencies, errors or omissions in the Contract Documents, the Bidder (i) will provide the labor, equipment or materials of the better quality or greater quantity of Work; and/or (ii) will comply with the more stringent requirements. The Bidder will not be entitled to any additional compensation for any conflicts, inconsistencies, errors or omissions that would have been discovered by such careful and diligent review, unless it has given prior written notice to Design Professional
 2. Careful and diligent inspection and examination by a competent person of the entire site and the surrounding area, including all parts of the site applicable to the Work for which it is submitting its bid, including location, condition and layout of the site and the location of utilities, and carefully correlate the results of the inspection with the requirements of the Contract Documents. The Bidder's bid must include all costs attributable to site and surrounding area conditions that would have been discovered by such careful and diligent inspection and examination of the site and the surrounding area, and the Bidder will not be entitled to any Change Order, additional compensation, or additional time on account of such conditions.
 3. Be familiar with the existing conditions in the material and labor markets, as well as the conditions related to the Work. The fact that a bid is submitted will be construed by the Owner as an agreement by the Bidder to carry out the improvements in full conformance with the Specifications and other Contract Documents, notwithstanding the existing conditions.
 4. Attend the pre-bid meeting; if applicable. Failure of a Bidder to attend the pre-bid meeting, if such failure results in the Bidder not fully being familiar with the existing conditions and Project Requirements, shall not be considered a basis for additional compensation to the successful Bidder for the Work.

1.02 EXAMINATION

- A. Each bidder shall visit and carefully examine the proposed work and fully acquaint themselves with conditions relating to construction and labor so that they may fully understand the facilities, difficulties and restrictions attending the execution of the work included under the Contract.
- B. Bidders shall thoroughly examine and be familiar with the drawings, specifications and other contract documents.
- C. Should a bidder find discrepancies in or omissions from the drawings or documents, or should he be in doubt as to their meaning, he shall at once notify the Consultant, at least five (5) days before bids are due, who will send written instructions in the form of an addendum to all bidders. Neither the Owner nor the Consultant will be responsible for any oral instructions.
- D. It is the responsibility of each bidder to become familiar with the site and documents; no extras will be approved for conditions that could be reasonably determined at the time of bidding.

1.03 SPECIFICATION TECHNIQUES

- A. Format:
 - 1. These specifications are written in imperative and streamlined form and are directed to the Contractor unless specifically noted otherwise.
 - 2. The words "shall be" shall be inferred where a colon (:) is used within phrases or sentences.

- B. Definitions:
 - 1. The word "furnish" shall mean to purchase, supply, and deliver to the project site, elevation, and location, those materials and/or services which are necessary for the completion of the Work.
 - 2. The word "install" shall mean to place and integrate materials into position for their designed use.
 - 3. The word "provide" shall mean furnish and install.
 - 4. The word "manufacturer" shall mean the manufacturer or private-labeler of the material, which are to be integrated into the Work.

PART 2 - PRODUCTS

- A. Not Used.

PART 3 - EXECUTION

- A. Not Used.

END OF SECTION

SUMMARY OF WORK

PART 1 - GENERAL

1.01 PROJECT OVERVIEW

- A. The Work consists of shingle roof replacement at Four (4) Separate Buildings in Buffalo Grove, Illinois for the Village of Buffalo Grove.
1. **Base Bid (3 buildings):**
 - a. 511 N Arlington Heights Road (including new curb and skylights)
 - b. 525 N Arlington Heights Road (including new curb and skylight)
 - c. 109 Deerfield Parkway
 2. **Alternate Add #1 (1 building):**
 - a. 345 Arlington Heights Road (including new skylight)
- B. The Work includes:
1. Related sheet metal work (see Section 07 62 00 and Construction Drawings for additional metal fabrication and installation requirements)
 - a. Installation of new perimeter metal at the 109 Deerfield Parkway building:
 - 1) Eave apron at all eaves
 - 2) **Note: At the other three (3) buildings, existing perimeter eave apron and rake edge metal shall remain in place and be reused.*
 - b. Replacement of existing gutters and downspouts.
 - 1) New downspouts shall be installed at existing locations.
 - c. Installation of sheet metal flashings and saddles at skylight curbs, as further described below.
 2. Replacement of existing square attic vents, where applicable.
 3. Installation of the specified continuous ridge vents along all ridges, where applicable.
 4. Replacement of soil stack flashings with new lead flashings.
- C. The Work also includes replacement of existing skylights and curbs at 3 buildings, as follows:
1. **511 N. Arlington Heights (row of 4 skylights)**
 - a. Before replacing skylights, build new 4-unit curb using dimensional lumber and plywood, as shown in Detail P-6 on Drawing Sheet A6.1. Adjust exact lumber construction/installation as needed to accommodate current skylight opening locations and sizes, ensuring skylight opening is not decreased. Minimum 8" curb height. Due to four (4) curbs in close proximity to each other, flash area in between curbs with EPDM flashings as shown in the drawings. Flash curb into shingle roof with new sheet metal step flashings, curb apron, and saddle on the up-slope side.
 - b. Over the new curbs, replace skylights with new skylights, as follows:
 - 1) VELUX Curb Mount Traditional Double-Dome (Model CMT2) *(or pre-approved equal)*
 - 2) Clear over white acrylic domes
 - 3) Sized to fit new curbs.
 2. **525 N. Arlington Heights (single skylight)**
 - a. Before replacing the skylight, build new 8" tall curb using dimensional lumber. Adjust exact lumber construction/installation as needed to accommodate current skylight opening location and size, ensuring skylight opening is not decreased. Flash curb into shingle roof with new sheet metal step flashings, curb apron, and saddle on the up-slope side.
 - b. Over the new curb, replace skylight with new skylight, as follows:
 - 1) VELUX Curb Mount Traditional Double-Dome (Model CMT2) *(or pre-approved equal)*

- 2) Clear over white acrylic domes
 - 3) Sized to fit new curb.
3. **345 Arlington Heights (single ridge-mount skylight)**
- a. Over existing skylight deck opening, install new ridge-mount skylight, as follows:
 - 1) American Skylights Ridge Mount Thermally Broken Self Flashing (Model RMTSF) (*or pre-approved equal*)
 - 2) Clear over white acrylic domes
 - b. Flash into shingles with step flashing on the sides and apron flashing on the bottoms.
4. Contractor shall coordinate skylight replacement with the owner, prior to disturbing the interior spaces, and barricade and protect the interior spaces below the skylight opening as needed to ensure the safety of building occupants and protect interior surfaces from falling debris.
5. Contractor shall remove the existing skylight and curb, and install the new curb and skylight, specified above, onto the existing deck opening. Install per the manufacturer's written installation instructions.
- D. The Owner will not be responsible for any work associated with this project, except for assisting with coordinating site use and interior access, if needed.

PART 2 - PRODUCTS

2.01 SYSTEM COMPONENTS

- A. Asphalt shingle roof system:
1. Laminated, architectural fiberglass reinforced asphalt shingles.
 2. Synthetic underlayment.
 3. Self-adhering leak barrier (ice-dam flashing membrane).
- B. Miscellaneous:
1. Integral sheet metal flashings:
 - a. Prefabricated aluminum flashings:
 - 1) Eave apron at all eaves
 - 2) Step flashing
 - b. 24 gauge galvanized shop-fabricated flashings
 - 1) Curb wrap
 - 2) Curb apron flashing
 - 3) Saddle on upslope side of curb
 - c. Prefinished aluminum gutters and downspouts
 2. New square attic vents.
 3. Prefabricated, shingle-over ridge vent.
 4. Lead soil stack flashings.
 5. Shingle nails (no staples will be allowed).
- C. Skylights and Curbs
1. As listed in Part 1 above.
- D. Miscellaneous fasteners and sealants.

2.02 COMPONENTS SUPPLIED BY OWNER

- A. None.

PART 3 - EXECUTION

3.01 WORK PERFORMED BY CONTRACTOR

- A. Remove existing shingles, underlayment's and sheet metal flashings down to the existing roof sheathing.
- B. Clean the exposed roof sheathing of all debris, shingle fasteners, etc. Repair or replace roof sheathing as required. Obtain unit price approval for Additional Work completed.
- C. Install new curbs and skylights as described above.
- D. Install self-adhering leak barrier at the eaves, valleys, changes in elevations, and projections as specified or where shown or required by the Construction Drawings.
- E. Install synthetic underlayment, in shingle fashion, over the entire roof deck.
- F. Install a starter shingle along all eaves and rake edges prior to installing the asphalt shingles.
 - 1. Starter strip (and shingles) shall overhang metal edge ½" along all eaves and rake edges.
- G. Install the asphalt shingles over the completed leak barrier, underlayment, and starter shingles. Install in accordance with the manufacturer's printed instructions. Install the integral metal flashings at the same time as the shingles.
 - 1. **Fasten shingles with a minimum of 6 nails per shingle**
- H. Remove and replace attic vents, soil stack flashings, ridge vent, and all other penetration flashings in accordance with these specifications and/or Construction Drawings, unless otherwise indicated.
- I. All perimeters and projections are to be constructed and flashed in strict accordance with the Construction Drawings provided.

3.02 INCLUSIONS

- A. The Contractor shall include, in his bid, any and all costs incurred in complying with the intent of the Construction Drawings.

END OF SECTION

APPLICATIONS FOR PAYMENT

PART 1 - GENERAL

1.01 DESCRIPTION

- A. This section describes the procedures and submittal requirements regarding Unit Pricing, Change Orders, and Application for Payment requests to the Owner.

1.02 PROGRESS PAYMENTS

- A. Unit Pricing:
1. The Unit Pricing submitted by the Contractor shall be considered fixed and inclusive of its purchase, installation, overhead expenses and profit.
 2. Units of measurement shall be as described on the Bid Form:
 - a. Dollars per square foot.
 - b. Dollars per lineal foot.
 - c. Dollars per unit.
 3. The Contractor shall obtain written approval, on the Unit Pricing forms provided by or acceptable to the Consultant, by signature of the Consultant or an authorized on-site representative of the Owner, for each day's quantity of completed work affected by unit pricing.
 4. The Contractor shall accumulate the completed Unit Pricing forms and submit them to the Consultant, on a weekly basis, in conjunction with a completed Change Order form totaling the cost of the approved Unit Pricing.
 5. In the event that proper approval of Unit Pricing is not obtained, the Owner reserves the right to reject the Contractor's measurement of Unit Pricing work-in-place, and to have the Work measured by the Consultant, or an independent surveyor acceptable to both the Owner and Contractor, at the Contractor's expense.
 6. Unit Pricing is intended to be used for small-scale areas of extra work. In the event that the scope of the work covered by the unit pricing escalates, the Owner reserves the right to use the Contractor's time and materials (T&M) rate or negotiate a lump sum price in lieu of the Unit Pricing.
- B. Time and materials (T&M) pricing:
1. The Time & Material Rate submitted by the Contractor shall be considered fixed and inclusive of overhead and profit.
 2. Repair of latent defects or the execution of additional work for which unit prices were not submitted:
 - a. Dollars, per man-hour, for labor.
 - b. Percentage mark-up over purchase price for materials furnished.
- C. Change Orders:
1. The Contractor shall be responsible for initiating the request for Change Order, on the forms provided by or acceptable to the Consultant, to include:
 - a. A summary of the approved Unit Pricing (include copies of approved Unit Pricing forms), on a weekly basis.
 - b. A description of the approved change in the Work, within one (1) week of initiation.
 2. The Consultant will review the Change Order requests and forward them with his recommendation to the Owner; copies approved by the Consultant and Owner will be returned to the Contractor.
 3. The Contractor shall submit the approved Change Order forms in conjunction with an Application for Payment form, including the total of the approved Change Orders.
 4. Change Orders shall be considered valid only if:

- a. Submitted in writing on the proper Change Order form.
- b. Approved by signatures of both the Consultant and the Owner.

D. Application for Payment:

- 1. The Contractor shall submit:
 - a. Completed Application for Payment, on standard AIA formats or on IRS forms, in triplicate.
 - b. Contractor's original invoice.
 - c. Subcontractor's material and/or labor Waivers of Lien, where applicable, to match the amount requested.
 - d. Written justification for payment of materials not in-place by means of supplier invoices, bills of lading, Waivers of Lien, etc.
- 2. The Contractor shall submit Application for Payment, on a periodic basis or as determined in the Agreement, to:

**Industrial Roofing Services, Inc.
13000 West Silver Spring Drive
Butler, WI 53007**

EMAIL – office@irsroof.com

- 3. The Consultant shall review the Application for Payment and either:
 - a. Approve the requested amount as a representation that the Work has progressed to the point indicated and, that to the best of his knowledge, information and belief, the quality of the Work is in accordance with the Contract Documents, or;
 - b. Revise the amount requested to an amount for which he is able to make such representation to the Owner.
 - c. Notify the contractor in writing of the applications rejection due to error and/or incompleteness
- 4. Payments will be reviewed, approved, and submitted to the Owner with the Consultants recommendations on a timely basis.

PART 2 - PRODUCTS

- A. Not Used.

PART 3 - EXECUTION

- A. Not Used.

END OF SECTION

ALTERNATES, ALLOWANCES AND SUBSTITUTIONS

PART 1 - GENERAL

1.01 DESCRIPTION

- A. This section identifies each voluntary and/or mandatory Alternate, by number, and describes the basic changes to be incorporated into the Work; only if that Alternate is made a part of the Work by acceptance by the Owner in the Agreement.
- B. This section also includes the Contractor's options in selecting products or requesting the acceptance of substitute products.
- C. This section also specifies Allowances – monetary amounts (or materials) to be included in the Contractor's bid prices – which will be used to cover change orders, unit pricing, deteriorated material replacement and/or other intangibles during the course of the Work.

1.02 RELATED REQUIREMENTS

- A. Bidding Documents: Method of quotation for each Alternate, and the basis of the Owner's acceptance of Alternates.
- B. Referenced sections of these specifications, or drawing details, which stipulate the products and methods necessary to achieve the Work for each Alternate, as described below.
- C. Coordination of related work and modification of surrounding work of the Base Bid, as required to properly integrate the work of each Alternate, to provide the Work as required by the Contract Documents.

1.03 DESCRIPTION OF ALTERNATES

- A. As described within Section 01 11 00 "Summary of Work".

1.04 PRODUCT OPTIONS AND SUBSTITUTIONS

- A. Contractor's product options:
 - 1. If products are specified only by reference standard, any product which meets that standard, by any manufacturer, shall be used.
 - 2. If several products are specified by name or manufacturer, any of the listed products may be used.
 - 3. If only one product is specified by name or manufacturer, that product shall be used, or the Contractor shall submit a request for substitution, as specified below, for a product that meets or exceeds the quality standards of the listed product.
 - 4. If product list is followed by "Approved equal", the Contractor may use any of the listed products or shall submit his "or equal" for consideration, following the substitution procedure, as specified below.
- B. Substitutions:
 - 1. During the Bidding process, the Consultant may consider written requests from Bidders for substitute products in place of those specified. If the Consultant deems the substitute product to be worthy of approval, it will be incorporated as such into an Addendum to all Bidders. Requests for substitutions shall include data as listed below and shall be received at least five (5) business days prior to the bid due date.

2. Submit requests substitution, supported with complete data, drawings and/or appropriate samples as necessary to show compliance with the intent of the Contract Documents, including:
 - a. Product description, performance, and test data, and applicable reference standards.
 - b. If applicable, a letter from a substitute manufacturer that indicates the following:
 - 1) Manufacturer has reviewed and approved the specifications and drawings, as they relate to the use of their products.
 - 2) Manufacturer confirms the specified system (including requirements of the drawings, installation methods specified, and other products) is acceptable to the manufacturer.
 - 3) Upon installation of the specified system, by an approved applicator, the manufacturer will issue the specified warranty.
 - c. Name, address, date of installation and Owner contact of similar projects on which the product was used.
 - d. Changes required in other elements of the Work as a result of incorporation of the substitute product.
 - e. Effect on the anticipated construction schedule, if any.
 - f. Cost of incorporation of the proposed substitution regardless of whether the Contract Sum is affected or not.
- C. Contractor's representation: a request for substitution constitutes a representation that the Contractor:
 1. Has investigated and determined that the proposed substitute product is equal or superior, in all respects, to the specified product.
 2. Will provide the same warranty as specified if substitute products are utilized.
 3. Will coordinate the incorporation of the proposed substitution in the Work
 4. Will modify other portions of the Work, as may be required, to complete the project in accordance with the intent of the Contract Documents.
 5. Waive all future claims for added costs to the Contract, over and above those approved by the Owner that may be caused by use of the substitute product.
- D. Substitutions will not be considered if:
 1. They are indicated or implied on shop drawings or product data submittals, except as described above.
 2. The substitute product is considered, in the opinion of the Consultant, to be outside of the general classifications of the specified product.
 3. Approval of the substitution would require substantial revisions to the Contract Documents.
- E. Contractor shall not order or install substitute products without Written Notice of Acceptance of the request for substitution by the Consultant and the Owner. Submission of the Substitution Request Form does not in any way constitute approval. If the substitution is not approved, the rejection shall be considered final and the Contractor shall furnish a specified product.

1.05 CONSTRUCTION ALLOWANCE

- A. Contractor shall add a lump sum amount of **ten thousand dollars (\$10,000.00)** to their base bid amounts for the funding of Unit Price Work.
- B. Use of the allowance is restricted to direction of the Consultant for the Owner's purposes and only authorized by Signed Change Orders or Unit Pricing Approvals that indicate amounts to be charged to the allowance.
- C. At Project closeout, credit unused amounts remaining in the contingency allowance to Owner by Change Order.

PART 2 - PRODUCTS

A. Not Used.

PART 3 - EXECUTION

A. Not Used.

END OF SECTION

01 31 19

PROJECT MEETINGS

PART 1 - GENERAL

1.01 DESCRIPTION

- A. This section provides information regarding the Consultant's scheduled project meetings.

1.02 PRE-BID MEETING

- A. If applicable, a pre-bid meeting will be held, at the project site, at the date/time designated in the bid invitation.
- B. Representatives of all prospective Bidders shall meet with the Consultant to review the existing conditions on the project site.
- C. The Consultant will, as a minimum, address the following items at the pre-bid meeting:
 - 1. Introduction of key project personnel;
 - 2. The general project scope, including site walkover;
 - 3. The requirements of Section 00 21 13 – “Instructions to Bidders”;
 - 4. The bid(s) to be included;
 - 5. The Bid due date;
 - 6. The Owner's intended project construction schedule;
 - 7. Required project warranties;
 - 8. Any special requirements;
 - 9. Anticipated construction facilities:
 - a. Use of the site and restrictions, if any;
 - b. Temporary services and controls.

1.03 PRE-CONSTRUCTION CONFERENCE

- A. Within ten (10) days after Consultants receipt and approval of required project submittals Contractor shall provide Consultant with written notice of his intent to start the work.
- B. Within ten (10) days after receipt of Contractors written notice of his intent to start the work Consultant will schedule a formal pre-construction conference to be held at the project site, at a time designated by the Consultant.
- C. Representatives of the Contractor and his subcontractors, including the project superintendent and foreman, shall attend the pre-construction conference with the Consultant and a representative of the Owner.
- D. The Consultant will, as a minimum, address the following items at the pre-construction meeting:
 - 1. Designation of key personnel and their duties;
 - 2. The channels for project communication;
 - 3. Review of the project Scope of Work;
 - 4. The anticipated project construction schedule, showing timeframe for start and completion of each portion of the Work;
 - 5. Review of material list (Contractor shall provide an updated list if changes were made from initial submittal);
 - 6. Review of sequencing for critical areas of the Work;
 - 7. The requirements for approving and processing of Unit Pricing and Change Orders;
 - 8. Job site conditions and requirements:
 - a. Use of site and restrictions;

- b. Temporary services and controls;
- c. Existing facilities and maintenance of operation;
- d. Daily completion procedures, such as night seals;
- e. Emergency weather-seal protections;
- 9. Notification procedures;
- 10. Expectations of the Owner and IRS;
- 11. Quality control of new work.

PART 2 - PRODUCTS

- A. Not Used.

PART 3 - EXECUTION

- A. Not Used.

END OF SECTION

SUBMITTAL PROCEDURES

PART 1 - GENERAL

1.01 DESCRIPTION

- A. This section provides requirements for project submittals and guidelines for submittals, by the Contractor or his Subcontractor, of shop drawings and other submittals as requested in the Project Documents.

1.02 SUBMISSION REQUIREMENTS

- A. Submittals listed below shall be delivered to the Consultant as soon as possible after Contract Award, but no later than ten (10) days prior to Contractor's intent to start work, and/or a minimum of five (5) days before approval is needed to order materials.
- B. Required Submittal items:
1. Insurance Certificate: Original copy, with the Owner as certificate holder and the Consultant (and any other entities specified) named as Additional Insureds.
 2. Performance and Payment Bonds: If required by Owner.
 3. Materials: List of major products proposed for use, with name of manufacturer, trade name or model number of product or materials (final list may be provided at the pre-construction meeting if changing between specified products). Submit product data sheets, printed information, installation instructions, catalog cuts, or material color charts.
 4. Safety Data Sheets: Provide copies of SDS for each product that will be brought on-site.
 5. Project Schedule: Provide a breakdown of the project schedule timetable by **each major portion** of the work. As a minimum, include start and completion dates for each required task.
 6. Schedule of Values: Provide a breakdown of project cost by **each major portion** of the Work such as mobilization, tear-off/temporary roof, insulation/membrane, flashings, sheet metal, etc. **DO NOT** list only material and labor.
 7. Sheet Metal Color Charts: Original, standard color charts, for selection by the Owner. This selection may not be made during the submittal approval process.
 8. Manufacturer's Certification: Submit a letter from the manufacturer stating their intent to warrant the project, as specified, including certification of the Contractor's standing as a licensed applicator of the specified product and/or system.
 9. Warranty: Submit a sample copy of the applicable manufacturer's warranty as well as a copy of the completed application for warranty.
 10. Project Contacts: Provide all necessary contact numbers (cellular, pager, etc.) for key personnel involved in the project. Include after-hours contact name and home telephone number in case of emergency. Also provide subcontractors' names, addresses, contact names, and phone/fax numbers, if applicable.

1.03 CONTRACTOR RESPONSIBILITIES

- A. The Contractor shall review the shop drawings, product data and samples prior to submission. The Contractor shall initial, sign, or stamp the submittals to certify his review and acceptance.
- B. Verification of existing field measurements and conditions is the SOLE responsibility of the Contractor.
- C. The Contractor's responsibility for errors and omissions in submittals is not relieved by the Consultant's review or acceptance of submittals.

- D. Clearly indicate, in the submittals, any deviations from the requirements of the Project Documents caused by acceptance of substitutions, negotiations with the Owner after the Bid, etc. Any changes to the Project Documents must be confirmed by written Change Order.
- E. The Contractor shall not begin work prior to receipt of the approved submittals from the Consultant.

1.04 DISTRIBUTION OF SUBMITTALS

- A. The Consultant will retain three (3) copies of approved or approved-as-noted submittals, two for IRS office use, and one for the Owner, and will return the remaining copies to the Contractor.
- B. The Contractor shall be responsible for distributing submittals which carry the Consultant's approval, as required for construction or fabrication, to the project Superintendent, Subcontractors, and material suppliers or distributors.

PART 2 - PRODUCTS

- A. Not Used.

PART 3 - EXECUTION

- A. Not Used.

END OF SECTION

QUALITY CONTROL

PART 1 - GENERAL

1.01 DESCRIPTION

- A. This section provides requirements for the standards of quality for materials and workmanship for this project.

1.02 GENERAL

- A. The Contractor shall maintain quality control over his employees, suppliers, manufacturer's products, services and site conditions to produce work of specified quality.

1.03 WORKMANSHIP

- A. Comply with recognized industry standards, except where specifications indicate more rigid standards or more precise workmanship.
- B. Perform the Work with personnel qualified to produce workmanship of specified quality.

1.04 APPLICATION QUALITY CONTROL

- A. The Contractor shall be experienced in all aspects of the type of work being performed.
- B. The Contractor shall be approved, by the product/system manufacturer, to install the specified roof system prior to the commencement of the Work. The Contractor shall also be certified to procure the specified warranty.
- C. The Contractor shall, at all times, have a complete set of Project Documents, including specifications, drawings, SDS sheets and approved submittals for his use and reference, on the project site. The site superintendent shall produce these Project Documents upon request of either the Owner or the Consultant. Failure to do so will result in a violation of Item 1.07 of this Section.

1.05 MANUFACTURER'S FIELD SERVICES

- A. Product Manufacturer(s) shall make available, upon request, qualified personnel to observe field conditions, conditions of surfaces and installation and quality of workmanship.
- B. The product manufacturer shall make qualified personnel available to make necessary recommendations during the course of the project, and to perform a final review of the Work, if requested.
- C. The manufacturer's representative shall submit a copy of his written report to the Consultant, listing observations and recommendations.

1.06 CONSTRUCTION OBSERVATION

- A. Construction observation shall be conducted by the Consultant on a periodic basis, as determined by agreement with the Owner. If the Contractor is cited for non-compliance with the specifications during the course of a site visit, all parties shall be notified with a copy of the observation report.

- B. In the event that the Contractor is cited for the same non-compliance item twice, or any three items total, the Owner may employ the Consultant to provide more frequent observation or full-time observation, to ensure compliance with the Project Documents. The cost of these additional visits may be deducted, in whole or in part, from the Contractor's final contract amount.

PART 2 - PRODUCTS

- A. Not Used.

PART 3 PART 3 - EXECUTION

- A. Not Used.

END OF SECTION

SITE CONDITIONS AND CONTROLS

PART 1 - GENERAL

1.01 DESCRIPTION

- A. This section provides requirements for the Contractor's operations at the project site, including use of existing facilities and utilities, delivery and storage of materials and equipment and controls affecting work operations.

1.02 SECURITY AND ACCESS

- A. Security: follow the Owner's procedures and requirements, as established during the pre-construction conference.
- B. Maintenance of access and operations:
 - 1. During the performance of the Work, the Owner shall continue to perform his normal operations in the building. The Contractor shall maintain access to Owner-occupied areas at all times.
 - 2. Schedule demolition and roofing work with the Owner in such a manner as to allow his normal operations to continue without interruption.
- C. Maintenance of existing services:
 - 1. The Contractor shall, during the performance of the Work, not adversely affect the temperature and humidity of the building interior; dust and debris shall be controlled to prevent interference with normal operations.
 - 2. Notify the Owner a minimum of three (3) days prior to each required interruption of mechanical or electrical services in building. Such interruptions shall occur only when, and for the length of time, approved by the Owner.
- D. Building access:
 - 1. Access to the building's interior shall be restricted to investigating leaks and performing portions of the Work which requires such interior access. The Contractor shall not have access to the building's interior during non-business hours unless previously arranged with the Owner.
 - 2. All access to the project site shall be by way of exterior means provided by the Contractor.
 - 3. Restrict construction traffic over adjacent areas as designated by the Owner during the pre-construction conference.

1.03 MATERIAL STORAGE AND HANDLING

- A. Store materials on-site where specified in Section 01 60 00 - "Materials and Equipment." Do not use any portion of the building interior for storage, unless specifically approved by the Owner.
- B. Stored materials shall be available for review by the Owner or Consultant at all times.
- C. Handle all materials properly and in original cartons or containers to prevent damage. Provide for all necessary rigging of materials and equipment supplied to the project site.

1.04 SANITARY FACILITIES

- A. The Contractor shall provide adequate, temporary chemical toilets for use by his employees. The toilets shall be in place at the project site when the Work is commenced.

- B. Upon completion of the Work, remove these facilities and all traces thereof.

1.05 TEMPORARY WATER

- A. The Contractor shall make arrangements with the Owner for water as required during the performance of the Work.
- B. The Owner shall be responsible for the cost of the water supply.
- C. The Contractor shall be responsible for providing hoses necessary for conveyance.

1.06 TEMPORARY ELECTRICAL POWER

- A. The Contractor shall make arrangements for electrical service, as necessary for completion of the Work, as established during the pre-construction conference.
- B. In the event that the Owner agrees to provide access to electrical service, he shall pay all energy charges for power and/or lighting used by the Contractor.

1.07 ENVIRONMENTAL CONDITIONS

- A. Do not work in rain or snow, or in the presence of visible precipitation.
- B. Do not install materials marked "Keep from Freezing" when daily temperatures are predicted to fall below 40°F.
- C. Do not perform masonry work unless the temperature is above 35°F and rising. Make provisions to protect masonry work from freezing for a period of forty-eight (48) hours after completion. Remove any masonry work that has been exposed to freezing within forty-eight (48) hours of completion.

1.08 DEBRIS REMOVAL

- A. Remove debris promptly from work areas each day. Do not allow piled debris to accumulate.
- B. All removed material, unless specifically noted for retention by the Owner, becomes the property of the Contractor.
- C. Do not allow debris to enter roof drains, storm sewers, catch basins, etc.
- D. Provide at site, prior to commencing removal of debris, a dumpster or dump truck to be located adjacent to the building where directed by the Owner.
- E. Protect the building surfaces at set-up and debris removal areas. Take all precautions necessary to prevent the scattering of debris during operations.
- F. Remove dumpster or dump truck from the premises when full and dispose of at an approved dumping or refuse area.
- G. Upon job completion, dumpster or dump truck and set-up area protection shall be removed from premises. All spilled or scattered debris shall be cleaned up immediately.

1.09 PARKING FACILITIES

- A. The Owner shall provide vehicle parking assignments and/or restrictions for the Contractor to the extent established during the pre-construction conference.

1.10 LEAK (WATER) DAMAGE CONTROL

- A. In the event of rain during performance of the Work, make work watertight and immediately inspect the interior of the building for leaks. The Contractor shall continue to check on the watertight status of the work on a 24-hour basis.
- B. Coordinate procedures with the Owner for access to the building during non-business hours for emergency work.
- C. If leaks are discovered during rains. Immediately notify the Owner of leak condition and perform emergency repairs on the work to stop leaks.

1.11 CLEANING

- A. The Contractor shall remove all spillage, overspray, or collections of dust or debris, and repair any damage inflicted on Owner-occupied spaces during the course of the Work.
- B. As soon as work on an area is complete, clean up all surfaces, remove equipment, materials and debris, and restore to a condition suitable for use by the Owner as quickly as possible.

PART 2 - PRODUCTS

- A. Not Used.

PART 3 - EXECUTION

- A. Not Used.

END OF SECTION

MATERIALS AND EQUIPMENT

PART 1 - GENERAL

1.01 DESCRIPTION

- A. This section includes general requirements for delivery, storage and handling of products to be used in the Work.

1.02 GENERAL

- A. Materials to be incorporated into the Work:
 - 1. Shall conform to applicable specifications and standards.
 - 2. Shall comply with the size, make, type and quality specified or shall be substitute products as specifically approved, in writing, by the Consultant.
 - 3. Fabricated products:
 - a. Fabricate and assemble in accordance with recognized industry standards.
 - b. Shall conform to the dimensions and configuration shown or specified or in accordance with approved shop drawing submittals.
- B. Materials shall not be used for purposes other than those for which they are designed, unless otherwise specified.

1.03 REUSE OF EXISTING MATERIALS

- A. Except as specifically indicated in the Construction Drawings or in Section 01 11 00 - "Summary of Work," materials and equipment removed from the existing construction shall not be utilized in the completed Work.
- B. Where materials and equipment are specifically indicated to be reused in the Work:
 - 1. Use special care in removal, handling, storage and reinstallation, to assure adequate and proper function in the completed Work.
 - 2. The Contractor shall be responsible for transportation, storage and handling of products which require off-site storage, restoration or renovation.

1.04 MANUFACTURER'S INSTRUCTIONS

- A. Where Project Documents require that the installation of work shall comply with the manufacturer's printed instructions, obtain and distribute copies of those instructions to all parties involved in the installation, including two copies to the Consultant.
 - 1. Maintain one set of complete instructions at the project site until completion of the work.
 - 2. Include copies of the printed instructions with the appropriate Product Data submittal.
- B. Handle, install, connect, clean, condition and adjust products in strict accordance with such instructions, and in conformity with specified requirements.
 - 1. Should existing conditions or specified requirements conflict, in any way, with the manufacturer's instructions, request clarification from the Consultant. Failure to notify the Consultant shall be grounds for rejection of the completed work.
 - 2. Do not proceed with work without clear instructions.

1.05 TRANSPORTATION AND HANDLING

- A. Arrange for delivery of materials in accordance with construction schedules; coordinate to avoid conflict with sequencing of the Work and conditions at the project site.
 - 1. When being transported to the project site by the Contractor, cover and protect materials in transit against entrance of dirt and/or weather damage.
 - 2. Deliver materials in undamaged condition, in manufacturer's original containers or packaging, with identifying labels intact and legible.
 - 3. Immediately upon delivery, inspect shipments to assure compliance with requirements of the Project Documents and approved submittals, and to assure that materials are properly protected and undamaged.
- B. Handle all materials properly and in original cartons or containers to prevent damage.
- C. Provide equipment and personnel to handle materials using methods necessary to prevent soiling or damage to products or packaging.

1.06 STORAGE OF MATERIALS

- A. Stored materials shall be available for review by the Owner or Consultant at all times.
- B. Store rolled goods on ends only. Discard rolls which have been flattened, creased, or otherwise damaged.
- C. Do not use any portion of the building interior for storage, unless specifically approved by the Owner.
 - 1. Disperse materials on rooftop to avoid concentrated loading of structure.
 - 2. Do not place materials on newly completed roofing or on areas of roofing not included in the Work.
- D. Stack insulation and roll goods on pallets; neatly stack wood on dunnage. Do not stack pallets.
- E. Store pallets of new steel roof deck with one end elevated to provide drainage.
- F. Completely cover the top and sides of materials with tarpaulin. Secure tarpaulin to prevent blow-off.
- G. Materials which, in the judgment of the Consultant, have been damaged, contaminated or improperly stored shall be immediately removed from the project site and replaced with new materials.

PART 2 - PRODUCTS

- A. Not Used.

PART 3 - EXECUTION

- A. Not Used.

END OF SECTION

CONTRACT CLOSE-OUT AND WARRANTIES

PART 1 - GENERAL

1.01 DESCRIPTION

- A. This section includes requirements for specific administrative procedures, close-out submittals, warranties and other forms to be used at the final completion of the Work.

1.02 CLOSE-OUT PROCEDURES

- A. When the Contractor considers the Work complete, he shall submit **Written Notice** to the Consultant that:
1. He has reviewed the Project Documents and inspected the project for compliance with them;
 2. He certifies that the Work has been completed in accordance with the Project Documents; and
 3. He certifies that the project is complete, to his satisfaction, and is ready for the Final Review.
- B. The Consultant will perform the Final Review after receipt of the Contractor's **Written Notice** of project completion.
1. If the Consultant considers the Work to be complete and in accordance with the requirements of the Project Documents he shall notify the Contractor to produce the Contract Close-out submittals, as described below.
 2. If the Consultant considers the Work to be incomplete or not in accordance with the requirements of Project Documents:
 - a. He shall notify the Contractor, in writing, of the deficiencies.
 - b. The Contractor shall take immediate steps to remedy the identified deficiencies, and shall make the Work ready for re-review.
 - c. The Contractor shall submit a second **Written Notice** to the Consultant confirming that the identified deficiencies have been remedied.
 - d. The Consultant shall review the Work and, if complete, shall notify the Contractor to produce the Contract Close-out Submittals.
 3. Should the Consultant be required to perform a third review of the Work due to the failure of the Contractor to correct previously-identified deficiencies, the Owner may retain, from moneys due the Contractor, such amount as necessary to compensate the Consultant for additional visits.

1.03 FINAL CLEANING

- A. Perform project clean-up prior to the Final Review:
1. Clean surfaces, gutters, downspouts and drainage system free from foreign matter and debris.
 2. Remove all grease, mastics, adhesives, bitumen or other foreign materials from sight-exposed exterior surfaces of the building.
 3. Repair, patch and touch up marred surfaces to match adjacent finishes.
 4. Remove all waste and surplus material, rubbish, and construction facilities from the project site.
 5. Repair the grounds and landscaping in accordance with Section 01 74 29 - "Grounds Repair."
 6. Prior leaving the project site, conduct a thorough review of the work surfaces and all sight-exposed exterior surfaces in work areas, to verify that the entire Work is clean.

1.04 CLOSE-OUT SUBMITTALS AND WARRANTIES

- A. Guarantees, Warranties and Bonds:
1. The Contractor shall, upon project completion provide the following original warranty documents to the Consultant for the delivery to the Owner:
 - a. After the Consultant's acceptance, the Contractor shall deliver to the Consultant each manufacturer warranty required by individual Sections of the Project Specifications, to be effective once complete payment has been received by both the Contractor and material suppliers.
 - b. Contractors two (2) year workmanship warranty for labor and materials.
- B. Certification:
1. Lien Waivers: The Contractor shall submit final Waivers of Lien including those from subcontractors, material suppliers, or any other parties that may have lien rights against the property of the Owner, including a list of those parties. All waivers of lien shall be verified and duly executed before submittal.
- C. Final Application for Payment:
1. The Contractor shall submit a final Application for Payment form showing the remaining amount due.

1.05 CONTRACT CLOSE-OUT PACKAGE

- A. The Contractor shall submit the Contract Close-out package to IRS Corporate Office in accordance with these requirements. The Consultant shall review the Contract Close-out Package for accuracy and completeness.
1. Contract Close-out Packages that are accurate, complete and in proper form shall be approved by Consultant and submitted to Owner on a timely basis.
 2. Contract Close-out Packages that are not accurate, complete and in proper form, Consultant shall notify Contractor of its rejection and cause the Package to be set aside for forty-five (45) days, after which time Consultant shall again review corrected Contract Close-out Package if received and if correct, shall approve final payment and submit them to the Owner on a timely basis.

IRS CORPORATE OFFICE
Industrial Roofing Services, Inc.
13000 West Silver Spring Drive
Butler, Wisconsin 53007
c/o office@irsroof.com

PART 2 - PRODUCTS

- A. Not Used.

PART 3 - EXECUTION

- A. Not Used.

END OF SECTION

GROUNDS REPAIR

PART 1 - GENERAL

1.01 DESCRIPTION

- A. This section covers the removal, and replacement with like materials, of lawns, plantings, and pavement damaged by the Contractor during the performance of the Work.
- B. The cost of all repairs covered under this section shall be the **sole** responsibility of the Contractor. If the Contractor fails to make repairs to the Owner's satisfaction, the Owner reserves the right to retain, from moneys due the Contractor, such amount as necessary to repair the grounds to their previous condition.

1.02 REQUIREMENTS

- A. Verify, with the Owner, at the pre-construction meeting, as to whether re-seeding will be acceptable for repair of lawn areas; if not, areas shall be resodded.
- B. All plants and planting materials shall meet "Horticultural Standards" for number one grade nursery stock as adopted by the American Association of Nurserymen.
- C. All plants and planting materials shall meet or exceed applicable regulatory requirements and inspections for plant disease and insect control.

1.03 WORK SEQUENCING

- A. Do not proceed with permanent replacements until after the Contractor has cleaned and vacated the project site.
- B. Replacement plantings and/or sod:
 - 1. Place plantings and/or sod within forty-eight (48) hours of cutting; protect and maintain during transit and storage on the site to prevent dry-out.
 - 2. All plantings and/or sod remaining unplaced on the site longer than forty-eight (48) hours, as well as any yellowing or otherwise discolored plantings and/or sod shall be discarded.

1.04 WARRANTY

- A. The Contractor shall maintain and warrant all work performed under this section for a period of ninety (90) days from the date of its completion. The Contractor shall be responsible for the correction of unsatisfactory landscaping materials or workmanship and shall repair such defects promptly upon notice, at no additional cost to the Owner.

PART 2 - PRODUCTS

2.01 ACCEPTABLE LAWN REPAIR PRODUCTS

- A. Provide topsoil which is:
 - 1. Natural, friable, and characteristic of soil on the project site;
 - 2. Not extremely acidic nor alkaline, nor containing toxic substances;
 - 3. Free from subsoil, clay lumps, stones, roots, debris or other foreign objects;
 - 4. Contains 1/3, by volume, soil amendment – organic material, fortified with organic nitrogen.

- B. Provide fertilizer which is:
 - 1. Commercially-balanced 11-8-4 composition.
 - 2. Free flowing to allow for mechanical spreading.
- C. Provide grass seed, if acceptable, which is:
 - 1. Free from noxious weeds, and recleaned;
 - 2. Grade A recent crop seed;
 - 3. Treated with appropriate fungicide at time of mixing;
 - 4. In proportion, by weight:
 - a. Kentucky Bluegrass – 35%
 - b. Red Fescue – 20%
 - c. Hard Fescue – 20%
 - d. Improved Fine Perennial Ryegrass – 25%
 - 5. Covered with clean and weed-free straw mulch.
- D. Provide sod, if grass seed is not acceptable, which is:
 - 1. Well established, containing dense root systems;
 - 2. Exhibiting vigorous, healthy root growth;
 - 3. Free of noxious weeds, objectionable grasses, grubs, diseases or injurious insects.

2.02 ACCEPTABLE PLANTING REPAIR PRODUCTS

- A. Provide trees and/or plants which are:
 - 1. Of the same species and size of growth to match those being replaced;
 - 2. Well established, containing dense root systems;
 - 3. Exhibiting vigorous, healthy root growth;
 - 4. Free of grubs, diseases or injurious insects.
- B. Provide planting bed cover consisting of:
 - 1. Ground mulch chips;
 - 2. Shredded bark.

2.03 VEHICLE & PEDESTRIAN PAVEMENTS

- A. Asphalt pavement:
 - 1. Base course aggregate:
 - a. Crushed limestone (traffic-bond) or crushed concrete, containing no pieces over three-quarter (3/4) inch in greatest dimension, for base courses less than four (4) inches thick.
 - b. Crushed limestone, containing no pieces over one and one-half (1-1/2) inches in greatest dimension, for base courses over four (4) inches thick.
 - 2. Paving asphalt:
 - a. Shall comply with applicable sections of the State Highway Specifications for binder and surface-grade paving asphalt mixes.
 - b. Shall be hot, plant-mixed asphalt paving material; temperature shall be 290-320°F when leaving the plant and 280°F, minimum, at time of placement.
- B. Concrete pavement: Compressive strength shall achieve a minimum of 4000 psi in twenty-eight (28) days. Mix concrete materials in accordance with ASTM C94, to comply with the following:
 - 1. Slump: three (3) inches, plus one (1) inch or minus one-half (1/2) inch.
 - 2. Air entrainment: Maximum five percent (5%) at time of placement.
 - 3. Maximum aggregate size: ¾ inch.
 - 4. Minimum cement content: 440 lbs./cu. Yd.
 - 5. Maximum fly ash content: 100 lbs./cu. Yd.
 - 6. Maximum water-to-cementitious material ratio (W/C): 0.55.

PART 3 - EXECUTION

3.01 EXAMINATION

- A. Examine the project site and verify satisfactory conditions for performance of the work.
- B. Notify the Owner and Consultant of pre-existing defects or conditions which may interfere with the requirements of this section. Absence of notice will constitute the Contractor's acceptance of the site.
- C. Verify existence and location of underground utilities, water and gas lines, fire sprinkler systems, pavement heating devices, and lawn sprinkling systems.

3.02 PREPARATION

- A. Provide protection of existing adjacent trees, plantings, lawns and pavement prior to commencing repairs.
- B. Lawn replacement areas:
 - 1. Fill ruts and depressions with topsoil. Work the soil to a depth of not less than three (3) inches with a rototiller.
 - 2. Remove stones, debris, and foreign objects larger than one (1) inch in diameter from the lawn repair area prior to seeding or sodding.
 - 3. Grade the repair area, thoroughly remove ridges and depressions, and make area a smooth, continuous, firm plane that ensures proper drainage.
- C. Planting replacement areas:
 - 1. Remove existing damaged trees, plants or ground cover. Remove large root systems, stones, debris, or foreign objects larger than one (1) inch in diameter from the area prior to installation of new plantings.
 - 2. Remove the topsoil, to a depth of not less than three (3) inches, from an area not less than three (3) times the width of the root ball of the new planting.
 - 3. Dig a hole in the center of the prepared area:
 - a. For a one (1) gallon plant container, twelve (12) inches wide and deep.
 - b. For a five (5) gallon plant container, twenty (20) inches wide and deep.
 - c. For a fifteen (15) gallon plant container, thirty (30) inches wide and deep.
 - d. For larger trees, 1-1/2 times the root ball diameter wide and deep.

3.03 LAWN REPLACEMENT – SEEDING

- A. When preparations are complete, seed the repair area:
 - 1. Sow the grass seed over the area with a mechanical seeder at the rate of five (5) pounds per thousand (1,000) square feet.
 - 2. Promptly after seeding, water until the soil is saturated to a depth of two (2) inches; apply water slowly to prevent erosion of the seed bed.
 - 3. Apply the specified fertilizer at the rate of twenty (20) pounds per thousand (1,000) square feet; rake lightly into the soil.
 - 4. Cover the repair area with chopped straw mulch approximately ½-inch thick.
 - 5. Make arrangements to keep the seed beds moist throughout the germination process.

3.04 LAWN REPLACEMENT – SODDING

- A. When preparations are complete, install sod:
 - 1. Fit sod pieces tightly together so that no joint is visible, with alternate courses staggered. Compact sod to eliminate all air pockets, provide a true and even surface, and ensure knitting without displacement of sod or deformation of the surface of sodded areas.
 - 2. Fill cracks between sod pieces with screened topsoil following compaction.

3. Excess soil shall be worked into the grass surface.
4. Bury edges of sod pieces flush with adjacent soil.
5. After the sod has been placed, water with a fine spray until the soil is saturated to a depth of two (2) inches.
6. Make arrangements to keep the sod moist until it is rooted into place.

3.05 TREE, PLANT AND GROUND COVER REPLACEMENT

- A. When preparations are complete, install planting:
1. Fill the bottom of the hole with a backfill mixture, consisting of three (3) parts soil (removed from the hole) and one (1) part soil amendment, to support the root ball so that the top of the ball is just above or equal to the existing grade for drainage.
 2. Place the root ball of the planting into the hole and adjust for height and position of the planting. Work excess soil to the sides for support of the root ball.
 3. Fill the remaining area of the hole with backfill mixture around the root ball; tamp firmly to eliminate all air pockets. When the hole is 2/3 full, thoroughly water the plant to saturate the soil.
 4. Fill the remainder of the area with topsoil and tamp into place until the surface is slightly sloping to the edge of the surrounding area.
 5. Remove excess soil from the area.
 6. Stake trees over four (4) feet high with a minimum of two (2) stakes and ties. Drive stakes a minimum of twelve (12) inches deep; provide protection for trunk at tree-tie location.
 7. Apply the specified planting bed cover to a minimum depth of two (2) inches, evenly spread over the entire area.
 8. Water with a fine spray to ensure that the soil is thoroughly saturated.
 9. Make arrangements to water the planting regularly until it is rooted into place.

3.06 PAVEMENT REPLACEMENT

- A. Removal and subgrade preparation:
1. Remove damaged areas of paving, as well as areas of unsound pavement and areas heavily stained with grease and oil.
 2. Cut edges to a straight, vertical edge of ½-inch or more, by means of mechanical sawing. Excavate a minimum of six (6) inches below the existing, surrounding pavement surface, or as necessary to reach sound base material.
 3. Provide new aggregate subbase as required to fill within three (3) inches of existing, surrounding asphalt pavement surface or to within four (4) or six (6) inches of existing, surrounding concrete pavement surface, depending on slab thickness. Compact aggregate subbase to 95% density.
- B. Asphalt paving replacement:
1. Place the new asphalt paving material in two lifts:
 - a. The first lift shall be 1-3/4 inches, after compaction, binder-grade asphalt.
 - b. The second lift shall be 1-1/4 inches, after compaction, surface-grade asphalt.
 2. Spread material in a manner which requires minimal handling.
 3. After the material is placed, to proper depth, roll until the surface is hard, smooth, unyielding, and true to the specified thickness and elevation of the existing, surrounding asphalt pavement.
 4. Roll surface layer in at least two directions until no roller marks are visible.
 5. Finish paving surface shall be free from "birdbaths," with no variations of more than 1/8-inch in six (6) feet.
 6. Seal the interface of the existing pavement with hot rubberized crack filler to prevent water infiltration.
- C. Concrete paving replacement:
1. Place wooden forms where necessary, staked into the ground, to provide straight and true edges for new pavement.

2. Dampen the subgrade material before placing concrete.
3. Pour concrete over the prepared subgrade. Tamp the freshly-placed concrete, using a heavy tamper, until at least 3/8-inch of mortar is brought to the surface.
4. Trowel surface and screed with a straightedge until depressions and irregularities are worked out and the surface is true to specified thickness and elevation of the existing, surrounding concrete pavement.
5. Float surface to a compact, smooth surface.
6. When concrete has set sufficiently, provide a non-slip, "broomed" surface finish.

END OF SECTION

MISCELLANEOUS ROUGH CARPENTRY

PART 1 - GENERAL

1.01 RELATED DOCUMENTS

- A. Drawings and general provisions of the Contract, including General and Supplementary Conditions and Division 01 Specification Sections, apply to this Section.

1.02 SUMMARY

- A. Section Includes
 - 1. Replacement of wood roof sheathing

1.03 DELIVERY, STORAGE, AND HANDLING

- A. Stack lumber flat with spacers beneath and between each bundle to provide air circulation. Protect lumber from the weather by covering with waterproof sheeting, securely anchored. Provide for air circulation around stacks and under coverings.

1.04 PROJECT CONDITIONS

- A. Provide all materials, labor, and accessories for the complete and proper installation of the wooden products required for the roof installation as shown on the Construction Drawings and as required to meet the highest industry standards.
- B. Provide wood, nails, bolts, screws, steel angles, rough hardware, and other items needed to perform rough carpentry for the construction shown on the Drawings, as specified herein, and as needed for a complete and proper installation.
- C. Work shall include, but is not limited to:
 - 1. Installation of new wood boards to match existing species and dimensions if required, to replace deteriorated wooden roof decking and miscellaneous rough carpentry where shown on the Construction Drawings or as needed for a complete and proper installation of the roof, gutter, expansion joint, and coping assemblies.

PART 2 - PRODUCTS

2.01 ROOF SHEATHING

- A. Match existing type (OSB or Plywood), grade, and thickness.

2.02 FASTENERS

- A. Roof Sheathing to Existing Structural Components:
 - 1. Common wire nails.
 - 2. Nail size: 8d galvanized.
 - 3. Placement:
 - a. Six (6) inches on center at the edge.
 - b. Eight (8) inches on center in the field

PART 3 – EXECUTION

3.01 EXAMINATION

- A. NONE

3.02 PREPARATION

- A. NONE

3.03 INSTALLATION

A. General Requirements:

1. Do not use lumber or materials which are unsound, warped, bowed, twisted, inadequately seasoned, or too small to fabricate the work with a minimum of joints.
2. Fit carpentry work to other work. Produce joints that are tight, true, and well fastened.
3. Set carpentry accurately to required levels and lines with members plumb and true.
4. Attach carpentry to substrates with specified fasteners in accordance with fastener manufacturers printed instructions.
 - a. Countersink new fastener heads flush with the top of wood members. Hollow out the bottom of new wood members, if necessary, to fit over existing exposed bolt heads that are not countersunk.
 - b. Countersink nail heads on exposed carpentry and fill holes.
5. Select fastener size that will not penetrate members where the opposite side will be exposed to view or will receive finish materials.
6. Threaded fasteners shall be turned into place, not driven.
7. Fasteners shall be tightened at installation and retightened as required prior to closing in or at the completion of work.

3.04 ROOF DECK REPLACEMENT (SHEATHING)

A. General requirements:

1. Do not use materials that are unsound, warped, bowed, twisted, inadequately seasoned, or too small to fabricate the work with a minimum of joints.
2. Fit sheathing work to other work.
3. Replace only complete sheets in their entirety.

B. Evaluation:

1. Inspect sheathing for signs of deterioration or dry-rot.
2. Replace sheathing panels that:
 - a. Are cut through or otherwise damaged;
 - b. Have openings larger than twelve (12) inches;
 - c. Have multiple openings between support members;
 - d. Are deteriorated over more than twenty-five percent (25%) of the area between support members; or
 - e. Are deflected, warped, or otherwise compromised structurally.
 - f. Verify, prior to the start of sheathing removal, the existence and location of deck-supported utilities and accessories including, but not limited to: water and gas lines, fire sprinkler systems, above and below deck conduit and tubing, and ceiling suspension systems. Coordinate any work that may affect these utilities with the Owner.

C. Documentation:

1. The contractor shall take digital photos of all areas and send them to the Consultant as they occur.
2. Replace sheathing panels that:
 - a. Are cut through or otherwise damaged;

- D. Sequencing:
 - 1. Demolish only as much roof sheathing as can be replaced with a completed roofing system before the stop of work on that day.
- E. Installation:
 - 1. Install new sheathing in place, gap sheathing 1/16" on all edges prior to fastening.
 - 2. Install galvanized "H" clips at mid-span of horizontal joints between framing members.
 - 3. Fasten new sheathing to existing structural components with appropriate fasteners.

3.05 CLEANING

- A. Wood chips, shavings, sawdust, and other debris shall be swept up and removed from the work area daily prior to the installation of subsequent roofing components.
- B. During the progress of the Work, use all means necessary to prevent the spread of dirt and debris to the building interior.
- C. Clean building interior/attic spaces on a daily basis. In addition, when deck replacement is completed.

3.06 PROTECTION

- A. NONE

END OF SECTION

FIBERGLASS-REINFORCED ASPHALT SHINGLES

PART 1 - GENERAL

1.01 RELATED DOCUMENTS

- A. Drawings and general provisions of the Contract, including General and Supplementary Conditions and Division 01 Specification Sections, apply to this Section.

1.02 SUMMARY

- A. Section Includes:
 - 1. Fiberglass-reinforced asphalt shingles.
 - 2. Hip and ridge shingles
 - 3. Starter shingles
 - 4. Self-adhering leak barrier
 - 5. Shingle underlayment
 - 6. Attic ventilation
 - 7. Fasteners
- B. Related Sections:
 - 1. 06 10 53 - Miscellaneous Rough Carpentry
 - 2. 07 62 00 - Sheet Metal Flashing and Trim

1.03 REFERENCES

- A. American Society of Civil Engineers (ACSE):
 - ASCE 7 Minimum Design Loads for Buildings and Other Structures.
- B. Asphalt Roofing Manufacturers Association (ARMA).
- C. ASTM International (ASTM):
 - A 653/A 653M Standard Specification for Steel Sheets, Zinc-Coated (Galvanized) or Zinc-Iron-Alloy-Coated (Galvannealed) by the Hot-Dip Process
 - B 209 Standard Specification for Aluminum and Aluminum-Alloy Sheet and Plate
 - B 370 Standard Specification for Copper Sheet and Strip for Building Construction
 - D 225 Standard Specification for Asphalt Shingles (Organic Felt) Surfaced with Mineral Granules
 - D 226 Standard Specification for Asphalt-Saturated Organic Felt used in Roofing and Waterproofing
 - D 1970 Standard Specification for Self-Adhering Polymer Modified Bituminous Sheet Materials Used as Steep Roofing Underlayment for Ice Dam Protection.
 - D 3018 Standard Specification for Class A Asphalt Shingles Surfaced with Mineral Granules.
 - D 3161 Standard Test Method for Wind-Resistance of Asphalt Shingles (Fan-Induced Method).

- D 3462 Standard Specification for Asphalt Shingles Made From Glass Felt and Surfaced with Mineral Granules.
- D 4586 Standard Specification for Asphalt Roof Cement, Asbestos-Free.
- D 4869 Standard Specification for Asphalt-Saturated Organic Felt Shingle Underlayment used in Roofing.
- D 6164 Standard Specification for Styrene Butadiene Styrene (SBS) Modified Bituminous Sheet Materials Using Polyester Reinforcements
- D 6381 Standard Test Method for Measurement of Asphalt Shingle Mechanical Uplift Resistance.
- D 6757 Standard Specification for Inorganic Underlayment for Use with Steep Slope Roofing Products.
- D 7158 Standard Test Method for Wind Resistance of Sealed Asphalt Shingles (Uplift Force/Uplift Resistance Method).
- E 108 Standard Test Methods for Fire Tests of Roof Coverings.
- F 1667 Standard Specification for Driven Fasteners: Nails, Spikes, and Staples.
- G 21 Determining Resistance of Synthetic Polymers to Fungi.

D. Underwriter Laboratories (UL):

- 790 Standard Test Methods for Fire Test of Roof Coverings.
- 997 Wind Resistance of Prepared Roof Covering Materials.
- 1897 Uplift Tests for Roof Covering Systems
- 2218 Impact Resistance of Prepared Roof Covering Materials.
- 2390 Test Method for Wind Resistant Asphalt Shingles with Sealed Tabs.

E. Environmental Protection Agency (EPA): ENERGY STAR rating system.

F. Cool Roof Rating Council (CRRC): Product rating program.

G. California Building Standards Commission (CBSC):

California Building Code, California Code of Regulations Title 24

H. International Code Council (ICC):

International Residential Code (IRC)

International Building Code (IBC)

I. International Code Council Evaluation Service (ICC-ES)

ICC-ES Evaluation Reports

ICC-ES Acceptance Criteria

- J. National Roofing Contractors Association (NRCA)
- K. Underwriters Laboratories Evaluation Services (UL-ES):
UL-ES Evaluation Reports.
- L. US Green Building Council (USGBC): Leadership in Energy and Environmental Design (LEED).

1.04 SUBMITTALS

- A. Submit under provisions of 01 33 00.
- B. Product Data: Manufacturer's data sheets and detail drawings for each product to be used, including:
 - 1. Preparation instructions and recommendations.
 - 2. Storage and handling requirements and recommendations.
 - 3. Product literature.
 - 4. Installation methods.
- C. Selection Samples: Two complete sets of samples, representing the manufacturer's full range of available products and colors.
- D. Verification Samples: For each product and finish specified, two samples representing actual products and colors.
- E. Copy of Warranty: For warranty specified in 1.10 in this Section.

1.05 QUALITY ASSURANCE

- A. Shingles shall carry Underwriter's Laboratories Labels:
 - 1. UL® 790, Class A Fire Resistance
 - 2. UL® 997, Wind Resistance
 - 3. ASTM D3462 - D3462M - 10a Standard Specification for Asphalt Shingles Made from Glass Felt and Surfaced with Mineral Granules
- B. Manufacturer Qualifications: Provide all primary roofing products, including shingles, underlayment, leak barrier, and ventilation, by a single manufacturer.
- C. Installer Qualifications: Installer must be approved for the installation of all roofing products to be installed under this section.

1.06 REGULATORY REQUIREMENTS

- A. Provide a roofing system achieving an Underwriters Laboratories (UL) Class A fire classification.
- B. Install all roofing products in accordance with all federal, state, and local building codes.
- C. All work shall be performed in a manner consistent with current OSHA guidelines.

1.07 QUALITY ASSURANCE

- A. Manufacturer Qualifications: Provide all primary roofing products, including shingles, underlayment, leak barrier, and ventilation, by a single manufacturer.
- B. Installer Qualifications:
 - 1. The installer shall follow the shingle manufacturer's published installation instructions.

2. The installer shall be an approved applicator as defined and certified by the manufacturer.

1.08 DELIVERY, STORAGE, AND HANDLING

- A. Deliver materials to site in manufacturer's unopened bundles with labels intact and legible.
- B. Store all products in the manufacturer's unopened, labeled packaging until they are ready for installation.
- C. Handle and store materials on-site to prevent damage. Store products in a covered, ventilated area, at temperature not more than 110 degrees F (43 degrees C); do not store near steam pipes, radiators, or in direct sunlight.
- D. Store bundles on a flat surface. Do not stack products more than 2 pallets high. If stacking 2 pallets high, use separator boards to protect the shingles below. Store all rolls on end.
- E. Do not install underlayment or shingles on wet surfaces.
- F. Store and dispose of all solvent-based materials in accordance with all federal, state, and local regulations.
- G. For rooftop loading, lay shingle bundles flat. Do not bend over the ridge. Do not overload structure.

1.09 PROJECT CONDITIONS

- A. Maintain environmental conditions (temperature, humidity, and ventilation) within limits recommended by the manufacturer for optimum results. Do not install systems under environmental conditions outside the manufacturer's recommended limits.
 1. Proceed with work only when existing and forecasted weather conditions will permit work to be performed in accordance with manufacturer's recommendations.

1.10 WARRANTY

- A. Installer shall provide a 2-year labor and materials warranty.
- B. Manufacturer's Warranty: Provide to the Owner manufacturer's standard prorated warranty coverage for materials in the event of a material defect.
 1. Minimum 30-year

1.11 PREINSTALLATION CONFERENCE

- A. Prior to the scheduled commencement of the roofing installation and associated work, conduct a meeting at the project site with the installer, Consultant, Owner, Contractor, and any other persons directly involved with the performance of the work. The installer shall record conference discussions to include decisions, agreements, and open issues and furnish copies of recorded discussions to each attending party. The primary purpose of the meeting is to review foreseeable methods and procedures related to roofing work.
 1. Meet with Owner, Consultant, roofing Installer, and installers whose work interfaces with or affects roofing including installers of roof accessories and roof-mounted equipment.
 2. Review methods and procedures related to roofing installation, including manufacturer's written instructions.
 3. Review and finalize construction schedule and verify availability of materials, Installer's personnel, equipment, and facilities needed to make progress and avoid delays.
 4. Examine deck substrate conditions and finishes for compliance with requirements, including flatness and fastening.

5. Review structural loading limitations of roof deck during and after roofing.
6. Review base flashings, special roofing details, roof drainage, roof penetrations, equipment curbs, and condition of other construction that will affect the roofing system.
7. Review governing regulations and requirements for insurance and certificates if applicable.
8. Review temporary protection requirements for roofing system during and after installation.
9. Review roof observation and repair procedures after roofing installation.

1.12 SEQUENCING AND SCHEDULING

- A. Preparation work shall be limited to those areas that can be covered completely with the new shingle roof system on the same day or before the arrival of inclement weather.
- B. Arrange work sequence to avoid the use of newly completed roofing for storage, walking surface, or equipment traffic. Move equipment and material storage areas as work progresses.
- C. Repair all traffic-induced damage to the roof system the same day as the damage occurs.

PART 2 - MATERIALS

2.01 ASPHALT SHINGLES

- A. Architectural laminated asphalt shingles
 1. Landmark, by CertainTeed.
 2. Timberline HDZ, by GAF.
 3. Oakridge or Duration, by Owens-Corning.
 4. Cambridge, by IKO.
- B. Color: As selected from manufacturers' full range.
- C. In addition to materials required to complete the project, provide four (4) bundles of matching shingles and one (1) bundle of matching ridge cap for the Owner's use; store where directed by the Owner.

2.02 HIP AND RIDGE SHINGLES

- A. Provide hip and ridge shingles color formulated and designed for use with selected roof shingles as provided by the shingle manufacturer.

2.03 STARTER STRIP

- A. Self-sealing starter shingle designed for use with selected roof shingles as provided by the shingle manufacturer.

2.04 SELF-ADHERING ICE AND WATER BARRIER

- A. Compliant with ASTM D 1970 and UL Listed.
- B. Skid resistant surface, self-adhering, self-sealing, bituminous ice and water barrier (Leak Barrier) as provided by the shingle manufacturer.

2.05 BITUMINOUS MATERIALS

- A. Plastic roof cement: asphalt-based, non-asbestos conforming to ASTM D4586, Type II.

2.06 SHINGLE UNDERLAYMENT

- A. Premium, synthetic, water repellent, breather type non-asphaltic underlayment. UV stabilized polypropylene construction. Meets or exceeds ASTM D226 and D4869.

2.07 FASTENERS

- A. Fasteners: Galvanized steel, stainless steel, or aluminum nails; minimum 12 gauge shank with heads 3/8 inch (9.5 mm) diameter head.
- B. All fasteners must be driven flush with the shingle surface and length must be sufficient to penetrate solid wood at least 3/4 inch (19 mm) or through plywood or oriented strand board by at least 1/8 inch (3.2 mm) through APA rated roof sheathing. Note: Staples or needle-point nails are not acceptable for attaching the shingles; however, staples may be used for attaching the underlayment felt.
- C. Fasteners must comply with ASTM F 1667. Check local building codes.

2.08 ROOFING SEALANT

- A. Commercial-grade roofing sealant that provides a 100% watertight seal that keeps water out at the most vulnerable areas of your roof (roof protrusions, step flashings, skylights, chimneys, vents, gutters, etc.). Meets the performance criteria of ASTM D412, ASTM D2196, ASTM D1475, and ASTM D1644.

2.09 ATTIC VENTILATION

- A. Ridge Vents
 1. Rigid plastic ridge ventilator designed to allow the passage of hot air from attics. For use in conjunction with eave/ soffit intake ventilation products. Provides 20 sq. in NFVA per lineal foot. (Provide in 4' rigid lengths. Rolled ridge vent not allowed)
- B. Roof Louvers (attic vents)
 1. Rooftop mounted, metal exhaust ventilator designed to evacuate hot air from attics.
 - a. Style: either slant-back or square top (match existing)
 - b. Minimum 51 sq. in NFVA.

2.10 SHEET METAL FLASHING

- A. See Section 07 62 00

PART 3 - EXECUTION

3.01 EXAMINATION

- A. Prior to starting work, examine all roof decks on which work is to be applied for defects in materials and workmanship which may be detrimental to the proper installation or long-term performance of the shingles.
 1. Underlayment and shingles installed directly over roof insulation or similar type decks are not approved.
 2. Roof deck must be dry, minimum 25/32 inch (20 mm) thick, maximum 6 inches (152 mm) wide boards, or APA rated sheathing (exposure 1); minimum 3/8 inch (9.5 mm) plywood, minimum 7/16 inch (11 mm) orientated strand board. Consult your manufacturer for other approved constructions.
 3. Ventilation under roof deck must meet local code requirements or FHA Minimum Property Standards if there is no local code in effect.

- B. Do not begin installation until the roof deck has been properly prepared.
- C. If substrate preparation is the responsibility of another installer, notify Consultant of unsatisfactory preparation and gain written direction before proceeding. Commencement of installation constitutes acceptance of conditions and responsibility of the same.

3.02 PREPARATION

- A. Prepare surfaces using the methods recommended by the manufacturer for achieving the best results for the substrate under the project conditions.
- B. Remove all existing roofing, including fasteners and underlayment's down to the roof deck.
- C. Verify the installed roof deck is acceptable to receive shingles. Acceptable roof decks include the following:
 - 1. Lumber sheathing: 6-inch (152 mm) maximum width, 25/32 inch (18 mm) minimum thickness.
 - 2. Plywood sheathing: 3/8 inch (9.5 mm) minimum thickness Exposure 1-grade plywood sheathing as recommended by APA and in compliance with applicable Codes.
 - 3. OSB Panels: 7/16 inch (11 mm) minimum thickness non-veneer structural panels as recommended by APA and in compliance with applicable Codes.
 - 4. Spacing between boards or panels shall not exceed ¼ inch (6 mm) between roof boards or between plywood or OSB sheathing panels.
- D. Verify that the deck is dry, structurally sound, clean, and smooth. It shall be free of any depressions, waves, and projections. Cover with sheet metal all holes over 1 inch (25 mm) in diameter, cracks over ½ inch (13 mm) in width, loose knots, and excessively resinous areas.
- E. Verify that the deck is structurally sound and free of deteriorated decking. All deteriorated and damaged decking shall be removed and replaced with new materials.
- F. Clean deck surfaces thoroughly prior to the installation of self-sealing ice and water barrier and underlayment.

3.03 INSTALLATION OF UNDERLAYMENTS

- A. Install shingle underlayment in accordance with the manufacturer's instructions.
 - 1. Install using methods recommended by shingle manufacturer, in accordance with local building codes. When local codes and application instructions conflict, the more stringent requirements shall take precedence.
- B. Eaves
 - 1. Install self-adhering leak barrier from the eaves edge of the roof up the slope a full 69 inches, but not less than 24 inches (610 mm) beyond the interior edge of the exterior wall. Lap ends 6 inches (152 mm).
- C. Valleys:
 - 1. Install self-adhering ice and water barrier at least 36 (914mm) inches wide and centered on the valley. Lap ends 6 inches (152mm) and seal.
 - 2. Where valleys are indicated to be "open valleys", install metal flashing over self-adhering ice and water barrier before roof deck underlayment is installed; DO NOT place fasteners through the metal flashing more than 1 inch (25 mm) from the outside edge of metal flashing. Secure metal flashing by using valley metal with formed edge and secure with clips. (See Section 07 62 00)

- D. Roof Deck:
 - 1. Install one layer of shingle underlayment protection over the entire area not protected by leak barrier at the eaves or valley. Install sheets horizontally so water sheds and fasten in place per manufacturer's written instructions.
- E. Penetrations:
 - 1. Vent pipes:
 - a. Install a 24 inch (610 mm) square piece of leak barrier membrane lapping over shingle underlayment; seal tightly to pipe.
 - 2. Vertical walls:
 - a. Install leak barrier membrane extending at least 6 inches (152mm) up the wall and 12 inches (305mm) on to the roof surface. Lap the leak barrier membrane over the shingle underlayment.

3.04 SHINGLE INSTALLATION

- A. General:
 - 1. Install shingles in accordance with manufacturers printed instructions and local building codes. When local codes and application instructions conflict, the more stringent requirements shall take precedence.
 - 2. Handle carefully in hot weather to avoid scuffing the surfacing, or damaging the shingle edges.
- B. Placement and Nailing:
 - 1. Install shingles in accordance with manufacturers printed installation instructions required to achieve required wind uplift resistance and proper installation.
 - 2. The placement of nails varies based on the type of shingle specified. Consult the shingle manufacturer's application instructions for the specified shingle for details.
 - 3. Nails must be driven flush with the shingle surface. Do not overdrive or underdrive the nails.
 - 4. Shingle offset varies based on the type of shingle specified. Consult the shingle manufacturer's application instructions for the specified shingle for details.
- C. Install starter course at the lowest roof edge and along rake edge of shingles extending ½ inch (13 mm) over the edge of the roof or installed edge metal.
- D. Install first and successive courses of shingles stepping diagonally up and across roof deck with manufacturer's recommended offset at each succeeding course. Maintain uniform exposure of shingles at each succeeding course.
- E. Fasten shingles to deck with manufacturer's recommended number of roofing nails per shingle but not less than six (6) per shingle.
- F. Install ridge vents and shingles at valleys, hips, and ridges in accordance with Construction Drawings.

3.05 INSTALLATION OF ATTIC VENTILATION

- A. Ridge ventilation
 - 1. Install ridge vent along the entire length of ridges:
 - 2. Cut continuous vent slots through the sheathing, stopping 12 inches from each end of the ridge.
 - 3. Install ridge vent material along the full length of the ridge stopping short of rake edges/ridges/valleys 24 inches.
 - 4. Butt ends of ridge vent material and join using roofing cement.

3.06 ADJUSTING & CLEANING

- A. Repair of deficiencies:
 - 1. Installation or details noted as deficient during Final Review must be repaired and corrected by Contractor, and made ready for review, within five (5) working days.
 - 2. Restore damaged surfaces in accordance with 02 51 29
- B. Clean-up:
 - 1. Immediately upon job completion, roof, wall, and flashing surfaces shall be cleaned of all debris.
 - 2. Collect all fasteners and debris from the site and grounds.
 - 3. Clean gutters and downspouts of all debris.

END OF SECTION

SHEET METAL FLASHING AND TRIM

PART 1 – GENERAL

1.01 RELATED DOCUMENTS

- A. Drawings and general provisions of the Contract, including General and Supplementary Conditions and Division 1 Specification Sections, apply to this Section

1.02 SUMMARY

- A. Section Includes:
 - 1. Formed roof flashing and trim.
 - 2. Formed gutters and downspouts.
 - 3. Pre-manufactured metal flashing.

1.03 PERFORMANCE REQUIREMENTS

- A. General: Install sheet metal flashing and trim to withstand wind loads, structural movement, thermally induced movement, and exposure to weather without failing, rattling, leaking, and fastener disengagement.
- B. Water Infiltration: Provide sheet metal flashing and trim that do not allow water infiltration to building interior.

1.04 SUBMITTALS

- A. Product Data: For each type of product indicated. Include construction details, material descriptions, dimensions of individual components and profiles, and finishes.
- B. Samples for Verification: For each type of exposed finish required, of size indicated below:
 - 1. Trim: 12 inches (300 mm) long. Include fasteners and other exposed accessories.
 - 2. Accessories: Full-size Sample.

1.05 QUALITY ASSURANCE

- A. Sheet Metal Flashing and Trim Standard: Comply with SMACNA's "Architectural Sheet Metal Manual." Conform to dimensions and profiles shown unless more stringent requirements are indicated.
- B. Pre-installation Conference: Conduct conference at Project site to comply with requirements in Section 01200 "Project Meetings."
 - 1. Meet with Owner, Consultant, Owner's insurer if applicable, Installer, and installers whose work interfaces with or affects sheet metal flashing and trim including installers of other building components.
 - 2. Review methods and procedures related to sheet metal flashing and trim.
 - 3. Examine substrate conditions for compliance with requirements, including flatness and attachment to structural members.
 - 4. Document proceedings, including corrective measures and actions required, and furnish copy of record to each participant.

1.06 DELIVERY, STORAGE AND HANDLING

- A. Deliver sheet metal flashing materials and fabrications undamaged. Protect sheet metal flashing and trim materials and fabrications during transportation and handling.
- B. Unload, store, and install sheet metal flashing materials and fabrications in a manner to prevent bending, warping, twisting, and surface damage.
- C. Stack materials on platforms or pallets, covered with suitable weathertight and ventilated covering. Do not store sheet metal flashing and trim materials in contact with other materials that might cause staining, denting, or other surface damage.

1.07 COORDINATION

- A. Coordinate installation of sheet metal flashing and trim with interfacing and adjoining construction to provide a leakproof, secure, and noncorrosive installation.
- B. Where sheet metal flashings are incorporated into other building systems, installation shall commence concurrently with the installation of such building components to prevent delays.
- C. Where sheet metal flashings are designed to provide counter flashing, installation shall commence after the installation of other building components has been completed in accordance with the specifications.

1.08 SEQUENCING AND SCHEDULING

- A. Owner will occupy portions of building immediately adjacent to work area. Conduct activities so Owner's operations will not be disrupted. Provide not less than 48 hours' notice to Owner of activities that will affect Owner's operations.

PART 2 – PRODUCTS

2.01 SHEET METALS

- A. Aluminum Sheet: ASTM B 209, Alloy 3003, 3004, 3105, or 5005, Temper suitable for forming and structural performance required, but not less than H14.
 - 1. Pre-finished.
 - a. Color: Manufacturer's standard color which will be selected by the Owner.
- B. Prefinished galvanized: AISA0-G90 Extra Smooth, minimum spangle, tension leveled, hot-dipped galvanized steel conforming to ASTM A653:
 - 1. Finish shall consist of primer on both sides, minimum 0.25-mil thickness, followed by a 70% Kynar 500® resin premium fluoropolymer (PVDF) coating on one side to achieve a 1.0 mil (+/- 0.1-mil) dry-film thickness.
 - a. Manufacturer's standard color which will be selected by the Owner.

2.02 FASTENERS

- A. Unless specified otherwise in the Construction Drawings or elsewhere in the project specifications, sheet metal fasteners shall comply with this section.

- B. Fasteners: Wood screws, annular threaded nails, self-tapping screws, self-locking rivets and bolts, and other suitable fasteners designed to withstand design loads:
1. Exposed Screw Fasteners: Heads matching color of sheet metal by means of plastic caps or factory-applied coating. Use only where concealed fasteners cannot be used.
 - a. Sheet Metal to Sheet Metal: Self Drilling, self-tapping, gasketed #10 Hex Washer Head sheet metal screw. Length as required for application, but no less than three threads pitches into metal.
 - b. Sheet Metal to Wood: Gasketed Hex Washer Head wood screw. Size and length as required for application but no less than #10 size and 1 inch in length.
 - c. Sheet Metal to masonry: Corrosion resistant pre-drilled gasketed masonry screws with hex washer head, minimum 3/16" thickness; length to provide embedment as required by fastener manufacturer.
 2. Concealed Screw Fasteners:
 - a. Sheet Metal to Sheet Metal: #10 Self Drilling, self-tapping, Phillips Pan Head sheet metal screw. Length as required for application, but no less than three threads pitches into metal.
 - b. Sheet Metal to Wood: #10 Phillips Pan Head Wood Screw. Size and length as required for application, but no less than #10 size and 1 inch in length.
 - c. Sheet Metal to masonry: Corrosion resistant pre-drilled masonry screws with hex washer head, minimum 3/16" thickness; length to provide embedment as required by fastener manufacturer.
 3. Nails: for use where roof edge flashing, cleats, and other flashings are fastened to wood substrate and whose nailing flanges are covered by roof materials or finish metal.
 - a. Standard round wire; minimum 12 gauge shank, smooth, barbed or deformed shank, with heads 3/8 inch (9mm) in diameter.
 - b. Length: 1.25-inches
- C. General fastener requirements (unless otherwise noted):
1. Fastener types for given metal types:
 - a. Galvanized or Prepainted, Metallic-Coated Steel: Use stainless-steel fasteners.
 - b. Aluminum: Use aluminum or stainless-steel fasteners.
 - c. Stainless Steel: Use stainless-steel fasteners.
- D. Blind Fasteners: High-strength aluminum, galvanized or stainless-steel rivets.

2.03 MISCELLANEOUS MATERIALS

- A. General: Provide materials and types of fasteners, solder, welding rods, protective coatings, separators, sealants, and other miscellaneous items as required for complete sheet metal flashing and trim installation.
- B. Elastomeric Sealant
1. Polyurethane, ASTM C 920, Grade NS, Class 25, Type S.

2.04 FABRICATION, GENERAL

- A. General:
1. Custom fabricate sheet metal flashing and trim to comply with recommendations in SMACNA's "Architectural Sheet Metal Manual" that apply to design, dimensions, metal, and other characteristics of item indicated. Shop fabricate items where practicable. Obtain field measurements for accurate fit before shop fabrication.
 2. All finish flashings, where applicable, must be fully engaged and continuously crimped onto the underlying cleat.
 3. All points where the sheet metal flashing ends or transitions into a different flashing detail shall be flashed with a field-formed sheet metal closure. The use of mastic or excessive caulking shall not be acceptable.

- B. Fabricate sheet metal flashing and trim in thickness or weight needed to comply with performance requirements, but not less than that specified for each application and metal.
- C. Fabricate sheet metal flashing and trim without excessive oil canning, buckling, and tool marks and true to line and levels indicated, with exposed edges folded back to form hems.
- D. Sealed Joints: Form nonexpanding but movable joints in metal to accommodate elastomeric sealant to comply with SMACNA recommendations.
- E. Expansion Provisions: Where lapped or bayonet-type expansion provisions in the Work cannot be used, form expansion joints of intermeshing hooked flanges, not less than 1 inch (25 mm) deep, filled with elastomeric sealant concealed within joints.
- F. Conceal fasteners and expansion provisions where possible on exposed-to-view sheet metal flashing and trim, unless otherwise indicated.

2.05 ROOF SHEET METAL FABRICATIONS

- A. Seamless gutters:
 - 1. Roll form 'K'-style gutter in continuous lengths.
 - a. Size
 - 1) Match existing
 - b. The front edge of the gutter shall be a minimum of 1-inch lower than the back apron to facilitate overflow.
 - 2. Fabricate from 0.027" thick aluminum coil stock.
 - 3. Accessories:
 - a. Fabricate gutter straps 1-1/2-inches wide from 0.050 inch thick aluminum sheet steel, or provide pre-manufactured heavy duty, hidden, screw-type hangers designed for use with K-Style gutter.
 - b. Fabricate sections with corners, end closures or expansion joint closures using the applicable solid joint procedure described below.
 - c. Fabricate downspout outlets to extend 3-inches below gutter.
 - 4. Joint Style:
 - a. Solid joints:
 - 1) Lap sheet metal sections 2-inches, minimum.
 - 2) Install butyl tape caulk between sections.
 - 3) Fasten with pop-rivets on 2-inch maximum centers.
- B. Downspouts:
 - 1. Fabricate from the following material:
 - a. Prefinished Aluminum: 0.027 inch thick.
 - 2. Fabricate or roll-form:
 - a. Dimensions: match existing.
 - b. Style: Rectangular; corrugated
 - 3. Fabricate solid elbow units to extend 6-inches minimum, in each direction, measured from the center of the joint. Fabricate using the applicable solid joint procedure described below.
 - 4. Solid joints:
 - a. Lap sheet metal sections 2-inches, minimum.
 - b. Fasten with pop-rivets on 2-inch maximum centers.
- C. Step Flashing:
 - 1. Fabricate of size required to install one step flashing per course of shingles, lapping each flashing 2 inches minimum and extending 2.5 inches onto roof surface and 2.5 inches up the wall.
 - 2. Fabricate from the following material:
 - a. Aluminum: 0.012 inch thick

- D. Eave Apron Flashing (drip edge at eave):
 - 1. Provide premanufactured flashings in minimum 96-inch (2400-mm) long, but not exceeding 10-foot (3-m) long sections.
 - 2. Provide roof edge flashings from the following material:
 - a. Prefinished Aluminum: .019 inch thick
 - 3. Shape and Size:
 - a. Under-bent to match slope of roof
 - b. Per profile shown in the Construction Drawings
 - 4. Joint Style:
 - a. Lap 2-inches (50-mm).
 - b. Apply a continuous bead of sealant between lapped sections.

- E. Drip Edge (along rake edge):
 - 1. Provide premanufactured flashings in minimum 96-inch (2400-mm) long, but not exceeding 10-foot (3-m) long sections.
 - 2. Provide roof edge flashings from the following material:
 - a. Prefinished Aluminum: .019 inch thick
 - 3. Shape and Size:
 - a. Per profile shown in the Construction Drawings
 - 4. Joint Style:
 - a. Lap 2-inches (50-mm).
 - b. Apply a continuous bead of sealant between lapped sections.

- F. Sheet Metal Valley Liner Flashing:
 - 1. 20-inch wide galvanized roll valley flashing

2.06 FINISHES

- A. Comply with NAAMM's "Metal Finishes Manual for Architectural and Metal Products" for recommendations for applying and designating finishes.
- B. Protect mechanical and painted finishes on exposed surfaces from damage by applying a strippable, temporary protective covering before shipping.
- C. Appearance of Finished Work: Variations in appearance of abutting or adjacent pieces are acceptable if they are within one-half of the range of approved Samples. Noticeable variations in the same piece are not acceptable. Variations in appearance of other components are acceptable if they are within the range of approved Samples and are assembled or installed to minimize contrast.

PART 3 – EXECUTION

3.01 EXAMINATION

- A. Examine substrates, areas, and conditions, with installer present, to verify actual locations, dimensions and other conditions affecting performance of work:
 - 1. Verify that substrate is sound, dry, smooth, clean, sloped for drainage, and securely anchored.
 - 2. Proceed with installation only after unsatisfactory conditions have been corrected.

3.02 INSTALLATION, GENERAL

- A. General: Anchor sheet metal flashing and trim and other components of the Work securely in place, with provisions for thermal and structural movement. Use fasteners, solder, welding rods, protective coatings, separators, sealants, and other miscellaneous items as required to complete sheet metal flashing and trim system:

1. Torch cutting of sheet metal flashing and trim is not permitted.
- B. Install exposed sheet metal flashing and trim without excessive oil canning, buckling, and tool marks.
- C. Install sheet metal flashing and trim true to line and levels indicated. Provide uniform, neat seams with minimum exposure of solder, welds, and elastomeric sealant.
- D. Install sheet metal flashing and trim to fit substrates and to result in watertight performance. Verify shapes and dimensions of surfaces to be covered before fabricating sheet metal.
- E. Seal joints with elastomeric sealant as required for watertight construction.
 1. Where sealant-filled joints are used, embed hooked flanges of joint members not less than 1 inch (25 mm) into sealant. Form joints to completely conceal sealant. When ambient temperature at time of installation is moderate, between 40 and 70 deg F (4 and 21 deg C), set joint members for 50 percent movement either way. Adjust setting proportionately for installation at higher ambient temperatures. Do not install sealant-type joints at temperatures below 40 deg F (4 deg C).

3.03 FABRICATED ROOF FLASHING INSTALLATION

- A. General: Install sheet metal roof flashing and trim to comply with performance requirements, sheet metal manufacturer's written installation instructions, and SMACNA's "Architectural Sheet Metal Manual." Provide concealed fasteners where possible, set units true to line, and level as indicated. Install work with laps, joints, and seams that will be permanently watertight.
- B. Seamless gutters
 1. At installation, join main sections using the applicable solid joint procedure described above. In addition,:
 - a. Hang gutter segments with a positive slope-to-drain between the gutter end or expansion joint and the downspout outlet(s).
 - b. Install gutter straps at 24-inches on center.
 - c. Where required, cut openings and join downspout outlets to bottom of gutter using the applicable solid joint procedure described above.
- C. Downspouts
 1. At installation, join sections using the lapped joint procedure described above.
 2. Secure downspouts to wall at 10'-0" on center maximum with straps per approved shop drawings or submittals.
 3. Install corners and lengths as needed to ensure downspouts follows the profile of the exterior of the building and/or matches existing downspouts location/direction.
- D. Rake Edge and Eave Apron Flashing
 1. Coordinate installation with installation of other roofing materials.
 2. Install over leak barrier and push tight to fascia/gutter.
 3. Fasten to roof deck with roofing nails: two (2) rows 6-inches on center staggered.
- E. Step Flashing:
 1. Coordinate installation of step flashing with installation of roof and exterior finish, where applicable.
 2. In alternating fashion, install new shingles and sheet metal step flashings up slope. Step flashings should be placed just above the exposure line.
 3. Fasten each piece to the roof deck with one roofing nail in the top corner.
- F. Soil Stack Flashing:
 1. Coordinate installation of soil stack flashing with installation of roofing and other items penetrating roof.

2. Set in plastic roof cement.
3. Turn lead flashing down inside vent piping 2-inches minimum, being careful not to block vent piping with flashing.

3.04 CLEANING AND PROTECTION

- A. Clean exposed metal surfaces of substances that interfere with uniform oxidation and weathering.
- B. Clean and neutralize flux materials. Clean off excess solder and sealants.
- C. Remove temporary protective coverings and strippable films as sheet metal flashing and trim are installed. On completion of installation, clean finished surfaces, including removing unused fasteners, metal filings, pop rivet stems, and pieces of flashing. Maintain in a clean condition during construction.
- D. Replace sheet metal flashing and trim that have been damaged or that have deteriorated beyond successful repair by finish touchup or similar minor repair procedures.
- E. Repair of deficiencies:
 1. Installation or details noted as deficient during Final Review must be repaired and corrected by Contractor, and made ready for review, within five (5) working days.

END OF SECTION

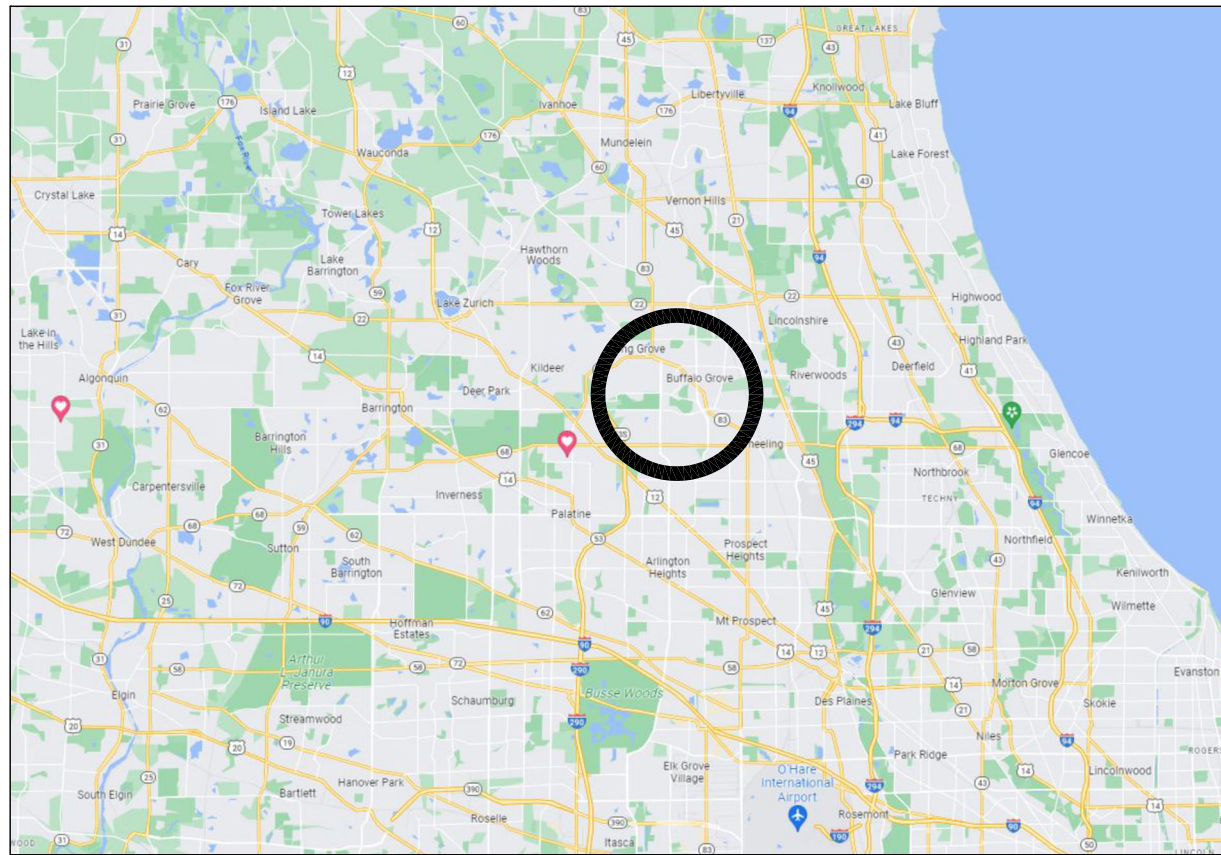

PROJECT: MULTI-SITE - ROOF SPECIFICATIONS
BUFFALO GROVE, IL 60089

OWNER: VILLAGE OF BUFFALO GROVE
51 RAUPP BOULEVARD
BUFFALO GROVE, IL 60089

CONSULTANT: INDUSTRIAL ROOFING SERVICES
13000 WEST SILVER SPRING DRIVE
BUTLER, WISCONSIN 53007
(262) 432-0500

IRS JOB #: 18190

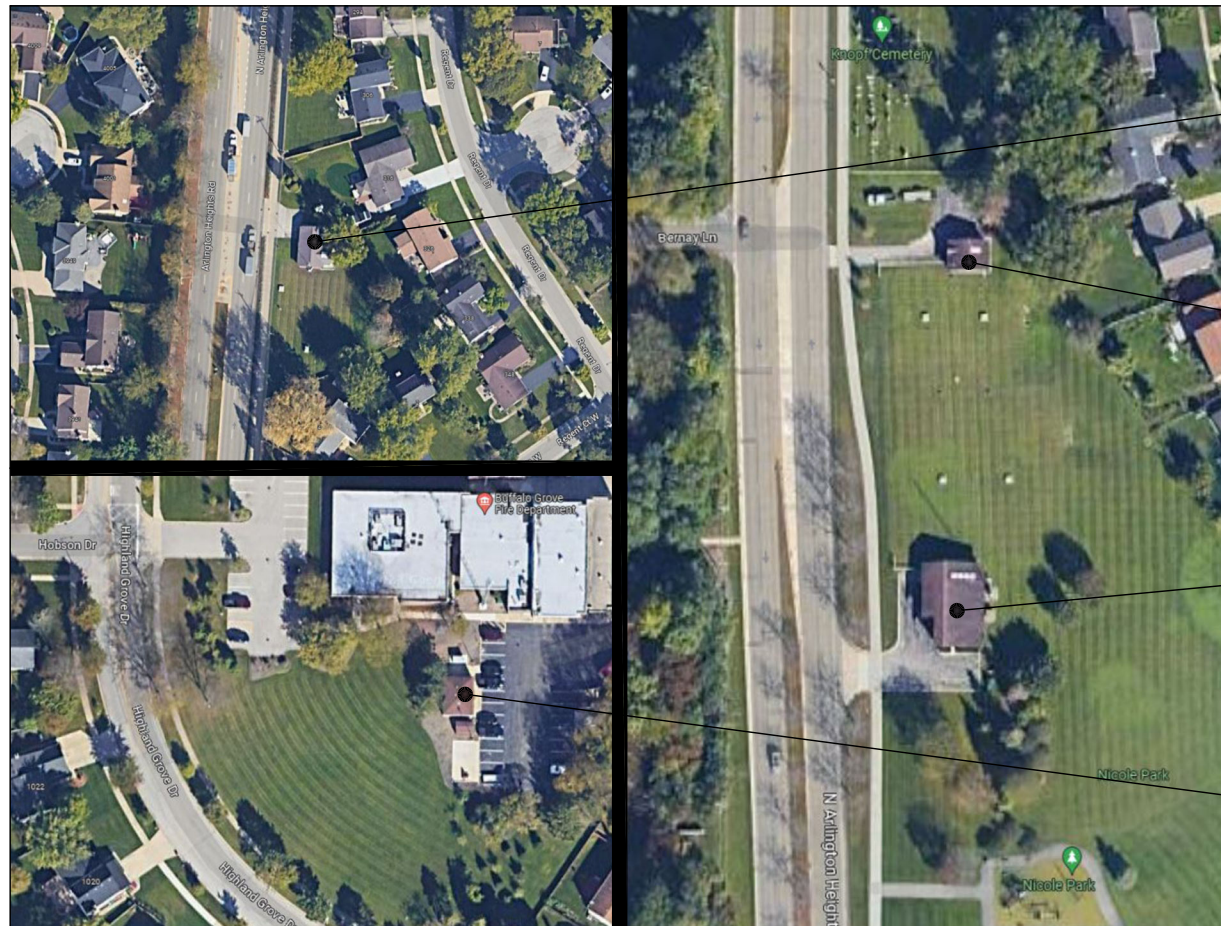

345 ARLINGTON HEIGHTS ROAD
BUFFALO GROVE, IL

525 N ARLINGTON HEIGHTS ROAD
BUFFALO GROVE, IL

511 N ARLINGTON HEIGHTS ROAD
BUFFALO GROVE, IL

109 DEERFIELD PARKWAY
BUFFALO GROVE, IL

SHEET INDEX

- A0 - COVER SHEET
- A4.0 - 511 N ARLINGTON - ROOF SPECIFICATION
- A4.1 - 345 ARLINGTON - ROOF SPECIFICATION
- A4.2 - 525 N ARLINGTON - ROOF SPECIFICATION
- A4.3 - 109 DEERFIELD - ROOF SPECIFICATION
- A5.0 - ROOF LAYOUTS
- A6.0 - PERIMETER DETAILS
- A6.1 - PERIMETER DETAILS
- A7.0 - TYPICAL DETAILS
- A8.0 - PENETRATION DETAILS
- A8.1 - PENETRATION DETAILS
- A9.0 - SHEET METAL DETAILS

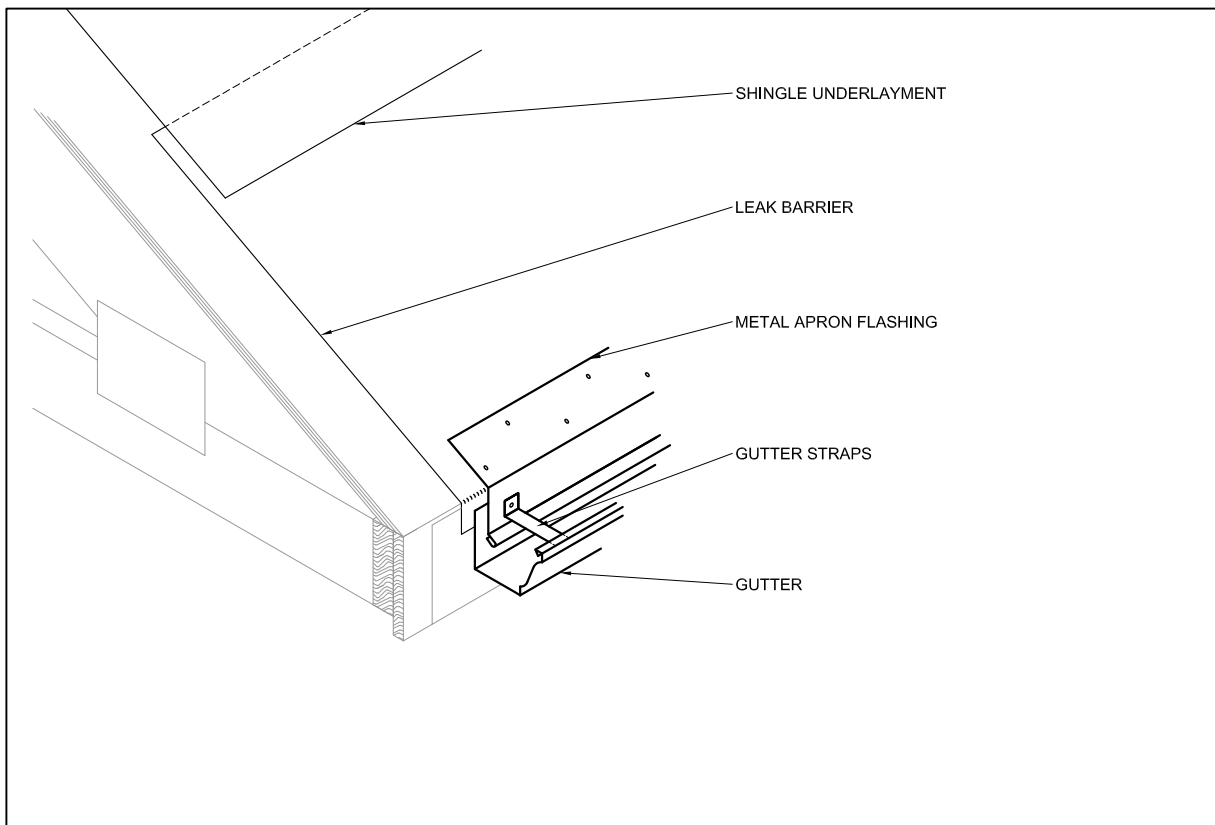

P-1: EAVE APRON FLASHING
NOT TO SCALE

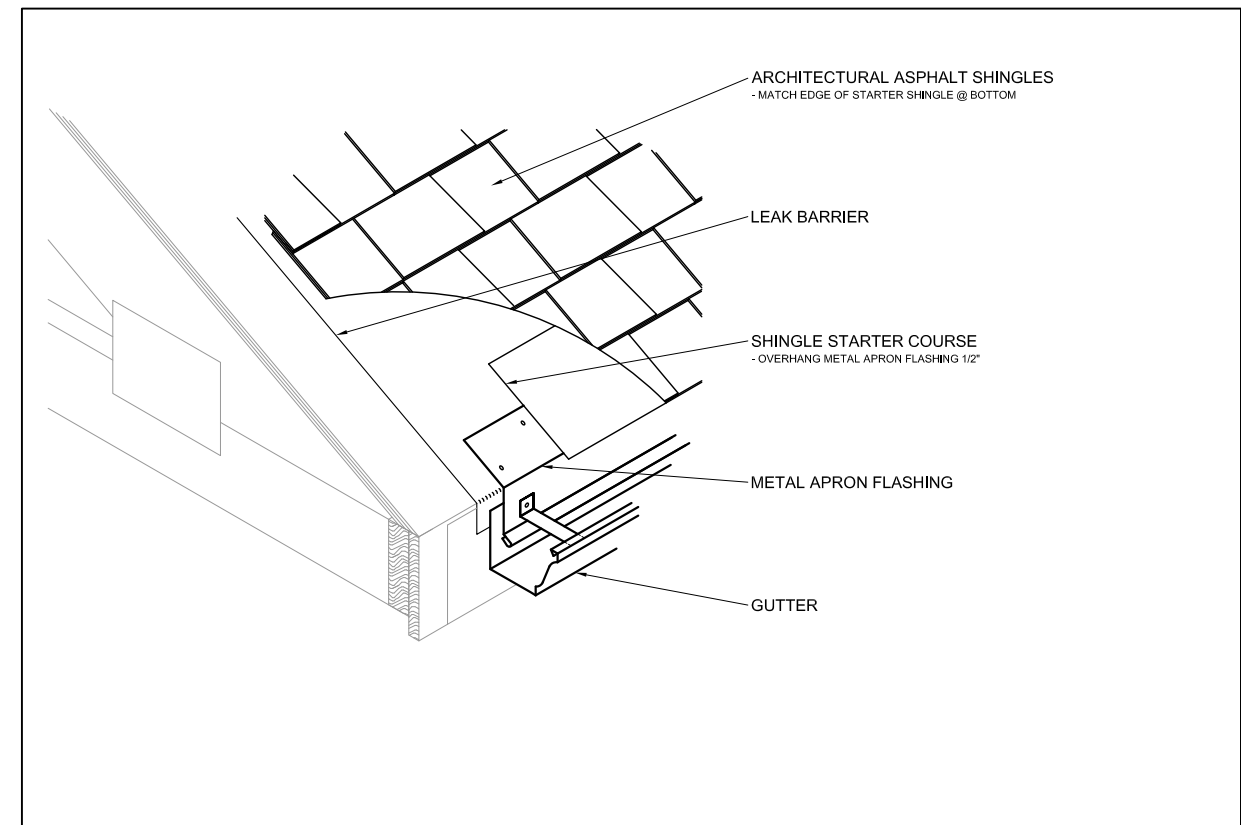

P-2: SHINGLES AT EAVE
NOT TO SCALE

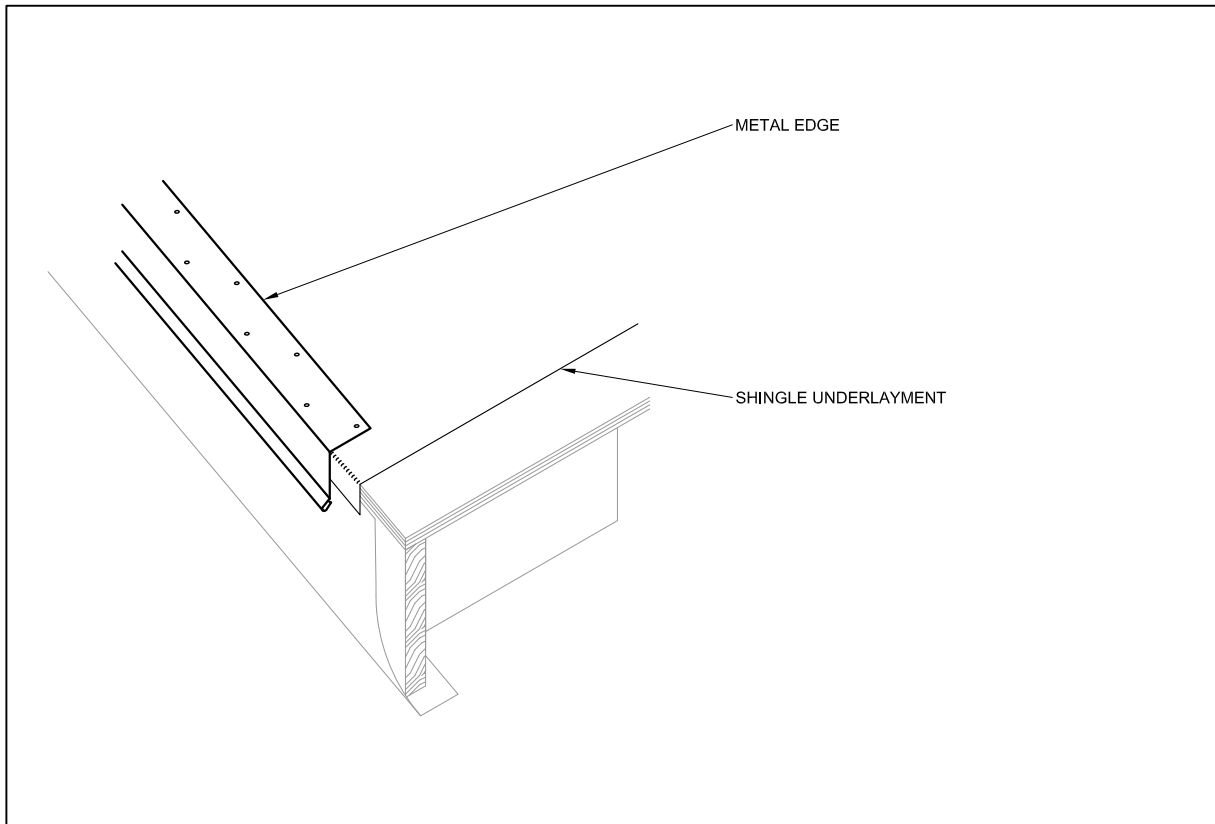

P-3: RAKE EDGE METAL
NOT TO SCALE

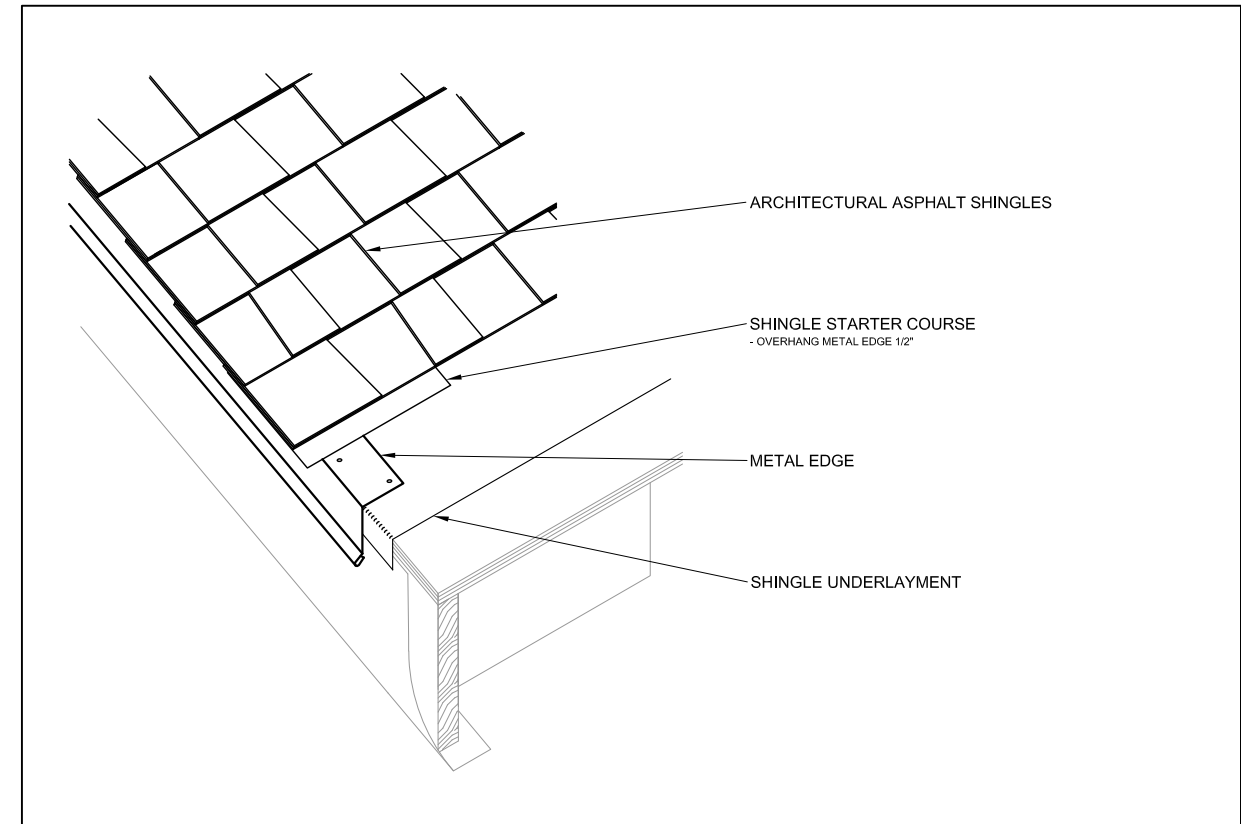

P-4: SHINGLES AT RAKE
NOT TO SCALE

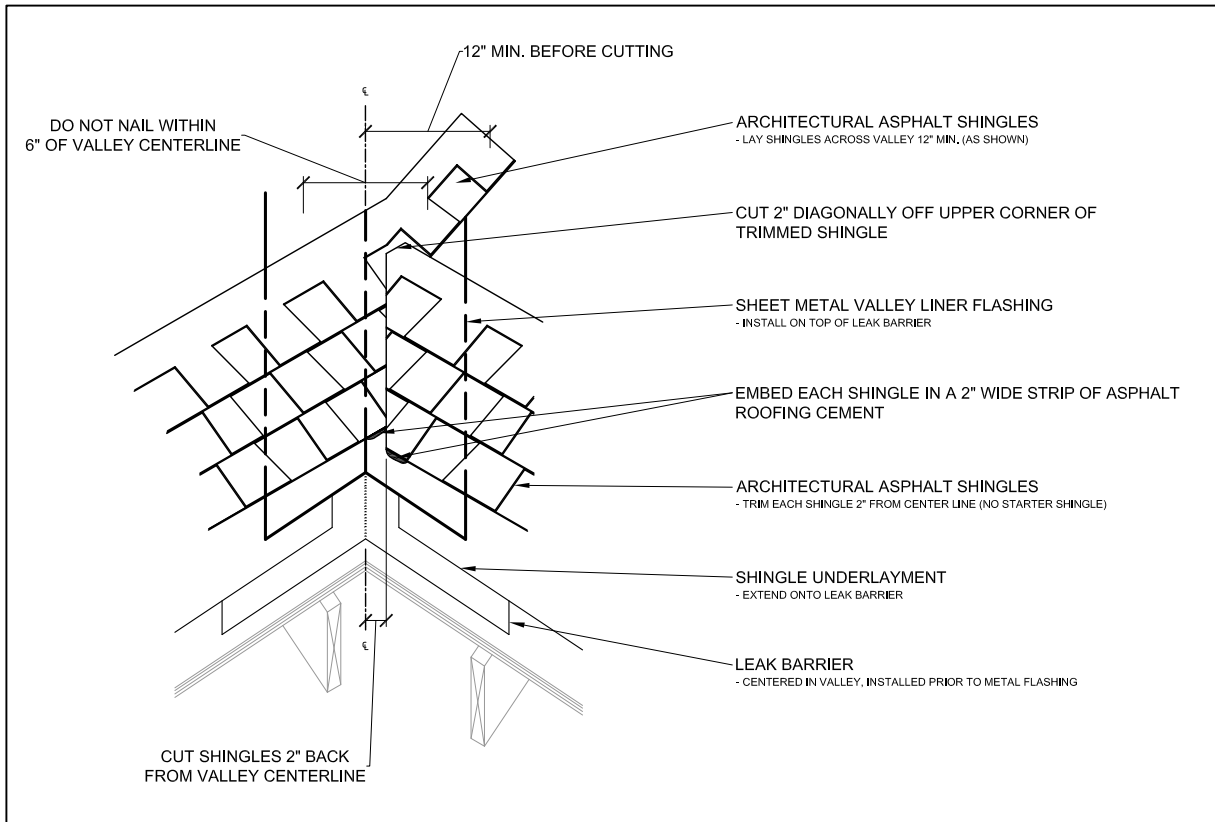

P-5: CLOSED CUT VALLEY
NOT TO SCALE

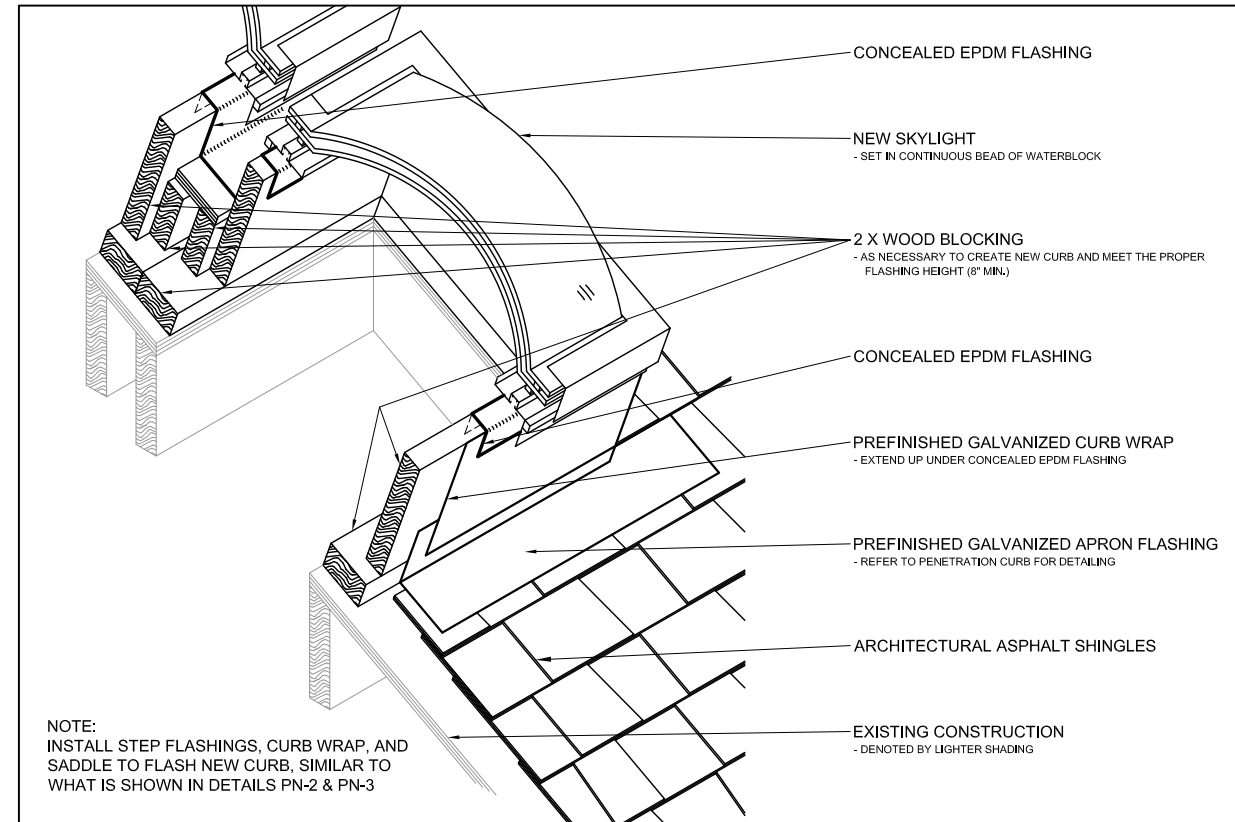

P-6: NEW SKYLIGHT CURBING (511 BUILDING)
NOT TO SCALE

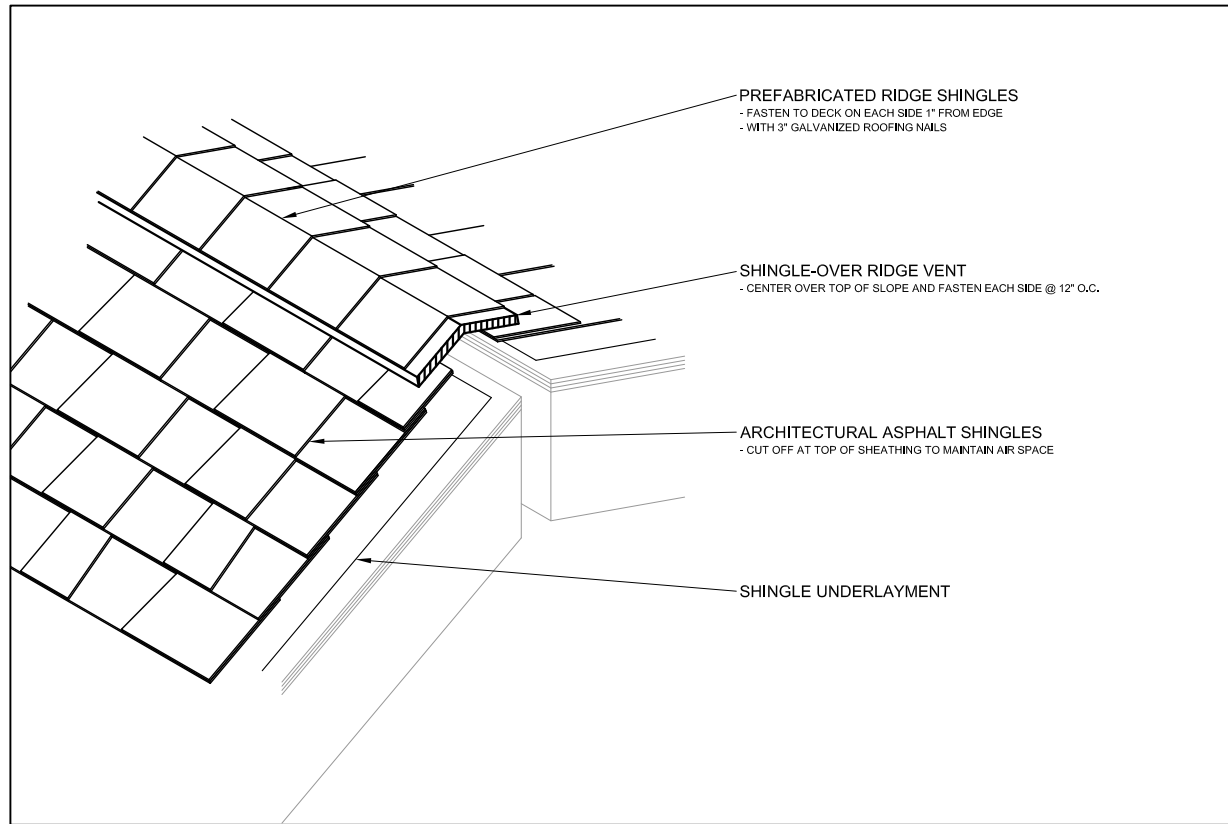

T-1: VENTED RIDGE
NOT TO SCALE

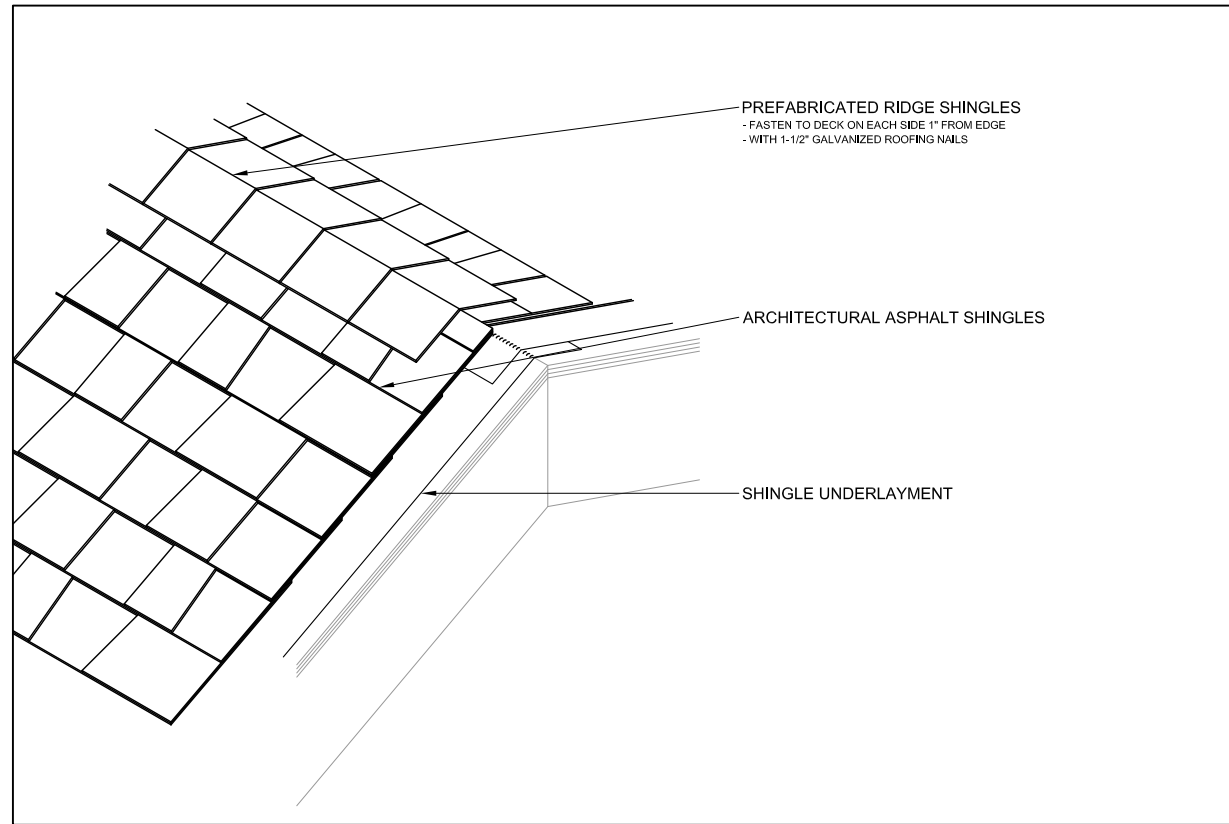

T-2: NON-VENTED RIDGE
NOT TO SCALE

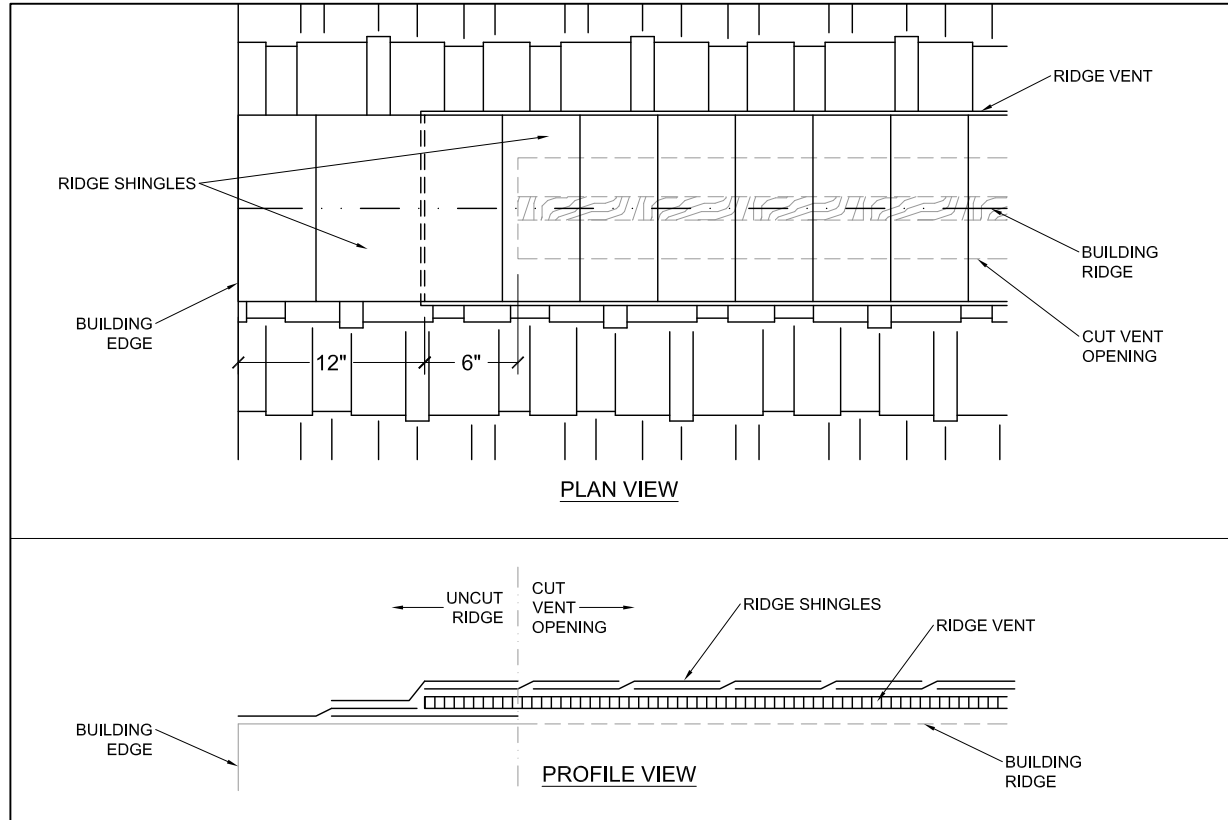

T-3: VENTED RIDGE TERMINATION
NOT TO SCALE

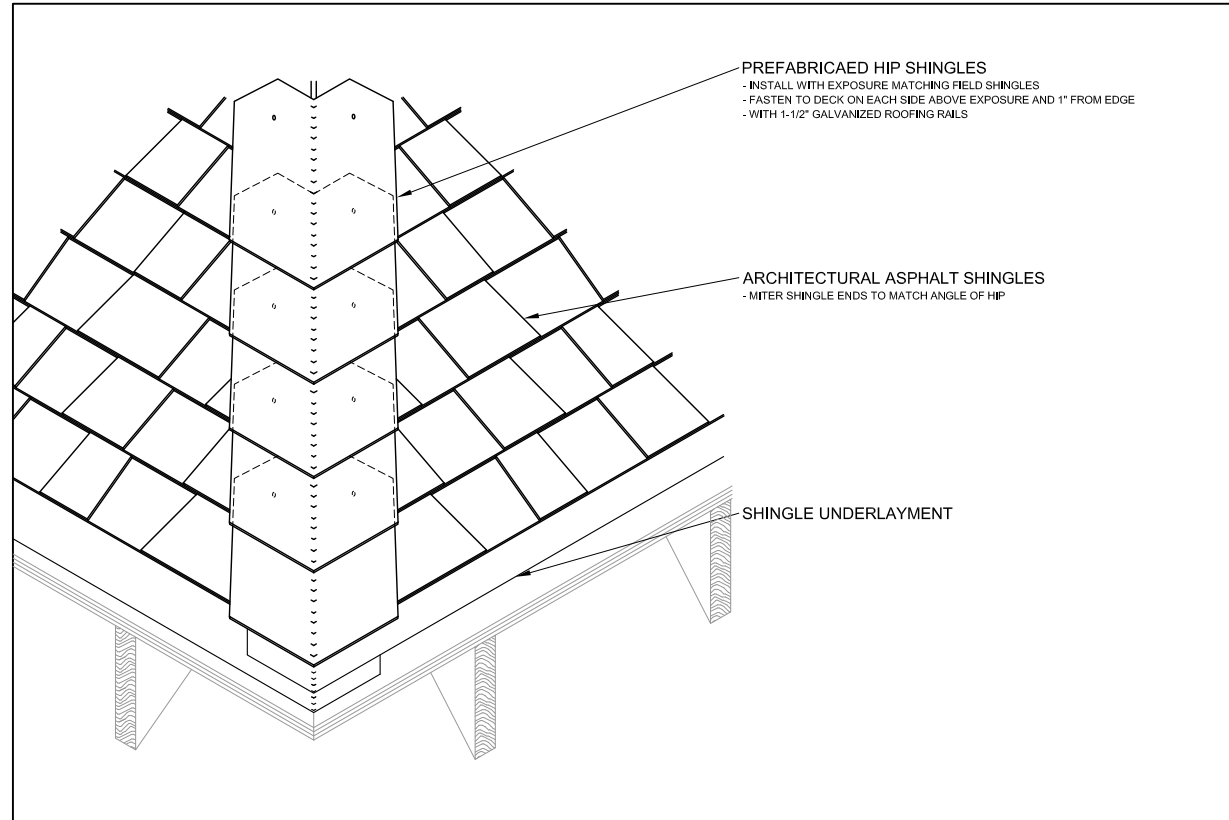

T-4: HIP
NOT TO SCALE

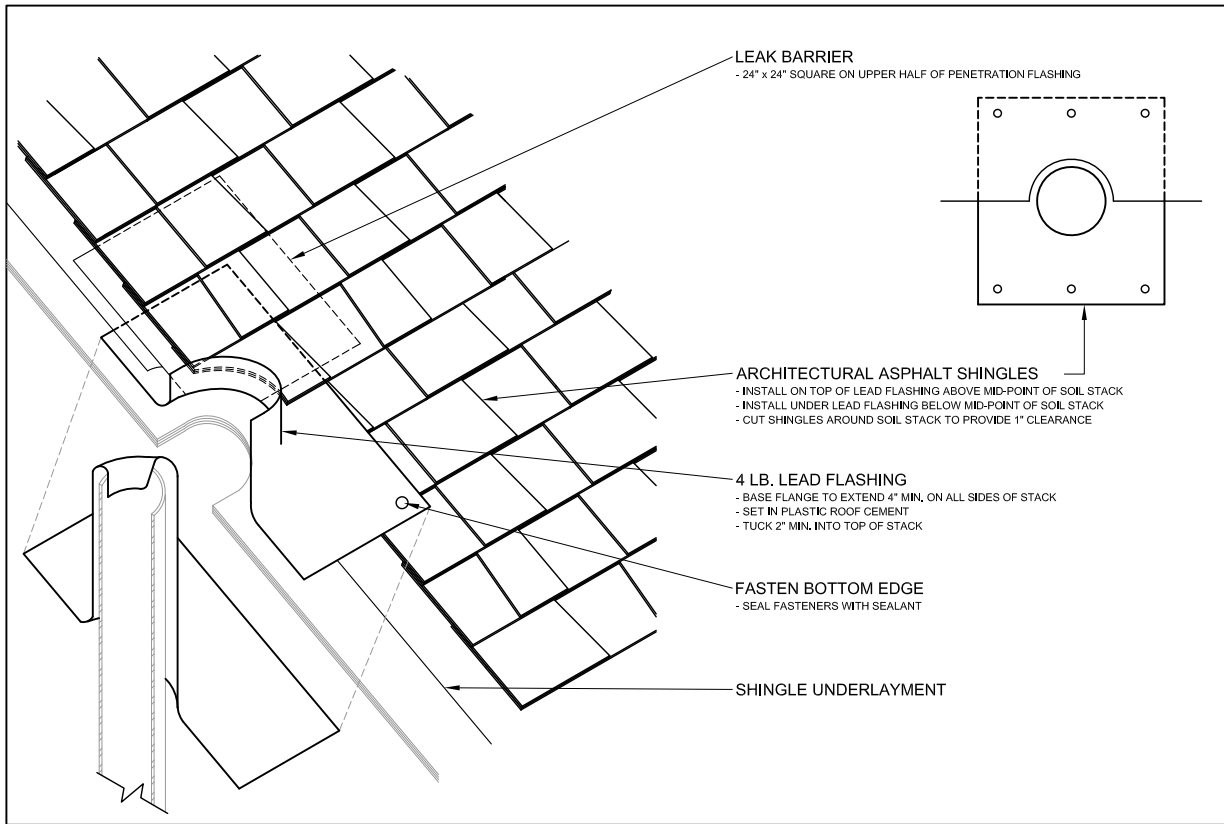

PN-1: SOIL STACK WITH LEAD FLASHING
NOT TO SCALE

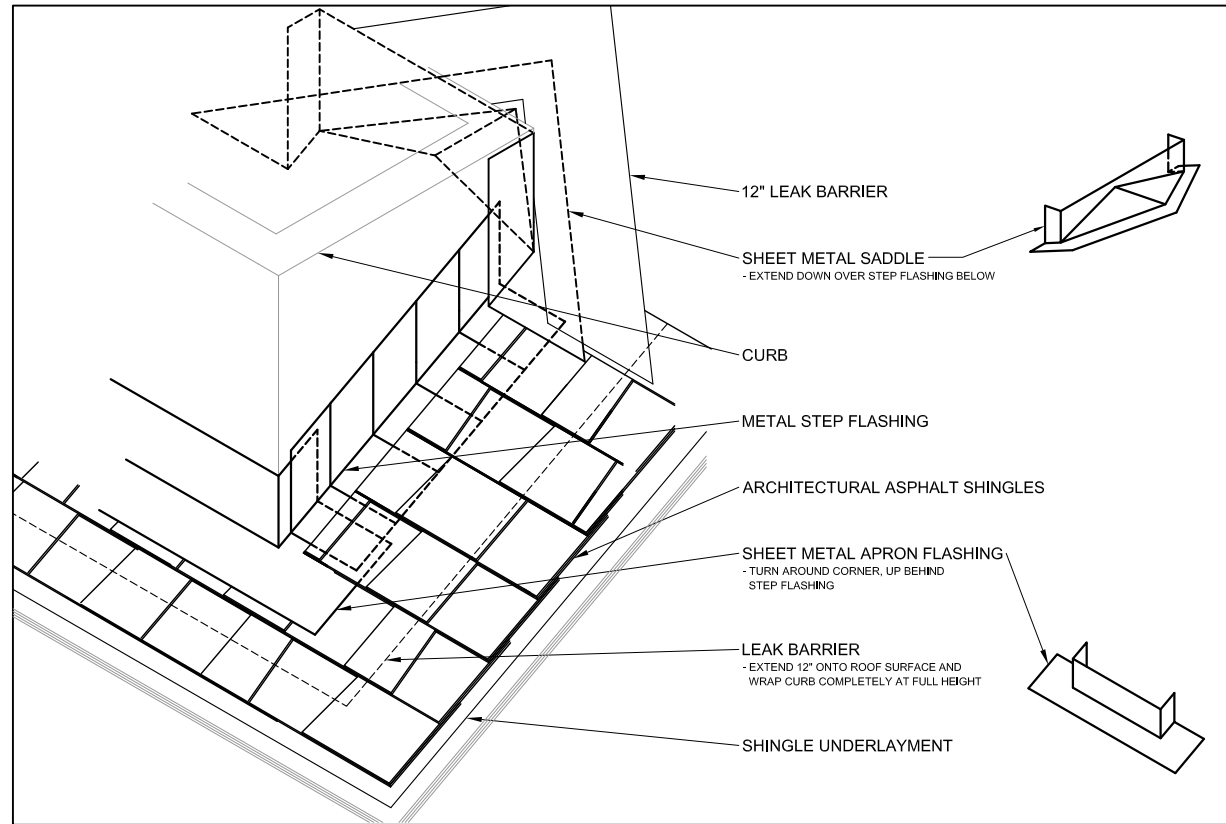

PN-2: ROOF CURB STEP 1 OF 2
NOT TO SCALE

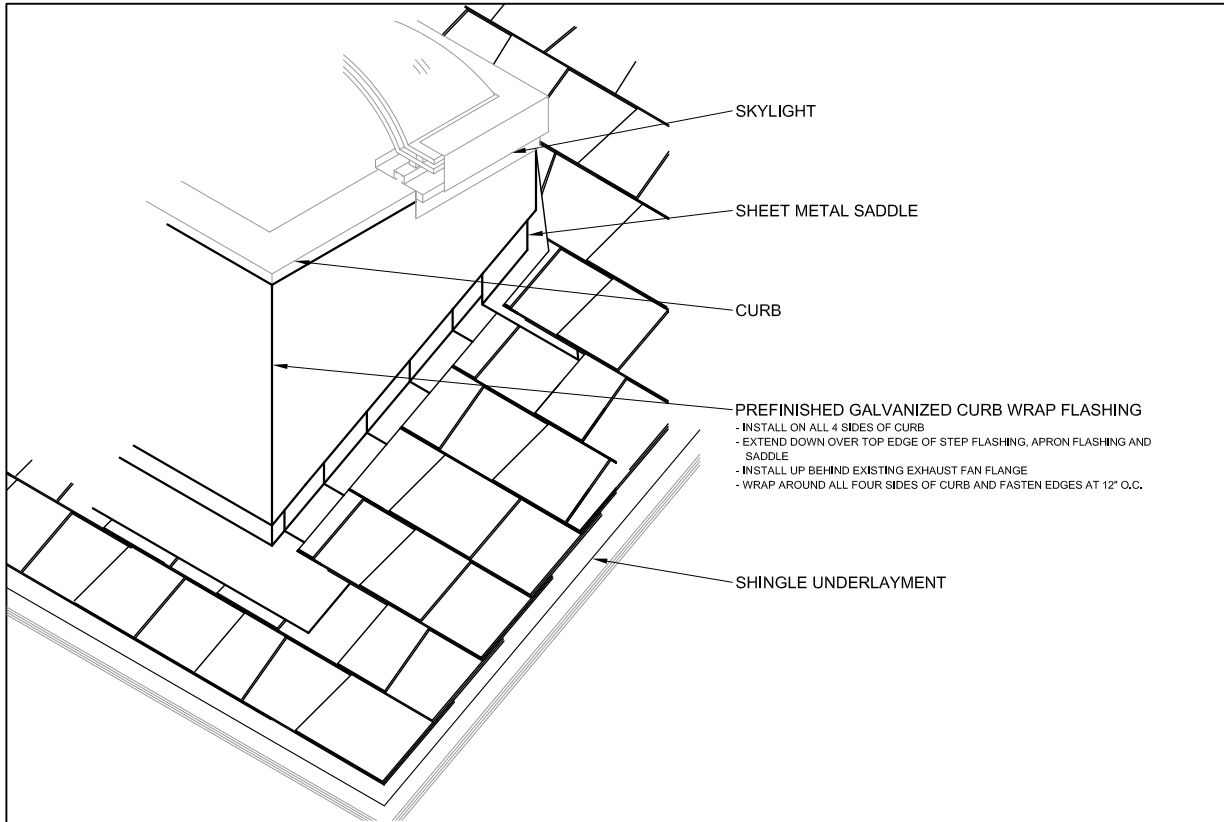

PN-3: ROOF CURB STEP 2 OF 2
NOT TO SCALE

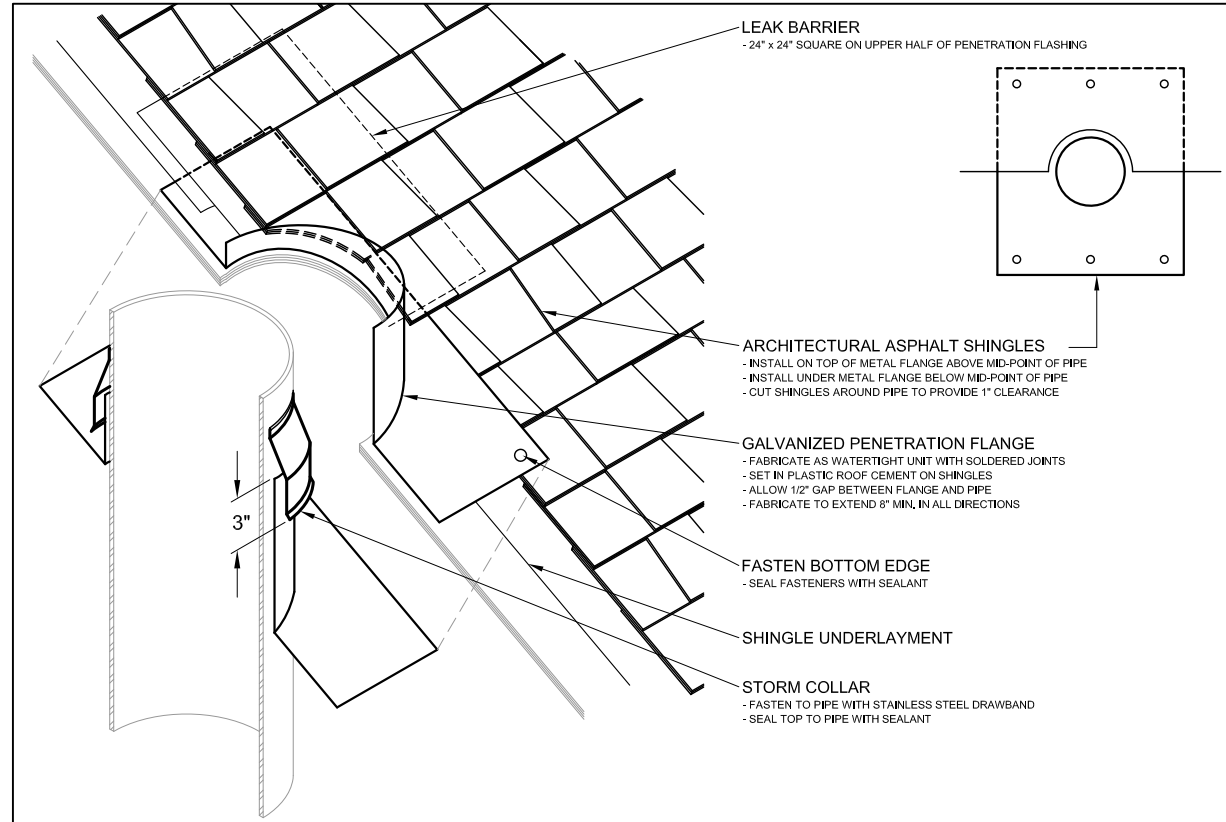

PN-4: PIPE FLANGE
NOT TO SCALE

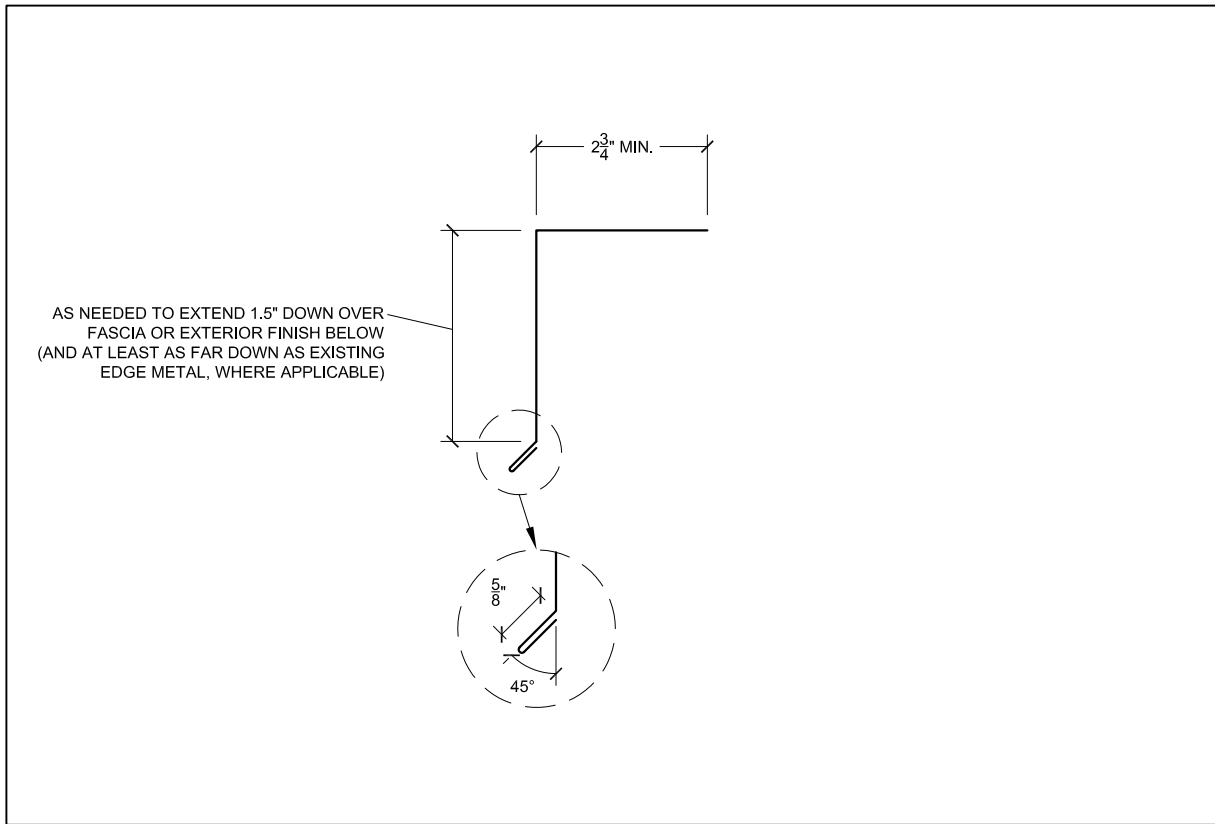

SM-1: RAKE EDGE METAL
NOT TO SCALE

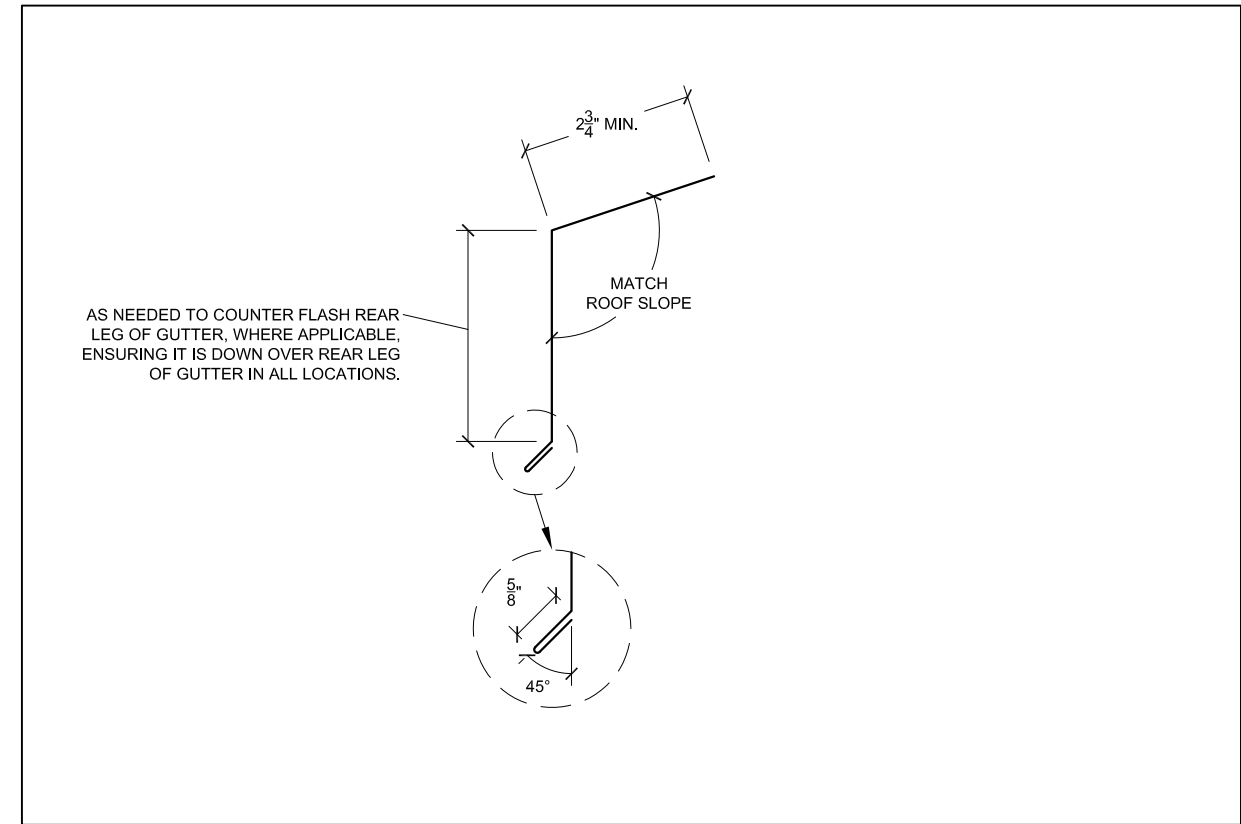

SM-2: EAVE APRON METAL
NOT TO SCALE

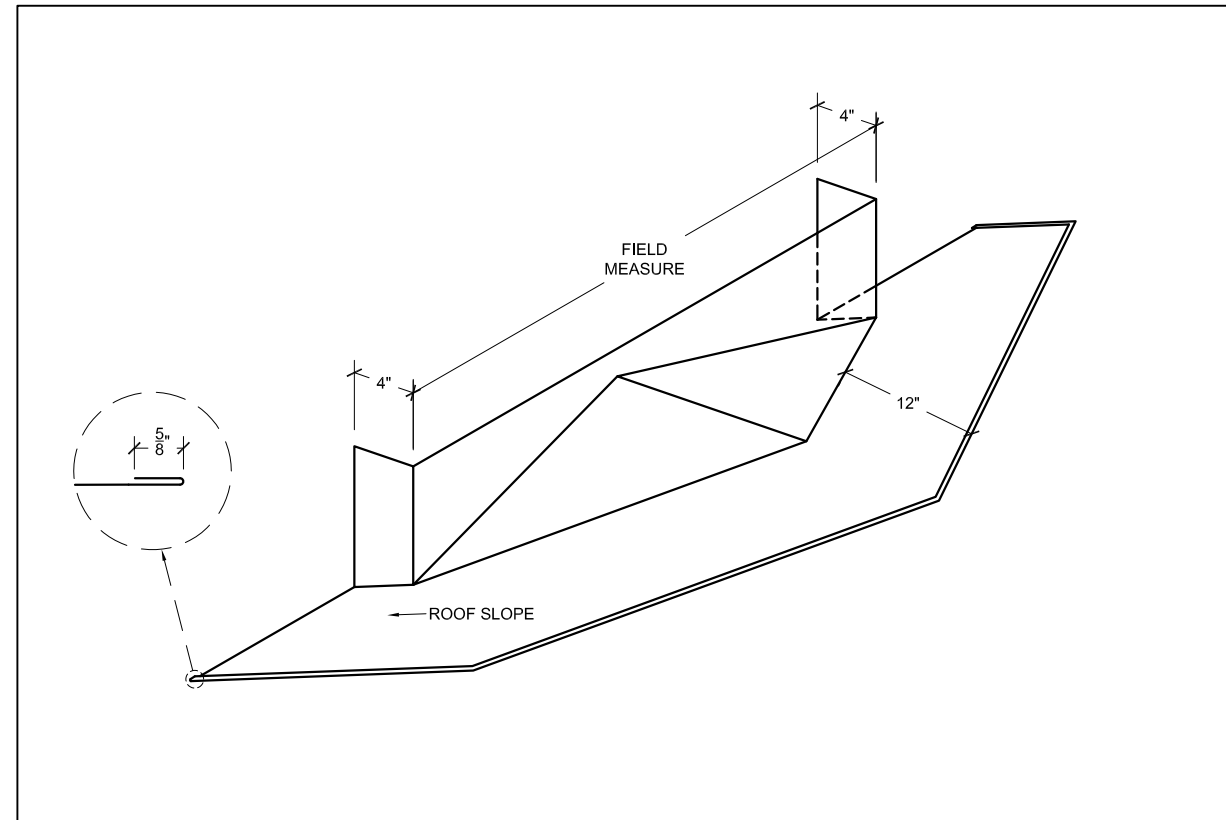

SM-3: SHEET METAL SADDLE
NOT TO SCALE

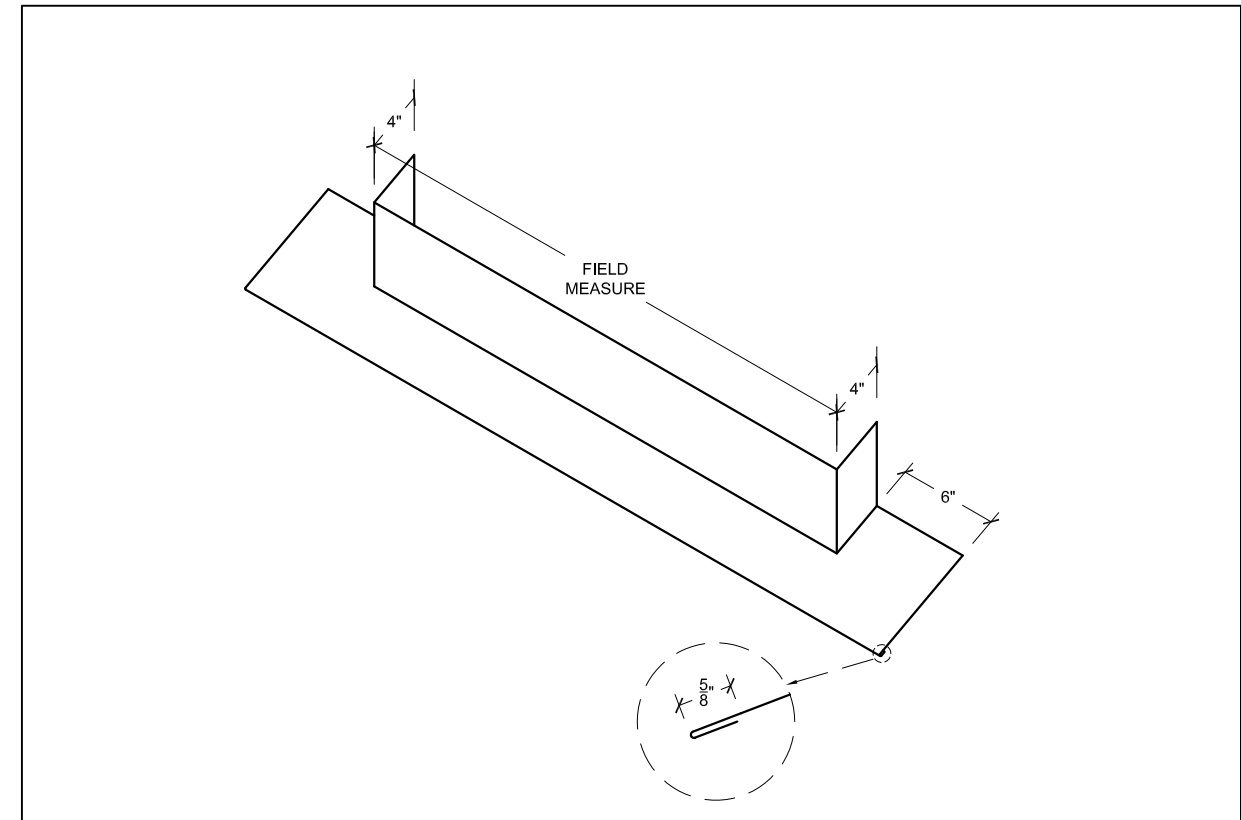

SM-4: SHEET METAL APRON FLASHING
NOT TO SCALE

CONTRACT EXHIBIT B – SCHEDULE OF PRICES

[Schedule of Prices]

EXHIBIT B - SCHEDULE OF PRICES

Name of Bidder:

Filotto Roofing, Inc.

Contractor's State License Registration Number:

No. 104.009778 In State of Illinois

Address of Bidder:

2111 OAKLAND Ave.City CREST HILL State IL Zip 60403 Telephone
815-740-5461Email Address: Kevin@filottoroofing.com

The Bidder attests, having carefully examined the Drawings, Specifications, Commercial Terms and Conditions and all Addenda thereto and other Contract Documents and having familiarized themselves with all existing conditions affecting this proposed Project. Also, having familiarized themselves with material availability, Federal, State and Local Laws, Ordinances, rules and regulations affecting performance of the work, does hereby propose to furnish all labor, mechanics, supervision, tools, material, equipment, transportation, services and all incidentals necessary to complete said work.

Bidder further declares that if their Bid Proposal is accepted, that Bidder will enter into the Contract in the same form as set forth in the Bid and Contract Documents. However, Bidder may request changes to the Contract by submitting with this Schedule of Price a list of requested changes to the Contract.

If this bid is accepted, and the undersigned fails to (i) contract as aforesaid, (ii) provide the Performance Bond required by the Contract, and (iii) provide all insurance required under the Contract within ten (10) calendar days after the date of the award of the Contract then the Village, at its option, may determine that the bidder has abandoned this Bid, and thereupon this Bid and the acceptance thereof shall be null and void, and such security accompanying this Bid shall be forfeited and shall be the property of the Village of Buffalo Grove not as penalty, but as liquidated damages.

BID SECURITYAccompanying this Bid is a copy of Bid Bondin the amount of Four thousand nine hundred ten Dollars
(\$ 4,910.00).

Note: (a) Insert the words "Bank Draft", "Cashier's Check", "Certified Check" or "Bid Bond", as the case may be.

(b) Amount must be equal to at least **ten percent (10%)** of the Total Base Bid.

EXHIBIT B - SCHEDULE OF PRICES (cont.)

BID PRICES

BASE BID (3 Buildings (511, 525, 109)).....\$ 39,100.⁰⁰
dollars

CONSTRUCTION ALLOWANCE: (Funding of Unit Price Items).....\$ 10,000.00

Total Base Bid (Base Bid + Allowances) \$ 49,100.⁰⁰

ALTERNATE ADD #1: (Additional building (345)).....\$ 25,300.⁰⁰
dollars

UNIT PRICING

1. Replace roof decking (per 4'x 8' sheet) \$ 144.⁰⁰

TIME & MATERIAL RATE

1. For repair of latent conditions or additional work:
Time (per man-hour) \$ 135.⁰⁰
Material (Contractor cost) plus 10 %

CONSTRUCTION SCHEDULE

1. The Undersigned agrees to commence the Work in 90 Calendar days after Contract Award and to complete the Work in 45 calendar days thereafter.

* 12 week lead time for skylights

EXHIBIT B - SCHEDULE OF PRICES (cont.)

CERTIFICATION

1. The Bidder acknowledges receipt of:
 - a. The Project Manual for the above-referenced Project.
 - b. The Project Drawings for the above-referenced Project.

2. The Bidder agrees:
 - a. To hold this Bid open for ninety (90) calendar days after the Bid due date.
 - b. To enter into and execute a Contract if awarded on the basis of the Bid and to furnish all bonds and insurance required in the Bidding Documents.
 - c. To accomplish the Work in accordance with the Contract Documents.
 - d. To comply with requirements outlined in attached Contract between Owner/Contractor; if applicable.

EXHIBIT B - SCHEDULE OF PRICES (cont.)

SUBCONTRACTOR LISTING

Bidder, to employ the following listed subcontractors for the following enumerated classes of work and is not to alter or add to such list without the written consent of the Village.

<u>SUBCONTRACTOR</u>	<u>CLASS OF WORK</u>
1. <u>DuPree Construction</u>	<u>Gutters + Downspouts</u>
2. _____	_____
3. _____	_____
4. _____	_____

ACKNOWLEDGEMENT OF ADDENDA

Acknowledgement of receipt of Addenda(s) _____ (list each addendum number)

Attach each signed addendum, if any, to the bid packet as part of your submittal.

CONTRACTOR SIGNATURE and CONTACT INFORMATION

August 31, 2023
Date

815-740-5461
Phone

Filotto Roofing, Inc
Legal Entity

Kevin@filottoroofing.com
E-mail

[Signature]
(Sign here)

Kevin Filotto, Vice Pres.
(Print Name)

EXHIBIT C - REFERENCE LIST

Contact Name: Pete HALL, Lockport Park Dist.
 Municipality/Business: Prairie Bluff Golf Course
 Dates Employed: 10/10/22 to 5/1/23
 Phone Number or E-mail address: 630-310-4413

Contact Name: George TRAVINCEK, New Lenox Park Dist.
 Municipality/Business: New Lenox shelters
 Dates Employed: 7/10/23 to 7/15/23
 Phone Number or E-mail address: 815-219-9481

Contact Name: Sam TRAKAS
 Municipality/Business: Iverness Police Dept.
 Dates Employed: 9-1-22 to 10-31-22
 Phone Number or E-mail address: 847-358-7740

Contact Name: Kevin Doyle
 Municipality/Business: Homer Township Fire
 Dates Employed: 7-26-23 to 8-16-2023
 Phone Number or E-mail address: 815-838-5006 ext:1115