



**ARLINGTON COUNTY, VIRGINIA**

**AGREEMENT NO. 22-FIR-R-309  
AMENDMENT NUMBER 2**

This Amendment Number 2 is made on 9/5/2023 by the County and amends Agreement Number 22-FIR-R-309 ("Main Agreement") dated September 10, 2021 between Municipal Emergency Services, Inc. ("Contractor") and the County Board of Arlington County, Virginia ("County").

The County and the Contractor agree to amend the Main Agreement as follows:

- 1. SECTION 1: CONTRACT DOCUMENTS, IS HEREBY REVISED TO INCLUDE RFP 19-007-SCBA AND MASTER PRICE LIST AS PART OF EXHIBIT A.**
- 2. SECTION 2: CONTRACT TERM, IS HEREBY DELETED IN ITS ENTIRETY AND REPLACED WITH THE FOLLOWING:**

**2. CONTRACT TERM**

The Contractor's provision of goods and services for the County ("Work") shall commence upon the execution of the Agreement by the County", and shall be completed no later than April 10, 2022("Contract Term"), subject to any modifications as provided for in the Contract Documents regarding the Contract Term. No aspect of the Work shall be deemed complete until it is accepted by the County's Project Officer.

Upon satisfactory performance by the Contractor, if COG renews their agreement identified in Exhibit A, the County may elect to renew this Agreement under the same contract terms for two (2) ~~three~~-year renewal periods from April 12, 2022 to April 11, 2028 ("Subsequent Contract Term"). However, if COG does NOT renew their agreement identified in Exhibit A, this Agreement shall automatically expire on the date of the contract expiration date.

- 3. THIS AGREEMENT IS HEREBY RETROACTIVELY RENEWED FROM APRIL 12, 2023 TO APRIL 11, 2025. ONE (1) OPTION PERIOD FOR AN ADDITIONAL THREE YEARS REMAIN FROM APRIL 12, 2025 TO APRIL 11, 2028.**
- 4. SECTION 12. COVID-19 VACCINATION POLICY FOR THE CONTRACTORS TO THE CONTRACT IS HEREBY DELETED.**

All other terms and conditions of the Main Agreement remain in effect.

WITNESS these signatures:

THE COUNTY BOARD OF ARLINGTON  
COUNTY, VIRGINIA

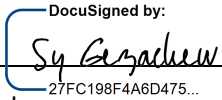
AUTHORIZED  
SIGNATURE: 

NAME: Sy Gezachew

TITLE: PROCUREMENT OFFICER

DATE: 9/5/2023

MUNICIPAL EMERGENCY SERVICES, INC.

AUTHORIZED  
SIGNATURE: 

NAME: Ward Petrie

TITLE: VP Finance

DATE: 8/31/2023



April 1, 2022

Bill Dunn  
Municipal Emergency Services  
315 Howard Avenue, Bays D and E  
Rockville, MD 20850  
Via email to: [billdunn@mesfire.com](mailto:billdunn@mesfire.com)

**RE: First Amendment to Contract Award 19-076 – First Option Period**

Dear Mr. Dunn:

The Metropolitan Washington Council of Governments (COG) is pleased to provide notice that COG will exercise the first renewal option of the above referenced contract.

COG Contract Award #19-076 has been modified as follows:

*Modification to Period of Performance*

Option period one is executed, extending the period of performance by three (3) years to April 11, 2025. One (1) option period for an additional (3) years remains.

All other terms and conditions of the original award remain unchanged, including RFP 19-007 and MES's Technical and Pricing Proposal as opened on January 28, 2019. A copy of the original award is incorporated and referenced herein.

Please feel free to contact me at [purchasing@mwkog.org](mailto:purchasing@mwkog.org), if additional information is requested.

Best regards,

A handwritten signature in blue ink that reads 'Rick D. Konrad'.

Rick D. Konrad  
Contracts and Purchasing Manager



Metropolitan Washington  
Council of Governments

April 25, 2019

Mr. Robert Duncan  
Municipal Emergency Services, Inc.  
315 Howard Avenue, Bays D and E  
Rockville, MD 20850

RE: **Request for Proposal (RFP) #19-007 –SCBA Equipment**

Dear Mr. Robert Duncan:

The Metropolitan Washington Council of Governments (“COG”), on behalf of its participating agencies, is pleased to provide official notification that Municipal Emergency Services’ proposal in response to **RFP #19-007** has been accepted to provide *SCBA Equipment* for public safety and emergency services agencies in the Metropolitan Washington region.

COG offers Municipal Emergency Services the enclosed contract award (**Contract #19-076**) under the following terms:

**Period of Performance:** April 11, 2019 – April 10, 2022, with two (2) three-year renewal options

**Award Amount:** Varies by the participating agency

This award notice of **Contract #19-076** incorporates all terms and conditions of RFP #19-007 (*SCBA Equipment*) and Municipal Emergency Services’ Technical and Pricing Proposal opened on January 28, 2019. Please be advised that each participating agency must issue its own contract and/or purchase order to Municipal Emergency Services.

COG thanks Municipal Emergency Services for your proposal submission and looks forward to working with you.

Please feel free to contact COG’s Cooperative Purchasing Specialist, Jayme Hardy, at [jhardy@mwkog.org](mailto:jhardy@mwkog.org), if additional information is requested.

Best regards,

A handwritten signature in black ink that reads "Rick D. Konrad".

Rick D. Konrad  
Contracts and Purchasing Manager





**REQUEST FOR PROPOSAL (RFP) NO. 19-007**

**Self-Contained Breathing Apparatus (SCBA) Equipment**

**Submission Due Date: Thursday, January 24, 2019**

**Time: 3:00 PM EDT**

Proposers shall submit one (1) original, five (5) copies, and one (1) CD or USB with the complete proposal to:

Cooperative Purchasing Program  
c/o Jayme Hardy  
Metropolitan Washington  
Council of Governments  
777 North Capitol Street, NE, Suite 300  
Washington, DC 20002

Questions - Email: [purchasing@mwcog.org](mailto:purchasing@mwcog.org)

## RFP 19-007 SELF-CONTAINED BREATHING APPARATUS EQUIPMENT

### TABLE OF CONTENTS

<u>Section</u>	<u>Page(s)</u>
Cover Page with basic submission instructions	1
I. Introduction	3 - 4
II. Proposer Qualifications	4
III. Proposal Instructions	4 - 8
IV. General Conditions	8 - 12
V. Specifications	13 - 19
VI. Price Proposal Instructions	20
VII. Price Proposal & Proposal Checklist	21 - 23
A. Attachment – Proposer Qualifications Form	24
B. Attachment – Contact Information Form	25
C. Attachment – Non-Collusion Affidavit	26
D. Attachment – Proposer Experience/References	27
E. Attachment – Proposal Reply Label	28
F. Attachment – MWCOG Cooperative Rider Clause	29
G. Attachment – Terms & Conditions	30 - 34

## RFP 19-007 SELF-CONTAINED BREATHING APPARATUS EQUIPMENT

### I. INTRODUCTION

A. The Metropolitan Washington Council of Governments (“MWCOCG”) is the regional organization of 24 of the Washington area's major local governments and their governing officials, plus area members of the Maryland and Virginia legislatures and the U.S. Senate and House of Representatives. MWCOCG provides a focus for action on issues of regional concern such as comprehensive transportation planning, air and water quality management plans, environmental monitoring, tracking economic development and population growth and their implications on the region, coordinating public safety programs, and promoting adequate child care and housing for the region. MWCOCG is supported by financial contributions from its participating local governments, federal and state government grants and contracts and through donations from foundations and the private sector. More information on MWCOCG may be found at [www.mwcog.org](http://www.mwcog.org).

B. Definitions used in this RFP include:

Participating Agencies	MWCOCG members desiring to receive services and/or commodities as a result of procurement led by MWCOCG.
Lead Agency	MWCOCG serves as Lead Agency by facilitating the procurement process on behalf of its Participating Agencies.
Awarding Authority	MWCOCG serves as Awarding Authority by evaluating bids for responsiveness and identifying the lowest bidder.
Proposal	Entity’s response to meeting the specifications and requirements of the procurement.
Proposer	Entity submitting a Proposal in response to this RFP.
Contractor	The term used throughout this document to describe the Proposer(s) awarded the Contract(s) based on this solicitation.
Contract	Agreement(s) executed between the Participating Agencies and the Contractor(s) as a result of the procurement led by MWCOCG.
Award	Notice from MWCOCG announcing the selected Contractor and the terms by which Contract(s) may be executed.

- C. In this RFP, MWCOCG, as Lead Agency on behalf of first responders within various public safety agencies in the MWCOCG region (“Participating Agencies”), is seeking Proposals for self-containing breathing apparatus (SCBA) equipment, training, and maintenance and repairs (hereinafter referred to as “**SCBA Equipment**”).
- D. MWCOCG, as Awarding Authority, will help identify the most qualified, responsible and responsive Proposer(s) based on scoring criteria including price, qualifications and references (See Section III.F). MWCOCG and its Participating Agencies may select more than one (1) Proposer for Award as it intends to create a regional supply chain pursuant to this RFP.
- E. MWCOCG anticipates Award(s) for a base term of three (3) years, with two (2) three-year renewal options (a maximum term of 9 years). Participating Agencies may purchase **SCBA**

## RFP 19-007 SELF-CONTAINED BREATHING APPARATUS EQUIPMENT

**Equipment** awarded pursuant to this RFP during the Award term.

- F. Contract(s) will be executed between the Participating Agencies and the Contractor(s). MWCOG reserves the right to accept or reject any and all Proposal(s) or portions thereof, to waive any informalities in the solicitation, and to recommend awards that appear to be in the best interest of the Participating Agencies. MWCOG and its Participating Agencies reserve the right to reject any proposals determined to be inadequate or unacceptable.
- G. This RFP is open to all public agencies in the MWCOG region and includes the MWCOG Cooperative Rider Clause (Attachment F) that allows those agencies to use this RFP and/or the resulting Award(s) to make purchases in accordance with their own policies. Other agencies outside of the MWCOG region may be permitted to utilize the MWCOG Cooperative Rider Clause as mutually agreed upon by MWCOG and the Contractor.
- H. Qualified Proposers responding to this RFP must do so no later than **3:00 PM EDT on Thursday, January 24, 2019**.
- I. Proposers are requested not to contact the Participating Agencies directly. Proposers are requested to only contact MWCOG in writing via email at [purchasing@mwkog.org](mailto:purchasing@mwkog.org) (cc: [jhardy@mwkog.org](mailto:jhardy@mwkog.org)) with questions regarding this solicitation.

### II. PROPOSER QUALIFICATIONS

Proposers must meet the following qualifications for consideration of award pursuant to this RFP:

- A. The Proposer must have at least ten (10) years of experience in the supply and delivery of **SCBA Equipment** as required by this RFP.
- B. Proposer must be a SCBA manufacturer, certified dealer or certified distributor to submit a Proposal in response to this RFP. Without manufacturer authorization or certification, the Proposal will be disqualified.
- C. The **SCBA Equipment** proposed must meet the requirements of the National Institute for Occupational Safety and Health (NIOSH) and the National Fire Protection Association (NFPA) standards (See Section V.A).

### III. PROPOSAL INSTRUCTIONS

- A. Proposer must include the documentation specified below, and otherwise, in their Proposal or they may be determined to be non-responsive and subject to rejection (See also Proposal Checklist in Section VII).
  - 1. Proposer shall complete the attached PROPOSER QUALIFICATION FORM (Attachment A) and return with documentation of manufacturer certification or authorization.
  - 2. Proposer shall complete the CONTACT INFORMATION FORM (Attachment B) in its entirety and designate a dedicated Sales/Customer Service Contact and Service/Support Contact as Key Personnel.
  - 3. Each Proposal shall be accompanied by a NON-COLLUSION AFFIDAVIT regarding price fixing, gratuities, bribery, and discriminatory employment practices. When the Proposer is a corporation, a duly authorized representative shall execute the affidavit

**RFP 19-007 SELF-CONTAINED BREATHING APPARATUS EQUIPMENT**

(Attachment C).

4. Proposer shall provide EXPERIENCE/REFERENCES from three (3) other clients who are being, or have been, provided with similar **SCBA Equipment** (Attachment D). Scope of work may be described as jurisdiction size, fire department size (more than 200), or similar purchasing levels.
  5. All Proposals are to be submitted using the RFP REPLY LABEL on the outside of the solicitation package to identify the Proposal (Attachment E) and use the following format:
    - a) **One (1) original and five (5) printed copies** of the Proposal; and
    - b) **One (1) digital copy** in the form of a CD or USB memory stick.
  6. Accord Form – PROOF OF INSURANCE must be provided as per the Terms and Conditions (Attachment G).
- B. All Proposals must be signed by Proposer's officials and delivered in a sealed envelope no later than the time and date indicated herein. Proposals received after the time and date indicated will be returned unopened unless they are the only submission received.
- C. Participating Agencies reserve the right to contract for the commodities/services of the Proposal in its entirety, in segments or by individual item.
- D. SUBSTITUTIONS
1. Because of the distinct difference in quality and, more importantly, the cost of certain products, and when it has been determined that no other manner of description suffices, proprietary specification (brand names) may have been used for some items.
  2. The use of brand names in no way precludes any Proposer from submitting alternative equivalent items for those items as long as the brand substitution is clearly indicated and technical specifications (cut sheets) are provided. To be considered, substitutions must meet or exceed the requirements in the RFP Specifications and NFPA standards.
- E. CLARIFICATIONS VIA ADDENDA
1. Questions regarding discrepancies, omissions, or specifications may be directed **in writing only** no later than **5:00 PM EDT on Thursday, January 10, 2019**, to Jayme Hardy, at [purchasing@mwkog.org](mailto:purchasing@mwkog.org) (cc: [jhardy@mwkog.org](mailto:jhardy@mwkog.org)).
  2. Exceptions taken do not obligate MWCOG to change the specifications. If no changes are needed, then no addendum will be issued.
  3. MWCOG will notify potential Proposers in writing, by addendum posted online, at least five (5) business days before the Proposal submission deadline, of any updated interpretations, specifications, or instructions.
  4. It is the responsibility of the Proposer to check and see if addenda have been issued by MWCOG, on its website, at [www.mwkog.org/purchasing-and-Proposals/cog](http://www.mwkog.org/purchasing-and-Proposals/cog).

## RFP 19-007 SELF-CONTAINED BREATHING APPARATUS EQUIPMENT

### [Proposals-and-RFPs/](#)

5. Proposer should indicate that they have reviewed the latest addenda by acknowledging so on the Price Proposal Form.

#### F. PROPOSAL SCORING

MWCOG will make Award(s) to the Proposer(s) who has the highest score, based on the Proposer's ability to demonstrate meeting the following evaluation criteria:

1. Ability to meet Participating Agencies specifications:	40%
<ol style="list-style-type: none"> <li>a) SCBA Packs</li> <li>b) Cylinders</li> <li>c) Power Supply</li> <li>d) Facepieces</li> <li>e) Electronics</li> <li>f) Carriers &amp; Harnesses</li> <li>g) Rapid Intervention Team (RIT) equipment</li> </ol>	
2. Preventative Maintenance and Service	20%
<ol style="list-style-type: none"> <li>a) Service Level Agreements</li> <li>b) Shipping and time factors</li> <li>c) Proximity of service center</li> <li>d) Customer Service abilities</li> </ol>	
3. Disadvantaged Business Enterprise (DBE) Participation Plan (See Section III.G)	15%
4. Pricing	15%
<ol style="list-style-type: none"> <li>a) Cost of Ownership</li> <li>b) Base Price Per Unit</li> <li>c) Catalogue Discount</li> </ol>	
5. Training (Levels, location(s), hours provided, etc.)	5%
6. Warranty	5%
<b>TOTAL</b>	<b>100%</b>

#### G. Disadvantaged Business Enterprise (DBE) Participation Plan

1. DBE participation shall be a component of the Proposer selection process for this RFP. COG has established a DBE goal of 15% for this project. MWCOG's DBE Policy may be viewed on its website [www.mwcog.org/purchasing-and-bids/dbe-policy/](http://www.mwcog.org/purchasing-and-bids/dbe-policy/).
2. Proposer shall submit a DBE Participation Plan with their Proposals to meet this goal. The Plan shall identify any DBE (defined in 49 CFR Part 26) that shall be

## RFP 19-007 SELF-CONTAINED BREATHING APPARATUS EQUIPMENT

participating in the project. The Plan shall include the name and address of the firm, a copy of the firm's current DBE Certification from any federal, state or local government agency that certifies DBE ownership (please note only DBE certifications will be accepted by MWCOG for this purpose).

3. MWCOG, in accordance with Title VI of the Civil Rights Act of 1964 and 78 Stat. 252, 42 USC 2000 d – 42 and Title 49, Code of Federal Regulations, hereby notifies all Proposers that it will affirmatively ensure that any Awards made pursuant to this advertisement will afford DBEs full opportunity to submit Proposals in response to this RFP, and will not discriminate on the grounds of race, color, sex, or national origin in consideration for an Award.
4. Federal Law – CFR Part 26.37 (Monitoring Performance) requires MWCOG to include a monitoring and enforcement mechanism to ensure that work committed to DBEs at time of the Award is performed by DBEs.
5. A total of 15 possible points (out of a maximum of 100 points) may be awarded for DBE participation, as measured in dollars, either as the “Contractor” or “Subcontractor”. In the event of a tie score between two (2) or more Proposals, the Proposal with the largest percentage of DBE participation, as measured in dollars, will be awarded. DBE points are to be awarded as follows:

### PARTICIPATION POINTS

10% to 14%	3
15% to 19%	6
20% to 24%	9
25% to 34%	12
35% or more	15

- H. Proposer must acknowledge their understanding of the all terms and conditions listed in this RFP by signing the Proposal Qualification Form (Attachment A) and the Price Proposal Form (Section VII) to be included in the Proposal submission. Similarly, please attach any other pricing and specification documents to the Price Proposal Form.
- I. MWCOG, as Lead Agency and Awarding Authority, reserves the right to cancel this RFP, or reject, in whole or in part, any or all Proposals within **60 days** of the Proposal opening, if MWCOG determines that cancellation or rejection serves the best interests of the Participating Agencies. If additional time is needed, all Proposers will be notified.
- J. At any point during the Award period, problems or concerns shall be addressed to MWCOG at [purchasing@mwkog.org](mailto:purchasing@mwkog.org). As the administrator of the regional procurement program, MWCOG shall be notified immediately of any problems that any Proposer has with the program or any problems that the Proposer experiences with any Participating Agency. MWCOG will attempt to resolve the problem as quickly as possible.

## IV. GENERAL CONDITIONS

### A. PARTICIPATING AGENCIES

1. Proposers should assume, before submitting a Proposal, that the entire MWCOG region is expected to participate in the Award via the MWCOG Cooperative Rider Clause.



## RFP 19-007 SELF-CONTAINED BREATHING APPARATUS EQUIPMENT

2. In addition, Proposers should assume that first responders and government entities outside of the MWCOG region will also be looking to leverage the Award under the associated consortium clause.
- B. Because all orders will be on an “as-needed” basis, Proposer must be familiar with the geographical proximity of the MWCOG region for delivery purposes and be able to provide prompt customer service to Participating Agencies.
  - C. Contact information for a Proposer’s customer service representative must be included on CONTACT INFORMATION FORM (Attachment B).
  - D. Due to the importance of product quality and manufacturer support and certification, Proposers must demonstrate in the Proposal that they are a licensed distributor for **SCBA Equipment**, as appropriate.
- E. PURCHASE AND DELIVERY TERMS
1. No minimum order quantity.
  2. Successful Proposers shall accept orders via mail, facsimile, email, telephone and online web form from the Participating Agency if accompanied by a Purchase Order number or a P-card number. All orders shall be complete, labeled and packaged adequately to ensure safe handling and proper delivery.
  3. No separate charges for freight and delivery. Freight terms for all orders requested “delivered” shall be FOB destination Freight Prepaid. All delivery charges, fees, insurance, expenses, and/or overhead shall be included in the price.
  4. Delivery will be to each Participating Agency as designated.
  5. Failure to meet delivery date and provide **SCBA Equipment** as specified may result in written termination of the Contract. Time is of the essence.
  6. If the Participating Agency requests expedited delivery, the Contractor may pass those costs to the requesting Participating Agency only with prior written approval.
  7. If the Contractor cannot meet the delivery requirement, either standard or expedited, each Participating Agency reserves the right to obtain the **SCBA Equipment** from another source.
  8. Further, if the Contractor is unable to meet the delivery requirement and supply the **SCBA Equipment** within the designated time due to factory delay, strike, or any unforeseen circumstances, the Contractor must notify the ordering Participating Agency’s representative of the delay and the anticipated delivery date.  
  
Failure to comply with this requirement will result in a poor performance rating, which will be considered in subsequent awards or renewals, and could result in the termination of the Contract.
  9. All Participating Agencies are responsible for inspecting all shipments and accepting them. Any damaged shipments shall be replaced solely at the Contractor's expense. This shall include pick-up of damaged **SCBA Equipment** and delivery of replacement

## RFP 19-007 SELF-CONTAINED BREATHING APPARATUS EQUIPMENT

**SCBA Equipment.** Replacement **SCBA Equipment** shall be delivered within three (3) business days from receipt of notification of damage.

10. Delivery shall be during normal business hours, Monday through Friday, excluding holidays, unless otherwise specified in Section V. Contractor shall be responsible for ensuring that deliveries are made during regular business hours for each Participating Agency.
11. A packing slip shall accompany all deliveries. The packing slip must include the Participating Agency's purchase order number. Any delivery that does not identify the appropriate Participating Agency's purchase order number may be rejected.

On the packing slip, Contractor shall obtain a signature from a Participating Agency employee for all **SCBA Equipment** delivered. Contractor shall be required to furnish proof of delivery in case of dispute.

12. All "drop shipments" (direct from a manufacturer or wholesaler) must adhere to the terms specified within this solicitation.

### F. PRICES/BILLING

#### 1. Prices

- a) Unless stated otherwise below, all prices offered by Proposers shall be firm against any increase for **one (1) year** from the effective date of the Award.
- b) For each subsequent year on the Award, Contractor shall notify MWCOG and the Participating Agencies at least **60 days** prior to any price increase taking effect and submit a request for a price increase by furnishing bona-fide manufacturer's documents or a price list reflecting the changes. Increases shall be limited to the actual cost increase to the Contractor.
- c) Price increase requests may be denied if not supported with appropriate price increase justification.
- d) Each Participating Agency reserves the right to accept or reject a price increase within **14 days** of written request for a price increase. If the price increase is rejected, the order for the specific item will be canceled.
- e) If the price increase is approved, the price will remain firm for the renewal term for no less than one (1) year. The Participating Agency will notify the Contractor in writing of the effective date of any price adjustment it has approved.
- f) **Price Decreases:** In the event of any decrease in price either by the manufacturer or if the Contractor charges a lower price to other customers, Contractor shall notify the Participating Agencies and give the Participating Agencies the decrease.

#### 2. Billing

- a) Contractor shall set up its billing system to ensure that no Participating Agency invoices include sales tax. Upon request, Participating Agencies will provide certificates of exemption for sales tax.

## RFP 19-007 SELF-CONTAINED BREATHING APPARATUS EQUIPMENT

- b) To facilitate prompt payment, invoices must contain the **SCBA Equipment** contract line item number, descriptions, quantity, and unit pricing. Invoices failing to contain the required line item detail, including contract line number and unit pricing may be returned for correction.
  - c) **Proposers must include a sample invoice with their response to this RFP.**
3. The Proposer shall assign a dedicated Service/Support Representative and provide their contact information for customer service and invoice issues. Include the name and contact information of the assigned representative in the CONTACT INFORMATION FORM (Attachment B).

### G. PAYMENT

1. Payment to the Contractor shall be made within 30 days of receipt of an invoice covering deliveries made during the 30 days prior to the invoice.
2. Participating Agencies reserve the right to hold payment or adjust payments for any **SCBA Equipment** that does not meet the minimum specifications or referenced standards.

### H. COOPERATIVE PURCHASE

1. MWCOG, as Awarding Authority, reserves the right to extend all of the terms, conditions, specifications, and unit or other prices of any Award resulting from this RFP to other public and non-profit agencies. This is conditioned upon mutual agreement between MWCOG and the Contractor, based on the attached MWCOG Cooperative Rider Clause (Attachment F) and pursuant to special requirements appended thereto.
2. Contractor agrees to notify MWCOG of new Participating Agencies that desire to use the Award(s) resulting from this RFP within **30 days** of receiving said requests and to provide reporting as required per this RFP (Section IV.I).
3. MWCOG requires a Rider Request Form be completed by the Participating Agency and submitted to MWCOG for approval. **No riding of this award is permitted without the Rider Request Form being signed by MWCOG.** Forms are available upon request at [purchasing@mwco.org](mailto:purchasing@mwco.org).
4. All Contracts resulting from this RFP shall be with the individual Participating Agencies. MWCOG assumes no authority, liability or obligation on behalf of any Participating Agency using a Contract resulting from this RFP, or any Contractor, or any other entity with respect to this procurement or any contract resulting from it.
5. All purchases and payment transactions will be made directly between the Contractor and the Participating Agency.
6. Participating Agencies may have other or additional terms and conditions that must be met by the Contractor.

### I. PARTICIPATION, SALES REPORTING, AND FEES

1. Contractor shall provide summary information on the purchases made by Participating Agencies, through the purchasing program associated with this RFP, to MWCOG on a

## RFP 19-007 SELF-CONTAINED BREATHING APPARATUS EQUIPMENT

semi-annual basis to allow MWCOG to monitor the program's use and benefit to its members.

### Semi-annual reporting Due Dates beginning 2019:

- November 30, covering May 1 – October 31
  - May 31, covering November 1 – April 30
2. The semi-annual report will provide sales data for each individual Participating Agency within the timeframe outlined above. Contractor is responsible for establishing an accounting system or process that will enable the tracking and reporting of sales to MWCOG under this RFP.
  3. The reporting will include a **1%** administrative fee paid to MWCOG. Contractor will be responsible for tracking and rebating this fee back to MWCOG semi-annually, based on gross sales for the periods described in Section IV.I.1 and due on November 30th and May 31st of each year on all contracts made pursuant to this RFP, at the time of the semi-annual report submission.

### J. AWARD TERMS

1. Awards will be issued for the **SCBA Equipment** advertised in this RFP. There are no product substitutions without prior written approval.
2. Following the base term of the Award, MWCOG will notify Contractor of intent to renew the Award for an additional term, at least **60 days** prior to the end of the current term.
3. Contractor shall notify MWCOG and Participating Agencies of any price increases which shall take effect in the next term at least **60 days** prior to the end of the Award term. Notification shall be in writing and shall identify the **SCBA Equipment**, the new price, and the amount of increase specified as a percentage (%), and the supporting documentation (pursuant to Section IV.F.1.b).

## V. SPECIFICATIONS

### A. COMPLIANCES

The **SCBA Equipment** required by this RFP shall be approved by NIOSH, under 42 CFR, Part 84 for chemical, biological, radiological, and nuclear protection (CBRN) with a 30-minute rated service life and compliant with all requirements of the NFPA 1981, Standard on Open-Circuit SCBAs for Emergency Services, 2018 edition and NFPA 1982, Standard on Personal Safety Alert Safety Systems (PASS), 2018 edition.

### B. DETAILED SPECIFICATIONS

The following are details and evaluation information for each component of the **SCBA Equipment**:

#### 1. Equipment

##### a) SCBA Packs

- 1) Must be within durability and weight requirements according to NFPA;

## RFP 19-007 SELF-CONTAINED BREATHING APPARATUS EQUIPMENT

- 2) Must, at a minimum, have carrier with the standard seatbelt harness, and with the option for a rescue harness;
  - 3) Must have buddy breathing capability as outlined in the latest NFPA standards;
  - 4) Must come with any applicable maintenance or toolkits for operation and/or basic maintenance and adjustments; and
  - 5) Must come with an applicable cylinder.
- b) Cylinders
- 1) Must be fiberglass composite, Kevlar composite, or carbon fiber composite cylinders;
  - 2) Must meet the Compressed Gas Association (CGA) standard threaded connection 347;
  - 3) Must be within the 4500-5500 PSI pressure range;
  - 4) Must have capacity air time within:
    - a. 30-60 minutes for structural firefighting;
    - b. 10-75-minute accessory cylinders (e.g. RIT cylinders, Haz-Mat team cylinders, escape cylinders, rebreather pack cylinder, etc.); and
  - 5) Must be able to be tracked and inventoried by unique identifiers, either through labeling or etching. Sequential labeling is preferred.
- c) Power Supply
- 1) Each SCBA must be provided a power supply, specifically explained to include battery location, battery replacement, and/or battery recharge specifications;
  - 2) If batteries are rechargeable, a recharging station which meets their operational requirements should be supplied to the Participating Agency, free of charge;
  - 3) Length of use for each battery, or the maximum use before recharge, must be specified to the extent possible; and
  - 4) If rechargeable batteries are being provided, the life of rechargeable battery must be specifically identified with costs for replacing after life-cycle.
- d) Facepiece
- 1) Each SCBA must come with a face piece;
  - 2) Must have multiple sizes, and nose sizes;
  - 3) Harness types with four (4) or five (5) straps, made of any, NFPA approved material will be accepted;

## RFP 19-007 SELF-CONTAINED BREATHING APPARATUS EQUIPMENT

- 4) Must have fit for firefighters with glasses; and
  - 5) All components must be replaceable.
- e) Electronics
- 1) All SCBA packs must come with integrated electronics that meet NFPA standards;
  - 2) Must meet SCBA standards for interoperability with all types of radios; and
  - 3) PASS alarm must also be integrated, complying with NFPA standards.

### 2. Optional Products

Proposers should provide specifications and pricing for the following optional products in its Proposal for consideration:

- a) Long-term rebreather packs, RIT packs, RIT cylinders, and RIT bags with quick release harnesses;
- b) Labeling and logos at the Participating Agency's request. Each Participating Agency will have their own requirements for labeling and logos; and
- c) External, unit identifiers on the SCBA packs and regulators. Identifiers should be either stickers, engraving, or etched.

### 3. Warranty

The base **SCBA Equipment** warranty must be for at least 10 years and must cover:

- a) Pressure reducers;
- b) Bumper to bumper electronics;
- c) Cylinder valve, facepiece, straps; and
- d) Shipping and return shipping for repairs on warranty-covered parts and components.

Preferential scoring will be given to longer and more inclusive guarantees on base warranty. Extended warranty must be optional and listed comprehensively on Price Proposal Form (Section VII).

### 4. Preventative Maintenance/Service

- a) Proposers shall provide comprehensive preventative maintenance for their products in order to maintain validity of the warranty. It shall include, at a minimum:
  - 1) Preventative Maintenance SOP and protocols;

## RFP 19-007 SELF-CONTAINED BREATHING APPARATUS EQUIPMENT

- 2) Toolkits and specific tools, free of charge;
  - 3) Lubricants and required cleaning supplies (in the initial purchase);
  - 4) Technician specific training on preventative maintenance protocols and proper cleaning; and
  - 5) Any other materials, equipment of training related to preventative maintenance of the **SCBA Equipment**.
- b) Service Level Agreements (SLAs)
- 1) The Proposer shall provide an agreement that defines the level of service expected. This agreement shall define the working relationship between the Proposer and the Participating Agency and shall contain a guarantee of performance between the parties. While formal SLAs are not required to be included in the RFP, the SLAs with their service center, or distributors and local dealers must be clearly stated.
  - 2) The MWCOC region should not be levied a minimum order amount nor dollar figure. Proposers must clearly state any minimum delivery requirements for new parts from the manufacturer. Preferential scoring for short turn-around times and low minimum order amounts will be given.
  - 3) Repairs
    - a. The minimum time necessary for repairing parts or components, or “repair time”, must be clearly stated. Delivery time must be included in this “repair time.”
    - b. Parts requiring repair should be returned within **30 days**, and loaner parts shall be provided for any repair projected to last over **14 days**. Preferential scoring will be applied.
  - 4) Testing

The SLA with the Participating Agency shall specifically identify the annual testing provided. Annual testing shall include, at a minimum:

    - a. Flow testing;
    - b. Posi Check testing with applicable software;
    - c. Hydrostatic testing;
    - d. Acoustic testing for cylinders; and
    - e. Testing with Quantifit and/or Portacount Fit testing machines.
- c) Shipping Time Requirements
- 1) Given the requirement that Proposers should pay for all the shipping costs,



## RFP 19-007 SELF-CONTAINED BREATHING APPARATUS EQUIPMENT

Proposers should clearly state all shipping timetables.

- 2) These timeframes shall not exceed reasonable shipping times, or already promoted shipping times to other customers. Reasonable shipping times are described in the above "Repairs" section. Faster shipping timeframes will receive preferential scoring.
  - 3) Expedited shipping for catastrophic emergencies shall be free of charge and triggers shall be established with each Participating Agency. Catastrophic emergencies can be described as large, complex, multiple agency responses to a natural or man-made disaster in the MWCOG region, requiring a significant surge of **SCBA Equipment**.
- d) Service Center
- 1) Participating Agencies are interested in receiving Proposals on a regional service center. Proposers should provide detailed method of implementation for a service center in the MWCOG region. Preferential scoring will be applied.
  - 2) If the Proposers are using the local dealer and/or distribution network for service, then a detailed SLA will be required. Locations of distributors will be required for review and their geographic area of responsibility should be clearly explained to include jurisdictional responsibilities. If this service method is chosen, it is recommended that Proposers provide detailed information on their technique to manage proper interoperability for the Participating Agencies.
  - 3) On-demand service shall be provided regardless of service methodology and shall provide expert support to Participating Agency's technician level trained members. On-demand service will be required after-hours and be available 24/7/365. In addition, redundancy in emergency service shall be identified and included in the Proposal.
- e) Customer Service
- 1) Proposer's and/or distributor's overall customer service will be evaluated using the submitted references. Reference should be equivalent to MWCOG region's jurisdictions and fire departments.
  - 2) Certified dealers and distributors of SCBA manufacturers will also be evaluated in this category.

### 5. Training

- a) Participating Agencies are requiring three (3) levels of training:
  - 1) **End-user training** shall be provided for Participating Agencies switching SCBA packs models or transitioning to a new Contractor. Training shall be completed on or off site at the Participating Agency's discretion and convenience and shall last as long as the Participating Agency requires for up to one (1) year after initial purchase.
  - 2) **Free on-site technician training** will be required for any Participating Agency

## RFP 19-007 SELF-CONTAINED BREATHING APPARATUS EQUIPMENT

transitioning from a different pack, or to a new Contractor altogether. On-site technician training shall be meet the following requirements:

- a. Scheduled at the Participating Agency's convenience;
  - b. Include as many technicians as the Participating Agency requests; and
  - c. Minimum duration of 2.5 days, or as deemed satisfactory by the Participating Agency.
- 3) **Second-level technician training** shall be offered on a limited basis with specialized group of SCBA technicians, and shall be completed on-site or off-site, at the convenience of the Participating Agency, with timing commensurate with the applicable training.
- b) Extended training shall be provided outside of the training list above for a cost and shall be coordinated at the Participating Agency level.
  - c) All Proposers must submit a detailed transition plan that will identify the following:
    - 1) The training of the Participating Agency's end-users and technicians on the pack and related accessories;
    - 2) The training of technicians on maintenance and service of the pack and related accessories; and
    - 3) The requisite equipment and infrastructure, to include cascade systems, air compressor systems, testing equipment, or other applicable equipment.

### 6. Cost of Ownership

The following is a supplemental category to better capture the total cost of ownership in the procurement for long-term purchase of **SCBA Equipment**. The categories identified below are supplemental to the purchase of the **SCBA Equipment**, but integral in the overall jurisdictional SCBA program. Participating Agencies reserve the right to purchase on this RFP as a whole or in segments from the following categories. The Proposer must provide information and pricing in their Proposal for the procurement of:

- a) Cascade systems
- b) Air compressor systems
- c) Rebreather packs
- d) Cylinders (only)
- e) Trade-in value for Participating Agencies' existing equipment:
  - 1) Packs
  - 2) Cylinders

## RFP 19-007 SELF-CONTAINED BREATHING APPARATUS EQUIPMENT

## 3) Accessories

## VI. PRICE PROPOSAL INSTRUCTIONS

The Proposer must provide pricing for the following **SCBA Equipment** components:

- A. Equipment:
  - 1. Per unit cost of SCBA pack(s) and cylinders; and
  - 2. Description – Proposers must provide specific weights of SCBA pack(s) when they are equipped and ready for operational use.
- B. Optional Products: Provide pricing to supply the optional products listed in Section V.B.2.
- C. Battery Products: Provide costs of battery replacement (See Section V.B.1.C)
- D. Catalogue Discount Program (% discount)
  - 1. Provide a discount list for catalogue pricing; and
  - 2. Provide an average price increase percentage based on the previous five (5) years.
- E. Training: Price Proposal shall include the number of free training hours and costs for extra training beyond those hours for each type of training:
  - 1. End-user training
  - 2. Free on-site technician training
  - 3. Second-level Technician training
  - 4. Extended training (See Section V.B.5)
- F. Warranty – 10-year minimum
- G. Supplemental Costs: Any costs of ownership, fees for the complete restocking of field replacement parts, and values for trade-in of the **SCBA Equipment** shall be included on the Price Proposal Form.

{Continued on the next page.}

## RFP 19-007 SELF-CONTAINED BREATHING APPARATUS EQUIPMENT

### VII. PRICE PROPOSAL FORM

Proposer \_\_\_\_\_

DATE: \_\_\_\_\_

#### SCBA Products

Item	Description:	Unit Cost
<b>SCBA EQUIPMENT</b>		
SCBA Pack (incl. power supply, facepiece, and electronics)		
Cylinder		
<b>OPTIONAL PRODUCTS</b>		
Rebreather Packs		
RIT packs with RIT cylinders		
RIT bags		
Labeling		
Unit Identifiers		
<b>BATTERY PRODUCTS</b>		
Battery Replacement (as applicable)		
<b>CATALOGUE DISCOUNT PROGRAM</b>		
	Discount %:	
	Average Annual Increase %:	

#### SCBA Services

Item	Cost
<b>WARRANTY</b>	
10-year minimum warranty	
Extended warranty (annual cost, as applicable)	
<b>PREVENTATIVE MAINTENANCE/SERVICE/REPAIRS</b>	
Annual cost of preventative maintenance	
Annual cost of regional service center	
Hourly cost for repairs (not covered by warranty)	

#### SCBA Training

Category	Number of Hours Provided at no cost	Extra Cost Per Hour	Notes
End User Training			
Second-level Technician Training			
Extended Training			

## RFP 19-007 SELF-CONTAINED BREATHING APPARATUS EQUIPMENT

**Supplemental Costs**

Item	Unit Cost
<b>COST OF OWNERSHIP</b>	
Cascade systems	
Air compressor systems	
Rebreather Packs	
Cylinders (only)	
<b>RESTOCKING</b>	
Restocking of field replacement parts	
<b>TRADE-IN VALUE</b>	
SCBA Packs	
Cylinders	
Accessories:	

Please feel free to add attachments to this Price Proposal for consideration.

**Addendums Acknowledged (if applicable) -**

Addendum #1      YES \_\_\_                      NO \_\_\_                      N/A \_\_\_

Addendum #2      YES \_\_\_                      NO \_\_\_                      N/A \_\_\_

Addendum #3      YES \_\_\_                      NO \_\_\_                      N/A \_\_\_

Addendum #4      YES \_\_\_                      NO \_\_\_                      N/A \_\_\_

Others \_\_\_\_\_

I have read, understood, and agreed to the terms and conditions of all contents of this RFP. The undersigned agrees to furnish the commodity or service stipulated in this RFP as stated above.

NAME: \_\_\_\_\_

COMPANY: \_\_\_\_\_

ADDRESS: \_\_\_\_\_

TELEPHONE: \_\_\_\_\_                      FAX: \_\_\_\_\_

EMAIL: \_\_\_\_\_

SIGNATURE: \_\_\_\_\_

TITLE: \_\_\_\_\_

## RFP 19-007 SELF-CONTAINED BREATHING APPARATUS EQUIPMENT

**PROPOSAL CHECKLIST**

<u>Item</u>	<u>Attached</u>	<u>YES</u>	<u>NO</u>
PROPOSAL CHECKLIST		_____	
Section VII PRICE PROPOSAL FORM		_____	
Attachment A PROPOSER QUALIFICATIONS FORM		_____	_____
Attachment B CONTACT INFORMATION FORM		_____	_____
Attachment C NON-COLLUSION AFFIDAVIT		_____	_____
Attachment D PROPOSER'S EXPERIENCE/REFERENCES		_____	_____
Attachment E PROPOSAL REPLY LABEL		_____	_____
Certificate of Insurance (see Terms and Conditions)		_____	_____
Sample Invoice		_____	
Acknowledgements		YES	Exceptions
Attachment F MWCOG Cooperative Rider Clause		_____	_____
Attachment G Terms and Conditions		_____	_____

If a Proposer is unable to accept all or parts Attachments F & G, Proposer must indicate that it has exceptions and provide an attachment indicating the exceptions. Exceptions may cause the Proposal to be disqualified. If no exceptions are noted, then checking "yes" indicates acceptance of the MWCOG Cooperative Rider Clause and Terms and Conditions as written.

RFP 19-007 SELF-CONTAINED BREATHING APPARATUS EQUIPMENT

Attachment A

PROPOSER QUALIFICATION FORM

1. NAME OF PROPOSER: \_\_\_\_\_

2. PERMANENT MAILING ADDRESS: \_\_\_\_\_

3. YEAR & STATE INCORPORATED: \_\_\_\_\_

4. DUN AND BRADSTREET D-U-N-S # \_\_\_\_\_

5. HOW MANY YEARS HAVE YOU ENGAGED IN BUSINESS UNDER YOUR PRESENT FIRM  
NAME: \_\_\_\_\_ YEARS \_\_\_\_\_

6. GENERAL CHARACTER OF WORK PERFORMED BY YOUR COMPANY:  
\_\_\_\_\_  
\_\_\_\_\_

7. HAVE YOU EVER DEFAULTED ON A CONTRACT?       YES       NO

IF YES, WHY? \_\_\_\_\_  
\_\_\_\_\_

8. ATTACH A LISTING BY PRODUCT LINE OF ALL MANUFACTURES FOR WHOM YOUR COMPANY IS AN AUTHORIZED DEALER/DISTRIBUTOR/RESALER

9. NAME OF BANKS WITH WHICH YOU DO BUSINESS:  
\_\_\_\_\_  
\_\_\_\_\_

10. DO YOU GRANT THE AWARDDING AUTHORITY PERMISSION TO CONTACT THIS (THESE) MANUFACTURES AND LENDING INSTITUTION(S)?       YES       NO

By signing this form, you acknowledge compliance with all terms and conditions of this Proposal.

Name: \_\_\_\_\_ Date: \_\_\_\_\_

Title: \_\_\_\_\_ Company: \_\_\_\_\_



RFP 19-007 SELF-CONTAINED BREATHING APPARATUS EQUIPMENT

Attachment B

CONTACT INFORMATION FORM

**Proposer Company Name** \_\_\_\_\_

**Contact for Proposal**

Name \_\_\_\_\_

Title \_\_\_\_\_

Phone number \_\_\_\_\_

Email address \_\_\_\_\_

**Sales Representative Contact**

Name \_\_\_\_\_

Title \_\_\_\_\_

Phone number \_\_\_\_\_

Email address \_\_\_\_\_

Area covered: \_\_\_\_\_ (“all”, or list)

**Service/Support Representative Contact**

Name \_\_\_\_\_

Title \_\_\_\_\_

Phone number \_\_\_\_\_

Email address \_\_\_\_\_

Area covered: \_\_\_\_\_ (“all”, or list)

Use additional sheet for more sales/support representatives

RFP 19-007 SELF-CONTAINED BREATHING APPARATUS EQUIPMENT

Attachment C

NON-COLLUSION AFFIDAVIT

DATE \_\_\_\_\_

TO: Metropolitan Washington Council of Governments,  
777 North Capitol Street, NE, Suite 300  
Washington, DC 20002

To Whom It May Concern:

This is to certify that the undersigned PROPOSER has not, either directly or indirectly, entered into any agreement, participated in any collusion, or otherwise taken any action in restraint of free competitive in connection with this Proposal submitted Metropolitan Washington Council of Governments.

In addition, the Proposer also certifies that they are in good standing and not on any debarred lists with any government Participating Agency including Local, Federal and State Governments.

RFP - 19-007 SELF CONTAINED BREATHING APPARATUS

Name of Proposer \_\_\_\_\_

\_\_\_\_\_  
Signature

\_\_\_\_\_  
Title of Authorized Representative

Swore to and subscribed before me this \_\_\_\_\_ day of \_\_\_\_\_, 20\_\_\_\_

My commission expires \_\_\_\_\_, 20\_\_\_\_.

\_\_\_\_\_  
Notary Public

(Notary Seal)

RFP 19-007 SELF-CONTAINED BREATHING APPARATUS EQUIPMENT

Attachment D

PROPOSER'S EXPERIENCE/REFERENCES

Name of Proposer \_\_\_\_\_

REFERENCES are to be provided from three (3) other clients who are being or have been provided by the Proposer similar products, services and scope of work.

Complete contact information for each reference, including name, telephone number, mailing address and E-mail address, must be included with the Proposal.

A Proposer, which, in the sole judgment of the offeror, lacks sufficient specific experience, may be deemed non-responsible, and may not be considered for award of subsequent contract(s) by the Agencies.

1) Company Name \_\_\_\_\_

Contact Name \_\_\_\_\_

Mail Address \_\_\_\_\_

\_\_\_\_\_

Telephone Number \_\_\_\_\_ Email Address \_\_\_\_\_

-----

2) Company Name \_\_\_\_\_

Contact Name \_\_\_\_\_

Mail Address \_\_\_\_\_

\_\_\_\_\_

Telephone Number \_\_\_\_\_ Email Address \_\_\_\_\_

\_\_\_\_\_

3) Company Name \_\_\_\_\_

Contact Name \_\_\_\_\_

Mail Address \_\_\_\_\_

\_\_\_\_\_

Telephone Number \_\_\_\_\_ Email Address \_\_\_\_\_

RFP 19-007 SELF-CONTAINED BREATHING APPARATUS EQUIPMENT

Attachment E

PROPOSAL REPLY LABEL

SECURE TO THE OUTSIDE OF YOUR RESPONSE ENVELOPE.

FROM: \_\_\_\_\_  
\_\_\_\_\_  
\_\_\_\_\_

TO: Metropolitan Washington Council of Governments  
c/o Jayme Hardy  
777 North Capitol Street, NE, Suite 300  
Washington, DC 20002

Attn: REQUEST FOR PROPOSAL 19-007  
SELF CONTAINED BREATHING APPARATUS (SCBA) EQUIPMENT

## RFP 19-007 SELF-CONTAINED BREATHING APPARATUS EQUIPMENT

Attachment FMWCOG Cooperative Rider Clause

The MWCOG Cooperative Purchasing Program works to aggregate the public entity and non-profit purchasing volumes in the National Capital Region of Maryland, Virginia and Washington, D.C.

## A. Format

MWCOG serves as the Lead Agency of this Procurement and has included this Cooperative Rider Clause indicating its willingness to allow other public entities to participate in this Procurement pursuant to the following Terms and Conditions:

## B. Terms

1. Participating Agencies, through their use of this Cooperative Rider Clause, agree to the terms and conditions of this Procurement to the extent that they can be reasonably applied to the Participating Agency.
2. Participating Agencies may also negotiate additional terms and conditions specific to their local requirements upon mutual agreement between the parties. Contract obligations rest solely with the Participating Agencies.
3. The resulting Contract shall be governed by and "construed" in accordance with the laws of the State/jurisdiction in which the Participating Agency is officially located.

## C. Other Conditions - Contract and Reporting

1. Public entities desiring to participate in this Procurement must receive written approval from MWCOG in the form of a MWCOG Rider Clause Approval Form signed by the public entity and MWCOG;
2. Contractor must provide semi-annual contract usage reporting information to MWCOG, including but not limited to quantity, unit pricing and total volume of sales by agency/entity, as well reporting other Participating Agencies added on the Contract, on demand and without further approval of Participating Agencies;

Semi-annual reporting Due Dates beginning from Contract execution:

- November 30, covering May 1 – October 31
  - May 31, covering November 1 – April 30
3. Contractor must provide to MWCOG a semi-annual administrative fee of 1% on all gross sales at the time of the semi-annual report submission due dates listed above; and
  4. Significant changes in total contract value may result in further negotiations of contract pricing with the Lead Agency and Participating Agencies.

Contract usage reporting information and requests for MWCOG Rider Clause Approval Forms shall be submitted to MWCOG's Contracts and Purchasing inbox at [purchasing@mwkog.org](mailto:purchasing@mwkog.org).

## RFP 19-007 SELF-CONTAINED BREATHING APPARATUS EQUIPMENT

**Attachment G****Terms and Conditions**

This document sets out provisions generally applicable to Metropolitan Washington Council of Governments (“MWCOG”) Participating Agencies contracts. The provisions herein do not constitute a complete agreement, and must be appended to a document, executed by all parties, which identifies the specific work to be performed, compensation, term, incorporated attachments, and special conditions, if any. This document and the Contract are intended to be complementary and shall be construed accordingly. However, should there be a direct contradiction between the terms and conditions contained herein and the Contract, then the Contract shall govern and control those contradictory terms and conditions. As used herein, the term “MWCOG” includes MWCOG, its various members, agencies, employees or agents as may be appropriate. The term “Contract” shall include a document entitled “agreement” or any other title on a document that is denoting a contract.

**Amendment.** This Contract constitutes the entire agreement between the parties and all other communications prior to its execution, whether written or oral, with reference to the subject matter of this Contract are superseded by this Contract. No amendment to this Contract shall be binding unless in writing and signed by the parties.

**Bankruptcy.** Upon filing for any bankruptcy proceeding by or against the Contractor, whether voluntary or involuntary, or upon the appointment of a receiver, trustee, or assignee for the benefit of creditors, the Contractor must notify MWCOG Participating Agencies immediately. Upon learning of the actions herein identified, MWCOG reserves the right at its sole discretion either to cancel the Contract or to affirm the Contract and hold the Contractor responsible for damages. The exercise of this right is in addition to any other rights MWCOG may have as provided in this agreement or by law.

**Compliance with Law.** The Contractor hereby represents and warrants that:

- A. It has the power and authority to enter into and perform the Contract, that the Contract, when executed and delivered, shall be a valid and binding obligation of Contractor, enforceable in accordance with its terms;
- B. Its performance under the Contract shall be in a good and workmanlike manner and in accordance with all applicable professional standards;
- C. It is qualified to do business in the jurisdictions covered by the Contract and that it will take such action as, from time to time hereafter, may be necessary to remain so qualified;
- D. It is not in arrears in the payment of any obligations due and owing to any agency involved in this agreement, including but not limited to the payment of taxes and employee benefits, and that it shall not become so in arrears during the term of this Contract;
- E. It shall comply with all federal, state and local laws, regulations, and ordinances applicable to its activities and obligations under this Contract; and
- F. It shall obtain, at its expense, all licenses, permits, insurance and governmental approvals, if any, necessary to the performance of its obligations under this Contract.

**Contingent Fee Prohibition.** The Contractor, architect or engineer (as applicable) warrants that it has not employed or retained any person, partnership, corporation, or other entity, other than a bona fide employee or agent working for the Contractor, architect or engineer, to solicit or secure this Contract, and that it has not paid or agreed to pay any person, partnership, corporation or other entity, other than a bona fide employee or agent, any commission, percentage, brokerage or contingent fee or other consideration contingent on the making of this Contract.

**Counterparts.** This Contract may be executed in several counterparts, each of which shall be an original, all of which shall constitute one and the same instrument.

**Force Majeure.** Neither MWCOG and/or its members nor Contractor shall be held responsible for delay or default caused by fire, riot, acts of God, declaration of emergency, or war where such cause was beyond, respectively, MWCOG’s and/or its members or Contractor’s reasonable control. MWCOG and/or its members and Contractor shall make all reasonable efforts to remove or eliminate such a cause of delay or default and shall, upon the cessation of the cause, diligently pursue performance of its obligations under this

## RFP 19-007 SELF-CONTAINED BREATHING APPARATUS EQUIPMENT

Contract.

Governing Law. This Contract shall be governed by and construed in accordance with the laws of the Participating Agency's jurisdiction without regard to principles of conflicts of law.

Indemnification. The Contractor shall protect, hold free and harmless, defend and indemnify MWCOG and its members including their officers, agents and employees from all liability, penalties, costs, losses, damages, expenses, causes of action, claims or judgments (including attorney's fees) resulting from injury to, or death of, any person or damage to property of any kind, which injury, death or damage arises out of, or is in any way connected with the performance of the work or failure to perform its obligations under this Contract. This obligation of indemnification shall apply to any acts or omissions, negligent conduct, whether active or passive, including acts or omissions of Contractor's agents or employees; except that it shall not be applicable to injury, death or damage to the property arising from the sole negligence of MWCOG and/or members, their officers, agents and employees.

Independent Contractor.

- A. Contractor shall perform the work required by this Contract as an "Independent Contractor." Although MWCOG and/or members reserves the right to determine the delivery schedule for the work to be performed and to evaluate the quality of the completed performance, MWCOG and/or members cannot and will not control the means or manner of the Contractor's performance. The Contractor shall comply promptly with any requests by MWCOG and/or members relating to the emphasis or relative emphasis to be placed on various aspects of the work or to such other matters pertaining to the work under this Contract. Contractor is responsible for determining the appropriate means and manner of performing the work.
- B. Contractor represents and warrants that Contractor is not an employee of MWCOG and/or members, is not currently employed by the Federal Government, and is not an officer, employee or agent of MWCOG and/or members.
- C. Contractor shall be responsible for all federal or state taxes applicable to any compensation or payments paid to Contractor under this Contract. Contractor is not eligible for any federal Social Security, unemployment insurance, or workers' compensation benefits from compensation or payments paid to Contractor under this Contract.
- D. Contractor agrees to immediately provide MWCOG and/or members notice of any claim made against Contractor by any third party. Contractor also agrees not to assign to any third party, without MWCOG's written consent, any obligation of MWCOG to indemnify Contractor for any actions under this Contract.

Insurance Requirements.

- A. Contractor shall obtain, and at all times keep in effect, Commercial General Liability Insurance in the amounts listed below for its activities and operations. The insurance shall include coverage for personal injury, discrimination and civil rights violation claims. All such insurance shall name MWCOG, individual members, their employees, and agents as ADDITIONAL INSURED. A copy of the certificate of insurance shall be filed with MWCOG and/or members prior to the time any services are rendered. Contractor shall maintain coverage in the amount of \$1,000,000 per occurrence and \$2,000,000 general aggregate and \$500,000 for property damage. Coverage shall be written on an occurrence form.
- B. Contractor shall obtain, and at all times keep in effect, automobile insurance on all vehicles used in this Contract with MWCOG and/or members to protect Contractor against claims for damages resulting from bodily injury, including wrongful death, and property damage that may arise from the operations of any owned or hired automobiles used by Contractor in connection with the carrying out of this Contract. All such insurance shall name MWCOG and/or individual members, their employees, and agents as ADDITIONAL INSURED.



## RFP 19-007 SELF-CONTAINED BREATHING APPARATUS EQUIPMENT

- C. Contractor shall, upon request, provide MWCOG and/or members with certification of Workers' Compensation Insurance, with employer's liability in the minimum amount required the governing jurisdiction's law in effect for each year of this Contract.
- D. All insurance policies shall have a minimum 30 days' notice of cancellation. Immediate written notice to MWCOG and members involved in the contract shall be required in the event of cancellation or restriction by the insurance company of any insurance policy referred to in this section.
- E. When insurance coverage is renewed, Contractor shall provide new certificates of insurance prior to expiration of current policies to all contracting agencies.

Nondiscrimination. A Contractor, who is the recipient of MWCOG and/or member funds, or who proposes to perform any work or furnish any goods under this Contract, shall not discriminate against any worker, employee or applicant because of religion, race, sex, age, sexual orientation, physical or mental disability, or perceived disability. Contractor further agrees that this provision will be incorporated in all sub-contracts entered into in connection with this Contract.

### Ownership of Documents and Materials.

- A. The Contractor agrees that all documents and materials, including but not limited to, reports, drawings, studies, specifications, estimates, maps, photographs, designs, graphics, mechanicals, artwork, and computations prepared by or for the Contractor under the terms of this Contract shall at any time during the performance of the services be made available to MWCOG and/or members upon request and shall become and remain the exclusive property of MWCOG and/or members upon termination or completion of the services. These jurisdictions shall have the right to use the same without restriction or limitation and without compensation to the Contractor other than that provided in this Contract. MWCOG and/or members shall be the owner for the purposes of copyright, patent or trademark registration.
- B. If the Contractor obtains or uses for purposes of this Contract, or subcontracts for, any design, device, material, or process covered by letters of patent for copyright, it shall provide an assignment to MWCOG and/or members of ownership for purposes of copyright, patent or trademark and of all right to possess and to use such design, device, material or process and a legally sufficient agreement with the patentee or owner, and a copy of such agreement shall be filed with MWCOG and/or members.
- C. The Contractor shall indemnify and save harmless MWCOG and/or members from any and all claims for infringement by reason of the use of any such patented design, device, materials, or process, or any trademark or copyright, and shall indemnify, protect and save harmless MWCOG and/or members, their officers, agents, and employees with respect to any claim. Action, costs or infringement, for royalties or user fees, arising out of purchase or use of materials, construction, supplies, equipment or services covered by this Contract.

Payments. Payments to the Contractor pursuant to this Contract shall be made no later than 30 days after MWCOG's and/or members receipt of a proper invoice from the Contractor.

Records. Contractor shall maintain all fiscal records relating to this Contract in accordance with generally accepted accounting principles. In addition, Contractor shall maintain any other records pertinent to this Contract in such a manner as to clearly document Contractor's performance hereunder. Contractor acknowledges and agrees that the MWCOG and/or members and their duly authorized representatives shall have access to such fiscal records and all other books, documents, papers, plans, and writings of the Contractor that are pertinent to this Contract. All such fiscal records, books, documents, papers, plans, and writing shall be retained by Contractor and kept accessible for a minimum of three (3) years, except as required longer by law, following final payment and termination of this Contract, or until the conclusion of any audit, controversy, or litigation arising out of or related to this Contract, whichever date is later. All subcontracts shall also comply with these provisions.

## RFP 19-007 SELF-CONTAINED BREATHING APPARATUS EQUIPMENT

Remedies.

- A. Corrections of errors, defect and omissions. Contractor agrees to perform the work as may be necessary to correct errors, defects, and omissions in the services required under this Contract, without undue delays and without cost to MWCOG and/or members. The acceptance of the work set forth herein by MWCOG and/or members shall not relieve the Contractor of the responsibility of subsequent corrections of such errors.
- B. Set Off. MWCOG and/or members may deduct from and set-off against any amounts due and payable to the Contractor any back-charges, penalties, or damages sustained by MWCOG and/or members, their agents, employees of recipients of its services, by virtue of any breach of this Contract by the Contractor or by virtue of the failure or refusal of the Contractor to perform the services or any part of the services in a satisfactory manner. Nothing herein shall be construed to relieve the Contractor of liability for additional costs resulting from a failure to satisfactorily perform the services.
- C. Cumulative. All rights and remedies of MWCOG/ members and Contractor shall be cumulative and may be exercised successively or concurrently. The foregoing is without limitation to or waiver of any other rights or remedies of the MWCOG and/or members by law.

Responsibility of Contractor.

- A. The Contractor shall perform the services with the standard of care, skill, and diligence normally provided by a Contractor in the performance of services similar the services hereunder.
- B. Notwithstanding any review, approval, acceptance or payment for the services by MWCOG, the Contractor shall be responsible for the professional and technical accuracy of its work, design, drawings, specifications and other materials furnished by the Contractor under this Contract.
- C. If the Contractor fails to perform the services, or any part of the services, in conformance with the standard set forth in subparagraph A above, it shall, if required by MWCOG and/or members, perform at its own expense and without additional cost to MWCOG and/or members, those services necessary for the correction of any deficiencies or damages resulting, in whole or in part, from the Contractor's failure. This obligation is in addition to and not in substitution for any other remedy available to MWCOG and/or members under the "Remedies" paragraph, or otherwise available by law.

Severability/Waiver. MWCOG and/or members and Contractor agree that, if any term or provision of this Contract is declared by a court of competent jurisdiction to be illegal or in conflict with any law, the validity of the remaining terms and provisions shall not be affected, and the rights and obligations of the parties shall be construed and enforced as if the Contract did not contain the particular term or provision held to be invalid. The failure of either party to enforce any provision of this Contract shall not constitute a waiver by that party of that or any other provision of this Contract.

Subcontracting or Assignment. The benefits and obligations hereunder shall inure to and be binding upon the parties hereto and neither this Contract nor the services to be performed hereunder shall be subcontracted, or assigned or otherwise disposed of, either in whole or in part, except with the prior written consent of MWCOG and/or members. MWCOG and/or members have the right to withhold such consent for any reason MWCOG and/or members deem appropriate.

Survival. The terms, conditions, representations, and all warranties contained in this Contract shall survive the termination or expiration of this Contract.

Termination. If the Contractor fails to fulfill its obligations under the Contract properly and on time, or otherwise violates any provision of the Contract, MWCOG and/or members may terminate the Contract by written notice to the Contractor. The notice shall specify the acts or omissions relied upon as cause for termination. All finished or unfinished work provided by the Contractor shall, at MWCOG's and/or members option, become MWCOG's and/or member's property. MWCOG and/or members shall pay the Contractor

**RFP 19-007 SELF-CONTAINED BREATHING APPARATUS EQUIPMENT**

fair and equitable compensation for satisfactory performance prior to receipt of notice of termination, less the amount of damages caused by the Contractor's breach. If the damages are more than the compensation payable to the Contractor, the Contractor will remain liable after termination and MWCOG and/or members can affirmatively collect damages.

Termination of Contract for Convenience. The performance of work under this Contract may be terminated by MWCOG and/or members, in whole or in part, upon written notice to the Contractor, when MWCOG and/or members determines such termination is in the best interest of MWCOG and/or members. The termination for convenience is effective on the date specified in MWCOG's and/or members written notice. MWCOG and/or members will pay for all reasonable costs allocable to the Contract for work or costs incurred by the Contractor up to the date of termination. However, the Contractor shall not be reimbursed for any anticipatory profits that have not been earned up to the date of termination.

Termination of Multi-Year Contract. If MWCOG and/or members fail to appropriate funds or if funds are not otherwise made available for continued performance for any fiscal period of this Contract succeeding the first fiscal period, this Contract shall be cancelled automatically as of the beginning of the fiscal year for which funds were not appropriated or otherwise made available; provided, however, that this will not affect either MWCOG's and/or members rights or the Contractor's rights under any termination clause in this Contract. The effect of termination of the Contract hereunder will be to discharge both the Contractor and MWCOG and/or members from future performance of the Contract, but not from their rights and obligations existing at the time of termination. The Contractor shall be reimbursed for the reasonable value of any non-recurring costs incurred but not amortized in the price of the Contract. MWCOG and/or members shall notify the Contractor as soon as it has knowledge that funds may not be available for the continuation of this Contract for each succeeding fiscal period beyond the first.

Time is of the essence. Time is of the essence in Contractor's performance of each and every obligation and duty under this Contract.

Whole Contract. This Contract constitutes the complete and exclusive statement of the Contract between the parties relevant to the purpose described herein and supersedes all prior agreements or proposals, oral or written, and all other communication between the parties relating to the subject matter of this Contract.

*(Revised 8/22/2017)*

**Revision A**

Current revision date: December 1, 2018



**All prices listed herein supercede all other price lists, including (but not limited to) Scott master PDF price list. All prices are subject to change.**

**3M | Scott Fire & Safety Master Price List**

<b>ITEM</b>	<b>Product Description</b>	<b>Signal Code</b>	<b>List Price</b>
0003-1822	MALE CONNECTOR	DIS	\$ 11.80
00-1164	SCREW,TRUSS HD,SS,6-32X0.375 L	SVC	\$ 2.20
0019-0398	REPLACEMENT SENSOR	DIS	\$ 98.95
0023-7354	BATTERY PACK, TLV-I.S.	DIS	\$ 752.00
0023-7383	10 IN. ALUM PROBE/5FT TEF HOSE		\$ 213.00
0051-1175	PCB ASSY, SENSOR BASE		\$ 68.80
0051-1219	BATTERY CHARGER, 120VAC		\$ 108.00
0051-1819	5 FT DAYLON EXT HOSE, W/FTNGS		\$ 93.45
0054-7001	02 SENSOR BODYGUARD		\$ 235.00
009-0050	O-RING, EPDM #010	DIS	\$ 1.05
012574	NOSECUP,REGULAR M95		\$ 43.60
012575	NOSECUP,SMALL M95		\$ 44.40
012577	EXHV SET ASSY, M120/M98		\$ 8.10
012592	PLUG, SPEECH DIAPHRAGM		\$ 7.75
012593	M95, BOTTLE W/BOTTLE CAP		\$ 32.10
012594	MOUTHPIECE DRINKING DEVICE		\$ 7.50
012597	LID,DRINKING DEVICE		\$ 8.50
012598	M95 HEAD HARNESS		\$ 33.00
012688	COVER,EXHALATION VALVE PROMASK	PHO	\$ 9.10
012692	HEAD HARNESS NR, PROMASK	PHO	\$ 33.60
012693	VISOR FRAME REPL SET PM		\$ 14.10
012694	HARNESS BUCKLES SET OF 5		\$ 9.60
012695	VISOR, PROMASK POLYCARB	PHO	\$ 34.60
012698	PROMASK LENS COVERS 10 PKG	PHO	\$ 36.80
012773	V.S., NOSECUP SET OF 2		\$ 6.10
012774	DISCS, VALVE SET OF 4 PM40		\$ 12.80

**Revision A**

Current revision date: December 1, 2018



**All prices listed herein supercede all other price lists, including (but not limited to) Scott master PDF price list. All prices are subject to change.**

**3M | Scott Fire & Safety Master Price List**

<b>ITEM</b>	<b>Product Description</b>	<b>Signal Code</b>	<b>List Price</b>
012775	HEAD HARNESS TEXTILE PROMASK	PHO	\$ 37.90
012776	NOSECUP W/FASTENING RING		\$ 40.40
012778	ASSY KIT,SPEECH DIAPHRAGM(PLY)		\$ 16.30
012779	KIT,SPEECH CHANNEL		\$ 16.30
012789	PM25 FILTER GASKET SET OF 2		\$ 8.75
012798	SPEC KIT, PROMASK, M95		\$ 26.10
013013	M120 CBRN HC	EUI	\$ 287.00
013014	M120 CBRN HC SMALL	EUI	\$ 287.00
013023	PROMASK 25, POLY LENS, NET REG	PHO	\$ 163.00
013024	PROMASK 25, POLY LENS, RUB REG	PHO	\$ 163.00
013027	PROMASK 25 POLY LENS, RUB SM	PHO	\$ 163.00
013028	PROMASK 25 POLY LENS, NET, SM	PHO	\$ 163.00
013222	M110,CBRN,SMALL RIOT W/DRINK	EUI	\$ 332.00
013242	M110,CBRN SMALL RIOT W/O DRINK	EUI	\$ 298.00
013262	M110,CBRN,M/L RIOT W/O DRINK	EUI	\$ 298.00
013263	SAFETYTECH M110,CBRN,M/L	EUI	\$ 220.72
013282	M110,CBRN,M/L RIOT W/DRINK DEV	EUI	\$ 332.00
013372	INH.VALVE SEATS EPDM SET OF 2		\$ 10.60
013374	DISC,EXH VALVE		\$ 12.00
013377	40MM PLUG, M120/M98		\$ 3.40
0204-0022	BATTERY,LITHIUM(COIN TYPE)3.OV	DIS	\$ 8.40
023-0017	GASKET, AUDIO TRANSDUCER	DIS	\$ 3.70
023-0022	LC4G BATTERY FOAM	DIS	\$ 1.05
023-0024	LC4G LCD FOAM	DIS	\$ 2.10
028-0037	12VDC PWR/SUP, 110VAC INPUT	DIS	\$ 84.80
028-0045	9VDC/.66A WALL CUBE,N.A. PLUG	DIS	\$ 16.00

**Revision A**

Current revision date: December 1, 2018



**All prices listed herein supercede all other price lists, including (but not limited to) Scott master PDF price list. All prices are subject to change.**

**3M | Scott Fire & Safety Master Price List**

<b>ITEM</b>	<b>Product Description</b>	<b>Signal Code</b>	<b>List Price</b>
028-0046	MULT INPUT BLADES FOR 028-0045	DIS	\$ 5.25
028-0047	9VDC/5A TABLE TOP POWER SUPPLY	DIS	\$ 42.00
028-0048	N.AMERICAN DETACHABLE CORDSET	DIS	\$ 17.05
028-0049	UK BRITISH DETACHABLE CORDSET	DIS	\$ 17.05
028-0050	EUROPEAN DETACHABLE CORDSET	DIS	\$ 17.05
028-0051	AUSTRALIAN DETACHABLE CORDSET	DIS	\$ 17.05
028-0052	CAR CHARGER - OUTPUT=9VDC/1.3A	DIS	\$ 32.00
028-0053	12 VOLT POWER SUPPLY	DIS	\$ 89.25
028-0055	POWER SUPPLY PROTEGE ZM DS		\$ 62.50
028-0056	POWER SUPPLY BLADE KIT		\$ 13.90
045123	COMB FLTRS CF22 ENFORCE CNSTR		\$ 40.00
045135	CBRN CAP 1 CANISTER		\$ 60.00
045170	MPC40PF SINGLE CARTRIDGE FILTE		\$ 28.40
048-0077	1/8NPT X 3/16 BARBED FITTING		\$ 1.05
048-0084	1/8"HIGH PRESSURE TUB FITTING		\$ 19.15
052683	P100 CARTRIDGE,40MM		\$ 12.60
062-0016	DOWNLOADING QUIK REF SHEET	EXP	\$ 5.55
062-0017	CAL STIK QUIK REF SHEET	EXP	\$ 5.80
062-0026	PROTEGE QUICK GUIDE	SVC	\$ 5.55
063548	PROFLOW BATT NIMH 3.8 AH		\$ 185.00
063791	CHARGER, ANSMANN AN4605 TRAVEL		\$ 185.00
064072	BELT,TEXTILE		\$ 23.80
064073	HOOD HOSE, EPDM		\$ 46.40
064074	BELT,PVC DECON		\$ 29.50
064077	80CM EPDM HOSE W/ANGLE CONNECT		\$ 52.00
064078	80CM HOSE W/STRAIGHT CONNECTOR		\$ 38.60

**Revision A**

Current revision date: December 1, 2018



**All prices listed herein supercede all other price lists, including (but not limited to) Scott master PDF price list. All prices are subject to change.**

**3M | Scott Fire & Safety Master Price List**

<b>ITEM</b>	<b>Product Description</b>	<b>Signal Code</b>	<b>List Price</b>
064079	100CM EPDM HOSE/ANGLE CONNECT		\$ 53.00
064087	PAPR,PROFLOW 2 KIT		\$ 910.00
064088	PAPR,PROFLOW 3 KIT (NO HOSE)		\$ 1,010.00
073-0324	LC4G T8 TORX L-KEY SHORT ARM	DIS	\$ 6.85
073-0355	BELT CLIP PROTEGE ZM		\$ 6.85
073-0359	PCBA IR BLOCK SHROUD		\$ 22.55
073-0360	LI BATTERY HOLDER BRACKET		\$ 11.80
073-0361	USB BLOCK SHROUD PROTEGE ZM		\$ 28.90
073-0362	USB COVER BRACKET PROTEGE ZM		\$ 28.90
073-0364	BRACKET, CAL CUP HOLDER		\$ 9.20
074-0407	NON-OPERATING SENSOR POS. HOLD	DIS	\$ 13.90
074-0546	CASE BOTTOM ASSEMBLY LC4G	SVC	\$ 7.60
074-0547	CAL CUP LC4G	DIS	\$ 2.20
074-0558	LC4G SENSOR DUMMY INSERT	DIS	\$ 6.85
074-0564	PROTEGE ZM CALIBRATION CAP		\$ 6.85
074-0568	ASSEMBLY, P.D.S. THERMOFORM		\$ 226.00
074-0569	CAL CUP MODIFICATION		\$ 8.15
074-0570	PLUG, PRY OUT, 6/6 NYLON		\$ 3.40
075-0005	SPRING,SLIDER BUTTON,SCOUT	EOL	\$ 3.40
076-0104	SCREW,4-24X7/16FLTHD,TORX SOC.		\$ 1.30
076-0120-55	SCREW,PHIL.PAN,4-40X1-1/4,SS	DIS	\$ 1.30
076-0195	M2.5X4, PHILLIPS,PAN HEAD,SS	DIS	\$ 1.60
076-0203	M2.5X10 DELT PT SCREW, PROTEGE	DIS	\$ 1.05
076-0209	M2.5 x 10 DELTA PT SEALING SCR	SVC	\$ 2.60
077-0025	H2S GAS BOTTLE,25 PPM, BAL AIR		\$ 237.00
077-0298	PARTICULATE FILTER, PROBE		\$ 3.40

**Revision A**

Current revision date: December 1, 2018



**All prices listed herein supercede all other price lists, including (but not limited to) Scott master PDF price list. All prices are subject to change.**

**3M | Scott Fire & Safety Master Price List**

<b>ITEM</b>	<b>Product Description</b>	<b>Signal Code</b>	<b>List Price</b>
077-0309	SCOUT HOLSTER	EOL	\$ 78.50
077-0317	PROBE HYDROPHOBIC FILTER		\$ 6.85
077-0323	FITTING, LUER/BARB		\$ 1.30
077-0351	METHANE/O2/CO/H2S GAS CYL. 34L	DIS	\$ 254.00
077-0352	METHANE/O2/CO/H2S GAS CYL. 58L		\$ 318.00
077-0355	METHANE/O2/H2S GAS CYL. 34L		\$ 181.00
077-0357	METHANE/BAL. AIR CYL. 34L 2AL		\$ 53.55
077-0376	SCOUT HOLSTER, VISIBLE YELLOW	EOL	\$ 102.00
077-0389	DEMAND FLOW REG, 5E W/CGA590		\$ 470.00
077-0410	100PPM ISOBUTYLENE/BAL AIR,7HP		\$ 84.80
077-0411	100PPM ISOBUTYLENE/BAL AIR,2AL		\$ 159.00
077-0426	100PPM ISOBUTYLENE/BAL AIR,6D		\$ 204.00
077-0452	ABRASIVE DISC,1200 GRIT(P2500)	DIS	\$ 1.30
077-0453	TWEEZERS, PRECISION, #1, SS		\$ 13.90
077-0454	SCREWDRIVER, #1 PHILLIPS		\$ 9.45
077-0455	NYLON ROD, 1/16DIA.X 6" LONG	EXP	\$ 1.30
077-0456	LAMP, REPLACEMENT, 10.6EV PID		\$ 411.00
077-0459	FILTER & CAP ASSEMBLY PID		\$ 52.75
077-0463	REPLCMNT SHOULDER STRAP, SCOUT	EOL	\$ 7.35
077-1200	ACCESS CASE W/DIE CUT INSERT	DIS	\$ 105.00
077-1269	PROPANE/O2/CO/H2S GAS CYL.,34L		\$ 255.00
077-1287	NITROGEN TRIFLUORIDE 10PPM CAL		\$ 530.00
077-1311	CALIBRATION KIT		\$ 37.80
077-1345	LC4G BUCKLE	DIS	\$ 3.70
077-1346	USB CABLE, A TO MINI B CONN.	DIS	\$ 11.55
077-1352	LC4G BATTERY HEAT SHRINK/WIRE	DIS	\$ 61.15



**Revision A**

Current revision date: December 1, 2018



**All prices listed herein supercede all other price lists, including (but not limited to) Scott master PDF price list. All prices are subject to change.**

**3M | Scott Fire & Safety Master Price List**

<b>ITEM</b>	<b>Product Description</b>	<b>Signal Code</b>	<b>List Price</b>
077-1379	PENTANE/H2S/CO/O2 CYL: 58L/8AL		\$ 318.00
077-1392	PORTABLE DOCKING STATION CASE		\$ 226.00
077-1394	GAUGE PROTEGE ZM DOCKING STATI		\$ 20.50
077-1395	BULKHEAD FITTING 5/16" TUBE		\$ 20.50
093-0148	2701-E PROBE FOR PORT. PRODUCT	DIS	\$ 67.75
093-0176	BATTERY CHRGR,SINGLE UNIT/INTF		\$ 215.00
093-0230	CO/H2S SENSOR(DUAL TOX)(REV.3)	DIS	\$ 282.00
093-0231	COMBUSTIBLE SENSOR	DIS	\$ 170.00
093-0232	OXYGEN SENSOR	DIS	\$ 136.00
093-0366	SENS MANIFOLD MEMBRANE W/ADHES	DIS	\$ 7.35
093-0470	SENSOR (CO) CARBON MONOXIDE	DIS	\$ 181.00
093-0471	SENSOR (H2S) HYDROGEN SULFIDE	SVC	\$ 181.00
093-0524	SENSOR, COMBUSTIBLE	DIS	\$ 170.00
093-0526	DOCKING STATION	DIS	\$ 1,587.00
093-0527	DOCKING STATION USB CABLE		\$ 47.50
093-0534	INLET FILTER REPLACEMENT PACK	DIS	\$ 50.65
093-0582	USB STICK-2 GB PROTEGE ZM DOCK		\$ 22.55
093-0587	SWITCH, PUSH BUTTON, BLACK		\$ 24.70
093-0588	IR CONNECT ASSEMBLY		\$ 108.00
093-0589	IR LINK, USB CABLE SPECIAL		\$ 5.55
093-0590	IR LINK TOP ASSEMBLY		\$ 27.85
093-0591	DC JACK&WIRE ASSY W/CONNECTOR		\$ 20.50
093-0592	BATTERY ASSY. W/WIRING & PLUG		\$ 40.95
093-0593	MAIN PCB ASSY. PROTEGE ZM DS		\$ 277.00
096-2389	CALIBRATION KIT, 25 PPM H2S		\$ 354.00
096-2391	O2 CHK GAS KIT,18.5,20.9,23.5%		\$ 343.00

**Revision A**

Current revision date: December 1, 2018



**All prices listed herein supercede all other price lists, including (but not limited to) Scott master PDF price list. All prices are subject to change.**

**3M | Scott Fire & Safety Master Price List**

<b>ITEM</b>	<b>Product Description</b>	<b>Signal Code</b>	<b>List Price</b>
096-2392	MEMBRANE REPLACEMENT KIT		\$ 58.55
096-2504-1	PUMP KIT,PUMP W/CLR TUBING		\$ 200.00
096-2506-10	.5L BUL,TUBING,34L LEL/CO/H2S		\$ 336.00
096-2506-11	.5L BUL,TUBING,58L LEL/CO/H2S		\$ 406.00
096-2506-12	.5L BUL,TUBING,34L LEL/CO		\$ 183.00
096-2506-13	.5L BUL,TUBING,103L LEL/CO		\$ 300.00
096-2506-14	.5L BUL,TUBING,34L LEL/H2S		\$ 353.00
096-2506-15	.5L BUL,TUBING,58L LEL/H2S		\$ 405.00
096-2506-16	.5L REG,TUBING,34L LEL/CO/H2S		\$ 431.00
096-2506-17	.5L REG,TUBING,58L LEL/CO/H2S		\$ 490.00
096-2506-18	.5L REG,TUBING,34L LEL/CO		\$ 270.00
096-2506-19	.5L REG,TUBING,103L LEL/CO		\$ 380.00
096-2506-20	.5L REG,TUBING,34L LEL/H2S		\$ 431.00
096-2506-21	.5L REG,TUBING,58L LEL/H2S		\$ 490.00
096-2506-22	DF REG,TUBING,34L LEL/CO/H2S		\$ 657.00
096-2506-23	DF REG,TUBING,58L LEL/CO/H2S		\$ 704.00
096-2506-24	DF REG,TUBING,34L LEL/CO		\$ 490.00
096-2506-25	DF REG,TUBING,103L LEL/CO		\$ 612.00
096-2506-26	DF REG,TUBING,34L LEL/H2S		\$ 662.00
096-2506-27	DF REG,TUBING,58L LEL/H2S		\$ 495.00
096-2508	PCB ASSY,MAIN INST. BOARD	DIS	\$ 221.00
096-2509	PCB ASSY,IRDA FLAG BD,MAIN BD	DIS	\$ 235.00
096-2517	ASSY, SENSOR COVER/SHUTTER	DIS	\$ 38.85
096-2526	ASSY, NH3 SENSOR		\$ 394.00
096-2528	ASSEMBLY, DUAL TOXIC SENSOR		\$ 354.00
096-2531	ASSY, HCN SENSOR		\$ 353.00

**Revision A**

Current revision date: December 1, 2018



**All prices listed herein supercede all other price lists, including (but not limited to) Scott master PDF price list. All prices are subject to change.**

**3M | Scott Fire & Safety Master Price List**

<b>ITEM</b>	<b>Product Description</b>	<b>Signal Code</b>	<b>List Price</b>
096-2532	ASSY, NO2 SENSOR		\$ 353.00
096-2535	NON-OPERATING SENSOR POS. HOLD	DIS	\$ 18.40
096-2536	CASE TOP HALF, HALL POST ASSY.	EOL	\$ 70.10
096-2554	ASSY, 12V PWR CORD, CHARGER		\$ 23.90
096-2656	CALIBRATION KIT, 5 PPM CL2		\$ 589.00
096-2658	CALIBRATION KIT, 1 PPM PH3		\$ 589.00
096-2660	CALIBRATION KIT, 25 PPM NH3		\$ 589.00
096-2662	CALIBRATION KIT, 10 PPM SO2		\$ 382.00
096-2862-1	ASSY, SCRUBBER ATTACH, NOX		\$ 45.40
096-2862-2	ASSY, SCRUBBER ATTACH, CHARCOAL		\$ 45.40
096-2893	CALIBRATION KIT, 10 PPM HCN		\$ 582.00
096-2894	CALIBRATION KIT, 5 PPM NO2		\$ 582.00
096-2920	MITEX (PTFE) MEMBRANE REPL KIT		\$ 88.20
096-2957	ASSY., CHARCOAL REFILL KIT		\$ 35.45
096-3053-1	PHOSGENE TYPE 1 BADGE, 3 DAY		\$ 8.15
096-3053-2	PHOSGENE TYPE 1 BADGE, 3 DAY		\$ 419.00
096-3167	10 FT TYGON TUBING ASSY.	DIS	\$ 18.40
096-3223	SCOUT CO2 SENSOR ASSEMBLY		\$ 501.00
096-3245	LC4G PUMP ASSEMBLY	DIS	\$ 170.00
096-3247	PROTEGE LCD KIT ASSEMBLY	SVC	\$ 22.05
096-3249	LC4G TOP CASE REPLACEMENT KIT	DIS	\$ 37.80
096-3257	LC4G CHARGER/COMM BOX ASSEMBLY	DIS	\$ 99.75
096-3259	PROTEGE PUMP MODULE ASSEMBLY	DIS	\$ 215.00
096-3259-CSA	PROTEGE PUMP MODULE ASSY.(CSA)	SVC	\$ 215.00
096-3262	LC4G 4 GAS MAIN ASSY. -SENSORS	SVC	\$ 331.00
096-3263	LC4G 2/3 GAS MAIN ASSY-SENSORS		\$ 345.00

**Revision A**

Current revision date: December 1, 2018



**All prices listed herein supercede all other price lists, including (but not limited to) Scott master PDF price list. All prices are subject to change.**

**3M | Scott Fire & Safety Master Price List**

<b>ITEM</b>	<b>Product Description</b>	<b>Signal Code</b>	<b>List Price</b>
096-3264	PROTEGE 4 GAS FINAL ASSEMBLY	DIS	\$ 577.00
096-3271	LC4G PUMP KIT		\$ 268.00
096-3272	.5L REG,TUBING,34L LEL CAL KIT		\$ 250.00
096-3276	PROTEGE US CHARGER/COMM. KIT	DIS	\$ 147.00
096-3277	PROTEGE GLOBAL CHARGER/COMM.	DIS	\$ 147.00
096-3278	PROTEGE REPLACEMENT BUCKLE	DIS	\$ 4.40
096-3286	PROTEGE FIELD PROGRAMMER ASSY		\$ 103.00
096-3366	PORTABLE INSTRUMENTS LINE CD	DIS	\$ 8.95
096-3386	PROTEGE EXTERNAL PUMP FILTER	DIS	\$ 9.95
096-3392	CALIBRATION KIT (PROPANE)		\$ 432.00
096-3393	CALIBRATION KIT (PENTANE)		\$ 497.00
096-3459-01	ProZM CO Red Assembly		\$ 169.00
096-3459-02	ProZM H2S Red Assembly		\$ 169.00
096-3459-03	ProZM O2 Red Assembly		\$ 169.00
096-3467-01	ProZM TS Port Assembly		\$ 1,995.00
096-3467-02	ProZM TS Stat Assembly		\$ 1,890.00
096-3469	ASSEMBLY, MICROPHONE PLATE		\$ 44.10
096-3470-1	REGULATOR ASSY PROTETE ZM DS		\$ 441.00
096-3470-2	REGULATOR ASSY PROTETE ZM DS		\$ 155.00
096-3474	PROTEGE ZM CD ASSEMBLY		\$ 5.25
096-3499	POLYETHYLENE TUBING 1/4"ODx10'		\$ 10.75
10000113	SCREW, RETAINING	SVC	\$ 4.10
10000369	NIPPLE		\$ 47.80
10004865	DECAL SKA-PAK CYLINDER		\$ 3.80
10005135	FACE SEAL - LARGE	SVC	\$ 53.00
10005178	LEVER, TOGGLE		\$ 16.20

**Revision A**

Current revision date: December 1, 2018



**All prices listed herein supercede all other price lists, including (but not limited to) Scott master PDF price list. All prices are subject to change.**

**3M | Scott Fire & Safety Master Price List**

<b>ITEM</b>	<b>Product Description</b>	<b>Signal Code</b>	<b>List Price</b>
10005201	ELBOW, STREET		\$ 10.10
10005218	KNOB, REGULATOR PURGE	SVC	\$ 6.40
10005228	SUPPORT, VALVE TUBE		\$ 2.20
10005229	SPRING DEMAND VALVE/LATCH	EXP	\$ 2.20
10005233	PLATE, LATCH		\$ 7.75
10005250	FILTER, CARTRIDGE-PRESS REDUCER	SVC	\$ 3.25
10005254	SCREW, RETAINER, SEAT *KB*	DIS	\$ 17.25
10005259	LEVER, PISTON	SVC	\$ 3.25
10005269	PLATE, TAB LOCK	SVC	\$ 5.50
10005279	NIPPLE, COUPLING A.P.4.5		\$ 66.00
10005284	KB SEAT, POPPET		\$ 3.25
10005286	SHAFT, PRESS-TO-TEST	SVC	\$ 6.60
10005296	BODY, PRESSURE REDUCER		\$ 800.00
10005299	SPRING, PRIMARY PRESS REDUCER	DIS	\$ 6.60
10005300	SPRING, SECONDARY PRESS REDUCER	SVC	\$ 6.60
10005302	PISTON, TRANSFER VLV AUTO ACT	DIS	\$ 10.90
10005303	SLEEVE, TRANS VALVE, AUTO ACT	DIS	\$ 34.90
10005305	RING, BACK-UP	EXP	\$ 3.25
10005322	PLATE, APPROVAL	SVC	\$ 3.60
10005331	NIPPLE, COUPLING A.P.2.2		\$ 51.00
10005354	LABEL, IDENTIFICATION		\$ 4.80
10005368	GASKET	SVC	\$ 14.10
10005375	WASHER, THRUST	EXP	\$ 2.20
10005384	DECAL-CYLINDER	DIS	\$ 3.25
10005431	LABEL, APPROVAL	SVC	\$ 3.25
10005473	PROBE, CONNECTING		\$ 6.90

**Revision A**

Current revision date: December 1, 2018



**All prices listed herein supercede all other price lists, including (but not limited to) Scott master PDF price list. All prices are subject to change.**

**3M | Scott Fire & Safety Master Price List**

<b>ITEM</b>	<b>Product Description</b>	<b>Signal Code</b>	<b>List Price</b>
10005603	VALVE, INHALATION		\$ 4.40
10005638	VALVE RELIEF		\$ 192.00
10005654	PLUG DUMMY		\$ 80.00
10005656	PUNCH PIN	DIS	\$ 24.90
10005657	PLIERS	SVC	\$ 60.00
10005658	PLIERS, RETAINING RING	DIS	\$ 82.00
10005744	TUBE, GUIDE *KB*		\$ 9.00
10005756	OUTLET, CHECK VALVE		\$ 29.10
10005759	SLEEVE, STRIKER-ALARM		\$ 21.20
10005773	SHAFT, PISTON	SVC	\$ 77.00
10005774	SLEEVE	SVC	\$ 12.25
10005775	SEAT, VALVE -KB-	SVC	\$ 56.00
10005776	HEAD, PISTON	SVC	\$ 27.80
10005856	PLUG	DIS	\$ 23.80
10005857	CLAMP		\$ 3.10
10005898	BAIL, CYLINDER BAND		\$ 25.90
10005913	AV/SOV EPDM FACESEAL SML-GREEN	SVC	\$ 54.00
10005959	PACKING	EXP	\$ 3.25
10005961	RETAINER, CHECK VALVE	DIS	\$ 65.00
10005973	PLUG		\$ 40.20
10006212	FACE SEAL, X-LARGE	SVC	\$ 53.00
10006289	HANGER, CYLINDER	SVC	\$ 21.75
10006448	SPRING-RSPTR POSITIVE PRESS		\$ 5.40
10006455	PACKING, PREFORMED	EXP	\$ 3.25
10006899	HANDWHEEL, VALVE		\$ 6.25
10006900	PLUG, HANDWHEEL		\$ 0.60

**Revision A**

Current revision date: December 1, 2018



**All prices listed herein supercede all other price lists, including (but not limited to) Scott master PDF price list. All prices are subject to change.**

**3M | Scott Fire & Safety Master Price List**

<b>ITEM</b>	<b>Product Description</b>	<b>Signal Code</b>	<b>List Price</b>
10006901	SPRING,HANDWHEEL		\$ 0.75
10006916	NUT,VALVE STEM		\$ 2.30
10007327	TEENUT,CAPPED		\$ 4.40
10007328	SCREW,SELF-LOCKING,TRUSS HD	EXP	\$ 2.20
10007329	SCREW,SELF-LOCKING,TRUSS HD		\$ 2.20
10007331	SLIDE	EXP	\$ 3.25
10007358	LEVER,DIAPHRAGM	SVC	\$ 3.60
10007461	NUT, SELF-LOCKING	DIS	\$ 2.20
10007462	SCREW,TRUSS HEAD (PHILLIPS)	DIS	\$ 2.20
10007472	SCREW,TAPPING TORX PAN HEAD		\$ 2.30
10007540	SPACER, BEARING		\$ 13.00
10007560	PACKING, PREFORMED	EXP	\$ 3.25
10007561	PACKING, PREFORMED	EXP	\$ 3.25
10007562	PACKING, PREFORMED		\$ 3.25
10007563	PACKING, PREFORMED	SVC	\$ 3.25
10007564	PACKING, PREFORMED		\$ 3.25
10007565	PACKING, PREFORMED		\$ 3.25
10007775	SCREW,THD PAN HEAD TYPE BT	SVC	\$ 2.20
10007834	NIPPLE, REDUCING		\$ 14.10
10007842	PIN, SPIRAL	SVC	\$ 2.20
10007861	LABEL,COVER,REGULATOR	DIS	\$ 3.25
10007862	PLATE, IDENTIFICATION		\$ 3.30
10007874	PLATE, RETAINER, BODY	SVC	\$ 3.25
10007881	EZ FLO DIAPHRAGM RETANING RING	SVC	\$ 8.00
10007884	SPRING, POSITIVE PRESSURE	EXP	\$ 2.30
10007892	PLATE, SUPPORT		\$ 25.60

**Revision A**

Current revision date: December 1, 2018



**All prices listed herein supercede all other price lists, including (but not limited to) Scott master PDF price list. All prices are subject to change.**

**3M | Scott Fire & Safety Master Price List**

<b>ITEM</b>	<b>Product Description</b>	<b>Signal Code</b>	<b>List Price</b>
10007893	BRACKET,PLATE,SUPPORT		\$ 10.10
10007895	PRIMER, LOCTITE**	SVC	\$ 88.00
10007896	LUBRICANT, "O" RING	EXP	\$ 36.00
10007970	STYLUS	SAR	\$ 26.60
10007997	NOSECLIP		\$ 2.40
10008002	CLIP, BELT		\$ 4.10
10008005	SOCKET		\$ 123.00
10008033	HANSEN HK PLUG, 1/4" ID		\$ 25.40
10008103	RETAINER, FRAME		\$ 5.50
10008146	TIE, CABLE	DIS	\$ 2.25
10008196	BOOT, LATCH PLATE	SVC	\$ 5.40
10008212	BAG, PLEATED	EXP	\$ 2.00
10008221	RETAINER, BAG-BELT CLIP		\$ 2.30
10008234	PLUG & HOSE FITTING ASSY		\$ 61.00
10008235	SOCKET & HOSE FITTING ASSY		\$ 87.00
10008244	LABEL,IDENT. E-Z FLO REG		\$ 3.25
10008382	DECAL EAGLE	SVC	\$ 3.25
10008383	DISC, NOSECUP VALVE (5-1-1081)		\$ 4.30
10008398	RING, RETAINING, NOSE CUP		\$ 4.30
10008400	DUCT, VOICEMITTER	SVC	\$ 9.50
10008401	SEAL,ADPT,NSECUP(NON-SALEABLE)		\$ 2.40
10008451	WASHER, ANTI-ROTATION (QTY 10)	EXP	\$ 2.20
10008475	VALVE, INHALATION		\$ 5.40
10008492	SCREW, SEAL		\$ 2.60
10008522	HEAD HARNESS 5 STRAP		\$ 77.00
10008531	CAP, DUST	DIS	\$ 29.10



**Revision A**

Current revision date: December 1, 2018



**All prices listed herein supercede all other price lists, including (but not limited to) Scott master PDF price list. All prices are subject to change.**

**3M | Scott Fire & Safety Master Price List**

<b>ITEM</b>	<b>Product Description</b>	<b>Signal Code</b>	<b>List Price</b>
10008532	LATCH	SVC	\$ 6.60
10008535	STRAP,GAUGE RETAINING	SVC	\$ 7.20
10008536	SUPPORT, WAIST		\$ 140.00
10008537	TIP, FLAT-VINYL	SVC	\$ 3.25
10008538	PIN, LEVER		\$ 5.50
10008561	LABEL, NFPA-1992 (ASC ONLY)	DIS	\$ 10.60
10008583	PLATE, INSTRUCTION		\$ 3.25
10008694	LABEL, COVER, REGULATOR		\$ 5.10
10008734	BODY, VALVE & HOSE -KB-	SVC	\$ 48.90
10008817	RETAINER, CHECK VALVE **		\$ 72.00
10008819	NIPPLE,COUPLING,PRESS REDUCER	SVC	\$ 56.00
10008850	COVER, PLATE		\$ 13.00
10008866	CLAMP, CYLINDER 10 MIN SKAPAK		\$ 12.00
10008880	HOLDER, REGULATOR -KB-	SVC	\$ 32.25
10008904	DECAL, SKA-PAK 4500 PSI		\$ 2.40
10008912	PACKING, PREFORMED	EXP	\$ 2.20
10008922	SLEEVE, LOW CYL. TRANSFER, 4.5	DIS	\$ 14.10
10008924	PACKING, PREFORMED	DIS	\$ 3.25
10008925	SLEEVE, LOW CYL. TRANSFER, 2.2	SVC	\$ 13.00
10008927	PACKING, PREFORMED	DIS	\$ 3.25
10008972	KIT, LOW CYL. TRANSFER, 4.5	SVC	\$ 88.00
10008973	KIT, LOW CYL. TRANSFER, 2.2	SVC	\$ 88.00
10009015	SPRING, COMPRESSION **		\$ 4.50
10009050	PA CONTROL MODULE GASKET		\$ 2.25
10009051	PACKING, PREFORMED	EXP	\$ 3.25
10009057	PACKING, PREFORMED	EOL	\$ 3.25

**Revision A**

Current revision date: December 1, 2018



**All prices listed herein supercede all other price lists, including (but not limited to) Scott master PDF price list. All prices are subject to change.**

**3M | Scott Fire & Safety Master Price List**

<b>ITEM</b>	<b>Product Description</b>	<b>Signal Code</b>	<b>List Price</b>
10009086	SOCKET, FOSTER		\$ 79.00
10009144	HOLDER, EYEGLOSS		\$ 10.40
10009148	BAIL, OFFSET WIRE		\$ 2.75
10009149	BAIL, INLINE WIRE	SVC	\$ 2.75
10009151	CLAMP		\$ 24.30
10009161	LATCH STRAP BACKFRAME PIN AP50		\$ 16.20
10009191	DRIVE CAP BACKFRAME		\$ 3.25
10009192	EDGING BACKFRAME	SVC	\$ 25.90
10009204	WASHER		\$ 2.20
10009205	PLATE, SUPPORT		\$ 4.40
10009224	FRAMES, EYEGLOSS		\$ 59.00
10009225	RING, EYEGLOSS SUSPENSION		\$ 6.00
10009256	SLIDE BACKFRAME *KB*	SVC	\$ 15.10
10009286	SCREW, SELF-LOCKING, PAN HEAD	SVC	\$ 2.20
10009324	CARRYING BAG		\$ 176.00
10009349	WASHER, WEAR BACKFRAME	EXP	\$ 2.20
10009372	SLEEVE,LOW CYL TRANSFER, 3.0	DIS	\$ 13.00
10009421	LABEL, APPROVAL	SVC	\$ 4.80
10009422	LABEL, NFPA-92 3.0		\$ 21.75
10009427	SOCKET BUTTON HD CAP SCR-SS	SVC	\$ 2.20
10009513	COUPLING,QUICK CHARGE MALE*KB*	SVC	\$ 570.00
10009514	BOOT,QUICK CHARGE MALE CPLG	SVC	\$ 64.00
10009592	*CPLG, QUICK CHARGE MALE, 4.5	DIS	\$ 453.00
10009593	HOSE, CHARGING WAND *KB*		\$ 308.00
10009594	CPLG, QUICK CHARGE FEMALE, 3.0		\$ 246.00
10009595	CPLG, QUICK CHARGE FEMALE, 4.5	DIS	\$ 269.00

**Revision A**

Current revision date: December 1, 2018



**All prices listed herein supercede all other price lists, including (but not limited to) Scott master PDF price list. All prices are subject to change.**

**3M | Scott Fire & Safety Master Price List**

<b>ITEM</b>	<b>Product Description</b>	<b>Signal Code</b>	<b>List Price</b>
10009598	NOSE CUP RETAIN RING(804019)	DIS	\$ 94.00
10009601	ADAPTER, CHARGING WAND		\$ 30.10
10009614	AP/PA HOSE CLAMP		\$ 3.35
10009633	BRACKET, BAIL		\$ 29.10
10009641	BELL, IND.2.2/4.5 REDUCER**		\$ 15.10
10009643	LABEL, SCOTT 2.2 REDUCER		\$ 9.80
10009650	LABEL,CVR REGULATOR(804475-02)		\$ 2.00
10009660	LABEL, 2.2 & 4.5 INDL SCBA		\$ 9.75
10009671	CYL,CARBON WRAP-30 MIN 4500PSI		\$ 1,010.00
10009672	CYL,CARBON WRAP-60 MIN 4500PSI		\$ 1,550.00
10009673	CYL,CARBON WRAP-45 MIN 4500PSI		\$ 1,320.00
10009675	SKA PAK CASE LATCHES		\$ 3.00
10009705	2.2 TRANSFER VALVE*		\$ 64.00
10009707	ISCBA MANIFOLD PN/SN LABEL**		\$ 3.25
10009708	LABEL,P/N &SN,IND4.5 REDUCER**	EXP	\$ 3.25
10009709	LABEL, SCOTT 4.5 REDUCER		\$ 4.40
10009720	SKAPAK RDCR TS ADAPT**		\$ 19.60
10009748	ALARM SEAT,IND2.2/4.5 RDR**		\$ 71.00
10009776	BAFFLE PLATE,IND2.2/4.5 RDR**		\$ 6.40
10009779	AV2/SOV MOLDED FACE SEAL (CS)	DIS	\$ 53.00
10009812	STRAP, HOOK & LOOP		\$ 13.75
10010063	CYL,CARBON, 30MIN. 2216 PSI		\$ 1,090.00
10010198	LADDER BAIL ASY WF 2.2/4.5		\$ 40.20
10010200	BAND, CYLINDER		\$ 23.80
10010212	FENESTRA (MOD) NAVSEA		\$ 84.00
10010224	INSULATOR CUP (LED ALERT)		\$ 16.20

**Revision A**

Current revision date: December 1, 2018



**All prices listed herein supercede all other price lists, including (but not limited to) Scott master PDF price list. All prices are subject to change.**

**3M | Scott Fire & Safety Master Price List**

<b>ITEM</b>	<b>Product Description</b>	<b>Signal Code</b>	<b>List Price</b>
10010227	BATTERY (3V WATCH)(LED ALARM)		\$ 10.90
10010343	CYL,HOOP-WRAP GLASS 15MIN 3000		\$ 499.00
10010352	COUPLING, QUICK CHARGE, 2.2		\$ 330.00
10010449	NAVSEA 25'HOSE,CHRG WAND *KB*		\$ 473.00
10010477	NAVSEA 10'HOSE,CHRG WAND *KB*		\$ 262.00
10010499	SILICONE FACE SEAL, X-LARGE		\$ 80.00
10010580	3.0,30MIN, CARBON CYLINDER		\$ 1,310.00
10010636	GASKET, 40MM ADAPTER		\$ 2.00
10010642	HEAD HARNESS, 4 STRAP		\$ 38.40
10010666	BEARING (EZFLO PURGE BODY)	SVC	\$ 3.30
10010667	O'RING (EZFLO PURGE BODY)	SVC	\$ 3.30
10010684	PLATE, MOUNTING**		\$ 9.00
10010685	CRICKET/BELL RETAINING STRAP	DIS	\$ 4.00
10010754	PLUG VALVE, LOW PRESSURE		\$ 91.00
10010824	SKA-PAK NIOSH LABEL FOR CYL		\$ 10.90
10010826	CYL,CARBON 45 MIN 4500PSI S/S		\$ 1,320.00
10010906	GASKET, LED ALARM		\$ 13.75
10010907	BOOT, LED ALARM		\$ 8.00
10010908	BELL FOR EOST ALARM (MODIFIED)		\$ 24.90
10010978	AVHOOD INTEGRATED SNAP & NUT		\$ 9.60
10011011	KB NOSECUP, AV3000 SMALL		\$ 45.80
10011012	KB NOSECUP, AV3000 MEDIUM	DIS	\$ 45.80
10011013	KB NOSECUP, AV3000 LARGE	DIS	\$ 45.80
10011014	KB INHALATION VALVE	DIS	\$ 3.75
10011015	KB RETAINING RING, NOSECUP	DIS	\$ 6.80
10011024	BEZEL, UPPER	SVC	\$ 9.75

**Revision A**

Current revision date: December 1, 2018



**All prices listed herein supercede all other price lists, including (but not limited to) Scott master PDF price list. All prices are subject to change.**

**3M | Scott Fire & Safety Master Price List**

<b>ITEM</b>	<b>Product Description</b>	<b>Signal Code</b>	<b>List Price</b>
10011025	BEZEL, LOWER	SVC	\$ 14.90
10011026	KB DUCT, VOICEMITTER, RIGHT	DIS	\$ 7.60
10011027	KB DUCT, VOICEMITTER, LEFT	DIS	\$ 11.25
10011028	PAD, BUCKLE, AV3000	EXP	\$ 2.25
10011038	INHALATION VALVE		\$ 7.40
10011051	GASKET, C420 PAPR SET OF TWO		\$ 48.30
10011094	COVER, EXHAUST VALVE, XCEL	PHO	\$ 2.25
10011095	ADJUSTER, CLIP,XCEL	PHO	\$ 1.75
10011096	ADJUSTER, D-RING,XCEL	PHO	\$ 1.75
10011100	PC,0-200PSIG GAUGE,STEM MNT**		\$ 132.00
10011102	SEAL, HALF MASK TEST ADAPTER		\$ 11.75
10011121	BRACKET		\$ 13.00
10011167	SWAT-PAK BACK COVER		\$ 259.00
10011171	PLATE, INSTR., SWAT PAK		\$ 4.40
10011195-01	DUAL EBSS RETNG STRAP,POUCH	SVC	\$ 39.10
10011202	LENS, HI TEMP REMOTE GAUGE		\$ 18.00
10011209	ELBOW, 1/4"NPT-F		\$ 73.00
10011216	CARRIAGE BOLT, 1/4-20X1/2**		\$ 2.20
10011217	NYLON INSERT LOCKNUT, 1/4-20**		\$ 3.25
10011374	PACKING,PREFORMED	SVC	\$ 3.25
10011490	TUBING, XCEL FIT TEST ADPT	PHO	\$ 3.30
10011499	NIPPLE, COUPLING		\$ 40.20
10011554	PLUG		\$ 9.00
10011653	SCREW,PANEL,CAPTIVE,PAN HD		\$ 2.20
10011687	SLIDE,QUARTER TURN ADAPTER		\$ 3.30
10011688	COVER, EXHALATION VALVE		\$ 10.40

**Revision A**

Current revision date: December 1, 2018



**All prices listed herein supercede all other price lists, including (but not limited to) Scott master PDF price list. All prices are subject to change.**

**3M | Scott Fire & Safety Master Price List**

<b>ITEM</b>	<b>Product Description</b>	<b>Signal Code</b>	<b>List Price</b>
10011690	SPRING, QUICK RELEASE SLIDE	EXP	\$ 1.90
10011745	QD PLUG (FOSTER)		\$ 30.75
10011747	QD PLUG (CEJN)		\$ 92.00
10011748	QD SOCKET (CEJN)		\$ 132.00
10011775	DIAPHRAM SHROUD	DIS	\$ 5.50
10011784	LABEL,REGULATOR COVER		\$ 4.80
10011882	TACTICAL CARRIER, MASK BAG M95		\$ 110.00
10012062	SEAL SILICONE,6 PIN,QD CONNECT		\$ 4.90
10012121	SIZING DISC., SMALL, AV3000	EXP	\$ 1.90
10012122	SIZING DISC., MEDIUM,AV3000	EXP	\$ 1.90
10012123	SIZING DISC.,LARGE, AV3000	EXP	\$ 1.90
10012126	LABEL, SIZING, FACEPIECE		\$ 0.60
10012127	MANIFOLD, QUICK DISCONNECT		\$ 136.00
10012128	Q D,MALE,CHECKED *KB*	SVC	\$ 255.00
10012129	Q D,FEMALE,CHECK *KB*	SVC	\$ 217.00
10012133	SCREW,SEAL,PANHD,SELF-TAP,AB		\$ 2.20
10012151	TACTICAL CARRIER,SHDR STRP M95		\$ 24.00
10012152	TACTICAL CARRIER,LEG STRP M95		\$ 17.00
10012157	PIN, LATCH LOCK		\$ 14.10
10012162	SEAL, SWITCH CONTACTS	DIS	\$ 2.30
10012167	COVER, SWITCH		\$ 2.30
10012168	SEAL, SWTICH COVER		\$ 3.30
10012169	DISC,NIPPLE	SVC	\$ 27.00
10012175	WASHER, SWIVEL		\$ 3.60
10012176	SCREW, LOCK		\$ 2.20
10012203	FITTING, 4500 PSI CGA		\$ 48.60

**Revision A**

Current revision date: December 1, 2018



**All prices listed herein supercede all other price lists, including (but not limited to) Scott master PDF price list. All prices are subject to change.**

**3M | Scott Fire & Safety Master Price List**

<b>ITEM</b>	<b>Product Description</b>	<b>Signal Code</b>	<b>List Price</b>
10012204	FITTING, 2216 PSI CGA		\$ 48.60
10012207	PROBE, 4500 PSI	SVC	\$ 79.00
10012208	PROBE, 2216 PSI		\$ 78.00
10012218	NOSECUP, AV3000 X-LARGE		\$ 45.80
10012222	LABEL, ALKALINE BATTERY HLDR		\$ 6.60
10012260	LABEL, BEZEL, USER NAME		\$ 0.40
10012265	LABEL, APPROVAL,NFPA 1998,SE+		\$ 3.25
10012298	SPRING, PISTON	SVC	\$ 16.20
10012299	SPRING, SEAL RETAINER	SVC	\$ 8.75
10012304	SPRING, COMPRESSION	EXP	\$ 9.00
10012311	SPRING, COMPRESSION	EXP	\$ 2.30
10012346	EEOSTI BATTERY COVER		\$ 9.50
10012347	EEOSTI GASKET		\$ 14.50
10012361	LABEL,NIOSH,AIR-PAK NXG2	DIS	\$ 6.40
10012376	CABLE ASSY,PRESSURE REDUCER	DIS	\$ 86.00
10012395	MTG BRKT, DISPLAY HOUSING	SVC	\$ 5.50
10012416	ELECTRONIC ENCLOSURE	EOL	\$ 82.00
10012417	COVER, ELECTRONICS ENCLOSURE	EOL	\$ 34.90
10012418	ELECTRONIC ENCLOSURE,GASKET	EOL	\$ 7.80
10012421	PC CABLE, BASE UNIT		\$ 208.00
10012422	SEMS USER PROG SOFTWARE		\$ 176.00
10012424	SOUND CHAMBER	EOL	\$ 26.40
10012438	ROLL PIN, EEOSTI	EXP	\$ 2.20
10012457	SCREW,CAPTIVE,PAN HD,SEMS/EMS		\$ 2.20
10012484	CYL,CARB,FULL WRAP 5 MIN 3.0		\$ 473.00
10012485	CYL,CARB,FULL WRAP 10 MIN 3.0		\$ 560.00

**Revision A**

Current revision date: December 1, 2018



**All prices listed herein supercede all other price lists, including (but not limited to) Scott master PDF price list. All prices are subject to change.**

**3M | Scott Fire & Safety Master Price List**

<b>ITEM</b>	<b>Product Description</b>	<b>Signal Code</b>	<b>List Price</b>
10012488	WAIST TO SHOULDER STRAP KB	SVC	\$ 83.00
10012512	LABEL,ELSA 5,NIOSH APPROVAL		\$ 6.90
10012513	LABEL,ELSA 10,NIOSH APPROVAL		\$ 6.15
10012515	MOUNTING BRACKET, MOTION SENS	EOL	\$ 18.30
10012516	SCREW,FILLISTER HD,3MMX10MM PT		\$ 2.20
10012533	PIEZO, W/CONNECTOR	EOL	\$ 29.60
10012535	LABEL,NFPA-2002,AIR-PAK NXG2	SVC	\$ 4.50
10012546	EBSS, QUARTER POST	DIS	\$ 16.20
10012566	CYL ALUM 5 MIN HF & 10 MIN 3.0		\$ 236.00
10012567	CYLINDER, ALUM 5 MIN 2216 PSI		\$ 195.00
10012574	CBRN BACK FRAME LABEL	SVC	\$ 3.25
10012582	HSG,DISPLAY,MASK MTD REGULATOR		\$ 9.50
10012602	VISOR, DISPLAY	SVC	\$ 8.00
10124-00	BAG-PROTECTIVE		\$ 3.30
1017260	BUCKLE PACK (5 PACK)		\$ 25.90
1017401	CAM LOCK CATCH BASE ASSY		\$ 27.40
1017795	CLIP, WHISTLE, ACS		\$ 49.60
1017797	U CLIP, LP FOR CN		\$ 10.25
1017801	U-CLIP,HIGH PRESS FOR CN		\$ 10.25
1018582	RETAINER FOR U CLIP CTR		\$ 48.50
1018590	HANDWHEEL, 4500 PSI, ACS		\$ 109.00
1018591	HANDWHEEL, 2216 PSI, ACS		\$ 109.00
1018923	PLUG, BLANK, LP, ACS		\$ 24.80
1021482	FRONT COVER SCREWS (5 PK)		\$ 8.90
1021904	WASHER, WHISTLE, ACS	DIS	\$ 11.90
1021905	NYLON WASHER,SPARES (5) PACK		\$ 53.00



**Revision A**

Current revision date: December 1, 2018



**All prices listed herein supercede all other price lists, including (but not limited to) Scott master PDF price list. All prices are subject to change.**

**3M | Scott Fire & Safety Master Price List**

<b>ITEM</b>	<b>Product Description</b>	<b>Signal Code</b>	<b>List Price</b>
1021935	WASHER, LOCK, ACS		\$ 10.00
1022061	FILTER, SINTERED, ACS REDUCER		\$ 35.50
1022064	SINTERED FILTER, SPARES (2) PK		\$ 69.00
1023213	BODY, WHISTLE, ACS		\$ 233.00
1023220	WHISTLE FLUTE & PLUG		\$ 42.00
1023238	NUT, WHISTLE FLUTE, ACS		\$ 42.30
1023391	COVER, GAUGE, ACS		\$ 61.00
1025881	O-RING LUBE, ACS		\$ 130.00
1027769	O-RING, ACS		\$ 10.00
1027818	BONDED SEAL 1/4 BSP	DIS	\$ 25.90
1027892	O-RING, ACS		\$ 18.30
1027893	CONNECTOR O-RING SPARES (5)PK		\$ 43.10
1027934	SEAL, WHISTLE, ACS	DIS	\$ 24.80
1027937	CRUSH SEAL, SPARES (5) PACK	DIS	\$ 55.00
1027985	O-RING, ACS	SVC	\$ 10.00
1028048	SEAL, ACS		\$ 56.00
1028286	O-RING, ACS	SVC	\$ 7.80
1028288	O-RING, REDUCER PISTON, ACS		\$ 23.75
1028289	O-RING, REDUCER, ACS		\$ 78.00
1028417	SPRING, PISTON, ACS		\$ 51.00
1028418	SPRING		\$ 30.25
1028856	VALVE DISC, SPARES (2) PACK		\$ 64.00
1029051	BYPASS KNOB		\$ 35.90
1029418	PISTON SEAT, ACS		\$ 10.80
1029421	PISTON SEAT, SPARES (5) PACK		\$ 30.25
1030071	TOP, REDUCER, ACS		\$ 101.00

**Revision A**

Current revision date: December 1, 2018



**All prices listed herein supercede all other price lists, including (but not limited to) Scott master PDF price list. All prices are subject to change.**

**3M | Scott Fire & Safety Master Price List**

<b>ITEM</b>	<b>Product Description</b>	<b>Signal Code</b>	<b>List Price</b>
1030085	PISTON ASSY, RED, ACS, SPARE		\$ 105.00
1032238	FRONT COVER & SCREWS, SPARES		\$ 20.50
1033779	C-100 TOOLKIT		\$ 640.00
1033987	TOOL, PISTON SEAT, ACS REDUCER		\$ 14.00
1033999	TOOL, CAP, ACS REDUCER		\$ 64.00
1034526	LOCTITE 542 HYDRAULIC SEALANT		\$ 91.00
1071671	VISION 3,LQF/ML		\$ 267.00
13160-01	CLAMP (WWD 152)		\$ 17.00
13161-00	CLAMP WWD176		\$ 8.50
13435-00	SOCKET & HOSE CLAMP ASSY		\$ 95.00
13436-00	PLUG&HOSE CLAMP ASSY		\$ 19.30
13870-00	VALVE,EXHALATION		\$ 7.50
13944-00	CAPLUG 5&8 SC		\$ 2.20
14492-01	PLUG ASSY		\$ 97.00
14575-00	FITTING HOSE		\$ 25.90
1500039	LABEL, NFPA 1981 2002 ED	DIS	\$ 3.90
1500061	SCREW,4-40 UNDERCUT FLAT HD	SVC	\$ 2.20
1500100	SCREW,FLAT SOCKET CAP 10-32 NF		\$ 2.50
1500117	PLUG, CHECK, FLUSH		\$ 9.30
1500123	CAP,DUST,DUAL DISCONNECT	SVC	\$ 30.60
15091-00	CLAMP		\$ 3.10
15423-00	HANSEN PLUG		\$ 7.75
15423-01	COUPLING		\$ 4.00
15424-00	SCHRADER PLUG		\$ 24.90
15424-01	ADAPTER		\$ 30.10
15435-00	PLUG & CLAMP		\$ 58.00

**Revision A**

Current revision date: December 1, 2018



**All prices listed herein supercede all other price lists, including (but not limited to) Scott master PDF price list. All prices are subject to change.**

**3M | Scott Fire & Safety Master Price List**

<b>ITEM</b>	<b>Product Description</b>	<b>Signal Code</b>	<b>List Price</b>
18002-00	PACKING,PREFORM .07W X .364 ID	EXP	\$ 3.25
18003-00	PACKING PREFORM .07W X .145 ID		\$ 2.20
18012-00	PACKING,PREFORM .07W X .489 ID	EXP	\$ 3.25
18013-00	PACKING,PREFORMED	EXP	\$ 3.25
18021-00	PACKING-PREFORM .07W X.426ID	EXP	\$ 3.25
18024-00	PACKING PREFORMED		\$ 3.25
18053-00	PACKING,PREFORM .07W X .301 ID	EXP	\$ 3.25
18057-00	2800C28A O RING	DIS	\$ 3.80
18062-00	PACKING,PREFORM .07W X .926 ID	EXP	\$ 3.25
18070-00	PACKING,PREFORM .07W X.114ID	EXP	\$ 5.40
18071-00	RETAINER,PACKING	EXP	\$ 3.50
18071-01	ORING,SNGL TRN(RED2.2/4.5)--	SVC	\$ 3.25
18071-02	ORING,SNGLTRN(PRED/HSE CPLG)	EXP	\$ 3.25
18071-05	RETAINER,PACK,ST,POLYTETRAFOU	SVC	\$ 2.20
18091-00	PACKING-PREFORM .301ID X.064DI	EXP	\$ 3.25
18099-00	PACKING-PREFORM .070W X.551ID	EXP	\$ 3.25
19003-00	PACKING,PREFORM .07W X .676ID	EXP	\$ 3.25
19457-00	SOCKET		\$ 54.00
19458-00	SOCKET		\$ 96.00
19486-00	PACKING-.125OD X.239 ID X.064	EXP	\$ 3.25
19889-00	SOCKET		\$ 99.00
19966-00	PACKING,PREFORM .07W X 1.114ID	EXP	\$ 3.25
200015-04	NXG2 DUAL,EBSS/EXDUR HOSEPOUCH		\$ 890.00
200015-05	DUAL,EBSS/EXDUR HOSE&POUCH 50		\$ 890.00
200015-09	DUAL COUPLING,EBSS ASSY, LH	SVC	\$ 900.00
200015-16	DUAL COUPLING,EBSS ASY,W,F,FFSR		\$ 850.00

**Revision A**

Current revision date: December 1, 2018



**All prices listed herein supercede all other price lists, including (but not limited to) Scott master PDF price list. All prices are subject to change.**

**3M | Scott Fire & Safety Master Price List**

<b>ITEM</b>	<b>Product Description</b>	<b>Signal Code</b>	<b>List Price</b>
200015-19	DUAL COUPLING,EBSS ASY,AP,FFSR		\$ 860.00
200016-01	HOSE W/HUD & PLUG DISC *KB*	SVC	\$ 403.00
200016-02	SWIVEL HOSE W/HUD *KB*	SVC	\$ 476.00
200016-03	SWIVEL HOSE W/HUD NXG2 *KB*	SVC	\$ 610.00
200017-01	HUD HOSE & SOCKET ASSY *KB*	SVC	\$ 510.00
200019-01	PCB ASSEMBLY, EEOSTI	SVC	\$ 92.00
200028-02	VALE ASSY, CHECK/VENT	SVC	\$ 560.00
200029-01	VALVE ASSY, RELIEF		\$ 105.00
200030-01	VALVE, TRANSFER, MOLDED		\$ 57.00
200031-03	REDUCER ASSY, SKA-PAK AT		\$ 760.00
200031-04	REDUCER ASSY, SKA-PAK AT		\$ 760.00
200035-01	HOUSING, EEOSTI, COATED		\$ 33.30
200036-01	ASSY,EEOSTI,WITH LINE 2.2 PSI		\$ 660.00
200036-02	ASSY,EEOSTI, WITH LINE 4.5 PSI		\$ 660.00
200036-03	ASSY,EEOSTI, WITH LINE 3.0 PSI		\$ 660.00
200036-04	ASSY,EEOSTI WITH LINE A/T 2.2		\$ 660.00
200036-05	ASSY,EEOSTI, WITH LINE A/T 3.0	DIS	\$ 660.00
200036-06	ASSY,EEOSTI, WITH LINE A/T 4.5		\$ 660.00
200036-08	GAUGE & LINE ASY,AT,MD,3.0		\$ 660.00
200043-01	BATTERY CONTACT ASSY, EEOSTI	DIS	\$ 12.00
200048-01	RIC UAC ASSEMBLY KIT		\$ 990.00
200048-03	RIC UAC ASSEMBLY KIT		\$ 990.00
200056-01	2002 UPGRADE KIT 2216 STD HOSE		\$ 1,850.00
200056-04	2002 UPGRADE KIT 2216 QD HOSE		\$ 2,040.00
200056-05	HUD CONTROL ASSY 3000 PSI		\$ 1,850.00
200056-08	2002 UPGRADE KIT 3000 QD HOSE		\$ 2,040.00

**Revision A**

Current revision date: December 1, 2018



**All prices listed herein supercede all other price lists, including (but not limited to) Scott master PDF price list. All prices are subject to change.**

**3M | Scott Fire & Safety Master Price List**

<b>ITEM</b>	<b>Product Description</b>	<b>Signal Code</b>	<b>List Price</b>
200056-09	2002 UPGRADE KIT 4500 STD HOSE		\$ 1,850.00
200056-12	2002 UPGRADE KIT 4500 QD HOSE		\$ 2,020.00
200058-01	MANIFOLD ASSEMBLY** SC ONLY	SVC	\$ 640.00
200058-02	MANIFOLD ASSEMBLY SC ONLY	SVC	\$ 610.00
200059-01	INLET/LATCH ASSEMBLY	DIS	\$ 660.00
200059-02	INLET/LATCH ASSEMBLY	SVC	\$ 660.00
200060-01	4.5 REDUCER ASSEMBLY		\$ 2,720.00
200070-01	TRC-1 CART W/HANSEN FITTINGS		\$ 6,660.00
200070-02	TRC-1 CART W/FOSTER FITTINGS		\$ 6,810.00
200070-03	TRC-1 CART W/HANSEN HK FTGS		\$ 7,180.00
200070-04	TRC-1 CART W/SCHRADER FITTINGS		\$ 6,690.00
200070-05	TRC-1 CART W/CEJN FITTINGS		\$ 7,030.00
200071-01	PCB ASSEMBLY, NXG2 SCT CONSOLE	EOL	\$ 560.00
200071-02	PCB ASSEMBLY, NXG2 SEMS CONSOL	EOL	\$ 478.00
200071-03	PCB ASSEMBLY, NXG2 GAUGE ONLY	EOL	\$ 560.00
200077-01	REG ASY,EZ FLO+,STD HOSE		\$ 1,290.00
200077-02	REG ASY,EZ FLO+,QD HOSE		\$ 1,290.00
200077-05	REG ASY,EZ FLO+,SWAT QD HOSE		\$ 1,280.00
200077-10	REG ASY,EZ FLO+,HUD QD HOSE		\$ 1,750.00
200077-11	REG ASY,EZ FLO+HUD LONG HOSE		\$ 1,680.00
200077-15	EZ FLO+ REG ASSY L/LOW PRE HSE		\$ 1,260.00
200077-18	REG ASY,EZ FLO+,SWAT HUD QD		\$ 1,690.00
200077-19	REG ASY.EZ FLO+,HUD NXG7 HOSE		\$ 1,620.00
200077-30	REG ASY,EZ FLO+		\$ 1,820.00
200077-31	REG ASY,EZ FLO+		\$ 1,810.00
200077-50	REG ASY, 2013, QD		\$ 1,800.00

**Revision A**

Current revision date: December 1, 2018



**All prices listed herein supercede all other price lists, including (but not limited to) Scott master PDF price list. All prices are subject to change.**

**3M | Scott Fire & Safety Master Price List**

<b>ITEM</b>	<b>Product Description</b>	<b>Signal Code</b>	<b>List Price</b>
200077-51	REG ASY, 2013, LH AP		\$ 1,790.00
200077-57	REG ASY, 2013, LH X3 SNAP		\$ 1,780.00
200077-58	REG ASY, 2013, LH X3 CGA		\$ 1,770.00
200077-59	REG ASY, 2013, LH NXG		\$ 1,780.00
200077-67	REG ASY, 2013, LH X3 PRO,SNAP		\$ 1,780.00
200077-68	REG ASY, 2013, LH X3 PRO,CGA		\$ 1,770.00
200083-01	DIAPHRAGM & VALVE ASSY,EZ FLO+	SVC	\$ 247.00
200092-01	PCB ASSMBLY,RELAY,EAGLE IMAGER		\$ 72.00
200095-01	WAIST PAD ASSEMBLY	SVC	\$ 463.00
200095-02	ASSY,PAD,WAIST	SVC	\$ 210.00
200097-01	SHOULDER STRAP ASSY	SVC	\$ 176.00
200097-02	ASSY,STRAP,SHOULDER	SVC	\$ 176.00
200098-01	SHOULDER PAD-STRAP ASSY	SVC	\$ 700.00
200098-02	ASSY,PAD-STRAP,SHOULDER	SVC	\$ 670.00
200100-01	UPGRADE KIT, 2216 SKA PAK AT		\$ 1,890.00
200100-02	UPGRADE KIT, 3000 SKA PAK AT		\$ 1,890.00
200100-03	UPGRADE KIT, 4500 SKA PAK AT		\$ 1,890.00
200111-01	CARRY CASE ASSY,THERMAL IMAGER		\$ 17.80
200112-01	CHECK ADAP ASY,EXT DUR,HANSEN		\$ 338.00
200112-02	CHECK ADAP ASY,EXT DUR,FOSTER		\$ 338.00
200112-03	CHECK ADAP ASY,EXT DUR,HAN HK		\$ 338.00
200112-04	CHECK ADAP ASY,EXT DUR,SCHRAD		\$ 338.00
200116-01	ASSEMBLY,CYLINDER RETENTION	SVC	\$ 157.00
200116-02	ASSEMBLY,CYLINDER RETENTION	SVC	\$ 157.00
200116-03	ASSEMBLY,CYL RET. SERVICE KIT	SVC	\$ 157.00
200116-04	ASSEMBLY,CYL RET. SERVICE KIT		\$ 189.00

**Revision A**

Current revision date: December 1, 2018



**All prices listed herein supercede all other price lists, including (but not limited to) Scott master PDF price list. All prices are subject to change.**

**3M | Scott Fire & Safety Master Price List**

<b>ITEM</b>	<b>Product Description</b>	<b>Signal Code</b>	<b>List Price</b>
200116-06	ASSEMBLY,CYLINDER RETENTION		\$ 145.00
200116-07	ASSEMBLY,AP75 CYL RETENTION		\$ 150.00
200117-01	ASSMBY, CYLINDER LATCH HANDLE	SVC	\$ 42.30
200123-01	BOTTLE SWITCH ASSEMBLY,NXG	DIS	\$ 27.00
200125-01	BACKFRAME SUB ASSY, NXG2		\$ 2,110.00
200127-02	NXG2 GAUGE ASSY,4500 PSI		\$ 1,920.00
200128-01	CYL&VALV ASSY CARB,30MIN,4500		\$ 1,304.00
200128-01-1	CYL&VALV ASSY CARB,30MIN,4500		\$ 1,304.00
200128-01-D	CYL&VALV ASSY CARB,30MIN,4500		\$ 1,304.00
200128-11	CYL&VALV ASSY CARB,30MIN,4500		\$ 1,409.00
200128-35	CYL&VALV ASSY,C,30YR,30M,4.5		\$ 1,576.00
200129-01	4.5-45MIN CARB CYL&VLV NXG		\$ 1,555.00
200129-01-1	CYL&VALV ASSY CARB,45MIN,4500		\$ 1,555.00
200129-01-1D	CYL&VALV ASSY CARB,45MIN,4500		\$ 1,555.00
200129-01A	CARBON & VALVE ASY,45MIN 4500		\$ 1,555.00
200129-01A-1	CYL&VALV ASSY CARB,45MIN,4500		\$ 1,555.00
200129-01A-D	CYL&VALV ASSY CARB,45MIN,4500		\$ 1,555.00
200129-01-D	CYL&VALV ASSY CARB,45MIN,4500		\$ 1,555.00
200129-11	CYL&VALV ASSY CARB,45MIN,4500		\$ 1,660.00
200129-35	CYL&VALV ASSY C,30YR,45MIN,4.5		\$ 1,952.00
200129-35-D	CYL&VALV ASSY C,30YR,45MIN,4.5		\$ 1,952.00
200130-01	4.5-60MIN CARB CYL&VLV NXG		\$ 1,732.00
200130-01-1	CYL&VALV ASSY CARB,60MIN,4500		\$ 1,732.00
200130-01-D	CYL&VALV ASSY CARB,60MIN,4500		\$ 1,732.00
200130-11	CYL&VALV ASSY CARB,60MIN,4500		\$ 1,837.00
200130-35	CYL&VALV ASSY C,30YR,60MIN,4.5		\$ 2,329.00

**Revision A**

Current revision date: December 1, 2018



**All prices listed herein supercede all other price lists, including (but not limited to) Scott master PDF price list. All prices are subject to change.**

**3M | Scott Fire & Safety Master Price List**

<b>ITEM</b>	<b>Product Description</b>	<b>Signal Code</b>	<b>List Price</b>
200131-01	CYL&VLV ASSY CARB,30MIN,2216		\$ 1,266.00
200131-01-1	CYL&VALV ASSY CARB,30MIN,2216		\$ 1,266.00
200131-01-D	CYL&VALV ASSY CARB,30MIN,2216		\$ 1,266.00
200132-01	HOSE ASSY W/SKT QD,NXG2 *KB*	SVC	\$ 530.00
200132-02	HOSE ASSY W/SKT QD,NXG2	SVC	\$ 530.00
200132-03	QD HOSE ASSY,NXG7, ANTI-ROTATI		\$ 540.00
200133-01	ADAPTER CABLE ASSY		\$ 78.00
200145-01	HOSE ASSY, MANIFOLD		\$ 93.00
200145-02	HOSE ASSY, MANIFOLD		\$ 181.00
200145-04	HOSE ASSY, MANIFOLD		\$ 77.00
200149-01	BATTERY HOLDER ASSEMBLY	SVC	\$ 257.00
200149-02	BATTERY HOLDER ASSEMBLY	EOL	\$ 256.00
200150-01	UNIVERSAL CHARING WAND ASSY		\$ 1,240.00
200150-03	UNIVERSAL CHARGING WAND		\$ 1,770.00
200154-04	REG ASSY,EZ FLO+QD NON-NFPA SW		\$ 1,620.00
200158-01	ASSY,BATTERY, EI,BAE-SERIES	DIS	\$ 167.00
200159-01	HAND STRAP ASSY,TI CAMERA	DIS	\$ 30.50
200162-01	HOSE ASY W/SOCK DISCON,HUD,SWA		\$ 406.00
200168-01	SUB-ASSEMBLY,HUD HOSE QD	SVC	\$ 426.00
200168-02	SUB-ASSEMBLY,HUD HOSE, LONG	SVC	\$ 497.00
200168-03	SUB-ASSEMBLY HUD HOSE NXG2	DIS	\$ 494.00
200170-02	DUAL COUP EBSS RETROFIT KIT		\$ 930.00
200170-03	DUAL COUP EBSS RETROFIT KIT		\$ 930.00
200170-04	DUAL COUP EBSS RETROFIT KIT		\$ 930.00
200170-12	DUAL COUP EBSS RETROFIT KIT		\$ 1,010.00
200170-21	DUAL COUP EBSS RETRO KIT, 2013		\$ 910.00



**Revision A**

Current revision date: December 1, 2018



**All prices listed herein supercede all other price lists, including (but not limited to) Scott master PDF price list. All prices are subject to change.**

**3M | Scott Fire & Safety Master Price List**

<b>ITEM</b>	<b>Product Description</b>	<b>Signal Code</b>	<b>List Price</b>
200170-24	DUAL COUP EBSS RETRO KIT, 2013		\$ 910.00
200170-26	DUAL COUP EBSS RETRO KIT, 2013		\$ 910.00
200170-29	DUAL COUP EBSS RETRO KIT, 2013		\$ 910.00
200170-34	DUAL COUP EBSS RETRO KIT, 2013		\$ 870.00
200170-36	DUAL COUP EBSS RETRO KIT, 2013		\$ 870.00
200170-39	DUAL COUP EBSS RETRO KIT, 2013		\$ 870.00
200173-01	CBRN '97 SCBA RETRO KIT - STD		\$ 1,310.00
200173-03	CBRN '97 SCBA RETROFIT KIT		\$ 1,690.00
200173-15	CBRN 2002 SCBA RETROFIT KIT		\$ 1,340.00
200174-01	SERVICE HOSE ASSY *SC ONLY	SAR	\$ 209.10
200176-01	FLOW RESTRICTOR ASSY		\$ 84.00
200177-01	HEAD HARN ASSY 6 ST, RUBBER	SVC	\$ 98.00
200184-01	PCB ASSEMBLY, EI TCS	DIS	\$ 66.00
200185-02	HANDLE POWER CABLE ASM		\$ 101.00
200187-01	HUD DRIVER MODULE ASSY,2216PSI	SVC	\$ 444.00
200187-02	HUD DRIVER MODULE ASSY,3000PSI		\$ 444.00
200187-03	HUD DRIVER MODULE ASSY,4500PSI	SVC	\$ 444.00
200188-01	HSG ASY, HUD DRIVER MODULE		\$ 116.00
200188-02	HSG ASY, HUD DRIVER MODULE		\$ 186.00
200188-03	HSG ASY, HUD DRIVER MODULE		\$ 186.00
200188-04	HSG ASY, HUD DRIVER MODULE	SVC	\$ 186.00
200189-01	BATTERY COVER ASSEMBLY	SVC	\$ 20.10
200190-01	TRANSDUCER AND HOUSING ASSY	SVC	\$ 387.00
200191-01	MANIFOLD ASSY, HUD	SVC	\$ 167.00
200194-05	KIT ASY HDWRE NAVSEA		\$ 303.00
200194-06	KIT,ASSY,HDWR, AP FIFTY-I		\$ 55.00

**Revision A**

Current revision date: December 1, 2018



**All prices listed herein supercede all other price lists, including (but not limited to) Scott master PDF price list. All prices are subject to change.**

**3M | Scott Fire & Safety Master Price List**

<b>ITEM</b>	<b>Product Description</b>	<b>Signal Code</b>	<b>List Price</b>
200197-01	KIT,DUAL COUP EBSS,POUCH	SVC	\$ 243.00
200197-02	KIT,DUAL COUP EBSS,POUCH	SVC	\$ 246.00
200204-10	REG ASY EZ FLO II+		\$ 1,800.00
200204-14	MMR W/PLATE,HUD & QD		\$ 1,840.00
200204-16	REG ASSY EZ FLO II+		\$ 1,750.00
200204-30	REG ASY EZ FLO II+		\$ 1,750.00
200204-31	REG ASY EZ FLO II+		\$ 1,750.00
200210-01	ASSEMBLY,HOSE,TEST *SC ONLY	SAR	\$ 32.70
200211-01	KIT,INH VLV XCEL	PHO	\$ 18.20
200220-01	HUD ASY,2216 PSI QD REG HOSE		\$ 1,570.00
200220-02	HUD ASY,2216 PSI STD REG HOSE		\$ 1,200.00
200220-03	HUD ASY,3000 PSI QD REG HOSE		\$ 1,570.00
200220-04	HUD ASY,3000 PSI STD REG HOSE		\$ 1,200.00
200220-05	HUD ASY,4500 PSI QD REG HOSE		\$ 1,570.00
200220-06	HUD ASY,4500 PSI STD REG HOSE		\$ 1,200.00
200220-22	HUD DRIV MOD 2216 W/MTG HDWRE		\$ 482.00
200220-30	HUD DRIV MOD 3000PSI W/MTG HDW		\$ 482.00
200220-45	HUD DRIV MOD 4500PSI W/MTG HDW	SVC	\$ 482.00
200225-01	KIT,HOSE,POSI-CHEK,NXG2/NXG7	SAR	\$ 245.90
200226-01	CAMERA PROGRAMMING ADAPTER	DIS	\$ 445.00
200237-01	POUCH, EBSS, FLAP, LH	SVC	\$ 165.00
200237-03	POUCH, EBSS, FLAP, LH, NO LOOP	DIS	\$ 158.00
200237-05	POUCH, EBSS, FLAP, LH, KOMBAT		\$ 206.00
200242-01	EAGLE X CORE ASSY PROG NO TEMP		\$ 7,370.00
200242-05	EAGLE X CORE ASSY PROG DIGIT C		\$ 7,370.00
200246-01	OVERLAY KIT, HUD DISPLAY		\$ 264.00

**Revision A**

Current revision date: December 1, 2018



**All prices listed herein supercede all other price lists, including (but not limited to) Scott master PDF price list. All prices are subject to change.**

**3M | Scott Fire & Safety Master Price List**

<b>ITEM</b>	<b>Product Description</b>	<b>Signal Code</b>	<b>List Price</b>
200249-02	TCS ASSY, EAGLE 'X'	EOL	\$ 491.00
200264-01	AV3000 EPIC BRACKET ASSEMBLY		\$ 60.00
200266-04	HHR ASSEMBLY,PAK-TRACKER		\$ 1,800.00
200270-01	GAUGE LINE ASSEMBLY	SVC	\$ 106.00
200270-02	GAUGE LINE ASSEMBLY	SVC	\$ 118.00
200270-03	GAUGE LINE ASSEMBLY	SVC	\$ 175.00
200270-11	GAUGE LINE W/ELBOW		\$ 175.00
200274-01	BACKFRAME ASSEMBLY	SVC	\$ 488.00
200275-01	BACK-PAK ASSEMBLY	SVC	\$ 1,440.00
200275-02	BACK-PAK ASSEMBLY		\$ 1,440.00
200280-01	CONSOLE ASSY,HUD VERSION 2007	SVC	\$ 1,820.00
200280-02	CONSOLE ASSY,HUD VERSION 2007		\$ 1,200.00
200280-11	CONSOLE ASSY, HUD 2013		\$ 1,140.00
200280-12	CONSOLE ASSY, HUD 2013		\$ 1,140.00
200280-14	CONSOLE ASSY, HUD 2013		\$ 1,140.00
200285-01	4.5 PRESSURE REDUCER		\$ 2,400.00
200286-01	CYL VLV SEAL KIT	SVC	\$ 54.00
200287-01	CASE, PAK-TRACKER		\$ 378.00
200296-01	BATTERY CAP ASSEMBLY	SVC	\$ 37.30
200297-01	ASSY, MANIFOLD	SVC	\$ 186.00
2003415	VISOR CLAMP/SCREW PACK		\$ 36.00
2003437	SPEECH DIAPH ASSY,O-RING		\$ 36.30
200354-01	GAUGE LINE ASSY, NXG2**	SVC	\$ 187.00
200354-02	GAUGE LINE ASSY, NXG2**	SVC	\$ 195.00
200354-04	GAUGE LINE ASSY, NXG2	EOL	\$ 453.00
200355-01	RECEPT ASSY W/CONNECTOR	EOL	\$ 37.00

**Revision A**

Current revision date: December 1, 2018



**All prices listed herein supercede all other price lists, including (but not limited to) Scott master PDF price list. All prices are subject to change.**

**3M | Scott Fire & Safety Master Price List**

ITEM	Product Description	Signal Code	List Price
200356-01	BATTERY CABLE ASSEMBLY		\$ 29.10
200370-01	BOOT, ASSEMBLY		\$ 37.00
200371-52F	LENS KIT, 52MM FRAMES ONLY		\$ 135.00
200371-60F	LENS KIT, 60MM FRAMES ONLY		\$ 135.00
200372-52F	LENS KIT, 52MM FRAMES ONLY		\$ 134.00
200372-60F	LENS KIT, 60MM FRAMES ONLY		\$ 134.00
200373-52F	LENS KIT, 52MM FRAMES ONLY		\$ 136.00
200373-60F	LENS KIT, 60MM FRAMES ONLY		\$ 136.00
200374-54F	LENS KIT, 54MM FRAMES ONLY		\$ 135.00
200379-01	POUCH, EBSS, FLAP, RH	SVC	\$ 122.00
200388-01	TOOL ADAPTER		\$ 660.00
200394-01	REDUCER ASY W/POPPET VALVE		\$ 274.00
200399-01	RSSI PCB ASSY, PAK-TRACKER		\$ 166.00
200401-02	BATTERY CONTACT BOARD,PAK-TRKR		\$ 32.60
200402-02	BATTERY ASSEMBLY, SSR	DIS	\$ 103.00
2004032	MAIN DIAPHRAGM		\$ 51.00
2004044	EXHALE VALVE ASSY		\$ 52.00
2004047	PRV ASSY, RED, ACS, SPARE		\$ 52.00
200411-01	LANYARD ASSY, PAK-TRACKER		\$ 32.30
200412-02	FLANGE ASSY PASS-THRU		\$ 272.00
200423-01	ADAPTER, CBRN 40MM		\$ 79.00
200423-02	ADAPTER, CBRN 40MM		\$ 68.00
200424-01	CONSOLE ASSY,PASS VERSION 2007	DIS	\$ 1,310.00
200424-02	CONSOLE ASSY,PASS VERSION 2007	DIS	\$ 1,310.00
200424-03	CONSOLE ASSY,PASS VERSION 2007		\$ 1,310.00
200424-04	CONSOLE ASSY,PASS VERSION 2007	SVC	\$ 1,310.00

**Revision A**

Current revision date: December 1, 2018



**All prices listed herein supercede all other price lists, including (but not limited to) Scott master PDF price list. All prices are subject to change.**

**3M | Scott Fire & Safety Master Price List**

<b>ITEM</b>	<b>Product Description</b>	<b>Signal Code</b>	<b>List Price</b>
200424-11	CONSOLE ASSY, PASS 2013		\$ 1,290.00
200424-12	CONSOLE ASSY, PASS 2013		\$ 1,290.00
200424-14	CONSOLE ASSY, PASS 2013		\$ 1,290.00
200433-01	TRK MT CHARGER,PAK-TRACKER		\$ 650.00
200433-02	TRK MT CHARGER,PAK-TRACKER		\$ 700.00
200434-01	DESK TOP CHRГ ASSY,PAK-TRACKER		\$ 580.00
200437-01	2.2 PRESSURE RED. ASSEMBLY		\$ 1,620.00
200438-01	4.5 PRESSURE RED. ASSEMBLY		\$ 1,620.00
200439-01	RELIEF VALVE ASSEMBLY	DIS	\$ 169.00
200440-01	COVER ASSY, PRESSURE REDUCER	SVC	\$ 365.00
200441-01	GAUGE LINE HOUSING ASSEMBLY	DIS	\$ 39.40
2004440	HEAD HARNESS		\$ 37.40
200449-01	ASSY,REG HOSE,HUD,QD	DIS	\$ 403.00
200449-02	ASSY,REG HOSE,HUD,LG,SWAT	DIS	\$ 476.00
200449-03	ASSY,REG HOSE,HUD,NXG NO QD	DIS	\$ 427.00
200450-01	ASSY HOSE,HUD SOCKET QD	DIS	\$ 510.00
200450-03	HOSE ASSY, HUD, QD, ANTI-ROTAT	DIS	\$ 540.00
200451-01	2007 SENSOR ASSY, AP75	DIS	\$ 2,230.00
200451-02	TOP ASSEMBLY, SENSOR, 2007		\$ 2,510.00
200451-03	TOP ASSEMBLY, SENSOR, 2013	DIS	\$ 2,550.00
200451-04	TOP ASSEMBLY, SENSOR, 2013	DIS	\$ 2,540.00
200451-11	TOP ASSEMBLY, SENSOR, 2007		\$ 1,470.00
200451-12	TOP ASSEMBLY, SENSOR, 2007	SVC	\$ 2,390.00
200451-13	TOP ASSEMBLY, SENSOR, 2013		\$ 1,600.00
200451-14	TOP ASSEMBLY, SENSOR, 2013		\$ 2,390.00
200451-23	TOP ASSY, SENSOR, 2013 UPGD		\$ 2,550.00

**Revision A**

Current revision date: December 1, 2018



**All prices listed herein supercede all other price lists, including (but not limited to) Scott master PDF price list. All prices are subject to change.**

**3M | Scott Fire & Safety Master Price List**

<b>ITEM</b>	<b>Product Description</b>	<b>Signal Code</b>	<b>List Price</b>
200451-24	TOP ASSY, SENSOR, 2013 UPGD		\$ 2,550.00
200451-33	TOP ASSY, SENSOR, 2013 UPGD		\$ 1,470.00
200451-34	TOP ASSY, SENSOR, 2013 UPGD		\$ 2,500.00
200453-01	HOUSING COVER ASSY, SENSOR	DIS	\$ 36.80
200455-02	BATTERY PCB ASSY, 2007 SENSOR	SVC	\$ 75.00
200465-01	BACKFRAME ASSEMBLY	DIS	\$ 212.00
200466-01	BACK-PAK ASSEMBLY		\$ 1,440.00
200466-02	BACK-PAK ASSEMBLY		\$ 1,440.00
200474-01	KIT, EBSS, AP50 & WIREFRAME		\$ 630.00
200657-01	VALVE ASSY,CYLINDER, JDF	DIS	\$ 443.00
200659-01	CYL&VLV ASSY (JAPAN)		\$ 2,029.00
200660-01	CYL&VLV ASSY (JAPAN)		\$ 1,621.00
200662-01	MOUNTING KIT, SENSOR MODULE	SVC	\$ 101.00
200662-02	MOUNTING KIT, SENSOR MODULE		\$ 130.00
200662-03	MOUNTING KIT, SENSOR MODULE		\$ 130.00
200662-04	MOUNTING KIT, SENSOR MODULE	SVC	\$ 130.00
200662-05	MOUNTING KIT, SENSOR MODULE	SVC	\$ 79.00
2006658	PRESSURE GAUGE & SEAL,2216 PSI		\$ 123.00
200673-01	ASSEMBLY,WIRELESS BOOT LOADER		\$ 1,250.00
200674-01	GAUGE ASSY, AIR-PAK,2216 PSIG	DIS	\$ 148.00
200674-02	GAUGE ASSY, AIR-PAK,4500 PSIG	DIS	\$ 148.00
200674-03	GAUGE ASSY, AIR-PAK,3000 PSIG	DIS	\$ 173.00
200674-04	GAUGE ASSY, NAVY,4500 PSIG	SVC	\$ 148.00
200674-08	GAUGE ASSY, AIR-PAK,5500 PSIG	DIS	\$ 146.00
200676-01	HOOD, FH22 (1 EA)		\$ 56.00
200676-03	HOOD, FH22 (3 EA)		\$ 160.00

**Revision A**

Current revision date: December 1, 2018



**All prices listed herein supercede all other price lists, including (but not limited to) Scott master PDF price list. All prices are subject to change.**

**3M | Scott Fire & Safety Master Price List**

<b>ITEM</b>	<b>Product Description</b>	<b>Signal Code</b>	<b>List Price</b>
200677-03	SHROUD, HOSE, PACK OF 3		\$ 39.00
200681-01	QUICK CHARGE BOOT ASSY(FEMALE)	SVC	\$ 46.25
200682-01	SE+ PAK-TRACKER UPGRADE KIT		\$ 900.00
200684-01	'02 RIC BOOT ASSEMBLY	DIS	\$ 58.00
200684-02	RIC BOOT ASSEMBLY	DIS	\$ 60.00
200686-01	HOUSING ASSY (HANSEN)		\$ 121.00
200687-01	HOUSING ASSY (SCHRADER)		\$ 163.00
200688-D430	CYLINDER CAP, 4500-30 DOME		\$ 33.60
200688-D445	CYLINDER CAP, 4500-45 DOME		\$ 33.60
200688-S430	CYLINDER CAP, 4500-30 VALVE		\$ 33.60
200688-S445	CYLINDER CAP, 4500-45 VALVE		\$ 33.60
200689-01	KIT, CYLINDER CAP INSTALL	DIS	\$ 60.00
200689-02	KIT, CYLINDER CAP INSTALL		\$ 281.00
200698-00	KIT, C420 PLUS PAPR, LESS HOSE		\$ 1,210.00
200698-30	KIT, C420 PLUS PAPR		\$ 1,290.00
200698-36	KIT, C420 PLUS PAPR		\$ 1,290.00
200699-01	BLOWER, C420 PLUS	SVC	\$ 1,140.00
200700-30	BREATHING TUBE, C240 PAPR, 30"		\$ 141.00
200700-36	BREATHING TUBE, C240 PAPR, 36"	DIS	\$ 141.00
200701-01	CONV KIT, C420 NIMH BATTERY		\$ 530.00
200703-01	BATTERY CHARGER, C420		\$ 268.00
200708-01	BRACKET WELDMENT, LEFT	DIS	\$ 10.50
200709-01	BRACKET WELDMENT, RIGHT		\$ 10.50
200710-30	KIT, C420+ PAPR W/ LISO2 BATT		\$ 1,400.00
200710-36	KIT, C420+ PAPR W/ LISO2 BATT		\$ 1,400.00
200711-01	TOP ASSEMBLY, PT PROGRAMMER		\$ 1,300.00

**Revision A**

Current revision date: December 1, 2018



**All prices listed herein supercede all other price lists, including (but not limited to) Scott master PDF price list. All prices are subject to change.**

**3M | Scott Fire & Safety Master Price List**

<b>ITEM</b>	<b>Product Description</b>	<b>Signal Code</b>	<b>List Price</b>
200715-01	EPIC BRACKET/AV3000,SERVICE KI	DIS	\$ 43.60
200716-01	EPIC BRACKET/AV2000,SERVICE KI		\$ 43.60
200718-02	ANTI-ROTN KIT, DUAL MANIFOLD	SVC	\$ 37.00
200718-03	ANTI-ROTN KIT, SINGLE, RETRO	DIS	\$ 24.30
200718-04	ANTI-ROTN KIT, DUAL, RETRO	DIS	\$ 24.30
200718-05	ANTI-ROTN KIT, SINGLE, 02 HUD		\$ 58.00
200718-06	ANTI-ROTN KIT, DUAL, 02 HUD		\$ 58.00
200720-01	ASSEMBLY,NXG MANIFOLD CAP		\$ 422.00
200721-01	ASSEMBLY,CLAMP,REGULATOR HOSE		\$ 44.40
200721-02	ASSEMBLY,CLAMP,REGULATOR HOSE		\$ 41.25
200721-03	ASSEMBLY,CLAMP,REGULATOR HOSE		\$ 52.00
200728-01	KIT,AP75 TO POSI-CHECK	SAR	\$ 129.60
200729-01	ASSY, SEMS II CONSOLE 4500 PSI	SVC	\$ 2,330.00
200729-02	ASSY, SEMS II (2216 PSI)		\$ 2,330.00
200729-03	ASSY, SEMS II CONSOLE 3000 PSI		\$ 2,330.00
200729-04	ASSY, SEMS II CONSOLE 5500 PSI		\$ 2,330.00
200729-11	ASSY, SEMS II CONSOLE 4500 PSI	DIS	\$ 2,280.00
200729-12	ASSY, SEMS II CONSOLE 2216 PSI		\$ 2,280.00
200729-14	ASSY, SEMS II CONSOLE 5500 PSI		\$ 2,280.00
200732-02	SEMS II MESH GATEWAY PCMCIA AS		\$ 2,310.00
200734-01	RFID PROGRAMMER ASSEMBLY		\$ 650.00
200741-01	KIT, HOLE TEMPALTES, NXG	SAR	\$ 50.00
200741-02	KIT, HOLE TEMPALTES, NXG		\$ 49.50
200742-01	KIT, HOLE TEMPLATES, AP50	SAR	\$ 47.00
200742-02	KIT, HOLE TEMPLATES, AP50	SAR	\$ 53.10
200753-01	EAGLE X SERVICE KIT		\$ 7,130.00



**Revision A**

Current revision date: December 1, 2018



**All prices listed herein supercede all other price lists, including (but not limited to) Scott master PDF price list. All prices are subject to change.**

**3M | Scott Fire & Safety Master Price List**

<b>ITEM</b>	<b>Product Description</b>	<b>Signal Code</b>	<b>List Price</b>
200753-02	EAGLE X SERVICE KIT		\$ 7,820.00
200756-01	GLARE SHIRLD ASSEMBLY		\$ 330.00
200765-01	ASSY, MAIN HOUSING, SEMS II		\$ 2,140.00
200766-01	AV-2000 CONVERSTION KIT	DIS	\$ 61.00
200770-01	PT LABELS, BAG OF 10	DIS	\$ 8.90
200773-01	RFID WRITER KIT		\$ 720.00
200774-01	RFID TAG KIT		\$ 132.00
200779-01	CYL&VLV ASSY, SKA-PAK AT		\$ 880.00
200779-02	CYL & VALVE ASSY, SKA-PAK AT		\$ 1,260.00
200779-03	CYL & VALVE ASSY, SKA-PAK		\$ 800.00
200779-102	CYL&VLV,SP+&AT,15M4.5 30YR SL	GCI	\$ 1,430.00
200793-10	CORE ASSEMBLY, EAGLE 320 DEG C		\$ 6,160.00
200794-01	BOOT, SWITCH,PUSHBUTTON,YELLOW		\$ 14.80
200794-02	BOOT, SWITCH,PUSHBUTTON,RED		\$ 14.80
200794-03	BOOT, SWITCH,PUSHBUTTON		\$ 14.80
200800-01	COVER, ASSY, REGULATOR	DIS	\$ 126.00
200800-02	COVER, ASSY, REGULATOR		\$ 125.00
200800-04	COVER, ASSY, REGULATOR		\$ 125.00
200800-05	COVER, ASSY, REGULATOR	DIS	\$ 126.00
200800-06	COVER, ASSY, REGULATOR	DIS	\$ 125.00
200802-01	FACE SEAL,SMALL,SURESEAL	DIS	\$ 202.00
200802-02	FACE SEAL,MED,SURESEAL	DIS	\$ 202.00
200802-03	FACE SEAL,LARGE,SURESEAL	SVC	\$ 202.00
200802-04	FACE SEAL,SM,4PT SURESEAL		\$ 182.00
200802-05	FACE SEAL,MD,4PT SURESEAL		\$ 182.00
200802-06	FACE SEAL,LG,4PT SURESEAL		\$ 182.00

**Revision A**

Current revision date: December 1, 2018



**All prices listed herein supercede all other price lists, including (but not limited to) Scott master PDF price list. All prices are subject to change.**

**3M | Scott Fire & Safety Master Price List**

<b>ITEM</b>	<b>Product Description</b>	<b>Signal Code</b>	<b>List Price</b>
200803-01	HEADNET ASM, SURESEAL	DIS	\$ 182.00
200812-01	NXG7 BACKFRAME ASSEMBLY	DIS	\$ 489.00
200815	USB FEATURE PROGRAMMING CABLE	EOL	\$ 39.25
200816-02	EI 320 SERVICE KIT, DEG F XMTR		\$ 9,800.00
200816-03	EI 320 SERVICE KIT, LESS CORE	SVC	\$ 1,852.40
200816-12	EI 320 SERVICE KIT, DEG C XMTR		\$ 9,800.00
200818-01	KIT,EZ FLO II COVER REPLACE	SVC	\$ 192.00
200818-02	KIT,EZ FLO II COVER REPLACE	SVC	\$ 198.00
200818-04	KIT,EZ FLO II COVER REPLACE	DIS	\$ 191.00
200818-05	KIT,EZ FLO II COVER REPLACE	SVC	\$ 198.00
200818-06	KIT,EZ FLO II COVER REPLACE	DIS	\$ 197.00
200820-075	SUPPLY HOSE ASSY,75 FT FOSTER	GCI	\$ 450.00
200822-01	NAVY SKA-PAK AT ASSEMBLY	GCI	\$ 6,060.00
200822-02	NAVY SKA-PAK AT ASSEMBLY	GCI	\$ 6,060.00
200822-03	NAVY SKA-PAK AT ASSEMBLY	GCI	\$ 6,210.00
200827-02	PROG CUST SERVICE KIT,2.2 PASS	SVC	\$ 670.00
200827-03	PROG CUST SERVICE KIT,3.0 PASS		\$ 670.00
200827-04	PROG CUST SERVICE KIT,4.5 PASS	DIS	\$ 670.00
200827-05	PROG CONS SERV KIT,5.5 PASS	SVC	\$ 680.00
200827-12	PROG CONS SERV KIT,PASS 2.2PSI		\$ 670.00
200827-14	PROG CONS SERV KIT,PASS 4.5PSI		\$ 670.00
200827-15	PROG CONS SERV KIT,PASS 5.5PSI		\$ 670.00
200828-02	PROG CUST SERVICE KIT, HUD		\$ 333.00
200828-04	PROG CUST SERVICE KIT, HUD		\$ 520.00
200828-05	PROG CUST SERV KIT,HUD 5.5 PSI		\$ 570.00
200828-12	PROG CUST SERV KIT,HUD 2.2 PSI		\$ 333.00

**Revision A**

Current revision date: December 1, 2018



**All prices listed herein supercede all other price lists, including (but not limited to) Scott master PDF price list. All prices are subject to change.**

**3M | Scott Fire & Safety Master Price List**

ITEM	Product Description	Signal Code	List Price
200828-14	PROG CUST SERV KIT,HUD 4.5 PSI		\$ 520.00
200828-15	PROG CUST SERV KIT,HUD 5.5 PSI		\$ 550.00
200829-30	AV-PAPR HOSE, 30"		\$ 189.00
200829-36	AV-PAPR HOSE, 36"		\$ 194.00
200830-30	KIT, C420 & AV-PAPR HOSE, 30"		\$ 1,210.00
200830-36	KIT, C420 & AV-PAPR HOSE, 36"		\$ 1,210.00
200833-30	KIT, C420 PLUS PAPR W/BATTERY		\$ 1,420.00
200833-36	KIT, C420 PLUS PAPR W/BATTERY		\$ 1,420.00
200836-01	EI GLARE SHIELD KIT		\$ 11,090.00
200836-02	EI GLARE SHIELD KIT (TRANSMITT		\$ 11,920.00
200840-01	STRAP ASM, TOP CENTER, SURESEA		\$ 23.50
200841-01	SEMS II 4500 PSI FIELD INSTALL		\$ 1,050.00
200841-02	SEMS II 2216 PSI FIELD INSTALL		\$ 1,110.00
200841-03	SEMS II 3000 PSI FIELD INSTALL		\$ 1,050.00
200842-01	HSG, RIGHT COMPLETE, 1 BUTTON	DIS	\$ 278.00
200843-01	HSG, LEFT COMPLETE, 1 BUTTON	DIS	\$ 264.00
200844-81	FIELD INSTALL KIT, SMALL SURES		\$ 219.00
200844-82	FIELD INSTALL KIT,MED SURESEAL		\$ 219.00
200844-83	FIELD INSTALL KIT,LARGE SURESE		\$ 224.00
200847-01	LCD ASSEMBLY, TAC TIC	DIS	\$ 454.00
200848-01	BATTERY, TAC TIC	DIS	\$ 239.00
200850-01	BULKHEAD PLATE ASSEMBLY		\$ 55.00
200858-101	WAIST PAD/BELT ASSY-S		\$ 890.00
200858-111	WAIST PAD/BELT ASSY-M		\$ 890.00
200858-121	WAIST PAD/BELT ASSY-L		\$ 890.00
200859-11	WAIST BELT ASSY-S		\$ 354.00

**Revision A**

Current revision date: December 1, 2018



**All prices listed herein supercede all other price lists, including (but not limited to) Scott master PDF price list. All prices are subject to change.**

**3M | Scott Fire & Safety Master Price List**

<b>ITEM</b>	<b>Product Description</b>	<b>Signal Code</b>	<b>List Price</b>
200859-12	WAIST BELT ASSY-M		\$ 354.00
200859-13	WAIST BELT ASSY-L		\$ 354.00
200859-21	WAIST BELT ASSY-S,AP,R		\$ 490.00
200859-22	WAIST BELT ASSY-M,AP,R		\$ 490.00
200859-23	WAIST BELT ASSY-L,AP,R		\$ 490.00
200859-31	WAIST BELT ASSY-S,AP,R,MU		\$ 840.00
200859-32	WAIST BELT ASSY-M,AP,R,MU		\$ 840.00
200859-33	WAIST BELT ASSY-L,AP,R,MU		\$ 840.00
200859-E	EXTENSION, WAIST BELT		\$ 97.00
200860-201	BAILOUT SYSTEM ASSY-50,F4,CR		\$ 1,170.00
200860-202	BAILOUT SYSTEM ASSY-75,F4,CR		\$ 1,380.00
200860-211	BAILOUT SYSTEM ASSY-50,F4,CA		\$ 1,170.00
200860-212	BAILOUT SYSTEM ASSY-75,F4,CA		\$ 1,380.00
200861-101	EZ-SI, O, 50, CR, FAL	SVC	\$ 1,400.00
200861-102	EZ-SI, O, 75, CR, FAL	DIS	\$ 1,450.00
200861-201	EZ-SI, WF, O, 50, CR, FAL		\$ 1,400.00
200861-202	EZ-SI, WF, O, 75, CR, FAL		\$ 1,450.00
200864-01	PROG ASSY,MAIN HSG,4.5 SEMS II	SVC	\$ 1,130.00
200864-02	PROG ASSY,MAIN HSG,2.2 SEMS II	SVC	\$ 1,130.00
200864-03	PROG ASSY,MAIN HSG,3.0 SEMS II		\$ 1,130.00
200864-04	PROG ASSY,MAIN HSG,5.5 SEMS II		\$ 1,130.00
200864-11	PROG ASSY,MAIN HSG,4.5 SEMS II		\$ 1,110.00
200866-01	ASSY,BACKFRAME HDWRE, NXG2	SVC	\$ 486.00
200867-01	LP QD REDUCER HOSE ASSY, ACS		\$ 181.00
200868-01	POSICHEK3 TEST HOSE ASSY, ACS	SAR	\$ 45.90
200870-01	CYL&VALVE ASSY, 30/4500,90 DEG		\$ 1,110.00

**Revision A**

Current revision date: December 1, 2018



**All prices listed herein supercede all other price lists, including (but not limited to) Scott master PDF price list. All prices are subject to change.**

**3M | Scott Fire & Safety Master Price List**

<b>ITEM</b>	<b>Product Description</b>	<b>Signal Code</b>	<b>List Price</b>
200870-01-D	CYL&VALV ASSY CARB,30MIN,4500		\$ 1,110.00
200871-01	CYL&VLV ASSY CARB,45MIN,4500		\$ 1,520.00
200871-01-D	CYL&VALV ASSY CARB,45MIN,4500		\$ 1,520.00
200872-01	CYL&VLV ASSY CARB,60MIN,4500		\$ 1,710.00
200872-01-D	CYL&VALV ASSY CARB,60MIN,4500		\$ 1,710.00
200873-01	CYL&VLV ASSY CARB,30MIN,2216		\$ 1,250.00
200873-01-D	CYL&VALV ASSY CARB,30MIN,2216		\$ 1,250.00
200874-01	CYL&VLV ASSY AL,30MIN,2216		\$ 720.00
200874-01-D	CYL&VALV ASSY AL,30MIN,2216		\$ 720.00
200877-01	BACK FRAME, ACSi		\$ 442.00
200879-01	HAN/FOSTER, ACS EXT DURATION		\$ 473.00
200879-02	SCHRADER, ACS EXT DURATION		\$ 473.00
200879-03	HAN HK PLUG, ACS EXT DURATION		\$ 473.00
200879-04	HAN HK SCKT, ACS EXT DURATION		\$ 473.00
200879-05	CEJN, ACS EXT DURATION		\$ 473.00
200882-01	HOSE ASSY, ACS EXT DURATION		\$ 272.00
200888-01	VALVE ASSY, CGA,90 DEG,4500PSI		\$ 500.00
200889-01	ASSEMBLY, 2216 PSI ACS VALVE		\$ 491.00
200895-01	POUCH, SHOULDER STRAP, EBSS	DIS	\$ 137.00
200895-02	POUCH, SHOULDER STRAP, EBSS, K		\$ 136.00
200898-01	SPARE, BOOT, AV-PAPR HOSE		\$ 59.00
200899-01	WAIST PAD ASSY,AP7 & NxG7,FI	DIS	\$ 640.00
200900-01	WAIST PAD ASSY,WIREFRAME,FI		\$ 630.00
200902-01	BAILOUT ROPE BAG ASSY,FI	DIS	\$ 475.00
200903-01	ROPE ASSEMBLY,TS,50,CR		\$ 402.00
200903-03	ROPE ASSEMBLY,TS,50,CA		\$ 410.00

**Revision A**

Current revision date: December 1, 2018



**All prices listed herein supercede all other price lists, including (but not limited to) Scott master PDF price list. All prices are subject to change.**

**3M | Scott Fire & Safety Master Price List**

ITEM	Product Description	Signal Code	List Price
200904-01	ROPE WEAVING FIXTURE ASY,50,FI		\$ 45.40
200904-02	ROPE WEAVING FIXTURE ASY,75,FI		\$ 45.40
200905-01	WAIST BELT ASSY, RIT	DIS	\$ 283.00
200906-01	WAIST PAD ASSY,AP75&NxG7,RIT	DIS	\$ 580.00
200909-01	WEBBING ASSY,50,CR,RIT		\$ 488.00
200910-01	VALVE, KUNKLE RELIEF KIT 4.5	DIS	\$ 170.00
200910-02	VALVE, KUNKLE RELIEF KIT 2.2	DIS	\$ 174.00
200910-03	KIT,VLV,KUNKLE RLF 4.5, UPGR07	DIS	\$ 200.00
200910-04	KIT,VLV,KUNKLE RLF 2.2, UPGR07	DIS	\$ 204.00
200915-01	FILTER COVER, XCEL HS 2 PC		\$ 9.25
200915-70	FILTER COVER, XCEL HS 70 PAIRS		\$ 590.00
2009164	ASSEMBLY, ELSA 5MIN ESC DEVICE		\$ 530.00
2009165	ASSEMBLY, ELSA 10MIN ESC DEVCE		\$ 650.00
200918-111	EZ-S II, S, 50, CR, F4 TS		\$ 1,750.00
200918-121	EZ-S II, M, 50, CR, F4 TS		\$ 1,750.00
200918-131	EZ-S II, L, 50, CR, F4 TS		\$ 1,750.00
200918-211	EZ-S II, WF, S, 50, CR, F4, TS		\$ 1,750.00
200918-221	EZ-S II, WF, M, 50, CR, F4, TS		\$ 1,750.00
200918-231	EZ-S II, WF, L, 50, CR, F4, TS		\$ 1,750.00
200920-01	HOSE,HIGH PRESSURE		\$ 278.00
200922-01	HOSE&COUPLING, HIGH PRESSURE	DIS	\$ 417.00
200922-02	HOSE&COUPLING, HIGH PRESSURE		\$ 417.00
200923-006	PACKING, PREFORMED	EXP	\$ 3.25
200923-009	PACKING, PREFORMED	SVC	\$ 3.25
200923-010	PACKING, PREFORMED	EXP	\$ 3.25
200923-011	PACKING, PREFORMED	EXP	\$ 3.25

**Revision A**

Current revision date: December 1, 2018



**All prices listed herein supercede all other price lists, including (but not limited to) Scott master PDF price list. All prices are subject to change.**

**3M | Scott Fire & Safety Master Price List**

<b>ITEM</b>	<b>Product Description</b>	<b>Signal Code</b>	<b>List Price</b>
200923-012	PACKING, PREFORMED	EXP	\$ 3.25
200923-013	PACKING, PREFORMED	EXP	\$ 3.25
200923-014	PACKING, PREFORMED	EXP	\$ 3.25
200923-015	PACKING, PREFORMED	DIS	\$ 3.25
200923-017	PACKING, PREFORMED	EXP	\$ 3.25
200923-021	PACKING, PREFORMED	DIS	\$ 3.25
200923-024	PACKING, PREFORMED	SVC	\$ 3.25
200923-028	PACKING, PREFORMED	DIS	\$ 4.60
200924-01	INLET ASSY (2.2)		\$ 580.00
200924-02	INLET ASSY (4.5)		\$ 580.00
200924-03	INLET ASSY (5.5)		\$ 580.00
200925-01	CGA PRESSURE REDUCER,AP75 2.2		\$ 1,640.00
200925-02	CGA PRESSURE REDUCER,AP75 4.5		\$ 1,640.00
200925-03	CGA PRESSURE REDUCER,AP75		\$ 1,710.00
200925-04	CGA PRES REDUCER,AP75(2.2,33%)		\$ 1,720.00
200925-05	CGA PRES REDUCER,AP75(4.5,33%)		\$ 1,710.00
200925-06	CGA PRES REDUCER,AP75(5.5,33%)		\$ 1,710.00
200926-01	NxG PRESSURE REDUCER		\$ 2,470.00
200926-02	NxG PRESSURE REDUCER	DIS	\$ 2,470.00
200926-03	NxG PRESSURE REDUCER		\$ 2,470.00
200927-01	INLET/LATCH ASSEMBLY		\$ 670.00
200927-02	INLET/LATCH ASSEMBLY		\$ 670.00
200927-03	INLET/LATCH ASSEMBLY		\$ 670.00
200928-02	GAUGE, DUAL POINTER, 5500 PSI	DIS	\$ 146.00
200930-01	CYL&VALV,CGA,CARB,30/5500 ASSY		\$ 1,451.00
200930-01-1	CYL&VALV,CGA,CARB,30/5500 ASSY		\$ 1,451.00

**Revision A**

Current revision date: December 1, 2018



**All prices listed herein supercede all other price lists, including (but not limited to) Scott master PDF price list. All prices are subject to change.**

**3M | Scott Fire & Safety Master Price List**

<b>ITEM</b>	<b>Product Description</b>	<b>Signal Code</b>	<b>List Price</b>
200930-01-1D	CYL&VALV,CGA,CARB,30/5500 ASSY		\$ 1,451.00
200930-01-D	CYL&VALV,CGA,CARB,30/5500 ASSY		\$ 1,451.00
200932	USB VIDEO DOWNLOAD CABLE		\$ 100.00
200951-01	M8 PIGTAIL REPL KIT - SVC ITEM		\$ 48.40
200951-02	M8 PIGTAIL REPL KIT-SVC ITEM		\$ 51.00
200951-03	M8 PIGTAIL REPL KIT-SVC ITEM		\$ 56.00
200951-04	M8 PIGTAIL REPL KIT-SVC ITEM		\$ 58.00
200952-01	KIT, CYLINDER SLEEVE		\$ 117.00
200952-02	KIT, CYLINDER SLEEVE 30M 4500		\$ 130.00
200952-03	KIT, CYLINDER SLEEVE 45M 4500		\$ 130.00
200952-04	KIT, CYLINDER SLEEVE 60M 4500		\$ 130.00
200952-05	KIT, FIELD, CYL SLEEVE 15M 450		\$ 112.00
200952-06	KIT, CYLINDER SLEEVE 30M 5500		\$ 136.00
200952-07	KIT, CYLINDER SLEEVE 45M 5500		\$ 136.00
200952-08	KIT, CYLINDER SLEEVE 60M 5500		\$ 136.00
200952-09	KIT, CYLINDER SLEEVE 75M 5500		\$ 136.00
200952-10	KIT, CYLINDER SLEEVE 30M 2216		\$ 136.00
200954-01	RIT-PAK III ASSY, 2216 PSI		\$ 3,700.00
200954-02	RIT-PAK III ASSY, 4500 PSI		\$ 3,700.00
200954-05	RIT-PAK III ASSY,5500 PSI		\$ 3,820.00
200955-01	BAG ASSEMBLY, RIT-PAK	DIS	\$ 890.00
200957-01	PNEUMATIC ASSY, RIT-PAK,2216		\$ 3,230.00
200957-02	PNEUMATIC ASSY, RIT-PAK,4500		\$ 3,230.00
200957-05	PNEUMATIC ASSY, RIT-PAK,5500		\$ 3,460.00
200958-01	HOSE & MANIFOLD ASSY - RIT-PAK	DIS	\$ 590.00
200959-01	AV3000 MASK ASSEMBLY, RIT-PAK		\$ 262.00



**Revision A**

Current revision date: December 1, 2018



**All prices listed herein supercede all other price lists, including (but not limited to) Scott master PDF price list. All prices are subject to change.**

**3M | Scott Fire & Safety Master Price List**

<b>ITEM</b>	<b>Product Description</b>	<b>Signal Code</b>	<b>List Price</b>
200960-01	CHARGING WAND ASSY, RIT-PAK		\$ 960.00
2009601	ELSA BAG, 15M, STD		\$ 111.00
200961-01	ASSY, RIT-PAK CONSOLE		\$ 1,390.00
200961-02	ASSY, RIT-PAK CONSOLE		\$ 1,390.00
200961-03	ASSY, RIT-PAK CONSOLE		\$ 1,390.00
200962-01	REGULATOR ASSEMBLY, RIT-PAK		\$ 800.00
200963-02	PROG CUST SERV KIT,CONS 2.2		\$ 600.00
200963-03	PROG CUST SERV KIT,CONS 4.5	DIS	\$ 600.00
200963-04	PROG CUST SERV KIT,CONS 5.5		\$ 600.00
200965-01	HEADNET ASSY,POLY, SURESEAL		\$ 83.00
200967-01	CYL&VALV,QD,CARB,30/5500 ASSY		\$ 1,451.00
200967-01-1	CYL&VALV,QD,CARB,30/5500 ASSY		\$ 1,451.00
200967-01-1D	CYL&VALV,QD,CARB,30/5500 ASSY		\$ 1,451.00
200967-01-D	CYL&VALV,QD,CARB,30/5500 ASSY		\$ 1,451.00
200969-01	CYL&VALV,CGA,CARB,45/5500 ASSY		\$ 1,722.00
200969-01-1	CYL&VALV,CGA,CARB,45/5500 ASSY		\$ 1,722.00
200969-01-1D	CYL&VALV,CGA,CARB,45/5500 ASSY		\$ 1,722.00
200969-01-D	CYL&VALV,CGA,CARB,45/5500 ASSY		\$ 1,722.00
200970-01	CYL&VALV,QD,CARB,45/5500 ASSY		\$ 1,722.00
200970-01-1	CYL&VALV,QD,CARB,45/5500 ASSY		\$ 1,722.00
200970-01-1D	CYL&VALV,QD,CARB,45/5500 ASSY		\$ 1,722.00
200970-01-D	CYL&VALV,QD,CARB,45/5500 ASSY		\$ 1,722.00
200972-01	CYL&VALV,CGA,CARB,60/5500 ASSY		\$ 1,911.00
200972-01-1	CYL&VALV,CGA,CARB,60/5500 ASSY		\$ 1,911.00
200972-01-1D	CYL&VALV,CGA,CARB,60/5500 ASSY		\$ 1,911.00
200972-01-D	CYL&VALV,CGA,CARB,60/5500 ASSY		\$ 1,911.00

**Revision A**

Current revision date: December 1, 2018



**All prices listed herein supercede all other price lists, including (but not limited to) Scott master PDF price list. All prices are subject to change.**

**3M | Scott Fire & Safety Master Price List**

<b>ITEM</b>	<b>Product Description</b>	<b>Signal Code</b>	<b>List Price</b>
200973-01	CYL&VALV,QD,CARB,60/5500 ASSY		\$ 1,911.00
200973-01-1	CYL&VALV,QD,CARB,60/5500 ASSY		\$ 1,911.00
200973-01-1D	CYL&VALV,QD,CARB,60/5500 ASSY		\$ 1,911.00
200973-01-D	CYL&VALV,QD,CARB,60/5500 ASSY		\$ 1,911.00
200975-01	CYL&VALV,CGA,CARB,75/5500 ASSY		\$ 2,108.00
200975-01-1	CYL&VALV,CGA,CARB,75/5500 ASSY		\$ 2,108.00
200975-01-1D	CYL&VALV,CGA,CARB,75/5500 ASSY		\$ 2,108.00
200975-01-D	CYL&VALV,CGA,CARB,75/5500 ASSY		\$ 2,108.00
200976-01	CYL&VALV,QD,CARB,75/5500 ASSY		\$ 2,108.00
200976-01-1	CYL&VALV,QD,CARB,75/5500 ASSY		\$ 2,108.00
200976-01-1D	CYL&VALV,QD,CARB,75/5500 ASSY		\$ 2,108.00
200976-01-D	CYL&VALV,QD,CARB,75/5500 ASSY		\$ 2,108.00
200977-01	BATTERY CHARGER,EAGLE ATTACK		\$ 960.00
200978-01	DVR POWER BOARD	EOL	\$ 470.00
200979-01	DVR PROCESSOR BOARD	EOL	\$ 730.00
200984-03	TRANSFER VALVE ASSEMBLY	DIS	\$ 35.75
200989-01	SHOULDER STRAP ASSY, RIT-PAK		\$ 143.00
200991-01	CARRYING STRAP KIT,RIT-PAK III		\$ 143.00
201001-01	CHARGER INTERFACE ASSY.	DIS	\$ 90.00
201002-01	POWER SWITCH ASSEMBLY	DIS	\$ 95.00
201003-01	EAB ASSEMBLY		\$ 1,380.00
201003-01	EAB ASSEMBLY		\$ 1,380.00
201004-01	REGULATOR & MANIFOLD ASSY, EAB		\$ 540.00
201004-01	REGULATOR & MANIFOLD ASSY, EAB		\$ 540.00
201008-01	BATTERY RETAINER STRAP	DIS	\$ 39.00
201009-01	L3 3600 CORE ASSY,NON-COLOR,F	SVC	\$ 5,260.00

**Revision A**

Current revision date: December 1, 2018



**All prices listed herein supercede all other price lists, including (but not limited to) Scott master PDF price list. All prices are subject to change.**

**3M | Scott Fire & Safety Master Price List**

<b>ITEM</b>	<b>Product Description</b>	<b>Signal Code</b>	<b>List Price</b>
201009-02	L3 3600 CORE ASSY,COLOR,F	SVC	\$ 5,850.00
201009-10	L3 3600 CORE ASSY,NON-COLOR,C		\$ 5,260.00
201009-12	L3 3600 CORE ASSY,COLOR,C		\$ 5,850.00
2010173	ANTI-FOG WIPE, 1 PACK		\$ 10.30
201018-01	LABEL,E-Z FLO REG,W/VIBRALERT	DIS	\$ 3.25
201018-02	LABEL, E-Z FLO REG, MODULAIR		\$ 3.25
201018-03	LABEL,E-Z FLO+ REG,W/VIBRALERT		\$ 5.40
201018-04	LABEL, E-Z FLO REGULATOR		\$ 3.25
201018-05	LABEL, E-Z FLO REGULATOR, SWAT		\$ 6.10
201018-06	LABEL,E-Z FLO+ REG,W/VIB, SWAT		\$ 3.25
201021-01	RERTRACTABLE LANYARD	DIS	\$ 54.00
201023-01	LABEL, COVER, REGULATOR, CBRN		\$ 3.25
201023-02	LABEL, COVER, REGULATOR, SCOTT		\$ 3.25
201023-03	LABEL, COVER, REG, W/WARNING	DIS	\$ 3.80
201026-01	SPARE BATTERY, TACTICAL TIC		\$ 245.00
201026-02	SPARE BATTERY, TACTICAL TIC		\$ 237.00
201026-03	SPARE BATTERY, TACTICAL TIC	DIS	\$ 255.00
201026-04	SPARE BATTERY, TACTICAL TIC		\$ 247.00
201027-01	MANIFOLD ASSY,LOW PRESSURE		\$ 620.00
201028-01	HOUSING, SUB ASSEMBLY	DIS	\$ 324.00
201029-01	KIT, X3 TO POSI-CHEK	SAR	\$ 216.30
201030-01	PRESSURE REDUCER,X3 (2.2,CGA)		\$ 2,280.00
201030-02	PRESSURE REDUCER,X3 (4.5,CGA)		\$ 2,280.00
201030-03	PRESSURE REDUCER,X3 (5.5,CGA)		\$ 2,280.00
201030-04	PRESSURE REDUCER,X3 (2.2,QD)		\$ 2,300.00
201030-05	PRESSURE REDUCER,X3 (4.5,QD)		\$ 2,300.00

**Revision A**

Current revision date: December 1, 2018



**All prices listed herein supercede all other price lists, including (but not limited to) Scott master PDF price list. All prices are subject to change.**

**3M | Scott Fire & Safety Master Price List**

<b>ITEM</b>	<b>Product Description</b>	<b>Signal Code</b>	<b>List Price</b>
201030-06	PRESSURE REDUCER,X3 (5.5,QD)		\$ 2,300.00
201040-01	EAGLE ATTACK PRESSURE TEST ASY		\$ 146.00
201043-01	BRACKET ASSY, QD		\$ 33.60
201044-01	BRACKET ASSY, CGA		\$ 57.00
201050-03	REDUCER ASSY, 5.5 ISCBA		\$ 1,650.00
201051-01	REPEATER ASSY		\$ 2,030.00
201056-01	GAUGE BLOCK/FILTER ASSY		\$ 64.00
201079-01	ASSY, BATTERY DOOR, EPIC 3		\$ 46.00
201081-01	ASSY,THUMB LATCH, EPIC 3	DIS	\$ 31.50
201083-01	CYLINDER RETENTION, OVERMOLDED	SVC	\$ 13.00
201084-01	ADAPTER ASSY, MALE	SAR	\$ 98.00
201085-01	ADAPTER ASSY, FEMALE	SAR	\$ 114.30
2010880	SPARE HOOD FOR SCOTT ELSA		\$ 121.00
201088-03	SEMS II, USB GATEWAY		\$ 2,170.00
2010881	SPARE REDUCER FOR ELSA 5, 15		\$ 412.00
2010882	SPARE REDUCER FOR ELSA 10		\$ 412.00
2010884	SPARE BAG FOR SCOTT ELSA 5	DIS	\$ 93.00
2010885	SPARE BAG FOR SCOTT ELSA 10		\$ 93.00
201089-01	BACK FRAME WELDMENT ASSY,X3		\$ 438.00
201090-02	SEMS FASTENER,#10-32 x 1/2"		\$ 3.00
201090-03	SEMS FASTENER,#10-32 x 1"		\$ 3.00
201090-04	SEMS FASTENER#10-32x1/2,PATCH		\$ 2.30
201090-06	SEMS FASTENER#10-32x7/8,PATCH		\$ 2.30
201095-01	EBSS POUCH, AIR-PAK X3	DIS	\$ 189.00
201096-01	SELF RESCUE WAIST BELT ASSY		\$ 850.00
201096-11	SELF RESCUE WAIST BELT ASSY,CH		\$ 1,500.00

**Revision A**

Current revision date: December 1, 2018



**All prices listed herein supercede all other price lists, including (but not limited to) Scott master PDF price list. All prices are subject to change.**

**3M | Scott Fire & Safety Master Price List**

<b>ITEM</b>	<b>Product Description</b>	<b>Signal Code</b>	<b>List Price</b>
201096-12	SELF RESCUE WAIST BELT ASSY,LT		\$ 1,550.00
201096-21	SR WAIST BELT ASSY, NON-J		\$ 850.00
201096-31	SR WAIST BELT ASSY,CH,NON-J		\$ 1,500.00
201096-32	SR WAIST BELT ASSY,LT,NON-J		\$ 1,550.00
201099-01	JETTISON CLIP ASSY		\$ 33.80
201100-01	AIR-PAK X3 BACK-PAK ASSY,PARA		\$ 1,380.00
201100-02	AIR-PAK X3 BACK-PAK ASY,SPRING		\$ 1,380.00
201100-11	AIR-PAK X3 BK-PK ASY,FFSR,PARA		\$ 950.00
201100-12	AIR-PAK X3 BK-PK ASY,FFSR,SPRG		\$ 950.00
201101-01	EBSS POUCH & HOSE ASSY, X3		\$ 920.00
201103-11	SELF RESCUE BAILOUT ASY,LT,SVC		\$ 1,110.00
201103-12	SELF RESCUE BAILOUT ASY,CH,SVC		\$ 1,110.00
201103-21	SELF RESCUE BAILOUT ASSY,POUCH		\$ 423.00
201104-01	T-SAFE ROPE ASSY, LIGHTNING		\$ 392.00
201104-02	T-SAFE ROPE ASSY, CROSBY		\$ 374.00
201109-01	MANIFOLD,PLUGGED		\$ 496.00
201110-01	X3,CONSOLE ASSY,PASS,4500,1/4		\$ 1,240.00
201110-02	X3,CONSOLE ASSY,PASS,2216,1/4		\$ 1,240.00
201110-03	X3,CONSOLE ASSY,PASS,5500,1/4		\$ 1,240.00
201110-11	X3,CONSOLE ASSY,PASS,4500,1/3		\$ 1,220.00
201110-12	X3,CONSOLE ASSY,PASS,2216,1/3		\$ 1,220.00
201110-13	X3,CONSOLE ASSY,PASS,5500,1/3		\$ 1,220.00
201112-02	X3,CONSOLE GAUGE,2216,1/4		\$ 198.00
201112-03	X3,CONSOLE GAUGE,5500,1/4		\$ 198.00
201112-11	X3,CONSOLE GAUGE,4500,1/3		\$ 198.00
201112-12	X3,CONSOLE GAUGE,2216,1/3	DIS	\$ 198.00

**Revision A**

Current revision date: December 1, 2018



**All prices listed herein supercede all other price lists, including (but not limited to) Scott master PDF price list. All prices are subject to change.**

**3M | Scott Fire & Safety Master Price List**

<b>ITEM</b>	<b>Product Description</b>	<b>Signal Code</b>	<b>List Price</b>
201112-13	X3,CONSOLE GAUGE,5500,1/3	SVC	\$ 198.00
201119-01	X3, GUAGE LINE ASSY		\$ 214.00
201122-11	X3,CONSOLE ASSY,SEMS,4500,1/3		\$ 1,770.00
201122-12	X3,CONSOLE ASSY,SEMS,2216,1/3		\$ 1,770.00
201122-13	X3,CONSOLE ASSY,SEMS,5500,1/3		\$ 1,770.00
201122-31	X3,CONSOLE ASSY,BT,4500PSI		\$ 1,950.00
201122-32	X3,CONSOLE ASSY,BT,2216 PSI		\$ 1,950.00
201122-33	X3,CONSOLE ASSY,BT,5500 PSI		\$ 1,950.00
201122-71	X3, CNSL ASSY 4500, NO MOTION		\$ 1,920.00
201122-73	X3, CNSL ASSY 5500, NO MOTION		\$ 1,950.00
201125-03	LABEL, REG, CBRN		\$ 3.25
201126-02	NOSECUP,AV3,S ASY, RED VALVES		\$ 54.00
201127-02	NOSECUP,AV3,M ASY, RED VALVES	DIS	\$ 54.00
201128-02	NOSECUP,AV3,L ASY,RED VALVES		\$ 54.00
201134-01	FEN,,DRILLED,COATED,AV3 HT	DIS	\$ 153.00
201136-01	HOSE ASSY,QD,HUD,X3,CGA		\$ 540.00
201136-02	HOSE ASSY,QD,HUD,X3,SNAP FIT		\$ 540.00
201136-03	HOSE ASSY,QD,HUD,6-WIRE, CGA		\$ 550.00
201136-04	HOSE ASY,QD,HUD,6-WIRE,SNAPFIT		\$ 550.00
201137-01	WAIST PAD ASSY,X3, PARA		\$ 445.00
201137-02	WAIST PAD ASSY,X3, SPRING		\$ 446.00
201138-01	HOSE ASSY,HUD,X3,CGA		\$ 560.00
201138-02	HOSE ASSY,HUD,X3,SNAP FIT		\$ 560.00
201138-03	HOSE ASSY,HUD,6-WIRE,CGA		\$ 560.00
201138-04	HOSE ASSY,HUD,6-WIRE,SNAPFIT		\$ 560.00
201139-01	SHOULDER STRAP ASSY,X3 PARA	DIS	\$ 670.00

**Revision A**

Current revision date: December 1, 2018



**All prices listed herein supercede all other price lists, including (but not limited to) Scott master PDF price list. All prices are subject to change.**

**3M | Scott Fire & Safety Master Price List**

<b>ITEM</b>	<b>Product Description</b>	<b>Signal Code</b>	<b>List Price</b>
201139-02	SHOULDER STRAP ASSY,X3,SPRING		\$ 670.00
201140-01	2216 PSI GAUGE		\$ 148.00
201140-02	4500 PSI GAUGE	DIS	\$ 148.00
201140-03	5500 PSI GAUGE		\$ 148.00
201146-01	ACCESSORY HOSE, POSI-CHEK 3,QD	SAR	\$ 30.60
201146-02	ACCESSORY HOSE, POSI-CHEK 3,QD		\$ 50.00
201148-01	X3,POWER CABLE SSY, HUD		\$ 398.00
201149-01	CABLE ASSY, TRANSDUCER		\$ 143.00
201160-01	ASSY, SEN MOD, X3	DIS	\$ 2,140.00
201160-02	ASSY, SEN MOD W/PAKTRKR, X3	DIS	\$ 2,090.00
201160-21	ASSY,SEN MOD. X3, UPGRADE		\$ 2,140.00
201160-22	ASSY,SENMOD,PAKTKR,X3,UPGRADE		\$ 2,090.00
201160-24	ASSY,SENMOD,PAKTKR,X3 PRO,UPGR		\$ 1,840.00
201160-72	ASY,SM,NOSENS,W/PAKTRKR,X3		\$ 2,090.00
201160-76	ASY,SM,NOSENS,W/TRKR,X3PRO,UPG		\$ 1,840.00
201161-01	ASSY,SENSOR MODULE HOUSING, X3		\$ 1,100.00
201163-01	ASSY,BATT CAP,SEN MODULE,X3		\$ 26.30
201177-01	LABEL, PIEZO, PAK-TRACKER		\$ 2.10
201177-02	LABEL, PIEZO, NON-PT		\$ 2.10
201180-01	ASSY, CYLINDER RETENTION	DIS	\$ 150.00
201181-01	ASSY,HANDLE,CYLINDER RETENTION	DIS	\$ 39.90
201182-01	ASSY,STRAP,CYLINDER RETENTION		\$ 70.00
201195-01	C50F BACK-PAK ASSEMBLY		\$ 2,560.00
201200-01	ASSY, CYLINDER RETENTION(SWAT)		\$ 181.00
201205-01	MAIN,LCD PDB ASSY PAK-TRACKER		\$ 277.00
201208-01	UK TEMPEST TO US AIRPAK		\$ 345.00

**Revision A**

Current revision date: December 1, 2018



**All prices listed herein supercede all other price lists, including (but not limited to) Scott master PDF price list. All prices are subject to change.**

**3M | Scott Fire & Safety Master Price List**

<b>ITEM</b>	<b>Product Description</b>	<b>Signal Code</b>	<b>List Price</b>
201210-01	ASSY,COM BRKT,AV3 HT,SER KIT,R		\$ 32.00
201210-02	ASSY,COM BRKT,AV3 HT,SER KIT,L		\$ 51.00
201214-01	QUEUE INTERFACE KIT		\$ 2,730.00
201215-01	AV-3000 HT (S), KVLR		\$ 385.00
201215-02	AV-3000 HT (M), KVLR		\$ 385.00
201215-03	AV-3000 HT (L), KVLR		\$ 385.00
201215-04	AV-3000 HT (S), KVLR w/ R BRKT		\$ 412.00
201215-05	AV-3000 HT (M), KVLR w/ R BRKT		\$ 412.00
201215-06	AV-3000 HT (L), KVLR w/ R BRKT		\$ 412.00
201215-07	AV-3000 HT (S), KVLR w/ L BRKT		\$ 434.00
201215-08	AV-3000 HT (M), KVLR w/ L BRKT		\$ 434.00
201215-09	AV-3000 HT (L), KVLR w/ L BRKT		\$ 434.00
201215-21	Assy,AV3 HT W/4PT KEV,RED,S		\$ 385.00
201215-22	Assy,AV3 HT W/4PT KEV,RED,M		\$ 385.00
201215-23	Assy,AV3 HT W/4PT KEV,RED,L		\$ 385.00
201215-27	Assy,AV3 HT W/4PT KEV,RED,RT,S		\$ 412.00
201215-28	Assy,AV3 HT W/4PT KEV,RED,RT,M		\$ 412.00
201215-29	Assy,AV3 HT W/4PT KEV,RED,RT,L		\$ 412.00
201215-34	Assy,AV3 HT W/4PT KEV,RED,LT,S		\$ 434.00
201215-35	Assy,AV3 HT W/4PT KEV,RED,LT,M		\$ 434.00
201215-36	Assy,AV3 HT W/4PT KEV,RED,LT,L		\$ 434.00
201222-01	POWER CABLE ASSY, 12V		\$ 40.00
201224-02	SNGL,MOTO XTS SER,EPIC3 LSM	HLD	\$ 695.00
201224-04	SNGL, MOTO HT750, EPIC3 LSM	HLD	\$ 695.00
201224-06	SNGL,MOTO APX SER,EPIC3 LSM	HLD	\$ 695.00
201224-07	SNGL, KEN NX 210,EPIC3 LSM	HLD	\$ 695.00



**Revision A**

Current revision date: December 1, 2018



**All prices listed herein supercede all other price lists, including (but not limited to) Scott master PDF price list. All prices are subject to change.**

**3M | Scott Fire & Safety Master Price List**

<b>ITEM</b>	<b>Product Description</b>	<b>Signal Code</b>	<b>List Price</b>
201224-22	SNGL, HAR P7300, EPIC3 LSM	HLD	\$ 695.00
201226-01	ACCESSORY, RING PTT, EPIC 3		\$ 273.00
201227-01	ACCESSORY, PADDLE PTT, EPIC 3		\$ 273.00
201228-01	ACCESSORY, THROAT MIC, EPIC 3		\$ 395.00
201229-01	ACCESSORY, COMMAND COM, EPIC 3		\$ 475.00
201243-01	PROGRAMMER, EPIC 3		\$ 195.00
201275-01	PACKAGING, EPIC 3 AMP, SINGLE	DIS	\$ 645.00
201275-02	PKGD,EPIC 3 AMP,CLOSED BRACKET		\$ 645.00
201275-03	PKGD,EPIC 3 AMP,EMEA BRACKET		\$ 645.00
201276-01	PACKAGING, EPIC 3 RI, SINGLE		\$ 695.00
201276-02	PACKAGING,EPIC 3 RI/T-A,SINGLE		\$ 695.00
201276-03	PKGD,EPIC 3 RI, VSN BRACKET		\$ 695.00
201276-04	PKGD,EPIC 3 RI,PRO BRACKET		\$ 695.00
201276-11	PKGD,EPIC 3 RDI MOTO,OPEN BRKT		\$ 795.00
201276-12	PKGD,EPIC 3 RDI MOTO,CLSD BRKT		\$ 795.00
201276-13	PKGD,EPIC 3 RDI MOTO, VSN BRKT		\$ 795.00
201276-14	PKGD,EPIC 3 RDI MOTO, PRO BRKT		\$ 795.00
201277-02	SNGL,MOTO XTS SER,EPIC3 RI LSM		\$ 850.00
201277-04	SNGL, MOTO HT750, EPIC3 RI LSM		\$ 850.00
201277-06	SNGL,MOTO APX SER,EPIC3 RI LSM		\$ 850.00
201277-07	SNGL, KEN NX210, EPIC3 RI LSM		\$ 850.00
201277-11	SNGL,MOTO GP 300,EPIC 3 RI LSM		\$ 850.00
201277-22	SNLG, HAR P7300, EPIC 3 RI LSM		\$ 850.00
201279-01	SEMS II,TALLY TAG,10 PACK,RED		\$ 111.00
201279-02	SEMS II,TALLY TAG,10 PACK,WHT		\$ 111.00
201279-03	SEMS II,TALLY TAG,10 PACK,BLK		\$ 111.00

**Revision A**

Current revision date: December 1, 2018



**All prices listed herein supercede all other price lists, including (but not limited to) Scott master PDF price list. All prices are subject to change.**

**3M | Scott Fire & Safety Master Price List**

<b>ITEM</b>	<b>Product Description</b>	<b>Signal Code</b>	<b>List Price</b>
201279-04	SEMS II,TALLY TAG,10 PACK,YEL		\$ 111.00
201279-05	SEMS II,TALLY TAG,10 PACK,ORG		\$ 111.00
201279-06	SEMS II,TALLY TAG,10 PACK,GRN		\$ 111.00
201279-07	SEMS II,TALLY TAG,10 PACK,BLU		\$ 111.00
201279-08	SEMS II,TALLY TAG,10 PACK,PNK		\$ 111.00
201280-01	SEMS II, BUTTON TAG, 10 PACK		\$ 111.00
201283-09	EBSS ASSY, 2013, AP		\$ 940.00
201284-01	BRACKET,PIVOT ASSY		\$ 23.80
201286-01	AMP TO AMP RI TRADEUP		\$ 545.00
201286-02	AMP TO AMP RI TRADEUP		\$ 545.00
201286-11	EPIC3 RDI MOTO OPEN BKT TRADIN		\$ 595.00
201286-12	EPIC3 RDI MOTO CLSD BKT TRADIN		\$ 595.00
201287-01	AMP RI TO AMP RDI SRV UPGRADE	SER	\$ 100.00
201287-02	AMP RI TO AMP RDI SRV UPGRADE		\$ 100.00
201287-03	AMP RI TO AMP RDI SRV UPGRADE		\$ 100.00
201311-01	SERV KIT, HT VM DUCT ASSY, RT		\$ 31.30
201311-02	SERV KIT, HT VM DUCT ASSY, LT		\$ 31.30
201325-01	KIT, NXG2 ELEC CABLE	DIS	\$ 257.00
201334-01	SCOTT POSI3 USB UPGRADE ASSEMB	SAR	\$ 2,608.20
201336-01	KIT, SCOTT POSI3 USB 5500 ASSY	SAR	\$ 10,085.80
201339-01	FRR MASK ASSEMBLY, SIZE 1	EUI	\$ 387.00
201339-02	FRR MASK ASSEMBLY, SIZE 2	EUI	\$ 387.00
201339-03	FRR MASK ASSEMBLY, SIZE 3	EUI	\$ 387.00
201339-04	FRR MASK ASSEMBLY, SIZE 4	EUI	\$ 387.00
201343-01	SPARE, FRR MASK FORMER SIZE 1	EUI	\$ 26.25
201343-02	SPARE, FRR MASK FORMER SIZE 2	EUI	\$ 26.25

**Revision A**

Current revision date: December 1, 2018



**All prices listed herein supercede all other price lists, including (but not limited to) Scott master PDF price list. All prices are subject to change.**

**3M | Scott Fire & Safety Master Price List**

<b>ITEM</b>	<b>Product Description</b>	<b>Signal Code</b>	<b>List Price</b>
201343-03	SPARE, FRR MASK FORMER SIZE 3	EUI	\$ 26.25
201343-04	SPARE, FRR MASK FORMER SIZE 4	EUI	\$ 26.25
201344-01	SPARE, NOSECUP SIZE 1	EUI	\$ 40.15
201344-02	SPARE, NOSECUP SIZE 2	EUI	\$ 40.15
201344-03	SPARE, NOSECUP SIZE 3	EUI	\$ 40.15
201344-04	SPARE, NOSECUP SIZE 4	EUI	\$ 40.15
201345-01	SPARE, DRINKING STRAW (20)	EUI	\$ 5.25
201346-01	SPARE, INNER FILTER	EUI	\$ 36.05
201347-01	SPARE, LOUVER COVER, FRR FP	EUI	\$ 12.60
201349-01	SPARE, INHAL ASSY, FRR (10)	EUI	\$ 24.70
201350-01	SPARE, CARTDG ASSY, FRR EXHALE	EUI	\$ 10.30
201351-01	SPARE, INHAL VALVE BLANK	EUI	\$ 19.22
201353-01	SPECTACLE KIT ASSY (10)		\$ 56.65
201354-01	ADAPTER ASSY, DRINK TUBE		\$ 31.50
201355-01	LENS KIT, TINT		\$ 56.65
201355-02	LENS KIT, CLEAR		\$ 55.36
201355-03	LENS KIT, LASER		\$ 63.00
201355-05	LENS KIT, BLUEBLOCKER		\$ 56.65
201365-01	KIT,35%TRANSFER VALVE (AP-2.2)		\$ 46.50
201365-02	KIT,35%TRANSFER VALVE (AP-4.5)		\$ 46.50
201365-03	KIT,35%TRANSFER VALVE (AP-5.5)		\$ 46.50
201365-04	KIT,35%TRANSFER VALVE(NXG-2.2)		\$ 46.50
201365-05	KIT,35%TRANSFER VALVE(NXG 4.5)		\$ 46.50
201365-06	KIT,35%TRANSFER VALVE(NXG 5.5)		\$ 46.50
201365-11	KIT,25%TRANSFER VALVE (AP-2.2)		\$ 46.50
201365-12	KIT,25%TRANSFER VALVE (AP-4.5)		\$ 46.50

**Revision A**

Current revision date: December 1, 2018



**All prices listed herein supercede all other price lists, including (but not limited to) Scott master PDF price list. All prices are subject to change.**

**3M | Scott Fire & Safety Master Price List**

<b>ITEM</b>	<b>Product Description</b>	<b>Signal Code</b>	<b>List Price</b>
201365-13	KIT,25%TRANSFER VALVE (AP-5.5)		\$ 46.50
201365-14	KIT,25%TRANSFER VALVE(NXG-2.2)		\$ 46.50
201365-16	KIT,25%TRANSFER VALVE(NXG 5.5)		\$ 46.50
201366-11	PGM CSTR SVCE KIT,X3,PASS,4.5		\$ 690.00
201366-12	PGM CSTR SVCE KIT,X3,PASS,2.2		\$ 690.00
201366-13	PGM CSTR SVCE KIT,X3,PASS,5.5		\$ 690.00
201367-11	PGM CSTR SVCE KIT,X3,SEMS,4.5		\$ 1,530.00
201367-12	PGM CSTR SVCE KIT,X3,SEMS,2.2		\$ 1,530.00
201367-13	PGM CSTR SVCE KIT,X3,SEMS,5.5		\$ 1,530.00
201367-31	PGM CSTR SVCE KIT,X3,BT,4.5		\$ 1,710.00
201367-32	PGM CSTR SVCE KIT,X3,BT,2.2		\$ 1,710.00
201367-33	PGM CSTR SVCE KIT,X3,BT,5.5		\$ 1,710.00
201373-01	KIT, AP REDUCER TO POSI-CHEK	SAR	\$ 170.40
201379-01	CYL VALVE ASSY, FAST FILL, 2.2		\$ 1,030.00
201379-02	CYL VALVE ASSY, FAST FILL, 3.0		\$ 1,030.00
201379-03	CYL VALVE ASSY, FAST FILL, 4.5		\$ 1,030.00
201385-01	CYL ASSY, FAST FILL,5 MIN, 3.0		\$ 1,490.00
201386-01	CYL ASSY, FAST FILL,10 MIN, 3.		\$ 1,610.00
201387-01	CYL ASSY, FAST FILL,5 MIN, 2.2		\$ 1,220.00
201388-01	CYL ASSY, FAST FILL,10 M, 4.5	EOL	\$ 1,660.00
201389-01	CYL ASSY, FAST FILL,15 M, 4.5		\$ 1,670.00
201398-32-D	CA,ASSY,ELSA 5MIN ESC DEVICE		\$ 530.00
201398-33-D	CA,ASSY,ELSA 10MIN ESC DEVICE		\$ 650.00
201398-34-D	CA,ASSY,ELSA 15MIN ESC DEVICE		\$ 815.00
201408-01	EZ-SCAPE PRO, WP & BELT ASSY		\$ 850.00
201408-11	WP,BELT,50' ROPE,CROS HK,F4		\$ 1,500.00

**Revision A**

Current revision date: December 1, 2018



**All prices listed herein supercede all other price lists, including (but not limited to) Scott master PDF price list. All prices are subject to change.**

**3M | Scott Fire & Safety Master Price List**

<b>ITEM</b>	<b>Product Description</b>	<b>Signal Code</b>	<b>List Price</b>
201408-12	WP,BELT,50' ROPE,LGT-GT HK,F4		\$ 1,550.00
2014226	ASSEMBLY,ELSA-15		\$ 815.00
201429-01	KIT, ARTS FIT TEST ADAPTR, FRR		\$ 72.10
201438-01	STRAP ASSEMBLY,WAIST TO SHLDER		\$ 83.00
201440-01	KIT, ATV		\$ 34.90
201440-02	KIT, ATV, PISTON, CAP & SLEEVE		\$ 26.40
201440-03	KIT, ATV, PLUG & SEAT		\$ 20.10
201443-01	BAILOUT/DESCENDER POUCH KIT		\$ 530.00
201444-01	PRESSURE REDUCER ASSY,RIT-PAK		\$ 335.00
201450-01	SCOTT SIGHT,TIC - BF		\$ 1,070.00
201452-01	BATTERY CHASSIS SUBASSEMBLY		\$ 37.25
201453-01	BATTERY LID SUBASSEMBLY		\$ 35.10
201455-01	IMD MAIN ASSEMBLY		\$ 1,030.00
201467-01	HEADNET ASSY,KVLR,SURESEAL 4PT		\$ 182.00
201467-02	HEADNET ASSY,KVLR,SURESEAL 4PT		\$ 182.00
201476-01	NOSECUP,RD,VAL,AV300HT SIGHTSM		\$ 52.00
201477-01	NOSECUP,RD,VAL,AV300HT SIGHTMD		\$ 52.00
201478-01	NOSECUP,RD,VAL,AV300HT SIGHTLG		\$ 51.00
2015330	SPARE BAG, ELSA 15		\$ 92.00
201558-01	SEWN BAG ASSY,RIT-BAG,MEDIUM		\$ 590.00
201558-02	SEWN BAG ASSY,RIT-BAG,SMALL		\$ 560.00
201561-01	CYL&VALVE ASSY, 15/4500,90 DEG		\$ 900.00
201562-01	PNEUMATIC ASSY, RIT-PAK, 4500		\$ 960.00
201564-01	RIT-PAK FAST ATTACK,4.5,MEDIUM		\$ 2,630.00
201564-02	RIT-PAK FAST ATTACK,5.5,MEDIUM		\$ 2,630.00
201564-03	RIT-PAK FAST ATTACK,4.5,SMALL		\$ 2,630.00

**Revision A**

Current revision date: December 1, 2018



**All prices listed herein supercede all other price lists, including (but not limited to) Scott master PDF price list. All prices are subject to change.**

**3M | Scott Fire & Safety Master Price List**

<b>ITEM</b>	<b>Product Description</b>	<b>Signal Code</b>	<b>List Price</b>
201566-01	VALVE ASSY, CGA,90 DEG,5500PSI		\$ 520.00
201567-01	CYL&VALVE ASSY, 30/5500,90 DEG		\$ 1,451.00
201568-01	CYL&VALVE ASSY, 45/5500,90 DEG		\$ 1,722.00
201580	UNIVERSAL TOOL		\$ 16.00
201581-01	SCOTT SIGHT SYS-SM 5-ST		\$ 1,960.00
201581-01P	SSIGHT SYS-SM 5-ST, PRO		\$ 2,313.00
201581-02	SCOTT SIGHT SYS-SM 5-ST W/COMM		\$ 2,060.00
201581-02P	SSIGHT SYS-SM 5-ST,W/COM PRO		\$ 2,415.00
201581-11	SCOTT SIGHT SYS-SM 4-ST		\$ 1,960.00
201581-11P	SSIGHT SYS-SM 4-ST,PRO		\$ 2,313.00
201581-12	SCOTT SIGHT SYS-SM 4-ST W/COMM		\$ 2,060.00
201581-12P	SSIGHT SYS-SM 4-ST,W/COM PRO		\$ 2,415.00
201581-21	SCOTT SIGHT SYS-SM GAL 5-ST		\$ 1,960.00
201581-21P	SSIGHT SYS-SM EN 5-ST,PRO		\$ 2,313.00
201581-22	SCOTT SIGHT SYS-SM GAL WC 5-ST		\$ 2,060.00
201581-22P	SSIGHT SYS-SM EN WC 5-ST,PRO		\$ 2,415.00
201581-31	SCOTT SIGHT SYS-SM GAL 4-ST		\$ 1,960.00
201581-31P	SSIGHT SYS-SM EN 4-ST,PRO		\$ 2,313.00
201581-32	SCOTT SIGHT SYS-SM GAL WC 4-ST		\$ 2,060.00
201581-32P	SSIGHT SYS-SM EN WC 4-ST,PRO		\$ 2,415.00
201582-01	SCOTT SIGHT SYS-MD 5-ST		\$ 1,960.00
201582-01P	SSIGHT SYS-MD 5-ST, PRO		\$ 2,313.00
201582-02	SCOTT SIGHT SYS-MD 5-ST W/COMM		\$ 2,060.00
201582-02P	SSIGHT SYS-MD 5-ST W/COM,PRO		\$ 2,415.00
201582-11	SCOTT SIGHT SYS-MD 4-ST		\$ 1,960.00
201582-11P	SSIGHT SYS-MD 4-ST, PRO		\$ 2,313.00

**Revision A**

Current revision date: December 1, 2018



**All prices listed herein supercede all other price lists, including (but not limited to) Scott master PDF price list. All prices are subject to change.**

**3M | Scott Fire & Safety Master Price List**

<b>ITEM</b>	<b>Product Description</b>	<b>Signal Code</b>	<b>List Price</b>
201582-12	SCOTT SIGHT SYS-MD 4-ST W/COMM		\$ 2,060.00
201582-12P	SSIGHT SYS-MD 4-ST W/COM,PRO		\$ 2,415.00
201582-21	SCOTT SIGHT SYS-MD GAL 5-ST		\$ 1,960.00
201582-21P	SSIGHT SYS-MD EN 5-ST, PRO		\$ 2,313.00
201582-22	SCOTT SIGHT SYS-MD GAL WC 5-ST		\$ 2,060.00
201582-22P	SSIGHT SYS-MD EN WC 5-ST, PRO		\$ 2,415.00
201582-31	SCOTT SIGHT SYS-MD GAL 4-ST		\$ 1,960.00
201582-31P	SSIGHT SYS-MD EN 4-ST, PRO		\$ 2,313.00
201582-32	SCOTT SIGHT SYS-MD GAL WC 4-ST		\$ 2,060.00
201582-32P	SSIGHT SYS-MD EN WC 4-ST, PRO		\$ 2,415.00
201583-01	SCOTT SIGHT SYS-LG 5-ST		\$ 1,960.00
201583-01P	SSIGHT SYS-LG 5-ST, PRO		\$ 2,313.00
201583-02	SCOTT SIGHT SYS-LG 5-ST W/COMM		\$ 2,060.00
201583-02P	SSIGHT SYS-LG 5-ST W/COM,PRO		\$ 2,415.00
201583-11	SCOTT SIGHT SYS-LG 4-ST		\$ 1,960.00
201583-11P	SSIGHT SYS-LG 4-ST, PRO		\$ 2,313.00
201583-12	SCOTT SIGHT SYS-LG 4-ST W/COMM		\$ 2,060.00
201583-12P	SSIGHT SYS-LG 4-ST W/COM,PRO		\$ 2,415.00
201583-21	SCOTT SIGHT SYS-LG GAL 5-ST		\$ 1,960.00
201583-21P	SSIGHT SYS-LG EN 5-ST, PRO		\$ 2,313.00
201583-22	SCOTT SIGHT SYS-LG GAL WC 5-ST		\$ 2,060.00
201583-22P	SSIGHT SYS-LG EN WC 5-ST, PRO		\$ 2,415.00
201583-31	SCOTT SIGHT SYS-LG GAL 4-ST		\$ 1,960.00
201583-31P	SSIGHT SYS-LG EN 4-ST, PRO		\$ 2,313.00
201583-32	SCOTT SIGHT SYS-LG GAL WC 4-ST		\$ 2,060.00
201583-32P	SSIGHT SYS-LG EN WC 4-ST, PRO		\$ 2,415.00

**Revision A**

Current revision date: December 1, 2018



**All prices listed herein supercede all other price lists, including (but not limited to) Scott master PDF price list. All prices are subject to change.**

**3M | Scott Fire & Safety Master Price List**

<b>ITEM</b>	<b>Product Description</b>	<b>Signal Code</b>	<b>List Price</b>
201584-01	SCOTT SIGHT UPGRD KIT SM		\$ 1,600.00
201584-01P	SSIGHT INSTALL KIT,PRO,SM		\$ 1,930.00
201584-02	SCOTT SIGHT UPGRD KIT SM WC		\$ 1,700.00
201584-02P	SSIGHT INSTALL KIT,PRO,SM WC		\$ 2,032.00
201584-21	SCOTT SIGHT UPGRD KIT SM GAL		\$ 1,610.00
201584-21P	SSIGHT INSTALL KIT,PRO,SM EN		\$ 1,930.00
201584-22	SCOTT SIGHT UPGRD KT SM WC GAL		\$ 1,720.00
201584-22P	SSIGHT INSTAL KIT,PRO,SM WC EN		\$ 2,032.00
201585-01	SCOTT SIGHT UPGRD KIT MD		\$ 1,600.00
201585-01P	SSIGHT INSTALL KIT,PRO,MD		\$ 1,930.00
201585-02	SCOTT SIGHT UPGRD KIT MD WC		\$ 1,700.00
201585-21	SCOTT SIGHT UPGRD KIT MD GAL		\$ 1,600.00
201585-21P	SSIGHT INSTALL KIT,PRO,MD EN		\$ 1,930.00
201585-22	SCOTT SIGHT INSTAL KT MD WC EN		\$ 1,720.00
201586-01	SCOTT SIGHT UPGRD KIT LG		\$ 1,600.00
201586-01P	SSIGHT INSTALL KIT,PRO,LG		\$ 1,930.00
201586-02	SCOTT SIGHT UPGRD KIT LG WC		\$ 1,700.00
201586-02P	SSIGHT INSTALL KIT,PRO,LG WC		\$ 2,032.00
201586-21	SCOTT SIGHT UPGRD KIT LG GAL		\$ 1,610.00
201586-21P	SSIGHT INSTALL KIT,PRO,LG EN		\$ 1,930.00
201586-22	SCOTT SIGHT UPGRD KT LG WC GAL		\$ 1,720.00
201586-22P	SSIGHT INSTAL KIT,PRO,LG WC EN		\$ 2,032.00
201587-01	KIT,GERMANIUM WIND REPLACE TIC		\$ 85.00
2015879	HOSE, HP, GAUGE, ACS	SVC	\$ 278.00
201588-01	KIT,TIC TO MASK BKT BF SPARES		\$ 12.80
201589-01	KIT,BAT DOOR REPLACEMENT KIT		\$ 36.10



**Revision A**

Current revision date: December 1, 2018



**All prices listed herein supercede all other price lists, including (but not limited to) Scott master PDF price list. All prices are subject to change.**

**3M | Scott Fire & Safety Master Price List**

<b>ITEM</b>	<b>Product Description</b>	<b>Signal Code</b>	<b>List Price</b>
201590-01	KIT,BAT DOOR REPLACE KIT IMD		\$ 15.00
201595-01	MASK ASSEMBLY, RIT-PAK		\$ 248.00
201597-01	KEEPER STAP ASSEMBLY		\$ 12.75
201598-01	NIPPLE ASSEMBLY, COUPLING		\$ 17.25
201600-01	SHOULDER STAP ASSY,RIT-PAK,SM		\$ 169.00
201601-01	WHISTLE&GAUGE ASSY,W/SPRG 4500		\$ 222.00
201601-02	WHISTLE&GAUGE ASSY,W/SPRG 5500		\$ 250.00
201605-01	PRESS DEMAND REGULATOR,RIT-PAK		\$ 770.00
201608-01	WAIST BELT ASSY, MALE,X3 PRO		\$ 73.00
201608-02	WAIST BELT ASSY,FEMALE,X3 PRO		\$ 75.00
201609-01	SHLDER HARNESS ASSY,X3PRO,PARA		\$ 830.00
201609-02	SHLDER HARNESS ASSY,X3PRO,ALLG		\$ 830.00
201610-01	WAISTPAD ASY,X3PRO,PARACHUTE		\$ 600.00
201610-02	WAISTPAD ASY,X3 PRO,ALLIGATOR		\$ 600.00
201611-01	EBSS POUCH, X3 PRO		\$ 200.00
201612-01	CHEST SRAP ASSY, LOWER, X3		\$ 83.00
201612-02	CHEST STRAP ASSY, UPPER, X3		\$ 83.00
201613-01	BACK FRAME WELDMNT ASSY,X3 PRO		\$ 427.00
201614-01	WAIST BELT EXTENSION,X3 PRO		\$ 67.00
201615-01	AIR-PAK BACK-PAK ASY,X3PRO,PAR		\$ 1,005.00
201615-03	BACK-PAK KIT ASY,X3PRO,PAR		\$ 1,600.00
201615-04	BACK-PAK KIT ASY,X3PRO,ALG		\$ 1,600.00
201615-11	BACK-PAK ASY,NO WP,X3PRO,PARA		\$ 1,140.00
201615-12	BACK-PAK ASY,NO WP,X3PRO,ALLG		\$ 1,140.00
201616-01	ASSY,CYLINDER RETENTION,75 MIN		\$ 144.00
201617-01	ASSY,STRAP,CYLINDER RETENT,75		\$ 47.50

**Revision A**

Current revision date: December 1, 2018



**All prices listed herein supercede all other price lists, including (but not limited to) Scott master PDF price list. All prices are subject to change.**

**3M | Scott Fire & Safety Master Price List**

<b>ITEM</b>	<b>Product Description</b>	<b>Signal Code</b>	<b>List Price</b>
201618-01	EBSS POUCH&HOSE ASSY,X3 PRO		\$ 910.00
201618-02	EBSS POUCH&HOSE ASSY,EZ-SCAPE		\$ 910.00
201620-01	SERVICE TOOL BAG		\$ 221.00
201621-01	SERVICE TOOL POUCH		\$ 19.60
2016236	WASHER, 5 PACK		\$ 10.90
201629-01	SERVICE KIT, CHK VLV ASSY		\$ 26.40
201632-01	DESCENDER / ANCHOR POUCH		\$ 212.00
201633-01	AP75 2013 PASS TONE UPDATE KIT		\$ 53.00
201633-02	X3 2013 PASS TONE UPDATE KIT		\$ 53.00
201638-01	RETAING STRAP,WAIST PAD,X3 PRO		\$ 42.30
201639-01	WAISTPAD,EZ-SCAPE PRO, X3 PRO		\$ 402.00
201639-02	WAISTPAD,EZ-SCAPE FIXED,X3 PRO		\$ 402.00
201649-01	HOLDER ASSY,REG,X3 PRO		\$ 35.10
201663-01	JETTISON CLIP REPLACE KIT,EZ S		\$ 112.00
201667-01	SPARE HARNESS KIT, X3 PRO,PARA		\$ 780.00
201667-02	SPARE HARN KIT,X3PRO,PARA,EBSS		\$ 930.00
201667-03	SPARE HARN KIT,X3PRO,PARA,EZ-S		\$ 930.00
201667-04	SPR HARN KIT,X3PR,PARA,EBSS/EZ		\$ 1,090.00
201667-05	SPARE HARNESS KIT,X3PRO,ALLG		\$ 780.00
201667-06	SPARE HARN KIT,X3PRO,ALLG,EBSS		\$ 930.00
201667-07	SPARE HARN KIT,X3PRO,ALLG,EZ-S		\$ 930.00
201667-08	SPR HARN KIT,X3PR,ALLG,EBSS/EZ		\$ 1,090.00
201668-01	EZ-S PRO,X3 PRO,BELT ONLY,JETT		\$ 925.00
201668-11	EZ-S PRO,X3 PRO,CROSBY,JETT		\$ 1,500.00
201668-12	EZ-S PRO,X3 PRO,LT GT,JETT		\$ 1,550.00
201668-21	EZ-S PRO,X3 PRO,BELT ONLY,FIXD		\$ 850.00

**Revision A**

Current revision date: December 1, 2018



**All prices listed herein supercede all other price lists, including (but not limited to) Scott master PDF price list. All prices are subject to change.**

**3M | Scott Fire & Safety Master Price List**

<b>ITEM</b>	<b>Product Description</b>	<b>Signal Code</b>	<b>List Price</b>
201668-31	EZ-S PRO,X3 PRO,CROSBY,FIXED		\$ 1,500.00
201668-32	EZ-S PRO,X3 PRO,LT GT,FIXED		\$ 1,550.00
201669-02	CBL ROUTING CLAMP,ANTI-ROTATN		\$ 24.80
201675-02	RIPTTPADDL MOT HT1000 XTS		\$ 375.00
201675-04	RIPTTPADDL MOT HT750/1250/1550		\$ 375.00
201675-06	RIPTTPADDL MOT APX XPR MTP DP		\$ 375.00
201675-07	RIPTTPADDL KEN TX NX MULTI PIN		\$ 375.00
201675-11	RIPTTPADDLE MOT GP300		\$ 375.00
201675-21	RIPTTPADDL HAR XL 200 XG100		\$ 375.00
201675-22	RIPTTPADDL HAR XG25/75 P7300		\$ 375.00
201675-28	RIPTTPADDL KEN TX NX 2PIN		\$ 375.00
201700-01	JETTISON CLIP ASY,EZS PRO,X3PR		\$ 53.00
2017070	RESP FIT TEST KIT (BITREX) REF		\$ 272.00
2017092	APPLICATOR KIT, SENSITIVITY		\$ 26.30
2017093	APPLICATOR KIT, FIT TEST		\$ 26.30
2017094	NEBULIZER, BITREX, LABELS		\$ 95.00
2017095	HOOD, FIT TEST, BITREX		\$ 38.60
2017491	LOCK NUT, 5 PACK		\$ 10.90
2018340	BODY, REDUCER, ACS		\$ 315.00
2018341	O-RING, VITON, AS568-006		\$ 2.10
2018839	SINGLE CYLINDER BAND, ACSi		\$ 39.80
2019228	PROBE, 2216 PSI REDUCER, ACS		\$ 315.00
2019229	PROBE, 4500 PSI, ACS		\$ 315.00
2019231	REDUCER, ACS, 2216 PSI		\$ 560.00
2019232	REDUCER, ACS, 4500 PSI		\$ 650.00
2019374	PLUG, BLANK, HP, ACS		\$ 49.60

**Revision A**

Current revision date: December 1, 2018



**All prices listed herein supercede all other price lists, including (but not limited to) Scott master PDF price list. All prices are subject to change.**

**3M | Scott Fire & Safety Master Price List**

<b>ITEM</b>	<b>Product Description</b>	<b>Signal Code</b>	<b>List Price</b>
2020313	WHISTLE AND GAUGE, 2216, ACS		\$ 471.00
2020314	WHISTLE AND GAUGE, 4500, ACS		\$ 471.00
2021489	COVER, ACS		\$ 49.60
2021535	SCREW, ACS		\$ 10.00
21917-02	STRIKER ASSY, PAK-ALARM**	DIS	\$ 29.90
26042-01	FASTENER ASSY		\$ 20.60
26369-006	6'SUPPLY HOSE,HANSEN HK		\$ 258.00
26369-010	10'SUPPLY HOSE,HANSEN HK		\$ 307.00
26369-025	25'SUPPLY HOSE,HANSEN HK		\$ 395.00
26369-050	50'SUPPLY HOSE,HANSEN HK		\$ 474.00
26369-100	100'SUPPLY HOSE,HANSEN HK		\$ 620.00
26370-006	6' SUPPLY HOSE,S/S FOSTER		\$ 135.00
26370-010	SUPPLY HOSE FOSTER		\$ 157.00
26370-025	25' SUPPLY HOSE,S/S FOSTER		\$ 216.00
26370-050	50' SUPPLY HOSE,S/S FOSTER	DIS	\$ 305.00
26370-100	100' SUPPLY HOSE,S/S FOSTER		\$ 470.00
26370-150	150' SUPPLY HOSE, S/S FOSTER		\$ 640.00
26390-13	MANIFOLD ASSY		\$ 550.00
26896-01	BUCKLE ASSY, SPARE PARTS	DIS	\$ 73.00
26954-00	2.2 CYLVLV SAFETY DEV RPL KIT	DIS	\$ 32.80
26954-01	4.5 CYLVLV SAFETY DEV RPL KIT	DIS	\$ 32.80
26954-02	3.0 SAFETY DEVICE KIT		\$ 32.80
26954-03	5.5 SAFETY DEVICE KIT	DIS	\$ 32.80
26977-01	KIT,HARDWARE, FRAME	DIS	\$ 17.90
26978-01	KIT,TOOL,FRAME RETAINER		\$ 11.60
26985-01	AP 50 HARNESS RPL KIT, BLK KEV		\$ 1,000.00

**Revision A**

Current revision date: December 1, 2018



**All prices listed herein supercede all other price lists, including (but not limited to) Scott master PDF price list. All prices are subject to change.**

**3M | Scott Fire & Safety Master Price List**

<b>ITEM</b>	<b>Product Description</b>	<b>Signal Code</b>	<b>List Price</b>
26985-04	ISCBA HARNESS RPL KIT, BLK KEV		\$ 461.00
26985-05	AP HARNESS RPL KIT, BLK KEV		\$ 463.00
26985-08	AP HARNESS RPL KIT SNAPS,BLK K		\$ 500.00
26986-01	CYLINDER RETENTION KIT(WFORM)		\$ 150.00
27245-01	PACKING, PREFORMED SQUARE	EXP	\$ 3.25
27436-01	HANGER, CYLINDER		\$ 62.00
27436-02	HANGER, CYLINDER		\$ 7.00
27473-01	MATCH PACK, LOCTITE 242		\$ 5.40
27501-01	HEX DRIVER (3/32 INCH)	DIS	\$ 8.30
27501-02	HEX DRIVER (7/64 INCH)	DIS	\$ 8.30
27501-03	HEX DRIVER (3/16 INCH)	DIS	\$ 12.40
27537-01	ACCESSORY HOSE ASSY,HANSEN		\$ 356.00
27537-02	ISCBA AIRLINE HOSE,SCHRADER		\$ 356.00
27537-03	ACCESSORY HOSE ASSY		\$ 356.00
27537-04	HAN HK EXT DURATION HS,HK SKT		\$ 243.00
27537-05	ACCESSORY HOSE RETAINER ASSY		\$ 243.00
27537-06	ACSY HOSE RETAINER ASSY(SCHR)		\$ 245.00
27537-08	CEJN ACC HOSE, ENAP50		\$ 246.00
27537-11	ACCESSORY HOSE ASSY		\$ 356.00
27537-12	ACCESSORY HOSE ASSY		\$ 356.00
27537-13	ACCESSORY HOSE ASSY		\$ 356.00
27537-14	ACCESSORY HOSE ASSY		\$ 356.00
27540-02	MODIFICATION KIT 2.2		\$ 232.00
27540-04	MODIFICATION KIT 4.5	SVC	\$ 232.00
2805-11	CAPLUG	EXP	\$ 3.25
2827-52	GASKET .437ID, .750OD, .015TK	EXP	\$ 3.25

**Revision A**

Current revision date: December 1, 2018



**All prices listed herein supercede all other price lists, including (but not limited to) Scott master PDF price list. All prices are subject to change.**

**3M | Scott Fire & Safety Master Price List**

ITEM	Product Description	Signal Code	List Price
29000-00	2216 30MIN ALUMINUM CYLINDER		\$ 495.00
29005-01	SKA-PAK 2.2 5MIN ALUMINUM CYL		\$ 334.00
29513-01	AV2 AUX EXHALATION VALVE KIT		\$ 102.00
29586-01	HOSE, LOW PRESSURE		\$ 122.00
29586-03	SKA-PAK LOW PRESSURE HOSE		\$ 134.00
30000-00	HOSE, SUPPLY		\$ 5.00
30010-003	SUPPLY HOSE		\$ 116.00
30010-004	SUPPLY HOSE ASSEMBLY		\$ 119.00
30010-006	6' SUPPLY HOSE,HANSEN		\$ 135.00
30010-010	10' SUPPLY HOSE, HANSEN		\$ 157.00
30010-015	SUPPLY HOSE		\$ 201.00
30010-025	25' SUPPLY HOSE,HANSEN		\$ 216.00
30010-050	50' SUPPLY HOSE,HANSEN		\$ 305.00
30010-100	100' SUPPLY HOSE,HANSEN		\$ 470.00
30010-150	150 FT' SUPPLY HOSE W/HANS		\$ 640.00
30010-300	SUPPLY HOSE, HANSON 300 FT		\$ 1,350.00
30020-006	6' SUPPLY HOSE,SCHRADER		\$ 135.00
30020-010	10' SUPPLY HOSE, SCHRADER		\$ 157.00
30020-015	15' SUPPLY HOSE, SCHRADER		\$ 201.00
30020-025	25' SUPPLY HOSE,SCHRADER		\$ 216.00
30020-050	50' SUPPLY HOSE,SCHRADER		\$ 305.00
30020-100	100' SUPPLY HOSE,SCHRADER		\$ 474.00
30020-150	150' SUPPLY HOSE W/SCHR		\$ 640.00
30020-300	SUPPLY HOSE ASSEMBLY		\$ 1,350.00
30020-S008	8'SUPPLY HOSE,SCHR,SS		\$ 282.00
30020-S025	25'SUPPLY HOSE,SCHR,SS		\$ 310.00

**Revision A**

Current revision date: December 1, 2018



**All prices listed herein supercede all other price lists, including (but not limited to) Scott master PDF price list. All prices are subject to change.**

**3M | Scott Fire & Safety Master Price List**

<b>ITEM</b>	<b>Product Description</b>	<b>Signal Code</b>	<b>List Price</b>
31000006	LABEL, SERVICE, P/N & S/N	SVC	\$ 3.25
31000013	SCREW, PAN HEAD, M4 THREAD	EXP	\$ 2.20
31000015	10-32X1/2 LOW HD SOCKT CAP SCR	DIS	\$ 2.30
31000028	INTRINSIC SAFETY LABEL, EEOSTI		\$ 3.90
31000042	WAIST PAD		\$ 76.00
31000042-01	WAIST PAD	DIS	\$ 177.00
31000043	CAPTIVE SCREW,FILLISTER 4-40		\$ 6.10
31000047	RIGHT LATCH		\$ 105.00
31000048	LEFT LATCH		\$ 105.00
31000050	SPRING, COMPRESSION	EXP	\$ 2.30
31000051	INSULATOR,INLET SWITCH CONN		\$ 5.50
31000052	MANIFOLD		\$ 268.00
31000053	MANIFOLD CAP	DIS	\$ 277.00
31000054	POST, SWIVEL		\$ 37.00
31000055	WASHER, SMALL SWIVEL	EXP	\$ 2.40
31000056	SHAFT, PRESS TO TEST		\$ 10.90
31000057	PLUG, LOW PRESSURE		\$ 8.00
31000058	SEAT, AUTO-TRANSFER		\$ 15.10
31000059	CAP,MANIFOLD END		\$ 3.30
31000060	HOUSING, REDUCER,		\$ 311.00
31000061	HIGH PRESSURE PLUG		\$ 8.00
31000062	SLEEVE, 2.2 TRANSFER VALVE		\$ 23.80
31000063	ELBOW, HIGH PRESSURE	EOL	\$ 60.00
31000064	CHECK VALVE	SVC	\$ 5.50
31000065	NOZZLE AIR PATH	DIS	\$ 33.60
31000066	RETAINER, SWITCH WIRE		\$ 4.10

**Revision A**

Current revision date: December 1, 2018



**All prices listed herein supercede all other price lists, including (but not limited to) Scott master PDF price list. All prices are subject to change.**

**3M | Scott Fire & Safety Master Price List**

<b>ITEM</b>	<b>Product Description</b>	<b>Signal Code</b>	<b>List Price</b>
31000068	SLEEVE, 4.5 TRANSFER VALVE		\$ 32.25
31000072	ORIFICE PLATE	SVC	\$ 5.50
31000073	LABEL, COVER, EZ FLO+	DIS	\$ 3.25
31000103	PIN,CYLINDER LATCH	DIS	\$ 3.30
31000118	RETAINER, SWIVEL FITTING		\$ 14.10
31000120	RETAINER, FLOW CAP		\$ 20.60
31000121	BUTTON, REDUCER POSITIONER	DIS	\$ 5.50
31000123	SCREW,SEMS PAN HD,STAINLESS		\$ 2.20
31000125	SCREW, POSITIONER		\$ 6.40
31000126	SPRING, COMPRESSION	EXP	\$ 3.00
31000143	PRESSURE TRANS 0-4500 PSI W/CA	DIS	\$ 560.00
31000145	PLUG, MANIFOLD, LOW PRESSURE	DIS	\$ 2.30
31000158	LABEL, APPROVAL, INTRINSIC SAF		\$ 2.60
31000170	POS PRESSURE SPRING, EZ FLO+	SVC	\$ 2.30
31000179	GUARD, BATTERY HOUSING	DIS	\$ 47.80
31000180	SCREW,HEX SOCKET,#6-20 TYPE B	SVC	\$ 2.20
31000182	LABEL, NIOSH,SKA-PAK PLUS & AT	DIS	\$ 15.10
31000190	COUPLING FEMALE WAND, CHARGING	DIS	\$ 710.00
31000197	PACKING, PREFORMED	DIS	\$ 3.25
31000199	NECK STRAP GROMMET, TI CAMERA		\$ 38.20
31000203	DETENT BALL, TI CAMERA	DIS	\$ 4.20
31000204	TUBE,BALL DETENT, TI CAMERA	DIS	\$ 22.25
31000205	DETENT PRES.SPRING,TI CAMERA	DIS	\$ 4.50
31000207	PRES.ADJ. WHEEL, TI CAMERA		\$ 67.00
31000211	HANDLE,LEFT,EI,BAE-SERIES	DIS	\$ 28.40
31000212	HANDLE,RIGHT,EI,BAE-SERIES	DIS	\$ 29.40



**Revision A**

Current revision date: December 1, 2018



**All prices listed herein supercede all other price lists, including (but not limited to) Scott master PDF price list. All prices are subject to change.**

**3M | Scott Fire & Safety Master Price List**

<b>ITEM</b>	<b>Product Description</b>	<b>Signal Code</b>	<b>List Price</b>
31000217	GASKET,HOUSING, EI, BAE-SERIES		\$ 29.40
31000218	GLARE SHIELD, EI,BAE-SERIES	DIS	\$ 36.10
31000219	BOOT,HOUSING,EI,BAE-SERIES	DIS	\$ 22.25
31000220	DISPLAY COVER, EI,BAE-SERIES		\$ 41.25
31000225	LABEL,COVER EZ FLO + SWAT NO		\$ 10.60
31000227	BARCODE LABEL FOR NXG2 EE ASY	EOL	\$ 12.60
31000235	DECAL,CYLINDER WARNING,SKA-PAK		\$ 2.50
31000237	BATTERY,ALKALINE 9V		\$ 5.25
31000238	SWITCH, EI 160		\$ 38.20
31000240-01	BAE 160 CORE W/NO TEMP READOUT		\$ 7,170.00
31000240-03	BAE 160 PAL CORE W/NO TEMP REA		\$ 7,170.00
31000240-04	BAE 160 PAL CORE W/ TEMP REA		\$ 7,170.00
31000240-05	CAMERA CORE ASM		\$ 7,170.00
31000240-06	CAMERA CORE ASM		\$ 7,170.00
31000240-07	CAMERA CORE ASM		\$ 7,170.00
31000240-08	CAMERA CORE ASM		\$ 7,170.00
31000240-09	CAMERA CORE ASM		\$ 7,170.00
31000240-10	CAMERA CORE EI 160		\$ 7,170.00
31000240-11	CAMERA CORE ASSEMBLY EI 160		\$ 7,170.00
31000243	RING,MOUNT,WINDOW,EI-BAE SERIE	SVC	\$ 23.25
31000250	10-32 X .500 BUTTON HD CAP SCR	DIS	\$ 2.50
31000251	DETENT PRESSURE SPRING GUIDE	DIS	\$ 10.10
31000259	FITT,HOSE SWIV CONN W/STOP,BLK		\$ 19.30
31000260	FASTENER,BROACHING.112-40 UNC	SVC	\$ 3.30
31000273	BOOT,BATT COVER NXG2 AIR-PAK	EOL	\$ 9.00
31000279	PIVOT GUIDE		\$ 10.60

**Revision A**

Current revision date: December 1, 2018



**All prices listed herein supercede all other price lists, including (but not limited to) Scott master PDF price list. All prices are subject to change.**

**3M | Scott Fire & Safety Master Price List**

<b>ITEM</b>	<b>Product Description</b>	<b>Signal Code</b>	<b>List Price</b>
31000283	BATTERY CHARGER, EI 160	EOL	\$ 379.00
31000284	LABEL,ELECT.ENC PASS/GAUGE ASY	EOL	\$ 3.80
31000296	BOOT,RING,EI,BAE-SERIES	DIS	\$ 17.80
31000298	CABL HARN,CMB TO SCC500,EI 160		\$ 40.25
31000299	CABL HARN,ICB TO CMB, EI 160		\$ 38.20
31000301	CABLE HARN, SMB TO CMB, EI 160		\$ 53.00
31000308	ICB ASSY, EI 160	DIS	\$ 56.00
31000321	LCD,4"TFT COLOR,NTSC EI 160	EOL	\$ 860.00
31000325	SPRING, LC 022C 00 S		\$ 5.40
31000327	FITTING,BATTERY SHEATH MAIN EN	EOL	\$ 16.20
31000335	LOCK PLATE		\$ 4.50
31000336	INLET, SWIVEL, 90 DEG		\$ 93.00
31000345	CAP,PLUG FITTING, NXG2	EOL	\$ 2.30
31000353	HOUSING,TRANSDUCER,HUD MODULE		\$ 3.30
31000354	BRACKET,MOUNTING,HUD MODULE		\$ 10.10
31000355	BUSHING,MOUNTING,HUD MODULE	DIS	\$ 2.30
31000362	HELICAL LOCK WASHER		\$ 2.20
31000366	AC ADAPTER, EI 160	DIS	\$ 84.00
31000380	CLIP,RETAINING,PRESSURE TRANS	EXP	\$ 2.30
31000381	SCREW,PAN HD,PHILLIPS		\$ 5.40
31000382	"U" PIN,GAUGE LINE	EXP	\$ 2.20
31000384	LABEL,INT SAFETY,VISUALERT ASY		\$ 7.40
31000389	INLET CAP		\$ 51.00
31000390	CAP,SPRING		\$ 9.00
31000391	INLET BUSHING		\$ 3.30
31000397	PRESSURE TRANSDUCER	SVC	\$ 261.00

**Revision A**

Current revision date: December 1, 2018



**All prices listed herein supercede all other price lists, including (but not limited to) Scott master PDF price list. All prices are subject to change.**

**3M | Scott Fire & Safety Master Price List**

<b>ITEM</b>	<b>Product Description</b>	<b>Signal Code</b>	<b>List Price</b>
31000401	LABEL,AIR-PAK,CBRN,RETROFIT		\$ 3.25
31000408	GERMANIUM LENS COVER		\$ 16.50
31000409	GERMANIUM LENS	DIS	\$ 355.00
31000412	COVER,LCD		\$ 29.30
31000413	ALKALINE BATTERY HOLDER(ACAD)		\$ 21.60
31000416	BAE CORE ASSY,HORIZONTAL	DIS	\$ 5,390.00
31000419	GASKET,BATTERY COVER		\$ 29.30
31000422	4-40 X .375 SHCS		\$ 0.30
31000434	5/16-32 HEX NUT,NXG2 LED ASY		\$ 2.30
31000435	BATTERY TRUCK CHARGER, EI 160	DIS	\$ 530.00
31000443	PRESSURE TRANSDUCER	DIS	\$ 311.00
31000445	LABEL,APPROVAL,INTRINSIC SAFE		\$ 3.50
31000448	O-RING, PARKER 2-028	DIS	\$ 3.25
31000458	HOUSING COMPLETE,LEFT	SVC	\$ 136.00
31000465	LCD RUBBER CENTERING BLOCKS	DIS	\$ 9.80
31000488	DC ADAPTER, TCS, EI 160	EOL	\$ 120.00
31000491	LABEL,ELSA 15,NIOSH APPROVAL	DIS	\$ 7.20
31000492	SCREW,1/4-20X5/8 LG SOCKET	DIS	\$ 2.20
31000495	BATTERY COVER GASKET		\$ 4.60
31000498	RETAINING RING		\$ 2.30
31000534	SHROUD,DEMANDLEVER,W/RETAINER	SVC	\$ 4.40
31000540	RETAINER RING,SCREW		\$ 2.20
31000553	TEE,1/4 NPT,FEMALE THREAD		\$ 122.00
31000554	NIPPLE,1/4 NPT,COUPLING		\$ 59.00
31000559	TI 160 CAMERA LABEL/BAE SYSTEM	EXP	\$ 2.25
31000565	NIMH BATTERY ASSEMBLY	DIS	\$ 116.00

**Revision A**

Current revision date: December 1, 2018



**All prices listed herein supercede all other price lists, including (but not limited to) Scott master PDF price list. All prices are subject to change.**

**3M | Scott Fire & Safety Master Price List**

<b>ITEM</b>	<b>Product Description</b>	<b>Signal Code</b>	<b>List Price</b>
31000574	CAMERA HSG,FRONT,EMI COATING		\$ 94.00
31000577	RING,RETAINING,EXT "E", 1/4"	DIS	\$ 3.25
31000578	PROFLOW DUFFLE BAG		\$ 53.00
31000605	O-RING,SPARE,HUD TRANSDUCER	DIS	\$ 6.60
31000647	LABEL,COVER,EZ FLO II+	DIS	\$ 3.50
31000673	EI 160 SECURING RUBBER BLOCKS	DIS	\$ 2.60
31000676	EAGLE X CAMER BATTY BAS CHRGER		\$ 175.00
31000678	EAGLE X LOGO LABEL	DIS	\$ 3.50
31000688	PLUG		\$ 18.30
31000689	WIRE,EXTERNAL RETAINER		\$ 6.60
31000698	8-32 X .375 HEX SOC BUTTON SCR	EXP	\$ 2.20
31000805	PLATE,IDENTIFICATION(GENERIC)		\$ 3.25
31000815	FITTING		\$ 41.25
31000816	INLET		\$ 164.00
31000937	BATTERY CAP O-RING		\$ 1.40
31000947	RSSI FLEX CABLE		\$ 11.10
31000948	SPEAKER,600 TO 500HZ 1.0W		\$ 16.10
31000973	RELIEF VALVE, 2.2	DIS	\$ 131.00
31000974	RELIEF VALVE, 3.0	SVC	\$ 96.00
31000975	RELIEF VALVE, 4.5		\$ 96.00
31001002	O-RING, .945 X .079, 70 DUR A		\$ 3.25
31001011	LABEL APPROV INTRINSIC SAFE		\$ 87.00
31001012	LABEL APPROV INTRINSIC SAFE	EOL	\$ 3.80
31001013	LABEL APPROV INTRINSIC SAFETY	EOL	\$ 45.75
31001025	POWER CORD, INT'L EUROPE		\$ 15.25
31001029	POWER CORD, INT'L AUS/NZ		\$ 9.60

**Revision A**

Current revision date: December 1, 2018



**All prices listed herein supercede all other price lists, including (but not limited to) Scott master PDF price list. All prices are subject to change.**

**3M | Scott Fire & Safety Master Price List**

<b>ITEM</b>	<b>Product Description</b>	<b>Signal Code</b>	<b>List Price</b>
31001041	HOUSING,BOTTOM,CONSOLE	DIS	\$ 30.10
31001043	NOSECUP, AV3000 SMALL	DIS	\$ 44.80
31001044	NOSECUP, AV3000 MEDIUM	DIS	\$ 44.80
31001045	NOSECUP, AV3000 LARGE		\$ 44.80
31001110	SCREW, SH, PAN HD, PHILLIPS		\$ 11.60
31001115	BODY,PRESSURE REDUCER	DIS	\$ 800.00
31001118	RETAINER, HOSE	DIS	\$ 3.25
31001123	PIN,GAUGE LINE	DIS	\$ 2.20
31001124	PLUG, MANIFOLD	DIS	\$ 11.40
31001125-010	SUPPLY HOSE, PCL		\$ 168.00
31001125-025	SUPPLY HOSE, PCL		\$ 249.00
31001125-050	SUPPLY HOSE, PCL		\$ 361.00
31001129	BATTERY SUPPORT, DTC, PAK-TRK		\$ 26.80
31001130	BATTERY LATCH, DTC PAK-TRK		\$ 15.80
31001140	PLATE, IDENTIFICATION		\$ 3.25
31001150-01	MOLDED CABLE ASSY,HUD ONLY	SVC	\$ 204.00
31001150-02	MOLDED CABLE ASSY,HUD/PASS	DIS	\$ 375.00
31001150-03	MOLDED CABLE ASSY,AIR-PAK	DIS	\$ 384.00
31001150-04	MOLDED CABLE ASSY,AIR-PAK	DIS	\$ 384.00
31001150-05	MOLDED CABLE ASSY,HUD/PASS	DIS	\$ 334.00
31001180	2007 RIC UAC BOOT		\$ 27.00
31001197	LABEL,INTRINSIC SAFETY		\$ 2.50
31001202	BATTERY CONNECTOR		\$ 61.00
31001207	HOSE, FLOWHOOD		\$ 60.00
31001220	LP HOSE CLAMP,STRAIGHT CONN DU		\$ 23.80
31001221	MANIFOLD,HOUSING	DIS	\$ 86.00

**Revision A**

Current revision date: December 1, 2018



**All prices listed herein supercede all other price lists, including (but not limited to) Scott master PDF price list. All prices are subject to change.**

**3M | Scott Fire & Safety Master Price List**

<b>ITEM</b>	<b>Product Description</b>	<b>Signal Code</b>	<b>List Price</b>
31001223	BUTTON, REDUCER	DIS	\$ 9.00
31001227	FEMALE PLUG ASSY, 3 POLE		\$ 30.10
31001229	PLUG		\$ 9.00
31001230	HOUSING, REDUCER		\$ 820.00
31001231	BLOCK,HOSE		\$ 79.00
31001232	RETAINER,HOSE BLOCK		\$ 13.00
31001238	CLIP,CABLE,ALUM,FRAME	SVC	\$ 2.20
31001239	CLIP,CABLE,WIRE FRAME		\$ 2.20
31001242	BRACKET,SENSOR MODULE		\$ 30.50
31001250	ADAPTER,FEMALE		\$ 30.10
31001255	#17 O-RING (VITON)		\$ 3.25
31001256	NOSECUP,AV2000,ASSEMBLY	DIS	\$ 60.00
31001259	COVER,HOUSING,SENSOR MODULE		\$ 12.00
31001262	O'RING,COVER SCREW,2007		\$ 10.30
31001264	LABEL,WARNING,SENSOR,2007		\$ 8.70
31001265	O-RING, RECEPTACLE	DIS	\$ 3.25
31001277	POST, BATTERY HOUSING, 2007	DIS	\$ 6.60
31001287	SEAL,BATTERY COVER, 2007		\$ 2.40
31001288	COVER SCREW,SENSOR HOUSING,200		\$ 10.50
31001290	E-CLIP,SENSOR,2007	SVC	\$ 1.90
31001298	CLIP,RETENTION		\$ 18.30
31001319	HOUSING, CHECK VALVE	DIS	\$ 123.00
31001331	MOLDED CABLE ASSY, NXG7	DIS	\$ 441.00
31001333	CABLE ASY,PRES.RED.HIGH TEMP	DIS	\$ 55.00
31001336	TRACKER LABEL,PIEZO COVER, 200	DIS	\$ 1.60
31001348	CYLINDER CARBON 45MIN (JAPAN)		\$ 1,380.00

**Revision A**

Current revision date: December 1, 2018



**All prices listed herein supercede all other price lists, including (but not limited to) Scott master PDF price list. All prices are subject to change.**

**3M | Scott Fire & Safety Master Price List**

<b>ITEM</b>	<b>Product Description</b>	<b>Signal Code</b>	<b>List Price</b>
31001358	CLAMP, SUPPORT PLATE		\$ 12.25
31001362	LABEL,NFPA-2007,AIR-PAK 4.5,3.	DIS	\$ 3.25
31001363	LABEL,NFPA-2007,AIR-PAK NXG7	DIS	\$ 7.40
31001364	LABEL,PASS APPROVAL,NFPA 2007	DIS	\$ 3.25
31001371	SOFTWARE CD,WIRELESS BOOT LOAD	EXP	\$ 198.00
31001384	PLUG	DIS	\$ 3.80
31001402	ELBOW,GAUGE LINE		\$ 83.00
31001414	PIN,RIC BOOT		\$ 27.25
31001415	FD-7 BOOT,02 RIC UAC		\$ 51.00
31001417	4-20 PLASTITE SCREW, PAK-TRACK		\$ 0.40
31001418	"U" PIN	SVC	\$ 2.20
31001450	LABEL, 4.5 REDUCER COVER	DIS	\$ 3.25
31001451	LABEL, 3.0 REDUCER COVER		\$ 13.00
31001452	LABEL, 2.2 REDUCER COVER	DIS	\$ 3.25
31001465	APPLICATOR, MANUAL ADHESIVE		\$ 102.00
31001466	STATIC MIXER		\$ 2.10
31001473	LABEL, NXG7 4.5	DIS	\$ 4.50
31001493	MTG. NUT, NARROW,RECEPTACLE		\$ 2.30
31001504	BATTERY, NIMH, C420 PLUS		\$ 221.00
31001506	END CAP, NIMH BATTERY, C420+		\$ 49.30
31001508	LABEL, NXG7 2.2	SVC	\$ 6.40
31001534	LIGHT PIPE		\$ 3.25
31001535	SEAL,SILICONE,ONE RIB,HUD QD	SVC	\$ 6.60
31001536	SCREW,#10-32X3/8,SOC BUTT HD	SVC	\$ 2.20
31001539	BATTERY SEPARATOR,SENSOR 2007	SVC	\$ 9.10
31001541	ADAPTER,NIPPLE TO MALE THREAD		\$ 39.10

**Revision A**

Current revision date: December 1, 2018



**All prices listed herein supercede all other price lists, including (but not limited to) Scott master PDF price list. All prices are subject to change.**

**3M | Scott Fire & Safety Master Price List**

<b>ITEM</b>	<b>Product Description</b>	<b>Signal Code</b>	<b>List Price</b>
31001544	CYL CARBON WRAP,15MIN,4500,15Y		\$ 660.00
31001548	LABEL,NIOSH,CBRN,AP,4.5,3.0,2	SVC	\$ 9.00
31001549	LABEL,NIOSH,CBRN,NXG,4.5,2.2	DIS	\$ 11.40
31001550	BATTERY DOOR LATCH SCREWS, SER		\$ 10.50
31001558	HUB, SLIDER	SVC	\$ 4.40
31001563	CAPLUG,1/2" TEAR	EXP	\$ 2.20
31001568-04	TUBING,HEAT SHRINK,HUD 3" (10)	SVC	\$ 4.90
31001568-05	TUBING,HEAT SHRINK,HUD3.5"(10)	SVC	\$ 5.70
31001582	CYL,BASE,CARB,ST7,30MIN, 4500		\$ 1,160.00
31001583	CYL,BASE,CARB,ST7-45M-4500PSI		\$ 1,430.00
31001584	CYL,BASE,CARB,ST7-60M-4500PSI		\$ 1,570.00
31001595	POWER CABLE	DIS	\$ 51.00
31001608	4"LCD PANEL, LED BACKLIGHT	DIS	\$ 66.00
31001613	RTV,DOW CORNING 3-1744 APP KIT	SVC	\$ 80.00
31001614	Y MANIFOLD		\$ 89.00
31001615	COVER, SEMS II HOUSING		\$ 69.00
31001626	LABEL, BATTERY ISOLATOR	SVC	\$ 0.60
31001627	CABLE HARNESS, I/O TO INTERFAC	DIS	\$ 66.00
31001628	CABLE HARNESS, CORE INTERFACE	DIS	\$ 83.00
31001632	CLAMP,CABLE		\$ 10.10
31001650	UPGRADE LABEL, AP2002 TO 2007	SVC	\$ 6.25
31001651	LABEL, UPGRADE NFPA-2007,NXG2		\$ 9.00
31001712-01	CYL,CARB,30YR 60M4500,SAR-NAVY		\$ 1,986.00
31001744	PIN, PIVOT	SVC	\$ 4.40
31001745	RETAINING SPRING	SVC	\$ 3.25
31001746	WINDOW, DISPLAY	DIS	\$ 53.00



**Revision A**

Current revision date: December 1, 2018



**All prices listed herein supercede all other price lists, including (but not limited to) Scott master PDF price list. All prices are subject to change.**

**3M | Scott Fire & Safety Master Price List**

<b>ITEM</b>	<b>Product Description</b>	<b>Signal Code</b>	<b>List Price</b>
31001748	SWITCH, PUSH BUTTON, BLACK	DIS	\$ 22.90
31001749	SWITCH PUSH BUTTON, GREEN	DIS	\$ 44.30
31001772	SEAL, QUAD RING,AS-568A-221		\$ 7.10
31001773	CAPPLUGS, 20/BAG		\$ 28.75
31001791	PLUG ASSY, FEM, M8, HUD		\$ 40.20
31001861-02	SEAL, HOUSING, SILVER		\$ 24.40
31001870	CABLE, CORE INTERFACE, EI 320	DIS	\$ 12.70
31001890	LENS COVER, TACTICAL TIC		\$ 7.60
31001891	LENS SEAL, TACTICAL TIC	DIS	\$ 13.30
31001892	CORE RETAINER,BTM,TACTICAL TIC	DIS	\$ 0.90
31001893	CORE RETAINER,TOP,TACTICAL TIC	DIS	\$ 0.90
31001896	VENT VALVE		\$ 1.75
31001898	SOCKET HEAD SHOULDER BOLT	DIS	\$ 6.80
31001900	PCB,LCD BRACKET,TACTICAL TIC	DIS	\$ 1.10
31001901	PCB BRACKET,TACTICAL TIC	DIS	\$ 1.00
31001904	2.5 TFT-LCD MODULE	DIS	\$ 255.00
31001905	RETAINER SCREW	DIS	\$ 22.25
31001906	LCD WINDOW, TACTICAL TIC	DIS	\$ 43.30
31001907	LCD SEAL, TACTICAL TIC	DIS	\$ 21.20
31001912	BATTERY RETAINER BRACKET		\$ 2.80
31001913	BATTERY CLIP		\$ 8.50
31001914-01	LENS COVER, TACTICAL TIC,RED	DIS	\$ 24.40
31001914-02	LENS COVER,TACTICAL TIC,ORG	DIS	\$ 34.40
31001914-03	LENS COVER, TACTICAL TIC,YEL	DIS	\$ 34.40
31001914-04	LENS COVER, TACTICAL TIC,BLK	DIS	\$ 24.40
31001915-01	LCD COVER,TACTICAL TIC,RED	DIS	\$ 35.75

**Revision A**

Current revision date: December 1, 2018



**All prices listed herein supercede all other price lists, including (but not limited to) Scott master PDF price list. All prices are subject to change.**

**3M | Scott Fire & Safety Master Price List**

<b>ITEM</b>	<b>Product Description</b>	<b>Signal Code</b>	<b>List Price</b>
31001915-02	LCD COVER,TACTICAL TIC,ORG	DIS	\$ 43.30
31001915-03	LCD COVER,TACTICAL TIC,YEL	DIS	\$ 43.30
31001915-04	LCD COVER,TACTICAL TIC,BLK	DIS	\$ 35.75
31001915-11	LCD CVR,TAC TIC,RED,GLARE SHLD	DIS	\$ 51.00
31001915-12	LCD CVR,TACTIC,ORAN,GLARE SHLD	DIS	\$ 59.00
31001915-13	LCD CVR,TAC TIC,YEL,GLARE SHLD	DIS	\$ 59.00
31001915-14	LCD CVR,TAC TIC,BLK,GLARE SHLD	DIS	\$ 51.00
31001916-01	BATTERY BUMPER,TAC TIC,RED	DIS	\$ 34.70
31001916-02	BATTERY BUMPER,TAC TIC,ORG	DIS	\$ 43.30
31001916-03	BATTERY BUMPER,TAC TIC,YEL	DIS	\$ 43.30
31001916-04	BATTERY BUMPER,TAC TIC,BLK	DIS	\$ 35.75
31001917	HANDLE, RIGHT, TACTICAL TIC	DIS	\$ 30.90
31001918	HANDLE, LEFT, TACTICAL TIC	DIS	\$ 30.90
31001919	HANDLE PCB SEAL, TACTICAL TIC	DIS	\$ 5.00
31001921	BATTERY, RETAINER RING	DIS	\$ 1.25
31001943-01	LABEL, CYLINDER-WARNING 4500	DIS	\$ 3.30
31001943-02	LABEL, CYLINDER-WARNING 3000		\$ 4.80
31001943-03	LABEL, CYLINDER-WARNING 2216		\$ 3.30
31001945	LABEL, CYLINDER-WARNING 3000		\$ 2.00
31001951	BOOT, FILL, NXG	DIS	\$ 27.00
31001960	MANIFOLD, ACS EXT DURATION		\$ 274.00
31001961	MANIFOLD COVER, ACS EXT DUR		\$ 139.00
31001962	CHECK VALVE, MALE, 1/4" NPT		\$ 201.00
31001972	BLEED VAVLE		\$ 183.00
31001973	RESP MANIFOLD OUTLET GAUGE	SVC	\$ 56.00
31001974	HANSEN COUPLING		\$ 89.00

**Revision A**

Current revision date: December 1, 2018



**All prices listed herein supercede all other price lists, including (but not limited to) Scott master PDF price list. All prices are subject to change.**

**3M | Scott Fire & Safety Master Price List**

<b>ITEM</b>	<b>Product Description</b>	<b>Signal Code</b>	<b>List Price</b>
31001975	SCHRADER COUPLING		\$ 113.00
31001976	SS FOSTER COUPLING		\$ 113.00
31001977	RESP REGULATOR INLET GAUGE	SVC	\$ 177.00
31001978	LOW PRESSURE WHISTLE		\$ 680.00
31001979	8" SEMI-PNEUMATIC WHEEL		\$ 76.00
31001980	TOOL OUTLET GAUGE		\$ 48.80
31001992	RING, MOUNTING, IMAGER LENS	DIS	\$ 5.25
31002001	QUICK RELEASE BELT HOLDER		\$ 115.00
31002002	QUICK RELEASE STRAP	SVC	\$ 250.00
31002004	SINGLE POUCH	DIS	\$ 157.00
31002005	DOUBLE POUCH		\$ 222.00
31002006	F4 DESCENT DEVICE		\$ 237.00
31002010	FIRE-AL DESCENT DEVICE ASY,RIT		\$ 373.00
31002011	CARABINER LINK,RIT		\$ 87.00
31002012	WEBBING LOADING TOOL,RIT		\$ 18.30
31002013	50'WEBBING CARTRIDGE,RIT		\$ 45.40
31002014	75'WEBBING CARTRIDGE,RIT		\$ 55.00
31002016	ADAPTOR, NXG2 RELIEF VALVE	SVC	\$ 47.80
31002040	HANGER, CYLINDER VALVE		\$ 55.00
31002042	plug		\$ 4.40
31002043	RETAINER, HIGH PRESSURE		\$ 31.75
31002044	RETAINER, SEAT	SVC	\$ 47.80
31002045	PLUG, ADJUSTMENT	SVC	\$ 23.80
31002046	SEAT	SVC	\$ 33.10
31002047	PISTON		\$ 105.00
31002048	PISTON	SVC	\$ 76.00

**Revision A**

Current revision date: December 1, 2018



**All prices listed herein supercede all other price lists, including (but not limited to) Scott master PDF price list. All prices are subject to change.**

**3M | Scott Fire & Safety Master Price List**

<b>ITEM</b>	<b>Product Description</b>	<b>Signal Code</b>	<b>List Price</b>
31002056	TRANSFER VALVE, 5.5		\$ 3.30
31002064	PACKING, PREFORMED	DIS	\$ 3.25
31002065	PACKING, PREFORMED	DIS	\$ 3.25
31002066	PACKING, PREFORMED	DIS	\$ 3.25
31002067	NOZZLE, AIR PATH		\$ 31.25
31002068	PIN, LATCH LOCK		\$ 10.90
31002069	SPRING, COMPRESSION		\$ 2.30
31002071	SLEEVE, 2.2 INLET		\$ 27.00
31002072	PIN, LOCK		\$ 18.30
31002073	BUSHING		\$ 4.40
31002074	PLATE, RETAINER		\$ 19.30
31002075	SCREW, FH, 8-32X1/2		\$ 2.20
31002076	RING PULL		\$ 45.40
31002077	HOUSING, 2.2 INLET		\$ 162.00
31002078	HOUSING, 4.5 INLET		\$ 162.00
31002079	HOUSING, 5.5 INLET		\$ 162.00
31002083	SLEEVE, 4.5 INLET		\$ 27.00
31002084	SLEEVE, 5.5 INLET		\$ 27.00
31002085	RELIEF VALVE, 5.5	SVC	\$ 185.00
31002086	LABEL, 5.5 REDUCER COVER	DIS	\$ 3.25
31002087	BODY, PRESSURE REDUCER	SVC	\$ 810.00
31002088	HOUSING, REDUCER, NXG		\$ 840.00
31002089	INLET HOUSING, 2.2		\$ 266.00
31002090	INLET HOUSING, 4.5	DIS	\$ 265.00
31002091	INLET HOUSING, 5.5		\$ 266.00
31002095	PROBE, 5500 PSI		\$ 98.00

**Revision A**

Current revision date: December 1, 2018



**All prices listed herein supercede all other price lists, including (but not limited to) Scott master PDF price list. All prices are subject to change.**

**3M | Scott Fire & Safety Master Price List**

<b>ITEM</b>	<b>Product Description</b>	<b>Signal Code</b>	<b>List Price</b>
31002096	PACKING, PREFORMED	SVC	\$ 3.25
31002100	PACKING, PREFORMED	SVC	\$ 3.25
31002101	LABEL, NXG7 5.5		\$ 3.25
31002105	HOUSING, REDUCER		\$ 960.00
31002108	BEARING, WEAR		\$ 19.30
31002109	PLUG		\$ 5.50
31002110	PIN PLUG		\$ 5.50
31002111	PLUG		\$ 5.50
31002114	PLUG, HIGH PRESSURE		\$ 5.50
31002115	LABEL,REDUCER IDENT. (2.2)		\$ 6.90
31002116	BUTTON, REDUCER		\$ 5.50
31002118	POST, SWIVEL		\$ 13.00
31002119	SPACER SWIVEL		\$ 5.50
31002121	BUTT SPLCE, RAYCHEM D1744-01	SVC	\$ 4.40
31002121-10	BUTT SPLCE, RAYCHEM D1744-01(20	SVC	\$ 71.00
31002122	BOOT, VALVE, RELIEF, RIC-UAC		\$ 11.10
31002129	FLASHLIGHT, STREAMLIGHT TLR-1	DIS	\$ 215.00
31002142	SCREW#4X.25PAN HD.SELF LOCKING		\$ 0.30
31002147	SCREW6-32X.275SH SELF LOCKING		\$ 0.30
31002155	PLATE, SUPPORT		\$ 26.60
31002162	HIGH PRESSURE MANIFOLD,RIT-PAK		\$ 149.00
31002168	LOW PRESSR MANIFOLD(5),RIT-PAK		\$ 92.00
31002170	REDUCER MOUNTING PLATE,RIT-PAK		\$ 18.30
31002172	NIPPLE COUPLING, RIT-PAK		\$ 27.00
31002181	SHOCK BUMPER, IMAGER CORE	DIS	\$ 9.30
31002191	PROTECTIVE BAND, KUNKLE VALVE	SVC	\$ 3.25

**Revision A**

Current revision date: December 1, 2018



**All prices listed herein supercede all other price lists, including (but not limited to) Scott master PDF price list. All prices are subject to change.**

**3M | Scott Fire & Safety Master Price List**

<b>ITEM</b>	<b>Product Description</b>	<b>Signal Code</b>	<b>List Price</b>
31002196	CAMERA RETAINER LEFT		\$ 2.50
31002197	CAMERA RETAINER RIGHT		\$ 2.50
31002204	DVR CONNECTION CABLE	DIS	\$ 44.40
31002205	DVR INTERCONNECT CABLE	DIS	\$ 12.25
31002216	ATTACK TVR DOWNLOAD CABLE	DIS	\$ 99.00
31002217	CAMERA SERVICE ADAPTER		\$ 9.80
31002218	TAC-TIC LCD CABLE	DIS	\$ 12.25
31002219	REAR ACCESS COVER		\$ 10.00
31002220	HANGER,CYLINDER,NAV-SEA		\$ 24.00
31002224	SPLIT RING, RIT-PAK		\$ 5.40
31002225	LABEL, WARNING, RIT-PAK		\$ 3.50
31002226	REDUCER LABEL,2.2,RIT-PAK III		\$ 8.80
31002227	REDUCER LABEL,4.5,RIT-PAK III		\$ 9.30
31002234	BATTERY RETAINER LATCH		\$ 9.50
31002235	TAC-TIC POWER/CORE CABLE	DIS	\$ 32.00
31002246	WASHER, SS, .24" O.D.		\$ 2.10
31002254	DUAL CHARGER PCB	DIS	\$ 101.00
31002262	O-RING, KUNKLE VALVE		\$ 10.10
31002265	ACCESSORY LIGHT MOUNT	DIS	\$ 21.20
31002266	RUBBER FOOT		\$ 2.25
31002267	CYL.CARBON,30YR,30MIN,4500PSIG		\$ 1,340.00
31002268	CYL.CARBON,30YR,45MIN,4500PSIG		\$ 1,760.00
31002269	NYLOCK NUT,#10-32,SELF LOCKING		\$ 0.30
31002270	CAP, CLOSURE, M12		\$ 14.10
31002272	2-28 X .625 TRILOBE SCREW		\$ 0.20
31002275	LABEL,FIELD SERV. REPL. 2 X .5	EXP	\$ 3.25

**Revision A**

Current revision date: December 1, 2018



**All prices listed herein supercede all other price lists, including (but not limited to) Scott master PDF price list. All prices are subject to change.**

**3M | Scott Fire & Safety Master Price List**

<b>ITEM</b>	<b>Product Description</b>	<b>Signal Code</b>	<b>List Price</b>
31002284	USB DOWNLOAD POWER ADAPTER		\$ 35.75
31002289	LABEL,BARCODE,FIELD SERV.,5X.5	EXP	\$ 3.25
31002290	LABEL, NIOSH CBRN AP 5.5	SVC	\$ 9.00
31002291	LABEL, NFPA-2007 AP 5.5		\$ 10.90
31002292	LABEL, NIOSH CBRN NXG 5.5		\$ 10.90
31002293	LABEL, NFPA-2007 NXG 5.5		\$ 8.50
31002295	RED GLPT INSULATING VARNISH		\$ 36.00
31002299	CYL,CARBON WRAP-30 MIN 5500PSI		\$ 1,190.00
31002300	CYL,CARBON WRAP-45 MIN 5500PSI		\$ 1,470.00
31002301	CYL,CARBON WRAP-60 MIN 5500PSI		\$ 1,670.00
31002302	CYL,CARBON WRAP-75 MIN 5500PSI		\$ 1,880.00
31002303	SPLIT HARNESS RING		\$ 0.90
31002307	RUBBER BUMPER, TACTICAL TIC	DIS	\$ 0.60
31002319	LABEL,MASK,FIELD SERV.,REPLACE	EXP	\$ 0.40
31002320	TAPERED SHANK FASTENER,TAC-TIC	DIS	\$ 6.00
31002321	FLAT RING SEAL, TACTICAL TIC	DIS	\$ 0.30
31002325	PRESS-TO-TEST		\$ 5.50
31002327	SNAP RING, INTERNAL		\$ 3.25
31002331	LABEL,REDUCER IDENT (5.5)	SVC	\$ 3.25
31002333	SEAT, AUTO-TRANSFER		\$ 25.90
31002352	PACKING,PREFMD,SERV.SPARE,FD17	DIS	\$ 4.90
31002358	LABEL,NIOSH,NAVY WIREFRAME	SVC	\$ 6.40
31002359	RETAINER, CYLINDER BRACKET		\$ 29.10
31002361	BATTERY CAP, C420+ PAPR		\$ 49.30
31002364	MOUNT, RELIEF VALVE		\$ 40.20
31002365	LABEL,REDUCER IDENT (4.5)		\$ 3.25

**Revision A**

Current revision date: December 1, 2018



**All prices listed herein supercede all other price lists, including (but not limited to) Scott master PDF price list. All prices are subject to change.**

**3M | Scott Fire & Safety Master Price List**

<b>ITEM</b>	<b>Product Description</b>	<b>Signal Code</b>	<b>List Price</b>
31002366	PACKING,PREFORMED		\$ 7.20
31002368	PACKING,PREFORMED		\$ 4.40
31002369	BASE CHARGE BOARD,PAK-TRACKER		\$ 161.00
31002377	REDUCER LABEL, 5.5 RIT		\$ 4.80
31002483	SKA-PAK NIOSH CYL LBL 3-5MIN		\$ 5.90
31002484	SKA-PAK NIOSH CYL LBL 15 MIN		\$ 16.20
31002486	PACKING, PREFORMED	SVC	\$ 3.25
31002490	COVER, BACK, EPIC 3		\$ 5.90
31002495	SEAL,MOUNT,EPIC 3		\$ 3.50
31002498	SCREW,BH,#2-28,3/16",T8,SS		\$ 0.30
31002499	SCREW,BH,#2-28,5/8",T8,SS		\$ 0.50
31002517	SCREW,PAN HEAD,4-40,1/4",SS		\$ 40.00
31002534	PACKING,PREFORMED	SVC	\$ 3.25
31002535	PACKING,PREFORMED		\$ 3.25
31002537	2.4 GHz ANTENNA		\$ 21.00
31002544	COVER, SHROUD, AIR-PAK X3		\$ 34.90
31002546	SPRING CLIP,CYLINDR HANDLE, X3		\$ 3.30
31002549	CLEVIS POST,MALE AIR-PAK X3		\$ 10.10
31002550	CLEVIS POST,FEMALE AIR-PAK X3		\$ 10.10
31002553	COVER,HUD ONLY,AIR-PAK X3		\$ 48.60
31002570	SPRING, COMPRESSION		\$ 2.30
31002571-01	X3, CONSOLE HOUSING, FRONT		\$ 33.60
31002571-02	X3, CONSOLE HOUSING,FRONT SEMS		\$ 33.60
31002572	X3, PASS CONSOLE, HOUSING,REAR		\$ 10.80
31002579	X3 SEMS CONSOLE,HOUSING,REAR		\$ 10.80
31002582	SPRING, COMPRESSION		\$ 2.30



**Revision A**

Current revision date: December 1, 2018



**All prices listed herein supercede all other price lists, including (but not limited to) Scott master PDF price list. All prices are subject to change.**

**3M | Scott Fire & Safety Master Price List**

<b>ITEM</b>	<b>Product Description</b>	<b>Signal Code</b>	<b>List Price</b>
31002615	LABEL,AP75,NFPA 2013 BACKFRAME		\$ 3.25
31002617	LABEL,A-P,NIOSH-CBRN 2013,2.2		\$ 10.60
31002618	LABEL, X3,NFPA 2013 BACKFRAME	SVC	\$ 3.25
31002620	LABEL,,X3,NIOSH-CBRN,2.2 CGA	SVC	\$ 4.00
31002636	GRILL, AV3000 HT		\$ 7.30
31002637	GRILL,AMP,AV3000 HT, RIGHT		\$ 7.30
31002639	ADAPTER,COMM,AV3000 HT, RIGHT		\$ 10.00
31002660	LABEL,IDENTIFICATION,X3,PASS		\$ 3.30
31002667	SCREW,SFHCS,8-32X5/16	SVC	\$ 2.20
31002676	SCREW,TRILOBULAR,#6-19,.50 LG		\$ 1.80
31002677	POST,BATT.HOUSING,SENSOR MOD.		\$ 9.25
31002681	SENSOR MODULE COVER, X3		\$ 49.40
31002682	CAP,BATTERY,SENSOR MODULE,X3		\$ 21.60
31002721	STRAP, WAIST TO SHOULDER(SWAT)		\$ 39.10
31002730	TRI-SLIDE, 1-1/2" X 5/16" SLOT		\$ 3.30
31002740	WAIST BELT		\$ 42.30
31002745	ANTENNA FLEX CABLE		\$ 16.10
31002759	LABEL,,X3,NIOSH-CBRN,4.5 CGA	SVC	\$ 4.00
31002760	LABEL,,X3,NIOSH-CBRN,5.5 CGA	SVC	\$ 4.00
31002763	LABEL,A-P,NIOSH-CBRN 2013,4.5		\$ 10.90
31002764	LABEL,A-P,NIOSH-CBRN 2013,5.5		\$ 9.30
31002772	LABEL, IS, PASS, 2013		\$ 7.00
31002773	LABEL,WARNING, SENSOR X3		\$ 7.00
31002774	LABEL,PASS APPROVAL,NFPA 2013		\$ 7.00
31002785	LABEL,X3,NIOSH-CBRN,2.2 SNAP	SVC	\$ 3.25
31002786	LABEL,X3,NIOSH-CBRN,4.5 SNAP	SVC	\$ 3.25

**Revision A**

Current revision date: December 1, 2018



**All prices listed herein supercede all other price lists, including (but not limited to) Scott master PDF price list. All prices are subject to change.**

**3M | Scott Fire & Safety Master Price List**

<b>ITEM</b>	<b>Product Description</b>	<b>Signal Code</b>	<b>List Price</b>
31002787	LABEL,X3,NIOSH-CBRN,5.5 SNAP	SVC	\$ 6.10
31002788	VALVE, INHALATION RED		\$ 4.25
31002790	BAND, COMM, AV3000 HT, RIGHT		\$ 12.80
31002791	BAND, COMM, AV3000 HT, LEFT		\$ 45.80
31002800	GRILL,AMP,AV3000 HT, LEFT		\$ 11.75
31002808	SCREW, SHOULDER		\$ 8.50
31002809	BEZEL, UPPER, AV3000 HT		\$ 10.50
31002810	BEZEL, LOWER, AV3000 HT	SVC	\$ 15.70
31002815	SWIVEL,HIGH PRESSURE HOSE		\$ 140.00
31002823	NXG AIR PATH WRENCH		\$ 202.00
31002868	WASHER,#4 FLAT, SS		\$ 0.40
31002916	SCREW,PH 6-32X1/2 SS NYL PATCH	SVC	\$ 2.20
31002920	SCREW,PAN HD,2-56X1/2,SS,BLK		\$ 2.20
31002942	SCREW PIVOT		\$ 8.50
31002946	POST, PIVOT		\$ 10.10
31002958	HP PLUG, #4 HEX HD WITH O-RING		\$ 2.10
31002959	HANDLE, MOBILE AIR CART		\$ 425.00
31002960	PIN,HANDLE CLEVIS, AIR CART		\$ 40.10
31002961	LANYARD CABLE, HANDLE, AIR CAR		\$ 5.60
31002962	LANYARD ATTACH RING, AIR CART		\$ 2.40
31003020	LUBRICANT, SIL GREASE, SPARE		\$ 58.00
31003025	ASSEMBLY,HEAD(NEW STYLE)	SAR	\$ 2,358.30
31003026	KNOB,HEAD MOUNTING POSI-CHECK	SAR	\$ 7.20
31003027	STANDOFF,INSERT,MOLDED POSI	SAR	\$ 18.40
31003028	SHEET,INSTRUCTION,INSTALL PO	SAR	\$ 5.10
31003029	GASKET, POSI CHEK, HEAD	SAR	\$ 24.50

**Revision A**

Current revision date: December 1, 2018



**All prices listed herein supercede all other price lists, including (but not limited to) Scott master PDF price list. All prices are subject to change.**

**3M | Scott Fire & Safety Master Price List**

<b>ITEM</b>	<b>Product Description</b>	<b>Signal Code</b>	<b>List Price</b>
31003030	HEAD, POSI	SAR	\$ 2,075.70
31003031	TUBING,TYGON,1/8ID,1/4 OD	SAR	\$ 5.10
31003032	KIT US EXTERNAL MANIFOLDS POSI	SAR	\$ 3,054.90
31003033	KIT,SPARE FUSE,POSI3 USB,110	SAR	\$ 12.30
31003034	MANIFOLD,LO PRESSURE,2200 PSI	SAR	\$ 744.60
31003035	MANIFOLD,HI PRESSURE,4500 PSI	SAR	\$ 963.90
31003036	POWER CORD,BELDEN 17504IN BLA	SAR	\$ 37.80
31003037	SOFT TIP,2250 PSI,WESTERN# 6	SAR	\$ 20.40
31003038	NIPPLE,O-RING,WESTERN #6347-	SAR	\$ 7.20
31003039	SCREW,RETAINING,WESTERN#SS63	SAR	\$ 22.50
31003040	MYLAR FRONT PANEL POSI 3 USB S	SAR	\$ 63.30
31003052	SPARE, HEAD HARNESS	EUI	\$ 19.55
31003054	MAINTENANCE TOOL KIT, FRR	EUI	\$ 669.00
31003103	AIR PACK 2013 UPGRADE LABEL		\$ 7.30
31003113	LUBRICANT, CHRISTO LUBE, 2 OZ		\$ 87.00
31003121	TOOL, DUAL POINTER (MODIFIED)	SVC	\$ 67.40
31003123	TOOL, BONNET (MODIFIED)	SVC	\$ 78.60
31003174	TEMPEST DEMAND VALVE, TACTICAL		\$ 318.00
31003181	MULTI-CONFIGURATION STRAP		\$ 60.00
31003348	CHARGE CONNECTOR, 379 BAR		\$ 152.00
31003375	RETAINING RING PLIERS (S: HO)	SAR	\$ 68.40
31003380	O-RING PICK SET		\$ 10.30
31003385	MULTI-USE LADDER STRAP		\$ 177.00
31003386	PLUG, CHECK VALVE		\$ 4.50
31003402	U-CLIP,SUPPLY LINE		\$ 32.00
31003407	SIZING DOT,SM,AV3, GREEN		\$ 2.25

**Revision A**

Current revision date: December 1, 2018



**All prices listed herein supercede all other price lists, including (but not limited to) Scott master PDF price list. All prices are subject to change.**

**3M | Scott Fire & Safety Master Price List**

<b>ITEM</b>	<b>Product Description</b>	<b>Signal Code</b>	<b>List Price</b>
31003408	SIZING DOT,MD,AV3, BLACK		\$ 2.25
31003409	SIZING DOT,LG,AV3, RED		\$ 2.25
31003442	OUTER BOOT		\$ 5.40
31003448	GERMANIUM WINDOW		\$ 21.30
31003460	BEZEL BOLT UNC 6-32X1-1/4		\$ 2.75
31003482	TIC TO MASK WASHER		\$ 1.10
31003489	U-CLIP RETAINING PLATE		\$ 43.30
31003491	WAIST PAD CLIP,NON-JETTISON		\$ 9.00
31003648	CARABINER,RIT-PAK		\$ 25.40
31003679	SCOTT SIGHT TOOL		\$ 13.90
31003682	BRACKET BOLT UNC 6-32X.375		\$ 0.75
31003712	LABEL,AV3000HT,LENS,BLACKOUT		\$ 9.80
31003725	STABILIZER,JETTISON,X3		\$ 4.30
31003726	ANCHOR,STABILIZER,JETTISON,X3		\$ 8.50
31003728	NUT,FLANGE,SERRATED,10-32		\$ 2.20
31003732	CLEVIS,SHOULDER HARNESS,X3 PRO		\$ 19.10
31003739	STRAP,WAIST-SHLDR,X3 PRO		\$ 87.00
31003949	WAIST BELT ASSY, EZ-SC PRO, X3		\$ 850.00
31004005	O-RING STYLUS		\$ 22.00
31004006	O-RING TOOL		\$ 58.00
31004007	X3 STRAP, WAIST TO SHOULDER		\$ 81.00
31004024	LAUNDRY BAG, X3 PRO		\$ 15.50
31004029	WAIST PAD CLIP, FIXED		\$ 17.60
31004030	CARRIAGE BOLT		\$ 3.10
31004031	SPACER, CARRIAGE BOLT		\$ 8.30
33220-01	NUT, NYLON LOCK, 1/4-28	DIS	\$ 2.20

**Revision A**

Current revision date: December 1, 2018



**All prices listed herein supercede all other price lists, including (but not limited to) Scott master PDF price list. All prices are subject to change.**

**3M | Scott Fire & Safety Master Price List**

<b>ITEM</b>	<b>Product Description</b>	<b>Signal Code</b>	<b>List Price</b>
33316-014	SCREW, FLAT HD,.312X#4	DIS	\$ 2.20
33324-001	SCREW, PAN HEAD .125 X #2		\$ 2.20
33324-002	SCREW, PAN HEAD .188 X #2	EXP	\$ 2.20
33324-005	SCREW, PAN HEAD	EXP	\$ 2.30
33324-014	SCREW, PAN HEAD .312 X #4		\$ 2.20
33324-015	SCREW, PAN HEAD #4-40X.375,SS		\$ 2.20
33324-021	SCREW, PAN HEAD 1.000 X #4		\$ 2.20
33324-028	SCREW, PAN HEAD .375 X #6	EXP	\$ 2.20
33324-029	SCREW, PAN HEAD (10)	EXP	\$ 4.30
33324-032	SCREW,PAN HEAD PHILLIPS #6-32		\$ 2.20
33324-041	SCREW PAN HD .164 X .250		\$ 2.20
33324-123	SCREW, PAN HEAD #6-32 X 9/16	DIS	\$ 2.20
33335-022	SCREW, CAP, SOCKET HEAD	DIS	\$ 3.00
33354-002	SCREW TAPPING, #2 X .188"		\$ 2.00
33354-004	SCREW	EXP	\$ 2.30
33354-016	SCREW, TAPPING.312 X #6	SVC	\$ 2.20
33354-030	SCREW-TAPPING #8 X .500"	EXP	\$ 2.10
33354-057	SCREW-TAPPING .250" X .750"		\$ 2.30
33361-008	SCREW, CAP, SOCKET HEAD	SVC	\$ 2.20
33361-009	SCREW,CAP,SOCKET HD 4-40X250		\$ 2.20
33361-010	SCREW-CAP HEAD .375 X #4	DIS	\$ 2.20
33361-011	SCREW-CAP HEAD .5 X #4-40		\$ 2.20
33361-017	SCREW-CAP HEAD .375 X #6	DIS	\$ 2.20
33361-018	SCREW, CAP, SOCKET HEAD		\$ 2.20
33361-020	SCREW,CAP,SOCKET HEAD	DIS	\$ 2.20
33361-026	SCREW,CAP,SOCKET HEAD	EXP	\$ 2.20

**Revision A**

Current revision date: December 1, 2018



**All prices listed herein supercede all other price lists, including (but not limited to) Scott master PDF price list. All prices are subject to change.**

**3M | Scott Fire & Safety Master Price List**

<b>ITEM</b>	<b>Product Description</b>	<b>Signal Code</b>	<b>List Price</b>
33361-047	SCREW-CAP HEAD .375 X .250		\$ 2.20
33361-048	SCREW,CAP,SOCKET HD, 1/4 X 1/2		\$ 2.20
33361-050	SCREW,1/4-20X.75LONG		\$ 2.20
33361-055	SCREW,CAP,SOCKET HD1/4-20X1.75		\$ 2.50
33362-006	SCR-RDH THD TYPE A 2-32 X .63	EXP	\$ 2.50
33365-204	SCREW,SELF-TAPPING 6X.375 FLHD		\$ 2.20
33460-069	LOCK WASHER-#2		\$ 2.30
33460-071	LOCK WASHER (MS35333-71)		\$ 2.20
33460-072	LOCK WASHER-#8		\$ 2.20
33461-058	#6 LOCKWASHER		\$ 2.20
33481-003	PIN,SPRING .062OD X .250L		\$ 2.20
33481-004	PIN-SPRING .062OD X .312L	SVC	\$ 2.20
33481-007	PIN-SPRING .062OD X .500L	SVC	\$ 2.20
33481-107	PIN-SPRING .078OD X .500L		\$ 2.20
33481-115	PIN-SPRING .078OD X 1.000L	SVC	\$ 2.20
33481-213	PIN-SPRING .094OD X .875L	SVC	\$ 2.20
33481-307	PIN-SPRING		\$ 2.25
33481-311	PIN-SPRING		\$ 2.20
33488-003	CLAMP LOOP-STEEL PLAIN/CUSHION	EXP	\$ 3.25
33488-004	CLAMP LOOP-STEEL PLAIN/CUSHION	DIS	\$ 3.25
33488-034	CLAMP LOOP-STEEL PLAIN/CUSHION		\$ 4.40
33602-098	RING,RETAINING,INTERNAL,BASIC	DIS	\$ 5.40
3502-01	WASHER,THRUST	EXP	\$ 2.20
3502-02	WASHER,THRUST	EXP	\$ 2.20
3502-03	WASHER, THRUST	EXP	\$ 2.20
3504-01	WASHER,SPACER	EXP	\$ 2.20

**Revision A**

Current revision date: December 1, 2018



**All prices listed herein supercede all other price lists, including (but not limited to) Scott master PDF price list. All prices are subject to change.**

**3M | Scott Fire & Safety Master Price List**

<b>ITEM</b>	<b>Product Description</b>	<b>Signal Code</b>	<b>List Price</b>	
36176-00	PACKING PREFORM	DIS	\$	3.30
36477-00	PACKING PREFORM		\$	3.30
36596-28	DISC,BURST .0062 THICKNESS		\$	2.30
36596-35	DISC,BURST .0078 THICKNESS	EXP	\$	2.20
36596-48	DISC,BURST .0098 THICKNESS		\$	2.30
36596-50	DISC, BURST .0110 THICKNESS		\$	2.30
36596-72	DISC,BURST .0135 THICKNESS	EXP	\$	2.20
36596-87	DISC,BURST .0186 THICKNESS		\$	2.90
36682-01	SCREW,SELF-TAPPING,TRUSS HEAD		\$	2.20
36682-03	SCREW,SELF TAPPING,TRUSS HD		\$	2.20
36683-02	SCR,SELF-TAPPING,FLAT HEAD,REC	SVC	\$	2.20
36684-047	RING-RETAINING EXTERNAL HD	SVC	\$	5.40
36701-01	POPPET, SAFETY	SVC	\$	3.25
36705-01	RETAINER PACKING BACKUP	EXP	\$	3.30
36711-00	PACKING, PREFORMED, BUNA-N	EXP	\$	3.25
36713-00	VALVE PLUG & SEAT ASSY -KB-	DIS	\$	7.75
36715-00	BODY,SAFETY** *KB*		\$	16.20
36744-02	PACKING, PREFORMED		\$	3.25
36750-01	COVER, PRESSURE GAUGE	SVC	\$	4.40
36751-01	SPRING, WAVE WASHER		\$	3.60
36752-01	SPRING, HANDWHEEL	EXP	\$	3.25
36755-02	HANDWHEEL ASSEMBLY	DIS	\$	20.60
36765-01	LENS, PRESSURE GAUGE		\$	5.50
36814-00	PACKING, WASHER	EXP	\$	3.30
36862-02	PACKING,PREFORM .492ID X .039W	DIS	\$	5.50
36862-06	PACKING,PREFORM .256ID X .047W	EXP	\$	3.25

**Revision A**

Current revision date: December 1, 2018



**All prices listed herein supercede all other price lists, including (but not limited to) Scott master PDF price list. All prices are subject to change.**

**3M | Scott Fire & Safety Master Price List**

<b>ITEM</b>	<b>Product Description</b>	<b>Signal Code</b>	<b>List Price</b>
36862-10	PACKING,PREFORMED		\$ 9.00
36862-11	PACKING,PREFORM .250ID X .035W	DIS	\$ 4.80
36862-13	PACKING,PREFORMED		\$ 10.10
37058-01	SOCKET		\$ 3.25
37059-01	DRIVER		\$ 40.20
37061-01	WASHER, FLAT	EXP	\$ 2.40
37079-01	PACKING PERFORMED	DIS	\$ 3.25
37082-01	PACKING PERFORMED	EXP	\$ 3.25
37084-01	WASHER,SAFETY CAP		\$ 2.20
37090-02	WASHER, WEAR	EXP	\$ 2.20
37091-02	WASHER, PACKING**	EXP	\$ 2.20
37092-02	BONNET		\$ 23.80
37093-02	STEM, VALVE -KB-	DIS	\$ 18.30
40000035	2.5%NATURAL GAS CYLINDER(HM)		\$ 55.65
40000056	O RING D-LINE INLET/OUTLET FTG		\$ 2.25
40000211	CELL BLOCK FLAME ARRESTOR		\$ 3.70
40002800	S.S.PIPE PLUG	PHO	\$ 5.55
40008583	BULB,ASPIRATOR		\$ 11.80
40008654	ASPIRATOR BULB ASSY.		\$ 5.25
40009207	AN ADAPTER, BRASS		\$ 8.65
40012165	EI, SPLIT-LOCK WASHER (10)		\$ 0.10
40012648	JUMPER,MINIATURE	EXP	\$ 2.50
40013885	SENSOR REPLACEMENT- CO		\$ 302.00
40013975	ALKALINE "AA" BATTERY	SVC	\$ 2.30
40014092	REPLACEMENT N1-CAD BATTERY PK		\$ 143.00
40014439	EI PISTOL GRIP ASSEMBLY		\$ 127.00



**Revision A**

Current revision date: December 1, 2018



**All prices listed herein supercede all other price lists, including (but not limited to) Scott master PDF price list. All prices are subject to change.**

**3M | Scott Fire & Safety Master Price List**

<b>ITEM</b>	<b>Product Description</b>	<b>Signal Code</b>	<b>List Price</b>
40014444	EI, BALL BEARING (10)		\$ 5.70
40014447	EI, DETENT SPRING (10)		\$ 5.70
40014585	EI, HANDSTRAP PAD	DIS	\$ 17.80
40014588	EI, SWIVEL STUD		\$ 4.60
40014604	LOCKWASHER, INTERNAL TOOTH	EOL	\$ 2.20
40014635	EI,CABLE,2.5MM TO CIGARET PLUG	DIS	\$ 35.10
40014658	O-RING, SILICONE, LENS ASS'Y		\$ 3.60
40014777	AAA BATTERY, ALKALINE		\$ 2.35
40014827	EI, 12 FT. LONG CIGARETTE CORD	EOL	\$ 61.00
40014832	EAGLE IMAGER RECEIVER FOR WRLS		\$ 2,360.00
40014839	EI INTERFACE BOARD ASY W/VIDEO		\$ 308.00
40014900	(1) SIXTH SENSE THERMAL SENSOR		\$ 16.00
40014971	ANTENNA, MOBILE, 2.4-2.5 GHZ		\$ 102.00
40014973	EI MOBILE ANT.ASSY.2.4GHZ OMNI		\$ 337.00
40389-00	SOCKET & HOSE CLAMP ASSEMBLY		\$ 79.00
50004-15	SEALING COMPOUND "222"	EXP	\$ 21.20
50004-16	SEALING COMPOUND 242	EXP	\$ 69.00
50004-18	SEALING COMPOUND "271"	EXP	\$ 23.80
50004-20	SEALING COMPOUND 085	EXP	\$ 99.00
50011-00	TAPE,ANTISEIZE 1/4"	EXP	\$ 23.80
50521-00	KRYTOX	EXP	\$ 1,890.00
50527-00	LUBRICANT, KRYTOX 240AC	EXP	\$ 378.00
50576-02	LOCTITE 422 INSTANT ADHESIVE	EXP	\$ 98.00
50721-02	SEALING COMPOUND	EXP	\$ 24.90
50721-03	SEALING COMPOUND	EXP	\$ 97.00
50728-01	RHEOLUBE 719M	DIS	\$ 40.75

**Revision A**

Current revision date: December 1, 2018



**All prices listed herein supercede all other price lists, including (but not limited to) Scott master PDF price list. All prices are subject to change.**

**3M | Scott Fire & Safety Master Price List**

<b>ITEM</b>	<b>Product Description</b>	<b>Signal Code</b>	<b>List Price</b>
50729-01	LUBRICANT, SILICONE	DIS	\$ 236.00
50755-01	ADHESIVE/SEALANT 734 RTV	EXP	\$ 23.80
50756-01	LOCTITE, BLACK MAX 380	EXP	\$ 56.00
50757-02	LOCTITE, X-NMS, CLEAN-UP SOLV	EXP	\$ 71.00
50758-01	LUBRICANT	EXP	\$ 760.00
50785-01	SCREW		\$ 2.20
50785-02	PASE MOTION SNSR ASY SCREW(10)		\$ 2.10
50786-03	RING, ID BUTTON (BLUE)		\$ 13.75
50795-10	ADHESIVE, EPOXY, HYSOL E-05CL		\$ 48.90
50835-02	PASE CNSL PC BRD ASY SCREW(10)		\$ 2.10
50903-01	ADHESIVE, RTV 5900	EXP	\$ 192.00
50904-08	CLAMP,LOOP-STEEL PLAIN		\$ 5.50
50904-37	CLAMP,LOOP-STEEL,CUSHIONED		\$ 6.60
50904-39	CLAMP,LOOP STEEL,CUSHIONED		\$ 5.50
5500-7100	FLTR REFLS 10/PK, PLASTIC FOAM		\$ 18.10
55065-00	SOCKET SUPPLY HOSE		\$ 86.00
55622-00	PACKING, PREFORMED	EXP	\$ 3.25
55810-00	PACKING,PREFORM .07W X .114ID	EXP	\$ 3.25
56427-00	PACKING PREFORMED		\$ 3.25
56756-00	PLUG, 1/4" FPT HANSEN		\$ 10.90
56894-00	EYELET		\$ 3.25
56940-00	PACKING, PREFORMED	EXP	\$ 3.25
57120-05	RIVET,BLIND,DOMED HD,OPEN END		\$ 2.20
57120-09	RIVET,BLIND,DOMED HD,OPEN END		\$ 2.20
57251-00	PACKING, PREFORMED		\$ 3.25
57252-00	PACKING, PREFORMED		\$ 3.25

**Revision A**

Current revision date: December 1, 2018



**All prices listed herein supercede all other price lists, including (but not limited to) Scott master PDF price list. All prices are subject to change.**

**3M | Scott Fire & Safety Master Price List**

<b>ITEM</b>	<b>Product Description</b>	<b>Signal Code</b>	<b>List Price</b>
57253-00	PACKING, PREFORMED	DIS	\$ 3.25
57264-00	PACKING, PREFORMED	SVC	\$ 3.25
57518-00	PIN, SPRING	SVC	\$ 2.20
58298-00	VALVE,HIGH PRESS-PKD TYPE MS		\$ 87.00
58353-00	PISTON		\$ 86.00
58355-00	WASHER		\$ 2.40
58370-01	REDUCER ASSEMBLY		\$ 361.00
58651-00	PACKING, PREFORMED	EXP	\$ 3.25
58652-00	PACKING, PREFORMED	EXP	\$ 3.25
58857-00	PLUG		\$ 14.10
59274-00	PACKING, PREFORMED		\$ 3.25
59275-00	PACKING, PREFORMED		\$ 3.25
59276-00	RELIEF VALVE ASSY,(LOW PRESS.)		\$ 114.00
59277-00	PACKING, PREFORMED		\$ 3.25
59333-00	O RING		\$ 6.40
595132-01	LIBERTY O&M		\$ 27.30
595305-01	EZ-SCAPE PRO X3 UI	EXP	\$ 5.40
595353-01	SCOTT SIGHT QUICK START		\$ 37.25
59607-00	PACKING, PREFORMED	EXP	\$ 3.25
600310-00	POUCH,GAS MASK-CHIN STYLE		\$ 53.00
60158-00	ANTI-FOG PREPARATION		\$ 15.50
6388-02	MANIFOLD, RESPIRATOR		\$ 61.00
64152-02	VALVE ASSY		\$ 16.30
64197-01	VALVE, CHECK		\$ 5.25
6507-01	BUCKLE,SPRING ACTION		\$ 8.00
6816-00	PLUG 1/4" MPT HANSEN		\$ 13.00

**Revision A**

Current revision date: December 1, 2018



**All prices listed herein supercede all other price lists, including (but not limited to) Scott master PDF price list. All prices are subject to change.**

**3M | Scott Fire & Safety Master Price List**

ITEM	Product Description	Signal Code	List Price
6831-00	SOCKET		\$ 96.00
6835-00	SOCKET ASSY		\$ 130.00
7000205	FRR/GSRE FP DRNK INS SUBASSY 1		\$ 22.05
7000383	FRR MRPS ASSY		\$ 40.95
7000408	CAMELBAK HYDR ADPTR, W/O HOSE		\$ 42.00
7000409	SOURCE HYDR ADPTR, W/O HOSE		\$ 32.25
7000410	OUTSERT LENS TINT (BLACK) 1		\$ 57.75
7000411	OUTSERT LENS CLEAR 1		\$ 57.75
7000415	NET HEAD HARNESS 1		\$ 66.15
7000427	SPARE, FRR LVRE CVR W/ COMMS 1		\$ 12.40
7000448	FRR LOU CVR SW ASSY LONG		\$ 47.56
7000449	FRR LOU CVR SW ASSY SHORT		\$ 47.56
7000450	FRR LOU CVR SW ASSY L W/COMMS		\$ 47.80
7000451	FRR LOU CVR SW ASSY S W/COMMS		\$ 47.79
7000475	SPARE, FRR LOUVRE COVER 1		\$ 11.30
7000476	SPARE, FRR LVRE CVR - SW SL 1		\$ 10.50
7000477	SPARE, FRR LVRE CVR - SW LL 1		\$ 10.50
7000478	SPR, FFR LC W COMMS - SSL 1		\$ 11.30
7000479	SPR, FFR LC W COMMS - SLL 1		\$ 11.34
7000683	TEMPEST DMND VLV - HIGH ACT 1		\$ 265.00
7000689	FRR-SCBA ADAPTER		\$ 13.20
7000976	VPU - STANDALONE 1		\$ 473.00
7001212	ARTS, MASK DRNKNG TUBE ADPTR 1		\$ 25.75
7001248	FRR - SCBA KEY		\$ 5.25
7001249	DRINKING TAP STRAW 1		\$ 7.35
7001633	NATO CANTEEN CAP 1		\$ 10.70

**Revision A**

Current revision date: December 1, 2018



**All prices listed herein supercede all other price lists, including (but not limited to) Scott master PDF price list. All prices are subject to change.**

**3M | Scott Fire & Safety Master Price List**

<b>ITEM</b>	<b>Product Description</b>	<b>Signal Code</b>	<b>List Price</b>
7001862	FRR/GSR DYNAMIC MICROPHONE-ODU		\$ 309.00
7001863	FRR/GSR ELCTRET MICROPHONE-QR4		\$ 382.00
7420-108	ASSY, XCEL HALF HEAD HARNESS	PHO	\$ 10.80
7421-114	XCEL LG GREY HALF MASK RESP	PHO	\$ 36.30
7421-114V	XCEL LG GREY HALF MASK VM RESP	PHO	\$ 44.00
7421-411V	ASSY, XCEL HS SM HALF MASK VM	PHO	\$ 44.00
7421-412V	ASSY, XCEL HS S/M HALF MASK VM	PHO	\$ 44.00
7421-413V	ASSY, XCEL HS M/L HALF MASK VM	PHO	\$ 44.00
7421-414V	ASSY, XCEL HS LG HALF MASK VM	PHO	\$ 44.00
7421-511V	CASE, XCEL HS SM HALF MASK VM	PHO	\$ 860.00
7421-512V	CASE, XCEL HS S/M HALF MASK VM	PHO	\$ 860.00
7421-513V	CASE, XCEL HS M/L HALF MASK VM	PHO	\$ 860.00
7421-514V	CASE, XCEL HS LG HALF MASK VM	PHO	\$ 860.00
7421-PF1	XCEL SMALL PROBED FACE PIECE	PHO	\$ 58.00
7421-PF2	XCEL S/M PROBED FACE PIECE	PHO	\$ 58.00
7421-PF3	XCEL M/L PROBED FACE PIECE	PHO	\$ 58.00
7421-PF4	XCEL LARGE PROBED FACE PIECE	PHO	\$ 58.00
7422-BA1	OV,78CC, PAIR		\$ 15.50
7422-BB1	OV-P100,78CC PAIR		\$ 29.80
7422-CD1	742 CSCN/P100,120CC CARTRIDGE		\$ 36.10
7422-FC1	ENCLOSURE COVER, PAIR		\$ 14.80
7422-FC4	ENCLOSURE COVER, 5 PR/BX		\$ 75.00
7422-FE4	ENCLOSURE COV/RETAIN,5 PR/BX		\$ 108.00
7422-FG4	GASKET/ENCLOSURE COV, 5 PR/BX		\$ 131.00
7422-FN5	N-95 FILTER ELEMENT,50 PR/CASE		\$ 188.00
7422-FP1	MINI P100 FILTER, PAIR		\$ 13.40

**Revision A**

Current revision date: December 1, 2018



**All prices listed herein supercede all other price lists, including (but not limited to) Scott master PDF price list. All prices are subject to change.**

**3M | Scott Fire & Safety Master Price List**

ITEM	Product Description	Signal Code	List Price
7422-FP4	CARTON OF 80 PRS, 742 MINI		\$ 1,030.00
7422-FT1	TEST FIT ADAPTER		\$ 57.00
7422-FT2	TEST FIT ADAPTER		\$ 29.80
7422-GA1	AM,78CC, PAIR		\$ 16.60
7422-GB1	AM-P100, 78CC CARTRIDGE PAIR		\$ 30.80
7422-MA1	ASSY,742 MVCL 78cc CARTRIDGE		\$ 30.90
7422-MB1	ASSY,742 MVCL-P100 78cc CART		\$ 43.10
7422-PD1	TEDA-P100, 120CC, PAIR		\$ 46.60
7422-SC1	MPC, 120CC, PAIR		\$ 17.50
7422-SD1	MPC-P100, 120CC, PAIR		\$ 30.90
7422-WA1	AG, 78CC, PAIR		\$ 15.50
7422-WB1	AG-P100,78CC CARTRODGE PAIR		\$ 30.90
7422-YC1	OA, 120CC, PAIR		\$ 16.50
7422-YD1	OA-P100, 120CC, PAIR		\$ 30.80
8000001	LED SVC Kit-PZM		\$ 50.95
8000002	SCREW/HDWR Kit- SVC PZM		\$ 34.90
8000003	Tubing/Barb Kit, SVC PZM		\$ 88.20
8000004	Cable Tie Kit, SVC PZM		\$ 12.10
8000005	Cal Bottle Mount Kit, SVC PZM		\$ 106.00
8000-1100	FILAMENT, ACTIVE, RED, G		\$ 106.00
800030-02	COUPLING NUT ASSY		\$ 69.00
8000371	SC-RES-BDL-1YR	APS	\$ 331.00
8000372	SC-RES-BDL-2YR	APS	\$ 600.00
8000373	SC-RES-BDL-3YR	APS	\$ 850.00
8000374	SC-RES-BDL-4YR	APS	\$ 1,090.00
8000375	SC-RES-BDL-5YR	APS	\$ 1,330.00

**Revision A**

Current revision date: December 1, 2018



**All prices listed herein supercede all other price lists, including (but not limited to) Scott master PDF price list. All prices are subject to change.**

**3M | Scott Fire & Safety Master Price List**

<b>ITEM</b>	<b>Product Description</b>	<b>Signal Code</b>	<b>List Price</b>
8000401	SC-IMP-WIN-1YR	APS	\$ 1,260.00
8000402	SC-IMP-WIN-2YR	APS	\$ 2,520.00
8000403	SC-IMP-WIN-3YR	APS	\$ 3,780.00
8000404	SC-IMP-WIN-4YR	APS	\$ 5,040.00
8000405	SC-IMP-WIN-5YR	APS	\$ 6,300.00
8000-7200	METHANE BEAD		\$ 214.00
8000760	SC-IMP-100-VA-5YR	APS	\$ 525.00
8000-8090	DETECTOR ELEMENT, TLV	DIS	\$ 253.00
800198-00	COUPLING ASSY		\$ 243.00
8002434	MANF, SMART FILL ASSY		\$ 3,660.00
8002437	O-RING 0.551X0.070		\$ 1.10
8002441	RING, BACK-UP, SEAL		\$ 12.50
8002442	O-RING 0.301X0.070		\$ 4.25
8002446	VLV, FLOW CTRL ASSY		\$ 690.00
8002448	CYL, VLV, FLOW CTRL		\$ 108.00
8002456	O-RING, 0.739X0.070		\$ 1.50
8002461	CYL, REG		\$ 100.00
8002486	CAP, CTRL VLV		\$ 45.50
8002487	WASHER, SHAFT, CTRL VLV		\$ 5.50
8002488	SHAFT, CTRL VLV		\$ 10.30
8002490	NUT, CTRL VLV		\$ 8.25
8002491	SPG, CTRL VLV		\$ 3.60
8002493	VLV, CTRL		\$ 23.90
8002494	SEAT, CTRL VLV		\$ 14.50
8002496	O-RING, 0.614X0.070		\$ 1.10
8002497	SEAL SHAFT, CTRL VLV		\$ 0.75

**Revision A**

Current revision date: December 1, 2018



**All prices listed herein supercede all other price lists, including (but not limited to) Scott master PDF price list. All prices are subject to change.**

**3M | Scott Fire & Safety Master Price List**

ITEM	Product Description	Signal Code	List Price
8002500	ELBOW, PARKER 4-C5BU-S		\$ 26.00
8002555	SEAL, 0.549X0.103		\$ 4.25
8002611	RELIEF VLV 7500PSI ASME CODED		\$ 1,030.00
8002614	O-RING, 1.239X0.070		\$ 2.40
8002617	SPOOL, VLV, PRSR CTRL		\$ 66.00
8002618	SPOOL,VLV,PRES CTRL ASSEMBLY		\$ 87.00
8002619	VLV, PRES CTRL		\$ 11.50
8002620	O-RING, 1.614X0.070		\$ 2.75
8002623	MANF MOD MULTI-PRES CTRL ASSY		\$ 5,340.00
8002633	XDUCER, PRES, 7.5KPSI		\$ 150.00
8002635	MANF,CTRL W/AUTO-CASCADE STG		\$ 9,570.00
8002637	PLUG, O-RING W/CK VLV		\$ 27.40
8002638	PLUG,O-RING W/CHECK VLV ASSY		\$ 121.00
8002667	FILTER, 5 MICRON		\$ 26.25
8002668	VLV, END, FEMALE		\$ 8.00
8002680	1/8 PRESTOLOK UNION TEE		\$ 18.80
8002688	MANF ASSY,MODULE,DUAL PRES		\$ 3,130.00
8002695	RESTRICTOR.047 5KPSI 1/4NPTMF		\$ 45.70
8002697	CONN, 1/4X7/16-20 SAE		\$ 10.30
8002715	SWITCH, EMERGENCY STOP, R/A		\$ 154.00
8002718	ADPT P-LOK 1/8 TUBE 10-32		\$ 10.30
8002719	CONN, 1/4 TUBE X 10-32 STR		\$ 13.90
8002720	ELBOW 90DEG P-LOK1/8 TUBE10-32		\$ 22.40
8002723	GAGE 10KPSI 7/16-SAE O-RING		\$ 185.00
8002743	XDUCER, PRES, 7.5KPSI		\$ 150.00
8002744	XDUCER, PRES, 3KPSI		\$ 150.00



**Revision A**

Current revision date: December 1, 2018



**All prices listed herein supercede all other price lists, including (but not limited to) Scott master PDF price list. All prices are subject to change.**

**3M | Scott Fire & Safety Master Price List**

<b>ITEM</b>	<b>Product Description</b>	<b>Signal Code</b>	<b>List Price</b>
8002745	XDUCER, PRES, 300PSI		\$ 150.00
8002761	END SPRT, CVR, STG		\$ 56.00
8002767	SIDE PANEL, R, STG		\$ 215.00
8002812	VAVLE, SOLENOID,12V		\$ 175.00
8002814	KIT,PARTS,SRS 635 REG ASSY		\$ 90.00
8002817	KIT,PARTS,1247 REG ASSY		\$ 54.00
8002879	O-RING, 0.364X0.070		\$ 0.90
8002881	REG,REDUCING ASSEMBLY		\$ 311.00
8002882	O-RING, 0676X0.070		\$ 1.30
8002914	E TO X SERIES BATTERY UPGRADE		\$ 46.25
8002917	STD K90 LEMON, VO, PYRO		\$ 11,360.00
8002926	X380 DESKTOP CHARGER		\$ 244.00
8002927	X380 FAST ATTACK CHARGER		\$ 830.00
8002928	X380 HARD SIDED CASE - CAMERA		\$ 262.00
8002929	X380 NFPA COMPLIANT BATTERY		\$ 187.00
8002930	X380 RETRACTABLE LANYARD		\$ 133.00
8002931	DRIVE-AWAY DETECTION		\$ 425.00
8002932	ELITE XRHR TRUCK CHARGER		\$ 860.00
8002933	ELITE XRHR LANYARD		\$ 134.00
8002936	SUPERCELL BATTERY ELITE XRHR		\$ 217.00
8002937	CABLE, USB A TO MINI USB		\$ 9.10
8002938	EXTENDED BATTERY, SUPERCELL		\$ 268.00
8002939	K90 PELI-INSERT, US VERSION		\$ 88.00
8002940	K90 AC WALL ADAPTER FOR CHARGE		\$ 13.50
8002941	K90 CONDITIONING CHARGER SET A		\$ 186.00
8002942	FAST ATTACK POWER CABLE		\$ 35.30

**Revision A**

Current revision date: December 1, 2018



**All prices listed herein supercede all other price lists, including (but not limited to) Scott master PDF price list. All prices are subject to change.**

**3M | Scott Fire & Safety Master Price List**

ITEM	Product Description	Signal Code	List Price
8002943	DRIVE AWAY PIGTAIL CABLE		\$ 19.40
8002944	TAC GRIP ASSEMBLY (NO LASER)		\$ 206.00
8002945	KINETICS CASE - K SERIES		\$ 412.00
8002946	FA AUXILIARY CHARGER CABLE		\$ 21.75
8002947	ELITE XRHR BOX WITH INSERT		\$ 61.00
8002948	X-SERIES GRIP PAD		\$ 40.10
8002949	X-SERIES RUBBER TOP COVER		\$ 76.00
8002950	CARABINEER, BLK DIAMOND, 30272		\$ 21.75
8002951	MAIN LENS GASKET		\$ 6.25
8002952	RETAINER, STRAP BLOCK FOR F/A		\$ 24.80
8002956	X-SERIES CARABINEER		\$ 10.90
8002957	X-SERIES QUICK CONNECT		\$ 16.25
8002958	NIMH BATTERY - K90		\$ 176.00
8002959	NECKSTRAP - AN		\$ 112.00
8002960	K90 SIDE STRAP		\$ 23.75
8002961	REAR WINDOW SUB ASSEMBLY - 3 B		\$ 900.00
8002962	REAR WINDOW SUBASSY, 3 BUTTON		\$ 64.00
8002963	X SERIES POWER PAK		\$ 29.00
8002964	E380 BATTERY - SERIALIZED		\$ 193.00
8002965	X380 STANDARD BATTERY		\$ 155.00
8002969	E380 DESK CHARGER ASSEMBLY		\$ 217.00
8002971	E-SERIES CASE ASSY WITH INSERT		\$ 206.00
8002972	E-SERIES, BLACK CARDBD ASSY		\$ 59.00
8002973	X SERIES BLACK BOX ASSY C/FA		\$ 99.00
8002975	FAP AC ADAPTER		\$ 178.00
8002976	AC/DC POWER SUPPLY 3.0 AMP		\$ 58.00

**Revision A**

Current revision date: December 1, 2018



**All prices listed herein supercede all other price lists, including (but not limited to) Scott master PDF price list. All prices are subject to change.**

**3M | Scott Fire & Safety Master Price List**

ITEM	Product Description	Signal Code	List Price
8002977	AXL 5MM ALLEN LONG ARM HEX KEY		\$ 2.10
8002978	2MM ALLEN WRENCH- E380		\$ 11.60
8002979	1.5MM ALLEN WRENCH		\$ 21.20
8002980	LABEL - BATTERY 7.4V LI-ION		\$ 9.60
8002981	E380 LOGO LABEL		\$ 9.60
8002982	E380 LOGO LABEL		\$ 10.60
8002983	E-SERIES TRUCK CHARGER LABEL		\$ 10.60
8002984	LABEL CHARGER TOP		\$ 5.25
8002985	LABEL CHARGER BASE		\$ 6.25
8002986	E-SERIES NFPA LABEL		\$ 6.25
8002987	LASER WINDOW STICKER		\$ 8.00
8002988	LABEL, E-SERIES HANDLE LED		\$ 15.80
8002989	LABEL-BATTERY 7.4 LI-ION		\$ 15.80
8002990	LABEL - X-SERIES NFPA & ANSI		\$ 5.40
8002991	LABEL - X-SERIES SERIAL NUMBER		\$ 2.20
8002992	E380 QUICK START GUIDE		\$ 4.20
8002994	X-SERIES QUICKSTART QUIDE		\$ 5.30
8002995	F/A CAMERA STRAP-3016-72-0001		\$ 16.50
8002996	VISOR HAND PAD - ISG/INFRASYS		\$ 96.00
8002997	E SERIES SIDE STRAP KIT		\$ 234.00
8002998	DRIVEAWAY VELCRO		\$ 2.20
8002999	FAST ATTACK PLUS POWER PAK XR		\$ 33.50
8003001	K90 PELI CASE WITH INSERT		\$ 268.00
8003002	BATTERY REFURBISHMENT		\$ 122.00
8003003	BATTERY REFURB EXT SUPER CELL		\$ 122.00
8003004	BATTERY REFURB SUPER CELL		\$ 123.00

**Revision A**

Current revision date: December 1, 2018



**All prices listed herein supercede all other price lists, including (but not limited to) Scott master PDF price list. All prices are subject to change.**

**3M | Scott Fire & Safety Master Price List**

ITEM	Product Description	Signal Code	List Price
8003005	K90 THERMAL IMAGER VISOR		\$ 71.00
8003006	K90 O-RING BASE ASSEMBLY		\$ 14.50
8003007	COMBO BATTERY/CHARGER KIT		\$ 433.00
8003008	K90 FPA LENS ASSEMBLY - THREE		\$ 820.00
8003009	AA BATTERY PACK ASSY- K90	EOL	\$ 145.00
8003010	PISTOL GRIP K-90		\$ 382.00
8003011	ELITE AA BATTERY ASSEMBLY	EOL	\$ 290.00
8003012	E380 SIDE STRAPS		\$ 72.00
8003015	K90 PYROMETER TEFLON RING		\$ 21.75
8003016	K90 MAIN LENS TEFLON RING		\$ 48.50
8003017	K90 PYRO-RING GASKET		\$ 4.20
8003018	K90 USA BASE ASSEMBLY MII		\$ 880.00
8003019	K90 HANDLE ASSEMBLY, MTI		\$ 351.00
8003020	K90 SHELL, PVO MII, LEMON/ZOOM	EOL	\$ 1,050.00
8003021	K90 VIDEO OVERLAY CAMERA	EOL	\$ 880.00
8003022	K90 PYROMETER BLOCK		\$ 89.00
8003023	K90 PYROMETER BRACKET		\$ 48.50
8003024	X380N V-01		\$ 11,100.00
8003025	X380N V-02		\$ 11,100.00
8003026	X380N V-03		\$ 10,340.00
8003027	X380N V-04		\$ 10,340.00
8003028	X380N V-05		\$ 10,600.00
8003029	X380N V-06		\$ 10,600.00
8003030	X380N V-07		\$ 10,910.00
8003031	X380N V-08		\$ 10,910.00
8003032	X380N V-09		\$ 11,980.00

**Revision A**

Current revision date: December 1, 2018



**All prices listed herein supercede all other price lists, including (but not limited to) Scott master PDF price list. All prices are subject to change.**

**3M | Scott Fire & Safety Master Price List**

ITEM	Product Description	Signal Code	List Price
8003033	X380N V-10		\$ 11,980.00
8003034	X380N V-11		\$ 12,250.00
8003035	X380N V-12		\$ 12,250.00
8003036	X380N V-13		\$ 12,550.00
8003037	X380N V-14		\$ 12,550.00
8003038	X380N V-15		\$ 12,890.00
8003039	X380N V-16		\$ 12,890.00
8003040	X380 3B V-01		\$ 9,380.00
8003041	X380 3B V-02		\$ 9,380.00
8003042	X380 3B V-03		\$ 8,580.00
8003043	X380 3B V-04		\$ 8,580.00
8003044	X380 3B V-05		\$ 8,880.00
8003045	X380 3B V-06		\$ 8,880.00
8003046	X380 3B V-07		\$ 9,190.00
8003047	X380 3B V-08		\$ 9,190.00
8003048	X380 3B V-09		\$ 10,230.00
8003049	X380 3B V-10		\$ 10,230.00
8003050	X380 3B V-11		\$ 10,530.00
8003051	X380 3B V-12		\$ 10,530.00
8003052	X380 3B V-13		\$ 10,840.00
8003053	X380 3B V-14		\$ 10,840.00
8003054	X380 3B V-15		\$ 11,180.00
8003055	X380 3B V-16		\$ 11,180.00
8003056	X380 5B V-01		\$ 10,000.00
8003057	X380 5B V-02		\$ 10,000.00
8003058	X380 5B V-03		\$ 9,070.00

**Revision A**

Current revision date: December 1, 2018



**All prices listed herein supercede all other price lists, including (but not limited to) Scott master PDF price list. All prices are subject to change.**

**3M | Scott Fire & Safety Master Price List**

ITEM	Product Description	Signal Code	List Price
8003059	X380 5B V-04		\$ 9,070.00
8003060	X380 5B V-05		\$ 9,410.00
8003061	X380 5B V-06		\$ 9,410.00
8003062	X380 5B V-07		\$ 9,770.00
8003063	X380 5B V-08		\$ 9,770.00
8003064	X380 5B V-09		\$ 10,720.00
8003065	X380 5B V-10		\$ 10,720.00
8003066	X380 5B V-11		\$ 11,060.00
8003067	X380 5B V-12		\$ 11,060.00
8003068	X380 5B V-13		\$ 11,420.00
8003069	X380 5B V-14		\$ 11,420.00
8003070	X380 5B V-15		\$ 11,970.00
8003071	X380 5B V-16		\$ 11,970.00
8003072	X380 HARD SIDED CASE - C & DC		\$ 187.00
8003129	INSERT, K90 HANDLE RUBBER		\$ 4.25
8003136	BRACKET, PYRO L	DIS	\$ 54.00
8003137	VO LENS		\$ 158.00
8003142	CHARGER BASE, K90		\$ 168.00
8003146	CONNECTOR, BNC		\$ 114.00
8003155	ELITE INTERFACE BD NTSC		\$ 361.00
8003157	BUTTON, RED		\$ 2.10
8003162	GASKET, FRONT LENS		\$ 4.25
8003167	SHELL, ELITE		\$ 560.00
8003168	BLOCK		\$ 55.00
8003169	VO LENS		\$ 200.00
8003170	CASE, K90 PELI (RECOMMENDED)		\$ 273.00

**Revision A**

Current revision date: December 1, 2018



**All prices listed herein supercede all other price lists, including (but not limited to) Scott master PDF price list. All prices are subject to change.**

**3M | Scott Fire & Safety Master Price List**

ITEM	Product Description	Signal Code	List Price
8003174	SWITCH, ON/OFF		\$ 22.10
8003178	PLATE, REAR		\$ 27.30
8003180	BLOCK, VO BORESIGHT		\$ 44.10
8003181	LENS ASSEMBLY		\$ 389.00
8003184	BUTTON, ENGRAVED TX		\$ 27.30
8003185	BUTTON, ENGRAVED VO		\$ 16.80
8003186	BUTTON, ENGRAVED X2		\$ 16.80
8003187	LCD DRIVER, NTSC		\$ 116.00
8003188	LCD		\$ 189.00
8003189	CABLE ASSY, LCD DRIVER		\$ 23.10
8003191	BRACKET, MOUNTING		\$ 4.25
8003192	WINDOW, VO		\$ 17.90
8003193	WINDOW, SHELL		\$ 44.10
8003198	BLOCK, PYRO ANGLE	DIS	\$ 54.00
8003200	BATTERY PACK, K90 AA (RECOMMEN		\$ 147.00
8003204	RING, FOCUS		\$ 32.00
8003205	NEW PART NUMBER K01MAD015		\$ 320.00
8003206	COVER, K90 SWITCH		\$ 66.00
8003209	WINDOW, BACKPLATE		\$ 32.60
8003212	O-RING , CASE SEALING		\$ 17.90
8003218	FPGA BOARD		\$ 483.00
8003219	INTERFACE BOARD	DIS	\$ 221.00
8003221	WINDOW, GERMANIUM		\$ 179.00
8003224	ADAPTER, AC		\$ 38.90
8003228	GASKET, FRONT RING		\$ 6.30
8003229	RETAINER		\$ 25.25

**Revision A**

Current revision date: December 1, 2018



**All prices listed herein supercede all other price lists, including (but not limited to) Scott master PDF price list. All prices are subject to change.**

**3M | Scott Fire & Safety Master Price List**

ITEM	Product Description	Signal Code	List Price
8003230	BOOT, FRONT RUBBER		\$ 40.00
8003231	CASTING, FRONT RING		\$ 147.00
8003232	O RING		\$ 2.10
8003234	3.5" DRIVER BOARD PCB NTSC		\$ 210.00
8003235	CABLE ASSY, LCD DRIVER CONNECT		\$ 9.50
8003236	CONTACTS, FAST ATTACK		\$ 60.00
8003238	PLATE, K80 HANDLE MOUNTING		\$ 65.00
8003239	CLAMP, D-RING		\$ 27.30
8003242	MAGNIFIER LENS		\$ 116.00
8003251	CASE, CARD BOARD CARRYING		\$ 16.00
8003258	BUTTON, RED		\$ 21.75
8003259	BUTTON, YELLOW		\$ 21.75
8003260	BOARD BNC EMC		\$ 24.80
8003261	CONNECTOR, BNC		\$ 24.80
8003262	LEAD ASSEMBLY		\$ 67.00
8003265	D RING		\$ 2.10
8003266	POWER SUPPLY BOARD, VOX		\$ 423.00
8003270	HEAD BOARD ASSY	DIS	\$ 620.00
8003271	BRACKET, PCB		\$ 35.10
8003272	GASKET, BACKPLATE WINDOW		\$ 19.60
8003273	CABLE CLIP		\$ 2.10
8003274	COVER, SWITCH		\$ 88.00
8003275	EMC BOARD		\$ 28.90
8003276	VISOR ASSY W/STRAPS		\$ 258.00
8003278	PILLAR, M2.5		\$ 8.50
8003280	FOAM, VOX, LH		\$ 130.00



**Revision A**

Current revision date: December 1, 2018



**All prices listed herein supercede all other price lists, including (but not limited to) Scott master PDF price list. All prices are subject to change.**

**3M | Scott Fire & Safety Master Price List**

<b>ITEM</b>	<b>Product Description</b>	<b>Signal Code</b>	<b>List Price</b>
8003281	FOAM, VOX, RH		\$ 130.00
8003282	BOX CARRYING CASE		\$ 5.25
8003283	INSERT FOR BOX CARRYING CASE		\$ 3.10
8003286	CASSETTE, SUPERCELL & EXT. SUP		\$ 114.00
8003288	PYRO BLOCK		\$ 95.00
8003291	3MM GASKET SHIELDING		\$ 9.30
8003292	5MM GASKET SHIELDING		\$ 13.50
8003326	BLACK CONTACT PLATE		\$ 34.75
8003331	FA 12DC WIRING HARN.		\$ 25.80
8003332	FA CHARGING HARNESS		\$ 4.20
8003333	BACKPLATE PAD		\$ 3.10
8003337	PILLAR,M2.0		\$ 8.50
8003344	K90 PYRO PLUG		\$ 28.40
8003348	HANDLE MOUNT ASSEMBLY		\$ 168.00
8003352	SUTTER BUSHING		\$ 33.60
8003354	LCD / DRIVER BD ASSEMBLY		\$ 389.00
8003355	DRIVER CABLE (362)		\$ 23.10
8003357	VC PLUS BOARD		\$ 2,050.00
8003360	LED ( 258 ) CABLE		\$ 5.25
8003361	DVR CABLE		\$ 22.75
8003362	DVR USB CABLE		\$ 22.75
8003366	E-SERIES FA POWER CABLE		\$ 55.00
8003367	CABLE ASSY, R/YELL W/PCB		\$ 10.30
8003368	CABLE ASSY, POWER BUTTON		\$ 14.50
8003369	CABLE ASSY, LCD & POWER		\$ 19.60
8003378	PUSH BUTTON - GREEN		\$ 25.80

**Revision A**

Current revision date: December 1, 2018



**All prices listed herein supercede all other price lists, including (but not limited to) Scott master PDF price list. All prices are subject to change.**

**3M | Scott Fire & Safety Master Price List**

<b>ITEM</b>	<b>Product Description</b>	<b>Signal Code</b>	<b>List Price</b>
8003379	BATTERY CONTACT GASKET		\$ 9.30
8003381	O-RING 1MM WIDTH, 6MM ID ( SET		\$ 7.30
8003384	TAPPEX TYPE 001M3 INSERT		\$ 10.30
8003385	BRASS INSERT, 1/4-20 TAPPEX		\$ 2.10
8003386	Cable Assy,Housing - Black		\$ 5.25
8003387	Cable Assy, Housing - Red		\$ 5.25
8003388	Cable Assy, Housing - Yellow		\$ 9.30
8003389	Cable Assy, Housing - Orange		\$ 5.25
8003390	Cable Assy, Housing - White		\$ 9.30
8003391	Cable Assy, Housing - Blue		\$ 9.30
8003392	Cable Assy, Housing - Violet		\$ 5.25
8003393	Cable Assy, Hirose Conn		\$ 89.00
8003394	PLUNGER SPRING CONTACT (SET OF	DIS	\$ 114.00
8003395	E-SERIES ARM WIRE		\$ 54.00
8003396	E-SERIES CONTACT SET (4)		\$ 51.00
8003398	STRAP W/VELCRO HOOK		\$ 14.50
8003399	CLAMP,K-SERIES D-RING		\$ 33.00
8003400	PLATE,K-SERIES MOUNT		\$ 80.00
8003401	SPARTAN 6 FPGA BOARD		\$ 485.00
8003402	E-SERIES SIDE HANDLE - OUTSIDE		\$ 11.60
8003403	USB MINI B RECEPTACLE		\$ 3.10
8003406	REAR WINDOW		\$ 186.00
8003408	BATTERY CELL 2600 MAH	NFI	\$ 46.40
8003409	HANDLE FIXING OUTER		\$ 11.40
8003411	FRONT RING		\$ 17.80
8003412	GASKET MAIN		\$ 22.25

**Revision A**

Current revision date: December 1, 2018



**All prices listed herein supercede all other price lists, including (but not limited to) Scott master PDF price list. All prices are subject to change.**

**3M | Scott Fire & Safety Master Price List**

<b>ITEM</b>	<b>Product Description</b>	<b>Signal Code</b>	<b>List Price</b>
8003413	GRIP PAD		\$ 21.20
8003414	VISOR-ELITE E380		\$ 24.30
8003415	4"FLEX CABLE-LONG		\$ 30.50
8003416	E-SERIES INTERFACE BOARD		\$ 173.00
8003417	E380 LCD & CHASSIS ASSY.		\$ 580.00
8003419	E-SERIES SIDE HANDLE - OUTSIDE		\$ 14.75
8003420	LABEL,HI-RES,YELLOW FLUORESCEN		\$ 4.20
8003422	LABEL,YELLOW FLUORESCENT		\$ 4.20
8003423	CONTACT SPACERS (SET OF 6)		\$ 4.20
8003424	BATTERY CONTACT PCB		\$ 21.20
8003427	XR / HR FRONT CASE GASKET		\$ 22.75
8003429	CHASSIS SPARTAN6 XR / HR		\$ 79.00
8003433	X380 LCD CABLE		\$ 18.30
8003436	K90 FOLDED OPTIC ASSEMBLY		\$ 570.00
8003437	K90 CAMERA CONTROLLER		\$ 464.00
8003441	X380 FLEX CABLE ( SHORT )		\$ 14.10
8003442	LED LABEL		\$ 8.80
8003443	EFA LED CABLE		\$ 13.75
8003444	EFA SERIAL LABEL		\$ 7.50
8003446	XFA SIDE LABEL		\$ 13.90
8003450	BATTERY CHARGER PCB		\$ 136.00
8003451	XFA CONTACT BLOCK		\$ 48.90
8003481	FA WEBBING HOOK		\$ 11.75
8003482	FA CHARGER BASE PLATE		\$ 72.00
8003483	FA BAR NUT		\$ 8.50
8003484	FA SHELL		\$ 77.00

**Revision A**

Current revision date: December 1, 2018



**All prices listed herein supercede all other price lists, including (but not limited to) Scott master PDF price list. All prices are subject to change.**

**3M | Scott Fire & Safety Master Price List**

<b>ITEM</b>	<b>Product Description</b>	<b>Signal Code</b>	<b>List Price</b>
8003485	CHARGE CONTACT POGO PIN		\$ 16.25
8003486	FA STRAP		\$ 14.40
8003487	METAL PLATE(LOGO)		\$ 12.30
8003488	2 PIN MINI CONN. LUGS		\$ 10.90
8003489	CIRCUIT PANEL MOUNT		\$ 6.50
8003490	DRAW LATCH		\$ 7.75
8003491	FA RED LED CABLE		\$ 17.60
8003492	FA GREEN LED CABLE		\$ 19.70
8003493	FA YELLOW LED CABLE		\$ 17.80
8003494	CAMERA LED INDICATOR		\$ 13.00
8003495	SPARE BATT.LED INDICATOR		\$ 8.50
8003496	POWER LED INDICATOR		\$ 8.50
8003497	1"FOOTMAN'S LOOP		\$ 1.10
8003498	FA CHARGER PCB		\$ 101.00
8003499	FA SERIAL NUMBER		\$ 8.50
8003500	LASER DIODE		\$ 35.10
8003632	MANF,MOD,MULTI-PRES		\$ 5,500.00
8003638	COVER, STORAGE, 4 CYL, RIGHT		\$ 410.00
8003699	X380N NFPA NO BATTERIES F		\$ 10,820.00
8003700	X380N NFPA NO BATTERIES C		\$ 10,820.00
8003707	TRADE X3803B KIT KSER/XR F	TIO	\$ 7,990.00
8003708	TRADE X3803B KIT KSER/XR C	TIO	\$ 4,840.00
8003709	TRADE X3803B KT KSER/XR F W1	TIO	\$ 9,670.00
8003710	TRADE X3803B KT KSER/XR C W1	TIO	\$ 9,670.00
8003711	TRADE X3803B KIT XRHR/E380 F	TIO	\$ 5,780.00
8003712	TRADE X3803B KIT XRHR/E380 C	TIO	\$ 5,780.00

**Revision A**

Current revision date: December 1, 2018



**All prices listed herein supercede all other price lists, including (but not limited to) Scott master PDF price list. All prices are subject to change.**

**3M | Scott Fire & Safety Master Price List**

<b>ITEM</b>	<b>Product Description</b>	<b>Signal Code</b>	<b>List Price</b>
8003713	TRADE X3803B KT XRHR/E380 F W1	TIO	\$ 7,450.00
8003714	TRADE X3803B KT XRHR/E380 C W1	TIO	\$ 7,450.00
8004099	SCW SKT HD CAP 7/16-14X3.5 SS		\$ 12.90
8004109	FILTER, CFR22 TAC-1		\$ 42.00
8004173	AIR SAMPLE FLOW CTRL VLV		\$ 27.90
8004224	3PLCONW/AC COIL60A,72A,85A,97A		\$ 1,283.00
8004260	STG VERT 4 CYL C/S ASSY		\$ 15,870.00
8004290	EN EZ FLO W LONG HOSE		\$ 560.00
8004295	SENTRY RFID BOARD ASSEMBLY		\$ 254.00
8004333	cOMPR CVR FRONT ASSY		\$ 1,880.00
8004334	cOMPR CVR FRONT ASSY		\$ 1,930.00
8004368	PANEL MNT.INLIN VALVE 7000 PSI		\$ 157.00
8004375	REG. ASSY. 7000PSI-350PSI OUT		\$ 2,060.00
8004380	REG. ASSY, 7000PSI-6000PSI-OUT		\$ 2,220.00
8004383	PRESS. REG. MOD. 1575-6000PSI		\$ 712.00
8004384	45 DEG ELBOW,37 DEG FLARE M F		\$ 15.30
8004414	MANF,MODULE,DUAL-PRES		\$ 3,550.00
8004421	CYL, 3000 PSI OXY DOT/TC		\$ 570.00
8004440	RA W/SENTRY S/F & M/P		\$ 28,230.00
8004442	RA W/SENTRY S/F & D/P		\$ 27,190.00
8004533	BELT, 20HP COMPR		\$ 49.90
8004537	MANF,PURGE/SAMPLE ASSEMBLY		\$ 5,490.00
8004545	PC CONTROLLER - PANTRY		\$ 2,810.00
8004553	HA 20HP 208VAC 60HZ 3PH		\$ 43,260.00
8004557	HA 10HP 208VAC 60HZ 3PH		\$ 32,960.00
8004561	HARNESS, I/O - RA		\$ 1,740.00

**Revision A**

Current revision date: December 1, 2018



**All prices listed herein supercede all other price lists, including (but not limited to) Scott master PDF price list. All prices are subject to change.**

**3M | Scott Fire & Safety Master Price List**

<b>ITEM</b>	<b>Product Description</b>	<b>Signal Code</b>	<b>List Price</b>
8004572	HARNESS,INTERCONNECT, PANTRY		\$ 3,290.00
8004579	SENSOR ASSEMBLY CO		\$ 640.00
8004615	ASSY, DECON FILTER ADAPTER		\$ 187.00
8004616	RESCUE WHIP		\$ 1,730.00
8004617	CHG ADPTR, EURO, 379 BAR		\$ 1,160.00
8004618	CHG ADPTR, US, CGA347		\$ 1,160.00
8004619	CONT, STORAGE, W/ FOAM INSERTS		\$ 1,340.00
8004620	EXTENSION KIT, 5510 BACKPACK		\$ 112.00
8004638	BATTERY SPEED LOADER CR123		\$ 610.00
8004639	ASSEMBLY - MASK INTERFACE		\$ 115.00
8004683	COMPR LWR HRNS, PLC TO COMPR		\$ 910.00
8004707	PROXIMITY SENSOR HRNS		\$ 730.00
8004748	SC-SAM-APP-1YR	APS	\$ 560.00
8004749	SC-SAM-PRD-100-1YR	APS	\$ 560.00
8004750	SC-SAM-PRD-500-1YR	APS	\$ 1,000.00
8004751	SC-SAM-PRD-1000-1YR	APS	\$ 1,330.00
8004752	SC-SAM-PRD-2000-1YR	APS	\$ 1,550.00
8004753	SC-SAM-PRD-MAX-1YR	APS	\$ 1,660.00
8004794	EN EZ FLO & CEJN HOSE		\$ 580.00
8004797	EN EZ FLO CBRN & LONG HOSE		\$ 1,120.00
8004798	EN EZ FLO CB & CEJN HOSE		\$ 1,120.00
8004810	MASK ADAPTER, 40 MM DIN		\$ 131.00
8004815	ASSY, HOSE,34" 7KPSI		\$ 630.00
8004816	ASSY, HOSE,28" 7KPSI		\$ 610.00
8004817	ASSY, HOSE,80" 7KPSI		\$ 770.00
8004818	ASSY, HOSE,38" 7KPSI		\$ 640.00

**Revision A**

Current revision date: December 1, 2018



**All prices listed herein supercede all other price lists, including (but not limited to) Scott master PDF price list. All prices are subject to change.**

**3M | Scott Fire & Safety Master Price List**

<b>ITEM</b>	<b>Product Description</b>	<b>Signal Code</b>	<b>List Price</b>
8004821	BRKT, PROXIMITY SENSOR		\$ 58.00
8004822	T BRANCH, CLIPPARD		\$ 77.00
8004832	I/O,INPUT,8-PT TERM,T1K-08ND3		\$ 287.00
8004833	I/OCUR INPUT 8-CH T1F-08AD-1		\$ 1,150.00
8004834	ISO DIS OUTPUTS,T1H-08TDS		\$ 670.00
8004836	CONTR ETHERNET T1H-DM1E		\$ 1,810.00
8004854	HA 10HP 230VAC 60HZ 3PH		\$ 32,960.00
8004856	HA 10HP 208VAC 60HZ 1PH		\$ 33,580.00
8004858	HA 10HP 230VAC 60HZ 1PH		\$ 33,580.00
8004864	HUSH AIR,10HP,460VAC,60HZ,3PH		\$ 32,960.00
8004876	HA 20HP 230VAC 60HZ 3PH		\$ 43,260.00
8004882	HUSH AIR,20HP,460VAC,60HZ,3PH		\$ 43,260.00
8004886	STG VERT 3 CYL CASCADE ASSY		\$ 12,950.00
8004888	STG VERT 2 CYL C/S ASSY		\$ 10,040.00
8004891	RA W/SENTRY S/F D/P W/O RFID		\$ 23,000.00
8004894	RA W/SENTRY S/F,M/P,W/O RFID		\$ 24,050.00
8004927	FULL SIZE TERMINAL BASE		\$ 287.00
8004940	RLF VLV7500PSI ASME 1/4-18 NPT		\$ 1,030.00
8004943	RIVET,SNAP,NYLON,.16" DIA		\$ 3.20
8004948	RIVET,PUSH-IN, NYLON,.19" DIA		\$ 3.20
8004956	HARNESS,INTERCONNECT 25FT		\$ 431.00
8004963	ASSY,CO/DP SENSOR CONTROL		\$ 2,620.00
8005071	X190 DEG F W/DESK CHARGER		\$ 6,490.00
8005072	X190 DEG C W/DESK CHARGER		\$ 6,490.00
8005073	X190 DEG F W/TRK CHARGER		\$ 7,210.00
8005074	X190 DEG C W/TRK CHARGER		\$ 7,210.00

**Revision A**

Current revision date: December 1, 2018



**All prices listed herein supercede all other price lists, including (but not limited to) Scott master PDF price list. All prices are subject to change.**

**3M | Scott Fire & Safety Master Price List**

ITEM	Product Description	Signal Code	List Price
8005075	X190 DEG F W/D&T CHARGER		\$ 7,580.00
8005076	X190 DEG C W/D&T CHARGER		\$ 7,580.00
8005077	X190 TVR DEG F W/DESK CHARGER		\$ 7,550.00
8005078	X190 TVR DEG C W/DESK CHARGER		\$ 7,550.00
8005079	X190 TVR DEG F W/TRK CHARGER		\$ 8,240.00
8005080	X190 TVR DEG C W/TRK CHARGER		\$ 8,240.00
8005081	X190 TVR DEG F W/D&T CHARGER		\$ 8,500.00
8005082	X190 TVR DEG C W/D&T CHARGER		\$ 8,500.00
8005098	ADAPTER,3/8" TUBE TO 10-32 THD		\$ 17.00
8005112	ASSY, RFID R/W DESKTOP MODULE		\$ 454.00
8005116	ASSY, HOSE, 20" 7KPSI		\$ 610.00
8005184	ASSY, RFID DUAL TAG,10-PACK		\$ 91.00
8005197	SC-MON-BASE-UNL	APS	\$ 1.00
8005276	Cal Adaptor,PSG,SP		\$ 25.00
8005280	Battery, PSG,SP		\$ 15.00
8005287	Dust filter,PSG,SP		\$ 10.00
8005307	Aligator clip, with screw,SP		\$ 10.00
8005318	H2S module, standard,SP		\$ 156.00
8005320	H2S module, low range,SP		\$ 136.00
8005321	CO module, standard,SP		\$ 136.00
8005322	CO module, H2 resist,SP		\$ 156.00
8005324	O2 module,SP		\$ 129.00
8005325	SO2 module,SP		\$ 300.00
8005326	PH3 module,SP		\$ 300.00
8005327	O3 module,SP		\$ 300.00
8005328	Cl2 module,SP		\$ 300.00



**Revision A**

Current revision date: December 1, 2018



**All prices listed herein supercede all other price lists, including (but not limited to) Scott master PDF price list. All prices are subject to change.**

**3M | Scott Fire & Safety Master Price List**

ITEM	Product Description	Signal Code	List Price
8005329	CIO2 module,SP		\$ 300.00
8005330	HCN module,SP		\$ 300.00
8005331	NO module,SP		\$ 350.00
8005332	NO2 module,SP		\$ 300.00
8005333	NH3 module,SP		\$ 300.00
8005583	ASSY, HOSE, 25', 7500 PSI		\$ 1,490.00
8005606	X-SERIES WIRING HARNESS		\$ 80.00
8005607	X-Series Blue Btn Cable w/Reg		\$ 54.00
8005608	X-SERIES USB CABLE		\$ 16.00
8005628	X-SERIES DISCONNECT MOUNT		\$ 22.30
8005629	SPRING CONTACT		\$ 10.70
8005630	X-SERIES GRIP PAD YELLOW		\$ 46.40
8005631	X-SER RUBBER TOP CVR YELLOW		\$ 67.00
8005633	Retractable Lanyard- 1-0139-04		\$ 47.80
8005654	X-SERIES LASER CHASSIS		\$ 42.50
8005671	Flat HD Screw M3 x 8mm		\$ 0.60
8005673	M2x12 Philips PH Machine Screw		\$ 0.20
8005699	X-SERIES CHARGER CONTACT PC		\$ 25.50
8005718	X-SERIES TOP LABEL		\$ 6.50
8005719	X-SERIES SIDE LABELS		\$ 6.50
8005732	X-SERIES FOAM LEFT SIDE		\$ 31.90
8005733	X-SERIES FOAM RIGHT SIDE		\$ 31.90
8005743	Ulis 384x288 Head Board		\$ 160.00
8005747	NFPA INTERFACE (ROHS REV D)		\$ 123.00
8005759	X-SERIES FAST ATTACK AUX CABLE		\$ 47.00
8005781	SCREW BHSC M5X30		\$ 0.30

**Revision A**

Current revision date: December 1, 2018



**All prices listed herein supercede all other price lists, including (but not limited to) Scott master PDF price list. All prices are subject to change.**

**3M | Scott Fire & Safety Master Price List**

<b>ITEM</b>	<b>Product Description</b>	<b>Signal Code</b>	<b>List Price</b>
8005825	TUBE, NYLON,.125 x .073	EXP	\$ 1.70
8005906	X-SER RUBBER TOP COVER RED		\$ 75.00
8005942	MDII KIT, 1CAL_PROTEGE_SG	DIS	\$ 2,100.00
8005981	3 BUTTON REAR WINDOW ASSY		\$ 224.00
8006023	X-SERIES GRIP PAD RED		\$ 40.40
8006026	CYL, 207 BAR O2		\$ 1,330.00
8006112	M4x12mm 316 SS FHPM Screw		\$ 0.50
8006342	SEAT, BLEED VALVE		\$ 3.90
8006350	10-32 TAPPED CONNECTOR		\$ 10.70
8006399	M-F EXTENSION HARNESS, 25FT		\$ 560.00
8006565	NIPPLE,1/4 NPT,HEX,7.2PSI		\$ 21.60
8006840	FRONT AIR DEFLECTOR, H/A		\$ 83.00
8006930	MSM,LSM PACKAGING KIT		\$ 1,190.00
8006931	STEP-UPS 12VDC		\$ 1,430.00
8006941	SPRING, DIE, 1.062 X 1.500		\$ 24.70
8006942	CAP, SPOOL VALVE		\$ 65.00
8006943	CABLE,CAT5e, 25' LONG		\$ 26.00
8006945	ADAPTER,INTERCONNECT TO CAT5e		\$ 316.00
8006948	SHIM, SPOOL VALVE CAP		\$ 5.80
8006951	MONITOR,PRO EDITION	APS	\$ -
8006953	HARNESS, HA, UPS TO PS		\$ 5.25
8006991	PLUG,SNUBBER,SOL.VALVE		\$ 31.90
8006994	1/8X10-32UNF MALE PUSH CON		\$ 8.00
8006997	VALVE,SOLENOID,12VDC		\$ 283.00
8007069	X380 3B, No Laser, V-01		\$ 9,104.00
8007128	V206 9Hz FAHRENHEIT - KIT		\$ 1,700.00

**Revision A**

Current revision date: December 1, 2018



**All prices listed herein supercede all other price lists, including (but not limited to) Scott master PDF price list. All prices are subject to change.**

**3M | Scott Fire & Safety Master Price List**

ITEM	Product Description	Signal Code	List Price
8007129	V206 9Hz CELSIUS - KIT		\$ 1,700.00
8007130	V206 25Hz FAHRENHEIT - KIT		\$ 1,700.00
8007131	V206 25Hz CELSIUS - KIT		\$ 1,700.00
8007132	V320 9Hz FAHRENHEIT - KIT		\$ 2,700.00
8007133	V320 9Hz CELSIUS PACK - KIT		\$ 2,700.00
8007134	V320 25Hz FAHRENHEIT - KIT		\$ 2,700.00
8007135	V320 25Hz CELSIUS PACK - KIT		\$ 2,700.00
8007136	V-SERIES RETRACTABLE LANYARD		\$ 125.00
8007137	V-SERIES BATTERY CHARGER		\$ 195.00
8007138	V-SERIES CHARGER POWER SUPPLY		\$ 50.00
8007139	V-SERIES STANDARD BATTERY		\$ 125.00
801935-03	(HM) AL.CYL&VLV 5 MIN.		\$ 469.00
802162-01	CARRYING CASE		\$ 550.00
802200-01	HARNESS ASSEMBLY		\$ 204.00
802200-02	SHOULDER STRAP ASSY		\$ 112.00
802210-01	PISTON ASSY, DEMAND VALVE	DIS	\$ 69.00
802221-02	PR OUTLET & RELIEF VALVE ASSY	DIS	\$ 280.00
802223-01	COVER ASSY,PRESS REDUCER	DIS	\$ 370.00
802227-01	CAP,ASSY OF-AUTO ACTUATOR	DIS	\$ 18.00
802228-01	HOSE & COUPLING ASSY	DIS	\$ 337.00
802228-02	HOSE & COUPLING ASSY		\$ 337.00
802228-06	HOSE & COUPLING ASM		\$ 328.00
802228-13	HOSE & COUPLING ASSY	DIS	\$ 920.00
802228-14	HOSE & COUPLING ASSY		\$ 1,030.00
802228-15	HOSE & COUPLING ASSY	DIS	\$ 750.00
802228-16	HOSE & COUPLING ASSY		\$ 920.00

**Revision A**

Current revision date: December 1, 2018



**All prices listed herein supercede all other price lists, including (but not limited to) Scott master PDF price list. All prices are subject to change.**

**3M | Scott Fire & Safety Master Price List**

<b>ITEM</b>	<b>Product Description</b>	<b>Signal Code</b>	<b>List Price</b>
802229-01	HOSE ASSY,HP	DIS	\$ 203.00
802229-02	HOSE ASSEMBLY	DIS	\$ 173.00
802229-03	HOSE ASSEMBLY,HIGH PRESSURE	DIS	\$ 199.00
802295-01	VALVE ASSY, CHECK	DIS	\$ 26.40
802360-01	CARTRIDGE FILTER ASSY		\$ 9.00
802471-01	GASKET		\$ 2.50
802830-01	TESTER ASSY-(AIR PAK 4.5&2.2)	SVC	\$ 8,927.10
802835-01	HOSE ASSY, ADAPTER		\$ 29.90
802837-02	SERVICE TOOL KIT, HAND TOOLS	SAR	\$ 881.30
802837-03	SERVICE TOOL KIT,SPECIAL TOOLS	SAR	\$ 482.50
802849-01	HOSE ASSY		\$ 184.00
802864-01	VALVE ASSY,CHECK		\$ 185.00
802865-01	ALARM ASSEMBLY	DIS	\$ 113.00
802870-01	FILTER INSTALLATION TOOL	SVC	\$ 519.20
802872-01	FILTER REMOVAL HAND TOOL	DIS	\$ 100.00
802873-01	TUBE & RESTRICTOR ASSEMBLY	DIS	\$ 20.00
802919-01	REG.BODY SUB-ASSY.(SPARE PART)	DIS	\$ 370.00
802919-04	REG.BODY SUB-ASSY, IND(SPARE)		\$ 112.00
802929-02	SHAFT WRENCH	DIS	\$ 57.00
803144-01	DUAL PORT OUTLET MANIFOLD	DIS	\$ 215.00
803144-02	OUTLET & MANIFOLD ASSEMBLY		\$ 199.00
803191-01	DEMAND VALVE GUIDE		\$ 28.50
803194-01	HOSE ASSEMBLY		\$ 105.00
803194-02	EZ AIRLINE HOSE W/HANS FITTING		\$ 158.00
803194-03	EZ AIRLINE HOSE W/SHR FITTING		\$ 158.00
803194-05	HOSE ASSEMBLY		\$ 212.00

**Revision A**

Current revision date: December 1, 2018



**All prices listed herein supercede all other price lists, including (but not limited to) Scott master PDF price list. All prices are subject to change.**

**3M | Scott Fire & Safety Master Price List**

<b>ITEM</b>	<b>Product Description</b>	<b>Signal Code</b>	<b>List Price</b>
803194-08	HOSE ASSY - 36"		\$ 200.00
803278-01	CARRY CASE-A/S SKA		\$ 200.00
803351-01	STEM ASSEMBLY, PURGE--	SVC	\$ 8.80
803380-01	VALVE BODY ASSY (2216PSI)	SVC	\$ 245.00
803380-02	VALVE BODY ASSY.(4500PSI)	DIS	\$ 232.00
803380-06	VALVE BODY ASSY,MACH 5500 PSI		\$ 278.00
803380-07	VALVE BODY ASSY, 2216, NXG		\$ 239.00
803380-08	VALVE BODY ASSY, 4500, NXG	DIS	\$ 239.00
803380-09	VALVE BODY ASSY, 5500, NXG		\$ 281.00
803392-01	GAGE,PRESS DUAL POINTER	DIS	\$ 145.00
803393-01	GAGE,PRESS DUAL POINTER	DIS	\$ 147.00
803454-01	WRENCH ASSEMBLY,CYLINDER VALVE		\$ 384.00
803549-01	HEAD HARNESS		\$ 17.60
803596-01	REGULATOR CAP ASSY		\$ 57.00
803620-01	PASS-THRU ASSY, SUIT(HAN)		\$ 169.00
803620-02	PASS-THRU ASSY, SUIT (SCHR)**		\$ 169.00
803620-03	PASS-THRU ASSY, SUIT (HNSN)		\$ 405.00
803620-04	PASS-THRU ASSY, SUIT (SCHR)		\$ 405.00
803620-05	PASS-THRU ASSY, SUIT (CEJN)		\$ 439.00
803732-01	BUCKLE ASSY, HEAD HARNESS		\$ 8.00
803759-01	VOICEMITTER ASSY *KB*	DIS	\$ 19.80
803792-01	EZF DIAPHRAGM & VALVE ASSEMBLY		\$ 144.00
803793-01	LEVER ASSY, REG, MAN SHUT-OFF	DIS	\$ 8.80
803806-07	2.2/4.5 HIP PAD ASSY, BLACK	DIS	\$ 238.00
803810-03	2.2/4.5 HIP&SHOULDER PAD,BLACK		\$ 434.00
803810-04	ISCBA HIP & SHOULDER PAD KIT		\$ 399.00

**Revision A**

Current revision date: December 1, 2018



**All prices listed herein supercede all other price lists, including (but not limited to) Scott master PDF price list. All prices are subject to change.**

**3M | Scott Fire & Safety Master Price List**

ITEM	Product Description	Signal Code	List Price
803834-01	90-AG MOUTHBIT RESP W/POUCH		\$ 35.75
803834-02	R90-AG MOUTHBIT RESP, RPLMENT	DIS	\$ 31.50
803834-03	C90-AG MOUTHBIT RESP W/CASE		\$ 54.00
803834-30	90-AG,MOUTHBIT W/POUCH(BULK30)	DIS	\$ 1,080.00
803834-32	C90-AG MOUTHBIT W/CASE(BULK30)		\$ 1,600.00
803839-01	90-AM MOUTHBIT RESP W/POUCH		\$ 35.75
803839-02	R90-AM MOUTHBIT RESP RPLMENT		\$ 31.50
803839-03	C90-AM MOUTHBIT RESP W/CASE		\$ 54.00
803839-30	90-AM MOUTHBIT W/POUCH(BULK30)		\$ 1,080.00
803839-32	C90-AM MOUTHBIT W/CASE(BULK30)		\$ 1,600.00
803920-01	BAND ASSY, NECK	DIS	\$ 20.80
803920-02	BAND ASSY, NECK		\$ 19.80
803928-01	FENESTRA, HARDCOATED		\$ 68.00
803928-02	FENESTRA, HARDCOATED		\$ 76.00
803930-02	FIT TEST KIT, 40MM ADAPTER		\$ 113.00
803941-25	KIT,COVER,LENS,PROTECTIVE		\$ 68.00
804010-01	VOICEMITTER ASSEMBLY -KB-		\$ 15.80
804014-01	AV2 NOSECUP ASSEMBLY KIT		\$ 123.00
804015-01	INHALATION VALVE ASSY		\$ 9.30
804018-01	FENESTRA ASSEMBLY	DIS	\$ 85.00
804018-04	FENESTRA ASSEMBLY	SVC	\$ 69.00
804019-01	AV-2000 FACEPIECE ASSY.L/HH		\$ 232.00
804019-02	AV-2000 FACEPIECE ASSY. L/HH		\$ 232.00
804019-03	AV-2000 FACEPIECE ASSY.L/HH		\$ 232.00
804019-08	MASK FACEPIECE ASSY W/NOSE CUP		\$ 232.00
804039-01	FENESTRA ASSY		\$ 219.00

**Revision A**

Current revision date: December 1, 2018



**All prices listed herein supercede all other price lists, including (but not limited to) Scott master PDF price list. All prices are subject to change.**

**3M | Scott Fire & Safety Master Price List**

<b>ITEM</b>	<b>Product Description</b>	<b>Signal Code</b>	<b>List Price</b>
804058-01	ADAPTER, CHIN CANISTER		\$ 52.00
804059-01	2.2 GAUGE & LINE COMPLETE		\$ 420.00
804059-02	4.5 GAUGE & LINE COMPLETE	DIS	\$ 420.00
804059-03	3.0 GAUGE & LINE COMPLETE		\$ 297.00
804059-04	2.2 GAUGE & LINE COMPLETE		\$ 245.00
804059-05	4.5 GAUGE & LINE COMPLETE		\$ 245.00
804059-06	3.0 GAUGE & LINE COMPLETE		\$ 264.00
804059-13	4500 GAUGE W/GAUGE LINE ONLY		\$ 159.00
804059-14	2216 GAUGE W/GAUGE LINE		\$ 347.00
804059-15	4500 GAUGE W/GAUGE LINE		\$ 347.00
804059-16	5500 GAUGE W/GAUGE LINE		\$ 347.00
804061-01	BAND ASSY, CAP-POLYESTER		\$ 20.25
804063-01	HEAD HARNESS ASSY.POLYESTER		\$ 86.00
804069-19	AV2 W/POLY HARN, GRAY NC(SM)		\$ 278.00
804069-20	AV2 W/POLY HARN, GRAY NC(LG)		\$ 278.00
804069-21	AV2 W/POLY HARN, GRAY NC(XLG)		\$ 278.00
804069-28	AV2 W/POLY HARN, GRAY NC(CS)		\$ 278.00
804082-01	KEEPER, STRAP 1 IN YELLOW		\$ 33.60
804083-01	SIDE STRAP, KEVLAR 1"		\$ 36.00
804084-03	STRAP ASSY, SHOULDER(NYLON)		\$ 87.00
804084-04	2.2/4.5 SHOULDER STRAP,BLK KEV	DIS	\$ 181.00
804084-05	STRAP ASSEMBLY. SHOULDER BLKEV		\$ 166.00
804085-01	STRAP ASSEMBLY, WAIST		\$ 40.20
804085-02	CONNECTOR STRAP ASSY WAIST		\$ 79.00
804085-03	BUCKLE STRAP ASSY,WAIST		\$ 87.00
804085-06	STRAP ASSEMBLY, WAIST		\$ 25.40

**Revision A**

Current revision date: December 1, 2018



**All prices listed herein supercede all other price lists, including (but not limited to) Scott master PDF price list. All prices are subject to change.**

**3M | Scott Fire & Safety Master Price List**

<b>ITEM</b>	<b>Product Description</b>	<b>Signal Code</b>	<b>List Price</b>
804085-07	WAIST STRAP/BLK KEV/WIREFRM AP		\$ 36.00
804085-08	2.2/4.5 WAIST STRAP W/CNCTR BL		\$ 74.00
804085-09	2.2/4.5 WAIST STRP W/BKL BLK K		\$ 84.00
804086-01	STAY ASSEMBLY, WAIST/FRAME		\$ 41.25
804086-02	STAY ASSY. WAIST/FRAME		\$ 19.75
804086-03	ISCB,STAY ASSEMBLY,WAIST/FRAME		\$ 41.25
804088-02	STRAP ASSY., NECK		\$ 43.30
804091-01	KIT, GAUGE PROTECTOR		\$ 54.00
804094-01	TUBING ASSY.,GAUGE LINE	DIS	\$ 285.00
804094-03	GAUGE LINE TUBING ASSY,CRICKET	DIS	\$ 285.00
804094-04	SWAT GAUGE LINE	EOL	\$ 344.00
804094-05	GAUGELINE,AT,SHORT	DIS	\$ 198.00
804094-06	GAUGELINE,AT,MEDIUM	DIS	\$ 197.00
804094-07	GAUGELINE,AT,LONG	DIS	\$ 193.00
804096-01	SAMPLING PROBE ASSEMBLY		\$ 21.40
804097-01	VALVE ASSY.,CYLINDER 2.2/IIA	DIS	\$ 560.00
804097-02	VALVE ASSY, CYLINDER 3.0		\$ 560.00
804098-01	VALVE ASSY, CYLINDER 4.5	DIS	\$ 493.00
804098-02	VALVE ASSY, CYLINDER	DIS	\$ 520.00
804101-01	AL.CYL&VLV ASSY.		\$ 730.00
804101-01-D	AL.CYL.& VALVE ASSY.		\$ 730.00
804110-01	E-Z FLO REGULATOR COVER	DIS	\$ 127.00
804110-03	COVER ASSY,REG MANUAL SHUT OFF	DIS	\$ 164.00
804110-13	COVER ASSY, REG, 13, CBRN	DIS	\$ 151.00
804111-03	BAND ASSEMBLY, CYLINDER		\$ 157.00
804111-04	BAND ASSEMBLY, CYLINDER		\$ 157.00



**Revision A**

Current revision date: December 1, 2018



**All prices listed herein supercede all other price lists, including (but not limited to) Scott master PDF price list. All prices are subject to change.**

**3M | Scott Fire & Safety Master Price List**

<b>ITEM</b>	<b>Product Description</b>	<b>Signal Code</b>	<b>List Price</b>
804112-02	STRAP ASSY		\$ 14.80
804113-01	BUMPER AND GUARD ASSY *KB*	DIS	\$ 26.40
804172-01	BACK FRAME ASSY.2.2/4.5	SVC	\$ 530.00
804172-02	BACK FRAME ASSY		\$ 510.00
804172-05	BACK FRAME ASSY		\$ 1,430.00
804172-06	BACK FRAME ASSEMBLY		\$ 530.00
804172-07	WF BACK FRAME ASSY L/BLKHARNES		\$ 510.00
804172-08	BACK FRAME ASSEMBLY		\$ 1,370.00
804172-09	BACK FRAME ASSEMBLY		\$ 1,370.00
804173-01	BACK-PAK ASSY.2.2/4.5		\$ 1,470.00
804173-02	2.2/4.5 WR BCKFRM W/MTL BAND		\$ 2,710.00
804173-03	WIRFRAME & HARNSBACK-PAK ASSY		\$ 930.00
804173-11	BACK-PAK ASSY		\$ 1,410.00
804173-12	BACK-PAK ASSY		\$ 2,710.00
804173-13	BACK-PAK ASSY		\$ 930.00
804173-24	BACK-PAK ASSY		\$ 2,680.00
804173-25	BACK-PAK ASSY, AP75, SS, WF		\$ 2,530.00
804176-01	BAND ASSY.,NECK (KEVLAR)	DIS	\$ 25.50
804176-02	BAND ASSY, NECK	DIS	\$ 25.50
804176-03	BAND ASSY, NECK		\$ 24.70
804177-01	HEAD HARNESS ASSY.KEVLAR	DIS	\$ 193.00
804178-01	TEMPLE STRAP ASSY.- KEVLAR	DIS	\$ 25.50
804178-02	HEANET ASSY, KEVLAR	DIS	\$ 25.50
804178-03	BAND ASSY, CAP		\$ 24.70
804191-01	MASK ASSY, AV-2000 KEV SML		\$ 387.00
804191-02	MASK ASSY, AV-2000 KEV STD		\$ 387.00

**Revision A**

Current revision date: December 1, 2018



**All prices listed herein supercede all other price lists, including (but not limited to) Scott master PDF price list. All prices are subject to change.**

**3M | Scott Fire & Safety Master Price List**

<b>ITEM</b>	<b>Product Description</b>	<b>Signal Code</b>	<b>List Price</b>
804191-03	MASK ASSY, AV-2000 KEV XL		\$ 387.00
804191-08	AV2000 W/KEV HARN COMF.SEAL(S)		\$ 387.00
804191-71	AV2000,KEV,SM,RUB,07NC		\$ 377.00
804191-72	AV2000,KEV,L,RUB,07NC		\$ 377.00
804191-73	AV2000,LEV,XL,RUB,07NC		\$ 377.00
804191-74	AV2000,KEV,CS,RUB,07NC		\$ 377.00
804191-75	AV2000,KEV,SM,RUB,07NC,W/CLP		\$ 410.00
804191-76	AV2000,KEV,L,RUB,07NC,W/CLP		\$ 410.00
804191-77	AV2000,KEV,XL,RUB,07NC,W/CLP		\$ 410.00
804191-78	AV2000,KEV,CS,RUB,07NC,W/CLP		\$ 410.00
804192-01	CASE, CARRYING-MOUTHBIT C-90		\$ 27.10
804194-01	COVER ASSEMBLY, BUTTON	DIS	\$ 42.00
804221-01	REGULATOR ASSY		\$ 820.00
804223-01	COVER,SKA-PAK E-Z FLO REG.	DIS	\$ 100.00
804298-01	BODY & CHECK VALVE ASSY		\$ 157.00
804304-01	PRESS REDUCER ASSY 4.5		\$ 540.00
804304-11	PRESSURE REDUCER 2.2/3.0		\$ 540.00
804305-01	HOSE ASSY, AIRLINE CONNECTION		\$ 124.00
804305-02	HOSE ASSY, AIRLINE CONNECTION		\$ 124.00
804305-03	SKAPAK AL HOSE W/HANSEN HK FTG		\$ 223.00
804305-04	AIRLINE HOSE, HAN PLUG W/FASTN		\$ 167.00
804305-05	AIRLINE HOSE,SCH PLUG W/FASTNR		\$ 167.00
804305-06	AIRLINE HOSE, HK PLUG Q/FASTN		\$ 234.00
804305-07	AIRLINE HOSE, CEJN PLUG		\$ 211.00
804305-09	AIRLINE HOSE, HANSEN SOCKET		\$ 223.00
804305-10	AIRLINE HOSE, HANSEN W/FASTENR		\$ 267.00

**Revision A**

Current revision date: December 1, 2018



**All prices listed herein supercede all other price lists, including (but not limited to) Scott master PDF price list. All prices are subject to change.**

**3M | Scott Fire & Safety Master Price List**

<b>ITEM</b>	<b>Product Description</b>	<b>Signal Code</b>	<b>List Price</b>
804307-01	HARNESS ASSY, KEVLAR		\$ 454.00
804310-01	PRESS REDUCER ASSY 4.5		\$ 396.00
804310-02	REDUCER, PRESSURE ASSEMBLY		\$ 920.00
804310-11	PRESSURE REDUCER 2.2/3.0		\$ 399.00
804315-02	PASE MOTION SENSOR ASSY	EOL	\$ 103.00
804319-01	HOSE ASSY, DUAL AIR SUPPLY **	SVC	\$ 385.00
804319-02	HOSE ASSY, DUAL AIR SUPPLY **	SVC	\$ 414.00
804334-01	VALVE ASSY, TRANSFER (4.5)	DIS	\$ 41.00
804334-02	VALVE ASSY, TRANSFER (2.2)	DIS	\$ 41.00
804334-03	VALVE ASSEMBLY TRANSFER	DIS	\$ 34.10
804335-04	HOSE & SOCKET ASSY PERFECTING	DIS	\$ 355.00
804335-07	HOSE & SOCKET ASSEMBLY		\$ 123.00
804335-10	HOSE & SOCKET ASSEMBLY		\$ 475.00
804335-11	HOSE & SOCKET ASSEMBLY	SAR	\$ 65.30
804335-14	HOSE & SOCKET ASSEMBLY	DIS	\$ 354.00
804335-15	HOSE & SOCKET ASSY PERFECTING		\$ 93.00
804336-01	REGULATOR, HOSE ASSY	DIS	\$ 159.00
804336-11	HOSE ASSY, REGULATOR, AP75i		\$ 191.00
804337-01	HOSE, PLUG ASSY.		\$ 183.00
804370-01	REG ASSY, E-Z FLO STD HOSE		\$ 1,140.00
804370-02	REG ASSY, E-Z FLO Q.D. HOSE		\$ 1,180.00
804370-05	REG ASSY, SWAT Q.D. HOSE M.S.O		\$ 1,160.00
804370-09	REG ASSY, SKA-PAK A/T M.S.O.		\$ 1,100.00
804370-10	REG ASSY, HUD W/Q.D. HOSE MSO		\$ 1,640.00
804370-11	REG ASSY, HUD STD HOSE M.S.O.		\$ 1,580.00
804370-31	REG ASSY, HUD W/QD HOSE AP75i		\$ 1,640.00

**Revision A**

Current revision date: December 1, 2018



**All prices listed herein supercede all other price lists, including (but not limited to) Scott master PDF price list. All prices are subject to change.**

**3M | Scott Fire & Safety Master Price List**

<b>ITEM</b>	<b>Product Description</b>	<b>Signal Code</b>	<b>List Price</b>
804370-41	REG ASSY,E-Z FLO STDHOSE AP75i		\$ 1,140.00
804381-03	BOTTOM ENCLOSURE ASSEMBLY	DIS	\$ 113.00
804386-19	E-Z AIRLINE, AV2 POLY HANSEN		\$ 918.00
804386-25	E-Z AIRLINE, AV2 POLY, SCHRADR		\$ 918.00
804386-31	E-Z AIRLINE, AV2 POLY, HK		\$ 918.00
804386-62	E-Z AIRLINE, LESS FP, SCHRADER		\$ 640.00
804386-66	E-Z AIRLINE, LESS FP, HANSEN		\$ 640.00
804386-67	E-Z AIRLINE,LESS FP,HANSEN LH		\$ 640.00
804415-01	A/P 50 BACKFRAME/HARNESS ASS'Y	DIS	\$ 1,440.00
804415-02	AP50 BACKFRAME & HARNESS ASSY		\$ 1,440.00
804421-01	CYLINDER RETENTION ASSY	DIS	\$ 162.00
804422-02	CYL RETENTION ASSY (WIRE FRAME		\$ 59.00
804422-03	CYL RETENTION ASSY (WIRE FRAME		\$ 62.00
804422-04	CYLINDER RETENTION ASSEMBLY		\$ 109.00
804423-01	AP50 CYLINDER LATCH ASSEMBLY	DIS	\$ 51.00
804424-02	CYL STRAP ASSY (WIRE FRAME)		\$ 38.10
804424-04	CYLINDER STRAP ASSY -WIREFRAME		\$ 87.00
804425-01	CYLINDER STRAP ASSY	DIS	\$ 72.00
804425-02	CYL STRAP ASSY,(PLATE FRAME)	DIS	\$ 72.00
804425-04	CYLINDER STRAP ASSY, AP75 WF		\$ 55.00
804426-01	WAIST BELT ASSY(FEMALE BUCKLE)	DIS	\$ 74.00
804426-02	WAIST BELT ASSY(FEMALE BUCKLE)		\$ 74.00
804427-01	WAIST BELT ASSY (MALE CONN.)	DIS	\$ 70.00
804427-02	WAIST BELT ASSY (MALE CONN.)		\$ 70.00
804428-01	SHOULDER PAD ASSY (PLATE FRAME	DIS	\$ 406.00
804428-02	SHLDR PAD W/SPR BUCK, AP50	DIS	\$ 404.00

**Revision A**

Current revision date: December 1, 2018



**All prices listed herein supercede all other price lists, including (but not limited to) Scott master PDF price list. All prices are subject to change.**

**3M | Scott Fire & Safety Master Price List**

<b>ITEM</b>	<b>Product Description</b>	<b>Signal Code</b>	<b>List Price</b>
804441-01	EZ AIRLINE REG, HANSEN		\$ 540.00
804441-02	EZ AIRLINE REG, SCHRADER		\$ 540.00
804441-03	EZ AIRLINE REG, HANSEN HK		\$ 630.00
804441-04	E-Z FLO REG. ISCBA		\$ 570.00
804441-05	E-Z FLO REG W/ MODULAIR		\$ 590.00
804441-06	E-Z FLO REG ACS		\$ 570.00
804442-01	KIT, EYEGLASS		\$ 65.00
804453-07	ASSEMBLY, SHOULDER PAD (NFS)		\$ 113.00
804453-08	PAD ASSEMBLY, SHOULDER		\$ 103.00
804471-01	WAIST PAD ASSEMBLY	DIS	\$ 327.00
804471-02	WAIST PAD, SPRING BUCKLE	DIS	\$ 298.00
804474-01	GAUGE DUAL POINTER 310 BAR		\$ 142.00
804475-01	COVER ASSY,E-Z AIRLINE REG.		\$ 111.00
804475-02	REG CVR ASY MANUAL SHUT-OFF		\$ 110.00
804476-01	SIDE STRAP, KEVLAR 1.5"(YL WF)		\$ 42.30
804476-02	STRAP ASSY, SIDE		\$ 17.25
804476-03	SIDE STRAP,BLKEV,WF	DIS	\$ 63.00
804481-01	BELT, WAIST TO SHOULDER ASSY	DIS	\$ 151.00
804493-01	HARNESS ASSEMBLY, BODY		\$ 171.00
804497-01	CARRYING-CASE, HARD		\$ 366.00
804497-02	CARRYING-CASE, HARD		\$ 426.00
804499-01	BACKFRAME ASSEMBLY	DIS	\$ 492.00
804512-01	BACK-PAK KIT		\$ 1,540.00
804530-01	STRAP ASSY, FASTENER	DIS	\$ 48.60
804530-03	STRAP ASSEMBLY, FASTENER		\$ 48.90
804538-01	3.0 V-A PRES DUAL POINTER GAGE	DIS	\$ 55.00

**Revision A**

Current revision date: December 1, 2018



**All prices listed herein supercede all other price lists, including (but not limited to) Scott master PDF price list. All prices are subject to change.**

**3M | Scott Fire & Safety Master Price List**

<b>ITEM</b>	<b>Product Description</b>	<b>Signal Code</b>	<b>List Price</b>
804558-01	CAP ASSEMBLY (SCHRADER)		\$ 266.00
804575-01	2.2/4.5/3.0 QKCHG COUPLING ASY		\$ 100.00
804594-01	MASK HOOK ASSEMBLY	DIS	\$ 23.80
804595-01	CHARGING WAND ASSEMBLY 2.2		\$ 1,380.00
804595-02	CHARGING WAND ASSY 3.0		\$ 1,380.00
804595-03	CHARGING WAND ASSY 4.5		\$ 1,370.00
804606-01	CAP ASSY(HANSEN)PN27537-05		\$ 103.00
804619-01	ISCBA 2.2 PRESSURE REDUCER SP		\$ 1,290.00
804619-02	ISCBA 2.2 PRES REDUCER W/DUAL		\$ 1,360.00
804619-03	IND 2.2 PRESSURE REDUCER ASSY		\$ 1,410.00
804621-02	ISCBA BKPK ASY KEV W/MTL BKL		\$ 820.00
804621-03	ISCBA BKPK ASY NYL W/POLY BKL		\$ 690.00
804622-05	MALE STRAP ASSY BUCKLE		\$ 17.25
804622-06	FEMALE STRAP ASSY BUCKLE		\$ 18.30
804642-01	IND 4.5 REDUCER		\$ 1,420.00
804642-02	IND 4.5 REDUCER DUAL		\$ 1,510.00
804642-03	PRESSURE REDUCER, 4500 ASSY		\$ 1,450.00
804642-04	IND 4.5 PRESSURE REDUCER ASSY		\$ 1,470.00
804646-01	REDUCER SUBASY,IND 2.2/4.5**		\$ 131.00
804646-03	REDUCER SUBASSEMBLY		\$ 350.00
804651-01	ALARM SUBASY,IND 2.2/4.5 RDR**	SVC	\$ 255.00
804678-01	HOSE & SOCKET ASSY		\$ 179.00
804679-01	HOSE,PLUG ASY NON-VIBR(EZAL)**		\$ 126.00
804694-01	HOSE AY MA, SKA+,EZA,INDL CJN		\$ 223.00
804694-02	HOSE ASSY, HANSEN HK		\$ 288.00
804694-03	HOSE ASSY, QUICK CONNECT		\$ 171.00

**Revision A**

Current revision date: December 1, 2018



**All prices listed herein supercede all other price lists, including (but not limited to) Scott master PDF price list. All prices are subject to change.**

**3M | Scott Fire & Safety Master Price List**

<b>ITEM</b>	<b>Product Description</b>	<b>Signal Code</b>	<b>List Price</b>
804694-04	HOSE ASY,QK CONNECT(EZAL)		\$ 180.00
804694-05	HOSE ASSY, QD,PERFECT. COUPLNG		\$ 212.00
804694-06	HOSE ASSY, QD,PERFECT. COUPLNG		\$ 216.00
804694-07	HOSE ASSY, QD,PERFECT. COUPLNG		\$ 216.00
804706-01	COVER ASSEMBLY, BATTERY		\$ 38.90
804706-03	PASE BATTERY COVER ASSY.		\$ 23.80
804706-06	COVER ASSEMBLY BATTERY SE		\$ 27.00
804707-01	COVER ASSY REG MANUAL SHUT-OFF		\$ 93.00
804721-01	CYL&VLV ASSY CARB,30MIN,4500		\$ 1,304.00
804721-01-1	CYL&VALV ASSY CARB,30MIN,4500		\$ 1,304.00
804721-01-D	CYL&VALV ASSY CARB,30MIN,4500		\$ 1,304.00
804721-11	CYL&VALV ASSY CARB,30MIN,4500		\$ 1,409.00
804721-11-D	CYL&VALV ASSY CARB,30MIN,4500		\$ 1,409.00
804721-21-S	CYL&VALV ASSY CARB,30MIN,4500		\$ 1,513.00
804721-21-SD	CYL&VALV ASSY CARB,30MIN,4500		\$ 1,513.00
804721-31	CYL&VLV ASSY, C,30YR,30M,4.5	GCI	\$ 1,576.00
804721-31-S	CYL&VLV W/SLV,C,30YR,30M,4.5	GCI	\$ 1,785.00
804721-31-SD	CYL&VLV ASSY, C,30YR,30M,4.5	GCI	\$ 1,732.00
804721-35	CYL&VLV ASSY, C,30YR,30M,4.5		\$ 1,576.00
804721-35-D	CYL&VLV ASSY, C,30YR,30M,4.5		\$ 1,576.00
804722-01	CYL&VLV ASSY,CARB,45MIN,4500		\$ 1,555.00
804722-01-1	CYL&VALV ASSY CARB,45MIN,4500		\$ 1,555.00
804722-01A	45MNCYL&VLVE ASY,CAR4500PSI SH		\$ 1,555.00
804722-01A-1	CYL&VALV ASSY CARB,45MIN,4500		\$ 1,555.00
804722-01A-D	CYL&VALV ASSY CARB,45MIN,4500		\$ 1,555.00
804722-01-D	CYL&VALV ASSY CARB,45MIN,4500		\$ 1,555.00

**Revision A**

Current revision date: December 1, 2018



**All prices listed herein supercede all other price lists, including (but not limited to) Scott master PDF price list. All prices are subject to change.**

**3M | Scott Fire & Safety Master Price List**

<b>ITEM</b>	<b>Product Description</b>	<b>Signal Code</b>	<b>List Price</b>
804722-11	CYL&VALV ASSY CARB,45MIN,4500		\$ 1,660.00
804722-11-D	CYL&VALV ASSY CARB,45MIN,4500		\$ 1,660.00
804722-21-S	CYL&VALV ASSY CARB,45MIN,4500		\$ 1,764.00
804722-31	CYL&VLV ASSY, C,30YR,45M,4.5	GCI	\$ 1,952.00
804722-31-S	CYL&VLV W/SLV,C,30YR,45M,4.5	GCI	\$ 2,162.00
804722-35	CYL&VLV ASSY, C,30YR,45M,4.5		\$ 1,952.00
804722-35-D	CYL&VLV ASSY, C,30YR,45M,4.5		\$ 1,952.00
804723-01	(HM) CYL&VLV CARBON 60		\$ 1,732.00
804723-01-1	CYL&VALV ASSY CARB,60MIN,4500		\$ 1,732.00
804723-01-D	CYL&VALV ASSY CARB,60MIN,4500		\$ 1,732.00
804723-11	CYL&VALV ASSY CARB,60MIN,4500		\$ 1,837.00
804723-11-D	CYL&VALV ASSY CARB,60MIN,4500		\$ 1,837.00
804723-31	CYL&VALV ASSY CARB,60MIN,4500	GCI	\$ 2,329.00
804723-31-S	CYL&VALV ASSY CARB,60MIN,4500	GCI	\$ 2,538.00
804723-35	CYL&VALV ASSY C,30YR,60M,4.5		\$ 2,329.00
804723-35-D	CYL&VALV ASSY C,30YR,60M,4.5		\$ 2,329.00
804825-01	FITTING ASY, TS 2.2/4.5**		\$ 34.00
804840-01	CYL&VLV ASSY CARB,30MIN,2216		\$ 1,266.00
804840-01-1	CYL&VALV ASSY CARB,30MIN,2216		\$ 1,266.00
804840-01-D	CYL&VALV ASSY CARB,30MIN,2216		\$ 1,266.00
804851-01	GAUGE ASSY. REMOTE MTG.		\$ 370.00
804861-2810	NAVSEA,CBRN,4.5 AIR-PAK	GCI	\$ 7,270.00
804861-3710	NAVSEA,CBRN,4.5 AIR-PAK	GCI	\$ 8,810.00
804861-3810	NAVSEA,CBRN,4.5 AIR-PAK	GCI	\$ 9,180.00
804861-50	AIR-PAK JAPANESE NAVY		\$ 5,120.00
804862-01	GAUGE BLOCK ASSEMBLY		\$ 113.00



**Revision A**

Current revision date: December 1, 2018



**All prices listed herein supercede all other price lists, including (but not limited to) Scott master PDF price list. All prices are subject to change.**

**3M | Scott Fire & Safety Master Price List**

ITEM	Product Description	Signal Code	List Price
804867-01	CLIP ASSY NAVSEA-RIGHT		\$ 13.00
804867-02	CLIP ASSY NAVSEA-LEFT		\$ 13.00
804868-01	FENESTRA ASSY W/ SNAPS		\$ 186.00
804869-01	BEZEL ASSY NAVSEA		\$ 29.10
804870-01	AV2000 LENS, L/HH W/SNAPS		\$ 284.00
804870-02	AV2 L/HEAD HARNESS W/SNAPS		\$ 284.00
804871-01	MASK ASSY AV2000 4 STRAP		\$ 349.00
804871-02	MASK ASSY AV2000 4 STRAP		\$ 350.00
804871-03	MASK ASSY AV2000 4 STRAP		\$ 349.00
804872-01	BAND ASSY, CYLINDER	DIS	\$ 373.00
804880-01	LED ALERT ASSEMBLY		\$ 176.00
804961-01	SKAPAK 3.0,15MIN.CYL&VLV ASSY		\$ 699.00
804961-02	C&V,3.0,15,EZ-CLIP		\$ 699.00
804965-01	WIRE BAIL/FRAME ASSEMBLY NY		\$ 189.00
804965-02	WIRE BAIL/ FRAME ASSEMBLY		\$ 81.00
804981-01	KEVLAR HARNESS ASSEMBLY		\$ 477.00
804982-01	NYLON HARNESS ASSY SKA+(BLK)		\$ 272.00
804983-01	HARNESS, WAIST BELT		\$ 53.00
804985-01	HANGER BRACKET ASSEMBLY		\$ 51.00
805004-03	CHARGING WAND ASSY., NAVSEA		\$ 1,070.00
805031-01	SKAPK+ 2.2 5MN CYL&VLV ASSY		\$ 520.00
805044-01	CYL&VLV ASSY CARB,30MIN,3000		\$ 1,579.00
805044-01-D	CYL&VALV ASSY CARB,30MIN,3000		\$ 1,579.00
805059-01	40MM CANISTER ADAPTER		\$ 53.00
805061-02	HARNESS ASSY,FALL PROT. SMALL		\$ 760.00
805061-03	HARNESS ASSY,FALL PROT. LARGE		\$ 760.00

**Revision A**

Current revision date: December 1, 2018



**All prices listed herein supercede all other price lists, including (but not limited to) Scott master PDF price list. All prices are subject to change.**

**3M | Scott Fire & Safety Master Price List**

<b>ITEM</b>	<b>Product Description</b>	<b>Signal Code</b>	<b>List Price</b>
805061-04	HARNESS ASSY,FALL PROT. MEDIUM		\$ 760.00
805085-01	KEEPER, STRAP ASSEMBLY		\$ 27.00
805088-01	AP 50 WAIST BELT EXTENSION		\$ 43.30
805088-02	WAIST BELT 2"EXT NYL/PLY BKL		\$ 19.00
805119-01	HOUSING&FILTER ASSY,GAUGE BELL		\$ 225.00
805121-01	POSI-CHEK3 INTERFACE KIT(H&G)*	SAR	\$ 266.30
805121-02	INTERFACE KIT,POSI-CK 3,MIDRAN	SAR	\$ 358.10
805123-01	INTERFACE HOSE LESS GAUGE	SAR	\$ 42.90
805133-02	LED ALARM AND HOSE (QD) ASSY		\$ 336.00
805182-02	WOV LENS HOLDER ASSY (FLIP UP)		\$ 71.00
805185-01	SKA-PAK+RETRO KIT(5&10) N HRN		\$ 206.00
805185-02	SKA-PAK+ RETROFIT KIT(5&10)KHN		\$ 354.00
805205-02	CABLE ASSY, 28.00" LONG	EOL	\$ 206.00
805212-01	HANDLE BRACKET ASSY., CA/RIT		\$ 74.00
805257-19	AV2 4PT RBR HARN,GRAY NC, SM		\$ 275.00
805257-20	AV2 4PT RBR HARN,GRAY NC, MD		\$ 275.00
805257-21	AV2 4PT RBR HARN,GRAY NC, LG		\$ 275.00
805257-28	AV2 4PT RBR HARN,GRAY NC, CS		\$ 275.00
805259-01	4-POINT RUBBER HEAD HARNESS		\$ 77.00
805290-01	P.R. AUTO TRANSFER VALVE KIT	DIS	\$ 96.00
805291-01	P.R. AUTO TRANSFER SEAL KIT	DIS	\$ 13.75
805292-01	LOW CYL TRANSFR VALV KIT,4.5**	DIS	\$ 44.60
805293-01	LOW CYL TRANSFR VALV KIT,2.2**	DIS	\$ 43.60
805294-01	TRANSFER VALVE SEAL KIT, 4.5		\$ 15.90
805295-01	TRANSFER VALVE SEAL KIT, 2.2		\$ 15.90
805296-01	CHECK VALVE & SEAL KIT	SVC	\$ 48.60

**Revision A**

Current revision date: December 1, 2018



**All prices listed herein supercede all other price lists, including (but not limited to) Scott master PDF price list. All prices are subject to change.**

**3M | Scott Fire & Safety Master Price List**

<b>ITEM</b>	<b>Product Description</b>	<b>Signal Code</b>	<b>List Price</b>
805297-01	AV2 HEAD HARNESS KIT		\$ 203.00
805298-01	AV2 HEAD HARNESS STRAP KIT		\$ 64.00
805299-01	AV2 LENS FRAME KIT		\$ 40.00
805300-01	AV2 FACE SEAL KIT, (S)		\$ 70.00
805301-01	AV2 FACE SEAL KIT,(L) BLACK		\$ 70.00
805302-01	AV2 FACE SEAL KIT,(XL) RED		\$ 66.00
805303-01	AV-2000 LENS KIT	DIS	\$ 99.00
805304-01	AV2 VOICEMITTER KIT		\$ 44.00
805307-01	AV2/SOV FACESEAL KIT(CS)		\$ 70.00
805309-01	P.R. SEAT RETAINER KIT**	SVC	\$ 73.00
805310-01	PRIMARY/SECONDARY SEAT KIT	DIS	\$ 89.00
805311-01	PISTON & SEAL KIT**	DIS	\$ 65.00
805312-01	PRIMARY/SECONDARY SEAL KIT	DIS	\$ 17.00
805313-01	P.R. COVER STATIC SEAL KIT	DIS	\$ 25.40
805314-01	PRESS TO TEST SHAFT KIT**	DIS	\$ 150.00
805315-01	PR REDUCER COVER SCREW KIT		\$ 19.10
805318-01	EZ FLO REG VIBRALERT KIT	SVC	\$ 510.00
805319-01	EZ FLO REG PURGE BODY KIT	DIS	\$ 81.00
805320-01	EZ FLO REGULATOR SEAL KIT	DIS	\$ 29.60
805321-01	DEMAND VALVE PISTON KIT	DIS	\$ 91.00
805322-01	EZ FLO PURGE STEM KIT	DIS	\$ 30.60
805323-01	EZ FLO DEMAND LEVER KIT	DIS	\$ 25.40
805324-01	EZ FLO REG LATCH PLATE KIT		\$ 23.30
805329-01	AP50 HARNESS & BUCKLE KIT		\$ 950.00
805337-11	MASK FACEPIECE ASSEMBLY		\$ 280.00
805337-12	MASK FACEPIECE ASSY		\$ 280.00

**Revision A**

Current revision date: December 1, 2018



**All prices listed herein supercede all other price lists, including (but not limited to) Scott master PDF price list. All prices are subject to change.**

**3M | Scott Fire & Safety Master Price List**

<b>ITEM</b>	<b>Product Description</b>	<b>Signal Code</b>	<b>List Price</b>
805337-13	MASK FACEPIECE ASSY		\$ 280.00
805339-01	VOICEMITTER DUCT ASSY., LEFT	DIS	\$ 16.25
805339-02	VOICEMITTER DUCT ASSY., RIGHT	DIS	\$ 15.90
805345-01	FENESTRA, DRILLED	DIS	\$ 141.00
805346-01	FENESTRA,HARDCOAT & ANTI-FOG		\$ 137.00
805358-01	BATTERY PACK ASY,C420 PAPR		\$ 153.00
805359-01	DECONTAMINATION BELT ASY,C420P		\$ 93.00
805374-01	AIRFLOW INDICATOR ASY,C420PAPR		\$ 40.80
805381-05	Posi3 USB Interface Kit	SAR	\$ 3,559.80
805381-06	Posi3 USB Interface Kit L/Tool	SAR	\$ 1,999.20
805385-01	UNIV SPRING COMPRESSOR ASSY	DIS	\$ 210.00
805402-01	LOOP, WEBBING		\$ 24.30
805402-02	LOOP, WEBBING	DIS	\$ 25.40
805421-01	SWAT SHOULDER PAD ASSEMBLY		\$ 402.00
805423-01	WAIST PAD ASSEMBLY		\$ 327.00
805425-01	SWAT BELT WAIST TO SHOULDER		\$ 144.00
805426-01	SWAT WAIST BELT MALE CONNECT		\$ 64.00
805427-01	SWAT WAIST BELT FEMALE CONNECT		\$ 80.00
805429-01	CYLINDER RETENTION ASSEMBLY		\$ 212.00
805442-02	HOSE & SOCKET ASSEMBLY		\$ 387.00
805443-01	RIT, HANSEN PLUG W/LANYARD		\$ 89.00
805443-03	CEJN PLUG W/LANYARD		\$ 106.00
805450-13	CHARGING WAND ASSY, RIT-PAK		\$ 1,020.00
805450-23	CHARGING WAND ASSY, RIT-PAK		\$ 1,280.00
805458-01	SWAT-PAK 6'EBSS HOSE & POUCH		\$ 476.00
805460-01	CARRIER FRAME, RIT PAK		\$ 520.00

**Revision A**

Current revision date: December 1, 2018



**All prices listed herein supercede all other price lists, including (but not limited to) Scott master PDF price list. All prices are subject to change.**

**3M | Scott Fire & Safety Master Price List**

<b>ITEM</b>	<b>Product Description</b>	<b>Signal Code</b>	<b>List Price</b>
805471-01	ASSEMBLY, LINE MOUNT PLUG**	DIS	\$ 29.60
805472-01	BELL, REPLACEMENT 4.5		\$ 495.00
805472-07	BELL, REPLACEMENT 2.2		\$ 498.00
805511-01	AP50 CHEST STRAP ASSEMBLY	SVC	\$ 38.20
805511-02	CHEST STRAP ASSEMBLY WITH SNAP		\$ 49.50
805534-01	MASK BAG, LIGHTWEIGHT FLEECE		\$ 28.75
805536-01	WOV LENS SEPARATOR&RETAINER KT		\$ 14.10
805537-01	WELD-O-VISTA LENS ASSEMBLY KIT		\$ 237.00
805557-01	MPC PLUS CARTRIDGE		\$ 26.30
805570-01	PA SE LEAK TESTER KIT**		\$ 870.00
805571-01	EI LENS HOUS ADP ASY		\$ 81.00
805572-01	PAK-ALERT ADAPTER ASSEMBLY		\$ 281.00
805573-01	EI CAMERA HS ADP ASY		\$ 16.80
805574-01	WOV LENS ASY,EPDM,W/NSCP&VCMTR		\$ 315.00
805600-01	HANDWHEEL KIT	DIS	\$ 74.00
805622-01	TWIN QUARTER TURN ADAPTER ASSY		\$ 53.00
805628-01	40MM FIT TEST ADAPTER ASSY		\$ 61.00
805629-01	CHIN CAN FIT TEST ADAPT ASSY		\$ 51.00
805630-01	REPLACEMENT KIT,FIT TEST ADAPT		\$ 12.80
805655-01	SEAL, MASK KIT		\$ 32.10
805659-006	SUPPLY HOSE, 6' (CEJN)EZAL		\$ 171.00
805659-025	SUPPLY HOSE, 25' (CEJN)		\$ 262.00
805659-050	SUPPLY HOSE, 50' (CEJN)EZAL		\$ 388.00
805659-100	SUPPLY HOSE, 100' (CEJN)		\$ 530.00
805659-150	SUPPLY HOSE, 150' (CEJN)		\$ 700.00
805679-00	BASE UNIT, SEMS	DIS	\$ 4,560.00

**Revision A**

Current revision date: December 1, 2018



**All prices listed herein supercede all other price lists, including (but not limited to) Scott master PDF price list. All prices are subject to change.**

**3M | Scott Fire & Safety Master Price List**

<b>ITEM</b>	<b>Product Description</b>	<b>Signal Code</b>	<b>List Price</b>
805679-01	BASE UNIT, SEMS		\$ 6,280.00
805680-01	PORTABLE UNIT, SEMS,2216 PSI	EOL	\$ 2,940.00
805680-02	PORTABLE UNIT, SEMS, 4500 PSI	EOL	\$ 2,350.00
805680-03	PORTABLE UNIT, SEMS,3000 PSI		\$ 2,330.00
805693-01	EZ FLOII,STD HOSE		\$ 1,200.00
805693-02	EZFLOII QD		\$ 1,200.00
805693-10	EZFLO II,HUD QD HOSE		\$ 1,680.00
805693-11	EZFLOII,HUD LONG HOSE		\$ 1,620.00
805693-16	EZFLOII,HUD,NXG2 REG.		\$ 1,620.00
805746-03	CEJN SOCKET ASSY		\$ 244.00
805746-04	36"HOSE&SCKT,LANYD W/CLMP		\$ 463.00
805746-05	72"HOSE&SCKT,LANYD W/CLMP		\$ 650.00
805746-06	4"HOSE&SCKT,LANYD W/CLMP		\$ 449.00
805753-01	AV3000 SPECTACLE KIT ASSY		\$ 60.00
805767-01	HOSE ASSEMBLY, EBSS		\$ 168.00
805767-02	HOSE ASSEMBLY, EBSS	DIS	\$ 168.00
805767-04	HOSE ASSEMBLY, EBSS		\$ 349.00
805769-01	HOSE & MANIFOLD ASSEMBLY		\$ 650.00
805769-02	HOSE & MANIFOLD ASSEMBLY	SVC	\$ 650.00
805771-01	FACE SEAL,SMALL,POLYISPORENE	DIS	\$ 163.00
805771-02	FACE SEAL,MEDIUM,POLYISOPRENE	DIS	\$ 163.00
805771-03	FACE SEAL, LARGE,POLYISOPRENE	DIS	\$ 163.00
805773-01	AV-3000(S) KVLR		\$ 434.00
805773-02	AV-3000(M) KVLR		\$ 434.00
805773-03	AV-3000(L) KVLR		\$ 434.00
805773-07	AV-3000(S) KVLR, W/BRKT		\$ 465.00

**Revision A**

Current revision date: December 1, 2018



**All prices listed herein supercede all other price lists, including (but not limited to) Scott master PDF price list. All prices are subject to change.**

**3M | Scott Fire & Safety Master Price List**

<b>ITEM</b>	<b>Product Description</b>	<b>Signal Code</b>	<b>List Price</b>
805773-08	AV-3000(M) KVLR, W/BRKT		\$ 465.00
805773-09	AV-3000(L) KVLR, W/BRKT		\$ 465.00
805773-71	AV-3000(S) KVLR	PHO	\$ 424.00
805773-72	AV-3000(M) KVLR	PHO	\$ 424.00
805773-73	AV-3000(L) KVLR	PHO	\$ 424.00
805773-74	AV-3000(S) KVLR, W/BRKT	PHO	\$ 455.00
805773-75	AV-3000(M) KVLR, W/BRKT	PHO	\$ 455.00
805773-76	AV-3000(L) KVLR, W/BRKT	PHO	\$ 455.00
805773-81	AV3 W/SURESEAL(S) KVLR		\$ 384.00
805773-82	AV3 W/SURESEAL(M) KVLR		\$ 384.00
805773-83	AV3 W/SURESEAL(L) KVLR		\$ 384.00
805773-84	AV3 W/SURESEAL(S) KVLR, W/BRKT		\$ 416.00
805773-85	AV3 W/SURESEAL(M) KVLR, W/BRKT		\$ 416.00
805773-86	AV3 W/SURESEAL(L) KVLR, W/BRKT		\$ 416.00
805774-07	AV3K, POLY HH, GRAY NC, SM	PHO	\$ 304.00
805774-08	AV3K, POLY HH, GRAY NC, MD	PHO	\$ 304.00
805774-09	AV3K, POLY HH, GRAY NC, LG	PHO	\$ 304.00
805774-81	AV3K, POLY , SURESEAL, SMALL		\$ 288.00
805774-82	AV3K, POLY , SURESEAL, MED		\$ 288.00
805774-83	AV3K, POLY , SURESEAL, LRG		\$ 288.00
805775-07	AV3K, RBR HARN, GRAY NC, SM	PHO	\$ 314.00
805775-08	AV3K, RBR HARN, GRAY NC, MD	PHO	\$ 314.00
805775-09	AV3K, RBR HARN, GRAY NC, LG	PHO	\$ 314.00
805775-81	AV3SS, RBR HARN, GRAY NC, SM		\$ 282.00
805775-82	AV3SS, RBR HARN, GRAY NC, MD		\$ 282.00
805775-83	AV3SS, RBR HARN, GRAY NC, LG		\$ 282.00

**Revision A**

Current revision date: December 1, 2018



**All prices listed herein supercede all other price lists, including (but not limited to) Scott master PDF price list. All prices are subject to change.**

**3M | Scott Fire & Safety Master Price List**

<b>ITEM</b>	<b>Product Description</b>	<b>Signal Code</b>	<b>List Price</b>
805782-01	VALVE, ASSY 2216 PSI	DIS	\$ 495.00
805783-01	VALVE, ASSY 4.5 PSI	DIS	\$ 540.00
805783-02	ASSY, NXG CYLINDER VALVE	DIS	\$ 530.00
805784-01	WIKA GAUGE ASSY, AIR-PAK 2.2 *		\$ 477.00
805784-02	WIKA GAUGE ASSY, AIR-PAK 4.5	SVC	\$ 487.00
805784-03	WIKA GAUGE ASSY, AIR-PAK 3.0		\$ 477.00
805807-01	KIT, LABEL, BEZEL, USER NAME		\$ 6.60
805808-01	HEADNET ASSY,KEVLAR, STD -KB-	DIS	\$ 183.00
805808-02	HEADNET ASSY,KEVLAR, LARGE-KB-	DIS	\$ 183.00
805809-01	HEADNET ASSY,POLY, STD		\$ 84.00
805809-02	HEADNET ASSY,POLY, LG		\$ 84.00
805810-01	PF2 PAPR,CHRGR,40MM ADAPTER	EOL	\$ 1,070.00
805810-03	PF2 PAPR,CHRGR	EOL	\$ 1,090.00
805816	ADAPTER KIT, OHD/XCEL FIT TEST		\$ 465.00
805825-01	SMAC-1,2 OUTLET,HANSEN, L/CYL		\$ 2,900.00
805825-04	MOBILE AIR CART,SCH,CYL DECK		\$ 2,900.00
805826-01	SMAC-2,4 OUTLET,HANSEN, L/CYL		\$ 3,050.00
805826-04	MOBILE AIR CART,SCH,CYL DECK		\$ 3,050.00
805827-01	SMAC-3,4 OUTL W/TOOL,L/CYL		\$ 3,520.00
805827-04	MOBILE AIR CART,SCH,CYL DECK		\$ 3,520.00
805827-07	MOBILE AIR CART,FOSTER,CYL DK		\$ 3,520.00
805827-13	MOBILE AIR CART,CEJN,CYL DECK		\$ 4,340.00
805833-01	BATTY COMPARTMENT ASSY,AIR-PAK	EOL	\$ 700.00
805884-01	ASSEMBLY, 4.5 CGA	DIS	\$ 176.00
805885-01	ASSEMBLY, 2.2, CGA	DIS	\$ 176.00
805886-01	ASSY,REDUCER MOUNTING	DIS	\$ 43.30



**Revision A**

Current revision date: December 1, 2018



**All prices listed herein supercede all other price lists, including (but not limited to) Scott master PDF price list. All prices are subject to change.**

**3M | Scott Fire & Safety Master Price List**

<b>ITEM</b>	<b>Product Description</b>	<b>Signal Code</b>	<b>List Price</b>
805896-11	PAD ASSY,SHLDER,STIFF,LEFT MAL	DIS	\$ 143.00
805896-21	PAD ASSY,SHDR,STIFF,RIGHT,MAL	DIS	\$ 151.00
805917-02	NXG ELECT ENCL ASSY 4.5 PASS *	EOL	\$ 1,220.00
805918-01	NXG2 PASS & GAUGE ASY,2216 PSI		\$ 2,480.00
805918-02	NXG2 PASS & GAUGE ASY,4500 PSI		\$ 2,480.00
805947-02	CYL&VLV,CARB,5 MIN 3.0 LOW RE		\$ 630.00
805948-02	CYL&VLV,CARB,10 MIN 3.0 LOW R		\$ 710.00
805954-01	ASSEMBLY, EEOSTI, 2216 PSI		\$ 630.00
805954-02	ASSEMBLY,EEOSTI,4500 PSI	SVC	\$ 640.00
805954-03	ASSEMBLY, EEOSTI, 3000 PSI		\$ 630.00
805954-04	ASSEMBLY, EEOSTI A/T 2216 PSI		\$ 630.00
805954-05	ASSEMBLY, EEOSTI A/T 3000 PSI	SVC	\$ 640.00
805954-06	ASSEMBLY, EEOSTI A/T 4500 PSI		\$ 630.00
805955-01	LED ASSY, ELECTRONICS ENCLOSRE	DIS	\$ 89.00
805964-01	REMOVABLE WAIST STRAP	DIS	\$ 74.00
805964-02	STRAP,WAIST,REMOVABLE	DIS	\$ 74.00
89105-01	RECORD CARD,MAINTENANCE	EXP	\$ 2.30
AB10009	VALVE,NEEDLE		\$ 18.40
AB10064	VALVE, 2ND STAGE SUCTION-7		\$ 477.00
AB10065	VALVE, 2ND STG DELIVERY-7		\$ 750.00
AB10-2101-01	RA UNIT WO/P NB,NR		\$ 8,500.00
AB10244	SEAL,OIL FRONT CRANKCASE-24		\$ 26.00
AB10860	PAD, PISTON END		\$ 30.30
AB110-0019	DANGER LABEL, AIR	EXP	\$ 11.00
AB110-0046	ASME RECEIVER ADAPTER WELDMT		\$ 153.00
AB110-0072	BOLT,1/4-20X.500 GRD 2 HXHD ZI		\$ 0.40

**Revision A**

Current revision date: December 1, 2018



**All prices listed herein supercede all other price lists, including (but not limited to) Scott master PDF price list. All prices are subject to change.**

**3M | Scott Fire & Safety Master Price List**

<b>ITEM</b>	<b>Product Description</b>	<b>Signal Code</b>	<b>List Price</b>
AB110-0096	FAN SHROUD,INGERSOLL COMPRESS		\$ 191.00
AB110-0099	BEARING BLOCK ASSY		\$ 182.00
AB110-0116	MOTOR MONITOR MOUNT BRACKET		\$ 61.00
AB110-0117	OFFSET ROCKER,REVOLVE AIR		\$ 17.10
AB110-0121	TRAILER BUMPER WELDMENT		\$ 2,110.00
AB110-0140	CYLINDER LOADING RACK,GUARDIAN		\$ 164.00
AB110-0148	PRIMARY FUSE BLOCK		\$ 104.00
AB110-0177	COUPLER,2-5/16 BALL		\$ 244.00
AB110-0213	COVER, REEL CORD		\$ 62.00
AB110-0215	SIDE PANEL ASSY,LH TANDEM		\$ 1,960.00
AB110-0218	SIDE PANEL ASSY,RH TANDEM		\$ 1,960.00
AB110-0247	PURIFIER MOUNT WELDMENT		\$ 436.00
AB110-0273	INSULATION,3/4" FOAM,BLUE,R4	EXP	\$ 58.00
AB110-0276	SUPPORT BAR (INSIDE FRAME/PUR)		\$ 37.25
AB110-0292	SURGE SUPPRESSOR		\$ 79.00
AB110-0320	MODIFICTION INST.SCUBA(REV-AIR	EXP	\$ 0.30
AB110-0321	SCUBA KIT INST & USE INSTR	EXP	\$ 0.20
AB110-0348	PIPE COUPLING, 1-1/4 NPT		\$ 14.10
AB110-0349	BLACK STEEL PIPE NIPPLE, 3"		\$ 8.00
AB110-0350	BLACK STEEL PIPE NIPPLE, 4"		\$ 10.70
AB110-0356	CABLE TIE HOLDER/ALLEN WR HLDR	EXP	\$ 0.80
AB110-0358	CABLE TIES, 4"	EXP	\$ 0.30
AB110-0414	HINGE, ELEC. DOOR		\$ 205.00
AB110-0440	SPACER,TRUNNION VALVE	EXP	\$ 20.50
AB110-0444	LIGHT REEL MOUNT		\$ 65.00
AB110-0454	SHIELD HANGER		\$ 80.00

**Revision A**

Current revision date: December 1, 2018



**All prices listed herein supercede all other price lists, including (but not limited to) Scott master PDF price list. All prices are subject to change.**

**3M | Scott Fire & Safety Master Price List**

ITEM	Product Description	Signal Code	List Price
AB110-0457	HYD.SURGE BRAKE ACTUATOR		\$ 1,350.00
AB110-0488	COVER,FRONT,L./R.H.RED BARON		\$ 88.00
AB110-0490	230VAC DUMP SOLENOID		\$ 281.00
AB110-0491	FITTING,END TRUNNION VALVE		\$ 44.25
AB110-0492	FITTING,END GASKET TRUN VALVE		\$ 5.30
AB110-0508	VALVE,1/4NPT 6000 PSIG		\$ 122.00
AB110-0514	DUMMY ASME, FOR 1 TANK RACK		\$ 34.75
AB110-0516	CHECK VALVE, H15T6		\$ 497.00
AB110-0535	DECAL,PARKING BRAKE	EXP	\$ 0.30
AB110-0536	DECAL,WARN,BRAKE/LIGHT TOWER	EXP	\$ 0.20
AB110-0541	TEE,1/4 NPTF MALE PIPE		\$ 32.40
AB110-0571	LONG TREAD PLATE	EOL	\$ 33.90
AB110-0581	DUMMY ASME, 3&5 TANK RACKS		\$ 35.80
AB110-0582	TERMINAL SPLITTER, DBL MALE		\$ 0.60
AB110-0585	NO STEP DECAL	EXP	\$ 4.10
AB110-0588	SAFETY ASSEMBLY		\$ 3.80
AB110-0591	NIPPLE COUPLING		\$ 14.10
AB110-0597	DECAL,SBAS APPLIQUE 9X14	DIS	\$ 39.30
AB110-0598	COIL,DUMP SOLENOID 230VAC		\$ 90.00
AB110-0600	PANEL,4 GAGE FRONT		\$ 152.00
AB110-0628	U-BOLT,ASME CYLINDERS,TRAILER		\$ 9.75
AB110-0639	ADAPTER,CGA702 FEMX1/4NPTF BRS		\$ 77.00
AB110-0640	1-1/2" CLAMP LIGHT TOWER MAST		\$ 61.00
AB110-0641	MOTOR,7.5HP,50HZ,3PH,2850 RPM		\$ 1,520.00
AB110-0642	COVER,WALL MOUNT		\$ 49.10
AB110-0687	DUMP CAN HOLDER, TRAILER		\$ 124.00

**Revision A**

Current revision date: December 1, 2018



**All prices listed herein supercede all other price lists, including (but not limited to) Scott master PDF price list. All prices are subject to change.**

**3M | Scott Fire & Safety Master Price List**

ITEM	Product Description	Signal Code	List Price
AB110-0697	BOX,LIGHT TOWER		\$ 278.00
AB110-0701	SHAFT,ENGINE	DIS	\$ 371.00
AB110-0721	CONTACTOR,7.5HP\15HP		\$ 228.00
AB110-0723	CONTACTOR,10HP,208/240V/3PH		\$ 174.00
AB110-0724	CRANKCASE OIL FILTER NA12&NA18		\$ 26.00
AB110-0725	CONTACTOR,5HP,208/240V/1PH	DIS	\$ 165.00
AB110-0726	CONTACTOR,5HP,208/240V/3PH	DIS	\$ 128.00
AB110-0727	CONTACTOR,10HP,208/240V/1PH		\$ 184.00
AB110-0750	WHEEL & TIRE ASSEMBLY 16"		\$ 820.00
AB110-0764	LIFT AND TURN LATCH		\$ 33.75
AB110-0765	GENERATOR,7.2KW,120/240V 360		\$ 1,900.00
AB110-0767	FUSE,.8A 600VAC		\$ 41.50
AB110-0768	FUSE,.6A 600VAC		\$ 41.50
AB110-0769	MOBILE RA MOUNTING ANGLE		\$ 119.00
AB110-0788	SCREW,10-24 X 1/2 SS PAN HD		\$ 0.40
AB110-0790	CONTROLLER CABLE,40FT LONG		\$ 393.00
AB110-0806	SCREW,1/4-20 X 5/8 PAN HD PHIL		\$ 0.70
AB110-0819	LED FLOODLIGHT 45 WATT		\$ 75.00
AB110-0821	REMOTE INTAKE,COLTRI 5 & 7.5HP		\$ 59.00
AB110-0822	REMOTE INTAKE,HAM 7.5 & 10 HP		\$ 354.00
AB110-0822E	REMOTE INT ENCL,HAM 7.5&10 HP		\$ 148.00
AB110-0824	REMOTE INTAKE,ING 15 & 20HP		\$ 311.00
AB110-0824E	REMOTE INT ENCL,IR 15&20HP		\$ 324.00
AB110-0891	INLET VACUUM AIR FILTER		\$ 297.00
AB110-0895	MOTOR,7.5HP,208VAC 1PH		\$ 2,250.00
AB110-0899	MOTOR,10HP,208VAC 1PH		\$ 2,260.00

**Revision A**

Current revision date: December 1, 2018



**All prices listed herein supercede all other price lists, including (but not limited to) Scott master PDF price list. All prices are subject to change.**

**3M | Scott Fire & Safety Master Price List**

<b>ITEM</b>	<b>Product Description</b>	<b>Signal Code</b>	<b>List Price</b>
AB110-0920	FAN BELT, LOMBARDINI		\$ 121.00
AB110-0934	DISC, 9KSI BURST	DIS	\$ 5.90
AB110-0935	CORDSET, 125V TWIST LOCK		\$ 230.00
AB110-0962	COIL, DUMP SOLENOID, 12VDC		\$ 88.00
AB110-0965	BUTTON, OVERLOAD RESET		\$ 25.00
AB110-0974	1/4-20UNC X .5 HX HD BOLT ZINC		\$ 0.40
AB110-0984	FRAME PANEL		\$ 423.00
AB110-0999	DOT WALL MOUNT, 34" UN-STRUT		\$ 175.00
AB110-1012	FUSE, .6A, 380VOLT		\$ 6.40
AB110-1014	PURIFICATION BASE		\$ 407.00
AB110-1015	GROMMET, 2.88 OD X 2.125 ID	EXP	\$ 6.75
AB110-1019	CONTACTOR, 10HP 50Z, 380V 3PH		\$ 163.00
AB110-1020	CORD GRIP, 90 DEGREE		\$ 64.00
AB110-1023	VALVE, RELIEF ADJUSTMENT, 6500		\$ 182.00
AB110-1024	LUNETTE EYE, 3"		\$ 115.00
AB110-1032	FUSE, 2.5A, 250V, CERAMIC		\$ 7.75
AB110-1052	X4 E-STOP, HORN & CABLE KIT	DIS	\$ 182.00
AB110-1055	LOMBARD ENG CONTROL BX, RECT		\$ 940.00
AB110-1056	LOMBARD ENG CONTROL BX, SQUARE	SVC	\$ 1,110.00
AB110-1069	1/8NPT-165LB-SAFETY VALVE		\$ 23.90
AB110-1070	1/8TUBEX1/8NPT STR PRESTOLOK		\$ 6.75
AB110-1076	BELT, ENGINE/7.2 GENERATOR, TRAI		\$ 111.00
AB110-1079	GEN PULLEY, ENG/GEN ON TRAIL		\$ 179.00
AB110-1081	PISTON, VALVE		\$ 218.00
AB110-1082	O-RING		\$ 16.25
AB110-1099	ELECTRIC MTR 60HP 3 PHASE		\$ 6,140.00

**Revision A**

Current revision date: December 1, 2018



**All prices listed herein supercede all other price lists, including (but not limited to) Scott master PDF price list. All prices are subject to change.**

**3M | Scott Fire & Safety Master Price List**

ITEM	Product Description	Signal Code	List Price
AB110-1103	V-BELT NOTCHED 86 LONG (OD)		\$ 35.00
AB110-1108	SEQUENCE VALVE-6000 PSI		\$ 395.00
AB110-1118	CONTR 60HP,60HZ,230V,3PH		\$ 860.00
AB110-1120	RELAY,60HP,230V,3PH THERM OVLD		\$ 750.00
AB110-1132	CONTROLLER CABLE,50 FT LONG		\$ 414.00
AB110-1133	SOLENOID/CONN ASSY,HIGH SPEED		\$ 168.00
AB110-1134	SOLENOID/CONN ASSY, CLUTCH		\$ 256.00
AB110-1165	KEY,REPLACEMENT		\$ 12.10
AB110-1237	ENGINE PULLEY,MOD ON TRAILERS		\$ 282.00
AB110-1245	BELT GUARD BASE 60 HZ GENERATO		\$ 160.00
AB110-1246	BELT GUARD FRONT COVER 60 HZ G		\$ 94.00
AB110-1265	SHIM(.010)		\$ 10.70
AB110-1268	INTAKE FILTER CARTRIDGE		\$ 27.10
AB110-1281	STRAP, CONDENSATE CONTAINER		\$ 302.00
AB110-1302	HOSE, HYD, 1-1/4ID, NO SKIVE		\$ 2.80
AB110-1318	CABLE 1AWG LOCOMOTIVE		\$ 1.10
AB110-1324	WIRE, 4 AWG, GREEN		\$ 0.60
AB110-1325	FLEX. COND. 2" GRAY		\$ 1.70
AB110-1327	QUICK DISC. SOCKET 3/8		\$ 51.00
AB110-1335	1/4 FLAREX1/4NPT SWIVEL CONNEC		\$ 22.90
AB110-1336	SCREW,HX HD, 10-32, 1/2 LONG	EXP	\$ 0.40
AB110-1338	TEE,1/2,MALE RUN,STEEL		\$ 35.10
AB110-1339	NIPPLE,1/2X3,NPT,PIPE		\$ 2.80
AB110-1345	IDLER ADJUSTING ARM, TRAILERS		\$ 147.00
AB110-1346	IDLER ROLLER IDLER ARM TRAILER	DIS	\$ 166.00
AB110-1347	SCREW, M12 X 1.75 X 110MM,SHCS		\$ 5.60

**Revision A**

Current revision date: December 1, 2018



**All prices listed herein supercede all other price lists, including (but not limited to) Scott master PDF price list. All prices are subject to change.**

**3M | Scott Fire & Safety Master Price List**

<b>ITEM</b>	<b>Product Description</b>	<b>Signal Code</b>	<b>List Price</b>
AB110-1348	NUT, LOCKNUT, M12 X 1.75MM, HE		\$ 16.25
AB110-1349	MOUNTING PLATE GENERATOR TRAIL		\$ 494.00
AB110-1352	FLOW FUSE MOD443 6KPSI 1/4NPT		\$ 87.00
AB110-1355	FUSE,1A,600V,FNQ-R		\$ 32.40
AB110-1359	NUT, NYLON LOCKNUT 5/16-18		\$ 0.30
AB110-1360	NUT, NYLON LOCKNUT 3/8-16		\$ 0.60
AB110-1362	STUD SELF LOCKING THRD 7/16-14		\$ 2.60
AB110-1363	SCREW, SHCS 3/8-16 X 2.00		\$ 1.40
AB110-1385	GAUGE, RED LINED, 0-10,000 PSI	SVC	\$ 132.00
AB110-1386	MOTOR,5HP,208VAC 1PH		\$ 820.00
AB110-1387	GAUGE,BTM MNT,0-10,000 PSI		\$ 130.00
AB110-1398	OIL LEVEL SWITCH	DIS	\$ 269.00
AB110-1399	O-RING FOR OIL SWITCH		\$ 10.90
AB110-1400	MOUNT PLATE, OIL SWITCH		\$ 245.00
AB110-1402	WASHER FOR ACORN NUT (1ST STAG		\$ 17.30
AB110-1403	O-RING, LARGE, 1ST STAGE	DIS	\$ 7.75
AB110-1404	O-RING, SMALL, 1ST STAGE	DIS	\$ 8.30
AB110-1405	VALVE ASSEMBLY, COMPLETE, 1ST		\$ 890.00
AB110-1406	COPPER WASHER, UPPER, 2ND STAG		\$ 71.00
AB110-1407	VALVE ASSEMBLY, 2ND STAGE		\$ 2,040.00
AB110-1408	COPPER WASHER, LOWER, 2ND STAG		\$ 72.00
AB110-1409	VALVE ASSEM COMP W/SEALS, 3RD		\$ 2,660.00
AB110-1410	VALVE ASSEM COMP W/SEALS, 4TH		\$ 2,490.00
AB110-1411	CHECK VALVE, CONDENSATE TRAY &		\$ 810.00
AB110-1412	REAR CRANKCASE COVER GASKET	DIS	\$ 44.60
AB110-1413	GAUGE, 0-100PSI	DIS	\$ 146.00

**Revision A**

Current revision date: December 1, 2018



**All prices listed herein supercede all other price lists, including (but not limited to) Scott master PDF price list. All prices are subject to change.**

**3M | Scott Fire & Safety Master Price List**

<b>ITEM</b>	<b>Product Description</b>	<b>Signal Code</b>	<b>List Price</b>
AB110-1414	GAUGE, 0-600PSI		\$ 231.00
AB110-1415	GAUGE, 0-2000PSI	DIS	\$ 231.00
AB110-1416	GAUGE, 0-10,000PSI		\$ 230.00
AB110-1417	OIL SWITCH (H15T6)		\$ 620.00
AB110-1418	OIL FILL CAP (H15T6)		\$ 129.00
AB110-1419	4TH STAGE SAFETY DISC		\$ 143.00
AB110-1420	VALVE GASKET, 88MM, 1ST STAGE		\$ 61.00
AB110-1421	VALVE GASKET, 95MM, 1ST STAGE	DIS	\$ 61.00
AB110-1422	VALVE ASSEMBLY, 1ST STAGE		\$ 700.00
AB110-1423	VALVE GASKET, LOWER, 1ST STAGE		\$ 73.00
AB110-1425	INLET VALVE, 2ND STAGE		\$ 201.00
AB110-1427	EXHAUST VALVE, 2ND STAGE		\$ 301.00
AB110-1428	O-RING, 2ND STAGE		\$ 6.75
AB110-1429	SAFETY RELEIF VALVE, 2ND STAGE		\$ 233.00
AB110-1430	INLET VALVE, 3RD STAGE		\$ 167.00
AB110-1431	EXHAUST VALVE, 3RD STAGE		\$ 167.00
AB110-1432	O-RING EXHAUST VALVE 3RD STAGE		\$ 6.75
AB110-1433	UPPER CAP, CONDENSATE SEPARATO		\$ 135.00
AB110-1434	O-RING, UPPER OR LOWER		\$ 6.75
AB110-1435	LOWER CAP,CONDENSATE SEPARATOR		\$ 68.00
AB110-1436	UPPER CAP, PURIFIER		\$ 73.00
AB110-1437	INTERNAL CAP, PURIFIER		\$ 73.00
AB110-1438	LOWER CAP, PURIFIER		\$ 73.00
AB110-1439	LOWER BODY, PMV		\$ 214.00
AB110-1440	STEEL BALL, PMV		\$ 13.00
AB110-1441	PISTON, PMV		\$ 102.00



**Revision A**

Current revision date: December 1, 2018



**All prices listed herein supercede all other price lists, including (but not limited to) Scott master PDF price list. All prices are subject to change.**

**3M | Scott Fire & Safety Master Price List**

ITEM	Product Description	Signal Code	List Price
AB110-1442	BELLEVILLLE WASHER SET, PMV		\$ 102.00
AB110-1443	CAP, PMV		\$ 135.00
AB110-1444	COPPER VALVE GASKET		\$ 6.80
AB110-1445	OIL FILLER CAP		\$ 21.80
AB110-1464-2	C/O SENSOR WITH CABLE		\$ 820.00
AB110-1464-4	SBAS CONTROLLER I/O BOARD		\$ 366.00
AB110-1464-5	SOFTWARE DOWNLOAD CABLE		\$ 130.00
AB110-1464-6	STATIONARY CONTROLLER CABLE		\$ 304.00
AB110-1464-7	MOBILE CONTROLLER CABLE		\$ 184.00
AB110-1464-8	CABLE ADAPTER, 25'		\$ 335.00
AB110-1464-810	CABLE ADAPTER, 100'		\$ 650.00
AB110-1464-850	CABLE ADAPTER, 50'		\$ 473.00
AB110-1464-875	CABLE ADAPTER, 75'		\$ 560.00
AB110-1476	NAMEPLATE, TRAILER, LIBERTY		\$ 18.50
AB110-1539	LOCATOR ENGINE PULLEY SYS TRIL		\$ 23.60
AB110-1557	NIPPLE, 1/8 X 2.5" NPT		\$ 8.30
AB110-1560	PNL,CNTRL,W/X4,LIB I-36		\$ 203.00
AB110-1561	ELBOW 1/8TUBEX1/4NPT SWIVEL PRE		\$ 26.00
AB110-1563	ELBOW 1/8TUBEX1/8NPT PRESTOLOK		\$ 10.90
AB110-1564	1/8NPT-250LB-SAFETY VALVE		\$ 23.90
AB110-1566	MOTOR,15HP/208V/3PH/60HZ		\$ 2,310.00
AB110-1567	MOTOR,20HP/208V/3PH/60HZ		\$ 3,490.00
AB110-1570	MOTOR,7.5HP/208V/3PH/60HZ		\$ 1,900.00
AB110-1571	MOTOR,10HP/208V/3PH/60HZ		\$ 2,330.00
AB110-1573	ADAPTER, 1/4BSPP X 1/4NPTF		\$ 23.90
AB110-1574	PRESS RELIEF VALVE 650PSIG ASM		\$ 127.00

**Revision A**

Current revision date: December 1, 2018



**All prices listed herein supercede all other price lists, including (but not limited to) Scott master PDF price list. All prices are subject to change.**

**3M | Scott Fire & Safety Master Price List**

ITEM	Product Description	Signal Code	List Price
AB110-1575	PRESS RELIEF VALVE 1400PSIG AS		\$ 130.00
AB110-1600	THERMOCOUPLE-TYPE J		\$ 141.00
AB110-1601	4ANX1/8NPTSWIVELSTRT		\$ 31.40
AB110-1602	4ANX1/4NPTBLKHD		\$ 48.00
AB110-1607	REGULATOR-INLINE-REDUCING	SVC	\$ 216.00
AB110-1615	SEAT, PURGE VALVE		\$ 44.60
AB110-1616	SPOOL,PURGE VALVE	SVC	\$ 24.10
AB110-1617	O-RING, .114 X .070, #2-006	SVC	\$ 0.40
AB110-1618	O-RING, 1.364 X .070, #2-028	SVC	\$ 1.00
AB110-1623	COLTRI 3RD ST. DUMP VLV KIT		\$ 383.00
AB110-1629-01	RADIATOR, LOMBARDINI ENGINE		\$ 2,470.00
AB110-1638	SWITCH, TRLR LIGHTS AND GENERA		\$ 22.30
AB110-1646	PISTON SWITCH 3650-7500PSI ADJ		\$ 194.00
AB110-1651	MOTOR 20HP 1760RPM 230/460V OD		\$ 2,320.00
AB110-1658	STRAIN RELIEF, LIQUID TIGHT	DIS	\$ 12.00
AB110-1660	O-RING SEAL		\$ 2.00
AB110-1674	TOP STRAP MOUNT		\$ 120.00
AB110-1680	OPERATING INSTRUCTIONS		\$ 49.90
AB110-1686	COLTRI FILTER ACCESS COVER		\$ 2,180.00
AB110-1692	12" BEADED CHAIN		\$ 0.30
AB110-1699	GAUGE-1.5"-DUAL READING PRESSU		\$ 44.60
AB110-1700	REGULATOR,LP,PURGE VALVE		\$ 134.00
AB110-1702	MUFFLER, 210 CFM EXHAUST		\$ 42.50
AB110-1704	NUT-PANEL MNT REGULATOR		\$ 6.75
AB110-1707	CLAMP .68 - 1.25 SS WORM DRIVE		\$ 4.10
AB110-1709	UNION, HEX, 4AN X 4AN		\$ 9.00

**Revision A**

Current revision date: December 1, 2018



**All prices listed herein supercede all other price lists, including (but not limited to) Scott master PDF price list. All prices are subject to change.**

**3M | Scott Fire & Safety Master Price List**

<b>ITEM</b>	<b>Product Description</b>	<b>Signal Code</b>	<b>List Price</b>
AB110-1710	ADAPTER, FEM DIN X 1/4 NPT FEM		\$ 35.80
AB110-1713	FILTER-1/8NPT INLINE,40 MICRON		\$ 21.80
AB110-1714	DANGER LABEL WHEEL LUG TORQUE		\$ 45.00
AB110-1715	BOLT 5/8-11 X 3-1/2 GRD 8 HXHD		\$ 9.40
AB110-1716	TENSIONER MOUNT IDLER TRAILER		\$ 141.00
AB110-1717	SEAL COPPER HEAD VALVE BODY 4T	SVC	\$ 15.30
AB110-1718	BACK-UP RING TEFLON 4TH STAGE	SVC	\$ 19.60
AB110-1719	RING RETAINING 4TH STAGE		\$ 82.00
AB110-1720	STOP INLET VALVE PLATE 4TH STA		\$ 428.00
AB110-1721	SPRING INLET VALVE 4TH STAGE		\$ 217.00
AB110-1722	PLATE INLET VALVE 4TH STAGE		\$ 213.00
AB110-1723	SEAT INLET DISCHARGE 4TH STAGE		\$ 930.00
AB110-1724	PLATE DISCHARGE 4TH STAGE		\$ 166.00
AB110-1725	GASKET COPPER 4TH STAGE	SVC	\$ 109.00
AB110-1726	SPRING DISCHARGE 4TH STAGE	DIS	\$ 169.00
AB110-1727	CAGE VALVE 4TH STAGE		\$ 1,520.00
AB110-1728	RINGS, FLOATING PISTON 4TH STA		\$ 1,320.00
AB110-1729	GASKET UPPER FLANGE CYL/CR 4TH		\$ 25.00
AB110-1730	GASKET LOWER FLANGE 4TH STAGE		\$ 38.25
AB110-1731	O-RING, 4TH STAGE	SVC	\$ 15.30
AB110-1732	BURST DISC CAP ASSY, 9000PSI		\$ 8.50
AB110-1761	WALL MNT BRCKT,X4		\$ 116.00
AB110-1768	PUSHER FAN FOR LDW 2204		\$ 238.00
AB110-1802	HX BOLT 7/16X4.00 GRD5 STL		\$ 2.80
AB110-1812	ASSY, REED VALVE, FIRST STAGE		\$ 1,540.00
AB110-1813	EXTENSION CABLE, THERMOCOUPLE		\$ 54.00

**Revision A**

Current revision date: December 1, 2018



**All prices listed herein supercede all other price lists, including (but not limited to) Scott master PDF price list. All prices are subject to change.**

**3M | Scott Fire & Safety Master Price List**

<b>ITEM</b>	<b>Product Description</b>	<b>Signal Code</b>	<b>List Price</b>
AB110-1830	SHAFT-MOTOR PLATE-SA COMP.		\$ 51.00
AB110-1838	SPRING, 1/4 TURN, S.S.		\$ 0.60
AB110-1840	12MM EXT SNAP RING		\$ 0.40
AB110-1841	PURIFIER BASE		\$ 222.00
AB110-1842	PURIFIER HOUSING		\$ 970.00
AB110-1843	PURIFIER CAP		\$ 175.00
AB110-1844	PURIFIER TUBE		\$ 19.40
AB110-1846	TRAILER WIRING HARNESS		\$ 830.00
AB110-1847	COIL, DRAIN SOLENOID		\$ 70.00
AB110-1848	SPRING-.845 O.D X 1.00 LONG	DIS	\$ 10.70
AB110-1849	SPRING-.475 O.D X 1.00 LONG	DIS	\$ 4.30
AB110-1850	PURIFIER STEM, LONG		\$ 25.00
AB110-1851	PURIFIER COAL. HEX FITTING		\$ 21.80
AB110-1865	CUP WASHER, 1/4 TURN, NYLON		\$ 0.60
AB110-1871	SUPPORT BRKT-GUARD-HA		\$ 60.00
AB110-1880	NUT, LOCK (1/2" NPS, ZINC)		\$ 6.75
AB110-1890	O-RING, 2ND STG VALVE GUIDE		\$ 8.30
AB110-1893	GASKET, 1ST STG HEAD		\$ 33.75
AB110-1894	SEALING WASHER, 3RD STAGE		\$ 25.00
AB110-1895	O-RING, 3RD STG VALVE ASSY		\$ 30.30
AB110-1896	SPRING, 3RD STG DELIVERY VALVE		\$ 33.75
AB110-1897	PLATE, 3RD STG DELIVERY VALVE		\$ 222.00
AB110-1898	WASHER, COPPER, 3RD STG DEL VLV		\$ 25.00
AB110-1899	PLATE, 3RD STAGE SUCTION VALVE		\$ 215.00
AB110-1900	RING, 3RD STAGE VALVE RETAINING		\$ 156.00
AB110-1901	SEAT, 3RD STG SUCTION/DELIVERY		\$ 720.00

**Revision A**

Current revision date: December 1, 2018



**All prices listed herein supercede all other price lists, including (but not limited to) Scott master PDF price list. All prices are subject to change.**

**3M | Scott Fire & Safety Master Price List**

<b>ITEM</b>	<b>Product Description</b>	<b>Signal Code</b>	<b>List Price</b>
AB110-1902	VALVE REMOVAL TOOL		\$ 97.00
AB110-1903	WASHER, 3RD STG COPPER 8MM		\$ 6.75
AB110-1904	O-RING, 3RD STAGE VITON		\$ 6.75
AB110-1905	O-RING, 504, 504H RELIEF VALVE		\$ 0.50
AB110-1906	O-RING, PV SAE J200		\$ 0.40
AB110-1907	BOLT, KNURLED HEAD		\$ 7.50
AB110-1908	NUT, TABBED (BENCH NUT)		\$ 1.10
AB110-1909	O-RING, I/R CHECK VALVE		\$ 6.40
AB110-1916	HINGE, DOOR, LIBERTY I		\$ 480.00
AB110-1919	PURIFIER CHAMBER, MCH-16		\$ 1,950.00
AB110-1920	WASHER-12MM SUPPORT		\$ 3.75
AB110-1922	BOTTLE-CONDESATE-SA		\$ 29.25
AB110-1926	RECEPTICAL, 1/4 TURN, STEEL		\$ 1.25
AB110-1927	STUD, 1/4 TURN, KNURLED		\$ 4.10
AB110-1928	RETAINER, 1/4 TURN, NYLON		\$ 0.40
AB110-1958	OIL FILTER, W70H-AL		\$ 126.00
AB110-1959	INTAKE OIL SEPARATOR W70H-AL		\$ 660.00
AB110-1966	DRILL TEMPLATE, LE4000		\$ 19.40
AB110-1967	ROLL, HEAT TAPE		\$ 26.00
AB110-1987	8" PIPE CLAMP, STRUT		\$ 22.00
AB110-1999	CLAMP,7/16-25/32,SS,WORM,HOSE		\$ 2.00
AB1102	VALVE,6KPSI 1/4NPTF PM SHUTOFF		\$ 367.00
AB110-2001	STEM, STANDARD, 65AL		\$ 68.00
AB110-2007	RA SHIM,UPPER SPINDLE	EXP	\$ 2.50
AB110-2024	RA LOWER SPINDLE		\$ 95.00
AB110-2029	RA UPPER SPINDLE		\$ 75.00

**Revision A**

Current revision date: December 1, 2018



**All prices listed herein supercede all other price lists, including (but not limited to) Scott master PDF price list. All prices are subject to change.**

**3M | Scott Fire & Safety Master Price List**

<b>ITEM</b>	<b>Product Description</b>	<b>Signal Code</b>	<b>List Price</b>
AB110-2036	NIPPLE, 1/4NPTX4" LONG		\$ 59.00
AB110-2042	205 SEALED BRG		\$ 11.10
AB110-2044	CAUTION SIGN, INTK. BRTH. AIR		\$ 91.00
AB110-2055	HEX BOLT, 1/4-20 SEMS W/LW&FW		\$ 3.40
AB110-2059	NARROW RECEPTALCE		\$ 1.10
AB110-2064	DECAL, STD CTRL PNL		\$ 43.80
AB110-2066	GROMMET, 2.13 O.D X 1.50 I.D.		\$ 3.75
AB110-2067	SPRING PIN 1/8X.75		\$ 3.75
AB110-2069	DECAL, DPR CTRL PNL		\$ 52.00
AB110-2076	SPRING, PNEUMATIC DUMP VALVE		\$ 5.60
AB110-2082	OVERLOAD, SOLID ST 18-90A 3PH	SVC	\$ 136.00
AB110-2083	OVERLOAD, SOLID ST 9-45A 3PH		\$ 129.00
AB110-2084	CLOSING PLUG, RESET BUTTON		\$ 8.80
AB110-2087	OVERLOAD, SOLID ST 9-45A 1PH		\$ 135.00
AB110-2088	OVERLOAD, SOLID ST 18-90A 1PH		\$ 135.00
AB110-2089	OVERLOAD, SOLID ST 5.4-27A 3PH		\$ 76.00
AB110-2090	CYL VLV DOT 4500PSI 25E THRD		\$ 136.00
AB110-2091	CYL VLV DOT 5000PSI 25E THRD		\$ 136.00
AB110-2092	CYL VLV DOT 6000PSI 25E THRD		\$ 136.00
AB110-2099	SPRING, 2ND, 3RD, 4TH STG VALVE		\$ 5.90
AB110-2100	SCOTT, RHT TEST SIMULATOR		\$ 298.00
AB110-2101	PLATE, 2ND, 3RD, 4TH STG VALVE		\$ 5.90
AB110-2108	SPRING, DISCHG VLV 1ST STAGE		\$ 198.00
AB110-2109	PLATE, DISCHG VLV 1ST STAGE		\$ 140.00
AB110-2110	SPRING, INLET VALVE 1ST STAGE		\$ 102.00
AB110-2111	PLATE, INLET VALVE 1ST STAGE		\$ 188.00

**Revision A**

Current revision date: December 1, 2018



**All prices listed herein supercede all other price lists, including (but not limited to) Scott master PDF price list. All prices are subject to change.**

**3M | Scott Fire & Safety Master Price List**

<b>ITEM</b>	<b>Product Description</b>	<b>Signal Code</b>	<b>List Price</b>
AB110-2112	SPRING,DISCHG VALVE, 2ND STAGE		\$ 178.00
AB110-2113	PLATE,DISCHG VALVE, 2ND STAGE		\$ 137.00
AB110-2114	SPRING,INLET VALVE,2ND STAGE		\$ 89.00
AB110-2118	SPRIING, INLET,3RD STAGE		\$ 70.00
AB110-2123	GASKET SET		\$ 289.00
AB110-2128	SWITCH PLATE,BALDOR 5,7.5,10		\$ 70.00
AB110-2139	O-RING, 52 SERIES FILTER		\$ 0.60
AB110-2160	GASKET,COPPER 4TH STAGE HEAD		\$ 6.25
AB110-2161	O-RING 4TH STG CYL TO C/CASE		\$ 6.25
AB110-2163	ROD, CONNECTING,4TH STAGE		\$ 154.00
AB110-2164	PIN, WRIST 4TH STG CONNECT ROD		\$ 22.90
AB110-2165	CLIP, WRIST PIN 4TH STAGE		\$ 6.25
AB110-2166	PISTON, 4TH STAGE		\$ 109.00
AB110-2167	CYLINDER, 4TH STAGE		\$ 332.00
AB110-2169	O-RING, SEPARATOR END CAP		\$ 6.40
AB110-2174	VALVE,MANUAL DRAIN, 1/8NPT		\$ 96.00
AB110-2175	V-BELT, ELECTRIC EASY AIR		\$ 14.25
AB110-2176	V-BELT,GAS POWERED EASY AIR		\$ 14.10
AB110-2177	RA SCUBA SUPPORT		\$ 266.00
AB110-2178	HX CAP SCR 1/4-20X1-1/4 GR5 Z		\$ 0.40
AB110-2181	CYL LINER 4TH STG 4S25/30		\$ 1,310.00
AB110-2198	VALVE SERVICE KIT H15T4 & 6		\$ 1,420.00
AB110-2200	ELBOW,SWIV,PUSH-IN 1/8NPTX1/4T		\$ 15.30
AB110-2203	RUN TEE,1/8NPT X 1/4T PUSH-IN		\$ 17.50
AB110-2258	AUTO DRAIN O-RING 31, 35X3, 53		\$ 10.10
AB110-2259	AUTO DRAIN O-RING 39, 34X2, 62		\$ 9.90

**Revision A**

Current revision date: December 1, 2018



**All prices listed herein supercede all other price lists, including (but not limited to) Scott master PDF price list. All prices are subject to change.**

**3M | Scott Fire & Safety Master Price List**

<b>ITEM</b>	<b>Product Description</b>	<b>Signal Code</b>	<b>List Price</b>
AB110-2260	AUTO DRAIN STEEL BALL, 10MM		\$ 13.40
AB110-2261	AUTO DRAIN SPRING, NF .030		\$ 30.10
AB110-2262	AUTO DRAIN O-RING 9, 25X1, 78		\$ 2.30
AB110-2263	AUTO DRAIN O-RING 29, 82X2, 62		\$ 8.00
AB110-2264	AUTO DRAIN PISTON AB 23.008		\$ 510.00
AB110-2269	ELBOW,PUSH-IN 1/4NPT X 1/4T		\$ 11.80
AB110-2275	SEQ. VLVE, MED. SPRNG		\$ 433.00
AB110-2282	CROSS - 3/4 NPT		\$ 37.50
AB110-2283	HEX BUSHING - 3/4 NPT STREET		\$ 8.60
AB110-2284	ELBOW - 3/4 NPT STREET		\$ 10.00
AB110-2285	NIPPLE - 3/4 NPT - CLOSE		\$ 8.10
AB110-2289	CLAMP SEGMENT, 2.5" SECTION		\$ 24.10
AB110-2294	PURIFIER COALESCER TUBE		\$ 31.40
AB110-2295	O-RING, BASE, 2.5" SECTION		\$ 10.25
AB110-2296	CLAMP SEGMENT, 2.25" SECTION		\$ 24.10
AB110-2297	GUIDE BUSHING, 2.25" SECTION		\$ 51.00
AB110-2298	MAST TUBE, 2.25" SECTION		\$ 454.00
AB110-2299	O-RING, BASE, 2.25" SECTION		\$ 8.90
AB110-2300-1	SBAS CONT., BASIC, ENGLISH		\$ 2,200.00
AB110-2300-2	SBAS CONT., BASIC. W/DP ENGLIS	DIS	\$ 3,210.00
AB110-2300-3	SBAS CONT., BASIC, W/DP,CO ENG		\$ 3,330.00
AB110-2300-4	SBAS CONT. BASIC, W/CO,DP ENGL		\$ 3,870.00
AB110-2301	CUP SEAL, 2.25" SECTION		\$ 108.00
AB110-2302	CLAMP SEGMENT, 2" SECTION		\$ 24.10
AB110-2303	GUIDE BUSHING, 2" SECTION		\$ 51.00
AB110-2304	MAST TUBE, 2" SECTION		\$ 420.00



**Revision A**

Current revision date: December 1, 2018



**All prices listed herein supercede all other price lists, including (but not limited to) Scott master PDF price list. All prices are subject to change.**

**3M | Scott Fire & Safety Master Price List**

ITEM	Product Description	Signal Code	List Price
AB110-2305	O-RING, BASE, 2" SECTION		\$ 8.10
AB110-2306	CUP SEAL, 2" SECTION		\$ 104.00
AB110-2307	CLAMP SEGMENT, 1.75" SECTION		\$ 24.10
AB110-2308	GUIDE BUSHING, 1.75" SECTION		\$ 47.25
AB110-2309	MAST TUBE, 1.75" SECTION		\$ 394.00
AB110-2310	O-RING, BASE, 1.75" SECTION		\$ 6.50
AB110-2311	CUP SEAL, 1.75" SECTION		\$ 100.00
AB110-2312	CLAMP SEGMENT, 1.5" SECTION		\$ 24.10
AB110-2313	GUIDE BUSHING, 1.5" SECTION		\$ 44.00
AB110-2314	MAST TUBE, 1.5" SECTION		\$ 374.00
AB110-2315	O-RING, BASE, 1.5" SECTION		\$ 4.40
AB110-2316	CUP SEAL, 1.5" SECTION		\$ 90.00
AB110-2317	CLAMP SEGMENT, 1.25" SECTION		\$ 26.30
AB110-2318	MAST TUBE, 1.25" SECTION		\$ 323.00
AB110-2319	CUP SEAL, 1.25" SECTION		\$ 85.00
AB110-2320	CLAMP SCREW		\$ 41.80
AB110-2321	2X8 SPRING PIN		\$ 2.50
AB110-2322	THREADED BUSHING		\$ 31.70
AB110-2323	DOG POINT GRUB SCREW		\$ 11.00
AB110-2324	1/4 BSF THIN NUT		\$ 2.75
AB110-2325	GUIDE BUSHING, 2.5" SECTION		\$ 58.00
AB110-2326	MAST TUBE, 2.5" SECTION		\$ 494.00
AB110-2327	SHOULDER HEAD SCREW		\$ 4.70
AB110-2328	1/4" BSP SEALON WASHER		\$ 9.75
AB110-2332	DECAL-SMART FILL AUTO CASCADE		\$ 81.00
AB110-2333	PISTON ASSY, 3RD STG MCH16		\$ 870.00

**Revision A**

Current revision date: December 1, 2018



**All prices listed herein supercede all other price lists, including (but not limited to) Scott master PDF price list. All prices are subject to change.**

**3M | Scott Fire & Safety Master Price List**

ITEM	Product Description	Signal Code	List Price
AB110-2346	SAE-ORB HEX HEAD PLUG		\$ 4.10
AB110-2356	SEQUENCE VALVE REPAIR KIT		\$ 148.00
AB110-2357	DECAL-SMART FILL AUTO CASCADE		\$ 29.00
AB110-2369	INDICATOR, MOISTURE/CO	SVC	\$ 264.00
AB110-2370	MOISTURE/CO ELEMENT KIT		\$ 72.00
AB110-2371	HEAD, 4TH STAGE CY. V22H-AL		\$ 408.00
AB110-2372	SEAL, 4TH STG. DISCH. CPLNG V2		\$ 8.80
AB110-2373	CPLNG, 4TH STG. DISCH. V22H-AL		\$ 186.00
AB110-2374	SCREW, 3RD STG. FILTER RET.		\$ 113.00
AB110-2375	VALVE, RELIEF, 1500 PSIG, ASME	SVC	\$ 134.00
AB110-2376	SWITCH, LOW OIL LEVEL		\$ 133.00
AB110-2382	O-RING, PURIFIER STEM		\$ 2.50
AB110-2384	FILL PRESS. REG. REPAIR TOOL		\$ 88.00
AB110-2389	MONITOR/PHASE REVERSAL & LINE		\$ 2,680.00
AB110-2398	GAUGE, GLYCERINE FILLED, RED L	SVC	\$ 132.00
AB110-2400-1	SBAS CONT., BASIC, ENGLISH		\$ 2,200.00
AB110-2400-2	SBAS CONT., BASIC. W/DP ENGLIS		\$ 3,210.00
AB110-2400-3	SBAS CONT., BASIC, W/DP,CO ENG		\$ 3,330.00
AB110-2400-4	SBAS CONT. BASIC, W/CO,DP ENGL	DIS	\$ 3,740.00
AB110-2449	PRESS. RELIEF VALVE, 150 PSIG		\$ 54.00
AB110-2450	PRESS. RELIEF VALVE, 750 PSIG		\$ 135.00
AB110-2454	HEAD, 3RD STAGE MCH16		\$ 980.00
AB110-2455	HEAD COVER, 3RD STAGE MCH16		\$ 123.00
AB110-2456	BOLT, 3RD STAGE HEAD MCH16		\$ 5.40
AB110-2458	WASHER, 8mm COPPER MCH16		\$ 5.10
AB110-2459	SCREW, 8mm VALVE LIMIT MCH16		\$ 8.00

**Revision A**

Current revision date: December 1, 2018



**All prices listed herein supercede all other price lists, including (but not limited to) Scott master PDF price list. All prices are subject to change.**

**3M | Scott Fire & Safety Master Price List**

<b>ITEM</b>	<b>Product Description</b>	<b>Signal Code</b>	<b>List Price</b>
AB110-2462	MOTOR,10HP/208V/3PH/60HZ		\$ 2,410.00
AB110-2469	VOLTMETER, 150VAC PANEL MT		\$ 286.00
AB110-2487	V-BELT, V17 COOLING FAN DRIVE		\$ 25.00
AB110-2490	GASKET, SHAFT END COVER, H15T6		\$ 9.80
AB110-2491	SEAL, OIL, H15T6		\$ 62.00
AB110-2492	KIT, BEARING/CONNECTING ROD, H		\$ 4,230.00
AB110-2498	REG. SPRING 1/2 GREEN 6500 PSI		\$ 13.00
AB110-2499	PISTON SWITCH 450-7500 PSI ADJ	SVC	\$ 438.00
AB110-2502	RING TERMINAL,18-22AWG #6 STUD		\$ 49.10
AB110-2503	CORD GRIP, 1/2"NPT, .25"-.38"		\$ 20.75
AB110-2504	R/A CYLINDER WARNING DECAL		\$ 17.10
AB110-2505	FUEL HOSE, 270mm F/2004 ENGINE		\$ 105.00
AB110-2506	GASKET, COPPER 14mm F/2004 ENG		\$ 4.70
AB110-2507	BOLT, M14 BANJO F/2004 ENGINE		\$ 40.75
AB110-2508	BOLT, M10 BANJO F/2004 ENGINE		\$ 37.50
AB110-2509	GASKET, COPPER 10mm F/2004 ENG		\$ 4.90
AB110-2510	FUEL HOSE, 226mm F/2004 ENGINE		\$ 145.00
AB110-2511	VALVE REMOVAL TOOL		\$ 80.00
AB110-2535	LABEL, 5.5 CYLINDER COMPATIBLE		\$ 1.50
AB110-2539	SBAS CONT.I/O BOARD W/DOOR INT		\$ 380.00
AB110-2541	W70AL SIGHT GLASS		\$ 42.50
AB110-2542	W70AL SIDE COVER GASKET		\$ 11.75
AB110-2543	W70AL O-RING 1-13/16 X 3/32		\$ 7.20
AB110-2544	W70AL GASKET O-RING KIT		\$ 870.00
AB110-2545	DECAL, PNL, DPR, 2.2 & 5.5		\$ 94.00
AB110-2546	DECAL, PNL, DPR, 4.5 & 5.5		\$ 93.00

**Revision A**

Current revision date: December 1, 2018



**All prices listed herein supercede all other price lists, including (but not limited to) Scott master PDF price list. All prices are subject to change.**

**3M | Scott Fire & Safety Master Price List**

ITEM	Product Description	Signal Code	List Price
AB110-2548	1/8 TUBE X 5/16 STR. THRD ORIN		\$ 27.00
AB110-2549	ADAPTER, 1/4NPT X 5/16-24 SAE		\$ 94.00
AB110-2550	INLET PIPE, 3RD STAGE V22H-AL		\$ 103.00
AB110-2554	WASHER, INTERNAL TOOTH, M10		\$ 0.40
AB110-2563	KEY, SPARE, LIBERTY TRAILER		\$ 22.00
AB110-2566	PURIFIER BASE (V2)		\$ 249.00
AB110-2567	PURIFIER HOUSING (V2)		\$ 670.00
AB110-2568	PURIFIER CAP (V2)		\$ 162.00
AB110-2571	PURIFIER (V2) ENG. REF. DIMS		\$ 1,060.00
AB110-2572	PURIFIER O-RING (V2)		\$ 18.40
AB110-2573	PURIFIER BACK-UP RING (V2)		\$ 14.10
AB110-2591	MOISTURE IND SEAL KIT		\$ 52.00
AB110-2598	5.2K HYD. BRAKE SHOE KIT		\$ 175.00
AB110-2599	HYDRAULIC BRAKE CYL, RH		\$ 96.00
AB110-2600	HYDRAULIC BRAKE CYL, LH		\$ 97.00
AB110-2601	BRAKE DRUM, TRAILER		\$ 495.00
AB110-2602	FILLER CAP, DA10 TRAILER		\$ 55.00
AB110-2603	FILLER CAP, HYDRASTAR		\$ 22.70
AB110-2604	BATTERY PACK, HYDRASTAR		\$ 336.00
AB110-2605	GAUGE DAMPENER, 1/8 NPT		\$ 139.00
AB110-2606	DECAL, SCOTT LOGO, 4"		\$ 14.25
AB110-2607	PISTON, DRAIN VALVE, DELRIN		\$ 13.00
AB1102G	VALVE,6KPSI 1/4NPTF PM W/GAGE		\$ 257.00
AB1113K	KIT,PM VALVE REPAIR 1113		\$ 43.50
AB13-0001	SLIP-IN HACKNEY 60HP LMF V17		\$ 99,500.00
AB13-0002	DUAL PWER SLIP IN NO ENC NO TK		\$ 98,540.00

**Revision A**

Current revision date: December 1, 2018



**All prices listed herein supercede all other price lists, including (but not limited to) Scott master PDF price list. All prices are subject to change.**

**3M | Scott Fire & Safety Master Price List**

ITEM	Product Description	Signal Code	List Price
AB13-0012	LIB1 DES.FLTR,DES.SAND MARINES		\$ 136,170.00
AB13-0013	6K/20/208/3/60 5PUR WL MT.X4-4		\$ 14,170.00
AB13-0015	6K/7.5/230/60/1 HORIZ.SLIPIN		\$ 69,980.00
AB1300155	O-RING 52AL PURIF'R TOP&BOTTOM		\$ 9.90
AB13-0022	10 HP SLIP-IN 460V AC, 6KPSI		\$ 31,530.00
AB13-0023	PIERCE R/A W/CASCADE PANEL		\$ 13,770.00
AB13-0024	PIERCE 10 H.P. 230V SLIP-IN		\$ 29,310.00
AB13-0025	20HP,6K,4B, 65AL4,RVR,HI-LO R		\$ 69,300.00
AB13-0026	SEQ. VALVE ASSY. W/O ISOLATION		\$ 9,100.00
AB13-0027	R/A W/NON-ISO SEQ. VALVE ASSY		\$ 9,310.00
AB14300	NUT,1/2		\$ 4.60
AB14301	SLEEVE,TUBING 1/2 FERRULE		\$ 2.80
AB14302	NUT, 5/8	EXP	\$ 3.50
AB14303	SLEEVE 5/8		\$ 2.80
AB14-6004-B1	60PSI/413B BLK PLBG 1 CYL		\$ 1,700.00
AB14-6004-B2	60PSI/413B BLK PLBG 2 CYL		\$ 3,390.00
AB14-6004-B3	60PSI/413B BLK PLBG 3 CYL		\$ 5,220.00
AB14-6004-B4	60PSI/413B BLK PLBG 4 CYL		\$ 13,730.00
AB15-6600-B1	BULK PLBG 1 CYL		\$ 3,090.00
AB15-6600-B2	BULK PLBG 2 CYL		\$ 5,970.00
AB15-6600-B3	BULK PLBG 3 CYL		\$ 8,470.00
AB15-6600-B4	BULK PLBG 4 CYL		\$ 11,050.00
AB16-0018	BRACKT,TRAILER COND. COLLECTR		\$ 200.00
AB16-0031	COVER WELDMENT		\$ 1,400.00
AB16-0032	TOP STORAGE ASSEMBLY		\$ 10,480.00
AB16-0070-4P	ASSY PANEL DUAL PRESS REG LE4		\$ 4,200.00

**Revision A**

Current revision date: December 1, 2018



**All prices listed herein supercede all other price lists, including (but not limited to) Scott master PDF price list. All prices are subject to change.**

**3M | Scott Fire & Safety Master Price List**

<b>ITEM</b>	<b>Product Description</b>	<b>Signal Code</b>	<b>List Price</b>
AB16-0072	ASSY,LOW PRESS WALL MOUNT		\$ 1,520.00
AB16-0073	ASSY,HIGH PRESS WALL MOUNT		\$ 1,560.00
AB16-0106	WELDMENT,INTAKE TUBE		\$ 45.70
AB16-0130	SEQUENCE VALVE ASSY		\$ 9,870.00
AB16-0160	BLOCK & COUPLINS ASSY		\$ 176.00
AB16-0161	ADJ VALVE BLOCK ASSY		\$ 499.00
AB16-0163	TOGGLE VALVE ASS'Y, REVOLVE AI		\$ 473.00
AB16-0188-20	HOSE ASSY 3/16,1/4 JIC 20" 7K		\$ 86.00
AB16-0188-240	HOSE ASSY 3/16,1/4 JIC X240 7K		\$ 361.00
AB16-0188-300	HOSE ASSY 3/16,1/4 JIC X300 7K		\$ 298.00
AB16-0188-33	HOSE ASSY 3/16,1/4 JIC X 33 7K		\$ 94.00
AB16-0188-80	HOSE ASSY 3/16,1/4 JIC X 80 7K		\$ 163.00
AB16-0188-93	HOSE ASSY 3/16,1/4 JIC X 93 7K		\$ 178.00
AB16-0198	BASE, FILL ADAPTER		\$ 484.00
AB16-0199	SCUBA FILL ADAPTER		\$ 144.00
AB16-0202	CGA 346/7 FILL ADPT W/ SEALOFF		\$ 151.00
AB16-0203	DIN SEALOFF ASSY		\$ 31.60
AB16-0204	DIN ADAPTER WITH SEALOFF		\$ 233.00
AB16-0216	60 HZ TENSIONER MOUNTING KI		\$ 1,680.00
AB16-0221	ASSY, STORAGE REFILL		\$ 660.00
AB16-0222	PBOX,FLAT,NO/LE5,STD		\$ 630.00
AB16-0234	4 BOTTLE STAND/WALL RACK		\$ 1,380.00
AB16-0268	NAVY PURIFIER, 40CFM, GRADE E		\$ 8,860.00
AB16-0282	10/230/60/1 ASSY ENCL		\$ 3,240.00
AB16-0288	KIT-SPARE TIRE RETRO-FIT		\$ 389.00
AB16-0295	STAND ASSY- HA COMP STAND		\$ 0.20

**Revision A**

Current revision date: December 1, 2018



**All prices listed herein supercede all other price lists, including (but not limited to) Scott master PDF price list. All prices are subject to change.**

**3M | Scott Fire & Safety Master Price List**

<b>ITEM</b>	<b>Product Description</b>	<b>Signal Code</b>	<b>List Price</b>
AB16-0299	ASSEMBLY,PURGE VALVE		\$ 196.00
AB16-0310	STD RA BASE		\$ 770.00
AB16-0330	X4-KIT-PNEU-STD.-SLANT		\$ 950.00
AB16-0331	X4-KIT-PNEU-WALL MNT		\$ 1,130.00
AB16-0368	ASSY-ENCLOSURE-HA COMP. STAND		\$ 2,420.00
AB16-0383	HOOD ASSY,GUARD-SA COMP. STAND		\$ 193.00
AB16-0393	1 CYL KIT, PLBG VERT CSCD ASME		\$ 3,580.00
AB16-0420	TIRE MOUNT,SPARE,TRAILER		\$ 224.00
AB16-0441	MOTOR MNT-SA COMP STAND		\$ 188.00
AB16-0454	PANEL,ASSY,6KPSI REEL,LIB II		\$ 1,440.00
AB16-0464	PURIF 20SCFM 6KPSI GR E WO/MI		\$ 4,590.00
AB16-0466	PURIF 30SCFM 6KPSI GR E WO/MI		\$ 6,280.00
AB16-0467	PURIF 40SCFM 6KPSI GR E WO/MI		\$ 7,930.00
AB16-0472	SCUBA ADPTR FOR R/A W/DIN		\$ 443.00
AB16-0476	TIRE KIT LIB1		\$ 960.00
AB16-0477	TIRE KIT LIB2		\$ 990.00
AB16-0478	SCUBA ADPTR FOR GUARD. W/CGA		\$ 287.00
AB16-0486	SEQUENCE VALVE ASSEMBLY		\$ 10,040.00
AB16-0514	LE5000 WALL MT RETRO-FIT CONTR		\$ 5,940.00
AB16-0532	REG. ASSY. CAL, GAS 1.5LPM	DIS	\$ 245.00
AB16-0533	CALIBRATION KIT X4		\$ 375.00
AB16-0535	X4-4 WALL MOUNT KIT		\$ 6,170.00
AB16-0541	LE5000 WALL MT RETRO-FIT KIT		\$ 3,790.00
AB16-0542	LE4000 WALL MT RETRO-FIT KIT		\$ 3,440.00
AB16-0543	LE5000 STA'NARY RETRO-FIT KIT		\$ 3,940.00
AB16-0544	LE4000 STA'NARY RETRO-FIT KIT		\$ 3,130.00

**Revision A**

Current revision date: December 1, 2018



**All prices listed herein supercede all other price lists, including (but not limited to) Scott master PDF price list. All prices are subject to change.**

**3M | Scott Fire & Safety Master Price List**

<b>ITEM</b>	<b>Product Description</b>	<b>Signal Code</b>	<b>List Price</b>
AB16-0552	UPGRADE KIT, COLTRI PUR FILTER		\$ 1,840.00
AB16-0560	RA LOCK SHAFT WELDMENT		\$ 224.00
AB16-0561	RA TRUN VLVE ASSY		\$ 940.00
AB16-0565	RA ASSY W/O STAND, RED		\$ 9,150.00
AB16-0572	BASE TUBE WELDMENT		\$ 910.00
AB16-0579	DOT CYL VLV & CAP 5000PSI 10YR		\$ 1,410.00
AB16-0580	DOT CYL VLV & CAP 6000PSI 10YR		\$ 1,800.00
AB16-0582	FILTER KIT, COLTRI		\$ 2,640.00
AB16-0584	PNL,GRD.W/CAS.W/CONT.		\$ 4,230.00
AB16-0607	ASSEMBLY, FILTER ADAPTER		\$ 64.00
AB16-0622	PNL DPR STD		\$ 4,020.00
AB16-0624	KIT,SCUBA, CGA-REV/AIR		\$ 510.00
AB16-0625	KIT,SCUBA, DIN-REV/AIR		\$ 520.00
AB16-0626	KIT, RA FILTER		\$ 24.25
AB16-0632	PURIFIER MNT ADAPTER-WELDMENT		\$ 294.00
AB16-0651	ASSY - AUTO CASCADE		\$ 4,850.00
AB16-0656	PURIFIER TUBE ASSEMBLY		\$ 1,370.00
AB16-0665	PNL,FLAT,W/A-CASC.		\$ 3,340.00
AB16-0667	PNL,FLAT,W/CONT,W/A-CAS.		\$ 3,370.00
AB16-0671	PNL,DPR,FLAT,W/X4 & A/CASC.		\$ 5,090.00
AB16-0675	PNL,DPR,STD,W/A-CASC.		\$ 3,860.00
AB16-0682	ASSY - AUTO CASCADE		\$ 4,830.00
AB16-0683	KIT, OVERLOAD REPLACEMENT		\$ 250.00
AB16-0684	KIT, OVERLOAD REPLACEMENT		\$ 263.00
AB16-0685	KIT, OVERLOAD REPLACEMENT		\$ 317.00
AB16-0686	KIT, OVERLOAD REPLACEMENT		\$ 317.00



**Revision A**

Current revision date: December 1, 2018



**All prices listed herein supercede all other price lists, including (but not limited to) Scott master PDF price list. All prices are subject to change.**

**3M | Scott Fire & Safety Master Price List**

ITEM	Product Description	Signal Code	List Price
AB16-0687	KIT, OVERLOAD REPLACEMENT		\$ 317.00
AB16-0688	KIT, OVERLOAD REPLACEMENT		\$ 252.00
AB16-0689	KIT,COLTRI,PURIFIER,RETRO-FIT		\$ 1,670.00
AB16-0690	INDICATOR, MOISTURE/CO		\$ 424.00
AB16-0694	ASSEMBLY, 4 BANK CSCD STORAGE		\$ 16,080.00
AB16-0695	ASSY, TWO BOTTLE BULK ASSY		\$ 8,950.00
AB16-0696	ASSY, MOBILE RA WITH STD PANEL		\$ 10,180.00
AB16-0699	ASSY, MOBILE MANUAL 6 BANK CAS		\$ 13,800.00
AB16-0700	ASSY, MOBILE MANUAL 4 BANK CAS		\$ 11,140.00
AB16-0701	ASSY, AUTO 4 BANK CASCADE MOBI		\$ 13,450.00
AB16-0705	ASSY,2 BOTTLE BULK STRG RACK		\$ 8,380.00
AB16-0706	ASSY,4 BOTTLE BULK STRG RACK		\$ 14,540.00
AB16-0710	SLIP IN, 10 H.P. HAM. 208V		\$ 30,020.00
AB16-0711	SLIP IN, 10 H.P. HAM. 230V		\$ 30,020.00
AB16-0712	SLIP IN, 15 H.P. HAM. 230V		\$ 37,540.00
AB16-0713	SLIP IN, 15 H.P. ING. 230V		\$ 37,700.00
AB16-0714	SLIP IN, 20 H.P. ING. 230V		\$ 40,270.00
AB16-0717	ASSEMBLY, RA W\STD FLT PNL AUT		\$ 13,660.00
AB16-0725	SLIP IN, 15 H.P. ING. 208V		\$ 38,780.00
AB16-0726	SLIP IN, 20 H.P. ING. 208V		\$ 40,930.00
AB16-0728	SLIP IN, 7.5 H.P. HAM. 230V		\$ 29,900.00
AB16-0729	SLIP IN, 7.5 H.P. HAM. 208V		\$ 30,120.00
AB16-0730	ASSY, 20 H.P. SLIP-IN COMP. (I		\$ 41,580.00
AB16-0732	20 HP COMPR. W/MOB. RA/BULK FI		\$ 49,540.00
AB16-0737	10 HP IR COMPR. W/ MOB. RA/BUL		\$ 39,280.00
AB16-0738	10 HP IR COMPR. W/ MOB. RA/BUL		\$ 39,280.00

**Revision A**

Current revision date: December 1, 2018



**All prices listed herein supercede all other price lists, including (but not limited to) Scott master PDF price list. All prices are subject to change.**

**3M | Scott Fire & Safety Master Price List**

<b>ITEM</b>	<b>Product Description</b>	<b>Signal Code</b>	<b>List Price</b>
AB16-0739	20 HP IR COMPR. W/ MOB. RA/BUL		\$ 50,200.00
AB16-0740	7.5 HP IR COMPR. W/ MOB. RA/BU		\$ 38,800.00
AB16-0741	7.5 HP IR COMPR. W/ MOB. RA/BU		\$ 39,010.00
AB16-0742	SLIP IN, 15 H.P. ING. 230V W/O		\$ 39,060.00
AB16-0744	15 HP COMPR. W/MOB. RA/BULK FI		\$ 48,100.00
AB16-0745	15 HP COMPR. W/MOB. RA/BULK FI		\$ 49,210.00
AB16-0746	7.5 HP HAM COMPR. W/ MOB. RA/		\$ 41,420.00
AB16-0747	7.5 HP HAM COMPR. W/ MOB. RA/		\$ 41,200.00
AB16-0748	7.5 HP HAM COMPR. W/ MOB. RA/		\$ 42,180.00
AB16-0749	7.5 HP HAM COMPR. W/ MOB. RA/		\$ 41,960.00
AB16-0750	7.5 HP HAM COMPR. W/ MOB. RA/		\$ 43,820.00
AB16-0751	7.5 HP HAM COMPR. W/ MOB. RA/		\$ 44,020.00
AB16-0752	10 HP HAM COMPR. W/ MOB. RA/ 4		\$ 41,700.00
AB16-0753	10 HP HAM COMPR. W/ MOB. RA/ 4		\$ 41,700.00
AB16-0754	10 HP HAM COMPR. W/ MOB. RA/ 6		\$ 42,480.00
AB16-0755	10 HP HAM COMPR. W/ MOB. RA/ 6		\$ 42,480.00
AB16-0756	10 HP HAM COMPR. W/ MOB. RA/ A		\$ 44,130.00
AB16-0757	10 HP HAM COMPR. W/ MOB. RA/ A		\$ 44,130.00
AB16-0758	15 HP ING COMPR. W/ MOB. RA/ 4		\$ 51,520.00
AB16-0759	15 HP ING COMPR. W/ MOB. RA/ 4		\$ 50,420.00
AB16-0760	15 HP ING COMPR. W/ MOB. RA/ 6		\$ 52,290.00
AB16-0761	15 HP ING COMPR. W/ MOB. RA/ 6		\$ 51,190.00
AB16-0762	15 HP ING COMPR. W/ MOB. RA/ A		\$ 53,950.00
AB16-0763	15 HP ING COMPR. W/ MOB. RA/ A		\$ 52,850.00
AB16-0764	20 HP ING COMPR. W/ MOB. RA/4		\$ 52,620.00
AB16-0765	20 HP ING COMPR. W/ MOB. RA/ 4		\$ 51,850.00

**Revision A**

Current revision date: December 1, 2018



**All prices listed herein supercede all other price lists, including (but not limited to) Scott master PDF price list. All prices are subject to change.**

**3M | Scott Fire & Safety Master Price List**

<b>ITEM</b>	<b>Product Description</b>	<b>Signal Code</b>	<b>List Price</b>
AB16-0766	20 HP ING COMPR. W/ MOB. RA/ 6		\$ 53,390.00
AB16-0767	20 HP ING COMPR. W/ MOB. RA/ 6		\$ 52,620.00
AB16-0768	20 HP ING COMPR. W/ MOB. RA/ A		\$ 55,050.00
AB16-0769	20 HP ING COMPR. W/ MOB. RA/ A		\$ 54,280.00
AB16-0771	7.5 208V COMP.,MOB. RA, 2 BULK		\$ 48,100.00
AB16-0772	7.5 230V COMP.,MOB. RA, 2 BULK		\$ 48,100.00
AB16-0773	7.5 208V COMP.,MOB. RA, 4 BULK		\$ 54,500.00
AB16-0774	7.5 230V COMP.,MOB. RA, 4 BULK		\$ 54,280.00
AB16-0775	7.5 208V COMP.,MOB. RA, 4 CASC		\$ 56,820.00
AB16-0776	7.5 230V COMP.,MOB. RA, 4 CASC		\$ 56,600.00
AB16-0777	7.5 208V COMP.,MOB. RA, 4 AUTO		\$ 60,350.00
AB16-0778	7.5 230V COMP.,MOB. RA, 4 AUTO		\$ 60,130.00
AB16-0779	10 208V COMP.,MOB. RA, 2 BULK		\$ 48,000.00
AB16-0780	10 230V COMP.,MOB. RA, 2 BULK		\$ 48,000.00
AB16-0781	10, 208V COMP, MOB., RA 4 BULK		\$ 54,390.00
AB16-0782	10 230V COMP.,MOB. RA, 4 BULK		\$ 54,390.00
AB16-0783	10 208V COMP.,MOB. RA, 4 CASC		\$ 56,700.00
AB16-0784	10 230V COMP.,MOB. RA, 4 CASC		\$ 56,700.00
AB16-0785	10 208V COMP.,MOB. RA, 4 AUTO		\$ 60,240.00
AB16-0786	10 230V COMP.,MOB. RA, 4 AUTO		\$ 60,240.00
AB16-0787	15 IR 208 COMP MOB. RA, 2 BULK		\$ 57,810.00
AB16-0788	15 IR 230 COMP. MOB. RA 2 BULK		\$ 56,700.00
AB16-0789	15 IR 208 COMP, MOB. RA 4 BULK		\$ 64,210.00
AB16-0790	15 IR 230 COMP. MOB. RA 4 BULK		\$ 63,110.00
AB16-0791	15 IR 208 COMP. MOB. RA 4 CASC		\$ 68,290.00
AB16-0792	15 IR 230 COMP. MOB. RA 4 CASC		\$ 66,530.00

**Revision A**

Current revision date: December 1, 2018



**All prices listed herein supercede all other price lists, including (but not limited to) Scott master PDF price list. All prices are subject to change.**

**3M | Scott Fire & Safety Master Price List**

ITEM	Product Description	Signal Code	List Price
AB16-0793	15 IR 208 COMP. MOB. RA 4 AUTO		\$ 70,750.00
AB16-0794	15 IR 230 COMP. MOB. RA 4 AUTO		\$ 69,060.00
AB16-0795	20 IR 208 COMP MOB. RA, 2 BULK		\$ 58,910.00
AB16-0796	20 IR 230 COMP. MOB. RA 2 BULK		\$ 58,140.00
AB16-0797	20 IR 208 COMP, MOB. RA 4 BULK		\$ 65,310.00
AB16-0798	20 IR 230 COMP. MOB. RA 4 BULK		\$ 64,540.00
AB16-0799	20 IR 208 COMP. MOB. RA 4 CASC		\$ 68,730.00
AB16-0800	20 IR 230 COMP. MOB. RA 4 CASC		\$ 67,960.00
AB16-0801	20 IR 208 COMP. MOB. RA 4 AUTO		\$ 71,160.00
AB16-0802	20 IR 230 COMP. MOB. RA 4 AUTO		\$ 70,500.00
AB16-0803	MOB. R/A, BULK FILL, 2 ASME		\$ 17,990.00
AB16-0804	MOB. R/A, BULK FILL, 4 ASME		\$ 24,270.00
AB16-0805	MOB. R/A, MAN. CASC., 4 ASME		\$ 27,810.00
AB16-0806	MOB. R/A, AUTO CASC., 4 ASME		\$ 30,230.00
AB16-0807	5.5 REVOLVEAIR CONVERSION KIT		\$ 139.00
AB16-0808	5.5 COMPRESSOR START/STOP CONV		\$ 520.00
AB16-0861	RETROFIT,SPRING TENSIONER,LIB	DIS	\$ 419.00
AB16-0871	LIB LE5 - X4 RETRO-FIT KIT		\$ 4,140.00
AB16-0873	FILL ADAPTER, CGA X FEM. DIN		\$ 144.00
AB16-0880	STD RA BASE, RED		\$ 448.00
AB16391	SEAT,DELIVERY VALVE-24		\$ 302.00
AB16411	SPRING,DEL VALVE-4-7-24		\$ 19.10
AB16413	PLATE,DEL VALVE-4-7-24		\$ 73.00
AB16414	PLATE,SUCTION VALVE-24		\$ 41.50
AB16415	SPRING SUCTION VALVE-7-24		\$ 22.30
AB17817	FILTER,POROSINT 40 MICRON BRON		\$ 13.00

**Revision A**

Current revision date: December 1, 2018



**All prices listed herein supercede all other price lists, including (but not limited to) Scott master PDF price list. All prices are subject to change.**

**3M | Scott Fire & Safety Master Price List**

<b>ITEM</b>	<b>Product Description</b>	<b>Signal Code</b>	<b>List Price</b>
AB17969	SET,BONDED SEAL 1/4BSP		\$ 10.70
AB210008	RING,BACKUP TEFLON 50AL		\$ 4.60
AB210012	PLUG,BURST DISC 60/50AL		\$ 18.40
AB210013	WASHER,BURST DISC SEAL NYLON Z	EXP	\$ 0.40
AB210014	DISC,BURST 10000PSI	EXP	\$ 1.70
AB210014-5	DISC,BURST 5KPSI 50AL 60AL		\$ 7.50
AB22445	ELEMENT,INTAKE 4S7 OE		\$ 91.00
AB22446	ELEMENT,FILTER INTAKE		\$ 156.00
AB23039	O-RING,4TH STG MINOR DIA-24		\$ 64.00
AB23040	O-RING,4TH STAGE MAJOR DIA-24		\$ 64.00
AB230600	PLUG,50/60AL DRAIN VALVE PORT		\$ 27.10
AB230601	KIT,REPAIR 1102 SHUTOFF VALVE		\$ 121.00
AB230602	KIT,VALVE O-RING 50AL 60AL 110		\$ 92.00
AB230604	SEAT,BRS W/TEFLON INSERT		\$ 21.80
AB230605	STEM,SHUTOFF VALVE SS 1102		\$ 23.50
AB230606	NUT,SS SHUTOFF VALVE SEAL		\$ 24.90
AB230607	KNOB,HANDWHEEL ABI VALVE		\$ 14.10
AB230609	NUT,STEM BRS CHROME PLATED LOC		\$ 10.25
AB230612	SPRING,SOV KNOB 1102 ASSY		\$ 18.25
AB230710	KIT,BURST DISC 10000PSI 60AL 5		\$ 56.00
AB230842	KIT,O-RING 42AL FILTER		\$ 40.75
AB230860	KIT,O-RING SHORT STEM 62AL 60A		\$ 37.50
AB230861	KIT,O-RING MED STEM 60AL & LON		\$ 37.25
AB23182	VALVE, RELIEF 650PSI -4 2ND ST		\$ 284.00
AB23185	VALVE,SAFETY 3RD STG 1200PSI	DIS	\$ 258.00
AB23496	CAP, BANJO		\$ 62.00

**Revision A**

Current revision date: December 1, 2018



**All prices listed herein supercede all other price lists, including (but not limited to) Scott master PDF price list. All prices are subject to change.**

**3M | Scott Fire & Safety Master Price List**

<b>ITEM</b>	<b>Product Description</b>	<b>Signal Code</b>	<b>List Price</b>
AB23497	SCREW, RETAINING		\$ 77.00
AB23498	SPRING,3RD STG POROSINT FILTER		\$ 14.10
AB235815	LOCKWASHER,1/4 STEEL ZINC	EXP	\$ 0.20
AB23700	VALVE,SAFETY 1400PSI		\$ 245.00
AB23985	WASHER,BONDED		\$ 7.20
AB241506	WASHER,NYLON 42AL BURST DISC S		\$ 7.75
AB241507B	DISC,BURST 4800PSI 42AL		\$ 4.80
AB241507K8	KIT,42MS 42AL BURST DISC REPAI		\$ 48.80
AB241507KS	KIT,42MS REPLACE O-RING SEAL		\$ 42.90
AB2426012	ASSY,SCUBA CLAMP X4AN MALE STD		\$ 161.00
AB243801S	BODY,FILL ADAPTER 6SAEX1/8NPTF		\$ 40.00
AB243802	NUT,PANEL MTG FILLER ADAPTER		\$ 15.00
AB2494	ASSY,DUMP BLOCK ALUMINUM VALVE	DIS	\$ 188.00
AB249401	HOUSING,DUMP BLOCK		\$ 45.80
AB249403	RETAINER,DUMP BLOCK		\$ 29.25
AB2494K	KIT, REPAIR DUMP VALVE	SVC	\$ 49.30
AB25008	BEARING, ROD BIG END 4S -10		\$ 33.60
AB25012	BLADE,FAN FOR 4S12/4S17		\$ 118.00
AB25017	GASKET,COVER 4S-10		\$ 8.00
AB25019	GASKET,BEARING HOUSING 4S-10		\$ 7.50
AB25031	GASKET,CYLINDER HEAD 4S-10-12		\$ 14.10
AB25036	ASSY,SUCTION VALVE 2ND STAGE	DIS	\$ 337.00
AB25037	ASSY,DELIVERY VALVE 2ND STAGE		\$ 690.00
AB25045	SEAL,DELIVERY VALVE SEAT		\$ 147.00
AB25047	O-RING,4TH STAGE-10		\$ 9.00
AB25048	O-RING,4TH STAGE-10		\$ 7.75

**Revision A**

Current revision date: December 1, 2018



**All prices listed herein supercede all other price lists, including (but not limited to) Scott master PDF price list. All prices are subject to change.**

**3M | Scott Fire & Safety Master Price List**

<b>ITEM</b>	<b>Product Description</b>	<b>Signal Code</b>	<b>List Price</b>
AB25052	RING, COMPRESSION 3RD STG 3S-10		\$ 225.00
AB25061	GASKET, CYLINDER BASE 4S-10		\$ 7.50
AB25064	O-RING, -10-12		\$ 13.25
AB25069	O-RING, 2ND ST VALVE SUCTION &		\$ 8.80
AB25117	SEAL, O-RING 15MM-10		\$ 10.10
AB25121	RING, COMPRESSION 1ST STG-12		\$ 70.00
AB25307	VALVE, SUCTION DELIVERY 14C-10		\$ 353.00
AB25312	RING, COMPRESSION 3RD STG -10		\$ 93.00
AB25313	RING, COMPRESSION 3RD STAGE		\$ 69.00
AB25316	CIRCLIP, 15MM 3RD STAGE PISTON		\$ 8.80
AB25320	RING, PISTON 4TH STAGE -10		\$ 171.00
AB25523	BLADE, FAN- 4S25		\$ 92.00
AB25528	GASKET, CRANKCASE-25 END COVER		\$ 28.25
AB25543	GASKET, 1ST STG-25-30 UPPER		\$ 27.10
AB25544	ASSY, VALVE REED-25		\$ 1,040.00
AB25545	GASKET, 1ST STG-25-30 LOWER		\$ 23.90
AB25547	WASHER, VALVE SEAT-25		\$ 28.25
AB25548	VALVE, SUCTION 2ND STAGE-25		\$ 1,040.00
AB25549	VALVE, DELIVERY 2ND STAGE-25		\$ 600.00
AB25555	RING, COMPRESSION 112MM		\$ 160.00
AB25556	RING, COMP MAJOR DIA 4S25		\$ 163.00
AB25557	RING, OIL CONTROL		\$ 150.00
AB25564	VALVE, SUCTION 3RD STAGE-25		\$ 1,040.00
AB25565	VALVE, DELIVERY 3RD STAGE-25		\$ 1,040.00
AB25566	WASHER, VALVE SEAT, 3RD STAGE		\$ 57.00
AB25569	RING, COMPRESSION 83MM		\$ 203.00

**Revision A**

Current revision date: December 1, 2018



**All prices listed herein supercede all other price lists, including (but not limited to) Scott master PDF price list. All prices are subject to change.**

**3M | Scott Fire & Safety Master Price List**

<b>ITEM</b>	<b>Product Description</b>	<b>Signal Code</b>	<b>List Price</b>
AB25570	RING, COMPRESSION 83MM		\$ 177.00
AB25571	RING, COMPRESSION 79.38MM		\$ 87.00
AB25576	PISTON, HP		\$ 1,030.00
AB25579	GASKET,LP CYL TO CRANKCASE 4S2		\$ 10.10
AB25581	WASHER,SEALING-25		\$ 4.10
AB25584	LOW PRESS PISTON		\$ 2,170.00
AB2595C	BASE,62AL PURIFIER BARE		\$ 429.00
AB2595E2	HOUSING, 62AL PURIFIER ALUM		\$ 770.00
AB2595E2C	CAP,62AL PURIFIED ALUM		\$ 296.00
AB2723A	NAMEPLATE,SERIAL NO TAG SYSTEM		\$ 16.50
AB2723M	LABEL,PURIFICATION FILTERS STD	EXP	\$ 9.00
AB280005	O-RING,60AL VALVE SEAL 1102	EXP	\$ 2.80
AB280006	O-RING,50AL FILTER	EXP	\$ 4.40
AB280007	O-RING,50AL FILTER STEM	EXP	\$ 0.80
AB280010	O-RING,42AL FILTER VITON -011	EXP	\$ 0.60
AB280013	O-RING,VITON DUMP BLOCK	EXP	\$ 1.10
AB280015	O-RING,2-136 TOP OF 42AL BASE	EXP	\$ 3.00
AB280020	O-RING,VITON		\$ 1.10
AB280022A	O-RING,FILL ADAPTER 346/347 TI		\$ 8.50
AB280024T	O-RING,-232 TEFLON 2-3/4ID X1/		\$ 7.70
AB280027	O-RING,60AL BASE	EXP	\$ 4.30
AB280057	ORING -239 VITON		\$ 6.40
AB280059T	O-RING,-226 TEFLON 2ID X1/8		\$ 6.00
AB280061T	O-RING,-228 TEFLON 2-1/4ID X1/		\$ 10.80
AB280065	ORING VITON .468ID .078W		\$ 1.60
AB280066T	O-RING,-230 TEFLON 2-1/2ID X1/		\$ 8.75



**Revision A**

Current revision date: December 1, 2018



**All prices listed herein supercede all other price lists, including (but not limited to) Scott master PDF price list. All prices are subject to change.**

**3M | Scott Fire & Safety Master Price List**

<b>ITEM</b>	<b>Product Description</b>	<b>Signal Code</b>	<b>List Price</b>
AB2801C	WASHER,TEFLON		\$ 15.25
AB280207	VALVE,RELIEF 150PSI 1/4NPT ASM		\$ 32.40
AB280217	VALVE,30PSI RELIEF 1/8NPT SOFT		\$ 32.75
AB280239	VALVE,RELIEF ADJ 6KPSI ALUM		\$ 158.00
AB280239-48	VALVE,RELIEF PRE-SET@4800PSI		\$ 165.00
AB280239-52	VALVE,RELIEF SET @ 5200PSI		\$ 196.00
AB280239-55	VALVE,RELIEF PRE-SET @5500PSI	MER	\$ 196.00
AB280239H	VALVE,RELIEF ADJ 6.3KPSI ALUM		\$ 205.00
AB280242	FUSE, FLOW 6K PSI 1/4NPT MALE		\$ 115.00
AB280256	VALVE,RELIEF 50-200PSI 1/4NPTM		\$ 46.75
AB280261	VALVE,135PSI RELIEF ASME 1/4NP		\$ 90.00
AB280264	VALVE,5500PSI ASME 1/4NPT RELI		\$ 1,160.00
AB280265	VALVE,RELIEF 6500PSIASME CODED	SVC	\$ 710.00
AB280432	GAUGE,600PSI 2-1/2 SS GF PM		\$ 201.00
AB280446	GAUGE,6000PSI 2-1/2 SS GF PM		\$ 317.00
AB280470	GAUGE,200PSI 2" 1/4NPT CB		\$ 31.40
AB280479	GAUGE,160PSI 1/8NPT MINI		\$ 41.50
AB280504	VALVE,BACKPRESS 6KPSI 1/4NPT F	SVC	\$ 124.00
AB280507	VALVE,BACKPRESS 1/2NPT 6KPSI A		\$ 215.00
AB280507K	KIT BACK PRESS 1/2NPT REPAIR		\$ 98.00
AB280610	VALVE,CGA702 DOT CYL 6KPSI		\$ 245.00
AB280610A	DISC,6750PSI DOT BURST		\$ 23.10
AB280708	VALVE CPI 1/8NPT BRASS		\$ 83.00
AB280724	VALVE,1/2NPTM XFEM MINI BRS BA		\$ 36.10
AB280725	VALVE,1/4NPTMXFEM MINI BRS BAL		\$ 21.80
AB280736	VALVE,6KPSI 3WAY PM TRUNNION B		\$ 840.00

**Revision A**

Current revision date: December 1, 2018



**All prices listed herein supercede all other price lists, including (but not limited to) Scott master PDF price list. All prices are subject to change.**

**3M | Scott Fire & Safety Master Price List**

<b>ITEM</b>	<b>Product Description</b>	<b>Signal Code</b>	<b>List Price</b>
AB280736K	KIT,REPAIR F/280736 VALVE		\$ 313.00
AB280738	VALVE,1/8NPTF STL 5KPSI THROTT		\$ 100.00
AB280751	VALVE,1/8NPT EXTNL SEAL DRAIN		\$ 21.60
AB280801	TEE,STREET 1/8NPT BRS		\$ 8.75
AB280937	REGULATOR, 6KPSI IN 5KPSI OUT		\$ 590.00
AB280937K	KIT, REGULATOR REPAIR		\$ 171.00
AB280937M	BRACKET,MOUNT FOR 280937 REGUL		\$ 76.00
AB280939	REGULATOR, 6KPSIX6KPSI ADJ AIR		\$ 660.00
AB280940	REGULATOR,6KPSI X 400PSIMAX OU		\$ 590.00
AB2809B1	REGULATOR,REDUCTION VALVE ASSY		\$ 282.00
AB281009	REGUL.,LP MINI 1/8 NPT L/GAGE		\$ 76.00
AB281009A	NUT,MINI REG MOUNTING		\$ 10.90
AB281032	LUBRICATOR,MINI 1/8NPT 20CFM		\$ 68.00
AB281205	ELEMENT, INTAKE FILTER -4 -5 P		\$ 76.00
AB281206	ELEMENT,INTAKE FLTR REPLACEMEN		\$ 70.00
AB281207	SILENCER,RECLASSIFIER 1NPT		\$ 234.00
AB281213	FILTER,INLINE 1/4FNPT SS2-5 MI		\$ 212.00
AB281217	ELEMENT,SINTERED BRONZE CONE		\$ 198.00
AB281219A	ELEMENT,FILTER COALESCER		\$ 98.00
AB281247	FILTER,1-1/4NPT INTK SILENCER		\$ 104.00
AB281251	ELEMENT,COALESCER 3SS PURIFICA		\$ 41.50
AB281251-1	ELEMENT KIT		\$ 81.00
AB281271A	ELEMENT,PREFILTER COALESCER 10		\$ 52.00
AB281273	ELEMENT,INTAKE INLET		\$ 31.25
AB281277	ELEMENT,FILTER PLEATED		\$ 69.00
AB281293	ASSY,ELEMENT,COALESCER FULL 60	SVC	\$ 159.00

**Revision A**

Current revision date: December 1, 2018



**All prices listed herein supercede all other price lists, including (but not limited to) Scott master PDF price list. All prices are subject to change.**

**3M | Scott Fire & Safety Master Price List**

<b>ITEM</b>	<b>Product Description</b>	<b>Signal Code</b>	<b>List Price</b>
AB281297	SILENCER,1/4NPTM MINI AIR MUFF		\$ 13.00
AB281505	TEE,1/8NPTF BRS PIPE		\$ 8.80
AB281507	TEE,BRANCH 1/8 NPT STL		\$ 23.90
AB281508	TEE,1/4NPT STREET STL		\$ 18.40
AB281509	TEE,1/4NPTF STL HP		\$ 15.25
AB281510	TEE,1/4NPT BRANCH STL		\$ 14.00
AB281511	TEE,1/8NPTF HP STL		\$ 13.30
AB281512	TEE,STREET 1/8NPT STL		\$ 14.10
AB281608	REDUCER,1/4NPTF X 1/8NPTM STL	EXP	\$ 7.75
AB281609	REDUCER,1/4NPTM X1/8NPTF STL		\$ 4.40
AB281616	REDUCER,1/2X1/4NPT HP STL	EXP	\$ 9.90
AB281619	ADAPTER,3/8 TUBE X 1/4MNPT ST		\$ 19.40
AB281624	REDUCER,1NPTM X1/4NPTF STL HP		\$ 34.75
AB281715	CONNECTOR,4ANX1/4NPTM W/O NUT	EXP	\$ 4.10
AB281716	CONNECTOR,4MS X1/4MNPT STL BST		\$ 10.70
AB281718	CONNECTOR,6MS X1/4NPTM STL		\$ 10.10
AB281721	CONNECTOR,4MS X1/8MNPT STR STL		\$ 8.80
AB281761	CONNECTOR,2MS X1/8NPTM STL		\$ 9.50
AB281762	CONNECTOR,2MS X1/4NPT STL		\$ 15.25
AB281770	CONNECTOR,2MS X 1/16NPTM SS		\$ 26.80
AB281775	ELBOW,4MSX1/4NPTM 45DEG SS	DIS	\$ 57.00
AB281778	FERRULE 6MM EO 250 BAR STL	EXP	\$ 0.30
AB281785	CONNECTOR,4AN X 6SAE O-RING		\$ 6.00
AB281789	CONNECTOR,5MS X1/4NPTM STL		\$ 10.10
AB281807	CONNECTOR,4ANX1/4NPTF W/O NUT		\$ 8.50
AB281808	CONNECTOR,4MS X1/4FNPT BSTL		\$ 12.00

**Revision A**

Current revision date: December 1, 2018



**All prices listed herein supercede all other price lists, including (but not limited to) Scott master PDF price list. All prices are subject to change.**

**3M | Scott Fire & Safety Master Price List**

<b>ITEM</b>	<b>Product Description</b>	<b>Signal Code</b>	<b>List Price</b>
AB281826	ELBOW,4MSX1/4NPTF STL		\$ 24.60
AB281829	CONNECTOR,2MSX 1/4NPTF SS		\$ 35.00
AB281907	PLUG,1/8NPT SOCKET STL	EXP	\$ 3.30
AB281908	PLUG,1/4NPT SOCKET STL PIPE	EXP	\$ 4.30
AB281914	PLUG,1/4NPT HEX HD STL	EXP	\$ 2.25
AB281915	PLUG,1/8NPT HEX STL PIPE		\$ 1.90
AB281929	PLUG,6SAE STR THRD O-RING HEX		\$ 23.90
AB282003	CROSS, 1/4FNPT STL		\$ 27.90
AB282006	CROSS,1/8FNPT STL		\$ 44.60
AB282104	OIL, 1 GALLON, COMPRESSOR		\$ 160.00
AB282130	OIL,15W-40 MOTOR, DIESEL	EXP	\$ 62.00
AB282203	SWITCH,LOW OIL SAFETY W/GAUGE	DIS	\$ 258.00
AB282406	FERRULE,4MS STL BITE TYPE	EXP	\$ 1.70
AB282412	FERRULE,1/8 SS PARKER FERULOK	EXP	\$ 8.00
AB282418	FERRULE,1/4 SS CPI TUBE FITTIN	EXP	\$ 8.50
AB282420	FERRULE,1/8 CPI SS TUBE	EXP	\$ 8.00
AB282423	FERRULE,2MS STL FERULOK TUBING	EXP	\$ 2.10
AB282424	FERRULE 1/8 CPI STEEL TUBING	EXP	\$ 3.00
AB282506	NUT,TUBE 4MS STL		\$ 2.25
AB282510	NUT 4MS CPI STL TUBING	EXP	\$ 2.75
AB282511	NUT 1/8 2MS FERULOK STL TUBING		\$ 2.80
AB282902	RING,BACK UP 42AL BASE TOP		\$ 2.30
AB282903	RING,BACK UP 60AL SERIES	EXP	\$ 2.00
AB282908	RING, BACKUP TEFLON-333		\$ 3.80
AB283041	SWITCH,60PSI 1/8NPT NO/NC PRES		\$ 123.00
AB283049	BREAKER,6A AUTO RESET W/MT CIR		\$ 23.10

**Revision A**

Current revision date: December 1, 2018



**All prices listed herein supercede all other price lists, including (but not limited to) Scott master PDF price list. All prices are subject to change.**

**3M | Scott Fire & Safety Master Price List**

ITEM	Product Description	Signal Code	List Price
AB283109	NIPPLE,HEX 1/4 NPT S		\$ 4.10
AB283110	NIPPLE,HEX 1/8NPT STL HP		\$ 3.50
AB283111	NIPPLE,1/4 X 1/8 HEX STL		\$ 5.60
AB283112	NIPPLE,1/8NPT BRS HEX		\$ 7.30
AB283114	NIPPLE,1/4X1/8NPT HEX BRS		\$ 12.30
AB283120	REDUCER 3/8 X 1/8 STL PIPE HP		\$ 7.50
AB283307	TUBING,1/4 POLY FLO	EXP	\$ 1.70
AB283308	ELBOW,1/4 POLY X1/8NPTM BRS	EXP	\$ 6.75
AB283315	CAP,DUST QUICK DISCONNECT		\$ 4.30
AB283330	TEE,1/4 POLY X1/8NPTM BRS STRE		\$ 10.70
AB283334	ELBOW,1/8TU X 10-32ADJ SUR LOK		\$ 14.10
AB283411	V-BELT,C85 89" OD MATCHED		\$ 98.00
AB283443	V-BELT,A71 73 IN OD		\$ 25.80
AB283488	V-BELT,A72 74IN OD		\$ 25.00
AB2834A52	V-BELT,A52 54" OD		\$ 17.30
AB2834A55	V-BELT,A55 57IN OD		\$ 21.80
AB2834A73	V-BELT,A73 75 IN OD		\$ 20.40
AB2834A74	V-BELT, A74		\$ 27.10
AB2834C81	V-BELT,C81 85 IN OD		\$ 98.00
AB283675-1	COUPLING, FLEX TOOTH MODIFIED		\$ 113.00
AB283809	BUSHING,CLUTCH 1-3/8ID W/KEYST		\$ 225.00
AB283810	CLUTCH,AIRW/2B SHEAVE INTEGRAL	SVC	\$ 2,100.00
AB283811	KIT, AIR SUPPLY FOR 4UC CLUTCH		\$ 750.00
AB284124	ASSY,INDICATOR HP CO/H2O BODY		\$ 163.00
AB284130	VOLTMETER,150VAC PANEL MT1-1/2		\$ 278.00
AB284202	GROMMET,3/16ID 5/16HOLE 1/8GRO		\$ 0.60

**Revision A**

Current revision date: December 1, 2018



**All prices listed herein supercede all other price lists, including (but not limited to) Scott master PDF price list. All prices are subject to change.**

**3M | Scott Fire & Safety Master Price List**

ITEM	Product Description	Signal Code	List Price
AB284213	CABLE,6/4 SO BLACK	EXP	\$ 12.00
AB284232	HOLDER,FUSE PANEL MT 250V 15A		\$ 10.90
AB284263	GRIP, .75-.875 90EL ALU 1NPT		\$ 83.00
AB284270	RECEPTACLE,15A 125V DUPLEX		\$ 25.25
AB284286	COUPLER,FEM 16-14AWG FULLY INS		\$ 2.30
AB284290	TERMINAL,RING 12-10 X #10 UNIN	EXP	\$ 0.90
AB284306	ASSY,CGA346/347 FEM X 1/4 NPTM		\$ 71.00
AB284306A	ADAPTER,CGA346/347 FEMX4JIC ML		\$ 85.00
AB284309	ADAPTER,CGA346 MALE X1/4NPTM B		\$ 16.10
AB284318	ASSY,SCUBA CLAMPXCGA W/18"HOSE		\$ 253.00
AB284321A	ADAPTER,CGA347X1/4NPTF BRS MNI		\$ 42.10
AB284321B	ADAPTER,CGA347 MALEX1/4NPTM SS		\$ 44.25
AB284419	ASSY,HOSE 4FT 6KPSI W/4AN FE		\$ 132.00
AB284426	ASSY,6FTHP HOSE FSWVL6KPSI3/16		\$ 150.00
AB284443	HOSE,2"INTAKE SMOOTH BORE RIBB	EXP	\$ 9.40
AB284445	ASSY,25FT 6KPSI 3/16 W/4JIC		\$ 402.00
AB284446	ASSY,10FT 6KPSI 4JICF ENDSHOSE		\$ 205.00
AB284452	HOSE,250PSI 3/4 BLCK GEN PURPO	EXP	\$ 9.00
AB284453	BARB,3/4 HOSE X3/4NPTM BRS		\$ 13.00
AB284454	BARB,3/4 HOSE X1/2NPTM BRS		\$ 10.90
AB284455	ASSY,1FT HP HOSE FSWVL 6KPSI 3		\$ 46.75
AB284461	COUPLING,4JIC FEM SWIV X3/16HO		\$ 13.00
AB284478	HOSE,7KPSI 3/16 ID PARFLEX		\$ 14.10
AB284611	ELBOW,UNION 4MS STL		\$ 20.75
AB284612	ELBOW,4MS X1/4NPT MALE STL		\$ 25.00
AB284613	ELBOW,6MS X1/4MNPT BSTL		\$ 22.90

**Revision A**

Current revision date: December 1, 2018



**All prices listed herein supercede all other price lists, including (but not limited to) Scott master PDF price list. All prices are subject to change.**

**3M | Scott Fire & Safety Master Price List**

ITEM	Product Description	Signal Code	List Price
AB284617	ELBOW,4MS X1/8MNPT BSTL		\$ 19.40
AB284622	ELBOW,2MS X 1/8NPT SS		\$ 37.90
AB284636	ELBOW,2MS X1/8NPT STL		\$ 31.40
AB284637	ELBOW,2MSX1/4NPTM STL CPI		\$ 41.00
AB284701	CLAMP,1/4" OD RUBER CUSHIONED		\$ 3.10
AB284704	CLAMP,3/8" OD RUBBER CUSHIONED	EXP	\$ 0.90
AB284705	CLAMP,MS21919WDG10 CUSHIONED		\$ 24.75
AB284709	CLAMP,#8 CUSHIONED 1/2 TUBING	EXP	\$ 1.10
AB284710	CLAMP,SS WORM 1/4-5/8 MAX		\$ 3.30
AB284712	CLAMP,MS21919WDG5 CUSHIONED		\$ 3.25
AB284714	CLAMP,#16 HT SILICONE CUSHND H		\$ 1.50
AB284715	CLAMP,SS WORM 2-1/2 MAX		\$ 9.90
AB284736	CLAMP,HD 1X1-3/4 SS WORM		\$ 5.60
AB284738	CLAMP,5/8 NOM.PLASTIC SNAPPER	EXP	\$ 2.25
AB284804	CONNECTOR,BLKHD 4ANX4MS STL		\$ 44.60
AB284808	UNION,4ANX4AN STL BLKHD		\$ 14.10
AB284813	UNION,4MS X 4MS STL		\$ 8.00
AB284814	CONNECTOR,4MSX1/4NPTF STL BLKH		\$ 34.50
AB284818	UNION,4AN X 4AN SS		\$ 48.00
AB284837	CONNECTOR,4AN X1/8NPTF BLKHD S		\$ 19.40
AB285016	VALVE,SOLENOID 3WAY NC 230V		\$ 107.00
AB285041A	COIL 230V ASCO SERIES		\$ 128.00
AB285205	ELBOW,STREET 1/4NPT STL		\$ 12.00
AB285207	ELBOW,STREET 1/8NPT STL		\$ 10.70
AB285210	ELBOW,45 STREET 1/4NPT STL		\$ 8.50
AB285214	ELBOW,MALE 1/8NPT STL		\$ 10.40

**Revision A**

Current revision date: December 1, 2018



**All prices listed herein supercede all other price lists, including (but not limited to) Scott master PDF price list. All prices are subject to change.**

**3M | Scott Fire & Safety Master Price List**

ITEM	Product Description	Signal Code	List Price
AB285301	TEE,4MS 1/4NPTM BRANCH STL		\$ 35.00
AB285304	TEE,4MS X 1/4NPTM RUN STREET S		\$ 31.40
AB285309	TEE,4MSX1/4NPTF BRANCH STL		\$ 39.75
AB285310	TEE,4MSX1/8NPTF RUN STL		\$ 21.50
AB285311	TEE 6MSX6MSX1/4 NPTF STL RUN		\$ 26.00
AB285322	TEE,4ANX1/4NPTM BRANCH STL 4JI		\$ 21.60
AB285324	TEE,4ANX4ANFEM SWIVEL STL RUN		\$ 19.40
AB285427	ASSY,SENSOR CELL CO LE1010 LE1		\$ 1,780.00
AB285438	ASSY,SENSOR CELL CO LE5000		\$ 990.00
AB285557	BULB,QUARTZ 300W 120V		\$ 21.00
AB285574	MAST,15FT AIR LIFTLIGHT TOWER		\$ 2,160.00
AB285574K	KIT,REBUILD F/285574 AIR MAST		\$ 680.00
AB285627	TRANSFORMER,440VX115/230 100VA		\$ 231.00
AB285629	TRANSFORMER,380V X 220V 100VA	DIS	\$ 353.00
AB285709	METER,HOUR MINI 4-40VDC		\$ 108.00
AB285714	METER,HOUR 240V MINI HOBBS		\$ 144.00
AB286110	ELBOW,4AN X1/4NPTM STL 4JIC		\$ 9.40
AB286111	ELBOW,4AN X1/4NPTF STL 4JIC		\$ 15.25
AB286120	ELBOW,4AN SWIVEL NUT MALEXFEM		\$ 15.25
AB286423	RECEPTACLE, CLIP ON		\$ 4.80
AB286431E	END,5/16 8MM METAL GAS SPRING		\$ 6.90
AB28643560	SPRING,GAS 60LB 7.8IN STROKE		\$ 63.00
AB28643580	SPRING,GAS 80LB 5.47 IN STROKE		\$ 58.00
AB28643590	SPRING,GAS 90# 7.8STRK 18.2QAL		\$ 51.00
AB286435C	SPRING,90LB 5" STROKE GAS		\$ 55.00
AB286435MT	MOUNT,5/16 BALL STUD F/GAS SPR		\$ 5.00



**Revision A**

Current revision date: December 1, 2018



**All prices listed herein supercede all other price lists, including (but not limited to) Scott master PDF price list. All prices are subject to change.**

**3M | Scott Fire & Safety Master Price List**

<b>ITEM</b>	<b>Product Description</b>	<b>Signal Code</b>	<b>List Price</b>
AB286435R	CLIP,RETAINER FOR GAS SPRING	EXP	\$ 1.40
AB286445	LOCK, MECHANISIM		\$ 78.00
AB286453S	HINGE,2"OPEN 1/8 PIN 304SS 96"		\$ 2.80
AB286454	DETENT,1-8 THRD		\$ 53.00
AB286456	LOCK,LEVER W/INTERNAL 1WAY CAM		\$ 366.00
AB286456H	ROD,SPARE FOR 286456		\$ 53.00
AB286456K	KNOB,F/HANDLE REVOLVEAIR		\$ 37.90
AB286459	SPRING,40LB 2.36" STROKE GAS		\$ 41.50
AB286471	HANDLE,HD LOCKING ZINC 1/2SHAF		\$ 123.00
AB286503	COUPLING,1/4NPT STL HP	EXP	\$ 6.75
AB286831	BUSHING, 1-1/8 BORE TL 1610		\$ 45.70
AB286862	BUSHING,2517 X 1-5/8 TL		\$ 74.00
AB286876	BUSHING,H 1-3/8		\$ 36.10
AB286884	BUSHING,D 1-1/8		\$ 10.70
AB286904	ELBOW,MALE 1/4MNPT STL		\$ 10.90
AB286905	ELBOW,1/4 FEM STL HP		\$ 13.00
AB287001	TUBING, 1/4 X .049 304SS A269	EXP	\$ 12.00
AB287007	TUBING, 1/8 X .028 304SS A269	EXP	\$ 10.90
AB287008	TUBING, 3/8 X .065 304SS A269	EXP	\$ 21.80
AB287121	GAUGE,FUEL DIRECT READ TOPMNT		\$ 230.00
AB287426	BOX,2 GANG 3EA 1/2 OUTLETS		\$ 23.90
AB287441	CONNECTOR,3/8 BX FLEX CONDUIT		\$ 8.10
AB287441E	ELBOW,3/8 BX FLEX X1/2NPT 90DE		\$ 8.80
AB287525	CONNECTOR,7POLE TRAILER END		\$ 45.00
AB287530	HOSE,FUEL 1/4ID HEAVY DUTY	EXP	\$ 4.50
AB287536	CONNECTOR,7POLE VEHICLE END		\$ 45.00

**Revision A**

Current revision date: December 1, 2018



**All prices listed herein supercede all other price lists, including (but not limited to) Scott master PDF price list. All prices are subject to change.**

**3M | Scott Fire & Safety Master Price List**

<b>ITEM</b>	<b>Product Description</b>	<b>Signal Code</b>	<b>List Price</b>
AB287541	RELAY,DPDT 12VDC W78RCSX-7 P&B		\$ 124.00
AB287548	COVER,2GANG OUTDOOR OUTLET BOX		\$ 77.00
AB287609	MOTOR,5HP3450RPM 208/460V3P182		\$ 810.00
AB287610	MOTOR,15HP 1760RPM 230/460VODP		\$ 1,930.00
AB287637	MOTOR,10HP 1PH 3450RPM 208-230		\$ 1,890.00
AB287644	MOTOR,10HP 3PH 230/460V 3450R		\$ 1,820.00
AB287645	MOTOR,20HP 1760R 208/460V ODP		\$ 2,080.00
AB287650	MOTOR, 7.5HP 1PH 3450 230/460		\$ 2,170.00
AB287703	MOLDING,1/4 VINYL BLACK	EXP	\$ 3.00
AB287713	MOLDING,1/2X1/2 BLACK VINYL	EXP	\$ 3.75
AB287903	ELBOW,45 4MSX1/4NPTM STL		\$ 19.40
AB288010	MOUNT,NEOPRENE BLUE		\$ 53.00
AB288015	MOUNT,NEOPRENE WHITE SHOCK		\$ 94.00
AB288018	MOUNT,280# SNGL DFLC 3/8-16 GR		\$ 40.30
AB288019	MOUNT,8-32 5/8W 1/2H MALE X FE		\$ 7.50
AB288028	MOUNT,730#DOME TYPE RUBBER 3/8		\$ 24.75
AB288031	MOUNT,1.5DIA X 1H 5/16-24 THRD		\$ 16.80
AB288101	ELBOW,45D 4AN X1/8NPTM STL 4JI		\$ 10.90
AB288215	TUBING,3/8ID X5/8OD PLASTIC RE	EXP	\$ 15.50
AB288231	ELBOW,1/8NPTM X 3/8 BARB BRS		\$ 10.90
AB288232	COUPLING,HI-FLO QD 1/2HOSE W/C		\$ 52.00
AB288233	COUPLING,HI-FLO QD 1/2NPTM THR		\$ 21.80
AB288443	BAGGING,5-1/2X500FT POLYMYLAR	EXP	\$ 1.50
AB288459	CONTAINER,2-1/2G PLASTIC W/LID		\$ 73.00
AB288705	TUBING,1/8 NYLON	EXP	\$ 0.75
AB288811	CASTER,8X2.5GRAY POLY 1100LB S	SVC	\$ 284.00

**Revision A**

Current revision date: December 1, 2018



**All prices listed herein supercede all other price lists, including (but not limited to) Scott master PDF price list. All prices are subject to change.**

**3M | Scott Fire & Safety Master Price List**

<b>ITEM</b>	<b>Product Description</b>	<b>Signal Code</b>	<b>List Price</b>
AB290060	ASSY,346/347CGAX6SAE MALE FILL	SVC	\$ 92.00
AB290329	HOSE REEL 6KPSI 250FT LIB II		\$ 6,540.00
AB290330	OPT,LP HOSE REEL 150FT 300PSI		\$ 3,870.00
AB290394	ASSY,SCUBA X RVLVR W/SUPP RACK		\$ 424.00
AB294203	CORD,16/3 SO	EXP	\$ 1.70
AB294222	LOCKNUT,1NPT CONDUIT FITTING	EXP	\$ 0.80
AB294238	LOOM,3/8 CONVOLUTED PLASTIC	EXP	\$ 1.10
AB294246	GRIP,.250-.375 90EL ALUM 1/2NP		\$ 38.40
AB294271	CORD,6/3 SO POWER	EXP	\$ 10.40
AB294275	GRIP,CORD .63-.75 3/4NPT EL ST		\$ 56.00
AB294283	BOOT,WEATHERPROOF F/C26145		\$ 33.60
AB294286	CONNECTOR,1/2 SUPER FLEX CONDU		\$ 6.00
AB294290	CONDUIT,3/8 SUPER FLEX BLK PVC	EXP	\$ 4.30
AB294292	ELBOW,3/8 SUP FLEX BLK CONDUIT		\$ 9.00
AB296808	SHEAVE,2A,4.2,4.45 OD "A"ONLY		\$ 72.00
AB299317	TERMINAL,RING #8 5/16 INSUL	EXP	\$ 1.70
AB299323	BATTERY,MARINE GRP24 MIN 485CA		\$ 294.00
AB299507	REEL,CORD 30FT 16/3 120V AC		\$ 167.00
AB299609	DISCONNECT,SOCKET 1/4NPTM W/LO		\$ 51.00
AB299617	PLUG,QD 1/4NPTM STL		\$ 2.10
AB299639	BARB,1/2HOSE X 1/2NPTM 90D BRS		\$ 10.90
AB299702	ELBOW 1/2 STREET BLK IRON		\$ 10.60
AB299703	PLUG,1/2 SQ HD BLK IRON		\$ 1.25
AB299727	ELBOW,1-1/4NPT STREET BLK PIPE		\$ 18.25
AB299734	NIPPLE,1-1/4 CLOSE BLK PIPE		\$ 6.40
AB299758	BUSHING,1NPT X3/4NPTF BLK PIPE		\$ 14.75

**Revision A**

Current revision date: December 1, 2018



**All prices listed herein supercede all other price lists, including (but not limited to) Scott master PDF price list. All prices are subject to change.**

**3M | Scott Fire & Safety Master Price List**

<b>ITEM</b>	<b>Product Description</b>	<b>Signal Code</b>	<b>List Price</b>
AB299823	TEE,MALE BRANCH 1/4NPT BRS		\$ 18.50
AB299866	TEE,STREET 1/4NPT BRS		\$ 18.40
AB299873	REDUCER,3/8NPTM X 1/4NPTF BRS		\$ 4.10
AB299874	REDUCER,1/2NPTM X1/4NPTF BRS	EXP	\$ 5.90
AB300007	NUT,1/4-20 HEX ZINC PLATED	EXP	\$ 0.30
AB300014	FLATWASHER, SAE 7/16 ZINC		\$ 0.60
AB300015	LOCKWASHER,7/16 SPLIT		\$ 0.40
AB300031	SCREW,8-32 X3/4 PHIL PAN ZINC	EXP	\$ 0.30
AB300042	BOLT,5/16-18X1-1/2 HX GRD5		\$ 0.40
AB300047	LOCKWASHER,1/4 SAE SPLIT SS	EXP	\$ 0.30
AB300050	ROD, THREADED 1/2-13 X 3FT ZIN		\$ 21.80
AB300108C	CARD,10/20/30% MOISTURE INDICA		\$ 10.90
AB300117	CO/HUMIDITY INDICATOR CARD		\$ 40.30
AB300205	ASME RECEIVER		\$ 2,490.00
AB300316	WIRE,16AWG BLACK TFFN 80C TEFL	EXP	\$ 0.60
AB300334	WRAP,CABLE 3/4 SPIRAL OUTDOOR	EXP	\$ 3.25
AB300366	WRAP,HOSE.91-1.45 OD BLK SPIRA	EXP	\$ 13.00
AB300807	TAPE,1/4 HD TEFLON TAPE	EXP	\$ 6.00
AB300901	CONNECTOR,4JIC FEM X1/4NPTM SW		\$ 12.00
AB300903	SWIVEL,5KPSI 1/4NPT LIVE PRESS		\$ 171.00
AB303040	ASSY,EMER STOP 1-NC 1-NO LATCH		\$ 158.00
AB303041	ACTUATOR,EMER STOP LATCHING		\$ 23.90
AB303042	MOUNT,EMER STOP SWITCH		\$ 1.70
AB303043	SWITCH,NORM CLOSED CONTACT		\$ 9.00
AB303044	SWITCH,NORM OPEN CONTACT		\$ 9.00
AB303050	ASSY 3POS SELECT SWITCH W/CONT		\$ 107.00

**Revision A**

Current revision date: December 1, 2018



**All prices listed herein supercede all other price lists, including (but not limited to) Scott master PDF price list. All prices are subject to change.**

**3M | Scott Fire & Safety Master Price List**

<b>ITEM</b>	<b>Product Description</b>	<b>Signal Code</b>	<b>List Price</b>
AB30378	O-RING,-25		\$ 23.90
AB304201	TRAILER CABLE PER SAE J1067	EXP	\$ 12.10
AB304204	PLUG,1/2NPT AL WP OUTLET BOX		\$ 2.30
AB304251	GROMMET,ALL FIT 1.375 HOLE BLK		\$ 1.00
AB310035	FUSE,1MDL SLOW BLOW	EXP	\$ 7.50
AB310037	STEM,SHORT 60AL FILTER		\$ 57.00
AB310038	STEM,MEDIUM 60AL FILTER		\$ 74.00
AB310038A	STEM, MED 65AL		\$ 74.00
AB310038B	TUBE,65AL COALESCER 65X10CA IN		\$ 68.00
AB310182	COOLANT,ANTI-FREEZE	EXP	\$ 42.90
AB310397	HOSE,1" SPIRAL RIB SMOOTH BORE		\$ 4.10
AB310506	NUT,2MS CPI STL		\$ 2.50
AB310543	LIGHT,26" FLUORES 12V W/SWITCH		\$ 209.00
AB310567	U-BOLT,7/16-14 X 1ASME RECEIVE		\$ 8.30
AB310658	RIVET,PUSH IN	EXP	\$ 0.60
AB310777	RECEIVER,4500PSI DOTW/VALVE&CA		\$ 1,720.00
AB310932	PISTON SWITCH 500-6000 PSI ADJ		\$ 335.00
AB311128	CLUTCH OIL, AIR TOOL OIL		\$ 22.00
AB311176	JACK,7K TOPWIND DROPFT TRAILER		\$ 192.00
AB3205F	ASSY,346/347 FEM X 4JIC FEM SW		\$ 130.00
AB3206A	ASSY,346/347 HANDWHEEL/NIPPLE		\$ 144.00
AB3302	ASSY,MANIFOLD CONNECT W/OVALVE		\$ 68.00
AB3303	ASSY,CONNECTION CYL TO CYL DOT		\$ 156.00
AB34606	SEAT, DELIVERY VALVE		\$ 550.00
AB35138	PISTON, 4TH STAGE		\$ 680.00
AB35139	4TH STAGE CYL SLEEVE		\$ 1,340.00

**Revision A**

Current revision date: December 1, 2018



**All prices listed herein supercede all other price lists, including (but not limited to) Scott master PDF price list. All prices are subject to change.**

**3M | Scott Fire & Safety Master Price List**

<b>ITEM</b>	<b>Product Description</b>	<b>Signal Code</b>	<b>List Price</b>
AB35140	RING,4TH STAGE PISTON		\$ 21.80
AB35333	GASKET,CYLINDER BASE-17	DIS	\$ 13.00
AB35334	GASKET,VALVE CYLINDER-17		\$ 10.70
AB3CAC	ELEMENT, FILTER CATALYST		\$ 133.00
AB3CACB-5	KIT,ELEM CATALYST/CARBON 20SS		\$ 670.00
AB3X	ELEMENT, FILTER		\$ 139.00
AB3XB-5	ELEMENT,DESICCANT 20SS FILTER		\$ 530.00
AB400000	OIL FILTER, LMF-V17		\$ 39.75
AB400001	FILTER OIL LMF V16		\$ 27.30
AB4008-3005	MANIFOLD,DUMP COLL. SKD 1		\$ 109.00
AB4008-4003	BRACKET ASSY, PURIFIER SKD1		\$ 421.00
AB42X5A	ELEMENT, FILTER		\$ 94.00
AB42XCAC	ELEMENT, FILTER		\$ 115.00
AB4457K118	FILL PIPE		\$ 34.10
AB5007-0016	REVOLVE AIR, RESCUE AIR		\$ 9,910.00
AB5007-1013	COVER,ADD ON CASCADE CONTROL B		\$ 95.00
AB5007-1017-3	BRACKET,PANEL LIGHT RVLVR AVGR		\$ 158.00
AB5016-2000	OPTION,2B CSCD ADD-ON CNTRL		\$ 2,230.00
AB5016-4000	OPT,4B CSCD ADD-ON CNTRL PANEL		\$ 3,060.00
AB5019-0101	ASSY,25FT CNTRL CABLE LE 4&5K		\$ 328.00
AB5019-0402	MOTOR PLATE ASSEMBLY		\$ 210.00
AB5019-0403	DUMP TEE ASSEMBLY		\$ 202.00
AB5019-0405	HINGE PIN ASSEMBLY		\$ 51.00
AB5019-0406	SHIPPING PIN ASSEMBLY		\$ 29.25
AB5033-1125-41	INTERLOCK VALVE LEVER ASSY		\$ 150.00
AB50CAC	ELEMENT, FILTER		\$ 120.00

**Revision A**

Current revision date: December 1, 2018



**All prices listed herein supercede all other price lists, including (but not limited to) Scott master PDF price list. All prices are subject to change.**

**3M | Scott Fire & Safety Master Price List**

ITEM	Product Description	Signal Code	List Price
AB50X	ELEMENT, FILTER		\$ 115.00
AB50X8C	ELEMENT,FILTER W/COALESCER		\$ 147.00
AB50X9	ELEMENT,FILTER COALESCER		\$ 134.00
AB50XAC	ELEMENT,FILTER		\$ 111.00
AB50XCAC	ELEMENT,FILTER		\$ 144.00
AB52X	FILT. ELEM. COLTRI UPGRADE KIT		\$ 162.00
AB52XCAC	ELEMENT,52AL COMBO PURIFIER		\$ 149.00
AB603AA	ELEMENT,3A SIEVE W/10% ALUMINA		\$ 149.00
AB60CAC	ELEMENT,FILTER 60AL		\$ 138.00
AB60X	ELEMENT,FILTER 60AL		\$ 118.00
AB60X10C	ELEMENT,FILTER 60AL	SVC	\$ 150.00
AB60X5A	ELEMENT,FILTER		\$ 146.00
AB60XCAC	ELEMENT,FILTER		\$ 153.00
AB6111-1009	VALVE,MODIFIED 3WAY TRUNNION		\$ 940.00
AB6111-1010	COLLAR,HOKE TRUNNION VALVE SS	DIS	\$ 39.00
AB6111-1013	ASSY,ACTUATOR ARM RVLVR INTERL		\$ 267.00
AB6130-0111T	COVER,LIGHT/AIR MAST VINYL		\$ 151.00
AB6130-0121-11	TANK BODY ASSEMBLY		\$ 2,340.00
AB6130-0202	ASSY, 6FT LE CONTROLLER CABLE		\$ 277.00
AB6130-0216	SCHEMTAIC,ELEC LIB-I 36E/D	EXP	\$ 0.30
AB6130-0316	SCHEMATIC,PNEU LIB-I 36E/D	EXP	\$ 0.30
AB6130-1132	DBL SHAFT,ELECTRIC MOTOR		\$ 3,730.00
AB6130-1300	PURIFIER,65AL4.5 LIB1 & 2		\$ 8,860.00
AB6130-7000	ASSY,DUAL MAST 2KW LIGHTS & IN		\$ 7,950.00
AB6130-7000-1	ASSY,DUAL MAST W/OUT LIGHTS		\$ 6,720.00
AB6130-7101	TUBE,3-1/2X3/4"INTAKE MAST BOT		\$ 670.00

**Revision A**

Current revision date: December 1, 2018



**All prices listed herein supercede all other price lists, including (but not limited to) Scott master PDF price list. All prices are subject to change.**

**3M | Scott Fire & Safety Master Price List**

<b>ITEM</b>	<b>Product Description</b>	<b>Signal Code</b>	<b>List Price</b>
AB6130-7101C	COLLAR,INTAKE MAST LIB-I BOTTO		\$ 142.00
AB6130-7102	TUBE,2-3/4X32" INTAKE MAST 2ND		\$ 476.00
AB6130-7102C	COLLAR,INTAKE MAST LIB-I 2ND S		\$ 62.00
AB6130-7103	TUBE,2-1/2X32"INTAKE MAST 3RD		\$ 275.00
AB6130-7103C	COLLAR,INTAKE MAST LIB-I 3RD S		\$ 51.00
AB6130-7104	TUBE,2-1/4X30-1/2 INTAKE MAST		\$ 341.00
AB6130-7104C	COLLAR,INTAKE MAST LIB-I 4TH S		\$ 64.00
AB6130-7105	TUBE,2"X29-3/4 INTAKE MAST 5TH		\$ 369.00
AB6130-7105C	BREATHER,INTAKE MAST LIB-I TOP		\$ 82.00
AB6130-7300	ASSY,2KW FLOODLIGHTS LIB-I		\$ 1,470.00
AB6130-7301	ASSY,2KW FLOODLIGHT HEAD 120VA		\$ 910.00
AB6130-7410	NUT,COUPLING F/LIGHT X AIR MAS		\$ 101.00
AB6130-7411	NUT,COUPLING F/LIGHT X AIR MAS		\$ 19.60
AB6130-7412	NUT,COUPLING F/LIGHT X AIR MAS		\$ 19.60
AB6130-7413	NUT,COUPLING F/LIGHT X AIR MAS		\$ 18.40
AB6130-8000	OPTION,COLD WEATHER RUN LIB I-		\$ 2,390.00
AB6130-9101D	TRLR DOOR, SINGLE, UNPAINTED		\$ 1,060.00
AB6130-9103D	TRAILER ROOF, UNPAINTED		\$ 1,520.00
AB6130-9112	SIDE,LEFT LIB-I W/WELDED FEND		\$ 1,740.00
AB6130-9112A	TRAILER BODY L.H. WHITE		\$ 1,610.00
AB6130-9112D	TRAILER BODY L.H.UNPAINTED		\$ 1,660.00
AB6130-9113A	TRAILER BODY R.SIDE WHITE		\$ 1,610.00
AB6130-9114D	FENDER WELL COVER, UNPAINTED		\$ 341.00
AB6130-9116	GRILL,RIGHT REAR LIB-I-36		\$ 1,510.00
AB6130-9117	GRILL,LEFT REAR LIB-I-36		\$ 1,510.00
AB6130-9210	SCREEN,LIB-I RIGHT SIDE COMP F		\$ 104.00



**Revision A**

Current revision date: December 1, 2018



**All prices listed herein supercede all other price lists, including (but not limited to) Scott master PDF price list. All prices are subject to change.**

**3M | Scott Fire & Safety Master Price List**

ITEM	Product Description	Signal Code	List Price
AB6130-9220	SCREEN,LIB-I LEFT SIDE COMP FA		\$ 96.00
AB65AL	ASSY,PURIFICATION BASE/CHAMBER		\$ 1,610.00
AB65CAC	ELEMENT,FILTER 65AL	SVC	\$ 136.00
AB65X	ELEMENT,FILTER 65AL		\$ 119.00
AB65X10C	ELEMENT,FILTER 65AL		\$ 142.00
AB65X10CA	ELEMENT,COALESCER & DRYER PURI	SVC	\$ 160.00
AB65XCAC	ELEMENT,COMBINATION PURIFIER	SVC	\$ 126.00
AB66CAC	ELEMENT, FILTER, 66AL		\$ 138.00
AB66X	ELEMENT, FILTER, 66AL		\$ 123.00
AB66X10CA	ELEMENT, COALESCER & DRYER, 66		\$ 148.00
AB66XCAC	ELEMENT, COMBINATION, 66AL		\$ 126.00
AB7206-3006	BLOCK,MANIFOLD 3X3 CAROUSEL		\$ 61.00
AB7402	CYL(HM),20PPM CALIBRATION GAS		\$ 89.00
AB7410	CYLINDER(HM),0PPM SPAN GAS CO	SVC	\$ 84.00
AB8085	CAP,OIL FILLER-7-10-16-24		\$ 39.75
ABA017615	CYL,7/16 BORE X 1 1/2 STROKE		\$ 83.00
ABA021838	ADAPTER,M18X1.5 TO 3/8NPTF CON		\$ 32.75
ABA022125	INTAKE HOSE ADAPTER		\$ 65.00
ABA02350	ASSY,250/300 BAR DIN FILL ADAP		\$ 114.00
ABA02350J	ADAPTER, 250/300 DIN X 4JIC FI		\$ 165.00
ABA02350P	ASSY, 250/300 DIN X 1/4NPTM CH		\$ 120.00
ABA024252	ADAPTER,52AL BASE X 42AL BOTTO		\$ 22.90
ABA025016	ADAPTER,1/4NPT MXF 1/16 NPTF S		\$ 31.70
ABA02614	ADAPTER,6SAE X1/4NPTF STL PIPE	EXP	\$ 6.00
ABA02616	ADAPTER,6SAE FEM X1/4NPT MALE		\$ 15.25
ABA027000	ADAPTER,FLOODLIGHT HEAD X AIR		\$ 10.80

**Revision A**

Current revision date: December 1, 2018



**All prices listed herein supercede all other price lists, including (but not limited to) Scott master PDF price list. All prices are subject to change.**

**3M | Scott Fire & Safety Master Price List**

<b>ITEM</b>	<b>Product Description</b>	<b>Signal Code</b>	<b>List Price</b>
ABA043400	ANCHOR,5/8" DIA 3"LG GRDS ZINC		\$ 18.40
ABA071017	AXLE, TRAILER		\$ 2,240.00
ABB071306	BEARING,FLANGE 1.25 ID 1.344 O	EXP	\$ 4.30
ABB074121	BEARING,BALL 1.3125ID 2.5625OD		\$ 81.00
ABB083205	BELT,TIMING 390H100 39"PD 1"W		\$ 67.00
ABB112538	BOLT,1/4-20 X3/8 GRD2 HXHD ZIN	EXP	\$ 0.40
ABB113835	BOLT,3/8-16X3-1/4 HXHD GRD5 ZI	EXP	\$ 0.30
ABB114214	BOLT,1/4-20 X2-1/4 SS HXHD	EXP	\$ 1.70
ABB21001	BUSHING,MK111 SKD NYL PANEL IN	EXP	\$ 1.10
ABB305000	ASSY,PS3 LE5000 LE4000 PWR BOA		\$ 700.00
ABC023000	CABLE,30FT LE4K LE5K CONTROLLE		\$ 356.00
ABC023500	CABLE,35FT LE4K LE5K CONTROLLE		\$ 368.00
ABC100617E	END,#10 BEAD NICPLTD BRASS.193	EXP	\$ 0.75
ABC113300-30	CHANNEL,GALV STRUT 30"		\$ 75.00
ABC113310	CHANNEL,STRUT 1-5/8X1-5/8 SLOT		\$ 15.25
ABC13048	CLAMP,2-1/2 OD CUSHION TUBE ST		\$ 28.50
ABC13097	CLAMP,3 1/2 TUBE STL STRUT		\$ 47.25
ABC133112	CLAMP,1/2 SOFT TUBING ADJ NYLO		\$ 3.00
ABC167245	END,10-32 FEM THRD BALL JOINT		\$ 15.30
ABC210017	COMPRESS, BARE-17 4S17 V22H-AL		\$ 13,140.00
ABC210025	COMPRESSOR, BARE-25 4S25		\$ 15,130.00
ABC214000	COMPRESSOR,MCH-16 3SCOLTRIBARE		\$ 10,380.00
ABC26013	ADAPTER,1/4NPTM X 1/4NPTF SS		\$ 29.00
ABC26145	CONNECTOR,2POLE 3WIRE 15ATL CO		\$ 59.00
ABC26418	CONNECTOR, 60A 600V FEM CORD		\$ 720.00
ABC42104	CORD,10/4 SO BLACK 25AMP MAX	EXP	\$ 2.50

**Revision A**

Current revision date: December 1, 2018



**All prices listed herein supercede all other price lists, including (but not limited to) Scott master PDF price list. All prices are subject to change.**

**3M | Scott Fire & Safety Master Price List**

<b>ITEM</b>	<b>Product Description</b>	<b>Signal Code</b>	<b>List Price</b>
ABC432230	CHARGER,3AMP 230VACX12VDC AUTO	DIS	\$ 430.00
ABC477111	CONTAINER,1000ML POLY SCREW TO	EXP	\$ 28.25
ABE02320	ENGINE,DIESEL 44.9 LOMBARDINI		\$ 17,330.00
ABE060668	ELEMENT,PARTIC 20SS AFT FILTER		\$ 267.00
ABE0612041	ELEMENT,AIR FILTER LDW1204 FOC		\$ 73.00
ABE0612042	ELEMENT,OIL FILTER LDW1204FOCS		\$ 53.00
ABE0620041	ELEMENT,INTAKE 2004 DIESEL ENG		\$ 170.00
ABE0620042	ELEMENT,ENGINE OIL 2004 FILTER		\$ 53.00
ABE0620043	ELEMENT,DIESEL FUEL 2004 FILTE		\$ 85.00
ABE065387	ELEMENT,REMOTE INTAKE		\$ 27.10
ABF04017	AIR FILTER, LMF-V17		\$ 155.00
ABF047125	FILTER,REMOTE INTK 50CFM 1-1/4		\$ 229.00
ABF0536T4	FAN,EXTENDED BLADE 15T4 COOLIN		\$ 760.00
ABF13645	FUSE,FAST 5.0 AMP SUB-MINI	EXP	\$ 2.50
ABF38100	FILTER, OIL DIESEL		\$ 45.00
ABG020100P	GAUGE, 2-5/8" 0-100PSI PM		\$ 112.00
ABG020400P	GAUGE, 0-400PSI PM 2-5/8 CB		\$ 112.00
ABG020600P	GAUGE, 2-5/8" 0-600PSI PM		\$ 112.00
ABG023000P	GAUGE, 2-5/8" 0-3000PSI PM		\$ 172.00
ABG146000	GENERATOR,6KW 3600RPM 120/240		\$ 1,770.00
ABG148000	GENERATOR,7.2KW120/240 3600RPM		\$ 1,820.00
ABH04738	ASSY,100FT 6KPSI 4JIC SWVL HOS		\$ 1,030.00
ABH070025	HOSE ASSY 40FT 3/16 ID 7K PSI		\$ 530.00
ABH070144	ASSY,12FT HOSE 6KPSI WP 4JIC S		\$ 257.00
ABH070329	ASSY, HOSE 24IN 7KPSI 4AN FEM		\$ 67.00
ABH070330	ASSY, HOSE 42IN 6KPSI 4AN FEM		\$ 118.00

**Revision A**

Current revision date: December 1, 2018



**All prices listed herein supercede all other price lists, including (but not limited to) Scott master PDF price list. All prices are subject to change.**

**3M | Scott Fire & Safety Master Price List**

<b>ITEM</b>	<b>Product Description</b>	<b>Signal Code</b>	<b>List Price</b>
ABH070336	ASSY,3FT 6KPSI 4AN FEM SWVL HO		\$ 104.00
ABH070360	ASSY,30FT 6KPSI 4JIC FSWVL HOS		\$ 445.00
ABH070378	ASSY,6KPSI 78"HOSE 4AN FEM SWV		\$ 174.00
ABH070396	ASSY,8FT 6KPSI 4AN FEM SWIVELS		\$ 174.00
ABH070700	ASSY,50FT 6KPSI 4JIC FE ENDS H		\$ 620.00
ABH071001	ASSY,18"6KPSI 4AN FEM SWVL HOS		\$ 90.00
ABH071120	HOSE,1-1/2 SPIRAL RIB SMOOTH B		\$ 5.50
ABH07180	ASSY,15FT 6KPSI HOSE 4JIC FEM		\$ 275.00
ABH072030	ASSY,30"4JIC SWIV 6KPSI HOSE		\$ 103.00
ABH075250	ASSY, 250FT 7KPSI 4JIC FEMSWIV		\$ 2,590.00
ABH085024	ASSY,2FT 6KPSI 4AN FEM SWVL HO		\$ 89.00
ABH13003	HEATER,50W 120VAC 5X28" BLANKE		\$ 123.00
ABH13004	HEATER,WALTERJACKET 2004 LOMB		\$ 177.00
ABH15T6-12	COMPRESSOR I/R #CCN81290850		\$ 26,850.00
ABH15T6-230	IR 6K W/230VAC SOLENOID		\$ 26,850.00
ABI051006	INSULATION,SOUND WHITE W/ADHES		\$ 235.00
ABI051006-4	22X34 SOUNDFOAM WHITE/ADHES		\$ 141.00
ABK02443	KIT,FLOW FUSE F/RVLVR REAR OUT		\$ 277.00
ABK02853	KIT,TRAILER UNDER 80"DOT LIGHT		\$ 114.00
ABKV1007	KIT, UNLOADER VALVE REPAIR		\$ 427.00
ABL01001	LATCH,CAM FINGER KNOB ACTUATED		\$ 12.10
ABL01002	LATCH,CAM SCREWDRIVER ACTUATED	DIS	\$ 12.00
ABL011006	LATCH,PUSH LOCK BUTTW/OKEY LOC		\$ 39.75
ABL011007	LATCH,RUBBER DRAW W/NYLON STRI		\$ 24.10
ABL101010	LOCKWASHER,#10 SS SAE	EXP	\$ 0.30
ABL101050	LOCKWASHER,#8 STL CAD PL	EXP	\$ 0.30

**Revision A**

Current revision date: December 1, 2018



**All prices listed herein supercede all other price lists, including (but not limited to) Scott master PDF price list. All prices are subject to change.**

**3M | Scott Fire & Safety Master Price List**

ITEM	Product Description	Signal Code	List Price
ABL18016	DECAL,CONTROL PANEL TRAILER		\$ 112.00
ABM-034020	MOISTURE SEPARATOR SIAC		\$ 440.00
ABM097000	TAB,INTAKE TO AIR MAST MOUNTIN		\$ 58.00
ABM6A20	CARTRIDGE MCH6 TYPE PURIFIER		\$ 148.00
ABN020677	ASSY,CGA 677 NIPPLE & NUT		\$ 117.00
ABN020702	ASSY,CGA 702 NIPPLE & NUT		\$ 127.00
ABN02677	NIPPLE,CGA677 1/4MNPT SS		\$ 60.00
ABN04010	NUT,1-1/4NPT JAM NUT STEEL		\$ 13.00
ABN04018	NUT,HEX JAM 1-8 CAD GRD2		\$ 5.25
ABN041008	NUT,3/8 TWIST ON F/STRUT		\$ 4.60
ABN041025	LOCKNUT,1/4-20 SS NYLOK	EXP	\$ 0.60
ABN04249	NUT,1/4-20 ACORN SS	EXP	\$ 3.50
ABN04677	NUT, CGA 677		\$ 59.00
ABN048215	JAMNUT,3/8-24 GRD2 CAD		\$ 0.30
ABP06181	PIN,1/8 X 1-1/8 SS TENSION SPR	EXP	\$ 0.30
ABP10001	PLUG,HP HEX 1NPT STEEL		\$ 17.30
ABP10422	PLUG,60A MOTOR 600V LOCKING		\$ 820.00
ABP104220	PLUG,4AN STL END CAP	EXP	\$ 4.60
ABP10798	INLET,2POLE 3WIRE 15A 125V FLA		\$ 68.00
ABR11969	REGULATOR,6KPSI X 0-250 ADJ		\$ 246.00
ABR283740	RIVET,NYLON RATCHET 9/32.346-.	EXP	\$ 0.75
ABS040726	SCREW,8-32X1/2 PHIL PNHD ZINC	EXP	\$ 0.30
ABS041018	SCREW,4-40X3/4 SHCS SS	EXP	\$ 0.40
ABS041019	SETSCREW,8-32 X 1/8 SS CUP POI		\$ 2.50
ABS041160	SCREW,10-32 X 1/2 SHCS SS	EXP	\$ 0.40
ABS044827	SCREW,10-32 X 3/8 PN HD PHIL		\$ 1.60

**Revision A**

Current revision date: December 1, 2018



**All prices listed herein supercede all other price lists, including (but not limited to) Scott master PDF price list. All prices are subject to change.**

**3M | Scott Fire & Safety Master Price List**

ITEM	Product Description	Signal Code	List Price
ABS051000	ASSY,1EA SEALOFF W/12"BEAD C		\$ 44.25
ABS065000-8	SENSOR,8FT TEMP F/LE4000 LE500		\$ 464.00
ABS100070	SHEAVE,2C 7.0 7.4 OD TL 2517		\$ 408.00
ABS10074	SHEAVE,2A 74D 7.25 OD		\$ 202.00
ABS101002	SHEAVE, 2A49D 4.75OD PD=4.50		\$ 145.00
ABS24143	SPACER,3/8OD X1/2L F/#10 SCREW		\$ 1.75
ABS282380	SPRING,SS TAPER .843X1.25 OD .		\$ 23.75
ABS40050	SWITCH,LOW OIL LEVEL-25 COMPRE		\$ 232.00
ABS444753	SHEET,1X24X24 OPENCELL POLYU	EXP	\$ 85.00
ABT168519	TIE,7" RBBRBNBND W/STOP BUNDLE		\$ 4.50
ABT19022	TAPE,FIBERGLASS 1"W ALUM RINFR	EXP	\$ 2.50
ABT194524	TAPE,10MIL X3IN POLYETHYLENE G	EXP	\$ 0.30
ABT212700	BOARD,POWER 85-264VAC 15VDC		\$ 93.00
ABU0222	UNION,BLKHD 2MS STL		\$ 44.60
ABUL101	KIT,REPAIR AUTO DRAIN VALVE		\$ 214.00
ABV011000	V-BELT, B65		\$ 32.40
ABV01B45	V-BELT,BX45 48IN OD		\$ 35.40
ABV02004	VALVE,BLEED 1/4NPTM		\$ 56.00
ABV021001	VALVE,DRAIN 7.5KPSI 1/4NPT STL		\$ 14.10
ABV021006	VALVE,3/8NPTMX5/8 HOSE BRS TRU		\$ 48.00
ABV023511	VALVE,ADJ VENT & SILENCER EXH		\$ 111.00
ABV02796	RESTRICTOR, .047 5KPSI 1/4NPTMF		\$ 61.00
ABV02816	VALVE,TOGGLE 6KPSI 1/4NPT ALUM		\$ 243.00
ABV028578	VALVE, 6KPSI 3-WAY TRUNION BAL		\$ 203.00
ABV029251	VALVE,RESTRICTOR 1/8NPT ADJ		\$ 74.00
ABV029885	RELIEF VALVE, 1ST STAGE		\$ 76.00

**Revision A**

Current revision date: December 1, 2018



**All prices listed herein supercede all other price lists, including (but not limited to) Scott master PDF price list. All prices are subject to change.**

**3M | Scott Fire & Safety Master Price List**

<b>ITEM</b>	<b>Product Description</b>	<b>Signal Code</b>	<b>List Price</b>
ABV029895	VALVE,RELIEF 2ND STG 400PSI IR		\$ 133.00
ABVCA955	VALVE,CHECK M-F FLOW		\$ 95.00
ABW01065	WASHER,65AL STEM BOTTOM SEALIN	EXP	\$ 0.40
ABW011000	WASHER,NYLON #4 .206 X .053	EXP	\$ 0.40
ABW017145	WASHER,DELFIN 3/4 X.065 1.312		\$ 2.75
ABW017401	FLATWASHER,5/16 NYLON .062	EXP	\$ 0.60
ABW032000	WHEEL & TIRE,15"6BOLT X7 2540#		\$ 790.00
ABY25309	VALVE SEAT WASHER		\$ 16.40
M21	POS13 USB FULL VERSION SOFTWARE		\$ 1,630.00
M23	POS13 USB EN VERSION SOFTWARE		\$ 1,630.00
M24	POS13 USB CALIBRATION		\$ 876.00
M27	Cylinder Valve Socket Kit		\$ 38.20
M29	Air Suppld Spec Level Stud Kit		\$ 4.20
M36	POS13 USB REPL CD/UPDATE	SAR	\$ 54.10
MS27980-9B	EYELET, BLACK, STYLE 2	EXP	\$ 3.25
MS27983-1	BUTTON,BLACK,STYLE 4		\$ 3.25
MS27983-2	SOCKET,BLACK,STYLE 4		\$ 3.25
MS27983-3	STUD,BLACK,STYLE 4	EXP	\$ 3.25
RSG-GL10N-B	MON,GREY,CSA,O2		\$ 299.00
RSG-GL10N-C	MON,GREY,CSA,H2S		\$ 299.00
RSG-GL10N-D	MON,GREY,CSA,CO		\$ 299.00
RSG-GL10N-E1	MON,GREY,CSA,HSL		\$ 350.00
RSG-GL10N-F	MON,GREY,CSA,SO2		\$ 399.00
RSG-GL10N-G	MON,GREY,CSA,CL2		\$ 399.00
RSG-GL10N-H	MON,GREY,CSA,NO2		\$ 399.00
RSG-GL10N-I	MON,GREY,CSA,CLO2		\$ 499.00

**Revision A**

Current revision date: December 1, 2018



**All prices listed herein supercede all other price lists, including (but not limited to) Scott master PDF price list. All prices are subject to change.**

**3M | Scott Fire & Safety Master Price List**

<b>ITEM</b>	<b>Product Description</b>	<b>Signal Code</b>	<b>List Price</b>
RSG-GL10N-J	MON,GREY,CSA,NH3		\$ 399.00
RSG-GL10N-K	MON,GREY,CSA,HCN		\$ 399.00
RSG-GL10N-L	MON,GREY,CSA,O3		\$ 499.00
RSG-GL10N-M	MON,GREY,CSA,COH		\$ 350.00
RSG-GL10N-N	MON,GREY,CSA,NO		\$ 399.00
RSG-GL10N-U	MON,GREY,CSA,PH3		\$ 499.00
RSG-RL10N-B	MON,RED,CSA,O2		\$ 299.00
RSG-RL10N-C	MON,RED,CSA,H2S		\$ 299.00
RSG-RL10N-D	MON,RED,CSA,CO		\$ 299.00
RSG-RL10N-E1	MON,RED,CSA,HSL		\$ 350.00
RSG-RL10N-F	MON,RED,CSA,SO2		\$ 399.00
RSG-RL10N-G	MON,RED,CSA,CL2		\$ 399.00
RSG-RL10N-H	MON,RED,CSA,NO2		\$ 399.00
RSG-RL10N-I	MON,RED,CSA,CLO2		\$ 499.00
RSG-RL10N-J	MON,RED,CSA,NH3		\$ 399.00
RSG-RL10N-K	MON,RED,CSA,HCN		\$ 399.00
RSG-RL10N-L	MON,RED,CSA,O3		\$ 499.00
RSG-RL10N-M	MON,RED,CSA,COH		\$ 350.00
RSG-RL10N-N	MON,RED,CSA,NO		\$ 399.00
RSG-RL10N-U	MON,RED,CSA,PH3		\$ 499.00





# 2019 PRICE LIST

---

3M SCOTT FIRE & SAFETY

Effective February 1st 2019  
Prices are subject to change without notice.

Rev. A

# 3M SCOTT

## AIR SUPPLIED RESPIRATORS

<b>■ Firefighting Self-Contained Breathing Apparatus</b>	
NFPA 2013 Air-Pak SCBA Configurator.....	3
NFPA 2013 Air-Pak SCBA Upgrade Configurator.....	4
EZ-Scape Integrated Self Rescue Belts.....	5
<b>■ Non-Fire SCBA</b>	
Air-Pak 75i SCBA.....	8
ISCBA SCBA.....	9- 11
ACSi SCBA.....	13 - 15
<b>■ SCBA Accessories</b>	
Cylinders and Valves.....	16
SCBA Accessories.....	18
Cylinder Accessories.....	18
<b>■ Supplied Airline Respirators</b>	
Ska-Pak AT Respirator Assemblies.....	19 - 21
Ska-Pak Plus Respirator Assemblies.....	22 - 24
Ska-Pak Respirator Assemblies.....	25 - 27
E-Z Airline Respirator Assemblies & Hoses.....	28 - 31
<b>■ Portable Air Sources</b>	
RIT-Pak Fast Attack Emergency Air Supply.....	32
RIT-Pak III Emergency Air Supply.....	33
Mobile Air Cart.....	34
TRC-1 Air Cart.....	34
<b>■ Escape Respirators</b>	
ELSA Emergency Escape Breathing Device.....	35

## ACCOUNTABILITY

<b>■ PASS Devices</b>	
Pak-Tracker Firefighter Locator.....	36
<b>■ Software Solutions</b>	
Monitor/Monitor Pro.....	37
Service and Asset Management (SAM).....	38
<b>■ Thermal Imaging Cameras</b>	
X380 Camera and Accessories.....	39
X190 Camera and Accessories.....	41
V320 Camera and Accessories.....	42
Scott Sight.....	43
Scott Sight Pro Package.....	44
<b>■ Communications</b>	
EPIC 3 Communications System.....	45

## AIR PURIFYING RESPIRATORS

<b>■ Full Facepiece Respirators</b>	
AV-3000 HT Facepiece.....	48 - 50
AV-3000 Facepiece with SureSeal.....	51 - 54
AV-2000 Facepiece.....	55 - 57
Weld-O-Vista Facepiece.....	58 - 60
FRR First Responder Respirator.....	61
M110 CBRN Dual Facepiece.....	62
M120 CBRN Facepiece.....	63
<b>■ Cartridges, Canisters and Filters</b>	
Facepiece Adapters.....	64
742 Cartridges.....	65
40MM Cartridges & Canisters.....	66
<b>■ Escape Respirators</b>	
Speed-Evac Respirator.....	67
<b>■ Powered Air Purifying Respirators</b>	
C420 PAPR Parts & Accessories.....	68 - 69
<b>■ Fit Testing Kits and Accessories</b>	
Bitrex Qualitative Fit Test Kit.....	70

## COMPRESSORS

<b>■ Compressor Systems</b>	
HushAir Connect 7500 & RevolveAir Connect.....	71
<b>■ Charge Stations</b>	
RevolveAir Charge Stations.....	72
<b>■ Compressors</b>	
SimpleAir & HushAir Compressors.....	73
<b>■ High Pressure Storage Options</b>	
ASME & UN Cylinders.....	74

This price list is intended for use only by 3M Scott Fire & Safety Authorized Distributors and their personnel and supersedes all previous price lists. Prices are subject to change without notice. 3M Scott Fire & Safety Terms and Conditions are applicable to this document. Should a copy of the Terms and Conditions be needed, they can be obtained by contacting 3M Scott Fire & Safety directly. © 2019 3M and 3M Scott Fire & Safety. 3M and the 3M Scott Fire & Safety Logo are marks and/or registered marks. All other trademarks are the property of their respective owners. Unauthorized use is strictly prohibited.



## NFPA AIR-PAK SCBA

AIR-PAK X3 PRO, AIR-PAK X3, AIR-PAK 75, AIR-PAK WIREFRAME

BUILT-TO SPECIFICATION CONFIGURATOR  
NFPA 1981/1982, 2013 EDITION

SCBA Model ①	List Price	Harness	List Price	Pressure (psig)	List Price	SCBA Belt Type (select one number from both columns)			List Price	Regulator Hose	List Price	EBSS	List Price	Wireframe & Air-Pak 75 SCBA		Air-Pak X3 Pro SCBA		List Price	Case ④	List Price	Packaging ⑤ ⑥	List Price	
						Belt Type ②	List Price	Escape Rope / Anchor / ③ ⑦ Descender						List Price	Airline Option ⑧	List Price	Spare Harness ⑨						List Price
1 Wireframe	\$4,070	1 Standard	N/C	2 2216	\$440	0 Standard	N/C	2 None (No FFRS)	N/C	1 Standard Hose	N/C	0 None	N/C	0 None	N/C	0 None	N/C	1 Gauge & HUD Only ⑩	\$1,470	0 None	N/C	1 1 SCBA per box	N/C
2 Air-Pak 75	\$4,070	2 Spring clips	N/C	4 4500	\$355	A EZ-Scape I, One-Size	\$590	A 50' webbing / Crosby hook / Fire AL2 descender	\$400	2 Quick Connect Hose	\$300	2 Dual	\$745	1 Hansen	\$347	1 Yes (EBSS)	\$850	3 Pak-Tracker	\$2,570	1 Hard Plastic	\$155	2 2 SCBA per box	N/C
3 Air-Pak X3 with CGA	\$4,620			5 5500	\$740	B EZ-Scape II, small	\$800	E 50' T-Safe rope / Crosby hook / F4 descender	\$560					2 Schrader	\$347	2 Yes	\$700	4 SEMS II ⑪	\$2,995	2 Soft Canvas	\$155	1 1 SCBA per Box (black)	N/C
4 Air-Pak X3 with Snap-Change	\$4,620					C EZ-Scape II, medium	\$800	L 50' T-Safe rope / Lightning GT hook / F4 descender	\$585					3 Hansen HK	\$347	3 Yes (EZ-Scape Pro & EBSS)	\$950	A SEMS II Pro ⑫	\$3,065			2 2 SCBA per Box (black)	N/C
5 Wireframe less pads	\$4,070					D EZ-Scape II, large	\$800							4 Foster	\$347	4 Yes (EZ-Scape Pro)	\$800	H SEMS II Pro ⑬ (Hazmat)	\$3,065				
6 Air-Pak X3 Pro with CGA	\$4,900					N EZ-Scape Pro, Fixed	\$500									5 No	N/C						
7 Air-Pak X3 Pro with Snap-Change	\$4,900					P EZ-Scape Pro, Jettison	\$550																
						S EZ-Scape Pro, Fixed (AP75)	\$500																

**1. Part Number:**

Select a one or two digit number per box from the chart above that corresponds to your choice

X3	X	X	X	X	X	X	X	X	X	X	X	X	X
----	---	---	---	---	---	---	---	---	---	---	---	---	---

- ① Air-Pak Wireframe requires the use of the spring clip harness.
- ② EZ-Scape I/II available on Air-Pak Wireframe and Air-Pak 75 SCBA only; EZ-Scape Pro available on Air-Pak 75, Air-Pak X3 and Air-Pak X3 Pro as either a belt-only configuration or full escape system.
- ③ Lightning GT hook option only available on EZ-Scape Pro.
- ④ Airline option not available on Air-Pak X3 Pro and Air-Pak X3 SCBA, or when dual EBSS is installed on Air-Pak 75 and Wireframe SCBA.
- ⑤ Spare harness option available only with Air-Pak X3 Pro SCBA; When selecting Air-Pak Wireframe, Air-Pak 75, or Air-Pak X3, you must select option 0 for spare harness.
- ⑥ SEMS II and Gauge & HUD Only options available only with Air-Pak Wireframe, Air-Pak 75, and Air-Pak X3 SCBA.
- ⑦ SEMS II Pro option available only with Air-Pak X3 Pro SCBA.
- ⑧ SEMS II Pro Hazmat option (motion sensor disabled) available only with Air-Pak X3 Pro SCBA; Does not comply with the requirements of NFPA 1982, 2013 Edition.
- ⑨ When ordering a case (soft or hard plastic) with an Air-Pak Wireframe, Air-Pak 75, or Air-Pak X3 SCBA, you must choose one per box; Case option must be ordered separately with Air-Pak X3 Pro SCBA.
- ⑩ When selecting packaging for an Air-Pak Wireframe, Air-Pak 75, or Air-Pak X3 SCBA, you must select option 1 or 2; When selecting packaging for an Air-Pak X3 Pro SCBA, you must select option 3 or 4.
- ⑪ Air-Pak X3 Pro may only be packaged 1 SCBA per box when configured with a spare harness kit or EZ-Scape Pro with Escape Rope (full bailout system).

**2. Price:**

Select the price that corresponds to the number selected above

X3	\$X	\$X	\$X	\$X	\$X	\$X	\$X	\$X	\$X	\$X	\$X	\$X	\$X
----	-----	-----	-----	-----	-----	-----	-----	-----	-----	-----	-----	-----	-----

Example

**Current model is:**  
Air-Pak X3 Pro, Parachute Buckles, 5500psig, Standard Waist Belt, E-Z Flo+ Regulator with Quick Connect Hose, Dual EBSS, SEMS II Pro, Shipped (1) per Box (black)

X3	7	1	5	0	2	2	2	0	5	A	0	3	
	\$4,900	\$0	\$740	\$0	\$0	\$300	\$745	\$0	\$0	\$3,065	\$0	\$0	

**Total:** Add up all costs  
**\$9,750**

# 3M SCOTT

## AIR-PAK SCBA UPGRADE

BUILT-TO SPECIFICATION CONFIGURATOR  
NFPA 1981, 2013 EDITION

From the columns below, please choose the configuration of your current Air-Pak SCBA when configuring your upgrade kit				From the columns below, please choose the configuration to which you wish to upgrade your Air-Pak SCBA when configuring your upgrade kit							
Current Certification <small>Price includes a new regulator</small>	List Price	*SCBA Style	List Price	Pressure Rating (psig)	List Price	Regulator Hose	List Price	Console / Gauge <small>Price includes the HUD for all configurations</small>	List Price	Dual EBSS	List Price
1 NFPA 1981 - 2002	\$600	1 Wireframe SCBA	\$525	2 2216	\$0	1 Standard Hose	\$0	1 Gauge & HUD Only	\$1,470	0 None	\$0
2 NFPA 1981 - 2002 (CBRN)	\$600	2 Air-Pak 50 SCBA	\$525	4 4500	\$0	2 Quick Disconnect Hose	\$65	3 PASS w/Pak-Tracker	\$2,570	1 Wireframe SCBA	\$0
3 NFPA 1981 - 2007 (CBRN)	\$200	3 Air-Pak 75 SCBA - w/o Adjustable Seats	\$525	5 5500	\$0			4 PASS w/SEMS II	\$2,995	2 Air-Pak 50 / Air-Pak 75 SCBA	\$0
		4 Air-Pak 75 SCBA - w/ Adjustable Seats ①	\$0							3 Air-Pak NxG2 / Air-Pak NxG7 SCBA	\$0
		5 Air-Pak NxG2 SCBA	\$650							4 Air-Pak NxG2 SCBA - Reducer P/N 200060 or 200061	\$100
		6 Air-Pak NxG7 SCBA - w/o Adjustable Seats	\$650								
		7 Air-Pak NxG7 SCBA - w/ Adjustable Seats ②	\$0								

**1. Part Number:**

Select a one number per box from the chart above that corresponds to your choice

13UG	X	X	X	X	X	X
------	---	---	---	---	---	---

- ① For those customers currently using Air-Pak 75 SCBA with the adjustable seat pressure reducer (part number 200925-01, 200925-02, or 200925-03), please select option 4.
- ② For those customers currently using Air-Pak NxG7 SCBA with the adjustable seat pressure reducer (part number 200926-01, 200926-02, or 200926-03), please select option 7.



Non-Adjustable Seats



Adjustable Seats

**2. Price:**

Select the price that corresponds to the number selected above

13UG	\$X	\$X	\$X	\$X	\$X	\$X
------	-----	-----	-----	-----	-----	-----



Please select the option above that reflects the current configuration of your Air-Pak SCBA. If you do not currently have Dual EBSS installed and would like to add it as part of your upgraded Air-Pak SCBA, please select from the part numbers below. (Must Order Separately)

Part Number	Dual EBSS Retrofit	Price
200170-24	NxG2/NxG7	\$910.00
200170-26	Wireframe	\$910.00
200170-29	AP50/AP75	\$910.00
*200170-34	NxG2/NxG7 with FFSR	\$870.00
*200170-36	Wireframe with FFSR	\$870.00
*200170-39	AP50/AP75 with FFSR	\$870.00

\* FFSR = EZ-Scape Integrated Self-Rescue Belt

**Example**

**Current model is:**  
NFPA 1981, 2007 (CBRN)  
Air-Pak 75 SCBA with non-Adjustable Seat pressure reducer.

**Upgraded model is:**  
NFPA 1981, 2013 (CBRN)  
Air-Pak 75 SCBA with Adjustable Seat pressure reducer (5500 psig rating); with quick disconnect low pressure hose; with integrated PASS w/ Pak-Tracker;

13UG	3	3	5	2	3	3	Total: Add up all costs <b>\$3,360</b>
	\$200	\$525	\$0	\$65	\$2,570	\$0	

Upgrading an Air-Pak SCBA to NFPA 1981, 2013 Edition requires the use of the AV-3000 HT facepiece in order to meet the requirements for voice intelligibility, high heat & flame resistance and radiant heat resistance

Part Number	Facepiece	Price
201215-21	AV-3000 HT, 4-Strap (S)	\$385.00
201215-22	AV-3000 HT, 4-Strap (M)	\$385.00
201215-23	AV-3000 HT, 4-Strap (L)	\$385.00
*201215-27	AV-3000 HT, 4-Strap (S)	\$412.00
*201215-28	AV-3000 HT, 4-Strap (M)	\$412.00
*201215-29	AV-3000 HT, 4-Strap (L)	\$412.00

\* Includes right side communication bracket (installed)

This price configurator is a guide to upgrade legacy Air-Pak SCBA to the current NFPA 1981, 2013 Edition Standard

# EZ-SCAPE

## INTEGRATED SELF-RESCUE BELTS

### EZ-Scape Pro Integrated Self-Rescue Belt

<i>Air-Pak SCBA Backframe</i>				<i>List Price</i>
<i>X3 Pro</i>	<i>X3</i>	<i>AP75</i>	<i>Description</i>	
<i>Part Number</i>	<i>Part number</i>	<i>Part number</i>	<i>Description</i>	<i>List Price</i>
201668-01	201096-01	N/A	EZ-Scape Pro (Jettison), Belt-Only	\$850.00
201668-11	201096-11	N/A	EZ-Scape Pro (Jettison), One Size Fits Most, 50' T-Safe Rope, Crosby Hook, F4 Descender	\$1,500.00
201668-12	201096-12	N/A	EZ-Scape Pro (Jettison), One Size Fits Most, 50' T-Safe Rope, Lightning GT Hook, F4 Descender	\$1,550.00
201668-21	201096-21	201408-01	EZ-Scape Pro (Fixed), Belt-Only	\$850.00
201668-31	201096-31	201408-11	EZ-Scape Pro (Fixed), One Size Fits Most, 50' T-Safe Rope, Crosby Hook, F4 Descender	\$1,500.00
201668-32	201096-32	201408-12	EZ-Scape Pro (Fixed), One Size Fits Most, 50' T-Safe Rope, Lightning GT Hook, F4 Descender	\$1,550.00

### Accessories for EZ-Scape Pro Integrated Self-Rescue Belt

*200904-01	Re-packing Jig for 50' rope	\$45.40
31003385	Multi-Use Ladder Strap	\$177.00

### EZ-Scape I Integrated Self-Rescue Belt

<i>Air-Pak SCBA Backframe</i>				<i>List Price</i>
<i>AP75</i>	<i>Wireframe</i>			
<i>Part number</i>	<i>Part number</i>	<i>Description</i>		<i>List Price</i>
200861-101	200861-201	EZ-Scape I, One Size Fits All, 50' Kevlar Webbing, Crosby Hook, AL Descent Device		\$1,400.00

### EZ-Scape II Integrated Self-Rescue Belt

<i>Air-Pak SCBA Backframe</i>				<i>List Price</i>
<i>AP75</i>	<i>Wireframe</i>			
<i>Part number</i>	<i>Part number</i>	<i>Description</i>		<i>List Price</i>
200918-111	200918-211	EZ-Scape II, Small, 50' T-Safe Rope, Crosby Hook, F4 Descender		\$1,750.00
200918-121	200918-221	EZ-Scape II, Medium, 50' T-Safe Rope, Crosby Hook, F4 Descender		\$1,750.00
200918-131	200918-231	EZ-Scape II, Large, 50' T-Safe Rope, Crosby Hook, F4 Descender		\$1,750.00

### Accessories for EZ-Scape II Integrated Self-Rescue Belt

*200904-01	Re-packing Jig for 50' rope	\$45.40
200859-E	EZ-Scape Waist Belt Extension, 12"	\$97.00

\* A single jig can be used to re-pack many EZ-Scape belts

# 3M SCOTT

## AIR-PAK 4.5 SCBA

(NIOSH 42 CFR CERTIFIED)



### Air-Pak 4.5

**Padded Harness • Voice Amplifier • AV-3000 Facepiece • E-Z Flo + Regulator ( includes cylinder )**

Part Number	Duration	Price
804861-3710	30 Minute	\$8,810.00
804861-3810	45 Minute	\$9,180.00

# NOTES

---

# 3M SCOTT

## AIR-PAK 75i SCBA

BUILT-TO SPECIFICATION CONFIGURATOR  
NIOSH 42 CFR CERTIFIED



SCBA Model	List Price	Harness	List Price	Pressure (psig)	List Price	Cylinder ①	List Price	Regulator ③	List Price	EBSS	List Price	Airline Options ②	List Price	Facepiece ④	List Price	Console	List Price	Case	List Price	Packaging	List Price	
4	Air-Pak 75i SCBA	\$2,483	5 Kevlar®/Parachute Buckle	N/C	2 2216	N/C	00 None	N/C	1 E-Z Flo with Vibralert	N/C	0 None	N/C	0 None	N/C	0 None	N/C	1 Gauge	N/C	0 None	N/C	1 One Per Box	N/C
				4 4500	\$355			2 E-Z Flo with Vibralert Quick Connect	\$180	2 Dual	\$689	1 Hansen	\$347	1 AV-2000, Kevlar® (CS)	\$377	4 Gauge & HUD	\$1,470	1 Hard Case	\$155			
				5 2216 with RIC/UAC	\$330			5 E-Z Flo with Vibralert / HUD (Industrial)	\$465			2 Schrader	\$347	3 AV-3000 SureSeal Kevlar® (M)	\$384			2 Soft Case	\$155			
				7 4500 with RIC/UAC	\$675			6 E-Z Flo with Vibralert Quick Connect / HUD (Industrial)	\$815			4 Hansen HK Plug	\$347									
				8 5500	\$740							5 Hansen HK Socket	\$347									
				9 5500 with RIC/UAC	\$1,060																	

**1. Part Number:**

Select a one or two digit number per box from the chart above that corresponds to your choice

APi	4	5	X	00	X	X	X	X	1	X	1
-----	---	---	---	----	---	---	---	---	---	---	---

- ① Order cylinders separately.
- ② Airline options not available when dual EBSS is installed on Air-Pak 75i SCBA.
- ③ When selecting an E-Z Flo with HUD, you must select Gauge & HUD for the Console.
- ④ If you prefer an alternate Facepiece style, head harness, or size, choose "none" and order an approved Facepiece as a separate line item (see pages 48 - 57 for selection).

**2. Price:**

Select the price that corresponds to the number selected above

APi	\$X	\$X	\$X	\$0	\$X	\$X	\$X	\$X	\$X	\$X	\$X
-----	-----	-----	-----	-----	-----	-----	-----	-----	-----	-----	-----

**Example**

**Air-Pak 75i SCBA Model;**  
Kevlar®/Parachute Buckle; for 4500 psig cylinder, no cylinder, with E-Z Flo regulator with Vibralert, no EBSS, no airline, no facepiece, standard gauge, no case, shipped one per box.

APi	4	5	4	00	1	0	0	0	1	0	1	Total: Add up all costs
	\$2,483	\$0	\$355	\$0	\$0	\$0	\$0	\$0	\$0	\$0	\$0	

In this example, order (4500 psig) Cylinder, Facepiece and Case separately

This price configurator is a guide to 3M Scott Air-Pak 75i SCBA part numbers.



## ISCBA SCBA

BUILT-TO SPECIFICATION CONFIGURATOR  
NIOSH 42 CFR CERTIFIED

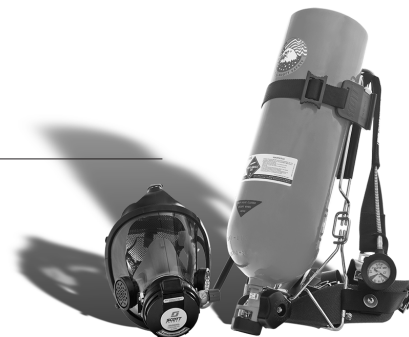

SCBA Model	List Price	Harness	List Price	Pressure (psig)	List Price	Cylinder	List Price	Regulator	List Price	Manifold ①	List Price	Airline Options	List Price	Facepiece ②	List Price	Console	List Price	Case	List Price	Packaging	List Price
1 ISCBA	\$1,293	1 Nylon/Polymer Buckle	N/C	2 2216	N/C	00 None	N/C	3 E-Z Flo standard	N/C	1 Single	N/C	0 None	N/C	0 None	N/C	1 Gauge	N/C	0 None	N/C	1 One Per Box	N/C
		4 Kevlar/Metal Buckle	\$145	4 4500	\$355	01 2216psi Aluminum, 30 min.	\$730	4 E-Z Flo Modulair	\$75	2 Dual	\$134	1 Hansen	\$347	1 AV-2000, Kevlar® (CS)	\$377			1 Hard Case	\$155		
						02 2216psi Carbon, 30 min.	\$1,266					2 Schrader	\$347	3 AV-3000 SureSeal, Kevlar® (M)	\$384			2 Soft Case	\$155		
						04 4500psi Carbon, 30 min.	\$1,304					3 Cejn	\$347	4 AV-2000 Poly (CS)	\$278						
						05 4500psi Carbon, 45 min.	\$1,555					4 Hansen HK Plug	\$347	6 AV-3000 SureSeal Poly (M)	\$288						
						06 4500psi Carbon, 60 min.	\$1,732					5 Hansen HK Socket	\$347	7 AV-2000 Rubber (CS)	\$275						
						<b>Drained</b>							9 AV-3000 SureSeal Rubber (M)	\$282							
						AA 2216psi Aluminum, 30 min.	\$730														
						BB 2216psi Carbon, 30 min.	\$1,266														
						DD 4500psi Carbon, 30 min.	\$1,304														
						EE 4500psi Carbon, 45 min.	\$1,555														
						FF 4500psi Carbon, 60 min.	\$1,732														

**1. Part Number:**

Select a one or two digit number per box from the chart above that corresponds to your choice

IND	1	X	X	XX	X	X	X	X	X	1	X	1
-----	---	---	---	----	---	---	---	---	---	---	---	---

① Airline options require a Dual Manifold.

② If you prefer an alternate Facepiece style, head harness, or size, choose "none" and order an approved Facepiece as a separate line item (see pages 48 - 57 for selection).

**2. Price:**

Select the price that corresponds to the number selected above

IND	\$X	\$X	\$X	\$X	\$X	\$X	\$X	\$X	\$X	\$X	\$X	\$X
-----	-----	-----	-----	-----	-----	-----	-----	-----	-----	-----	-----	-----

**Example**  
ISCBA SCBA Model: Kevlar/Metal Buckle; for 4500 psig cylinder, no cylinder, with E-Z Flo regulator, Single Manifold, no airline, no facepiece, standard gauge, no case, shipped one per box.

IND	1	4	4	00	3	1	0	0	1	0	1	Total: Add up all costs <b>\$1,793</b>
	\$1,293	\$145	\$355	\$0	\$0	\$0	\$0	\$0	\$0	\$0	\$0	

In this example, order (4500 psig) Cylinder, Facepiece and Case separately

This price configurator is a guide to 3M Scott ISCBA SCBA part numbers.

# 3M SCOTT

## ISCBA Respirator

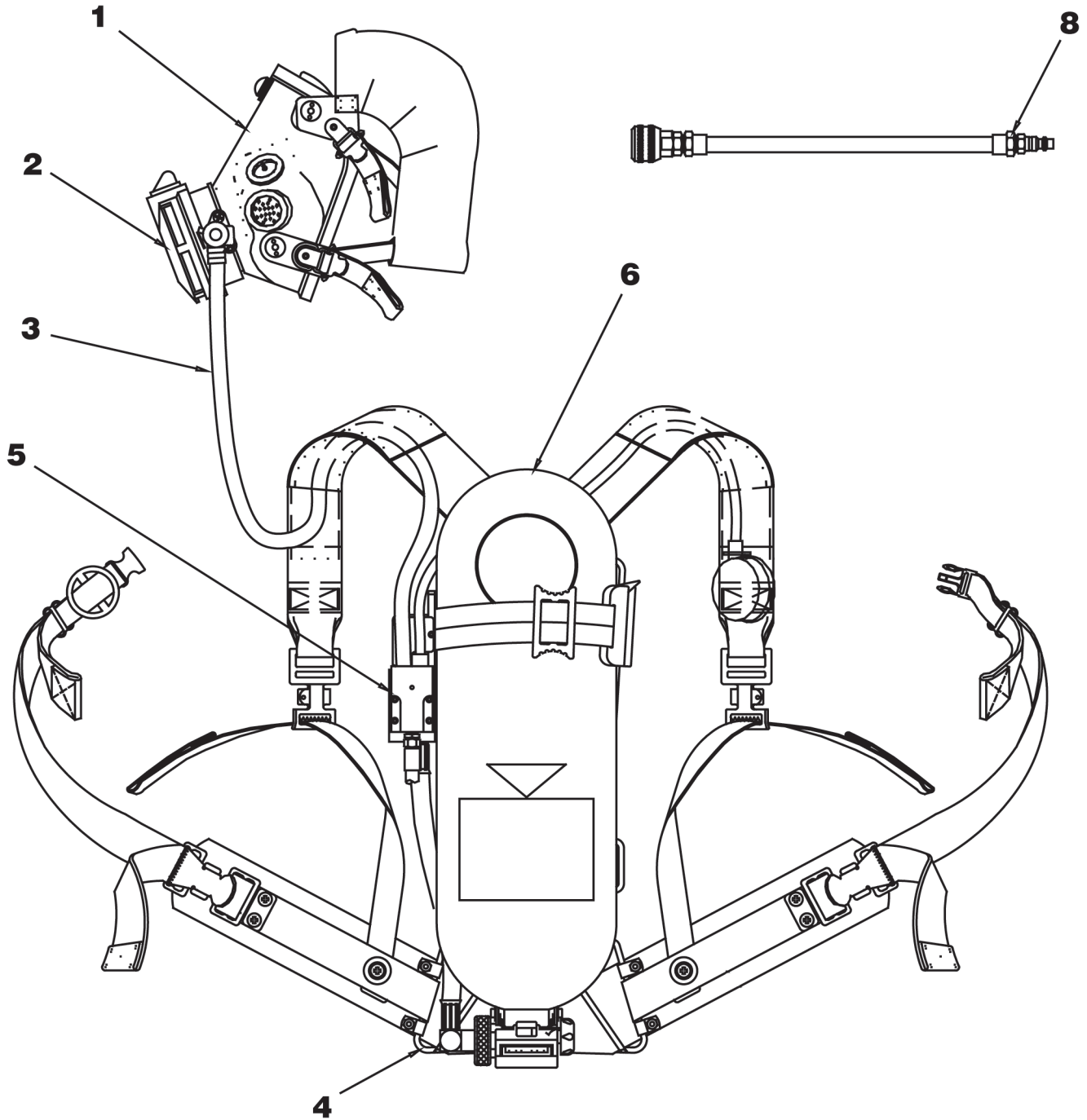

**Industrial SCBA Parts & Accessories**

Item Number	Description	Pieces Per Pkg	Part Number	Price
1	<b>FACEPIECES</b>			
1a	AV-3000 HT Facepiece	See Page 48		
1b	AV-3000 Facepiece with SureSeal	See Page 51		
1c	AV-2000 Facepiece	See Page 55		
2	<b>REGULATOR</b>			
2a	E-Z Flo	1	804441-04	\$570.00
2b	E-Z Flo with Modulair Quick Connect	1	804441-05	\$590.00
3	<b>Quick Connect Low Pressure Hose Assembly</b>	1	804678-01	\$179.00
4	<b>BACKFRAME AND HARNESES</b>			
4a	Kevlar with Metal Buckles	1	804621-02	\$820.00
4b	Nylon with Plastic Buckles	1	804621-03	\$690.00
5	<b>PRESSURE REDUCERS</b>			
5a	2216 psig, Single Port	1	804619-01	\$1,290.00
5b	2216 psig, Dual Port	1	804619-02	\$1,360.00
5e	4500 psig, Single Port	1	804642-01	\$1,420.00
5f	4500 psig, Dual Port	1	804642-02	\$1,510.00
6	<b>CYLINDER AND VALVE ASSEMBLIES</b>			
6a	Aluminum, 30-Minute, 2216 psig	1	804101-01	\$730.00
6b	Carbon, 30-Minute, 2216 psig	1	804840-01	\$1,266.00
6c	Carbon, 30-Minute, 4500 psig	1	804721-01	\$1,304.00
6d	Carbon, 45-Minute, 4500 psig	1	804722-01	\$1,555.00
6e	Carbon, 60-Minute, 4500 psig	1	804723-01	\$1,732.00
7	<b>AIRLINE HOSE AND FITTINGS (Not shown)</b>			
7a	Airline Accessory Hose, Hansen Fitting	1	27537-01	\$356.00
7b	Airline Accessory Hose, Schrader Fitting	1	27537-02	\$356.00
7c	Airline Accessory Hose, Hansen HK Fitting	1	27537-03	\$356.00
8	<b>SUPPLY HOSES</b>	See Page 30		
9	<b>COMMUNICATIONS</b>	See Page 45		
Not shown	Hard Carrying Case, SCBA	1	804497-01	\$366.00
Not shown	Soft Carrying Case, SCBA	1	10009324	\$176.00

# 3M SCOTT

## NOTES

---

## ACSi SCBA

BUILT-TO SPECIFICATION CONFIGURATOR  
NIOSH 42 CFR CERTIFIED



SCBA Model	List Price	Harness	List Price	Pressure (psig)	List Price	Cylinder ①	List Price	Regulator	List Price	Manifold	List Price	Extended Duration Airline	List Price	Facepiece ②	List Price	Console	List Price	Case	List Price	Packaging	List Price
3 ACSI SCBA	\$959	A ACSI Standard	N/C	2 2216	N/C	00 None	N/C	3 E-Z Flo standard	N/C	0 Standard	N/C	0 None	N/C	0 None	N/C	1 Gauge	N/C	0 None	N/C	1 One Per Box	N/C
				4 4500	\$355	01 2216psi Aluminum, 30 min.	\$730	4 E-Z Flo Modulair	\$75			1 Hansen	\$347	1 AV-2000, Kevlar® (CS)	\$377			1 Hard Case	\$155		
						02 2216psi Carbon, 30 min.	\$1,266					2 Schrader	\$347	3 AV-3000 SureSeal Kevlar® (M)	\$384			2 Soft Case	\$155		
						04 4500psi Carbon, 30 min	\$1,304					3 Hansen HK Plug	\$347	4 AV-2000 Poly (CS)	\$278						
						05 4500psi Carbon, 45 min	\$1,555					4 Cejn	\$347	6 AV-3000 SureSeal Poly (M)	\$288						
						06 4500psi Carbon, 60 min	\$1,732					5 Hansen HK Socket	\$347	7 AV-2000 Rubber (CS)	\$275						
						<b>Drained</b>								9 AV-3000 SureSeal Rubber (M)	\$282						
						AA 2216psi Aluminum, 30 min.	\$730														
						BB 2216psi Carbon, 30 min.	\$1,266														
						DD 4500psi Carbon, 30 min	\$1,304														
						EE 4500psi Carbon, 45 min	\$1,555														
						FF 4500psi Carbon, 60 min	\$1,732														

**1. Part Number:**

Select a one or two digit number per box from the chart above that corresponds to your choice

ACS	3	A	X	XX	X	0	X	X	1	X	1
-----	---	---	---	----	---	---	---	---	---	---	---

① Selecting a cylinder with ACSI will ship a cylinder with the unique ACS designated valve assembly.

② If you prefer an alternate Facepiece style, head harness, or size, choose "none" and order an approved Facepiece as a separate line item (see pages 48 - 57 for selection).

**2. Price:**

Select the price that corresponds to the number selected above

ACS	\$X	\$X	\$X	\$X	\$X	\$X	\$X	\$X	\$X	\$X	\$X
-----	-----	-----	-----	-----	-----	-----	-----	-----	-----	-----	-----

Example

**ACSi SCBA Model:**  
Standard Harness, for 2216 psig cylinder, no cylinder, with E-Z Flo regulator, Standard Manifold, no airline, no facepiece, standard gauge, no case, shipped one per box.

ACS	3	A	2	00	3	0	0	0	1	0	1
	\$959	\$0	\$0	\$0	\$0	\$0	\$0	\$0	\$0	\$0	\$0

Total: Add up all costs

\$959

In this example, order (2216 psig) Cylinder, Facepiece and Case separately

This price configurator is a guide to 3M Scott ACSI SCBA part numbers.

# 3M SCOTT

## ASCI Respirator

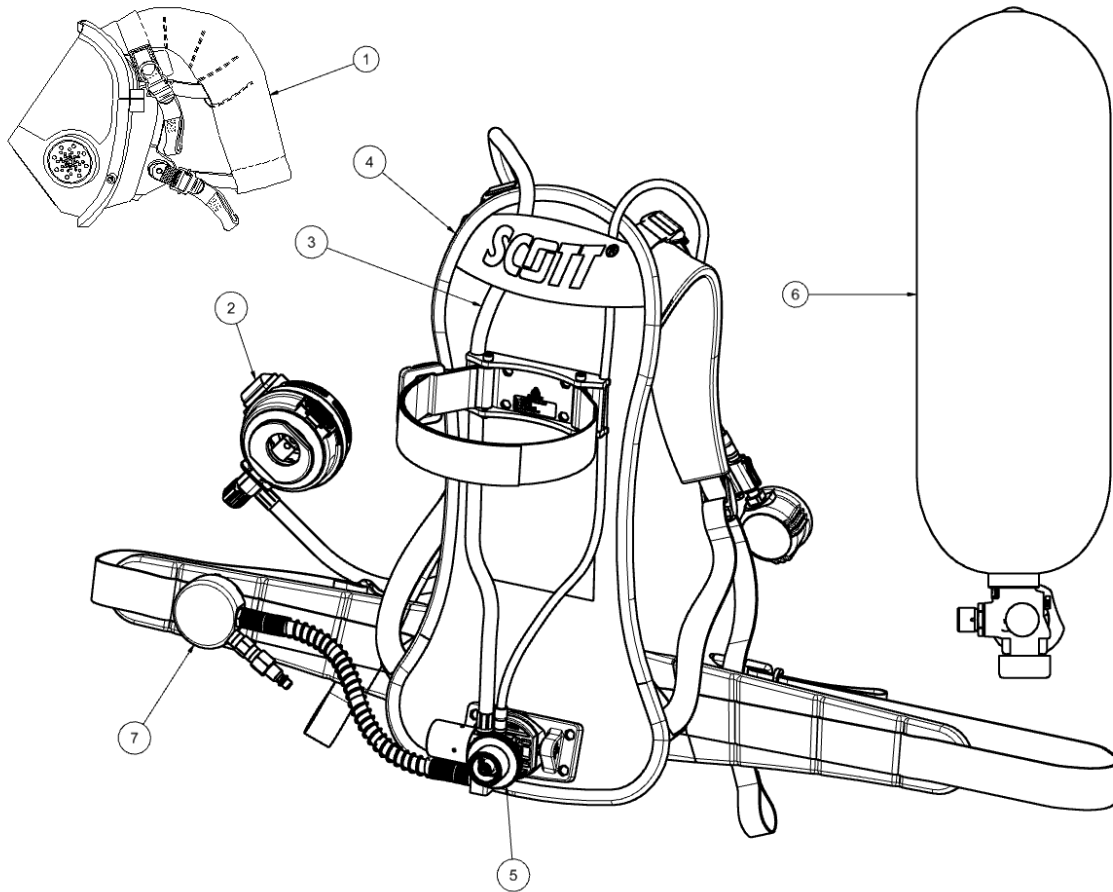

**ACSi SCBA Parts & Accessories**

Item Number	Description	Pieces Per Pkg	Part Number	Price
1	<b>FACEPIECES</b>			
1a	AV-3000 HT Facepiece	See Page 48		
1b	AV-3000 Facepiece with SureSeal	See Page 51		
1c	AV-2000 Facepiece	See Page 55		
2	<b>REGULATOR</b>			
2a	E-Z Flo Regulator	1	804441-06	\$570.00
2b	E-Z Flo with Modulair Quick Connect	1	804441-05	\$590.00
3	Quick Connect Low Pressure Hose Assembly	1	200867-01	\$181.00
4	<b>BACKFRAME AND HARNESSSES</b>			
4a	ACS (Advanced Carrying System) Standard Backframe/ Harness Assembly	1	200877-01	\$442.00
5	<b>PRESSURE REDUCERS</b>			
5a	2.2 Pressure Reducer Assembly	1	2019231	\$560.00
5b	4.5 Pressure Reducer Assembly	1	2019232	\$650.00
6	<b>ACS CYLINDER AND VALVE ASSEMBLIES (with ACS valve)</b>			
6a	Aluminum, 30-Minute, 2216 psig	1	200874-01	\$720.00
6b	Carbon, 30-Minute, 2216 psig	1	200873-01	\$1,250.00
6c	Carbon, 30-Minute, 4500 psig	1	200870-01	\$1,110.00
6d	Carbon, 45-Minute, 4500 psig	1	200871-01	\$1,520.00
6e	Carbon, 60-Minute, 4500 psig	1	200872-01	\$1,710.00
7	<b>Extended Duration Airline Assembly (Not shown)</b>			
7a	Airline Accessory Hose, Hansen Fitting	1	200879-01	\$473.00
7b	Airline Accessory Hose, Schrader Fitting	1	200879-02	\$473.00
7c	Airline Accessory Hose, Hansen HK Fitting	1	200879-03	\$473.00
7d	Airline Accessory Hose, CEJN Fitting	1	200879-05	\$473.00
8	<b>SUPPLY HOSES</b>	See Page 30		

# 3M SCOTT

## CYLINDER & VALVE

30, 45, 60 & 75 MINUTE ASSEMBLIES

### 2216 psig 30 Minute Cylinder & Valve Assemblies

Part Number	Aluminum	Carbon	30-Year	Cylinder Valve	Price
804101-01	●			●	\$730.00
804840-01		●		●	\$1,266.00
200131-01*		●		●	\$1,266.00
10010063**		●			\$1,090.00

### 4500 psig, 30 Minute Cylinder & Valve Assemblies

Part Number	Carbon	ST7	30-Year	Cylinder Valve	Price
804721-01	●			●	\$1,304.00
200128-01*	●			●	\$1,304.00
10009671**	●				\$1,010.00
804721-11	●	●		●	\$1,409.00
200128-11*	●	●		●	\$1,409.00
804721-35	●		●	●	\$1,576.00
200128-35*	●		●	●	\$1,576.00

### 4500 psig, 45 Minute Cylinder & Valve Assemblies

Part Number	Carbon	ST7	30-Year	Cylinder Valve	Price
804722-01	●			●	\$1,555.00
200129-01*	●			●	\$1,555.00
10009673**	●				\$1,320.00
804722-11	●	●		●	\$1,660.00
200129-11*	●	●		●	\$1,660.00
804722-35	●		●	●	\$1,952.00
200129-35*	●		●	●	\$1,952.00

### 4500 psig, 60 Minute Cylinder & Valve Assemblies

Part Number	Carbon	ST7	30-Year	Cylinder Valve	Price
804723-01	●			●	\$1,732.00
200130-01*	●			●	\$1,732.00
10009672**	●				\$1,550.00
804723-11	●	●		●	\$1,837.00
200130-11*	●	●		●	\$1,837.00
804723-35	●		●	●	\$2,329.00
200130-35*	●		●	●	\$2,329.00



**5500 psig, 30 Minute, Cylinder & Valve Assemblies**

Part Number	Carbon	ST7	30-Year	Cylinder Valve	Price
200930-01	●			●	\$1,451.00
200967-01*	●			●	\$1,451.00
31002299**	●				\$1,190.00

**5500 psig, 45 Minute, Cylinder & Valve Assemblies**

Part Number	Carbon	ST7	30-Year	Cylinder Valve	Price
200969-01	●			●	\$1,722.00
200970-01*	●			●	\$1,722.00
31002300**	●				\$1,470.00

**5500 psig, 60 Minute, Cylinder & Valve Assemblies**

Part Number	Carbon	ST7	30-Year	Cylinder Valve	Price
200972-01	●			●	\$1,911.00
200973-01*	●			●	\$1,911.00
31002301**	●				\$1,670.00

**5500 psig, 75 Minute, Cylinder & Valve Assemblies**

Part Number	Carbon	ST7	30-Year	Cylinder Valve	Price
200975-01	●			●	\$2,108.00
200976-01*	●			●	\$2,108.00
31002302**	●				\$1,880.00

**ACSi Cylinder & Valve Assemblies**

See Page 15

\* Snap-Change Valve Assembly

\*\* Standard Carbon Cylinder (less valve)

# 3M SCOTT

## Air-Pak (SCBA) Accessories

Part Number	Description	Price
805511-01*	Chest Strap	\$38.20
201612-01	Chest Strap, Lower (X3 Pro)	\$83.00
201612-02	Chest Strap, Upper (X3 Pro)	\$83.00
200112-01	Extended Duration Adapter Assy, Hansen	\$338.00
200112-02	Extended Duration Adapter Assy, Foster	\$338.00
200112-03	Extended Duration Adapter Assy, Hansen HK	\$338.00
200112-04	Extended Duration Adapter Assy, Schrader	\$338.00
200388-01**	Tool Adapter, Snap Change	\$660.00
803620-03***	Pass Thru Assembly, Hansen	\$405.00
803620-04***	Pass Thru Assembly, Schrader	\$405.00
805088-01	Waist Belt Extension (AP75/WF/X3)	\$43.30
201614-01	Waist Belt Extension (X3 Pro)	\$67.00

\* Recommended for use with the Air-Pak Wireframe, Air-Pak 75, and Air-Pak X3 SCBA

\*\* Accommodates 2.2, 4.5, and 5.5 Snap-Change Cylinders

\*\*\* For use with Dual EBSS in an encapsulated protective suit

## Cylinder Accessories

Part Number	Description	Price
200952-02	Cylinder Sleeve Kit, 30-min, 4500 psi	\$130.00
200952-03	Cylinder Sleeve Kit, 45-min, 4500 psi	\$130.00
200952-04	Cylinder Sleeve Kit, 60-min, 4500 psi	\$130.00
200952-05	Cylinder Sleeve Kit, 15-min, 4500 psi	\$112.00
200952-06	Cylinder Sleeve Kit, 30-min, 5500 psi	\$136.00
200952-07	Cylinder Sleeve Kit, 45-min, 5500 psi	\$136.00
200952-08	Cylinder Sleeve Kit, 60-min, 5500 psi	\$136.00
200952-09	Cylinder Sleeve Kit, 75-min, 5500 psi	\$136.00
200952-10	Cylinder Sleeve Kit, 30-min, 2216 psi	\$136.00
200688-S430	Cylinder Protective Cap, Valve End, 30-min, 4500 psi	\$33.60
200688-D430	Cylinder Protective Cap, Dome End, 30-min, 4500 psi	\$33.60
200688-S445	Cylinder Protective Cap, Valve End, 45-min, 4500 psi	\$33.60
200688-D445	Cylinder Protective Cap, Dome End, 45-min, 4500 psi	\$33.60
200689-01	Epoxy Pak (Epoxy for 8 caps, Mixing Nozzle, O&M)	\$60.00
31001465	Applicator Gun/Mixer	\$102.00

## SKA-PAK AT

### SUPPLIED AIR RESPIRATOR ASSEMBLIES



SAR Model	List Price	Entry/Egress	List Price	Pressure (psig)	List Price	Cylinder	List Price	Harness	List Price	Regulator	List Price	Airline	List Price	Facepiece ①	List Price	Case ②	List Price	Packaging	List Price
4 Ska-Pak AT SAR	\$1,324	2 Entry/Egress	N/C	2 2216	N/C	00 None	N/C	3 Nylon	\$179	3 E-Z Flo Vibralert	N/C	1 Hansen	\$113	0 None	N/C	0 None	N/C	1 One Per Box	N/C
				3 3000	N/C	01 2216/Aluminum/3min	\$503	4 Kevlar*	\$306	4 E-Z Flo Vibralert QC	\$175	2 Schrader	\$118	1 AV-2000, Kevlar® (CS)	\$377				
				4 4500	N/C	02 3000/Carbon/5min	\$625	5 FBH (Small)	\$560			3 Cejn	\$199	3 AV-3000 SureSeal, Kevlar® (M)	\$384				
						03 3000/Carbon/10min	\$708	6 FBH (Medium)	\$560			4 Hansen HK Plug	\$220	4 AV-2000 Poly (CS)	\$278				
						06 4500/Carbon/15min	\$839	7 FBH (Large)	\$560			5 Hansen HK Socket	\$220	6 AV-3000 SureSeal Poly (M)	\$288				
						Drained								7 AV-2000 Rubber (CS)	\$275				
						AA 2216/Aluminum/3min	\$503							9 AV-3000 SureSeal Rubber (M)	\$282				
						BB 3000/Carbon/5min	\$625												
						CC 3000/Carbon/10min	\$708												
						FF 4500/Carbon/15min	\$839												

**1. Part Number:**  
Select a one or two digit number per box from the chart above that corresponds to your choice

SAR	4	2	X	XX	0	X	X	X	X	X	1
-----	---	---	---	----	---	---	---	---	---	---	---

① If you prefer an alternate Facepiece style, head harness, or size, choose "none" and order an approved Facepiece as a separate line item (see pages 48 - 57 for selection).  
② Cases are not compatible with select Ska-Pak AT configurations and Ska-Pak AT with FBH styles. Please choose "none" for case option and order case separately as required noting that fit on all configurations cannot be guaranteed.

**2. Price:**  
Select the price that corresponds to the number selected above

SAR	\$X	\$X	\$X	\$X		\$X	\$X	\$X	\$X	\$X	\$X
-----	-----	-----	-----	-----	--	-----	-----	-----	-----	-----	-----

**Example**  
**SKA-PAK AT SAR Model:**  
For Entry/Egress, for 3000 psi Cylinder, with 3000 psig 10 min Carbon cylinder, Kevlar harness, with E-Z Flo Vibralert, Hansen airline, no case, shipped one per box.

SAR	4	2	3	03	0	4	3	1	0	0	1	Total: Add up all costs
	\$1,324	\$0	\$0	\$708	\$0	\$306	\$0	\$113	\$0	\$0	\$0	

In this example, order Facepiece and Case separately

This price configurator is a guide to 3M Scott Ska-Pak AT Supplied Air Respirator part numbers.

# 3M SCOTT

## Ska-Pak AT Respirator

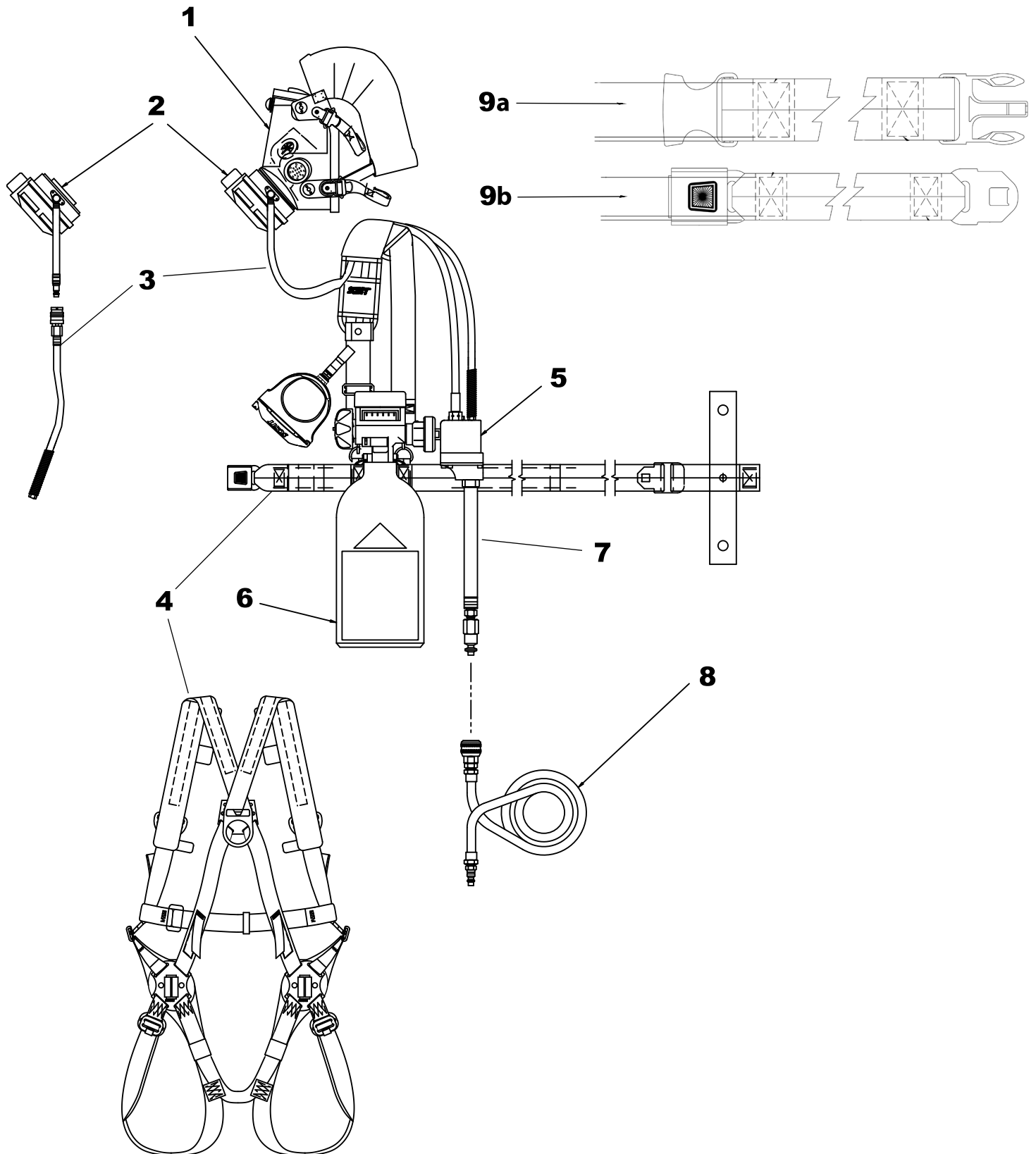

**Ska-Pak AT Respirator Parts & Accessories**

Item Number	Description	Pieces Per Pkg	Part Number	Price
1	<b>FACEPIECE</b>			
1a	AV-3000 HT Facepiece	See Page 48		
1b	AV-3000 Facepiece with SureSeal	See Page 51		
1c	AV-2000 Facepiece	See Page 55		
2	<b>REGULATOR</b>			
2a	E-Z Flo with Vibralert	1	804370-09	\$1,100.00
2b	E-Z Flo with Vibralert Quick Connect	1	804370-02	\$1,180.00
3	<b>Quick Connect Hose Assembly</b>	1	804694-05	\$212.00
4	<b>HARNESSES</b>			
4a	Nylon	1	804982-01	\$272.00
4b	Kevlar	1	804981-01	\$477.00
4c	Full Body Harness (Fall Protection) - Small	1	805061-02	\$760.00
4d	Full Body Harness (Fall Protection) - Medium	1	805061-03	\$760.00
4e	Full Body Harness (Fall Protection) - Large	1	805061-04	\$760.00
5	<b>PRESSURE REDUCERS</b>			
5a	2216/3000, Entry/Egress	1	200031-03	\$760.00
5b	4500 psig, Entry/Egress	1	200031-04	\$760.00
6	<b>CYLINDER AND VALVE ASSEMBLIES</b>			
6a	2216 psi, Aluminum, 3-minute	1	805031-01	\$520.00
6b	3000 psi, Carbon, 5-minute	1	805947-02	\$630.00
6c	3000 psi, Carbon, 10-minute	1	805948-02	\$710.00
6f	4500 psi, Carbon, 15-minute	1	200779-01	\$880.00
7	<b>AIRLINE HOSE AND FITTINGS</b>			
7a	Airline Hose with Hansen/Foster Fitting	1	804305-01	\$124.00
7b	Airline Hose with Schrader Fitting	1	804305-02	\$124.00
7c	Airline Hose with Hansen HK Fitting Plug	1	804305-03	\$223.00
8	<b>AIRLINE SUPPLY HOSES</b>	See Page 30		
9	<b>WAIST EXTENSION BELTS</b>			
9a	Kevlar Extension Belt, 1.5 Inches Wide	1	805088-01	\$43.30
9b	Nylon Extension Belt, 2 Inches Wide	1	805088-02	\$19.00
10	<b>ACCESSORIES (Not shown)</b>			
10a*	Ska-Pak Series Hard Case	1	803278-01	\$200.00

**NOTE:**

\* Cases are not compatible with select Ska-Pak AT and Ska-Pak AT with FBH

# 3M SCOTT

## SKA-PAK PLUS

### SUPPLIED AIR RESPIRATOR ASSEMBLIES



SAR Model	List Price	Entry/Egress ①	List Price	Pressure (psig) ②	List Price	Cylinder	List Price	Harness	List Price	Regulator	List Price	Airline	List Price	Facepiece ③	List Price	Case ④	List Price	Packaging	List Price
3 Ska-Pak Plus SAR	\$700	2 Entry/Egress	N/C	2 2216	N/C	00 None	N/C	3 Nylon	\$179	1 E-Z Flo	N/C	0 None	N/C	0 None	N/C	0 None		1 One Per Box	N/C
		3 Egress Only	N/C	3 3000	N/C	01 2216/Aluminum/5min	\$503	4 Kevlar*	\$306	2 E-Z Flo Modulair	\$75	1 Hansen	\$113	1 AV-2000, Kevlar® (CS)	\$377	1 Hard Case	\$200		
				4 4500	N/C	02 3000/Carbon/5min	\$625	5 FBH (Small)	\$560			2 Schrader	\$118	3 AV-3000 SureSeal, Kevlar® (M)	\$384				
				6 2216 FF	\$561	03 3000/Carbon/10min	\$708	6 FBH (Medium)	\$560			3 Cejn	\$199	4 AV-2000 Poly (CS)	\$278				
				7 3000 FF	\$561	06 4500/Carbon/15min	\$839	7 FBH (Large)	\$560			4 Hansen HK Plug	\$220	6 AV-3000 SureSeal Poly (M)	\$288				
				8 4500 FF	\$561	Drained						5 Hansen HK Socket	\$220	7 AV-2000 Rubber (CS)	\$275				
						AA 2216/Aluminum/5min	\$503							9 AV-3000 SureSeal Rubber (M)	\$282				
						BB 3000/Carbon/5min	\$625												
						CC 3000/Carbon/10min	\$708												
						FF 4500/Carbon/15min	\$839												

**1. Part Number:**

Select a one or two digit number per box from the chart above that corresponds to your choice

SAR	3	X	X	XX	0	X	X	X	X	X	1
-----	---	---	---	----	---	---	---	---	---	---	---

- ① Must select Entry/Egress to select an Airline option.
- ② FF refers to the Fast Fill system which utilizes a quick connect fitting on the cylinder valve to enable rapid charging of the cylinder.
- ③ If you prefer an alternate Facepiece style, head harness, or size, choose "none" and order an approved Facepiece as a separate line item (see pages 48 - 57 for selection).
- ④ Cases are not compatible with select FBH styles, if selecting a FBH, please choose "none" for case option.

**2. Price:**

Select the price that corresponds to the number selected above

SAR	\$X	\$X	\$X	\$X		\$X	\$X	\$X	\$X	\$X	\$X
-----	-----	-----	-----	-----	--	-----	-----	-----	-----	-----	-----

**Example**

**SKA-PAK Plus SAR Model:**  
For Entry/Egress, for 2216 psi Cylinder, with 2216 psig 5 min Aluminum cylinder, Kevlar harness, with E-Z Flo Regulator, Hansen airline, no facepiece, no case, shipped one per box.

SAR	3	2	2	01	0	4	1	1	0	0	1	Total: Add up all costs <b>\$1,622</b>
	\$700	\$0	\$0	\$503	\$0	\$306	\$0	\$113	\$0	\$0	\$0	

In this example, order Facepiece and Case separately

This price configurator is a guide to 3M Scott Ska-Pak Plus Supplied Air Respirator part numbers.

## Ska-Pak Plus Respirator

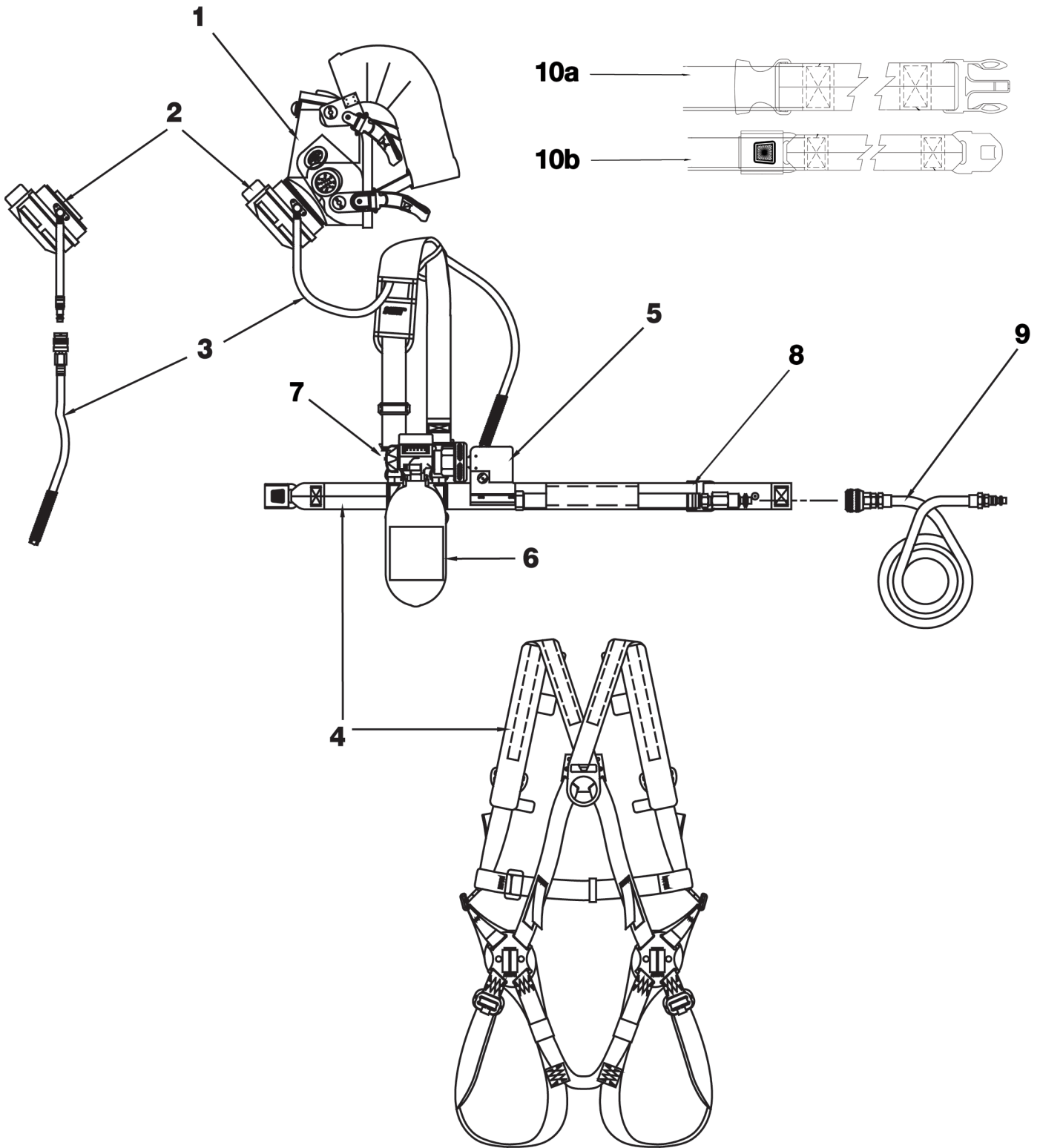

# 3M SCOTT

## Ska-Pak Plus Respirator Parts & Accessories

Item Number	Description	Pieces Per Pkg	Part Number	Price
<b>1</b>	<b>FACEPIECE</b>			
1a	AV-3000 HT Facepiece	See Page 48		
1b	AV-3000 Facepiece with SureSeal	See Page 51		
1c	AV-2000 Facepiece	See Page 55		
<b>2</b>	<b>REGULATOR</b>			
2a	E-Z Flo	1	804221-01	\$820.00
2b	E-Z Flo with Modulair Quick Connect	1	804441-05	\$590.00
<b>3</b>	<b>Quick Connect Hose Assembly</b>	1	804694-01	\$223.00
<b>4</b>	<b>HARNESSES</b>			
4a	Kevlar	1	804981-01	\$477.00
4b	Nylon	1	804982-01	\$272.00
4c	Full Body Harness (Fall Protection) - Small	1	805061-02	\$760.00
4d	Full Body Harness (Fall Protection) - Medium	1	805061-03	\$760.00
4e	Full Body Harness (Fall Protection) - Large	1	805061-04	\$760.00
<b>5</b>	<b>PRESSURE REDUCERS</b>			
5a	2.2/3.0 Reducer Assembly	1	804304-11	\$540.00
5f	4.5 Reducer Assembly	1	804304-01	\$540.00
5g	4.5 Reducer Assembly (Escape Only)	1	804310-01	\$396.00
<b>6</b>	<b>CYLINDER AND VALVE ASSEMBLIES</b>			
6a	2216 psi, Aluminum, 5-minute	1	805031-01	\$520.00
6b	3000 psi, Carbon, 5-minute	1	805947-02	\$630.00
6c	3000 psi, Carbon, 10-minute	1	805948-02	\$710.00
6f	4500 psi, Carbon, 15-minute	1	200779-01	\$880.00
<b>7</b>	<b>FAST FILL VALVE ASSEMBLIES</b>			
7a	2216 psi	1	201379-01	\$1,030.00
7b	3000 psi	1	201379-02	\$1,030.00
7c	4500 psi	1	201379-03	\$1,030.00
<b>8</b>	<b>AIRLINE HOSE AND FITTINGS</b>			
8a	Airline Hose with Hansen/Foster Fitting	1	804305-01	\$124.00
8b	Airline Hose with Schrader Fitting	1	804305-02	\$124.00
8c	Airline Hose with Hansen HK Fitting Plug	1	804305-03	\$223.00
<b>9</b>	<b>AIRLINE SUPPLY HOSES</b>	See Page 30		
<b>10</b>	<b>WAIST EXTENSION BELTS</b>			
10a	Nylon Extension Belt, 2 Inches Wide	1	805088-02	\$19.00
10b	Kevlar Extension Belt, 1.5 Inches Wide	1	805088-01	\$43.30
<b>11</b>	<b>ACCESSORIES</b>			
11a*	Ska-Pak Series Hard Case	1	803278-01	\$200.00

**NOTE:**

\* Cases are not compatible with select Ska-Pak AT and Ska-Pak AT with FBH



## SKA-PAK

### SUPPLIED AIR RESPIRATOR ASSEMBLIES



SAR Model	List Price	Entry/Egress ①	List Price	Pressure (psig) ②	List Price	Cylinder ④	List Price	Harness	List Price	Regulator	List Price	Airline	List Price	Facepiece ③	List Price	Case	List Price	Packaging	List Price
2 Ska-Pak SAR	\$637	2 Entry/Egress	N/C	2 2216	N/C	00 None	N/C	2 Polypropylene	\$179	1 E-Z Flo	N/C	0 None	N/C	0 None	N/C	0 None	N/C	1 One Per Box	N/C
		3 Egress Only	N/C	3 3000	N/C	01 2216/Aluminum/5min	\$478	4 Kevlar®	\$306			1 Hansen	\$113	1 AV-2000, Kevlar® (CS)	\$377	1 Hard Case	\$200		
				4 4500	N/C	06 4500/Carbon/15min	\$812					2 Schrader	\$118	3 AV-3000 SureSeal, Kevlar® (M)	\$384				
				6 2216 FF	\$561	Drained						3 Cejn	\$199	4 AV-2000 Poly (CS)	\$278				
				7 3000 FF	\$561	AA 2216/Aluminum/5 min	\$478					4 Hansen HK Plug	\$220	6 AV-3000 SureSeal Poly (M)	\$288				
				8 4500 FF	\$561	FF 4500/Carbon/15min	\$812					5 Hansen HK Socket	\$220	7 AV-2000 Rubber (CS)	\$275				
														9 AV-3000 SureSeal Rubber (M)	\$282				

**1. Part Number:**

Select a one or two digit number per box from the chart above that corresponds to your choice

SAR	2	X	X	XX	0	X	1	X	X	X	1
-----	---	---	---	----	---	---	---	---	---	---	---

- ① Must select Entry/Egress to select an Airline option.
- ② FF refers to the Fast Fill system which utilizes a quick connect fitting on the cylinder valve to enable rapid charging of the cylinder.
- ③ If you prefer an alternate Facepiece style, head harness, or size, choose "none" and order an approved Facepiece as a separate line item (see pages 48 - 57 for selection).
- ④ Cylinder clamps not included when selecting option 00.

**2. Price:**

Select the price that corresponds to the number selected above

SAR	\$X	\$X	\$X	\$X		\$X	\$X	\$X	\$X	\$X	\$X
-----	-----	-----	-----	-----	--	-----	-----	-----	-----	-----	-----

**Example**  
**SKA-PAK SAR Model:**  
 For Entry/Egress, for 2216 psi Cylinder, with 2216 psig 5 min Aluminum cylinder, Polypropylene Harness, with E-Z Flo Regulator, no airline, no facepiece, no case, shipped one per box.

SAR	2	2	2	01	0	2	1	1	0	0	1	Total: Add up all costs
	\$637	\$0	\$0	\$478	\$0	\$179	\$0	\$113	\$0	\$0	\$0	

In this example, order Facepiece and Case separately

This price configurator is a guide to 3M Scott Ska-Pak Supplied Air Respirator part numbers.

# 3M SCOTT

## Ska-Pak Respirator

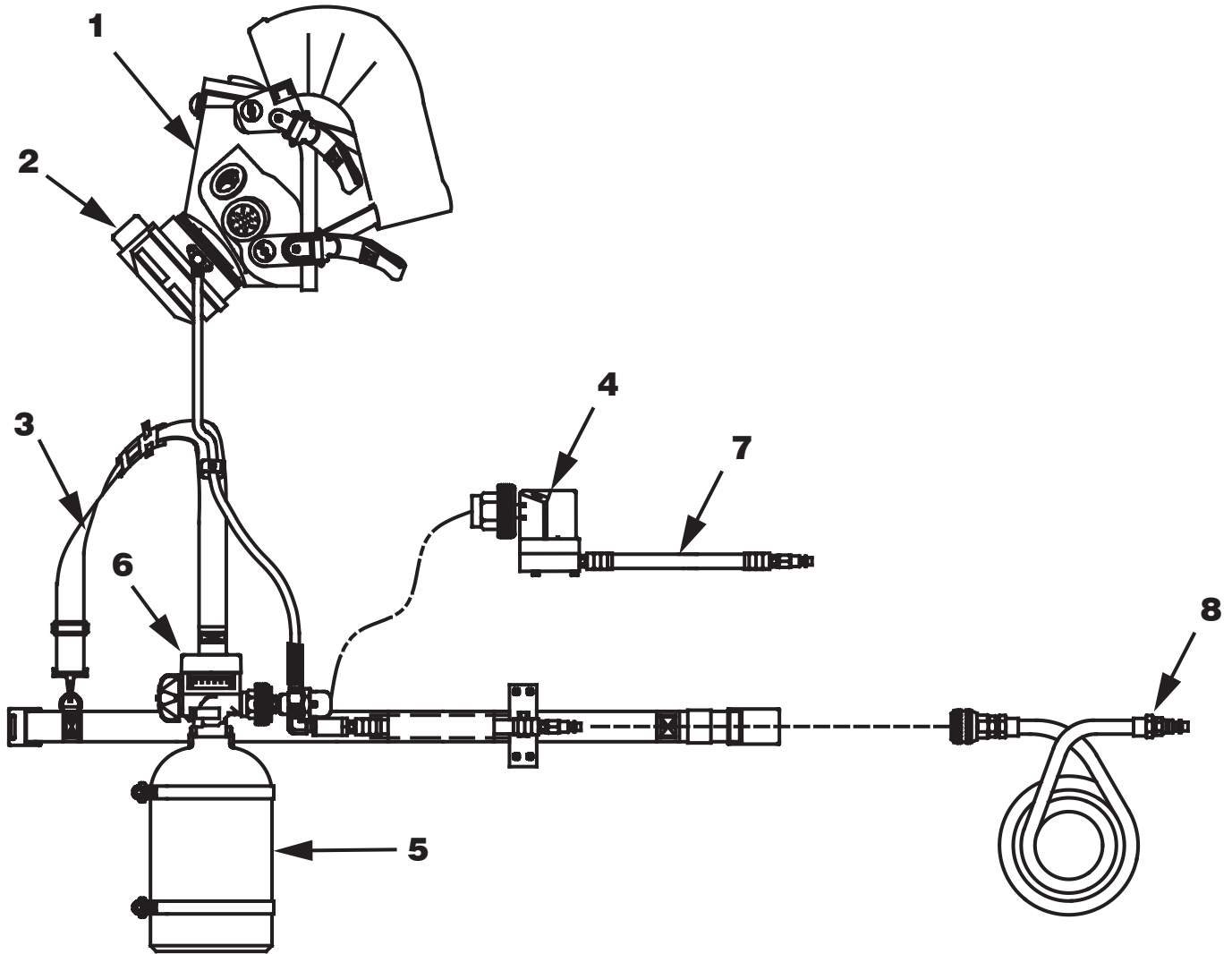

**Ska-Pak Respirator Parts & Accessories**

Item Number	Description	Pieces Per Pkg	Part Number	Price
1	<b>FACEPIECE</b>			
1a	AV-3000 HT Facepiece	See Page 48		
1b	AV-3000 Facepiece with SureSeal	See Page 51		
1c	AV-2000 Facepiece	See Page 55		
2	<b>E-Z Flo Regulator</b>	1	804221-01	\$820.00
3	<b>HARNESSES</b>			
3a	Polypropylene	1	802200-01	\$204.00
3b	Kevlar	1	804307-01	\$454.00
4	<b>PRESSURE REDUCERS</b>			
4a	2.2/3.0 Reducer Assembly	1	804304-11	\$540.00
4c	4.5 Reducer Assembly	1	804304-01	\$540.00
4d	4.5 Reducer Assembly (Escape only)	1	804310-01	\$396.00
5	<b>CYLINDER AND VALVE ASSEMBLIES</b>			
5a	Aluminum, 5-Minute, 2216 psig	1	801935-03	\$469.00
5d	Carbon, 15-minute, 4500 psig	1	200779-03	\$800.00
6	<b>FAST FILL VALVE ASSEMBLIES</b>			
6a	2216 psi	1	201379-01	\$1,030.00
6b	3000 psi	1	201379-02	\$1,030.00
6c	4500 psi	1	201379-03	\$1,030.00
7	<b>AIRLINE HOSE AND FITTINGS</b>			
7a	Airline Hose with Hansen/Foster Fitting	1	804305-01	\$124.00
7b	Airline Hose with Schrader Fitting	1	804305-02	\$124.00
7c	Airline Hose with Hansen HK Fitting Plug	1	804305-03	\$223.00
8	<b>AIRLINE SUPPLY HOSES</b>	See Page 30		
9	<b>ACCESSORIES</b>			
9a	Ska-Pak Series Hard Case	1	803278-01	\$200.00

**3M SCOTT****E-Z AIRLINE**

RESPIRATOR ASSEMBLIES

**E-Z Airline with Modulair QuickConnect**

Part Numbers	Harness	Facepiece	Head Harness	Faceseal Size	Regulator	Hose Fitting	Price
804386-19	Nylon	AV-2000	Polyester	Comfort Seal	E-Z Flo w/ Modulair	Hansen	\$918.00
804386-25	Nylon	AV-2000	Polyester	Comfort Seal	E-Z Flo w/ Modulair	Schrader	\$918.00
804386-66	Nylon	Facepiece not included, order separately			E-Z Flo w/ Modulair	Hansen	\$640.00
804386-62	Nylon	Facepiece not included, order separately			E-Z Flo w/ Modulair	Schrader	\$640.00

**E-Z Airline Less Modulair QuickConnect**

Part Numbers	Harness	Facepiece	Head Harness	Faceseal Size	Regulator	Hose Fitting	Price
804386-67	Nylon	Facepiece not included, order separately			E-Z Flo	Hansen	\$640.00

**E-Z Airline Respirator Facepiece Parts & Accessories**

Item Number	Description	Pieces Per Pkg	Part Number	Price
1	<b>FULL FACEPIECES</b>			
1a	AV-3000 HT Facepiece	See Page 48		
1b	AV-3000 Facepiece with SureSeal	See Page 51		
1c	AV-2000 Facepiece	See Page 55		
2	<b>HARNESS</b>	1	804493-01	\$171.00
3	<b>E-Z Flo Regulator with Modulair Quick Connect</b>	1	804441-05	\$590.00
4	<b>REGULATOR HOSE ASSEMBLIES</b>			
4a	Hose Assembly, Schrader	1	804694-03	\$171.00
4b	Hose Assembly, Hansen	1	804694-04	\$180.00
4c	Hose Assembly, Hansen HK Plug	1	804694-02	\$288.00
5	<b>AIRLINE SUPPLY HOSES</b>	See Page 30		

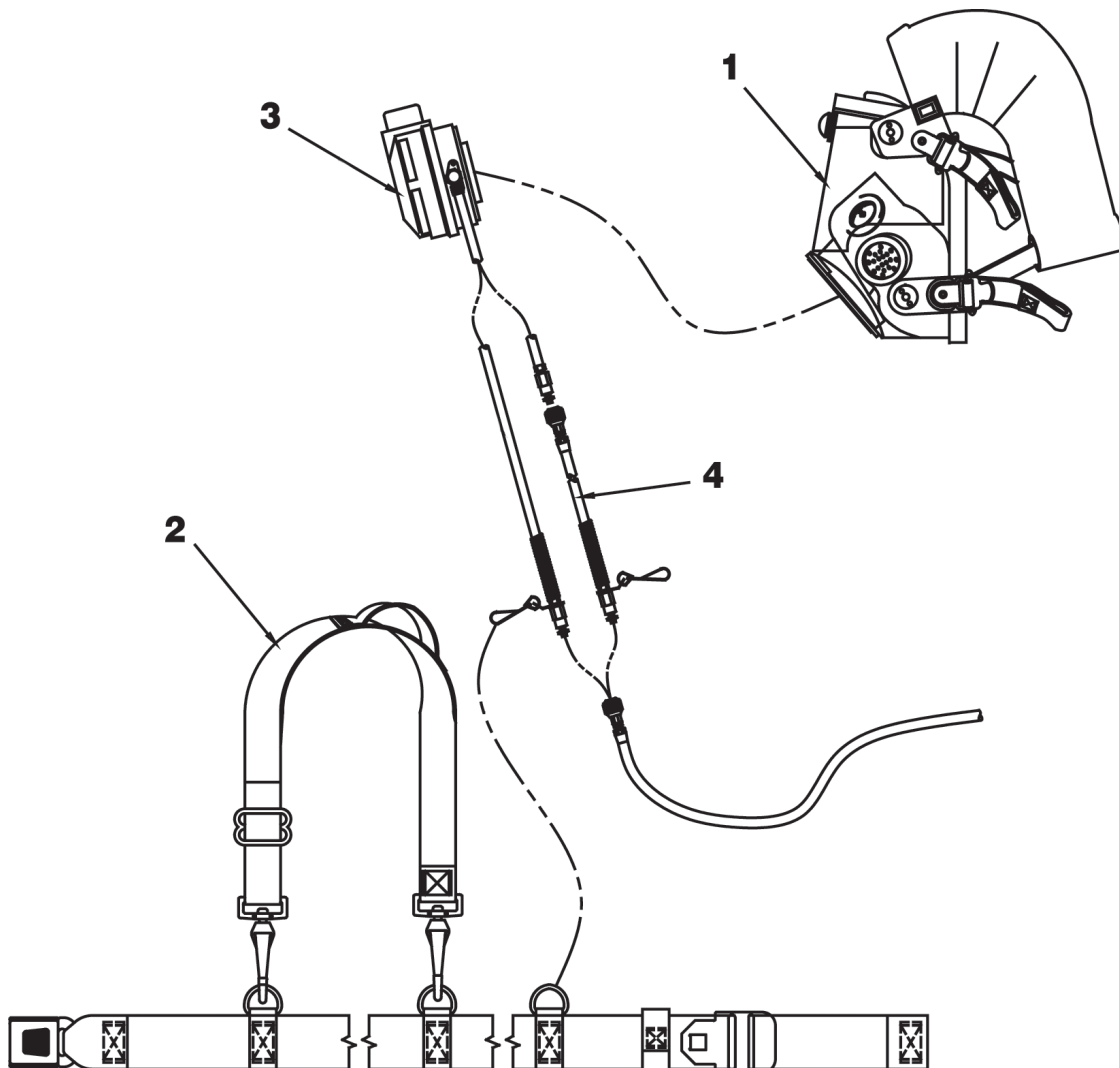

# 3M SCOTT

## Supply Hose Assemblies

Part Number	Description	Pieces Per Pkg	Price
26369-006	Hansen HK, 6 Ft	1	\$258.00
26369-010	Hansen HK, 10 Ft	1	\$307.00
26369-025	Hansen HK, 25 Ft	1	\$395.00
26369-050	Hansen HK, 50 Ft	1	\$474.00
26369-100	Hansen HK, 100 Ft	1	\$620.00
26370-006	Foster, 6 Ft	1	\$135.00
26370-010	Foster, 10 Ft	1	\$157.00
26370-025	Foster, 25 Ft	1	\$216.00
26370-050	Foster, 50 Ft	1	\$305.00
26370-100	Foster, 100 Ft	1	\$470.00
26370-150	Foster, 150 Ft	1	\$640.00
30010-006	Hansen, 6 Ft	1	\$135.00
30010-010	Hansen, 10 Ft	1	\$157.00
30010-025	Hansen, 25 Ft	1	\$216.00
30010-050	Hansen, 50 Ft	1	\$305.00
30010-100	Hansen, 100 Ft	1	\$470.00
30010-150	Hansen, 150 Ft	1	\$640.00
30010-300	Hansen, 300 Ft	1	\$1,350.00
30020-006	Schrader, 6 Ft	1	\$135.00
30020-010	Schrader, 10 Ft	1	\$157.00
30020-025	Schrader, 25 Ft	1	\$216.00
30020-050	Schrader, 50 Ft	1	\$305.00
30020-100	Schrader, 100 Ft	1	\$474.00
30020-150	Schrader, 150 Ft	1	\$640.00
805659-006	Cejn, 6 Ft	1	\$171.00
805659-025	Cejn, 25 Ft	1	\$262.00
805659-050	Cejn, 50 Ft	1	\$388.00
805659-100	Cejn, 100 Ft	1	\$530.00

**Pass-Thru Assemblies**

Part Number	Description	Pieces Per Pkg	Price
803620-01*	Pass-Thru Assembly, Hansen Fitting, Airline	1	\$169.00
803620-02*	Pass-Thru Assembly, Schrader Fitting, Airline	1	\$169.00
803620-05*	Pass-Thru Assembly, Cejn Fitting, Airline	1	\$439.00
803620-03**	Pass-Thru Assembly, Hansen Fitting, Dual EBSS	1	\$405.00
803620-04**	Pass-Thru Assembly, Schrader Fitting, Dual EBSS	1	\$405.00

\* For use with airline

\*\* For use with Dual EBSS

\*\*\* Pass-thru devices are manufactured for use in protective chemical suits, e.g. Level A and Level B. NIOSH approvals for pass-thru devices in chemical suits are carried by the chemical suit manufacturer. The pass-thru devices must be installed by the suit manufacturer to maintain proper NIOSH approvals.

# 3M SCOTT

## RIT-PAK FAST ATTACK

EMERGENCY AIR SUPPLY



### RIT-Pak Fast Attack (Less Cylinder)

Part Number	Bag Size	Pressure (psig)	Carrying Bag	6' EBSS Hose	5' RIC Hose	RIT-Pak Facepiece	E-Z-Flo Regulator	Price
201564-01	Medium	4500	●	●	●	●	●	\$2,630.00
201564-02	Medium	5500	●	●	●	●	●	\$2,630.00
201564-03	Small	4500	●	●	●	●	●	\$2,630.00

### RIT-Pak Fast Attack Cylinders

Part Number	Description	Price
201561-01	4.5, 15-min, Cylinder & Valve (90°)	\$900.00
200870-01	4.5, 30-min, Cylinder & Valve (90°)	\$1,110.00
201567-01	5.5, 30-min, Cylinder & Valve (90°)	\$1,451.00
201568-01	5.5, 45-min, Cylinder & Valve (90°)	\$1,722.00

### RIT-Pak Fast Attack Accessories

Part Number	Description	Price
201558-01	RIT-Pak Fast Attack, Bag, Medium	\$590.00
201558-02	RIT-Pak Fast Attack, Bag, Small	\$560.00
201600-01	RIT-Pak Fast Attack, Shoulder Strap Assembly	\$169.00
201595-01	RIT-Pak Fast Attack, Facepiece	\$248.00
201605-01	RIT-Pak Fast Attack, E-Z Flo Regulator	\$770.00
31003648	RIT-Pak Fast Attack, Carabiner	\$25.40



## RIT-PAK III

EMERGENCY AIR SUPPLY



### RIT-Pak III

Part Number	Pressure (psig)	Carrying Bag	Shoulder Strap	6' EBSS Hose	5' RIC Hose	Facepiece	E-Z-Flo Regulator	Price
200954-01	2216	●	●	●	●	●	●	\$3,700.00
200954-02	4500	●	●	●	●	●	●	\$3,700.00
200954-05	5500	●	●	●	●	●	●	\$3,820.00

### RIT-Pak III Accessories

Part Number	Description	Price
200955-01	RIT-Pak III Replacement Bag Less Shoulder Strap	\$890.00
200989-01	Replacement Shoulder Strap	\$143.00
200959-01	RIT-Pak III Replacement Facepiece	\$262.00
200962-01	RIT-Pak III Replacement E-Z Flo Regulator	\$800.00
200991-01	RIT-Pak III Carrying Strap Assembly	\$143.00

# 3M SCOTT

## MOBILE AIR CART

AIR SUPPLY



### Mobile AIR CART (Less Cylinders)

Part Number	Description	Pieces Per Pkg	Price
805825-01	Mobile Air Cart, 2 Outlet, Hansen Style, Aux. Inlet	1	\$2,900.00
805825-04	Mobile Air Cart, 2 Outlet, Schrader, Aux. Inlet	1	\$2,900.00
805826-01	Mobile Air Cart, 4 Outlet, Hansen Style, Aux. Inlet	1	\$3,050.00
805826-04	Mobile Air Cart, 4 Outlet, Schrader Aux. Inlet	1	\$3,050.00
805827-01	Mobile Air Cart, 4 Outlet, 2 Tool, Hansen Style, Aux. Inlet	1	\$3,520.00
805827-04	Mobile Air Cart, 4 Outlet, 2 Tool, Schrader, Aux. Inlet	1	\$3,520.00

## TRC-1 AIR CART

AIR SUPPLY



### TRC-1 AIR CART (Less Cylinders)

Part Number	Description	Pieces Per Pkg	Price
200070-01	TRC-1 Air Cart, 8 Outlet, Aux. Inlet, Hansen Style	1	\$6,660.00
200070-02	TRC-1 Air Cart, 8 Outlets, Aux. Inlet, Foster	1	\$6,810.00
200070-03	TRC-1 Air Cart, 8 Outlets, Aux. Inlet, Hansen HK	1	\$7,180.00
200070-04	TRC-1 Air Cart, 8 Outlets, Aux. Inlet, Schrader	1	\$6,690.00
200070-05	TRC-1 Air Cart, 8 Outlets, Aux. Inlet, Cejn	1	\$7,030.00

### Cylinder & Valve Assemblies

Part Number	Description	Pieces Per Pkg	Price
804723-01	4500 psig, 60 minute Carbon	1	\$1,732.00
804723-35	4500 psig, 60 minute Carbon, 30 yr	1	\$2,329.00
200972-01	5500 psig, 60 minute Carbon	1	\$1,911.00
200975-01	5500 psig, 75 minute Carbon	1	\$2,108.00

# ELSA

## EMERGENCY ESCAPE BREATHING DEVICE



### ELSA Emergency Escape Breathing Device

Part Number	Description	Price
2009164	ELSA 5-Minute Emergency Escape Breathing Device	\$530.00
2009165	ELSA 10-Minute Emergency Escape Breathing Device	\$650.00
2014226	ELSA 15-Minute Emergency Escape Breathing Device	\$815.00
201398-32-D*	ELSA 5-Minute Emergency Escape Breathing Device, Drained Cylinder	\$530.00
201398-33-D*	ELSA 10-Minute Emergency Escape Breathing Device, Drained Cylinder	\$650.00
201398-34-D*	ELSA 15-Minute Emergency Escape Breathing Device, Drained Cylinder	\$815.00

\* CA Approved

### ELSA Parts and Accessories

Part Number	Description	Price
2010880	Replacement Hood	\$121.00
2010884	Replacement Bag, 5-Minute Unit	\$93.00
2010885	Replacement Bag, 10-Minute Unit	\$93.00
2015330	Replacement Bag, 15-Minute Unit	\$92.00
2010881	Reducer Assembly, 5-Minute Unit	\$412.00
2010882	Reducer Assembly, 10-Minute and 15-Minute Unit	\$412.00
2010173	Anti-Fog Coating	\$10.30

**3M SCOTT**

# PAK-TRACKER

## FIREFIGHTER LOCATOR



With the Pak-Tracker Locator in their arsenal, search and rescue teams can locate downed, trapped or lost firefighters, first responders or other emergency personnel quickly and efficiently regardless of the complexity of the structure or the visual conditions at the fire scene.

### Pak-Tracker Firefighter Locator

Part Number	Description	Price
200266-04	Pak- Tracker Hand-Held Receiver Kit	\$1,750.00

*Note - Upgrade Kits are available for Air-Pak 75 and Air-Pak X3 SCBA to add Pak-Tracker functionality. Consult your distributor or 3M Scott Specialist for more information.*

### Accessories of Pak-Tracker Firefighter Locator

Part Number	Description	Price
200433-01	Pak-Tracker Hand-Held Receiver Truck Charging System, 12V DC	\$640.00
200433-02	Pak-Tracker Hand-Held Receiver Truck Charging System, 110V AC	\$690.00
200434-01	Pak-Tracker Hand-Held Receiver Desktop Charging System, 110V AC	\$570.00

# MONITOR/MONITOR PRO

TELEMETRY SOFTWARE SOLUTION



Scott Connect Monitor puts critical, real-time responder information at incident command's fingertips. Designed for use on modern, touch-enabled PCs, Monitor is an intuitive and powerful air management/telemetry solution meant to compliment existing accountability practices. Monitor works with all SEMS-equipped 3M Scott SCBA, though some features are only available when used with the Air-Pak X3 Pro.

## Scott Connect Monitor Core Components

Part Number	Description	Price
8005197	Scott Connect Monitor Base Command Install	\$0.00
*8006951	Scott Connect Monitor, Pro Edition Add-on	\$0.00
201088-03	SEMS II, USB Gateway	\$2,150.00
201051-01	SEMS II Repeater	\$1,975.00

\*Required for compatibility with SEMS II Pro. Must be purchased in addition to Scott Connect Monitor Base Command Install, part number 8005197.

## Accessories / Hardware

Part Number	Description	Price
200773-01	RFID Reader/Writer	\$700.00
200774-01	RFID cards, 10 pack	\$130.00
201279-01	Tally Tag, Red, 10 pack	\$110.00
201279-02	Tally Tag, White, 10 pack	\$110.00
201279-03	Tally Tag, Black, 10 pack	\$110.00
201279-04	Tally Tag, Yellow, 10 pack	\$110.00
201279-05	Tally Tag, Orange, 10 pack	\$110.00
201279-06	Tally Tag, Green, 10 pack	\$110.00
201279-07	Tally Tag, Blue, 10 pack	\$110.00
201279-08	Tally Tag, Pink, 10 pack	\$110.00
201280-01	Button Tag, 10 pack	\$115.00

# SERVICE & ASSET MANAGEMENT (SAM)

CLOUD-BASED ASSET MANAGEMENT SOLUTION



The Service and Asset Management (SAM) solution is a simple-to-use application that simplifies a firefighter's daily equipment inspections, preserving a permanent digital inspection record and assisting in keeping a department in compliance with NFPA 1852 and OSHA 1910.134. SAM is customizable to meet a department's requirements and can be configured for direct communication between a station and their Service Center.

## SAM Application License

Part Number	Description	Price
8004748	Scott Connect Service and Asset Management (SAM) App License - 1 Year	\$525.00

## SAM Equipment Asset Bundle

Part Number	Description	Price
8004749	Scott Connect SAM Asset Bundle (100 Assets) - 1 Year	\$525.00
8004750	Scott Connect SAM Asset Bundle (500 Assets) - 1 Year	\$945.00
8004751	Scott Connect SAM Asset Bundle (1000 Assets) - 1 Year	\$1,260.00
8004752	Scott Connect SAM Asset Bundle (2000 Assets) - 1 Year	\$1,470.00
8004753	Scott Connect SAM Asset Bundle (Unlimited Assets) - 1 Year	\$1,575.00

## SAM Resource Bundle

Part Number	Description	Price
8000371	Scott Connect Resource Bundle (50 Resources) - 1 Year	\$315.00
8000372	Scott Connect Resource Bundle (50 Resources) - 2 Year	\$570.00
8000373	Scott Connect Resource Bundle (50 Resources) - 3 Year	\$810.00
8000374	Scott Connect Resource Bundle (50 Resources) - 4 Year	\$1,040.00
8000375	Scott Connect Resource Bundle (50 Resources) - 5 Year	\$1,260.00

# X380

## THERMAL IMAGING CAMERA



### X380

Description	Temp	X380N NFPA*		X380 3 BUTTON*		X380 5 Button**	
		Part No.	List	Part No.	List	Part No.	List
X-Series Camera with standard Hot and Cold Spot Tracker, 2X/4X Zoom and Two Batteries. Ships with a Lanyard, Desktop and Truck Charger in a Carton. Price includes standard three year warranty. Fahrenheit	F	8003024	\$11,100.00	8003040	\$9,380.00	8003056	\$10,000.00
X-Series Camera with standard Hot and Cold Spot Tracker, 2X/4X Zoom and Two Batteries. Ships with a Lanyard, Desktop and Truck Charger in a Carton. Price includes standard three year warranty. Celsius	C	8003025	\$11,100.00	8003041	\$9,380.00	8003057	\$10,000.00
X-Series Camera with standard Hot & Cold Spot Tracker, 2X/4X Zoom and Two Batteries. Ships in a Carton. Three years of warranty. Fahrenheit	F	8003026	\$10,340.00	8003042	\$8,580.00	8003058	\$9,070.00
X-Series Camera with standard Hot & Cold Spot Tracker, 2X/4X Zoom and Two Batteries. Ships in a Carton. Three years of warranty. Celsius	C	8003027	\$10,340.00	8003043	\$8,580.00	8003059	\$9,070.00
X-Series Camera with standard Hot and Cold Spot Tracker, 2X/4X Zoom and Two Batteries. Ships with a Lanyard, and Desktop Charger in a Hard Case. Three years of warranty. Fahrenheit	F	8003028	\$10,600.00	8003044	\$8,880.00	8003060	\$9,410.00
X-Series Camera with standard Hot and Cold Spot Tracker, 2X/4X Zoom and Two Batteries. Ships with a Lanyard, and Desktop Charger in a Hard Case. Three years of warranty. Celsius	C	8003029	\$10,600.00	8003045	\$8,880.00	8003061	\$9,410.00
X-Series Camera with standard Hot and Cold Spot Tracker, 2X/4X Zoom and Two Batteries. Ships with a Lanyard and Truck Charger in a Carton. Three years of warranty. Fahrenheit	F	8003030	\$10,910.00	8003046	\$9,190.00	8003062	\$9,770.00
X-Series Camera with standard Hot and Cold Spot Tracker, 2X/4X Zoom and Two Batteries. Ships with a Lanyard and Truck Charger in a Carton. Three years of warranty. Celsius	C	8003031	\$10,910.00	8003047	\$9,190.00	8003063	\$9,770.00

\* Does not have DVR.

\*\* Also offers Image Capture (Snapshot), On-Demand DVR & Image Freeze

# 3M SCOTT

## X380 Extended Warranty Options

Description	Temp	X380N NFPA*		X380 3 BUTTON*		X380 5 Button**	
		Part No.	List	Part No.	List	Part No.	List
X-Series Camera with standard Hot & Cold Spot Tracker, 2X/4X Zoom and Two Batteries. Ships in a Carton. Price includes two years of extended warranty, for a total of five years' coverage. Fahrenheit	F	8003032	\$11,980.00	8003048	\$10,230.00	8003064	\$10,720.00
X-Series Camera with standard Hot & Cold Spot Tracker, 2X/4X Zoom and Two Batteries. Ships in a Carton. Price includes two years of extended warranty, for a total of five years' coverage. Celsius	C	8003033	\$11,980.00	8003049	\$10,230.00	8003065	\$10,720.00
X-Series Camera with standard Hot and Cold Spot Tracker, 2X/4X Zoom and Two Batteries. Ships with a Lanyard and Desktop Charger in a Hard Case. Price includes two years of extended warranty, for a total of five years' coverage. Fahrenheit	F	8003034	\$12,250.00	8003050	\$10,530.00	8003066	\$11,060.00
X-Series Camera with standard Hot and Cold Spot Tracker, 2X/4X Zoom and Two Batteries. Ships with a Lanyard and Desktop Charger in a Hard Case. Price includes two years of extended warranty, for a total of five years' coverage. Celsius	C	8003035	\$12,250.00	8003051	\$10,530.00	8003067	\$11,060.00
X-Series Camera with standard Hot and Cold Spot Tracker, 2X/4X Zoom and Two Batteries. Ships with a Lanyard and Truck Charger in a Carton. Price includes two years of extended warranty, for a total of five years' coverage. Fahrenheit	F	8003036	\$12,550.00	8003052	\$10,840.00	8003068	\$11,420.00
X-Series Camera with standard Hot and Cold Spot Tracker, 2X/4X Zoom and Two Batteries. Ships with a Lanyard and Truck Charger in a Carton. Price includes two years of extended warranty, for a total of five years' coverage. Celsius	C	8003037	\$12,550.00	8003053	\$10,840.00	8003069	\$11,420.00
X-Series Camera with standard Hot and Cold Spot Tracker, 2X/4X Zoom and Two Batteries. Ships with a Lanyard, Desktop and Truck Charger in a Hard-Sided Case. Price includes two years of extended warranty, for a total of five years' coverage. Fahrenheit	F	8003038	\$12,890.00	8003054	\$11,180.00	8003070	\$11,970.00
X-Series Camera with standard Hot and Cold Spot Tracker, 2X/4X Zoom and Two Batteries. Ships with a Lanyard, Desktop and Truck Charger in a Hard-Sided Case. Price includes two years of extended warranty, for a total of five years' coverage. Celsius	C	8003039	\$12,890.00	8003055	\$11,180.00	8003071	\$11,970.00

\* Does not have DVR.

\*\* Also offers Image Capture (Snapshot), On-Demand DVR & Image Freeze

## X380 Accessories

Part Number	Description	Price
8003072	X Series Hard Sided Case - Fits Camera, Desktop and Truck Charger	\$187.00
8002931	Drive Away Detection	\$425.00
8002930	X Series Retractable Lanyard	\$133.00
8002926	X Series Desktop Charger	\$244.00
8002927	X Series Truck Charger	\$830.00
8002965	X Series Standard Battery	\$155.00
8002929	X380 NFPA Compliant Battery	\$187.00



# X190

THERMAL IMAGING CAMERA



## X190

Part Number	Temp	Description	Price
8005071	F	X190 Camera with Two Batteries. Ships with a Lanyard, and Desktop Charger in a carton. Three years of warranty. Fahrenheit V-01	\$6,490.00
8005072	C	X190 Camera with Two Batteries. Ships with a Lanyard, and Desktop Charger in a carton. Three years of warranty. Celsius V-02	\$6,490.00
8005073	F	X190 Camera with Two Batteries. Ships with a Lanyard, Truck Charger in a Carton. Three years of warranty. Fahrenheit V-03	\$7,210.00
8005074	C	X190 Camera with Two Batteries. Ships with a Lanyard, Truck Charger in a Carton. Three years of warranty. Celsius V-04	\$7,210.00
8005075	F	X190 Camera with Two Batteries. Ships with a Lanyard, Desktop Charger and Truck Charger in a Carton. Three years of warranty. Fahrenheit V-05	\$7,580.00
8005076	C	X190 Camera with Two Batteries. Ships with a Lanyard, Desktop Charger and Truck Charger in a Carton. Three years of warranty. Celsius V-06	\$7,580.00

## X190 Accessories

Part Number	Description	Price
8003072	X Series Hard Sided Case - Fits Camera, Desktop and Truck Charger	\$187.00
8002931	Drive Away Detection	\$425.00
8002930	X Series Retractable Lanyard	\$133.00
8002926	X Series Desktop Charger	\$244.00
8002927	X Series Truck Charger	\$830.00
8002965	X Series Standard Battery	\$155.00

**3M SCOTT**

## V320

THERMAL IMAGING CAMERA



### V320

Part Number	Temp	Description	Price
8007134	F	V320 25 Hz Fahrenheit - Kit includes two batteries, retractable lanyard, and desktop charger in a carton. Three years of warranty.	\$2,700.00
8007135	C	V320 25 Hz Celsius - Kit includes two batteries, retractable lanyard, and desktop charger in a carton. Three years of warranty.	\$2,700.00

### V320 Accessories

Part Number	Description	Price
8007136	V-Series Retractable Lanyard	\$125.00
8007137	V-Series Battery Charger	\$195.00
8007138	V-Series Charger Power Supply	\$50.00
8007139	V-Series Standard Battery	\$125.00

## SCOTT SIGHT

IN-MASK THERMAL IMAGING



### SCOTT SIGHT

Part Number	Description	Price
201581-01	Scott Sight Full Kit - Small 5 Strap	\$1,960.00
201581-02	Scott Sight Full Kit w/comms - Small 5 Strap	\$2,060.00
201581-11	Scott Sight Full Kit - Small 4 Strap	\$1,960.00
201581-12	Scott Sight Full Kit w/comms - Small 4 Strap	\$2,060.00
201582-01	Scott Sight Full Kit - Medium 5 Strap	\$1,960.00
201582-02	Scott Sight Full Kit w/comms - Medium 5 Strap	\$2,060.00
201582-11	Scott Sight Full Kit - Medium 4 Strap	\$1,960.00
201582-12	Scott Sight Full Kit w/comms - Medium 4 Strap	\$2,060.00
201583-01	Scott Sight Full Kit - Large 5 Strap	\$1,960.00
201583-02	Scott Sight Full Kit w/comms - Large 5 Strap	\$2,060.00
201583-11	Scott Sight Full Kit - Large 4 Strap	\$1,960.00
201583-12	Scott Sight Full Kit w/comms -Large 4 Strap	\$2,060.00
201584-01	Scott Sight Install Kit Small	\$1,600.00
201584-02	Scott Sight Install Kit Small Left Comms	\$1,700.00
201585-01	Scott Sight Install Kit Medium	\$1,600.00
201585-02	Scott Sight Install Kit Medium Left Comms	\$1,700.00
201586-01	Scott Sight Install Kit Large	\$1,600.00
201586-02	Scott Sight Install Kit Large Comms	\$1,700.00

**3M SCOTT**

## SCOTT SIGHT

IN-MASK THERMAL IMAGING



### SCOTT SIGHT PRO PACKAGE

Part Number	Description	Price
201581-01P	Scott Sight Pro Package Full Kit - Small 5 Strap	\$2,313.00
201581-02P	Scott Sight Pro Package Full Kit w/comms - Small 5 Strap	\$2,415.00
201581-11P	Scott Sight Pro Package Full Kit - Small 4 Strap	\$2,313.00
201581-12P	Scott Sight Pro Package Full Kit w/comms - Small 4 Strap	\$2,415.00
201582-01P	Scott Sight Pro Package Full Kit - Medium 5 Strap	\$2,313.00
201582-02P	Scott Sight Pro Package Full Kit w/comms - Medium 5 Strap	\$2,415.00
201582-11P	Scott Sight Pro Package Full Kit - Medium 4 Strap	\$2,313.00
201582-12P	Scott Sight Pro Package Full Kit w/comms - Medium 4 Strap	\$2,415.00
201583-01P	Scott Sight Pro Package Full Kit - Large 5 Strap	\$2,313.00
201583-02P	Scott Sight Pro Package Full Kit w/comms - Large 5 Strap	\$2,415.00
201583-11P	Scott Sight Pro Package Full Kit - Large 4 Strap	\$2,313.00
201583-12P	Scott Sight Pro Package Full Kit w/comms -Large 4 Strap	\$2,415.00
201584-01P	Scott Sight Pro Package Install Kit Small	\$1,930.00
201584-02P	Scott Sight Pro Package Install Kit Small Left Comms	\$2,032.00
201585-01P	Scott Sight Pro Package Install Kit Medium	\$1,930.00
201585-02P	Scott Sight Pro Package Install Kit Medium Left Comms	\$2,032.00
201586-01P	Scott Sight Pro Package Install Kit Large	\$1,930.00
201586-02P	Scott Sight Pro Package Install Kit Large w/comms	\$2,032.00

# COMMUNICATIONS

## EPIC 3 COMMUNICATIONS



### EPIC 3 Radio Direct Interface Voice Amplifier

Part Number	Description	Price
201276-11	EPIC 3 RDI Voice Amplifier, Motorola APX radios, Open Bracket Configuration	\$795.00
201276-12	EPIC 3 RDI Voice Amplifier, Motorola APX radios, Closed Bracket Configuration	\$795.00
201276-21	EPIC 3 RDI Voice Amplifier, Harris XL radios, Open Bracket Configuration	\$795.00
201276-22	EPIC 3 RDI Voice Amplifier, Harris XL radios, Closed Bracket Configuration	\$795.00

### EPIC 3 Radio Interface Voice Amplifier

Part Number	Description	Price
201276-01	EPIC 3 Radio Interface Voice Amplifier, Open Bracket Configuration	\$695.00
201276-02	EPIC 3 Radio Interface Voice Amplifier, Closed Bracket Configuration	\$695.00

### EPIC 3 Voice Amplifier

Part Number	Description	Price
201275-01	EPIC 3 Voice Amplifier, Open Bracket Configuration	\$645.00
201275-02	EPIC 3 Voice Amplifier, Closed Bracket Configuration	\$645.00

### EPIC 3 Bluetooth Lapel Speaker Microphone

Part Number	Description	Price
201277-02	EPIC 3 Bluetooth Lapel Speaker Microphone, for use with Motorola HT1000, XTS series radios	\$850.00
201277-04	EPIC 3 Bluetooth Lapel Speaker Microphone, for use with Motorola HT750/1250/1550 series radios	\$850.00
201277-06	EPIC 3 Bluetooth Lapel Speaker Microphone, for use with Motorola Mototrbo XPR Series, APX series radios	\$850.00
201277-07	EPIC 3 Bluetooth Lapel Speaker Microphone, for use with Kenwood TK280/290/380/390 series radios	\$850.00
201277-11	EPIC 3 Bluetooth Lapel Speaker Microphone, for use with Motorola Radius GP300 series radios	\$850.00
201277-22	EPIC 3 Bluetooth Lapel Speaker Microphone, for use with Harris P5400/7300, Unity Series, XG series radios	\$850.00

### EPIC 3 Lapel Speaker Microphone

# 3M SCOTT

Part Number	Description	Price
201224-02	EPIC 3 Lapel Speaker Microphone, for use with Motorola HT1000, XTS series radios	\$695.00
201224-04	EPIC 3 Lapel Speaker Microphone, for use with Motorola HT750/1250/1550 series radios	\$695.00
201224-06	EPIC 3 Lapel Speaker Microphone, for use with Motorola Mototrbo XPR Series, APX series radios	\$695.00
201224-07	EPIC 3 Lapel Speaker Microphone, for use with Kenwood TK280/290/380/390 series radios	\$695.00
201224-22	EPIC 3 Lapel Speaker Microphone, for use with Harris P5400/7300, Unity Series, XG series radios	\$695.00

## Radio Interface PTT Paddle Accessory

Part Number	Description	Price
201675-02	Radio Interface PTT PADDLE, for use with Motorola HT1000, XTS series radios	\$375.00
201675-04	Radio Interface PTT PADDLE, for use with Motorola HT750/1250/1550 series radios	\$375.00
201675-06	Radio Interface PTT PADDLE, for use with Motorola APX/XPR/DP/DGP/MTP series radios	\$375.00
201675-07	Radio Interface PTT PADDLE, for use with JVCKenwood multi-pin connector TK and NX series radios	\$375.00
201675-11	Radio Interface PTT PADDLE, for use with Motorola Radius GP300 series radios	\$375.00
201675-21	Radio Interface PTT PADDLE, for use with Harris XL-200, Unity XG-100 radios	\$375.00
201675-22	Radio Interface PTT PADDLE, for use with Harris P5400/7300, XG 25/75 radios	\$375.00
201675-28	Radio Interface PTT PADDLE, for use with JVCKenwood two-pin connector TK and NX series radios	\$375.00

## EPIC 3 Voice Communication System Accessories

Part Number	Description	Price
201226-01	EPIC 3 Ring PTT	\$273.00
201227-01	EPIC 3 Paddle PTT	\$273.00
201228-01	EPIC 3 Throat Mic	\$395.00
201229-01	EPIC 3 Command Communication Headset	\$475.00
201243-01	EPIC 3 Bluetooth Programmer Interface Module with USB cable	\$195.00

## Facepiece Brackets

Part Number	Description	Price
201210-01	AV-3000 HT Open Bracket, Right (for use with EPIC 3 only)	\$32.00
201210-02	AV-3000 HT Open Bracket, Left (for use with EPIC 3 only)	\$51.00
200715-01	AV-3000 communications bracket, right side	\$43.60
200716-01	AV-2000 communications bracket	\$43.60

# NOTES

---

# 3M SCOTT









## AV-3000 HT

### SERIES FACEPIECES











The AV-3000 HT Series facepieces are fully interchangeable with the full line of 3M Scott SCBA, air-supplied respirators and air purifying respirators, as well as 3M Scott communications products providing "Top-Down Convertibility" options. It is designed to minimize equipment inventories, simplify the complexities of user training when issued as a single personal issue facepiece and reduce redundant facepiece fit tests.

#### AV-3000 HT Facepiece with Kevlar Head Harness, 5-Strap

Part Number	Description	Price
201215-01	Small Face seal 	\$385.00
201215-02	Medium Face seal 	\$385.00
201215-03	Large Face seal 	\$385.00
201215-04	Small Face seal, Right Comm Bracket 	\$412.00
201215-05	Medium Face seal, Right Comm Bracket 	\$412.00
201215-06	Large Face seal, Right Comm Bracket 	\$412.00
201215-07	Small Face seal, Left Comm Bracket 	\$434.00
201215-08	Medium Face seal, Left Comm Bracket 	\$434.00
201215-09	Large Face seal, Left Comm Bracket 	\$434.00

#### AV-3000 HT Facepiece with Kevlar Head Harness, 4-Strap

Part Number	Description	Price
201215-21	Small Face seal 	\$385.00
201215-22	Medium Face seal 	\$385.00
201215-23	Large Face seal 	\$385.00
201215-27	Small Face seal, Right Comm Bracket 	\$412.00
201215-28	Medium Face seal, Right Comm Bracket 	\$412.00
201215-29	Large Face seal, Right Comm Bracket 	\$412.00
201215-34	Small Face seal, Left Comm Bracket 	\$434.00
201215-35	Medium Face seal, Left Comm Bracket 	\$434.00
201215-36	Large Face seal, Left Comm Bracket 	\$434.00



AV-3000 HT Facepiece with Kevlar Head Harness is NIOSH CBRN APR approved with 40 mm First Responder adapter and CBRN Cap-1 Canister



**AV-3000 HT Facepiece Parts & Accessories**

Item Number	Description	Pieces Per Pkg	Part Number	Price
1	<b>COMPLETE HEAD HARNESS ASSEMBLY</b>			
1a	Kevlar Head Harness, 5-Strap*	1	200803-01	\$182.00
1b	Kevlar Head Harness, 4-Strap, Small	1	201467-01	\$182.00
1c	Kevlar Head Harness, 4-Strap, Medium/Large	1	201467-02	\$182.00
2	<b>TEMPLE STRAPS</b>			
2a	Kevlar Temple Strap**	1	804178-02	\$25.50
3	<b>NECK STRAPS</b>			
3a	Kevlar Neck Strap	1	804176-02	\$25.50
4	<b>Facepiece Lens (Fenestra, Drilled) (AV-3000 HT only)</b>	1	201134-01	\$153.00
5	<b>Upper Bezel (AV-3000 HT only)</b>	1	31002809	\$10.50
6	<b>Lower Bezel (AV-3000 HT only)</b>	1	31002810	\$15.70
7	<b>Bezel Screw</b>	2	33361-020	\$2.20
8	<b>FACEPIECE SEALS (AV-3000 SURESEAL AND AV-3000 HT)</b>			
8a	AV-3000 SureSeal, FaceSeal, Small	1	200802-01	\$202.00
8b	AV-3000 SureSeal, FaceSeal, Medium	1	200802-02	\$202.00
8c	AV-3000 SureSeal, FaceSeal, Large	1	200802-03	\$202.00
8d	AV-3000 SureSeal, FaceSeal, 4-Strap, Small	1	200802-04	\$182.00
8e	AV-3000 SureSeal, FaceSeal, 4-Strap, Medium	1	200802-05	\$182.00
8f	AV-3000 SureSeal, FaceSeal, 4-Strap, Large	1	200802-06	\$182.00
9	<b>Left Voicemitter Duct Kit (AV-3000 HT only)</b>	1	201311-02	\$31.30
10	<b>Right Voicemitter Duct Kit (AV-3000 HT only)</b>	1	201311-01	\$31.30
11	<b>NOSECUPS (AV-3000 HT ONLY)</b>			
11a	Nosecup with Red Valves, Small	1	201126-02	\$54.00
11b	Nosecup with Red Valves, Medium	1	201127-02	\$54.00
11c	Nosecup with Red Valves, Large	1	201128-02	\$54.00
12	<b>Inhalation Valve, Red (AV-3000 HT only)</b>	2	31002788	\$4.25
13	<b>Comm Bracket Kit, Right (AV-3000 HT only)*</b>	1	201210-01	\$32.00
14	<b>Comm Bracket Kit, Left (AV-3000 HT only)*</b>	1	201210-02	\$51.00
not shown	<b>Fleece Facepiece Bag</b>	1	805534-01	\$28.75
not shown	<b>Neck Strap Assy</b>	1	804088-02	\$43.30

\* Required with NFPA 1981, 2013 Edition approvals.

\*Includes the temple strap sewn into the headnet.

\*\* Replacement of the temple strap on AV-3000 HT, 5-Strap products produced after August 2015 will require replacement of headnet assembly (P/N 200803-01)

## AV-3000 HT Facepiece

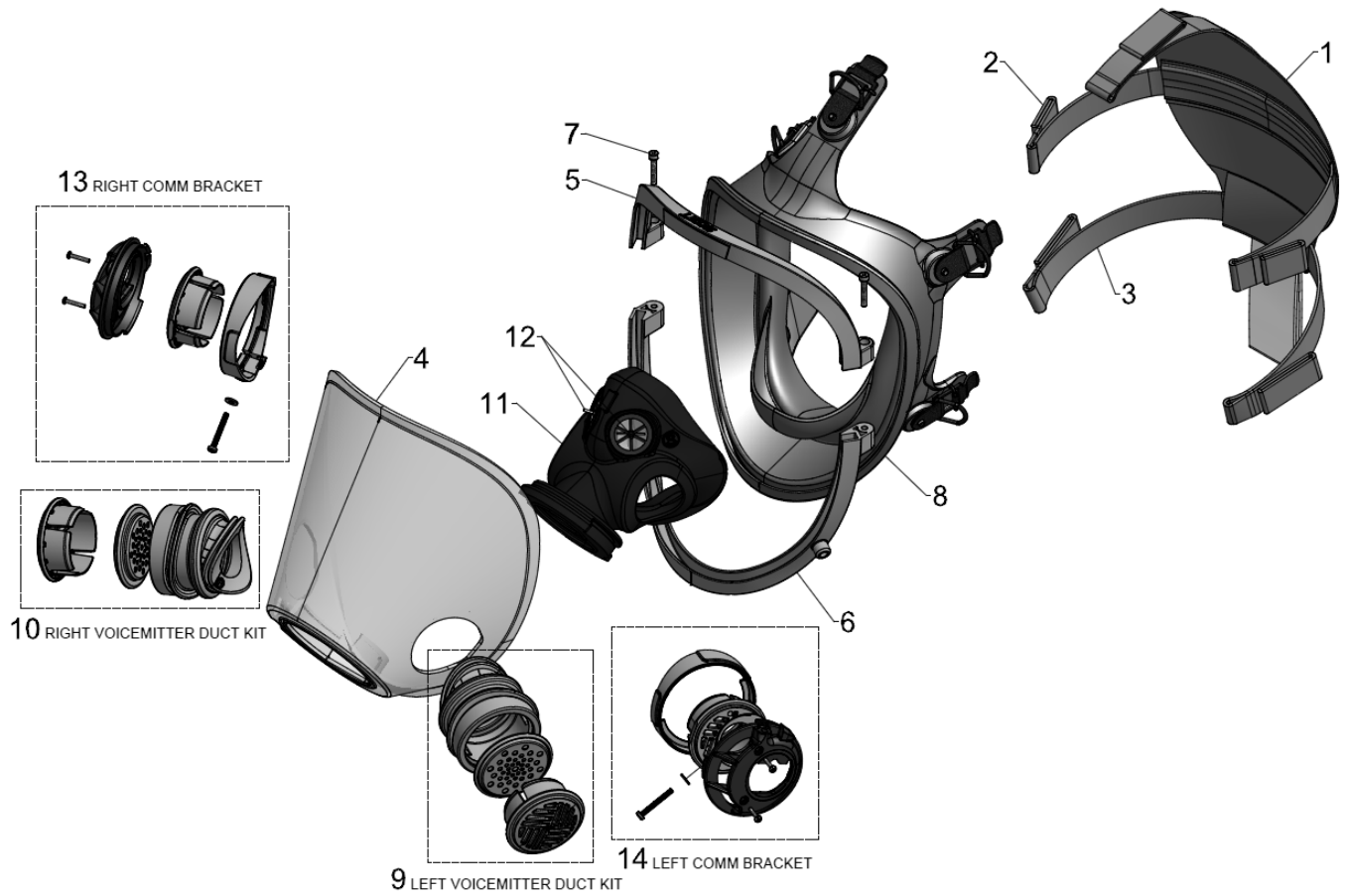







# AV-3000 SureSeal

## SERIES FACEPIECES



The AV-3000 SureSeal Series facepieces are fully interchangeable with the full line of 3M Scott SCBA, air-supplied respirators and air purifying respirators, as well as 3M Scott communications products providing “Top- Down Convertibility” options. It is designed to minimize equipment inventories, simplify the complexities of user training when issued as a single personal issue facepiece and reduce redundant facepiece fit tests.

### AV-3000 Facepiece with SureSeal and Kevlar Head Harness

Part Number	Description	Pieces Per Pkg	Price
805773-81	Small Faceseal, Small Nosecup 	1	\$384.00
805773-82	Medium Faceseal, Medium Nosecup 	1	\$384.00
805773-83	Large Faceseal, Large Nosecup 	1	\$384.00
805773-84	Small Faceseal, Small Nosecup, Comm Bracket 	1	\$416.00
805773-85	Medium Faceseal, Medium Nosecup, Comm Bracket 	1	\$416.00
805773-86	Large Faceseal, Large Nosecup, Comm Bracket 	1	\$416.00





AV-3000 Facepiece with SureSeal and Kevlar Head Harness is NIOSH CBRN APR approved with 40 mm First Responder adapter and CBRN Cap-1 Canister, and with the C420 Plus CBRN PAPR as configured on page 68

### AV-3000 Facepiece with SureSeal and Polyester Head Harness

Part Number	Description	Pieces Per Pkg	Price
805774-81	Small Faceseal, Small Nosecup	1	\$288.00
805774-82	Medium Faceseal, Medium Nosecup	1	\$288.00
805774-83	Large Faceseal, Large Nosecup	1	\$288.00

### AV-3000 Facepiece with SureSeal and Rubber Head Harness

Part Number	Description	Pieces Per Pkg	Price
805775-81	Small Faceseal, Small Nosecup 	1	\$282.00
805775-82	Medium Faceseal, Medium Nosecup 	1	\$282.00
805775-83	Large Faceseal, Large Nosecup 	1	\$282.00



AV-3000 Facepiece with SureSeal and Rubber Head Harness is NIOSH CBRN APR approved with 40 mm First Responder adapter and CBRN Cap-1 Canister

# 3M SCOTT

## AV-3000 Facepiece Parts & Accessories

Item Number	Description	Pieces Per Pkg	Part Number	Price
<b>1</b>	<b>COMPLETE HEAD HARNESS ASSEMBLIES</b>			
1a	Kevlar Head Harness (AV-3000 SureSeal)*	1	200803-01	\$182.00
1b	Kevlar Head Harness SM/MED (AV-3000)	1	805808-01	\$183.00
1c	Kevlar Head Harness LARGE (AV-3000)	1	805808-02	\$183.00
1d	Polyester Head Harness (AV-3000 SureSeal)	1	200965-01	\$83.00
1e	Polyester Head Harness SM/MED (AV-3000)	1	805809-01	\$84.00
1f	Polyester Head Harness LARGE (AV-3000)	1	805809-02	\$84.00
1g	Rubber Head Harness (AV-3000 Sureseal)	1	10008522	\$77.00
1h	Rubber Head Harness, 4 pt (AV-3000)	1	200177-01	\$98.00
<b>2</b>	<b>TEMPLE STRAPS (Fit AV-3000 and AV-3000 SureSeal)</b>			
2a	Kevlar Temple Strap**	1	804178-02	\$25.50
2b	Polyester Temple Strap	1	804061-01	\$20.25
<b>3</b>	<b>NECK STRAPS (Fit AV-3000 and AV-3000 SureSeal)</b>			
3a	Kevlar Neck Strap	1	804176-02	\$25.50
3b	Polyester Neck Strap	1	803920-02	\$19.80
<b>5</b>	<b>AV-3000 Facepiece Lens (Fenestra, Drilled)</b>	1	805345-01	\$141.00
<b>6</b>	<b>Upper Bezel</b>	1	10011024	\$9.75
<b>7</b>	<b>Lower Bezel</b>	1	10011025	\$14.90
<b>8</b>	<b>Bezel Screw</b>	1	33335-022	\$3.00
<b>9</b>	<b>FACEPIECE SEALS</b>			
9a	AV-3000 SureSeal, FaceSeal, Small	1	200802-01	\$202.00
9b	AV-3000 SureSeal, FaceSeal, Medium	1	200802-02	\$202.00
9c	AV-3000 SureSeal, FaceSeal, Large	1	200802-03	\$202.00
9d	AV-3000 Faceseal Small	1	805771-01	\$163.00
9e	AV-3000 Faceseal Medium	1	805771-02	\$163.00
9f	AV-3000 Faceseal Large	1	805771-03	\$163.00
<b>10</b>	<b>Voicemitter</b>	1	803759-01	\$19.80
<b>11</b>	<b>Left Voicemitter Duct</b>	1	10011027	\$11.25
<b>12</b>	<b>Right Voicemitter Duct</b>	1	10011026	\$7.60
<b>13</b>	<b>NOSECUPS (Fit AV-3000 and AV-3000 SureSeal)</b>			
13a	Nosecup Grey Small	1	31001043	\$44.80
13b	Nosecup Grey Medium	1	31001044	\$44.80
13c	Nosecup Grey Large	1	31001045	\$44.80
not shown	Inhalation Check Valve Disk	1	10011014	\$3.75
not shown	Fleece Facepiece Bag	1	805534-01	\$28.75
not shown	EPIC Communications Clamp, Right Side Only		200715-01	\$43.60
not shown	Protective Lens Cover	10	012698	\$36.80
not shown	Neck Strap Assy	1	804088-02	\$43.30

\*Includes the temple strap sewn into the headnet.

\*\*Replacement of the temple strap on AV-3000 SureSeal products produced after August 2015 will require replacement of headnet assembly (P/N 200803-01)

**AV-3000 Series Facepiece Lens Kits Accessories**

Part Number	Description	Price
805753-01	Standard Eyeglass Kit	\$60.00
200372-52F	52mm Wire Frame Eyeglass Kit	\$134.00
200372-60F	60mm Wire Frame Eyeglass Kit	\$134.00

## AV-3000 Facepiece with SureSeal

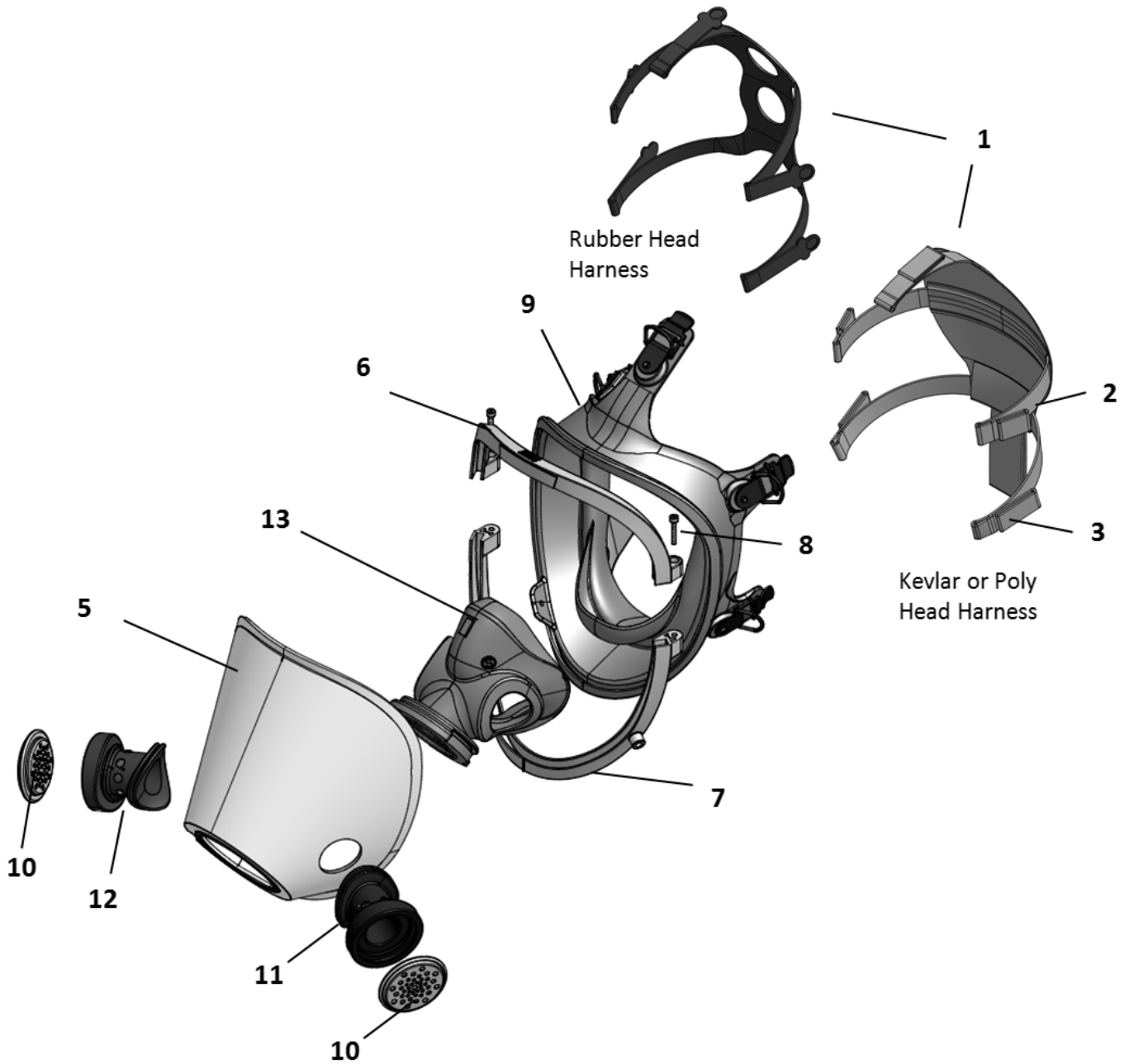





# AV-2000

## FACEPIECE

**TOP-DOWN CONVERTIBILITY™**

The AV-2000 facepiece is fully interchangeable with the full line of 3M Scott SCBA, air-supplied respirators and air purifying respirators, as well as 3M Scott communications products providing "Top-Down Convertibility" options. It is designed to minimize equipment inventories, simplify the complexities of user training when issued as a single personal issue facepiece and reduce redundant facepiece fit tests.

### AV-2000 Facepiece with Kevlar Head Harness

Part Number	Description	Pieces Per Pkg	Price
804191-71	Small Faceseal, Grey Nosecup 	1	\$377.00
804191-72	Large Faceseal, Grey Nosecup 	1	\$377.00
804191-73	X-Large Faceseal, Grey Nosecup 	1	\$377.00
804191-74	Comfort Seal Faceseal, Grey Nosecup 	1	\$377.00



AV-2000 Facepiece with Kevlar Head Harness is NIOSH CBRN APR approved with 40 mm First Responder adapter and CBRN Cap-1 Canister, and with the C420 Plus CBRN PAPR as configured on page 68

### AV-2000 Facepiece with Polyester Head Harness

Part Number	Description	Pieces Per Pkg	Price
804069-19	Small Faceseal, Grey Nosecup	1	\$278.00
804069-20	Large Faceseal, Grey Nosecup	1	\$278.00
804069-21	X-Large Faceseal, Grey Nosecup	1	\$278.00
804069-28	Comfort Seal Faceseal, Grey Nosecup	1	\$278.00

### AV-2000 Facepiece with 4-Point Rubber Head Harness

Part Number	Description	Pieces Per Pkg	Price
805257-19	Small Faceseal, Grey Nosecup	1	\$275.00
805257-20	Large Faceseal, Grey Nosecup	1	\$275.00
805257-21	X-Large Faceseal, Grey Nosecup	1	\$275.00
805257-28	Comfort Seal Faceseal, Grey Nosecup	1	\$275.00

### AV-2000 Facepiece Lens Kits Accessories

Part Number	Description	Price
804442-01	Standard Eyeglass Kit	\$65.00
200371-52F	52mm Wire Frame Eyeglass Kit	\$135.00
200371-60F	60mm Wire Frame Eyeglass Kit	\$135.00

# 3M SCOTT

## AV-2000 Facepiece Parts & Accessories

Item Number	Description	Pieces Per Pkg	Part Number	Price
1	<b>COMPLETE HEAD HARNESS ASSEMBLIES</b>			
1a	Kevlar Head Harness Assembly	1	804177-01	\$193.00
1b	Polyester Head Harness Assembly	1	804063-01	\$86.00
1c	4-Point Rubber Head Harness Assembly	1	805259-01	\$77.00
2	<b>TEMPLE STRAPS</b>			
2a	Kevlar Temple Strap	1	804178-01	\$25.50
2b	Polyester Temple Strap	1	804061-01	\$20.25
3	<b>NECK STRAPS</b>			
3a	Kevlar Neck Strap	1	804176-01	\$25.50
3b	Polyester Neck Strap	1	803920-01	\$20.80
4	<b>Lower Strap Buckle</b>	1	803732-01	\$8.00
5	<b>AV-2000 FACEPIECE LENS</b>	1	804018-01	\$85.00
5a	AV-2000 Facepiece Lens (For Grey nose cup versions)	1	804018-04	\$69.00
6	<b>Lens Frame (Fenestra)</b>	1	10008068	\$15.25
7	<b>FACEPIECE SEALS</b>			
7a	Faceseal, Small (Green)	1	10005913	\$54.00
7b	Faceseal, Large (Black)	1	10005135	\$53.00
7c	Faceseal, X-Large (Red)	1	10006212	\$53.00
7d	Faceseal, Comfort Seal (Black)	1	10009779	\$53.00
9	<b>NOSECUP ASSEMBLY</b>			
9a	AV-2000 Facepiece Nosecup Assembly, Grey	1	31001256	\$60.00
Not shown	AV-2000 Nosecup Conversion Kit*	1	200766-01	\$61.00
10	<b>Inhalation Valves for Gray Nosecup</b>	1	10008383	\$4.30
11	<b>Voicemitter Duct</b>	1	10008400	\$9.50
12	<b>Voicemitter</b>	1	804010-01	\$15.80
Not shown	Fleece Facepiece Bag	1	805534-01	\$28.75
Not shown	Protective Lens Cover	25	803941-25	\$68.00
Not shown	EPIC Communications Clamp, Right (AV-2000)	1	200716-01	\$43.60
Not shown	Neck Strap Assy	1	804088-02	\$43.30

\* Conversion kit includes grey nose cup, label, and upgrade instructions. Only for AV-2000 facepieces manufactured after 2004 (Lot # 050104 or later date indicated on label in chin area)



# AV-2000 Facepiece

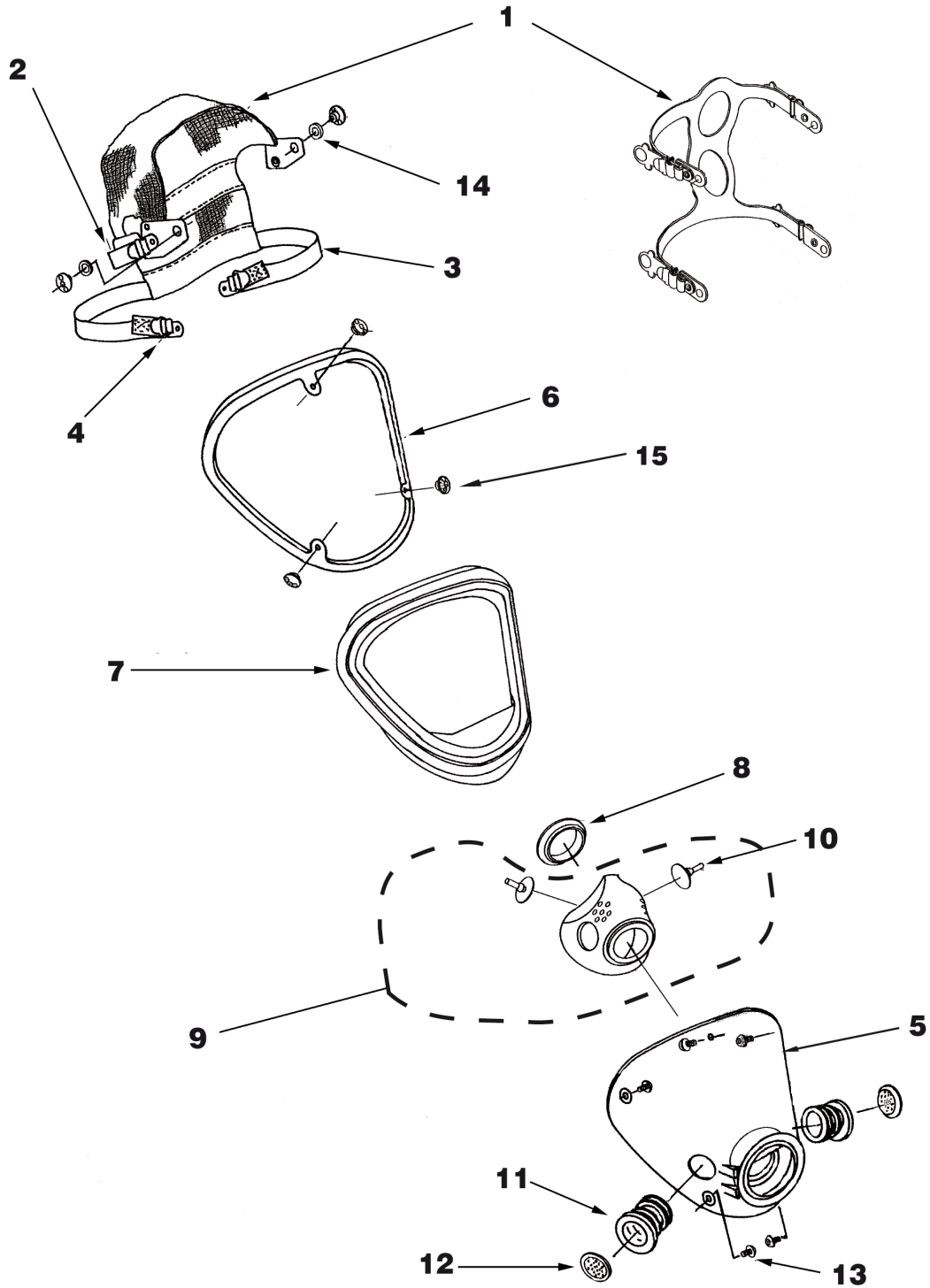

# 3M SCOTT

## WELD-O-VISTA

### FACEPIECE ASSEMBLIES



TOP-DOWN CONVERTIBILITY™

The Weld-O-Vista facepiece is fully interchangeable with the full line of 3M Scott SCBA, air-supplied respirators and air purifying respirators, as well as 3M Scott communications products providing "Top- Down Convertibility" options. It is designed to minimize equipment inventories, simplify the complexities of user training when issued as a single personal issue facepiece and reduce redundant facepiece fit tests.

#### Weld-O-Vista Facepiece with Kevlar Head Harness

Part Number	Description	Pieces Per Pkg	Price
805438-01	Small Faceseal	1	\$460.00
805438-02	Large Faceseal	1	\$460.00
805438-03	X-Large Faceseal	1	\$460.00
805438-08	Comfort Seal Faceseal	1	\$460.00

#### Weld-O-Vista Facepiece with Rubber Head Harness

Part Number	Description	Pieces Per Pkg	Price
805438-21	Small Faceseal	1	\$403.00
805438-22	Large Faceseal	1	\$403.00
805438-23	X-Large Faceseal	1	\$403.00
805438-28	Comfort Seal Faceseal	1	\$403.00

#### Weld-O-Vista Facepiece Lens Kits Accessories

Part Number	Description	Price
804442-01	Standard Eyeglass Kit	\$65.00
200371-52F	52mm Wire Frame Eyeglass Kit	\$135.00
200371-60F	60mm Wire Frame Eyeglass Kit	\$135.00

**Weld-O-Vista Facepiece Parts & Accessories**

Item Number	Description	Pieces Per Pkg	Part Number	Price
1	<b>HEAD HARNESSES</b>			
1a	Kevlar Head Harness Assembly	1	804177-01	\$193.00
1b	4-Point Rubber Head Harness Assembly	1	805259-01	\$77.00
2	<b>TEMPLE STRAPS</b>			
2a	Kevlar Temple Strap	1	804178-01	\$25.50
3	<b>NECK STRAPS</b>			
3a	Kevlar Neck Strap	1	804176-01	\$25.50
4	<b>Lower Buckle Strap</b>	1	803732-01	\$8.00
5	<b>Lens Frame</b>	1	10008068	\$15.25
6	<b>FACEPIECE SEALS</b>			
6a	Faceseal, Small (Green)	1	10005913	\$54.00
6b	Faceseal, Large (Black)	1	10005135	\$53.00
6c	Faceseal, X-Large (Red)	1	10006212	\$53.00
6d	Faceseal, Comfort Seal (Black)	1	10009779	\$53.00
7	<b>Nosecup Retaining Ring</b>	1	10008398	\$4.30
8	<b>Nosecup Assembly</b>	1	804014-01	\$123.00
9	<b>INHALATION VALVES</b>			
10	<b>LENS ASSEMBLIES</b>			
10a	Weld-O-Vista Assembly (Lens with VM, Lens Holder, Nosecup)	1	805574-01	\$315.00
10b	Weld-O-Vista Lens Assembly Kit (Lens and Lens Holder)	1	805537-01	\$237.00
11	<b>Voicemitter Duct</b>	1	10008400	\$9.50
12	<b>Voicemitter</b>	1	804010-01	\$15.80
13	<b>Lens Holder Assembly</b>	1	805182-02	\$71.00
14	<b>Lens Separator &amp; Lens Retainer Kit</b>	1	805536-01	\$14.10
Not Shown	Fleece Facepiece Bag	1	805534-01	\$28.75

## Weld-o-Vista Facepiece

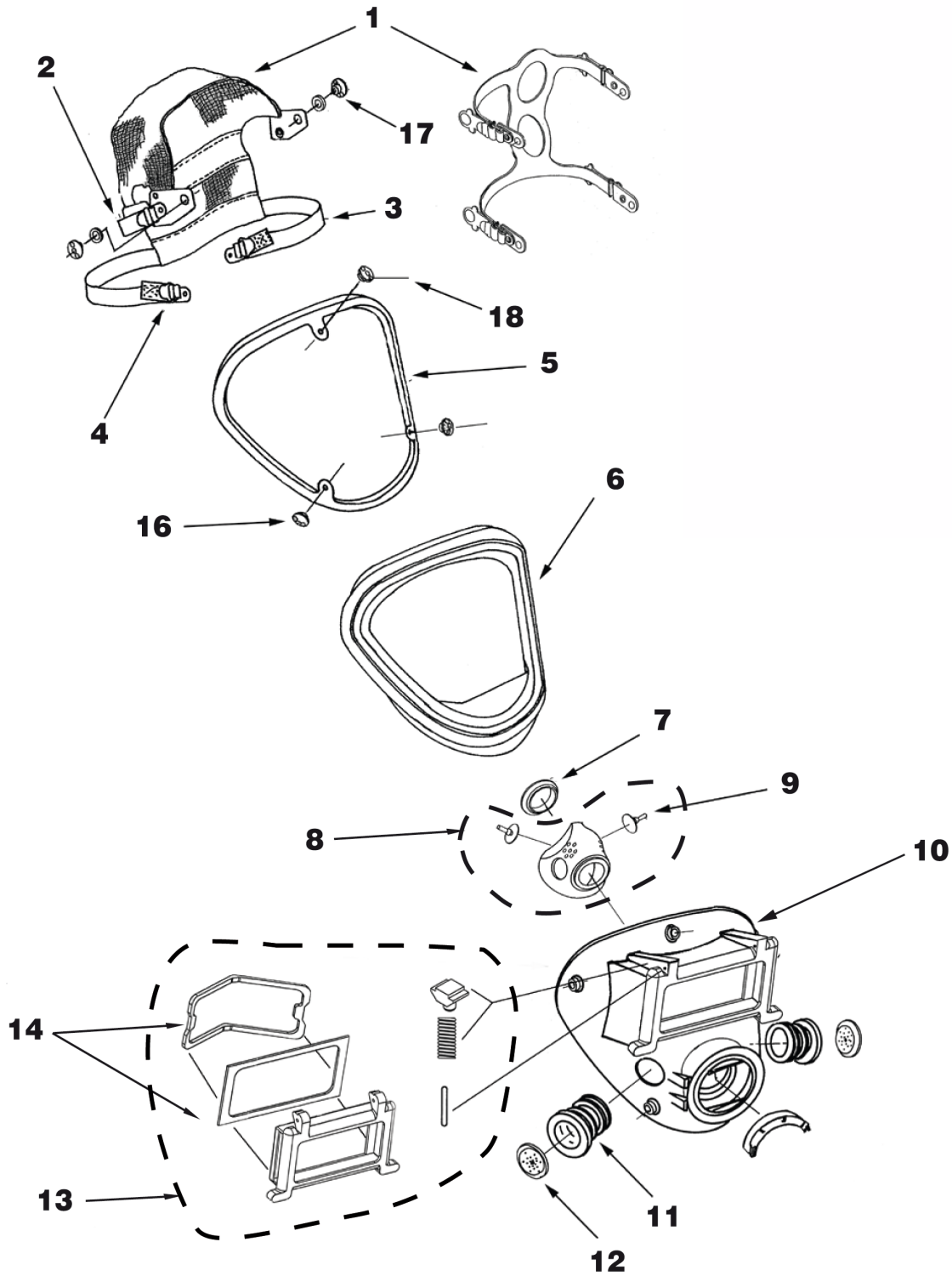





# FRR

## FIRST RESPONDER RESPIRATOR



### FRR Respirator

Part Number	Description	Price
201339-01	Size 1 (L) 	\$387.00
201339-02	Size 2 (L/M) 	\$387.00
201339-03	Size 3 (M) 	\$387.00
201339-04	Size 4 (S) 	\$387.00

### Canister

Part Number	Description	Price
045135	CBRN CAP 1 Canister 	\$60.00
8004109	TAC 1 Cartridge	\$42.00
805557-01	MPC Plus Cartridge	\$26.30
052683	40mm P100 (HEPA) Cartridge	\$12.60

### Accessories

Part Number	Description	Price
201353-01	Spectacle Kit Assembly	\$56.65
201355-03	Lens Kit, Laser	\$63.00
201355-01	Lens Kit, Tint	\$56.65
201355-02	Lens Kit, Clear	\$55.36
201355-05	Lens Kit, Blueblocker	\$56.65



FRR Respirator is NIOSH CBRN APR approved when used with CBRN Cap-1 canister.





# 3M SCOTT

## M110

### CBRN DUAL LENS FACEPIECE

#### M110 CBRN Dual Lens Facepiece



Part Number	Description	Price
013262	Medium/Large 	\$298.00
013282	Medium/Large with Drinking Device 	\$332.00
013242	Small 	\$298.00
013222	Small with Drinking Device 	\$332.00

#### Canister

Part Number	Description	Price
045135	CBRN CAP 1 Canister 	\$60.00
805557-01	MPC Plus Cartridge	\$26.30
052683	40mm P100 (HEPA) Cartridge	\$12.60
045123	Enforcement Cartridge	\$40.00

#### Accessories

Part Number	Description	Price
200374-54F	54mm Wire Split-Frame Eyeglass Kit	\$135.00
012593	Drinking Bottle	\$32.10
012592	Speech Diaphragm	\$7.75
1001882	Tactical Facepiece Bag with Belt Mounting	\$110.00
10012151	Shoulder Strap for Tactical Facepiece Bag	\$24.00
10012152	Leg Strap for Tactical Facepiece Bag	\$17.00
805534-01	Fleece Facepiece Bag	\$28.75

#### Replacement Parts

Part Number	Description	Pieces Per Pkg	Price
012577	Exhalation valve set assembly	1	\$8.10
012774	Inhalation valve discs, set of four (4)	4	\$12.80
013372	Inhalation valve seats, set of two (2)	2	\$10.60
012574	Nose cup for regular M110	1	\$43.60
012575	Nose cup for small M110	1	\$44.40
012773	Nose cup valve seats, set of two (2)	2	\$6.10
012598	Head harness	1	\$33.00
012592	Speech diaphragm plug	8	\$7.75
012594	Mouthpiece, drinking device (if equipped)	1	\$7.50
012597	Lid, drinking device (if equipped)	10	\$8.50





CBRN approved when used with Cap 1 Canister

# M120

## CBRN FACEPIECE



### M120 CBRN Facepiece

Part Number	Description	Price
013013	Medium/Large 	\$287.00
013014	Small 	\$287.00

### Canister

Part Number	Description	Price
045135	CBRN CAP 1 Canister 	\$60.00
805557-01	MPC Plus Cartridge	\$26.30
052683	40mm P100 (HEPA) Cartridge	\$12.60
045123	Enforcement Cartridge	\$40.00

### Accessories

Part Number	Description	Price
012798	Standard Eyeglass Kit	\$26.10
10011882	Tactical Facepiece Bag with Belt Mounting	\$110.00
10012151	Shoulder Strap for Tactical Facepiece Bag	\$24.00
10012152	Leg Strap for Tactical Facepiece Bag	\$17.00
805534-01	Fleece Facepiece Bag	\$28.75

### Replacement Parts

Part Number	Description	Price
012577	Exhalation Valve Set Assembly	\$8.10
013372	Inhalation Valve Seats (EPDM), Set of two (2)	\$10.60
012773	Nosecup Valve Seats, set of two (2)	\$6.10
012774	Valve Discs, set of four (4)	\$12.80
012776	Nosecup w/Fastening Ring	\$40.40
012692	Head harness (ribbed)	\$33.60
013377	40mm Plug	\$3.40
012694	Harness Buckles, set of five (5)	\$9.60



The M120 Facepiece is NIOSH CBRN APR approved with the CBRN Cap-1 canister, and with the C420 Plus CBRN PAPP as configured on page 68



# 3M SCOTT

## FACEPIECE ADAPTERS

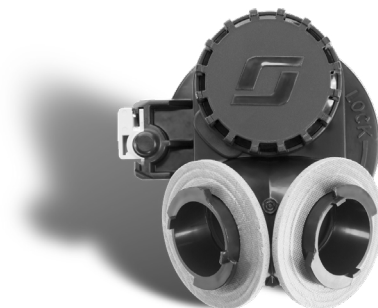
FOR CARTRIDGES & CANISTERS



### Facepiece Adapters

Part Number	Description	Pieces Per Pkg	Price
805622-01	742 Series Twin Cartridge 1/4 Turn Adapter	1	\$53.00
805059-01	40mm Cartridge Adapter	1	\$53.00
200423-01	40mm First Responder Adapter 	1	\$79.00
*200423-02	40mm First Responder Adapter 	1	\$68.00
10011688	Exhalation Cover for 805622-01	1	\$10.40

\*Required for use with the AV-3000 HT facepiece

### Quantitative Fit Testing Adapters for use with TSI PortaCount (for pricing, see page 70)

Facepiece to be Fit Tested	Quantitative Fit Test Probe Adapter Required	Filter Required	Facepiece Adapter Required
742 Cartridge Series	7422-FT1	7422-FP1	805622-01
Xcel Half Mask	●	●	
Promask 25	●	●	
AV-2000, AV-3000 Series, Weld-O-Vista	●	●	●
40mm Cartridge Series	805628-01	052683	805059-01
AV-2000, AV-3000 Series, Weld-O-Vista	●	●	●
M110, M120	●	●	

### Quantitative Fit Testing Adapters for use with Fit Tester 3000

Facepiece to be Fit Tested	Quantitative Fit Test Probe Adapter Required	Filter Required	Facepiece Adapter Required
742 Cartridge Series	805816	7422-FP1	805622-01
AV-2000, AV-3000 Series, Weld-O-Vista	●	●	●



## 742 SERIES

### FILTERS & CARTRIDGES



#### 742 Series Twin Filter and Chemical Cartridges

Part Number	Description	Pieces Per Pkg	Price
7422-BA1	Organic Vapor	1 Pair	\$15.50
7422-BB1	Organic Vapor/P100	1 Pair	\$29.80
7422-CD1	Tear Gas /P100	1 Pair	\$36.10
7422-FP1	P100 Filter	1 Pair	\$13.40
7422-FP4	P100 Filter (Carton of 80 Pair)	80 pair	\$1,030.00
7422-FN5	Particulate N95 stand alone filter (case of 50 pair)	50 pair	\$188.00
7422-GA1	Ammonia/Methylamine	1 Pair	\$16.60
7422-GB1	Ammonia/Methylamine/P100	1 Pair	\$30.80
7422-PD1	TEDA-P100	1 Pair	\$46.60
7422-SC1	Multi-Purpose	1 Pair	\$17.50
7422-SD1	Multi-Purpose / P100	1 Pair	\$30.90
7422-WA1	Acid Gas	1 Pair	\$15.50
7422-WB1	Acid Gas/P100	1 Pair	\$30.90
7422-YC1	Organic Vapor/ Acid Gas	1 Pair	\$16.50
7422-YD1	Organic Vapor / Acid Gas / P100	1 Pair	\$30.80
7422-MA1	Mercury Vapor/Chlorine Gas	1 Pair	\$30.90
7422-MB1	Mercury Vapor/Chlorine Gas/P100	1 Pair	\$43.10

#### Particulate Filter Accessories

Part Number	Description	Price
7422-FE4	N95 Filter Cover + Retainer, Reusable (5 pair of 7422-FE1). Holds the N95 filter for stand alone use.	5 pair \$108.00
7422-FC4	N95 Filter Covers, Reusable (5 pair of 7422-FC1). Cover attaches N95 to chemical cartridge.	5 pair \$75.00

#### Fit Check Seal Kit

Part Number	Description	Price
7422-FG4	Box of 5 pair of 7422-FG1 (Reusable filter cover + gasket) Facilitates negative pressure leak check with chemical cartridges	5 pair \$131.00

# 3M SCOTT

## 40mm SERIES

CARTRIDGES & CANISTERS



### 40mm Series Canisters

Part Number	Description	Pieces Per Pkg	Price
805557-01	MPC Plus Cartridge	1	\$26.30
052683	40mm P100 (HEPA) Cartridge	1	\$12.60
045123	Enforcement Cartridge	1	\$40.00
045135	CBRN Cap-1 Canister 	1	\$60.00
8004109	TAC 1 Cartridge	1	\$42.00
045170	MPC40PF Cartridge	1	\$28.40

# SPEED-EVAC

## MOUTHBIT RESPIRATOR



### Speed-Evac 90 Series Mouthbit Respirators

Part Number	Description	Pieces Per Pkg	Price
803834-01	Acid Gas, With Pouch	1	\$35.75
803834-03	Acid Gas, With Case	1	\$54.00
803834-30	Acid Gas, With Pouch	30	\$1,080.00
803834-32	Acid Gas, With Case	30	\$1,600.00
803839-01	Ammonia, With Pouch	1	\$35.75
803839-03	Ammonia, With Case	1	\$54.00
803839-30	Ammonia, With Pouch	30	\$1,080.00
803839-32	Ammonia, With Case	30	\$1,600.00

### Speed-Evac 90 Series Mouthbit Respirators Part and Accessories

Part Number	Description	Pieces Per Pkg	Price
10007997	Mouthbit Noseclip	1	\$2.40
10008212	Mouthbit Replacement Bag	1	\$2.00
10008221	Mouthbit Belt Clip Retainer	1	\$2.30

# 3M SCOTT

## C420 PLUS

POWERED AIR PURIFYING RESPIRATOR



### C420 Plus

	Blower	LiSO2 Battery	Decon Belt	30" CBRN Breathing Tube (use with M120)	36" CBRN Breathing Tube (use with M120)	30" CBRN AV-PAPR Hose (Use with AV-Facepieces*)	36" CBRN AV-PAPR Hose (Use with AV-Facepieces*)	Price
Part No:	200699-01	805358-01	805359-01	200700-30	200700-36	200829-30	200829-36	

### C420 Plus PAPR Blowers:

200699-01	●							\$1,140.00
200698-00	●		●					\$1,210.00

### C420 CBRN\*\* PAPR Kits:

*For use with M120 Facepiece (sold separately)*

200698-30	●		●	●				\$1,290.00
200698-36	●		●		●			\$1,290.00
200710-30	●	●	●	●				\$1,400.00
200710-36	●	●	●		●			\$1,400.00

*For use with AV-2000, AV-3000 SureSeal, or AV-3000 HT Facepieces (sold separately)*

200830-30	●		●			●		\$1,210.00
200830-36	●		●				●	\$1,210.00
200833-30	●	●	●			●		\$1,420.00
200833-36	●	●	●				●	\$1,420.00

\*AV-PAPR hose connects directly to AV-series facepieces.

\*\*The C420 Plus PAPR is also approved for NIOSH non-CBRN applications; Additional configurations are available

### CBRN Canister:

Part Number	Description	Price
045135	CBRN Cap-1 Canister 	\$60.00

### Other NIOSH approved canisters:

Part Number	Description	Price
045170	MPC40PF	\$28.40
045123	Enforcement Cartridge	\$40.00
052683	40mm P100 (HEPA) Cartridge	\$12.60

**C420 Plus Powered Air Purifying Respirators (PAPR) Parts & Accessories**

Part Number	Description	Pieces Per Pkg	Price
	<b>FACEPIECE</b>	See pages 51-63	
See Pg 63	M120	1	
See Pg 48	AV-3000 HT with Kevlar Head Harness	1	
See Pg 51	AV-3000 with SureSeal with Kevlar Head Harness	1	
See Pg 55	AV-2000 with Grey Nosecup and Kevlar Head Harness	1	
	<b>Breathing Tubes</b>		
200700-30	30" Breathing Tube for M120	1	\$141.00
200700-36	36" Breathing Tube for M120	1	\$141.00
200829-30	30" AV-PAPR Breathing Tube for approved AV-Facepieces	1	\$189.00
200829-36	36" AV-PAPR Breathing Tube for approved AV-Facepieces	1	\$194.00
	<b>C420 Plus PAPR Blower Unit</b>		
200698-00	C420 Plus PAPR Blower Kit (Blower, decon belt, airflow indicator)	1	\$1,210.00
200699-01	C420 Plus PAPR Blower only	1	\$1,140.00
805359-01	Decontamination Belt	1	\$93.00
805374-01	Airflow Indicator	1	\$40.80
	<b>BATTERIES, C420 Plus</b>		
805358-01	LiSO2 Battery	1	\$153.00
31002361	(Black) End cap for LiSO2 Battery		\$49.30
200701-01	NiMH Rechargeable Battery Conversion Kit, (Single Bank Charger, NiMH Battery, End Cap)	1	\$530.00
31001504	NiMH Rechargeable Battery Pack	1	\$221.00
31001506	(Green) End Cap for NiMH Rechargeable Battery	1	\$49.30
200703-01	Single Unit Battery Recharger	1	\$268.00
	<b>CARRY CASE</b>		
31000578	Scott duffle bag carry case	1	\$53.00
See Previous Page	<b>CARTRIDGES AND CANISTERS</b>		

# 3M SCOTT

## BITREX

### QUALITATIVE FIT TEST KIT

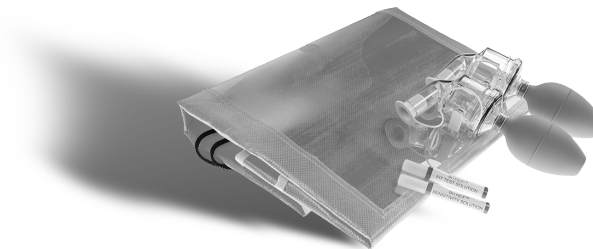

#### Bitrex Qualitative Fit Test Kit

Part Number	Description	Pieces Per Pkg	Price
2017070	Bitrex Qualitative Fit Test Kit	1	\$272.00

#### Bitrex Qualitative Fit Test Kit - Spare Parts

Part Number	Description	Pieces Per Pkg	Price
2017093	Fit Test Solution Applicator Kit (6 ampoules/box)	6	\$26.30
2017092	Sensitivity Solution Applicator Kit (6 ampoules/box)	6	\$26.30
2017094	Nebulizer	1	\$95.00
2017095	Test Hood	1	\$38.60

#### Fit Test Parts For Use With 742 Series Twin Cartridges

Part Number	Description	Pieces Per Pkg	Price
805622-01	742 Series Twin Cartridge 1/4 Turn Adapter	1	\$53.00
7422-FP1	P100 Filter, 742 Series	1	\$13.40
7422-BA1	Organic Vapor Cartridges, 742 Series	1	\$15.50

#### Fit Test Parts and Accessories For Use With 40mm Series Canisters

Part Number	Description	Pieces Per Pkg	Price
805059-01	40mm Canister Adapter	1	\$53.00
052683	40mm P100 (HEPA) Cartridge	1	\$12.60

# HUSHAIR CONNECT 7500 & REVOLVEAIR CONNECT

## COMPRESSOR SYSTEMS

### How To Order A Compressor System

#### Step 1 - Choose Your Compressor



HP	Power Options	Part Number	Price
10	208v/3ph/60Hz	8004557	\$32,960.00
10	230v/3ph/60Hz	8004854	\$32,960.00
10	208v/1ph/60Hz	8004856	\$33,580.00
10	230v/1ph/60Hz	8004858	\$33,580.00
10	460v/3ph/60Hz	8004864	\$32,960.00
20	208v/3ph/60Hz	8004553	\$43,260.00
20	230v/3ph/60Hz	8004876	\$43,260.00
20	460v/3ph/60Hz	8004882	\$43,260.00

#### Step 2 - Choose Your Charge Station



Pressure Options	RFID	Part Number	Price
Dual-Pressure	RFID	8004442	\$27,190.00
Dual-Pressure	Non-RFID	8004891	\$23,000.00
Multi-Pressure	RFID	8004440	\$28,230.00
Multi-Pressure	Non-RFID	8004894	\$24,050.00

\* When selecting the charge station part number above, please specify the desired preset pressures, i.e. 2216psi, 3000psi, 4500psi, or 5500psi. For clarification, dual-pressure can be configured with any two of the aforementioned pressures and multi-pressure can be configured with any three of the aforementioned pressures.

#### Step 3 - Choose Your Storage



Storage Options	Part Number	Price
4 Bank ASME storage	8004260	\$15,870.00
3 Bank ASME storage	8004886	\$12,950.00
2 Bank ASME storage	8004888	\$10,040.00

**NOTE:** For ordering purpose, **you must select a compressor, charge station and storage option.** Individual components are not available. Smart Fill auto-cascade is standard on all charge stations.

# 3M SCOTT

## REVOLVEAIR CHARGE STATIONS



### Charge Stations Price Configurator

Model	Price	Base	Price	Fill Panel	Price	Dual Pressure	Price	Auxiliary Low Pressure	Price	Auxiliary High Pressure	Price	Cutout	Price	Cascade Panel	Price	Options	Price							
2 RevolveAir	\$9,080	1	Yes	N/C	0	None	N/C	0	None	N/C	1	Yes	\$1,090	1	Yes	N/C	0	0	None	N/C	0	1	CGA Adapter	N/C
3 RevolveAir Mobile	\$9,080	2	No	N/C	1	Stationary	\$780	1	2.5 & 4.5	\$1,710	2	No	N/C	2	No *	N/C	0	2	2 Bank	\$1,310	0	2	DIN Adapter	N/C
					2	Mobile	\$780	2	2.5 & 5.5	\$1,710				3	No **	N/C	0	3	3 Bank	\$1,830	1	1	SCUBA Adapter/ RevolveAir & CGA	\$340
																	0	4	4 Bank	\$2,250	1	2	SCUBA Adapter/ RevolveAir & DIN	\$340
																	0	5	5 Bank	\$2,840				
																	0	6	6 Bank	\$3,360				
																	A	0	Auto NO storage	\$4,880				
																	A	4	with storage	\$4,880				

**Part Number:**  
Select one number per box from the chart above that corresponds to your choice

AF																	
----	--	--	--	--	--	--	--	--	--	--	--	--	--	--	--	--	--

**Price:**  
Select the price that corresponds to the number selected above

--	--	--	--	--	--	--	--	--	--	--	--	--	--	--	--	--	--

**Total:**  
Add up all prices to the left

--

**Example**  
RevolveAir Mobile;  
with No Base;  
with Mobile Fill Panel;  
with Dual Pressure;  
with Auxiliary Low Pressure;  
with No Auxiliary High Pressure;  
with Cutout;  
with 5 Bank Cascade Panel;  
with SCUBA Adapter / RevolveAir & CGA

AF	3	2	2	1	1	2	1	0	5	1	1
	\$9,080	\$0	\$780	\$1,710	\$1,090	\$0	\$0	\$2,840	\$340		

\$15,840
----------

This price configurator is a guide to 3M Scott breathing air systems product part numbers. Not all part numbers configured with this chart can be manufactured. Please confirm part numbers with 3M Scott Customer Service Department, a 3M Scott Specialist, or your local 3M Scott Authorized Distributor of breathing air systems.

\* No (Stand Alone -No Compressor)  
\*\* No (Charge Station- Wall Mount)



# SIMPLEAIR & HUSHAIR

## COMPRESSORS



### Stationary & Horizontal Compressors Price Configurator

Model	Price	Voltage/Phase/Hz	Price	Horsepower	Price	Controller	Price	Frame	Price	Color	Price	Language	Price	Options	Price
0 3 Simple Air / 6000 psi / 1 Phase	\$20,570	0 1 208 Volt / 1 Phase/ 60Hz	N/C	1 5 HP	\$570	1 Basic	\$800	1 Open	N/C	1 Blue/White	N/C	1 English	N/C	0 None	N/C
0 4 Simple Air / 6000 psi / 3 Phase	\$19,910	0 2 230 Volt / 1 Phase/ 60Hz	N/C	2 7.5 HP	\$670	2 CO Monitor	\$2,330	2 Simple Enclosed	\$3,410			2 Spanish	N/C	1 Wall Mount	N/C
0 5 Hush Air / 6000 psi	\$30,170	0 3 208 Volt / 3 Phase/ 60Hz	N/C	3 10 HP	\$1,150	3 Dew Point	\$1,540	3 Hush Enclosed	\$3,650					2 Moisture Indicator	\$210
		0 4 230 Volt / 3 Phase/ 60Hz	N/C	4 15 HP	\$1,580	4 CO & Dew Point	\$3,870	4 Open/Remote Air Simple	\$160					3 Wall M. W/Moist.Ind	\$210
		0 5 460 Volt / 3 Phase/ 60Hz	N/C	5 20HP	\$2,200	5 CO Monitor *	\$2,680	4 Open/Remote Air Hush	\$270						
		0 7 380 Volt / 3 Phase/ 50Hz	N/C			6 CO & Dew Point *	\$4,210	5 Simple Enclosed/ Remote Air	\$3,420						
		0 8 415 Volt / 3 Phase/ 50Hz	N/C					6 Hush Enclosed/ Remote Air	\$3,900						

**Part Number:**

Select one number per box from the chart above that corresponds to your choice

AC															
----	--	--	--	--	--	--	--	--	--	--	--	--	--	--	--

**Price:**

Select the price that corresponds to the number selected above

--	--	--	--	--	--	--	--	--	--	--	--	--	--	--	--

**Total:**  
Add up all prices to the left

--

**Example**  
SimpleAir / 6000 psi / 3 Phase Model  
with 230 Volt / 3 Phase / 60 Hz;  
with 10 HP;  
with CO & Dew Point Controller;  
with Simple Enclosed Frame;  
with Blue/White Color;  
in English;  
with no Options

AC	0	4	0	4	3	4	2	1	1	0
	\$19,910		\$0	\$1,150	\$3,870	\$3,410	\$0	\$0	\$0	

\$28,340
----------

This price configurator is a guide to 3M Scott breathing air systems product part numbers. Not all part numbers configured with this chart can be manufactured. Please confirm part numbers with 3M Scott Customer Service Department, a 3M Scott Specialist, or your local 3M Scott Authorized Distributor of breathing air systems.

\* with calibration kit

### OEM Liberty Slip-In System

For an OEM Liberty Slip-In compressor solution for emergency apparatus, please contact 3M Scott Tech Support. Technicians will provide the necessary drawings and specification needed to ensure a proper installation in your apparatus. A wide variety of options are available.

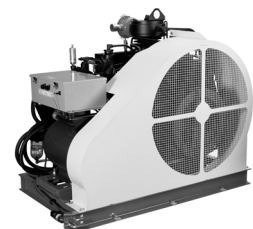

# 3M SCOTT

## ASME & UN CYLINDERS

HIGH PRESSURE STORAGE OPTIONS

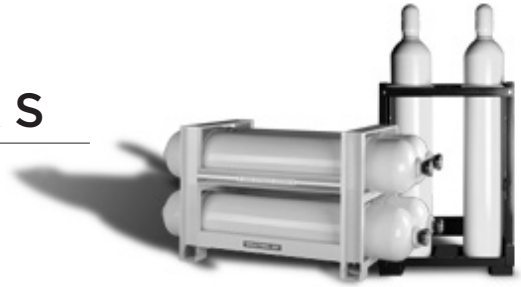

### Storage & Racks Price Configurator

Cylinder Type	Price	Rack	Price	Quantity	Price (ASME 6000 psi)	Price (UN 5000 psi)	Price (UN 6000 psi)	Plumbing & Quantity	Price	Hoses	Price	Options	Price
1 ASME 6000 psi	N/C	1 Wall 2	\$250	0 0	None	N/C	N/C	N/C	0 0	None	N/C	0 without Charge Station	N/C
3 UN 5000 psi	N/C	2 Wall 4	\$370	0 1	One	\$2,730	\$1,140	\$1,890	A 4	4 Auto Cascade	\$400	1 with RevolveAir**	N/C
4 UN 6000 psi	N/C	3 Vertical Back 2	\$1,520	0 2	Two	\$5,660	\$2,350	\$3,430	B 1	1 Bulk	N/C		
		4 Vertical Back 4	\$2,000	0 3	Three	\$8,020	\$3,530	\$4,640	B 2	2 Bulk	N/C		
		5 Vertical Stand Alone 2	\$1,520	0 4	Four	\$10,910	\$4,680	\$7,040	B 3	3 Bulk	N/C		
		6 Vertical Stand Alone 4	\$2,000	0 5	Five	\$13,180	N/A	N/A	B 4	4 Bulk	N/C		
		7 Horizontal 2	\$1,680	0 6	Six	\$16,100	N/A	N/A	B 5	5 Bulk	N/C		
		8 Horizontal 4	\$1,790						B 6	6 Bulk	N/C		
		9 Horizontal 6	\$2,180						C 2	2 Cascade	\$160		
									C 3	3 Cascade	\$220		
									C 4	4 Cascade	\$280		
									C 5	5 Cascade	\$400		
									C 6	6 Cascade	\$410		

**Part Number:**  
Select one number per box from the chart above that corresponds to your choice

AR									
----	--	--	--	--	--	--	--	--	--

**Price:**  
Select the price that corresponds to the number selected above

--	--	--	--	--	--	--	--

**Total:**  
Add up all prices to the left

--

\* Bulk systems require one hose, cascade systems require one hose per bank  
\*\* Options 1 & 2 only required with Rack selection (3) Vertical Back 2 or (4) Vertical Back 4

Example

**DOT 5000 psi Model**  
Four Quantity;  
with Wall4 Rack;  
with 4 Bulk Plumbing;  
with 20 Foot Hose;  
with no Options

AR	3	2	0	4	B	4	2	0	0
	\$0	\$370	\$4,680		\$0	\$0	\$0		

\$5,050
---------

This price configurator is a guide to 3M Scott breathing air systems product part numbers. Not all part numbers configured with this chart can be manufactured. Please confirm part numbers with 3M Scott Customer Service Department, a 3M Scott Specialist, or your local 3M Scott Authorized Distributor of breathing air systems.

# NOTES

---



P.O. Box 569  
Monroe, NC 28111  
Telephone: 800.247.7257  
Facsimile: 704.291.8330  
[www.3m-scott.com](http://www.3m-scott.com)  
[US-3M-ScottMonroeCSR@mmm.com](mailto:US-3M-ScottMonroeCSR@mmm.com)  
01.19