



Local Public Agency Formal Contract

Contractor's Name			
Alliance Contractors, Inc.			
Contractor's Address	City	State	Zip Code
1166 Lake Avenue	Woodstock	IL	60098

STATE OF ILLINOIS

Local Public Agency	County	Section Number
Village of Buffalo Grove	Lake	N/A
Street Name/Road Name	Type of Funds	
Various Street Segments	LOCAL	

CONTRACT BOND (when required)

<b>For a County and Road District Project</b>
Submitted/Approved
Highway Commissioner Signature & Date
Submitted/Approved
County Engineer/Superintendent of Highways Signature & Date

<b>For a Municipal Project</b>
Submitted/Approved/Passed
Signature & Date
4/27/2023
Official Title
Director of Public Works

<b>Department of Transportation</b>
<input type="checkbox"/> Concurrence in approval of award
Regional Engineer Signature & Date

Local Public Agency	Local Street/Road Name	County	Section Number
Village of Buffalo Grove	Various Street Segments	Lake	N/A

1. THIS AGREEMENT, made and concluded the 20th day of March 2023 between the Village of Buffalo Grove, known as the party of the first part, and Alliance Contractors, Inc., its successor, and assigns, known as the party of the second part.

2. For and in consideration of the payments and agreements mentioned in the Proposal hereto attached, to be made and performed by the party of the first part, and according to the terms expressed in the Bond referring this contract, the party of the second part agrees with said party of the first part, at its own proper cost and expense, to do all the work, furnish all materials and all labor necessary to complete the work in accordance with the plans and specifications hereinafter described, and in full compliance with all of the terms of this contract.

3. It is also understood and agreed that the LPA Formal Contract Proposal, Special Provisions, Affidavit of Illinois Business Office, Apprenticeship or Training Program Certification, and Contract Bond hereto attached, and the Plans for Section N/A in Village of Buffalo Grove, approved by the Illinois Department of Transportation on N/A documents of this contract and are a part hereof.

4. IN WITNESS WHEREOF, the said parties have executed this contract on the date above mentioned.

Attest: The Village of Buffalo Grove

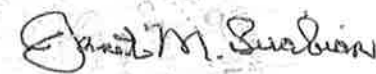
Clerk Signature & Date  

(SEAL, if required by the LPA)

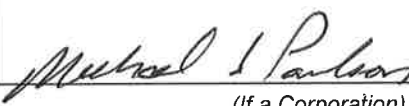
Party of the <sup>Second</sup> First Part Signature & Date  
 By:   
 (If a Corporation)

Corporate Name  
Alliance Contractors, Inc

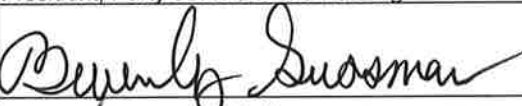
President, Party of the <sup>First</sup> Second Part Signature & Date  
 By:   
 (If a Limited Liability Corporation)  
 LLC Name

(SEAL, if required by the LPA)

Village of Buffalo Grove

Manager or Authorized Member, Party of the Second Part  
 By:   
 (If a Partnership)

Attest:  
 Secretary Signature & Date  
 4/11/23

(SEAL, if required by the LPA)

Partner Signature & Date  

Partner Signature & Date  

Partners doing Business under the firm name of  
 Party of the Second Part  

(If an individual)  
 Party of the Second Part Signature & Date  



Contract Bond

Local Public Agency	County	Street Name/Road Name	Section Number
Village of Buffalo Grove	Lake	Various Street Segments	N/A

Bond information to be returned to Local Public Agency at 51 Raupp Blvd, Buffalo Grove, IL 60089  
Complete Address

We, Alliance Contractors, Inc., 1166 Lake Avenue, Woodstock, IL 60098  
Contractor's Name and Address

a/an Corporation organized under the laws of the State of Delaware as PRINCIPAL, and  
State

Travelers Casualty and Surety Company of America, One Tower Square, Hartford, CT 06183  
Surety Name and Address

as SURETY, are held and firmly bound unto the above Local Public Agency (hereafter referred to as "LPA") in the penal sum of  
One Hundred Ninety Nine Thousand Six Hundred Twenty Eight and 28/100 Dollars

Dollars ( \$199,628.28 ) lawful money of the United States, to be paid to said LPA, the payment of which we bind ourselves, successors and assigns jointly to pay to the LPA this sum under the conditions of this instrument.

WHEREAS, THE CONDITION OF THE FOREGOING OBLIGATION IS SUCH that the said Principal has entered into a written contract with the LPA acting through its awarding authority for the construction of work on the above sections, which contract is hereby referred to and made a part hereof, as if written herein at length, and whereby the said Principal has promised and agreed to perform said work in accordance with the terms of said contract, and has promised to pay all sums of money due for any labor, materials, apparatus, fixtures or machinery furnished to such Principal for the purpose of performing such work and has further agreed to pay all direct and indirect damages to any person, firm, company or corporation to whom any money may be due from the Principal, subcontractor or otherwise for any such labor, materials, apparatus, fixtures or machinery so furnished and that suit may be maintained on such bond by any such person, firm, company or corporation for the recovery of any such money.

NOW, THEREFORE, if the said Principal shall perform said work in accordance with the terms of said contract, and shall pay all sums of money due or to become due for any labor, materials, apparatus, fixtures or machinery furnished to it for the purpose of constructing such work, and shall commence and complete the work within the time prescribed in said contract, and shall pay and discharge all damages, direct and indirect, that may be suffered or sustained on account of such work during the time of the performance thereof and until the said work shall have been accepted, and shall hold the LPA and its awarding authority harmless on account of any such damages and shall in all respects fully and faithfully comply with all the provisions, conditions and requirements of said contract, then this obligation shall be void; otherwise it shall remain in full force and effect.

IN TESTIMONY WHEREOF, the said PRINCIPAL and the said SURETY have caused this instrument to be signed by their respective agents this 11th day of April, 2023  
Day Month and Year

PRINCIPAL

Company Name  
Alliance Contractors, Inc

By  
Signature & Date  

Attest  
Signature & Date  
 4/11/23

Company Name

By  
Signature & Date

Attest  
Signature & Date

(If PRINCIPAL is a joint venture of two or more contractors, the company names and authorized signature of each contractor must be affixed.)

STATE OF IL  
COUNTY OF MCHENRY

I, Renee' Behrens, a Notary Public in and for said county, do hereby certify that  
Notary Name

Michael J. Paulson

Insert name of Individuals signing on behalf of PRINCIPAL

who is/are each personally known to me to be the same person(s) whose name(s) is/are subscribed to the foregoing instrument on behalf of PRINCIPAL, appeared before me this day in person and acknowledged respectively, that he/she/they signed and delivered said instrument freely and voluntarily for the uses and purposes therein set forth.

Given under my hand and notarial seal this 11th day of April, 2023  
Day Month, Year



Notary Public Signature & Date

*Renee' Behrens*

Date commission expires 12-15-2026

**SURETY**

Name of Surety

Travelers Casualty and Surety Company of America

Title/Attorney-in-Fact

By: *Ashley Stewart*

STATE OF IL  
COUNTY OF \_\_\_\_\_

I, \_\_\_\_\_, a Notary Public in and for said county, do hereby certify that  
Notary Name

**See Attached**

Insert name of Individuals signing on behalf of SURETY

who is/are each personally known to me to be the same person(s) whose name(s) is/are subscribed to the foregoing instrument on behalf of SURETY, appeared before me this day in person and acknowledged respectively, that he/she/they signed and delivered said instrument freely and voluntarily for the uses and purposes therein set forth.

Given under my hand and notarial seal this \_\_\_\_\_ day of \_\_\_\_\_  
Day Month, Year

(SEAL)

Notary Public Signature & Date

Date commission expires \_\_\_\_\_

Approved this 21st day of February 2023  
Day Month, Year

Attest:

Local Public Agency Clerk Signature & Date

*Christina Sussman*

Village

Local Public Agency Type

Clerk

Awarding Authority

Village of Buffalo Grove - President

Awarding Authority Signature & Date

*Christina Sussman*



**Travelers Casualty and Surety Company of America**  
**Travelers Casualty and Surety Company**  
**St. Paul Fire and Marine Insurance Company**

**POWER OF ATTORNEY**

**KNOW ALL MEN BY THESE PRESENTS:** That Travelers Casualty and Surety Company of America, Travelers Casualty and Surety Company, and St. Paul Fire and Marine Insurance Company are corporations duly organized under the laws of the State of Connecticut (herein collectively called the "Companies"), and that the Companies do hereby make, constitute and appoint **Kathleen Stewart** of **Chicago / Naperville Illinois**, their true and lawful Attorney(s)-in-Fact to sign, execute, seal and acknowledge any and all bonds, recognizances, conditional undertakings and other writings obligatory in the nature thereof on behalf of the Companies in their business of guaranteeing the fidelity of persons, guaranteeing the performance of contracts and executing or guaranteeing bonds and undertakings required or permitted in any actions or proceedings allowed by law.

**IN WITNESS WHEREOF**, the Companies have caused this instrument to be signed, and their corporate seals to be hereto affixed, this **21st** day of **April**, 2021.



State of Connecticut

City of Hartford ss,

By:   
 Robert L. Raney, Senior Vice President

On this the **21st** day of **April**, 2021, before me personally appeared **Robert L. Raney**, who acknowledged himself to be the Senior Vice President of each of the Companies, and that he, as such, being authorized so to do, executed the foregoing instrument for the purposes therein contained by signing on behalf of said Companies by himself as a duly authorized officer.

**IN WITNESS WHEREOF**, I hereunto set my hand and official seal.

My Commission expires the **30th** day of **June**, 2026



  
 Anna P. Nowik, Notary Public

This Power of Attorney is granted under and by the authority of the following resolutions adopted by the Boards of Directors of each of the Companies, which resolutions are now in full force and effect, reading as follows:

**RESOLVED**, that the Chairman, the President, any Vice Chairman, any Executive Vice President, any Senior Vice President, any Vice President, any Second Vice President, the Treasurer, any Assistant Treasurer, the Corporate Secretary or any Assistant Secretary may appoint Attorneys-in-Fact and Agents to act for and on behalf of the Company and may give such appointee such authority as his or her certificate of authority may prescribe to sign with the Company's name and seal with the Company's seal bonds, recognizances, contracts of indemnity, and other writings obligatory in the nature of a bond, recognizance, or conditional undertaking, and any of said officers or the Board of Directors at any time may remove any such appointee and revoke the power given him or her; and it is

**FURTHER RESOLVED**, that the Chairman, the President, any Vice Chairman, any Executive Vice President, any Senior Vice President or any Vice President may delegate all or any part of the foregoing authority to one or more officers or employees of this Company, provided that each such delegation is in writing and a copy thereof is filed in the office of the Secretary; and it is

**FURTHER RESOLVED**, that any bond, recognizance, contract of indemnity, or writing obligatory in the nature of a bond, recognizance, or conditional undertaking shall be valid and binding upon the Company when (a) signed by the President, any Vice Chairman, any Executive Vice President, any Senior Vice President or any Vice President, any Second Vice President, the Treasurer, any Assistant Treasurer, the Corporate Secretary or any Assistant Secretary and duly attested and sealed with the Company's seal by a Secretary or Assistant Secretary; or (b) duly executed (under seal, if required) by one or more Attorneys-in-Fact and Agents pursuant to the power prescribed in his or her certificate or their certificates of authority or by one or more Company officers pursuant to a written delegation of authority; and it is

**FURTHER RESOLVED**, that the signature of each of the following officers: President, any Executive Vice President, any Senior Vice President, any Vice President, any Assistant Vice President, any Secretary, any Assistant Secretary, and the seal of the Company may be affixed by facsimile to any Power of Attorney or to any certificate relating thereto appointing Resident Vice Presidents, Resident Assistant Secretaries or Attorneys-in-Fact for purposes only of executing and attesting bonds and undertakings and other writings obligatory in the nature thereof, and any such Power of Attorney or certificate bearing such facsimile signature or facsimile seal shall be valid and binding upon the Company and any such power so executed and certified by such facsimile signature and facsimile seal shall be valid and binding on the Company in the future with respect to any bond or understanding to which it is attached.

I, **Kevin E. Hughes**, the undersigned, Assistant Secretary of each of the Companies, do hereby certify that the above and foregoing is a true and correct copy of the Power of Attorney executed by said Companies, which remains in full force and effect.

Dated this 11th day of April, 2023



  
 Kevin E. Hughes, Assistant Secretary

**To verify the authenticity of this Power of Attorney, please call us at 1-800-421-3880.**  
**Please refer to the above-named Attorney(s)-in-Fact and the details of the bond to which this Power of Attorney is attached.**



STATE OF ILLINOIS }  
COUNTY OF KANE }

I, Karena Rios a Notary Public in and for said County, do

hereby certify that Kathleen Stewart Attorney -in-Fact, of the:

- THE TRAVELERS INDEMNITY COMPANY
- TRAVELERS CASUALTY & SURETY COMPANY
- TRAVELERS CASUALTY & SURETY COMPANY OF AMERICA
- FARMINGTON CASUALTY COMPANY
- UNITED STATES FIDELITY AND GUARANTY COMPANY
- ST. PAUL FIRE AND MARINE INSURANCE COMPANY
- FIDELITY AND GUARANTY INSURANCE COMPANY
- FIDELITY AND GUARANTY INSURANCE UNDERWRITERS, INC.
- ST. PAUL GUARDIAN INSURANCE COMPANY
- ST. PAUL MERCURY INSURANCE COMPANY

Who is personally known to me to be the same person, whose name is subscribed to the foregoing, instrument, appeared before me this day in person, and acknowledged that they signed, sealed, and delivered said instrument for and on behalf of:

- THE TRAVELERS INDEMNITY COMPANY
- TRAVELERS CASUALTY & SURETY COMPANY
- TRAVELERS CASUALTY & SURETY COMPANY OF AMERICA
- FARMINGTON CASUALTY COMPANY
- UNITED STATES FIDELITY AND GUARANTY COMPANY
- ST. PAUL FIRE AND MARINE INSURANCE COMPANY
- FIDELITY AND GUARANTY INSURANCE COMPANY
- FIDELITY AND GUARANTY INSURANCE UNDERWRITERS, INC.
- ST. PAUL GUARDIAN INSURANCE COMPANY
- ST. PAUL MERCURY INSURANCE COMPANY

For the uses and purposed therein set forth.

Given under my hand and notarial seal at my office in the City of Naperville in said

County, this 11th day of April A.D. 20 23

  
\_\_\_\_\_  
Notary Public



Local Public Agency	County	Section Number	Route(s) (Street/Road Name)
Village of Buffalo Grove	Cook		Busch Parkway and Barclay Bo

**NOTICE TO BIDDERS**

Sealed proposals for the project described below will be received at the office of www.vbg.org/bids

	Name of Office
	until <u>9:00 AM</u> on <u>03/09/23</u>
Address	Time                      Date

Sealed proposals will be opened and read publicly at the office of a live, online meeting hosted by the Village.

	Name of Office
<u>https://bit.ly/3lcvGNR</u>	at <u>9:00 AM</u> on <u>03/09/23</u>
Address	Time                      Date

**DESCRIPTION OF WORK**

Location	Project Length
Busch Parkway and Barclay Boulevard, and Chicory Lane	880' (0.17 Miles)

**Proposed Improvement**

This project includes, but is not limited to, the following major work items: new concrete sidewalk, driveway pavement removal & replacement, and other associated improvements.

1. Plans and proposal forms will be available in the office of

www.vbg.org/bids  
Office of the Purchasing Manager - (847) 459-2500

2.  Prequalification

If checked, the 2 apparent as read low bidders must file within 24 hours after the letting an "Affidavit of Availability" (Form BC 57) in triplicate, showing all uncompleted contracts awarded to them and all low bids pending award for Federal, State, County, Municipal and private work. One original shall be filed with the Awarding Authority and two originals with the IDOT District Office.

3. The Awarding Authority reserves the right to waive technicalities and to reject any or all proposals as provided in BLRS Special Provision for Bidding Requirements and Conditions for Contract Proposals.

4. The following BLR Forms shall be returned by the bidder to the Awarding Authority:

- a. Local Public Agency Formal Contract Proposal (BLR 12200)
- b. Schedule of Prices (BLR 12201)
- c. Proposal Bid Bond (BLR 12230) (if applicable)
- d. Apprenticeship or Training Program Certification (BLR 12325) (do not use for project with Federal funds.)
- e. Affidavit of Illinois Business Office (BLR 12326) (do not use for project with Federal funds)

5. The quantities appearing in the bid schedule are approximate and are prepared for the comparison of bids. Payment to the Contractor will be made only for the actual quantities of work performed and accepted or materials furnished according to the contract. The scheduled quantities of work to be done and materials to be furnished may be increased, decreased or omitted as hereinafter provided.

6. Submission of a bid shall be conclusive assurance and warranty the bidder has examined the plans and understands all requirements for the performance of work. The bidder will be responsible for all errors in the proposal resulting from failure or neglect to conduct an in depth examination. The Awarding Authority will, in no case, be responsible for any costs, expenses, losses or changes in anticipated profits resulting from such failure or neglect of the bidder.

7. The bidder shall take no advantage of any error or omission in the proposal and advertised contract.

8. If a special envelope is supplied by the Awarding Authority, each proposal should be submitted in that envelope furnished by the Awarding Agency and the blank spaces on the envelope shall be filled in correctly to clearly indicate its contents. When an envelope other than the special one furnished by the Awarding Authority is used, it shall be marked to clearly indicate its contents. When sent by mail, the sealed proposal shall be addressed to the Awarding Authority at the address and in care of the official in whose office the bids are to be received. All proposals shall be filed prior to the time and at the place specified in the Notice to Bidders. Proposals received after the time specified will be returned to the bidder unopened.

9. Permission will be given to a bidder to withdraw a proposal if the bidder makes the request in writing or in person before the time for opening proposals.





Local Public Agency	County	Section Number	Route(s) (Street/Road Name)
Village of Buffalo Grove	Cook		Busch Parkway and Barclay Bo

### CONTRACTOR CERTIFICATIONS

The certifications hereinafter made by the bidder are each a material representation of fact upon which reliance is placed should the Department enter into the contract with the bidder.

- Debt Delinquency.** The bidder or contractor or subcontractor, respectively, certifies that it is not delinquent in the payment of any tax administered by the Department of Revenue unless the individual or other entity is contesting, in accordance with the procedure established by the appropriate Revenue Act, its liability for the tax or the amount of the tax. Making a false statement voids the contract and allows the Department to recover all amounts paid to the individual or entity under the contract in a civil action.
- Bid-Rigging or Bid Rotating.** The bidder or contractor or subcontractor, respectively, certifies that it is not barred from contracting with the Department by reason of a violation of either 720 ILCS 5/33E-3 or 720 ILCS 5/33E-4.

A violation of section 33E-3 would be represented by a conviction of the crime of bid-rigging which, in addition to Class 3 felony sentencing, provides that any person convicted of this offense, or any similar offense of any state or the United States which contains the same elements as this offense shall be barred for 5 years from the date of conviction from contracting with any unit of State or local government. No corporation shall be barred from contracting with any unit of State or local government as a result of a conviction under this Section of any employee or agent of such corporation if the employee so convicted is no longer employed by the corporation: (1) it has been finally adjudicated not guilty or (2) if it demonstrates to the governmental entity with which it seeks to contract that entity finds that the commission of the offense was neither authorized, requested, commanded, nor performed by a director, officer or a high managerial agent on behalf of the corporation.

A violation of Section 33E-4 would be represented by a conviction of the crime of bid-rotating which, in addition to Class 2 felony sentencing, provides that any person convicted of this offense or any similar offense of any state or the United States which contains the same elements as this offense shall be permanently barred from contracting with any unit of State of Local government. No corporation shall be barred from contracting with any unit of State or Local government as a result of a conviction under this Section of any employee or agent of such corporation if the employee so convicted is no longer employed by the corporation and: (1) it has been finally adjudicated not guilty or (2) if it demonstrates to the governmental entity with which it seeks to contract and that entity finds that the commission of the offense was neither authorized, requested, commanded, nor performed by a director, officer or a high managerial agent on behalf of the corporation.

- Bribery.** The bidder or contractor or subcontractor, respectively, certifies that, it has not been convicted of bribery or attempting to bribe an officer or employee of the State of Illinois or any unit of local government, nor has the firm made an admission of guilt of such conduct which is a matter of record, nor has an official, agent, or employee of the firm committed bribery or attempted bribery on behalf of the firm and pursuant to the direction or authorization of a responsible official of the firm.
- Interim Suspension or Suspension.** The bidder or contractor or subcontractor, respectively, certifies that it is not currently under a suspension as defined in Subpart I of Title 44 Subtitle A Chapter III Part 6 of the Illinois Administrative code. Furthermore, if suspended prior to completion of this work, the contract or contracts executed for the completion of this work may be canceled.

Local Public Agency	County	Section Number	Route(s) (Street/Road Name)
Village of Buffalo Grove	Cook		Busch Parkway and Barclay Bo

**SIGNATURES**

(If an individual)

Signature of Bidder	Date	
Business Address		
City	State	Zip Code

(If a partnership)

Firm Name		
Signature	Date	
Title		
Business Address		
City	State	Zip Code

Insert the Names and Addresses of all Partners

--

(If a corporation)

Corporate Name		
Alliance Contractors, Inc.		
Signature	Date	
	3/9/2023	
Title		
Scott A. Marquart, Vice President		
Business Address		
1166 Lake Ave.		
City	State	Zip Code
Woodstock	IL	60098

Insert Names of Officers

President
Michael J. Paulson

Attest:



Assistant Secretary

Secretary

Helen J. Ruth

Treasurer





Schedule of Prices



Contractor's Name

Alliance Contractors, Inc.

Contractor's Address

1166 Lake Ave.

City

Woodstock

State

IL

Zip Code

60098

Local Public Agency

Village of Buffalo Grove

County

Cook/Lake

Section Number

Route(s) (Street/Road Name)

Various Street Segments

Schedule for Multiple Bids

Combination Letter	Section Included in Combinations	Total

Schedule for Single Bid

(For complete information covering these items, see plans and specifications.)

Item Number	Items	Unit	Quantity	Unit Price	Total
20100210	TREE REMOV OVER 15	UN	20	90.00	1800.00
20101100	TREE TRUNK PROTECTION	EA	3	250.00	750.00
20101200	TREE ROOT PRUNING	EA	3	150.00	450.00
20201200	REM & DISP OF UNS MATL	CY	30	40.00	1200.00
21001000	GEOTECH FAB F/ GR STAB	SY	75	0.90	67.50
28000510	INLET FILTERS	EA	5	25.00	125.00
30300001	AGG SUBGRADE IMPROVE	CY	30	40.25	1207.50
42300400	PC CONC DRIVEWAY 8 INCH	SY	160	135.80	21728.00
42400200	PC CONC SIDEWALK 5	SF	6660	13.30	88578.00
44000200	DRIVE PAVEMENT REM	SY	160	20.00	3200.00
44000500	COMB CURB GUTTER REM	FT	250	15.00	3750.00
67100100	MOBILIZATION	LS	1	10971.50	10971.50
70102620	TR CONT & PROT 701501	LS	1	3675.00	3675.00
70102640	TR CONT & PROT 701801	LS	1	100.00	100.00
X2600012	R&R SIGN PANEL & POLE	EA	4	200.00	800.00
-	GEN LANDSCAPE REST	SY	580	13.50	7830.00
-	AGG BASE CSE B	TN	250	19.00	4750.00
-	COMB C&G TY B-6.12 (SP)	FT	250	83.50	20875.00
-	6 INCH BARRIER CURB	FT	85	67.75	5768.75
-	SAN MH TO BE ADJ (SP)	EA	1	475.00	475.00

Local Public Agency		County		Section Number		Route(s) (Street/Road Name)	
Village of Buffalo Grove		Cook				Various Street Segments	
Item Number	Items	Unit	Quantity	Unit Price	Total		
-	SAN MH TO BE REC (SP)	EA	1	2500.00	2500.00		
-	D&U STRUC TO BE ADJ (SP)	EA	3	175.00	525.00		
-	EXPLORATION EXCAVATION	EA	3	1.00	3.00		
-	STUMP REMOVAL	EA	4	90.00	360.00		
-	PVC SLEEVE, 6 INCH	EA	1	1.00	1.00		
Bidder's Total Proposal						181,480.25	

1. Each pay item should have a unit price and a total price.
2. If no total price is shown or if there is a discrepancy between the product of the unit price multiplied by the quantity, the unit price shall govern.
3. If a unit price is omitted, the total price will be divided by the quantity in order to establish a unit price.
4. A bid may be declared unacceptable if neither a unit price or total price is shown.



Local Public Agency
Proposal Bid Bond



Local Public Agency: Village of Buffalo Grove; County: Cook/Lake; Section Number: [ ]

WE, Alliance Contractors, Inc., 1188 Lake Avenue, Woodstock, IL 60098 as PRINCIPAL, and Travelers Casualty and Surety of America, 215 Shuman Blvd., Naperville, IL 60563 as SURETY, are held jointly, severally and firmly bound unto the above Local Public Agency (hereafter referred to as "LPA") in the penal sum of 5% of the total bid price, or for the amount specified in the proposal documents in effect on the date of invitation for bids, whichever is the lesser sum. We bind ourselves, our heirs, executors, administrators, successors, and assigns, jointly pay to the LPA this sum under the conditions of this instrument.

WHEREAS THE CONDITION OF THE FOREGOING OBLIGATION IS SUCH that, the said PRINCIPAL is submitting a written proposal to the LPA acting through its awarding authority for the construction of the work designated as the above section.

THEREFORE if the proposal is accepted and a contract awarded to the PRINCIPAL by the LPA for the above designated section and the PRINCIPAL shall within fifteen (15) days after award enter into a formal contract, furnish surety guaranteeing the faithful performance of the work, and furnish evidence of the required insurance coverage, all as provided in the "Standard Specifications for Road and Bridge Construction" and applicable Supplemental Specifications, then this obligation shall become void; otherwise it shall remain in full force and effect.

IN THE EVENT the LPA determines the PRINCIPAL has failed to enter into a formal contract in compliance with any requirements set forth in the preceding paragraph, then the LPA acting through its awarding authority shall immediately be entitled to recover the full penal sum set out above, together with all court costs, all attorney fees, and any other expense of recovery.

IN TESTIMONY WHEREOF, the said PRINCIPAL and the said SURETY have caused this instrument to be signed by their respective officers this 9th of March, 2023

Principal

Company Name: Alliance Contractors, Inc.
Signature: Scott A. Marquart
Date: 3/9/2023
Title: Vice President

Company Name: [ ]
Signature: [ ]
Date: [ ]
Title: [ ]

(If Principal is a joint venture of two or more contractors, the company names, and authorized signatures of each contractor must be affixed.)

Surety

Name of Surety: Travelers Casualty and Surety of America

Signature of Attorney-in-Fact: Kathleen Stewart
Date: 3/9/23

STATE OF IL
COUNTY OF

I Dawn L. Thibadeau, a Notary Public in and for said county do hereby certify that

Scott A. Marquart and Kathleen Stewart

(Insert names of individuals signing on behalf of PRINCIPAL & SURETY)

who are each personally known to me to be the same persons whose names are subscribed to the foregoing instrument on behalf of PRINCIPAL and SURETY, appeared before me this day in person and acknowledged respectively, that they signed and delivered said instruments as their free and voluntary act for the uses and purposes therein set forth.

Given under my hand and notarial seal this 9th day of March, 2023

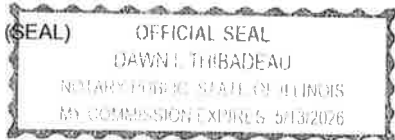

Notary Public Signature: [Signature]

Date commission expires 5/13/26



**Travelers Casualty and Surety Company of America  
Travelers Casualty and Surety Company  
St. Paul Fire and Marine Insurance Company**

**POWER OF ATTORNEY**

**KNOW ALL MEN BY THESE PRESENTS:** That Travelers Casualty and Surety Company of America, Travelers Casualty and Surety Company, and St. Paul Fire and Marine Insurance Company are corporations duly organized under the laws of the State of Connecticut (herein collectively called the "Companies"), and that the Companies do hereby make, constitute and appoint **Kathleen Stewart** of **Chicago / Naperville**, **Illinois**, their true and lawful Attorney(s)-in-Fact to sign, execute, seal and acknowledge any and all bonds, recognizances, conditional undertakings and other writings obligatory in the nature thereof on behalf of the Companies in their business of guaranteeing the fidelity of persons, guaranteeing the performance of contracts and executing or guaranteeing bonds and undertakings required or permitted in any actions or proceedings allowed by law.

**IN WITNESS WHEREOF**, the Companies have caused this instrument to be signed, and their corporate seals to be hereto affixed, this **21st** day of **April**, 2021.



State of Connecticut

City of Hartford ss.

By:   
Robert L. Raney, Senior Vice President

On this the **21st** day of **April**, 2021, before me personally appeared **Robert L. Raney**, who acknowledged himself to be the Senior Vice President of each of the Companies, and that he, as such, being authorized so to do, executed the foregoing instrument for the purposes therein contained by signing on behalf of said Companies by himself as a duly authorized officer.

**IN WITNESS WHEREOF**, I hereunto set my hand and official seal.

My Commission expires the **30th** day of **June**, 2026

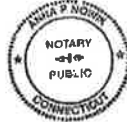

  
Anna P. Nowik, Notary Public

This Power of Attorney is granted under and by the authority of the following resolutions adopted by the Boards of Directors of each of the Companies, which resolutions are now in full force and effect, reading as follows:

**RESOLVED**, that the Chairman, the President, any Vice Chairman, any Executive Vice President, any Senior Vice President, any Vice President, any Second Vice President, the Treasurer, any Assistant Treasurer, the Corporate Secretary or any Assistant Secretary may appoint Attorneys-in-Fact and Agents to act for and on behalf of the Company and may give such appointee such authority as his or her certificate of authority may prescribe to sign with the Company's name and seal with the Company's seal bonds, recognizances, contracts of indemnity, and other writings obligatory in the nature of a bond, recognizance, or conditional undertaking, and any of said officers or the Board of Directors at any time may remove any such appointee and revoke the power given him or her; and it is

**FURTHER RESOLVED**, that the Chairman, the President, any Vice Chairman, any Executive Vice President, any Senior Vice President or any Vice President may delegate all or any part of the foregoing authority to one or more officers or employees of this Company, provided that each such delegation is in writing and a copy thereof is filed in the office of the Secretary; and it is

**FURTHER RESOLVED**, that any bond, recognizance, contract of indemnity, or writing obligatory in the nature of a bond, recognizance, or conditional undertaking shall be valid and binding upon the Company when (a) signed by the President, any Vice Chairman, any Executive Vice President, any Senior Vice President or any Vice President, any Second Vice President, the Treasurer, any Assistant Treasurer, the Corporate Secretary or any Assistant Secretary and duly attested and sealed with the Company's seal by a Secretary or Assistant Secretary; or (b) duly executed (under seal, if required) by one or more Attorneys-in-Fact and Agents pursuant to the power prescribed in his or her certificate or their certificates of authority or by one or more Company officers pursuant to a written delegation of authority; and it is

**FURTHER RESOLVED**, that the signature of each of the following officers: President, any Executive Vice President, any Senior Vice President, any Vice President, any Assistant Vice President, any Secretary, any Assistant Secretary, and the seal of the Company may be affixed by facsimile to any Power of Attorney or to any certificate relating thereto appointing Resident Vice Presidents, Resident Assistant Secretaries or Attorneys-in-Fact for purposes only of executing and attesting bonds and undertakings and other writings obligatory in the nature thereof, and any such Power of Attorney or certificate bearing such facsimile signature or facsimile seal shall be valid and binding upon the Company and any such power so executed and certified by such facsimile signature and facsimile seal shall be valid and binding on the Company in the future with respect to any bond or understanding to which it is attached.

I, **Kevin E. Hughes**, the undersigned, Assistant Secretary of each of the Companies, do hereby certify that the above and foregoing is a true and correct copy of the Power of Attorney executed by said Companies, which remains in full force and effect.

Dated this **9th** day of **MARCH**, 2023



  
Kevin E. Hughes, Assistant Secretary

**To verify the authenticity of this Power of Attorney, please call us at 1-800-421-3880.  
Please refer to the above-named Attorney(s)-in-Fact and the details of the bond to which this Power of Attorney is attached.**



Karena Rios  
Account Manager, Construction Services, Travelers Bond  
215 Shuman Blvd., Naperville, IL 60563  
Telephone: (630) 961-7162  
Fax: (866)216-5979  
Email: krios4@travelers.com

March 9, 2023

Village of Buffalo Grove  
50 Raupp Blvd.  
Buffalo Grove, IL 60089

**RE:** Alliance Contractors Inc.  
1166 Lake Avenue, Woodstock, IL 60098

**Project:** Busch Parkway and Barclay Boulevard, and Chicory Lane  
Buffalo Grove, IL

Ladies and Gentlemen:

We are pleased to share with you our experience as surety for ALLIANCE CONTRACTORS, INC. We consider ALLIANCE CONTRACTORS, INC. one of our outstanding and most valued clients in whom we have the highest confidence. Through the years this company has, in our opinion, remained properly financed, well equipped and capably managed.

TRAVELERS CASUALTY AND SURETY COMPANY OF AMERICA is prepared to give favorable consideration to the execution of contract performance and payment bonds running to the Owner, in association with the Busch Parkway and Barclay Boulevard, and Chicory Lane Project. We understand that ALLIANCE CONTRACTORS, INC.'S contract is in the \$7,000,000.00 Single to \$20,000,000.00 Aggregate range.

Our willingness to provide surety credit on this project is subject to ALLIANCE CONTRACTORS, INC.'S acceptance of an award of the contract, ALLIANCE CONTRACTORS, INC. applying to the TRAVELERS CASUALTY AND SURETY COMPANY OF AMERICA on or about the day work is scheduled to begin for bonding, and ALLIANCE CONTRACTORS, INC. and us, as surety, determining that the contract documents, contract specifications and bond forms are acceptable.

We are pleased to share with you our experience with this fine organization. If you require any additional information, please let us know.

Best regards,

TRAVELERS CASUALTY AND SURETY  
COMPANY OF AMERICA

Karena Rios  
Attorney-in-Fact





# CERTIFICATE OF LIABILITY INSURANCE

DATE (MM/DD/YYYY)

3/24/2022

THIS CERTIFICATE IS ISSUED AS A MATTER OF INFORMATION ONLY AND CONFERS NO RIGHTS UPON THE CERTIFICATE HOLDER. THIS CERTIFICATE DOES NOT AFFIRMATIVELY OR NEGATIVELY AMEND, EXTEND OR ALTER THE COVERAGE AFFORDED BY THE POLICIES BELOW. THIS CERTIFICATE OF INSURANCE DOES NOT CONSTITUTE A CONTRACT BETWEEN THE ISSUING INSURER(S), AUTHORIZED REPRESENTATIVE OR PRODUCER, AND THE CERTIFICATE HOLDER.

**IMPORTANT:** If the certificate holder is an ADDITIONAL INSURED, the policy(ies) must have ADDITIONAL INSURED provisions or be endorsed. If SUBROGATION IS WAIVED, subject to the terms and conditions of the policy, certain policies may require an endorsement. A statement on this certificate does not confer rights to the certificate holder in lieu of such endorsement(s).

<b>PRODUCER</b> Arthur J. Gallagher Risk Management Services, Inc. 240 Commerce Drive Crystal Lake IL 60014	<b>CONTACT NAME:</b> <b>PHONE (A/C No, Ext):</b> 815-459-6300	<b>FAX (A/C, No):</b> 815-459-5794
	<b>E-MAIL ADDRESS:</b>	
<b>INSURED</b> Alliance Contractors, Inc. 1166 Lake Avenue Woodstock IL 60098	<b>INSURER(S) AFFORDING COVERAGE</b>	
	<b>INSURER A:</b> Cincinnati Insurance Company	<b>NAIC #</b> 10677
	<b>INSURER B:</b> Great American Insurance Company	16691
	<b>INSURER C:</b>	
	<b>INSURER D:</b>	
	<b>INSURER E:</b>	
<b>INSURER F:</b>		

**COVERAGES**

CERTIFICATE NUMBER: 1579263958

REVISION NUMBER:

THIS IS TO CERTIFY THAT THE POLICIES OF INSURANCE LISTED BELOW HAVE BEEN ISSUED TO THE INSURED NAMED ABOVE FOR THE POLICY PERIOD INDICATED. NOTWITHSTANDING ANY REQUIREMENT, TERM OR CONDITION OF ANY CONTRACT OR OTHER DOCUMENT WITH RESPECT TO WHICH THIS CERTIFICATE MAY BE ISSUED OR MAY PERTAIN, THE INSURANCE AFFORDED BY THE POLICIES DESCRIBED HEREIN IS SUBJECT TO ALL THE TERMS, EXCLUSIONS AND CONDITIONS OF SUCH POLICIES. LIMITS SHOWN MAY HAVE BEEN REDUCED BY PAID CLAIMS.

INSR LTR	TYPE OF INSURANCE	ADDL SUBR INSD. WVD	POLICY NUMBER	POLICY EFF (MM/DD/YYYY)	POLICY EXP (MM/DD/YYYY)	LIMITS
A	<input checked="" type="checkbox"/> <b>COMMERCIAL GENERAL LIABILITY</b> <input type="checkbox"/> CLAIMS-MADE <input checked="" type="checkbox"/> OCCUR <input checked="" type="checkbox"/> XCU Included GEN'L AGGREGATE LIMIT APPLIES PER: <input checked="" type="checkbox"/> POLICY <input checked="" type="checkbox"/> PROJECT <input type="checkbox"/> LOC OTHER:		EPP 0317038	4/1/2022	4/1/2023	EACH OCCURRENCE \$ 1,000,000 DAMAGE TO RENTED PREMISES (Ea occurrence) \$ 500,000 MED EXP (Any one person) \$ 10,000 PERSONAL & ADV INJURY \$ 1,000,000 GENERAL AGGREGATE \$ 2,000,000 PRODUCTS - COMPI/OP AGG \$ 2,000,000 \$
A	<input checked="" type="checkbox"/> <b>AUTOMOBILE LIABILITY</b> <input checked="" type="checkbox"/> ANY AUTO <input type="checkbox"/> OWNED AUTOS ONLY <input type="checkbox"/> SCHEDULED AUTOS <input checked="" type="checkbox"/> HIRED AUTOS ONLY <input checked="" type="checkbox"/> NON-OWNED AUTOS ONLY		EBA 0317038	4/1/2022	4/1/2023	COMBINED SINGLE LIMIT (Ea accident) \$ 1,000,000 BODILY INJURY (Per person) \$ BODILY INJURY (Per accident) \$ PROPERTY DAMAGE (Per accident) \$ \$
A	<input checked="" type="checkbox"/> <b>UMBRELLA LIAB</b> <input checked="" type="checkbox"/> OCCUR <input type="checkbox"/> EXCESS LIAB <input type="checkbox"/> CLAIMS-MADE DED <input checked="" type="checkbox"/> RETENTION \$ 50		EPP 0317038	4/1/2022	4/1/2023	EACH OCCURRENCE \$ 5,000,000 AGGREGATE \$ 5,000,000 \$
A	<input checked="" type="checkbox"/> <b>WORKERS COMPENSATION AND EMPLOYERS' LIABILITY</b> ANY PROPRIETOR/PARTNER/EXECUTIVE OFFICER/MEMBER EXCLUDED? (Mandatory in NH) If yes, describe under DESCRIPTION OF OPERATIONS below	Y/N <input checked="" type="checkbox"/> N <input type="checkbox"/> N/A	EWC0317040-08	4/1/2022	4/1/2023	<input checked="" type="checkbox"/> PER STATUTE <input type="checkbox"/> OTHER E.L. EACH ACCIDENT \$ 1,000,000 E.L. DISEASE - EA EMPLOYEE \$ 1,000,000 E.L. DISEASE - POLICY LIMIT \$ 1,000,000
B	Excess Umbrella		TUE 3085918 03	4/1/2022	4/1/2023	Each Occurrence \$20,000,000
A	Leased & Rented Equipment		EPP 0317038	4/1/2022	4/1/2023	Aggregate \$20,000,000 Leased & Rented Equip \$450,000

DESCRIPTION OF OPERATIONS / LOCATIONS / VEHICLES (ACORD 101, Additional Remarks Schedule, may be attached if more space is required)

**CERTIFICATE HOLDER****CANCELLATION**

SAMPLE

SHOULD ANY OF THE ABOVE DESCRIBED POLICIES BE CANCELLED BEFORE THE EXPIRATION DATE THEREOF, NOTICE WILL BE DELIVERED IN ACCORDANCE WITH THE POLICY PROVISIONS.

AUTHORIZED REPRESENTATIVE

© 1988-2015 ACORD CORPORATION. All rights reserved.



# Illinois Department of Transportation

# Certificate of Eligibility

Alliance Contractors, Inc.  
1166 Lake Avenue Woodstock, IL 60098

Contractor No 0103

WHO HAS FILED WITH THE DEPARTMENT AN APPLICATION FOR PREQUALIFICATION STATEMENT OF EXPERIENCE, EQUIPMENT AND FINANCIAL CONDITION IS HEREBY QUALIFIED TO BID AT ANY OF DEPARTMENT OF TRANSPORTATION LETTINGS IN THE CLASSES OF WORK AND WITHIN THE AMOUNT AND OTHER LIMITATIONS OF EACH CLASSIFICATION, AS LISTED BELOW, FOR SUCH PERIOD AS THE UNCOMPLETED WORK FROM ALL SOURCES DOES NOT EXCEED

\$101,597,000.00

001	EARTHWORK	\$5,775,000
002	PCC PAVING	\$21,350,000
005	HMA PAVING	\$625,000 B
012	DRAINAGE	\$3,525,000
014	ELECTRICAL	\$350,000
017	CONCRETE CONSTRUCTION	\$6,125,000
022	FENCING	\$100,000
023	GUARDRAIL	\$175,000
026	SIGNING	\$525,000
032	COLD MILL, PLAN. & ROTOMILL	\$450,000
034	DEMOLITION	\$400,000
08A	AGGREGATE BASES & SURF. (A)	\$2,750,000
09C	HWY., R.R. & WATERWAY STR.	\$5,650,000

THIS CERTIFICATE OF ELIGIBILITY IS VALID FROM 7/19/2022 TO 7/31/2023 INCLUSIVE, AND SUPERSEDES ANY CERTIFICATE PREVIOUSLY ISSUED, BUT IS SUBJECT TO REVISION OR REVOCATION, IF AND WHEN CHANGES IN THE FINANCIAL CONDITION OF THE CONTRACTING FIRM OR OTHER FACTS JUSTIFY SUCH REVISIONS OR REVOCATION. ISSUED AT SPRINGFIELD, ILLINOIS ON 7/19/2022.

B Restricted to 1200 tons in any 1 contract (Class I and/or B&M) or as specified by local agency

*[Signature]*  
Engineer of Construction



# Apprenticeship and Training Program Certification



VoBG-2023-12

Local Public Agency	County	Street Name/Road Name	Section Number
Village of Buffalo Grove	Cook/Lake	Various Street Segments	

All contractors are required to complete the following certification

- For this contract proposal or for all bidding groups in this deliver and install proposal.
- For the following deliver and install bidding groups in this material proposal.

Illinois Department of Transportation policy, adopted in accordance with the provisions of the Illinois Highway Code, requires this contract to be awarded to the lowest responsive and responsible bidder. The award decision is subject to approval by the Department. In addition to all other responsibility factors, this contract or deliver and install proposal requires all bidders and all bidder's subcontractors to disclose participation in apprenticeship or training programs that are (1) approved by and registered with the United States Department of Labor's Bureau of Apprenticeship and Training, and (2) applicable to the work of the above indicated proposals or groups. Therefore, all bidders are required to complete the following certification:

1. Except as provided in paragraph 4 below, the undersigned bidder certifies that it is a participant, either as an individual or as part of a group program, in an approved apprenticeship or training program applicable to each type of work or craft that the bidder will perform with its own employees.
2. The undersigned bidder further certifies, for work to be performed by subcontract, that each of its subcontractors either (A) is, at the time of such bid, participating in an approved, applicable apprenticeship or training program; or (B) will, prior to commencement of performance of work pursuant to this contract, establish participation in an approved apprenticeship or training program applicable to the work of the subcontract.
3. The undersigned bidder, by inclusion in the list in the space below, certifies the official name of each program sponsor holding the Certificate of Registration for all of the types of work or crafts in which the bidder is a participant and that will be performed with the bidder's employees. Types of work or craft that will be subcontracted shall be included and listed as subcontract work. The list shall also indicate any type of work or craft job category for which there is no applicable apprenticeship or training program available.

Please see attached.

4. Except for any work identified above, if any bidder or subcontractor shall perform all or part of the work of the contract or deliver and install proposal solely by individual owners, partners or members and not by employees to whom the payment of prevailing rates of wages would be required, check the following box, and identify the owner/operator workforces and positions of ownership.

The requirements of this certification and disclosure are a material part of the contract, and the contractor shall require this certification provision to be included in all approved subcontracts. The bidder is responsible for making a complete report and shall make certain that each type of work or craft job category that will be utilized on the project is accounted for and listed. The Department at any time before or afterward may require the production of a copy of each applicable Certificate of Registration issued by the United States Department of Labor evidencing such participation by the contractor and any or all of its subcontractors. In order to fulfill the participation requirement, it shall not be necessary that any applicable program sponsor be currently taking or that it will take applications for apprenticeship, training or employment during the performance of the work of this contract or deliver and install proposal.

Bidder	Signature	Date
Scott A. Marquart		3/9/2023
Title		
Vice President		
Address	City	State Zip Code
1166 Lake Ave.	Woodstock	IL 60098

**K. Apprenticeship and Training Certification**

- 1. DuPage County Cement Masons Local #803 Joint Apprenticeship Committee**
- 2. Bureau of Apprenticeship and Training Operating Engineers Local #150**
- 3. Chicagoland Laborers Training and Apprenticeship Program**
- 4. Cement Masons Area Joint Apprenticeship and Cement Masons Union Local #502**
- 5. Chicago and Northeast Illinois District Council of Carpenters Apprenticeship and Training Program**



Affidavit of Illinois Business Office



Local Public Agency	County	Street Name/Road Name	Section Number
Village of Buffalo Grove	Cook/Lake	Various Street Segments	

I, Scott A. Marquart of Woodstock, IL,  
Name of Affiant City of Affiant State of Affiant

being first duly sworn upon oath, state as follows:

1. That I am the Vice President of Alliance Contractors, Inc.  
Officer or Position Bidder
2. That I have personal knowledge of the facts herein stated.
3. That, if selected under the proposal described above, Alliance Contractors, Inc., will maintain a business office in the  
Bidder  
 State of Illinois, which will be located in McHenry County, Illinois.  
County
4. That this business office will serve as the primary place of employment for any persons employed in the construction contemplated by this proposal.
5. That this Affidavit is given as a requirement of state law as provided in Section 30-22(8) of the Illinois Procurement Code.

Signature	Date
<i>Scott A. Marquart</i>	3/9/2023
Print Name of Affiant	
Scott A. Marquart, Vice President	

Notary Public

State of IL  
 County McHenry

Signed (or subscribed or attested) before me on 3/9/2023 by  
(date)

Scott A. Marquart, authorized agent(s) of  
(name/s of person/s)  
Alliance Contractors, Inc.  
Bidder

Signature of Notary Public

*[Signature]*

My commission expires 5/13/26

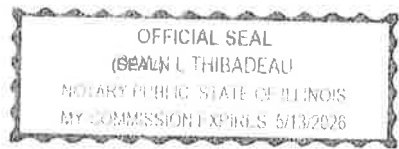

# Illinois Department of Transportation

Bureau of Construction  
2300 South Dirksen Parkway/ Room 322  
Springfield, Illinois 62764

## Affidavit of Availability

For the Letting of: March 9, 2023

Instructions: Complete this form by either typing or using black ink. "Authorization to Bid" will not be issued unless both sides of this form are completed in detail. Use additional forms as needed to list all work.

### Part I. Work Under Contract

List below all work you have under contract as either a prime contractor or a subcontractor. It is required to include all pending low bids not yet awarded or rejected. In a joint venture, list only that portion of the work which is the responsibility of your company. The uncompleted dollar value is to be based upon the most recent engineer's or owners estimate, and must include work subcontracted to others. If no work is contracted, show **NONE**.

	1	2	3	4	Awards Pending	
	21024	Cont.	22001	Cont.		
Contract Number	62633		62K02			
Contract With	IDOT		IDOT			
Estimated Completion Date	5/1/2023		7/1/2023			Accumulated
Total Contract Price	\$4,496,491.00		\$2,935,409.00			Totals
Uncompleted Dollar Value if Firm is the Prime Contractor	\$46,480.00		\$275,876.00			\$322,356.00
Uncompleted Dollar Value if Firm is the Subcontractor						\$0.00
						\$322,356.00

### Part II. Awards Pending and Uncompleted Work to be done with your own forces.

List below the uncompleted dollar value of work for each contract and awards pending to be completed with your own forces. All work subcontracted to others will be listed on the reverse of this form. In a joint venture, list only that portion of the work to be done by your company. If no work is contracted, show **NONE**.

					Accumulated Totals
Earthwork			\$28,434.00		\$28,434.00
Portland Cement Concrete Paving					\$0.00
HMA Plant Mix					\$0.00
HMA Paving					\$0.00
Clean & Seal Cracks / Joints					\$0.00
Aggregate Bases & Surfaces			\$7,216.00		\$7,216.00
Highway R.R. and Waterway Structures					\$0.00
Drainage					\$0.00
Electrical					\$0.00
Cover and Seal Coats					\$0.00
Concrete Construction	\$4,325.00		\$198,010.00		\$202,335.00
Landscaping					\$0.00
Fencing					\$0.00
Guardrail					\$0.00
Temp Soil Retention	9th				\$0.00
Sound Wall	March				\$0.00
Cold Milling, Planning & Rotomilling					\$0.00
Demolition					\$0.00
Pavement Markings (Paint)					\$0.00
Signing					\$0.00
Layout					\$0.00
Totals	\$4,325.00	\$0.00	\$233,660.00	\$0.00	\$0.00
					\$237,985.00

Disclosure of this information is **REQUIRED** to accomplish the statutory purpose as outlined in the "Illinois Procurement Code". Failure to comply will result in non-issuance of an "Authorization To Bid." This form has been approved by the State Forms Management Center.

**Part III. Work Subcontracted to Others.**

3/9/2023

For each contract described in Part 1, list all the work you have subcontracted to others.

	1	Cont.	3	Cont.	Awards Pending
Subcontractor	Resource Illinois	Clean Cut	Schroeder	Mackie	
Type of Work	Spl Waste	Tree Removal	Asphalt	Const. Layout	
Subcontract Price	\$87,700.00	\$5,970.00	\$638,575.00	\$15,900.00	
Amount Uncompleted	\$0.00	\$0.00	\$0.00	\$0.00	
Subcontractor	Galaxy	LPS	Elmund Nelson	Lands. By G. Weiss	
Type of Work	SS	Brick	Electrical	Landscaping	
Subcontract Price	\$52,165.00	\$39,744.00	\$724,624.00	\$38,268.00	
Amount Uncompleted	\$0.00	\$0.00	\$0.00	\$0.00	
Subcontractor	D2K	Mackie	Horvath		
Type of Work	Traffic Control	Const. Layout	Spl Waste		
Subcontract Price	\$381,096.00	\$34,900.00	\$88,400.00		
Amount Uncompleted	\$0.00	\$0.00	\$0.00		
Subcontractor	Peter Baker	Home Towne	D2K		
Type of Work	Asphalt	Electrical	Pvt Marking		
Subcontract Price	\$1,035,928.00	\$1,103,289.00	\$29,656.00		
Amount Uncompleted	\$0.00	\$42,155.00	\$29,656.00		
Subcontractor	Espinoza		Traffic Contr & Prot		
Type of Work	Landscaping		Traffic Control		
Subcontract Price	\$33,119.00		\$107,570.00		
Amount Uncompleted	\$0.00		\$12,560.00		
<b>Total Uncompleted</b>	\$0.00	\$42,155.00	\$42,216.00	\$0.00	\$0.00

I, being duly sworn, do hereby declare that this affidavit is a true and correct statement relating to ALL uncompleted contracts of the undersigned for Federal, State, County, City and private work, including ALL subcontract work, ALL pending low bids not yet awarded or rejected and ALL estimated completion dates.

Subscribed and sworn to before me  
 this 9th day of  
March 2023

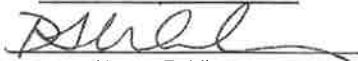
  
 Notary Public

My commission expires 5/13/2026



Type or Print Name Scott A. Marquart, Vice President  
Officer or director Title

Signed 

Company Alliance Contractors, Inc.

Address 1166 Lake Avenue  
Woodstock, Illinois 60098

# Illinois Department of Transportation

Bureau of Construction  
2300 South Dirksen Parkway/ Room 322  
Springfield, Illinois 62764

## Affidavit of Availability

For the Letting of: March 9, 2023

Instructions: Complete this form by either typing or using black ink. "Authorization to Bid" will not be issued unless both sides of this form are completed in detail. Use additional forms as needed to list all work.

### Part I. Work Under Contract

List below all work you have under contract as either a prime contractor or a subcontractor. It is required to include all pending low bids not yet awarded or rejected. In a joint venture, list only that portion of the work which is the responsibility of your company. The uncompleted dollar value is to be based upon the most recent engineer's or owners estimate, and must include work subcontracted to others. If no work is contracted, show **NONE**.

	5	6	7	8	
	22009	Cont.	Cont.	22011	Cont.
Contract Number	61H35			61E87	
Contract With	IDOT			IDOT	
Estimated Completion Date	6/1/2023			12/1/2023	Accumulated
Total Contract Price	\$1,093,662.00			\$4,371,729.00	Totals
Uncompleted Dollar Value if Firm is the Prime Contractor	\$568,559.00			\$4,371,729.00	\$5,262,644.00
Uncompleted Dollar Value if Firm is the Subcontractor					\$0.00
					\$5,262,644.00

### Part II. Awards Pending and Uncompleted Work to be done with your own forces.

List below the uncompleted dollar value of work for each contract and awards pending to be completed with your own forces. All work subcontracted to others will be listed on the reverse of this form. In a joint venture, list only that portion of the work to be done by your company. If no work is contracted, show **NONE**.

					Accumulated Totals
Earthwork	\$56,412.00			\$565,263.00	\$650,109.00
Portland Cement Concrete Paving	\$34,088.00			\$290,213.00	\$324,301.00
HMA Plant Mix					\$0.00
HMA Paving					\$0.00
Clean & Seal Cracks / Joints					\$0.00
Aggregate Bases & Surfaces	\$6,547.00			\$115,097.00	\$129,760.00
Highway, R.R. and Waterway Structures					\$0.00
Drainage					\$0.00
Electrical					\$0.00
Cover and Seal Coats					\$0.00
Concrete Construction	\$57,089.00			\$273,315.00	\$532,739.00
Landscaping					\$0.00
Fencing					\$0.00
Guardrail					\$0.00
Temp Soil Retention	9th				\$0.00
Sound Wall	March				\$0.00
Cold Milling, Planning & Rotomilling					\$0.00
Demolition					\$0.00
Pavement Markings (Paint)					\$0.00
Signing					\$0.00
Layout					\$0.00
Totals	\$154,136.00	\$0.00	\$0.00	\$1,244,788.00	\$0.00
					\$1,636,909.00

Disclosure of this information is **REQUIRED** to accomplish the statutory purpose as outlined in the "Illinois Procurement Code". Failure to comply will result in non-issuance of an "Authorization To Bid." This form has been approved by the State Forms Management Center.



**Part III. Work Subcontracted to Others.**

3/9/2023

For each contract described in Part 1, list all the work you have subcontracted to others.

	5	Cont.	Cont.	8	Cont.
Subcontractor	Homer	Western Remac	Metromex	Resource Cons.	Traffic Contr & Prot
Type of Work	Tree Removal	Signage	Asphalt	Spl Waste	Traffic Control
Subcontract Price	\$8,453.00	\$24,408.00	\$111,580.00	\$24,625.00	\$133,163.00
Amount Uncompleted	<b>\$0.00</b>	<b>\$24,408.00</b>	<b>\$111,580.00</b>	<b>\$24,625.00</b>	<b>\$133,163.00</b>
Subcontractor	Resource Cons.	Utility Dynamics		Lands. By G Weiss	Ray Edwards
Type of Work	Spl Waste	Electrical		Landscaping	Underground
Subcontract Price	\$76,522.00	\$170,368.00		\$300,000.00	\$601,087.00
Amount Uncompleted	<b>\$16,724.00</b>	<b>\$112,045.00</b>		<b>\$300,000.00</b>	<b>\$601,087.00</b>
Subcontractor	Quigg Eng.	Work Zone Safety		Clean Cut	Home Towne
Type of Work	Const. Layout	Traffic Control		Tree Removal	Electrical
Subcontract Price	\$5,965.00	\$39,282.00		\$5,375.00	\$669,567.00
Amount Uncompleted	<b>\$1,965.00</b>	<b>\$21,715.00</b>		<b>\$5,375.00</b>	<b>\$669,567.00</b>
Subcontractor	A. Horn	Conin		Mackie Cons.	Northern
Type of Work	Masonry	Landscaping		Const. Layout	Railing
Subcontract Price	\$62,920.00	\$40,230.00		\$22,500.00	\$131,232.00
Amount Uncompleted	<b>\$62,920.00</b>	<b>\$40,230.00</b>		<b>\$22,500.00</b>	<b>\$131,232.00</b>
Subcontractor	Northern	Marking Spec.		Traffic Control Co.	Schroeder
Type of Work	Railing	Pvt Marking		Pvt Marking	Asphalt
Subcontract Price	\$8,000.00	\$14,836.00		\$24,392.00	\$1,215,000.00
Amount Uncompleted	<b>\$8,000.00</b>	<b>\$14,836.00</b>		<b>\$24,392.00</b>	<b>\$1,215,000.00</b>
Total Uncompleted	\$89,609.00	\$213,234.00	\$111,580.00	\$376,892.00	\$2,750,049.00

I, being duly sworn, do hereby declare that this affidavit is a true and correct statement relating to ALL uncompleted contracts of the undersigned for Federal, State, County, City and private work, including ALL subcontract work, ALL pending low bids not yet awarded or rejected and ALL estimated completion dates.

Subscribed and sworn to before me  
this 9th day of  
March 2023

  
Notary Public

My commission expires 5/13/2026

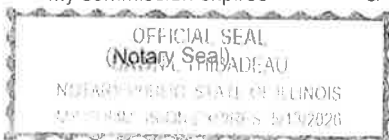

Type or Print Name Scott A. Marquart, Vice President  
Officer or director Title

Signed



Company

Alliance Contractors, Inc.

Address

1166 Lake Avenue  
Woodstock, Illinois 60098

# Illinois Department of Transportation

Bureau of Construction  
2300 South Dirksen Parkway/ Room 322  
Springfield, Illinois 62764

## Affidavit of Availability

For the Letting of: March 9, 2023

Instructions: Complete this form by either typing or using black ink. "Authorization to Bid" will not be issued unless both sides of this form are completed in detail. Use additional forms as needed to list all work.

### Part I. Work Under Contract

List below all work you have under contract as either a prime contractor or a subcontractor. It is required to include all pending low bids not yet awarded or rejected. In a joint venture, list only that portion of the work which is the responsibility of your company. The uncompleted dollar value is to be based upon the most recent engineer's or owners estimate, and must include work subcontracted to others. If no work is contracted, show **NONE**.

	9 22018	10 Cont.	11 22017	12 22018	Awards Pending	
Contract Number	62D30		61H61			
Contract With	IDOT		Home Towne	DuPage Co. Forest Preserve		
Estimated Completion Date	8/1/2023		6/1/2023	5/15/2023		Accumulated
Total Contract Price	\$6,228,576.00		\$14,391.00	\$1,264,628.00		Totals
Uncompleted Dollar Value if Firm is the Prime Contractor	\$6,228,576.00		\$14,391.00	\$123,964.00		\$11,629,575.00
Uncompleted Dollar Value if Firm is the Subcontractor						\$0.00
Total Value of Work						\$11,629,575.00

### Part II. Awards Pending and Uncompleted Work to be done with your own forces.

List below the uncompleted dollar value of work for each contract and awards pending to be completed with your own forces. All work subcontracted to others will be listed on the reverse of this form. In a joint venture, list only that portion of the work to be done by your company. If no work is contracted, show **NONE**.

					Accumulated Totals	
Earthwork	\$636,486.00		\$5,632.00		\$1,292,227.00	
Portland Cement Concrete Paving	\$1,690,967.00				\$2,015,268.00	
HMA Plant Mix					\$0.00	
HMA Paving					\$0.00	
Clean & Seal Cracks / Joints					\$0.00	
Aggregate Bases & Surfaces	\$204,949.00				\$334,709.00	
Highway, R.R. and Waterway Structures	\$190,870.00			\$10,244.00	\$201,114.00	
Drainage	\$142,290.00				\$142,290.00	
Electrical					\$0.00	
Cover and Seal Coats					\$0.00	
Concrete Construction	\$275,886.00		\$8,759.00		\$817,384.00	
Landscaping					\$0.00	
Fencing					\$0.00	
Guardrail					\$0.00	
Temp Soil Retention	9th				\$0.00	
Sound Wall	March				\$0.00	
Cold Milling, Planning & Rotomilling					\$0.00	
Demolition					\$0.00	
Pavement Markings (Paint)					\$0.00	
Signing					\$0.00	
Layout					\$0.00	
Totals	\$3,141,448.00	\$0.00	\$14,391.00	\$10,244.00	\$0.00	\$4,802,992.00

Disclosure of this information is **REQUIRED** to accomplish the statutory purpose as outlined in the "Illinois Procurement Code". Failure to comply will result in non-issuance of an "Authorization To Bid". This form has been approved by the State Forms Management Center.

**Part III. Work Subcontracted to Others.**

3/9/2023

For each contract described in Part 1, list all the work you have subcontracted to others.

	9	Cont.	11	12	Awards Pending
Subcontractor	JA Johnson	Traf Contr & Prot		McGinty	
Type of Work	Asphalt	Traffic Control		Landscaping	
Subcontract Price	\$270,148.00	\$252,202.00		\$26,234.00	
Amount Uncompleted	<b>\$270,148.00</b>	<b>\$252,202.00</b>		<b>\$0.00</b>	
Subcontractor	Home Towne	Lands, by G Weiss		Bach Steel	
Type of Work	Electrical	Landscaping		Iron Work	
Subcontract Price	\$707,753.00	\$198,156.00		\$384,829.00	
Amount Uncompleted	<b>\$707,753.00</b>	<b>\$198,156.00</b>		<b>\$113,720.00</b>	
Subcontractor	Abitua	Geo Eng.		Mackie	
Type of Work	Underground	Spl Waste		Const. Layout	
Subcontract Price	\$1,483,904.00	\$32,350.00		\$5,800.00	
Amount Uncompleted	<b>\$1,483,904.00</b>	<b>\$32,350.00</b>		<b>\$0.00</b>	
Subcontractor	CES	Clean Cut			
Type of Work	Const. Layout	Tree Removal			
Subcontract Price	\$36,450.00	\$31,830.00			
Amount Uncompleted	<b>\$36,450.00</b>	<b>\$31,830.00</b>			
Subcontractor	Precision	Northern			
Type of Work	Pvt Marking	Railing			
Subcontract Price	\$40,899.00	\$33,436.00			
Amount Uncompleted	<b>\$40,899.00</b>	<b>\$33,436.00</b>			
Total Uncompleted	\$2,539,154.00	\$547,974.00	\$0.00	\$113,720.00	\$0.00

I, being duly sworn, do hereby declare that this affidavit is a true and correct statement relating to ALL uncompleted contracts of the undersigned for Federal, State, County, City and private work, including ALL subcontract work, ALL pending low bids not yet awarded or rejected and ALL estimated completion dates.

Subscribed and sworn to before me  
 this 9th day of  
March 2023

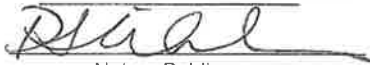
  
 Notary Public

My commission expires 5/13/2026



Type or Print Name Scott A. Marquart, Vice President  
 Officer or director Title

Signed 

Company Alliance Contractors, Inc.

Address 1166 Lake Avenue  
Woodstock, Illinois 60098

# Illinois Department of Transportation

Bureau of Construction  
2300 South Dirksen Parkway/ Room 322  
Springfield, Illinois 62764

## Affidavit of Availability

For the Letting of: March 9, 2023

Instructions: Complete this form by either typing or using black ink. "Authorization to Bid" will not be issued unless both sides of this form are completed in detail. Use additional forms as needed to list all work.

### Part I. Work Under Contract

List below all work you have under contract as either a prime contractor or a subcontractor. It is required to include all pending low bids not yet awarded or rejected. In a joint venture, list only that portion of the work which is the responsibility of your company. The uncompleted dollar value is to be based upon the most recent engineer's or owners estimate, and must include work subcontracted to others. If no work is contracted, show **NONE**.

	13 22023	14 Cont.	15 22036	16 Cont.	Awards Pending	
Contract Number	61H71		61H44			
Contract With	IDOT		IDOT			
Estimated Completion Date	10/1/2023		10/1/2023			Accumulated
Total Contract Price	\$5,262,614.00		\$8,264,103.00			Totals
Uncompleted Dollar Value if Firm is the Prime Contractor	\$5,262,614.00		\$8,264,103.00			\$25,156,292.00
Uncompleted Dollar Value if Firm is the Subcontractor						\$0.00
						\$25,156,292.00

### Part II. Awards Pending and Uncompleted Work to be done with your own forces.

List below the uncompleted dollar value of work for each contract and awards pending to be completed with your own forces. All work subcontracted to others will be listed on the reverse of this form. In a joint venture, list only that portion of the work to be done by your company. If no work is contracted, show **NONE**.

					Accumulated Totals
Earthwork	\$470,195.00		\$774,279.00		\$2,536,701.00
Portland Cement Concrete Paving	\$798,060.00		\$1,199,369.00		\$4,012,717.00
HMA Plant Mix					\$0.00
HMA Paving					\$0.00
Clean & Seal Cracks / Joints					\$0.00
Aggregate Bases & Surfaces	\$401,264.00		\$417,971.00		\$1,153,944.00
Highway, R.R. and Waterway Structures			\$218,751.00		\$419,865.00
Drainage	\$1,130,400.00		\$467,050.00		\$1,739,740.00
Electrical					\$0.00
Cover and Seal Coats					\$0.00
Concrete Construction	\$413,438.00		\$617,461.00		\$1,848,283.00
Landscaping					\$0.00
Fencing					\$0.00
Guardrail					\$0.00
Temp Soil Retention	9th				\$0.00
Sound Wall	March				\$0.00
Cold Milling, Planning & Rotomilling					\$0.00
Demolition					\$0.00
Pavement Markings (Paint)					\$0.00
Signage					\$0.00
Layout					\$0.00
Totals	\$3,213,377.00	\$0.00	\$3,694,881.00	\$0.00	\$11,711,250.00

Disclosure of this information is **REQUIRED** to accomplish the statutory purpose as outlined in the "Illinois Procurement Code". Failure to comply will result in non-issuance of an "Authorization To Bid". This form has been approved by the State Forms Management Center.

**Part III. Work Subcontracted to Others.**

3/9/2023

For each contract described in Part 1, list all the work you have subcontracted to others.

	13	Cont.	15	Cont.	Awards Pending
Subcontractor	JEM	Homer	Home Towne	Traffic Contr & Prot	
Type of Work	Traffic Control	Tree Removal	Electrical	Traffic Control	
Subcontract Price	\$175,172.00	\$16,493.00	\$3,061,118.00	\$147,394.00	
Amount Uncompleted	<b>\$175,172.00</b>	<b>\$16,493.00</b>	<b>\$3,061,118.00</b>	<b>\$147,394.00</b>	
Subcontractor	Metromex	Roadway Lines	McGinty	Maint Coatings	
Type of Work	Asphalt	Pvt Marking	Tree Rem	Pvt Marking	
Subcontract Price	\$559,715.00	\$21,595.00	\$9,792.00	\$60,976.00	
Amount Uncompleted	<b>\$559,715.00</b>	<b>\$21,595.00</b>	<b>\$9,792.00</b>	<b>\$60,976.00</b>	
Subcontractor	Berger	Arteaga	Arteaga	Schroeder	
Type of Work	Underground	Landscaping	Landscaping	Asphalt	
Subcontract Price	\$640,220.00	\$155,021.00	\$69,908.00	\$960,742.00	
Amount Uncompleted	<b>\$640,220.00</b>	<b>\$155,021.00</b>	<b>\$69,908.00</b>	<b>\$960,742.00</b>	
Subcontractor	Resource III.	Elmund Nelson	Brownfield	Surface Const.	
Type of Work	Spl Waste	Electrical	Spl Waste	Asphalt Stamping	
Subcontract Price	\$15,500.00	\$450,031.00	\$35,800.00	\$179,329.00	
Amount Uncompleted	<b>\$15,500.00</b>	<b>\$450,031.00</b>	<b>\$35,800.00</b>	<b>\$179,329.00</b>	
Subcontractor	Quigg		Mackie	LPS	
Type of Work	Const. Layout		Const. Layout	Brick	
Subcontract Price	\$15,490.00		\$29,500.00	\$14,663.00	
Amount Uncompleted	<b>\$15,490.00</b>		<b>\$29,500.00</b>	<b>\$14,663.00</b>	
Total Uncompleted	\$1,406,097.00	\$643,140.00	\$3,206,118.00	\$1,363,104.00	\$0.00

I, being duly sworn, do hereby declare that this affidavit is a true and correct statement relating to ALL uncompleted contracts of the undersigned for Federal, State, County, City and private work, including ALL subcontract work, ALL pending low bids not yet awarded or rejected and ALL estimated completion dates.

Subscribed and sworn to before me  
 this 9th day of  
March 2023

  
 Notary Public

My commission expires 5/13/2026

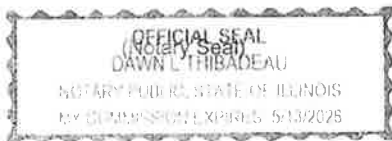

Type or Print Name Scott A. Marquart, Vice President  
Officer or director Title

Signed 

Company Alliance Contractors, Inc.

Address 1166 Lake Avenue  
Woodstock, Illinois 60098

# Illinois Department of Transportation

Bureau of Construction  
2300 South Dirksen Parkway/ Room 322  
Springfield, Illinois 62764

## Affidavit of Availability

For the Letting of: March 9, 2023

Instructions: Complete this form by either typing or using black ink. "Authorization to Bid" will not be issued unless both sides of this form are completed in detail. Use additional forms as needed to list all work.

### Part I. Work Under Contract

List below all work you have under contract as either a prime contractor or a subcontractor. It is required to include all pending low bids not yet awarded or rejected. In a joint venture, list only that portion of the work which is the responsibility of your company. The uncompleted dollar value is to be based upon the most recent engineer's or owners estimate, and must include work subcontracted to others. If no work is contracted, show **NONE**.

	17	18	19	20	Awards Pending	
	22052	Cont.	23002		23001	
Contract Number						
Contract With	Carol Stream		Bolder		Campanella	
Estimated Completion Date	6/30/2023		8/1/2023		8/1/2023	Accumulated
Total Contract Price	\$452,315.00		\$32,300.00		\$190,440.00	Totals
Uncompleted Dollar Value if Firm is the Prime Contractor	\$452,315.00					\$25,608,607.00
Uncompleted Dollar Value if Firm is the Subcontractor			\$32,300.00		\$190,440.00	\$222,740.00
Total Value of Work						\$25,831,347.00

### Part II. Awards Pending and Uncompleted Work to be done with your own forces.

List below the uncompleted dollar value of work for each contract and awards pending to be completed with your own forces. All work subcontracted to others will be listed on the reverse of this form. In a joint venture, list only that portion of the work to be done by your company. If no work is contracted, show **NONE**.

					Accumulated Totals	
Earthwork	\$44,816.00				\$2,581,517.00	
Portland Cement Concrete Paving					\$4,012,717.00	
HMA Plant Mix					\$0.00	
HMA Paving					\$0.00	
Clean & Seal Cracks / Joints					\$0.00	
Aggregate Bases & Surfaces	\$17,087.00				\$1,171,031.00	
Highway, R.R., and Waterway Structures	\$209,163.00				\$629,028.00	
Drainage	\$72,120.00				\$1,811,860.00	
Electrical					\$0.00	
Cover and Seal Coats					\$0.00	
Concrete Construction			\$32,300.00	\$190,440.00	\$2,071,023.00	
Landscaping					\$0.00	
Fencing					\$0.00	
Guardrail					\$0.00	
Temp Soil Retention	9th				\$0.00	
Sound Wall	March				\$0.00	
Cold Milling, Planning & Rotomilling					\$0.00	
Demolition					\$0.00	
Pavement Markings (Paint)					\$0.00	
Signing					\$0.00	
Layout					\$0.00	
<b>Totals</b>	<b>\$343,186.00</b>	<b>\$0.00</b>	<b>\$32,300.00</b>	<b>\$0.00</b>	<b>\$190,440.00</b>	<b>\$12,277,176.00</b>

Disclosure of this information is **REQUIRED** to accomplish the statutory purpose as outlined in the "Illinois Procurement Code". Failure to comply will result in non-issuance of an "Authorization To Bid." This form has been approved by the State Forms Management Center.

**Part III. Work Subcontracted to Others.**

3/9/2023

For each contract described in Part 1, list all the work you have subcontracted to others.

	17	Cont.	19	20	Awards Pending
Subcontractor	TAT	Work Zone Safety			
Type of Work	Asphalt	Traffic Control			
Subcontract Price	\$33,149.00	\$10,400.00			
Amount Uncompleted	<b>\$33,149.00</b>	<b>\$10,400.00</b>			
Subcontractor	Sincere	Hamilton			
Type of Work	Landscaping	Const. Layout			
Subcontract Price	\$10,685.00	\$4,180.00			
Amount Uncompleted	<b>\$10,685.00</b>	<b>\$4,180.00</b>			
Subcontractor	Clean Cut	MA Rebar			
Type of Work	Tree Removal	Rebar Setting			
Subcontract Price	\$3,120.00	\$17,000.00			
Amount Uncompleted	<b>\$3,120.00</b>	<b>\$17,000.00</b>			
Subcontractor	Northern				
Type of Work	Railing				
Subcontract Price	\$23,115.00				
Amount Uncompleted	<b>\$23,115.00</b>				
Subcontractor	AC				
Type of Work	Pavt Marking				
Subcontract Price	\$7,480.00				
Amount Uncompleted	<b>\$7,480.00</b>				
<b>Total Uncompleted</b>	<b>\$77,549.00</b>	<b>\$31,580.00</b>	<b>\$0.00</b>	<b>\$0.00</b>	<b>\$0.00</b>

I, being duly sworn, do hereby declare that this affidavit is a true and correct statement relating to ALL uncompleted contracts of the undersigned for Federal, State, County, City and private work, including ALL subcontract work, ALL pending low bids not yet awarded or rejected and ALL estimated completion dates.

Subscribed and sworn to before me  
 this 9th day of  
March 2023

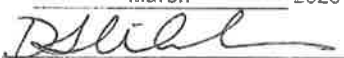
  
 Notary Public

My commission expires 5/13/2026

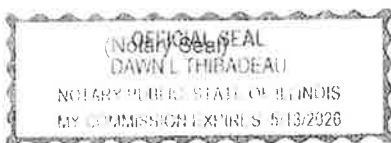

Type or Print Name Scott A. Marquart, Vice President  
 Officer or director Title

Signed 

Company Alliance Contractors, Inc.

Address 1166 Lake Avenue  
Woodstock, Illinois 60098

**EXHIBIT A - PUBLIC CONTRACT STATEMENT**

This Public Contract Statement (the "Contract Statement") has been executed by the below supplier, Contractor or vendor (collectively the "Contractor") in order for the Village of Buffalo Grove to obtain certain information necessary prior to awarding a public contract. The Contract Statement shall be executed and notarized and submitted as part of the Bid Proposal.

**CERTIFICATION OF CONTRACTOR/BIDDER**

In order to comply with 720 Illinois Compiled Statutes 5/33 E-1 et seq., the Village of Buffalo Grove requires the following certification be acknowledged:

The Contractor certifies that it is not barred from bidding or supplying any goods, services or construction let by the Village of Buffalo Grove with or without bid, due to any violation of either Section 5/33 E-3 or 5/33 E-4 of Article 33E, Public Contracts, of the Chapter 720 of the Illinois Compiled Statutes, as amended. This act relates to interference with public contracting, bid rigging and rotating, kickbacks, and bidding.

**CERTIFICATION RELATIVE TO 65 ILCS 5/11-42.1.1**

In order to comply with 65 Illinois Compiled Statutes 5/11-42.1.1, the Village of Buffalo Grove requires the following certification:

The Contractor does hereby swear and affirm that it is not delinquent in the payment of any tax administered by the Illinois Department of Revenue unless it is contesting such tax in accordance with the procedures established by the appropriate revenue act, its liability for the tax or the amount of the tax. The undersigned further understands that making a false statement herein: (1) is a Class A misdemeanor, and (2) voids the contract and allows the Village to recover all amounts paid to it under the contract.

**CONFLICT OF INTEREST**

The Village of Buffalo Grove Municipal Code requires the following verification relative to conflict of interest and compliance with general ethics requirements of the Village:

The Contractor represents and warrants to the Village of Buffalo Grove as a term and condition of acceptance of their Bid Proposal that none of the following Village officials is either an officer or director of Contractor nor owns five percent (5%) or more of the Contractor: the Village President, the members of the Village Board of Trustees, the Village Clerk, the Village Treasurer, the members of the Zoning Board of Appeals and the Plan Commission, the Village Manager and his/her Assistant, or the heads of the various departments within the Village.

If the foregoing representation and warranty is inaccurate, state the name of the Village official who either is an officer or director of your business entity or owns five percent (5%) or more thereof: N/A

IN WITNESS WHEREOF, the below Contractor has signed and sealed this Contract Statement as of this 9th day of March, 2023.

Alliance Contractors, Inc.

Print Name of Contractor

Scott A. Marquart  
Signature

Scott A. Marquart, Vice President

Print Title

Given under my hand and official seal, this 9th day of March, 2023

D. Salvo  
Notary Public





**Description of Work**  
**2023 New Sidewalk Improvements Project**  
**Village of Buffalo Grove**

This project includes the construction of new sidewalks on local streets within the Village of Buffalo Grove right-of-way. They will serve as extensions between existing sidewalks to make travel for the public both safer and easier. Removal and replacement of an existing commercial driveway and associated curb and gutter is proposed to maintain ADA compliance. These proposed improvements are considered new construction at various locations throughout the Village Limits.

The following is a list of streets including limits, and a brief description of work:

---

<b>Street</b>	<b>From/To</b>
Barclay Blvd	Busch Pkwy to Deerfield Pkwy
Busch Parkway	Barclay Blvd to N. Milwaukee Ave
Chicory Lane	Chicory Ln to Weiland Rd

The above street segments will include tree removal, earth excavation, new sidewalk construction, commercial driveway pavement removal & replacement, curb and gutter removal & replacement, structure adjustments, landscape restoration, and other associated improvements.

## SUMMARY OF QUANTITIES

ITEM NO	DESCRIPTION	UNIT	QUANTITY	Busch Pkwy and Barclay Blvd	Chicory Ct and Weiland Rd
20100210	TREE REMOVAL (OVER 15 UNITS DIAMETER)	UN	20.0	20.0	
20101100	TREE TRUNK PROTECTION	EA	3.0	2.0	1.0
20101200	TREE ROOT PRUNING	EA	3.0	3.0	
20201200	REMOVAL AND DISPOSAL OF UNSUITABLE MATERIAL	CY	30.0	25.0	5.0
21001000	GEO TECHNICAL FABRIC FOR GROUND STABILIZATION	SY	75.0	75.0	
28000510	INLET FILTERS	EA	5.0	4.0	1.0
30300001	AGGREGATE SUBGRADE IMPROVEMENT	CY	30.0	25.0	5.0
42300400	PORTLAND CEMENT CONCRETE DRIVEWAY PAVEMENT, 8 INCH	SY	160.0	160.0	
42400200	PORTLAND CEMENT CONCRETE SIDEWALK, 5 INCH	SF	6,660.0	6,500.0	160.0
44000200	DRIVEWAY PAVEMENT REMOVAL	SY	160.0	160.0	
44000500	COMBINATION CURB AND GUTTER REMOVAL	FT	250.0	250.0	
67100100	MOBILIZATION	LS	1.0	1.0	
70102620	TRAFFIC CONTROL AND PROTECTION, STANDARD 701501	LS	1.0	1.0	
70102640	TRAFFIC CONTROL AND PROTECTION, STANDARD 701801	LS	1.0	1.0	
X2600012	REMOVE AND RELOCATE SIGN PANEL AND POLE ASSEMBLY	EA	4.0	4.0	
-	GENERAL LANDSCAPE RESTORATION (SPECIAL)	SY	580.0	530.0	50.0
-	AGGREGATE BASE COURSE, TYPE B VARIES (SPECIAL)	TN	250.0	240.0	10.0
-	COMBINATION CONCRETE CURB AND GUTTER, TYPE B-6.12 (SPECIAL)	FT	250.0	250.0	
-	6 INCH BARRIER CURB, VARIABLE HEIGHT (SPECIAL)	FT	85.0	85.0	
-	SANITARY MANHOLES TO BE ADJUSTED (SPECIAL)	EA	1.0	1.0	
-	SANITARY MANHOLES TO BE RECONSTRUCTED (SPECIAL)	EA	1.0	1.0	
-	DRAINAGE AND UTILITY STRUCTURES TO BE ADJUSTED (SPECIAL)	EA	3.0	3.0	
-	EXPLORATION EXCAVATION (SPECIAL)	EA	3.0	3.0	
-	STUMP REMOVAL	EA	4.0		4.0
-	PVC SLEEVE, 6 INCH	EA	1.0	1.0	



**Check Sheet for Recurring Special Provisions**

Local Public Agency	County	Section Number
Village of Buffalo Grove	Cook/Lake	

Check this box for lettings prior to 01/01/2023.

The Following Recurring Special Provisions Indicated By An "X" Are Applicable To This Contract And Are Included By Reference:

Recurring Special Provisions

<u>Check Sheet #</u>		<u>Page No.</u>
1	<input type="checkbox"/> Additional State Requirements for Federal-Aid Construction Contracts	53
2	<input type="checkbox"/> Subletting of Contracts (Federal-Aid Contracts)	56
3	<input type="checkbox"/> EEO	57
4	<input type="checkbox"/> Specific EEO Responsibilities Non Federal-Aid Contracts	67
5	<input type="checkbox"/> Required Provisions - State Contracts	72
6	<input type="checkbox"/> Asbestos Bearing Pad Removal	78
7	<input type="checkbox"/> Asbestos Waterproofing Membrane and Asbestos HMA Surface Removal	79
8	<input type="checkbox"/> Temporary Stream Crossings and In-Stream Work Pads	80
9	<input type="checkbox"/> Construction Layout Stakes	81
10	<input type="checkbox"/> Use of Geotextile Fabric for Railroad Crossing	84
11	<input type="checkbox"/> Subsealing of Concrete Pavements	86
12	<input type="checkbox"/> Hot-Mix Asphalt Surface Correction	90
13	<input type="checkbox"/> Pavement and Shoulder Resurfacing	92
14	<input type="checkbox"/> Patching with Hot-Mix Asphalt Overlay Removal	93
15	<input type="checkbox"/> Polymer Concrete	95
16	<input type="checkbox"/> Reserved	97
17	<input type="checkbox"/> Bicycle Racks	98
18	<input type="checkbox"/> Temporary Portable Bridge Traffic Signals	100
19	<input type="checkbox"/> Nighttime Inspection of Roadway Lighting	102
20	<input type="checkbox"/> English Substitution of Metric Bolts	103
21	<input type="checkbox"/> Calcium Chloride Accelerator for Portland Cement Concrete	104
22	<input type="checkbox"/> Quality Control of Concrete Mixtures at the Plant	105
23	<input checked="" type="checkbox"/> Quality Control/Quality Assurance of Concrete Mixtures	113
24	<input type="checkbox"/> Reserved	129
25	<input type="checkbox"/> Reserved	130
26	<input type="checkbox"/> Temporary Raised Pavement Markers	131
27	<input type="checkbox"/> Restoring Bridge Approach Pavements Using High-Density Foam	132
28	<input type="checkbox"/> Portland Cement Concrete Inlay or Overlay	135
29	<input type="checkbox"/> Portland Cement Concrete Partial Depth Hot-Mix Asphalt Patching	139
30	<input type="checkbox"/> Longitudinal Joint and Crack Patching	142
31	<input type="checkbox"/> Concrete Mix Design - Department Provided	144
32	<input type="checkbox"/> Station Numbers in Pavements or Overlays	145

Local Public Agency	County	Section Number
Village of Buffalo Grove	Cook	

The Following Local Roads And Streets Recurring Special Provisions Indicated By An "X" Are Applicable To This Contract And Are Included By Reference:

Local Roads And Streets Recurring Special Provisions

<u>Check Sheet #</u>		<u>Page No.</u>
LRS 1	<b>Reserved</b>	147
LRS 2	<input type="checkbox"/> Furnished Excavation	148
LRS 3	<input checked="" type="checkbox"/> Work Zone Traffic Control Surveillance	149
LRS 4	<input checked="" type="checkbox"/> Flaggers in Work Zones	150
LRS 5	<input checked="" type="checkbox"/> Contract Claims	151
LRS 6	<input checked="" type="checkbox"/> Bidding Requirements and Conditions for Contract Proposals	152
LRS 7	<input type="checkbox"/> Bidding Requirements and Conditions for Material Proposals	158
LRS 8	<b>Reserved</b>	164
LRS 9	<input type="checkbox"/> Bituminous Surface Treatments	165
LRS 10	<b>Reserved</b>	169
LRS 11	<input checked="" type="checkbox"/> Employment Practices	170
LRS 12	<input checked="" type="checkbox"/> Wages of Employees on Public Works	172
LRS 13	<input checked="" type="checkbox"/> Selection of Labor	174
LRS 14	<input type="checkbox"/> Paving Brick and Concrete Paver Pavements and Sidewalks	175
LRS 15	<input checked="" type="checkbox"/> Partial Payments	178
LRS 16	<input type="checkbox"/> Protests on Local Lettings	179
LRS 17	<input type="checkbox"/> Substance Abuse Prevention Program	180
LRS 18	<input type="checkbox"/> Multigrade Cold Mix Asphalt	181
LRS 19	<input type="checkbox"/> Reflective Crack Control Treatment	182



Local Public Agency	County	Section Number
Village of Buffalo Grove	Cook/Lake	

The following Special Provision supplement the "Standard Specifications for Road and Bridge Construction", adopted

January 1, 2022, the latest edition of the "Manual on Uniform Traffic Control Devices for Streets and Highways", and the "Manual of Test Procedures of Materials" in effect on the date of invitation of bids, and the Supplemental Specification and Recurring Special Provisions indicated on the Check Sheet included here in which apply to and govern the construction of the above named section, and in case of conflict with any parts, or parts of said Specifications, the said Special Provisions shall take precedence and shall govern.

2023 New Sidewalk Improvements Project

**TABLE OF CONTENTS  
FOR CONTRACT GENERAL CONDITIONS AND SPECIAL PROVISIONS**

**General Conditions**

1. General Conditions
2. Scope of Work
3. Definition of Village of Buffalo Grove
4. Clean Construction and Demolition Debris (CCDD) Material Disposal
5. JULIE Notification
6. Notice to Bidders
7. Village Contractor Registration
8. Completion Date
9. Contract Sequencing
10. Construction Work Periods
11. Use of the Work Site
12. Pre-Construction Meeting
13. Authority of the Engineer
14. Status of Utilities
15. Maintenance of Roadways and Erosion Control
16. Construction Staging and Maintenance of Base Course
17. Saw Cutting
18. Use of Fire Hydrants
19. Dust Control
20. Refuse Pick Up Schedule
21. Earth Excavation
22. Traffic Control Plan
23. Maintenance of Roadways
24. Indemnification
25. Insurance Requirements
26. Accidents
27. No Assignment
28. Default
29. Delays
30. Compliance With Laws
31. No Waiver of Rights
32. Termination of Contract
33. Controlling Law and Venue
34. Miscellaneous
35. Application For Payment
36. Certified Payroll Reports

37. Monetary Penalties
38. Public Notification
39. Maintenance Bond

**Special Provisions**

1. Portland Cement Concrete Sidewalk
2. Remove and Relocate Sign Panel and Pole Assembly
3. General Landscape Restoration
4. Aggregate Base Course, Type B Varies
5. Combination Concrete Curb and Gutter
6. Barrier Curb, Variable Height
7. Sanitary Manholes to be Adjusted
8. Sanitary Manholes to be Reconstructed
9. Drainage and Utility Structures to be Adjusted
10. Exploration Excavation
11. Stump Removal
12. PVC Sleeve

## General Conditions

### 1. General Conditions

It is the policy of the Municipality and other governing agencies to set standards for the performance of road and bridge construction. This contract shall expressly adhere to the 'Standard Specifications for Road and Bridge Construction', latest edition, and the 'Standard Specifications for Water and Sewer Main Construction in Illinois', latest edition, unless otherwise specified herein.

### 2. Scope of Work

The provisions of Article 104.02 of the Standard Specifications are hereby amended as follows: **"The Village of Buffalo Grove (Village) expressly reserves the right to remove from or add to the project any portions thereof included in the 2023 New Sidewalk Improvements Project. Such additions or reductions, if any, shall be made in writing by the Village prior to execution of the Contract Documents. Any addition or reduction in the scope of work required by the Village prior to the execution of the Contract Documents shall not result in an adjustment to the contract or to the price originally bid."**

### 3. Definition of Village of Buffalo Grove

All references in the contract relating to the Department, Awarding Authority, Village of Buffalo Grove, Village etc. shall mean the Village of Buffalo Grove.

### 4. Clean Construction and Demolition Debris (CCDD) Material Disposal

Work under this item shall be performed in compliance with the Illinois Environmental Protection Agency (IEPA) guidelines in effect at the time of construction.

The Contractor will be required to make all arrangements for coordination and submission of the necessary documents with their chosen CCDD or other suitable disposal facility. Written confirmation of preliminary approval must be provided from the disposal facility and confirmed by the Owner as acceptable.

All surplus, clean material generated from the Contractor's activities must be disposed of at an IEPA permitted CCDD or otherwise acceptable facility. The Contractor is responsible for providing documentation to the Owner for each load hauled off-site showing the quantity of material and the location the material was disposed of.

Disposal of clean material not in compliance with these requirements will constitute breach of contract. If the Contractor fails to provide adequate documentation supporting the legal disposal of clean material according to this special provision, the Contractor shall be fined \$1,000 per load of material and will assume all liability associated with material disposed of not in compliance with this special provision.

No extra compensation will be allowed to the Contractor for any expenses incurred complying with these requirements including but not limited to: delays, inconvenience, or interruptions in the work resulting from compliance with these requirements. All costs associated with material disposal shall be included into the appropriate unit bid prices for the work.

### 5. JULIE Notification

The Contractor shall call the Joint Utility Locating Information for Excavators (JULIE) (1-800-892-0123 or 811), a minimum of forty-eight (48) hours in advance of work being done in the area in accordance with Article 107.39 of the Standard Specifications.

For utilities which are not members, excluding homeowners, the Contractor shall contact the owners directly. The Contractor will be required to cooperate with all utility companies and municipal agencies involved in connection with the removal, temporary relocation, reconstruction or abandonment by these agencies of any and all services.

No additional compensation will be allowed the Contractor for any expense incurred by complying with these requirements, or because of delays, inconvenience or interruptions in his work resulting from the failure of the municipal agencies or utility company to remove, relocate, reconstruct or abandon their services.



## 6. Notice to Bidders

All bid proposals must be submitted electronically through the Village's Vendor Registry online procurement system. **Hard copy bids will not be accepted.** As read results of the bids will be posted to the Village's webpage, [www.vbg.org/bids](http://www.vbg.org/bids) as soon as possible following the bid opening. In order to submit a bid proposal, bidders

- a. Go to [www.vbg.org/bids](http://www.vbg.org/bids)
- b. Select on the project description, '2023 New Sidewalk Improvements Project' and click the large red button at the top  

- c. Log in to your account and enter your total bid.
- d. Include an attachment (up to 200 MB), the following bid documents only:
  - i. Local Public Agency Formal Contract Proposal (6 Pages)
  - ii. Schedule of Prices (2 Pages)
  - iii. Local Agency Proposal Bid Bond
- e. The following documents will be requested by the two (2) as read low bidders immediately following the bid opening:
  - i. Apprenticeship or Training Program Certification
  - ii. Affidavit of Illinois Business Office
  - iii. Affidavit of Availability
  - iv. Village of Buffalo Grove Public Contract Statements

All bids will be opened and read publicly via the Microsoft Teams video conferencing platform.

**Please join on your computer, mobile app or room device**

<https://bit.ly/3lcvGNR>

**Meeting ID:** 228 765 690 485

**Passcode:** yvYMsS

## 7. Village Contractor Registration

**All bidders are required to fully register with the Village of Buffalo Grove, including IRS Form W-9, at:**

<https://vrapp.vendorregistry.com/Vendor/Register/Index/buffalo-grove-village-of-il-vendor-registration>

OR

[www.vbg.org/bids](http://www.vbg.org/bids)

Select the link 'Register My Business'

Please contact Vendor Registry at (844) 802-9202 for assistance in the registration process.

The Village of Buffalo Grove reserves the right to reject any or all proposals if the bidder does not comply with the requirements as stated herein.

## 8. Completion Date

The Contractor shall commence the work to be performed under this contract, on or near Monday, April 24, 2023. The work shall be prosecuted in such a manner and with such a supply of materials, equipment and labor as considered necessary to ensure its completion according to the time specified in the contract. The Contractor shall have ten (10) working days from the actual date the Contractor begins work to complete this project. All work shall be completed, regardless of what is awarded or the actual start date by **Friday, May 26, 2023**, including punch list items, as defined in Article 108.04 of the Standard Specifications.

In case of failure to complete the work on time, the provisions of Article 108.09 of the Standard Specifications shall apply following the calendar day schedule of deductions.

The estimated Village Board award date for this project is Monday, March 20, 2023.

## **9. Contract Sequencing**

The Contractor shall notify the Engineer at least 72 hours in advance of beginning work and 48 hours prior to construction commencement on each subsequent street. Construction operations shall be conducted in a manner such that streets will remain open to all traffic. At no time shall residents or business owners be kept out of their driveway over a weekend or holiday as defined in article 107.09 of the Standard Specifications.

Work shall be scheduled so that it is continuous on the various roadways. The Contractor and approved Subcontractor(s) shall, at all times, employ and provide sufficient labor, tools, equipment, and other incidental items for prosecuting the work to full completion in the manner and time required by the contract.

## **10. Construction Work Periods**

Construction operations shall be completed in accordance with Article 107.09 of the Standard Specifications. All work shall be confined to the period beginning at 7:00 AM and ending at 6:00 PM on weekdays. No work shall be done on weekends or legal holiday periods as defined in Article 107.09 of the Standard Specifications.

Any work outside the allowed time periods specified including but not limited to, material deliveries, mobilization of equipment, warming up machinery, and mobilization of equipment, a penalty of \$1,000 per occurrence may be imposed.

## **11. Use of the Work Site**

Contractor shall use the Work Site solely to complete the Work and such related activities as may be authorized or directed by the Village. Except as provided herein, Contractor shall not (nor shall Contractor cause or permit any employee or person under Contractor's control) to display or broadcast commercial, political, or religious messages or advertisements of any nature at the Work Site or in connection with the Work. The foregoing shall not be construed to prohibit the following at the Work Site or in connection with the Work: (a) the use of equipment, materials, or other items (e.g. personnel uniforms and clothing) that identify the Contractor (such as by displaying the Contractor's name, logo, slogan, contact information, or similar messages) or that identify the maker or supplier of such equipment, material, or item; or (b) the use or display of signs, flags, cones, traffic control devices, markers, or other similar devices that reasonably relate to the Work, Work Site safety, public safety, or regulatory compliance; or (c) personal speech, religious practice, or expression by any individual performing Work or at the Work Site; or (d) upon written approval or direction of the Village, the display of information regarding the sponsor of the Work or funding sources for the Work.

In addition, Contractor shall not (nor shall Contractor require or permit its personnel, subcontractors, or subcontractors' personnel to) conduct any prohibited political activity at the Work Site or while performing the Work. Contractor and its personnel or subcontractors (including any subcontractor's personnel) shall not intentionally or knowingly use the Work Site or any other property or resources of the Village in connection with any prohibited political activity. For purposes of this section, the term "prohibited political activity" shall have the meaning set forth in Section 5 of the State Officials and Employees Ethics Act, 5 ILCS 430/1-5.

## **12. Pre-Construction Meeting**

Prior to commencing any construction operations, there shall be a pre-construction meeting. The Owner or Engineer will set the time and date of the meeting following Contract award.

The following shall be submitted by the Contractor for review at the pre-construction meeting:

A Progress Schedule in accordance with Article 108.02.

The 24-hour emergency phone number and contact information of the assigned Contractor's superintendent, or otherwise.

The name and 24-hour emergency phone number of the person in the direct employ of the Contractor who is responsible for administrating the Traffic Control and Protection on the Contract

A list of subcontractors with contact information, including but not limited to name, phone number, and email address, and include quantity and type of work to be sublet for each respective subcontractor in accordance with Article 108.01 of the Standard Specifications.

A list of proposed sources of material.

Concrete mix designs and respective quality control plans.

Any applicable shop drawing submittals.

### **13. Authority of the Engineer**

Revise Article 105.01 Authority of Engineer to read:

"All work shall be done in accordance with the requirements of the Contract, the Engineer shall have the right, but not the obligation, to observe all work. The Engineer shall decide all questions that arise as to the interpretation of the Plans and Specifications and as to disputes and mutual rights between Contractors under the Specifications. The Engineer shall advise the Village of Buffalo Grove as to the quality and acceptability of materials furnished and work performed, rate of progress of the work, and acceptable fulfillment of the Contract. The Engineer will determine the amount of materials furnished and work performed. The Engineer's advice and determinations shall be conditions precedent to the right of the Contractor to receive money due the Contractor under the Contract."

"The Engineer will notify the Contractor in writing if the work is to be suspended by the Village of Buffalo Grove wholly or in part due to the failure of the Contractor to carry out provisions of the contract; for failure to carry out orders; for such periods due to unsuitable weather; for conditions considered unsuitable for the prosecution of the work or for any other condition or reason deemed to be in the public interest."

"In case of failure on the part of the Contractor to execute work as directed by the Engineer, the Village of Buffalo Grove may, at the expiration of a period of 48 hours after giving notice in writing to the Contractor, proceed to execute such work as may be deemed necessary, and the cost thereof shall be deducted from compensation due or which may become due to the Contractor under the contract."

The Engineer shall not assume any of the responsibilities of the Contractor's superintendent or of subcontractors; shall not expedite the work for the Contractor; and shall not advise on, or issue directions concerning aspects of construction means, methods, techniques, sequences or procedures, or safety precautions in connection with the work.

### **14. Status of Utilities (D-1)**

Effective: June 1, 2016

Revised: January 1, 2020

Utility companies and/or municipal owners located within the construction limits of this project have provided the following information regarding their facilities and the proposed improvements. The tables below contain a description of specific conflicts to be resolved and/or facilities which will require some action on the part of the Department's contractor to proceed with work. Each table entry includes an identification of the action necessary and, if applicable, the estimated duration required for the resolution.

#### **UTILITIES TO BE ADJUSTED**

Conflicts noted below have been identified by following the suggested staging plan included in the contract. The company has been notified of all conflicts and will be required to obtain the necessary permits to complete their work; in some instances, resolution will be a function of the construction staging. The responsible agency must relocate, or complete new installations as noted below; this work has been deemed necessary to be complete for the Department's contractor to then work in the stage under which the item has been listed.

- Vinakom Communications box at southeast corner of Busch Pkwy & Barclay Blvd to be raised to elevation: 645.65 FT

#### **UTILITIES TO BE WATCHED AND PROTECTED**

The areas of concern noted below have been identified by following the suggested staging plan included for the contract. The information provided is not a comprehensive list of all remaining utilities, but those which during coordination were identified as ones which might require the Department's contractor to take into consideration when making the determination of the means and methods that would be required to construct the proposed improvement. In some instances, the contractor will be responsible to notify the owner in advance of the work to take place so necessary staffing on the owner's part can be secured.

No facilities requiring extra consideration.

The following contact information is what was used during the preparation of the plans as provided by the owner of the facility.

Agency/Company Responsible to Resolve Conflict	Name of Contact	Phone	E-mail address
AT&T Distribution			G11629@ATT.com
AT&T/TCG	Bobby Akhter	(630) 719-1482	-
Comcast	Martha Gieras	(224) 229-5862	Martha_Gieras@comcast.com
ComEd	Lisa Argast	(708) 277-8511	plansubmittalsandmaprequestsW@exeloncorp.com
Lumen	Leslie Dingman	-	Leslie.Dingman@Lumen.com
North Shore Gas	James Massuci	(312) 240-4419	James.massuci@peoplesgasdelivery.com
Vinakom	Mauli Patel	(847) 882-8200	Mauli.patel@vinakom.com

The above represents the best information available to the Department and is included for the convenience of the bidder. The days required for conflict resolution should be considered in the bid as this information has also been factored into the timeline identified for the project when setting the completion date. The applicable portions of the Standard Specifications for Road and Bridge Construction shall apply.

Estimated duration of time provided above for the first conflicts identified will begin on the date of the executed contract regardless of the status of the utility relocations. The responsible agencies will be working toward resolving subsequent conflicts in conjunction with contractor activities in the number of days noted.

The estimated relocation duration must be part of the progress schedule submitted by the contractor. A utility kickoff meeting will be scheduled between the Department, the Department's contractor and the utility companies when necessary. The Department's contractor is responsible for contacting J.U.L.I.E. prior to all excavation work.

**15. Maintenance of Roadways and Erosion Control**

Beginning on the date that the Contractor begins work on this project, he shall assume responsibility for normal maintenance of all existing roadways and trenches within the limits of the improvement. This normal maintenance shall include all repair work deemed necessary by the Engineer, but shall not include snow removal operations. Traffic control and protection for maintenance of roadways will be provided by the Contractor as required by the contract documents.

The Contractor shall be required to control dust or air-borne dirt resulting from construction operations by utilizing a mechanical street sweeper on all pavement within or adjacent to the project work zone throughout the duration of the project. The resulting debris shall be disposed of off-site in accordance with Article 202.03 of the Standard Specifications. Individual fire hydrant use shall not be permitted to control dust at specific locations. The Contractor shall provide dust control operations daily, throughout the project limits and adjacent streets. At the direction of the Engineer, a professional street sweeper may be requested on a weekly basis or as deemed necessary by the Village or Engineer.

The cost of this work shall be included in the unit prices bid and no additional compensation shall be allowed to control dust as specified herein.

No excavations shall be left open during non-work hours unless approved by the Engineer and adequately protected from the public.

The Contractor will be required over the course of construction to clean inlet filter baskets weekly or prior to a forecasted rain event. Many of the homes in the Village have lower garages and are susceptible to damage when streets flood. The Contractor shall be held liable for any damage to private structures if it is determined that the damage was due to the Contractor's neglect as specified herein. In the event water is not properly running through inlet filter baskets caused by debris, the Village crews may respond to resident calls about street flooding. Any Village expense occurred in labor or materials responding to these calls will be back charged to the Contractor and deducted from a future pay request.

The Contractor will be required to perform erosion control best management practices as listed on the plans, specifications, and details during construction. Discharge of sediment-laden water or construction debris into the storm sewer system or waterways will not be permitted and subjected to a monetary penalty as noted in the monetary penalties general condition. In addition, the Contractor will be responsible for cleaning all storm sewer systems and waterways to their preconstruction condition to the satisfaction of the Engineer. In the event of an illicit

discharge, regardless of blame, the Contractor shall concentrate their work efforts on remedying the situation to correct the deficiency.

The work zone shall be maintained in accordance with Section 701 of the Standard Specifications. Negligence by the Contractor to follow these minimum guidelines that result in or cause damage to Village equipment during snow fall removal or any other similar Village operation will be the direct responsibility of the Contractor to repair. The repair will be completed by the Village and the cost of the repair will be deducted from the next pay request due to the Contractor.

All operations by the Contractor such as flushing, dewatering, leaking water trucks or equipment, repairs to broken water services or water main, or similar that cause freezing of water on the pavement or sidewalk shall be maintained by salting, sanding or removal of the condition by the Contractor to the satisfaction of the Engineer.

If items of work have not been provided for in the contract, or otherwise specified for payment, such items, including the accompanying traffic control and protection required by the Engineer, will be paid for in accordance with Article 109.04 of the Standard Specifications.

#### **16. Construction Staging and Maintenance of Base Course**

All pavement removal, curb installation, and hot-mix asphalt binder installation shall be completed in accordance with Section(s) 202, 406, 423, 440, and 606 of the Standard Specifications and as specified herein.

Pavement removal and hot-mix asphalt binder course placement shall be staged in a manner to minimize the exposure of vehicular traffic over the existing base course following pavement removal.

No pavement removal operations shall commence if rain is in the forecast within the following five working days. If the Contractor does not follow this requirement, any disking, drying or undercut operations required by the Engineer to provide a sufficient subbase prior to paving shall be completed by the Contractor at no additional cost to the Village.

Roadways excavated to subgrade and/or subbase material shall have the hot-mix asphalt binder course installed within seven (7) calendar days from the first day of pavement removal on that respective street segment.

**There shall be no placement of hot-mix asphalt permitted on scheduled days of refuse pickup.** The Contractor shall be responsible for determining the current refuse schedule and incorporating it into their progress schedule accordingly.

No resident shall be without driveway access and no sidewalk shall be barricaded or closed for more than seven (7) calendar days unless specifically listed otherwise in the plans or herein.

Prior to driveway access impediment due to proposed curb and gutter or driveway pavement operations, the Contractor shall be required to deliver resident notification letters approved by the Engineer to each respective residence or business owner notifying them of the day and time they will not be able to get in and out of their driveway. After the new concrete curb has set, the Contractor shall install all required forms for installation of the driveway pavement for inspection by the Engineer. The Contractor is required to install curb and driveway pavement within two (2) calendar days of each other. Example: If the curb is poured on Monday the driveways will be required to be poured on the same day after the curb is set or on Tuesday. If the curb in front of the resident is not being replaced the Contractor shall frame and pour the driveway on the same day. The driveways shall be properly barricaded until the concrete is sufficiently cured. If, at the discretion of the Engineer, the driveway requires that the old aggregate base course be removed and replaced, it shall be completed prior to pouring the new concrete combination curb & gutter or not until after it has been allowed to cure for a minimum of three (3) calendar days, or after the concrete has reached 2,500 psi as verified by cylinder breaks. Any additional cylinders cast and testing costs associated with this verification shall be included in the cost of the contract. Proposed portland cement concrete sidewalk shall follow the same timeframe as noted above.

**The work at 1275 Busch Parkway shall be staged so that one driveway entrance/exit is open at all times. The two driveways cannot be closed at the same time.**

If the Contractor does not install proposed concrete curb, driveway pavement, and/or sidewalk in the time frame specified herein, a monetary penalty of \$250 per calendar day will be imposed for each day, and each occurrence the work is not completed.

The Contractor will be required to furnish and install a temporary ramp immediately following pavement removal operations. Each ramp shall be installed the full driveway width of material determined by the Contractor. Each temporary ramp shall be removed prior to paving operations, the respreading of stone on the base or paving over hot-mix asphalt ramps will not be allowed. If the Contractor fails to install or maintain a temporary ramp in a timely manner, a monetary penalty of \$250 per calendar day will be imposed.

The Contractor shall make themselves aware of the surroundings and of private property. The Village will not tolerate entering private property or driving equipment/vehicles on a driveway within the public right of way to remain for any reason during construction unless prior approval has been granted by the property owner. The Contractor will incur a monetary penalty of \$500 per occurrence as determined by the Engineer for violation of this requirement.

#### **17. Saw Cutting**

The Contractor shall be required to perform a perpendicularly straight joint by full-depth machine sawing of all proposed items to be removed prior to removal operations to prevent damage or spalling to existing hardscape to remain. Simple or partial depth scoring shall not be permitted. Saw cut locations may or may not be shown on the plans, however, shall be required in the field. All sawcut slurry, regardless of the amount, shall be promptly removed to prevent tracking. Any slurry tracked or left on surfaces to remain shall be thoroughly cleaned or replaced, at the direction of the Village or Engineer, by the Contractor at no additional cost to the Village.

The Contractor shall replace, at no additional cost to the Village, any hardscape, outside of the limit of improvements, damaged by the Contractor's operations due to neglect, misconduct, or poor workmanship.

#### **18. Use of Fire Hydrants**

The indiscriminate use of fire hydrants is strictly prohibited. The Contractor can obtain non-potable water in bulk at no charge at the Buffalo Grove Public Works Department, 51 Raupp Blvd. The Contractor shall provide a water truck or containment and driver to obtain and transport the water. All water obtained from the Village shall be used for this project only. If deemed necessary, the Village reserves the right to restrict or refuse the use of Village water. The Contractor will be responsible for executing the required paperwork and follow all requirements of the Village. If it is determined that the Contractor or its subcontractors operate or use a Village fire hydrant, a monetary penalty of \$1,000 per occurrence that will be imposed.

#### **19. Dust Control**

The Contractor shall be required to control dust or air-borne dirt resulting from construction operations by utilizing a mechanical street sweeper on all pavement within or adjacent to the project work zone throughout the duration of the project. The resulting debris shall be disposed of off-site in accordance with Article 202.03 of the Standard Specifications. Individual fire hydrant use shall not be permitted to control dust at specific locations. The Contractor shall provide dust control operations daily or as directed by the Engineer.

The cost of this work shall be included in the unit prices bid and no additional compensation shall be allowed to control dust as specified herein.

#### **20. Refuse Pick Up Schedule**

There will be no placement of hot-mix asphalt allowed on scheduled days of refuse pick up. The Contractor shall be responsible for determining the current refuse pickup schedule and incorporating it into their proposed project schedule.

#### **21. Earth Excavation**

All earth excavation required to complete this project to the proposed lines, grades, and cross sections shall be in accordance with Section 202 of the Standard Specifications. Earth excavation will not be paid for separately but shall be included in the cost of the item requiring the excavation. All surplus excavated material shall be disposed of off-site in accordance with Article 202.03 of the Standard Specifications.

#### **22. Traffic Control Plan**

Effective: September 30, 1985

Revised: January 1, 2007

Traffic Control shall be according to the applicable sections of the Standard Specifications, the Supplemental Specifications, the "Illinois Manual on Uniform Traffic Control Devices for Streets and Highways", any special details and Highway Standards contained in the plans, and the Special Provisions contained herein.

Special attention is called to Article 107.09 of the Standard Specifications and the following Highway Standards, Details, Quality Standard for Work Zone Traffic Control Devices, Recurring Special Provisions and Special Provisions contained herein, relating to traffic control.

Delays to the Contractor caused by complying with these requirements will be considered included in the cost of the contract, and no additional compensation will be allowed.

**Standards**

701006, 701301, 701501, 701801 and 701901

**Details**

TC-10 Traffic Control and Protection for Side Roads, Intersections and Driveways

**Special Provisions**

Dist 1 - Maintenance of Roadways

LRS 3 – Work Zone Traffic Control Surveillance

LRS 4 – Flaggers in Work Zones

BDE – Vehicle and Equipment Warning Lights

BDE – Work Zone Traffic Control Devices

**23. Maintenance of Roadways**

Effective: September 30, 1985

Revised: November 1, 1996

Beginning on the date that the Contractor begins work on this project, he shall assume responsibility for normal maintenance of all existing roadways within the limits of the improvement. This normal maintenance shall include all repair work deemed necessary by the Engineer, but shall not include snow removal operations. Traffic control and protection for maintenance of roadways will be provided by the Contractor as required by the Engineer.

If items of work have not been provided for in the contract, or otherwise specified for payment, such items, including the accompanying traffic control and protection required by the Engineer, will be paid for in accordance with Article 109.04 of the Standard Specifications.

**24. Indemnification**

To the fullest extent permitted by law, the Contractor agrees to defend, pay on behalf of, indemnify, and hold harmless the Village, its elected and appointed officials, agents, employees and volunteers and others working on behalf of the Village against any and all claims, demands, suits or loss, including all costs connected therewith, and for any damages which may be asserted, claimed or recovered against or from the Village, its elected and appointed officials, agents, employees and volunteers and others working on behalf of the Village, by reason of personal injury, including bodily injury and death, and/or property damage, whether damage to property of the Village or of a third party, including loss of use thereof, which arises out of or is in any way connected or associated with the Contract and the Work.

For this project, the Village also hired a Consultant, Gewalt Hamilton Associates. The Contractor shall indemnify the Consultant in the same manner as the Village, as stated above.

**25. Insurance Requirements**

12.04.080 - Insurance.

A. Required Coverages and Limits. Unless otherwise provided by franchise, license, or similar agreement, each Contractor occupying right-of-way or constructing any facility in the right-of-way shall secure and maintain the following liability insurance policies insuring the Contractor as named insured and naming the Village, and its elected and appointed officers, officials, agents, and employees and Gewalt Hamilton Associates, Inc. and employees as additional insureds on the policies listed in subsection (A)(1) and (A)(2) of this section:

1. Commercial general liability insurance, including premises-operations, explosion, collapse, and underground hazard (commonly referred to as "X," "C," and "U" coverages) and products-completed operations coverage with limits not less than:
  - a. Five million dollars for bodily injury or death to each person,

- b. Five million dollars for property damage resulting from any one accident, and
- c. Five million dollars for all other types of liability;
2. Automobile liability for owned, non-owned and hired vehicles with a combined single limit of one million dollars for personal injury and property damage for each accident;
3. Worker's compensation with statutory limits; and
4. Employer's liability insurance with limits of not less than one million dollars per employee and per accident.

If the Contractor is not providing such insurance to protect the contractors and subcontractors performing the work, then such contractors and subcontractors shall comply with this section.

- B. Excess or Umbrella Policies. The coverages required by this section may be in any combination of primary, excess, and umbrella policies. Any excess or umbrella policy must provide excess coverage over underlying insurance on a following-form basis such that when any loss covered by the primary policy exceeds the limits under the primary policy, the excess or umbrella policy becomes effective to cover such loss.
- C. **Copies Required. The Contractor shall provide copies of any of the policies including all endorsements or certificates required by this section to the Village within ten calendar days following receipt of a written request therefor from the Village.**
- D. Maintenance and Renewal of Required Coverages. The insurance policies required by this section shall contain the following endorsement:

"It is hereby understood and agreed that this policy may not be canceled nor the intention not to renew be stated until thirty (30) calendar days after receipt by the Village, by registered mail or certified mail, return receipt requested, of a written notice addressed to the Village Manager of such intent to cancel or not to renew."

Within ten (10) calendar days after receipt by the Village of said notice, and in no event later than ten (10) calendar days prior to said cancellation, the Contractor shall obtain and furnish to the Village evidence of replacement insurance policies meeting the requirements of this section.

- E. Self-Insurance. A Contractor may self-insure all or a portion of the insurance coverage and limit requirements required by subsection A of this section. A Contractor that self-insures is not required, to the extent of such self-insurance, to comply with the requirement for the naming of additional insureds under subsection A of this section, or the requirements of subsections B through D of this section. A Contractor that elects to self-insure shall provide to the Village evidence sufficient to demonstrate its financial ability to self-insure the insurance coverage and limit requirements required under subsection A of this section, such as evidence that the Contractor is a "private self-insurer" under the Workers Compensation Act.
- F. Effect of Insurance and Self-Insurance on Contractor's Liability. The legal liability of the Contractor to the Village and any person for any of the matters that are the subject of the insurance policies or self-insurance required by this section shall not be limited by such insurance policies or self-insurance or by the recovery of any amounts thereunder.
- G. Insurance Companies. All insurance provided pursuant to this section shall be effected under valid and enforceable policies, issued by insurers legally able to conduct business with the licensee in the State of Illinois. All insurance carriers and surplus line carriers shall be rated "A-" or better and of a class size "X" or higher by A.M. Best Company.
- H. Verification of Coverage. **Contractor shall furnish the Village with certificates of insurance naming the Village, its officials, agents, employees, and volunteers as additional insured's and with original endorsements, affecting coverage required herein.** The certificates and endorsements for each insurance policy are to be signed by a person authorized by that insurer to bind coverage on its behalf. The certificates and endorsements are to be received and approved by the Village before any work commences. The Village reserves the right to request full certified copies of the insurance policies and endorsements.
- I. Subcontractors. Contractor shall include all subcontractors as insured's under its policies or shall furnish separate certificates and endorsements for each subcontractor. All coverage's for subcontractors shall be subject to all of the requirements stated herein.
- J. Assumption of Liability. The contractor assumes liability for all injury to or death of any person or persons including employees of the contractor, any subcontractor, any supplier or any other person and assumes liability for all damage to property sustained by any person or persons occasioned by or in any way arising out of any work performed pursuant to the Contract.



- K. **Workers' Compensation and Employers' Liability Coverage.** The insurer shall agree to waive all rights of subrogation against the Village of Buffalo Grove, its officials, employees, agents and volunteers for losses arising from work performed by Contractor for the municipality.
- L. **Failure to Comply.** In the event the Contractor fails to obtain or maintain any insurance coverage's required under this contract, The Village may purchase such insurance coverage's and charge the expense thereof to the Contractor.

Nothing contained herein is intended to constitute, nor shall it constitute a waiver of the rights, defenses and/or other immunities provided or available to the Village under law including, but not limited to, the Local Governmental and Governmental Employees Tort Immunity Act.

#### **26. Accidents**

In the event of any accident of any kind that involves the general public or property of the Village or a third party, the Contractor shall immediately notify the Village by phone as well as provide Notice of the same. The Notice shall include a full accounting of all details of the accident. The Contractor shall furnish the Village with copies of all reports of such accidents at the same time that the reports are forwarded to any other interested parties.

#### **27. No Assignment**

If the Contractor sublets or assigns any part of the Work then the Contractor shall not under any circumstances be relieved of its liabilities hereunder. All transactions of the Village shall be with the Contractor. Subcontractors shall be recognized only in the capacity of employees or workmen and shall be subject to the same requirements as to character and competence. The Contractor shall not assign, transfer, convey, sell or otherwise dispose of the whole or any part of this Contract to any person, firm or corporation without written consent of the Village or authorized representative.

#### **28. Default**

The following shall constitute a default an "**Event of Default**" by the Contractor under this Contract:

- A. If the Contractor shall fail to strictly observe or perform one or more of the terms, conditions, covenants and agreements of this Contract;
- B. If there shall be placed on any property owned by the Village any mechanics', materialmens' or suppliers' lien;
- C. If there shall be instituted any proceeding against the Contractor seeking liquidation, dissolution or similar relief and the same shall not be dismissed within forty-five (45) calendar days;
- D. If there shall be appointed any trustee, receiver or liquidator of the Contractor and such appointment shall not have been vacated within forty-five (45) calendar days; and
- E. If the Contractor fails to maintain or obtain any and all permits, licenses and the like, if any, required by the Village, State or Federal governments for the Work.

Upon any Event of Default the Village shall have the option of (i) terminating the Contract; (ii) pursuing any remedy available to it at law or in equity; or (iii) pursuing both simultaneously. In addition, upon an Event of Default, the Village may withhold payments due to the Contractor until it has hired a replacement of the Contractor and deducted all costs of hiring a replacement.

#### **29. Delays**

The Contractor shall not be liable in damages for delays in performance when such delay is the result of fire, flood, strike, acts of God, or by any other circumstances which are beyond the control of the Contractor; provided, however, under such circumstances the Village may, at its option, cancel the Contract.

### 30. Compliance With Laws

The Contractor shall comply with all applicable laws, regulations and rules promulgated by any federal, state, local, or other governmental authority or regulatory body pertaining to all aspects of the Work, now in effect, or which may become in effect during the performance of the Work. The scope of the laws, regulations, and rules referred to in this paragraph includes, but is in no way limited to, the Illinois Human Rights Act, Illinois Equal Pay Act of 2003, Occupational Safety & Health Act along with the standards and regulations promulgated pursuant thereto (including but not limited to those safety requirements involving work on elevated platforms), all forms of traffic regulations, public utility, Interstate and Intrastate Commerce Commission regulations, Workers' Compensation Laws, Public Construction Bond Act, Public Works Preference Act, Employment of Illinois Workers on Public Works Act, USA Security Act, federal Social Security Act (and any of its titles), and any other law, rule or regulation of the Illinois Department of Labor, Department of Transportation, Illinois Environmental Protection Act, Illinois Department of Natural Resources, Illinois Department of Human Rights, Human Rights Commission, EEOC, and the Village of Buffalo Grove. Notwithstanding the following, the Contractor shall particularly note that:

**A. NO DISCRIMINATION** – The Contractor shall comply with the provisions of the Illinois Public Works Employment Discrimination Act and the Illinois Human Rights Act/Equal Opportunity Clause which, pursuant to Illinois law, are deemed to be part of this Contract.

**B. FREEDOM OF INFORMATION** - The Contractor agrees to furnish all documentation related to the Contract, the Work and any documentation related to the Village required under an Illinois Freedom of Information Act (ILCS 140/1 et. seq.) ("FOIA") request within five (5) calendar days after the Village issues Notice of such request to the Contractor. The Contractor agrees to defend, indemnify and hold harmless the Village, and agrees to pay all reasonable costs connected therewith (including, but not limited to attorney's and witness fees, filing fees and any other expenses) for the Village to defend any and all causes, actions, causes of action, disputes, prosecutions, or conflicts arising from Contractor's actual or alleged violation of FOIA or the Contractor's failure to furnish all documentation related to a FOIA request within five (5) calendar days after Notice from the Village for the same. Furthermore, should the Contractor request that the Village utilize a lawful exemption under FOIA in relation to any FOIA request thereby denying that request, Contractor agrees to pay all costs connected therewith (such as attorneys' and witness fees, filing fees and any other expenses) to defend the denial of the request. This defense shall include, but not be limited to, any challenged or appealed denials of FOIA requests to either the Illinois Attorney General or a court of competent jurisdiction.

**C. ILLINOIS WORKERS ON PUBLIC WORKS ACT** - To the extent applicable, the Contractor shall comply with the Illinois Workers on Public Works Act, 30 ILCS 570/1 et seq., and shall provide to the Village any supporting documentation necessary to show such compliance.

**D. NOT A BLOCKED PERSON** - The Contractor affirms and covenants that neither the Contractor nor any individual employed by the Contractor for this Work or under this Contract is a person forbidden from doing business with a unit of local government under Executive Order No. 13224 (Sept 23, 2001), 66 Fed.Reg. 49,079 (Sept 23, 2001) or is a person registered on the Specially Designated Nationals and Blocked Persons List. The Contractor shall indemnify the Village from all costs associated with failure to comply with this paragraph.

**E. SUBSTANCE ABUSE PREVENTION ON PUBLIC WORKS ACT** - The Contractor knows, understands and acknowledges its obligations under the Substance Abuse Prevention on Public Works Act (820 ILCS 265/1 et seq.), and shall comply and require all subcontractors and lower tiered contractors to comply with the requirements and provisions thereof.

### 31. No Waiver of Rights

A waiver by the Village of any Event of Default or any term of provision of this Contract shall not be a waiver of the same Event of Default, another Event of Default or any other term or provision of this Contract.

### 32. Termination of the Contract

**Voluntary Termination.** Notwithstanding any other provision hereof, the Village may terminate this Contract during the Initial Term with or without cause, at any time upon thirty (30) calendar days prior written notice to the Contractor.

**Termination for Breach.** Either party may terminate this Contract upon written notice to the other party following material breach of a material provision of this Contract by the other party if the breaching party does not cure such breach within fifteen (15) calendar days of receipt of written notice of such breach from the non-breaching party.

### **33. Controlling Law and Venue**

This Contract is entered into in the State of Illinois, for work to be performed in the State of Illinois and shall be governed by and construed in accordance with the laws of the State of Illinois. Any legal matters or dispute shall be resolved in the Circuit Court of Cook County and the Parties hereby submit to the jurisdiction of such Circuit Court. This Contract shall be construed without regard to any presumption or other rule requiring construction against the Party causing the Contract to be drafted.

### **34. Miscellaneous**

- A. AMENDMENT** – This Contract may be amended only in writing executed by both Parties.
- B. NO RECORDING** – This Contract, or a memorandum thereof, may not be recorded in any form by either Party. If either Party records this Contract, or a memorandum thereof, they shall immediately file a release of the same.
- C. SECTION HEADINGS** – The headings in the Contract are intended for convenience only and shall not be taken into consideration in any construction or interpretation of the Contract.
- D. NO THIRD PARTY BENEFICIARIES** – This Contract does not confer any rights or benefits on any third party.
- E. BINDING EFFECT** – This Contract shall be binding and inure to the benefit of the Parties hereto, their respective legal representatives, heirs and successors-in-interest.
- F. ENTIRE AGREEMENT** – This Contract supersedes all prior agreements and understandings and constitutes the entire understanding between the Parties relating to the subject matter hereof.
- G. SEVERABILITY** - If any term, condition or provision of the Contract is adjudicated invalid or unenforceable, the remainder of the Contract shall not be affected and shall remain in full force and effect, to the fullest extent permitted by law.
- H. TORT IMMUNITY DEFENSES** - Nothing contained in this Contract is intended to constitute nor shall constitute a waiver of the rights, defenses, and immunities provided or available to the Village under the Local Governmental and Governmental Employees Tort Immunity Act, 745 ILCS 10 *et seq.*

### **35. Application For Payment**

At least once each month, the Engineer will make a written estimate of the quantity of work performed in accordance with the Contract, and the value thereof at the contract unit prices according to Article 109.02 of the Standard Specifications. For each pay period, the quantity cut off will be the first Saturday of each month. During the second week, the Engineer and Contractor will agree to the quantities completed to-date. The Contractor shall submit an agreed upon invoice electronically to the Engineer by the end of the working day of the third Monday of the month. The Village will begin their payment process and will result in the review of the payment at the next regularly scheduled Village Board meeting. Prior to the release of payment, the Contractor shall submit electronically, all certified payroll reports, applicable waivers, and a notarized and signed clarifying statement for Village Attorney review and subsequent approval. Prior to the release of the check, hardcopies of all applicable waivers and the clarifying statement shall be received by the Village.

All payments under this Contract must be approved by the Village Board at a regularly scheduled meeting. The Village reserves the right to request any receipts, invoices, proof of payments as the Village, in its sole discretion, may deem necessary to justify the payment requested prior to paying the requested payment. A Final Lien Waiver from the Contractor, its subcontractors, and all material suppliers shall be furnished with the final application for payment.

The Contractor acknowledges that the Village is a unit of local government and that all payments under the Contract are subject to the Local Government Prompt Payment Act, 50 ILCS 505 *et seq.* To that extent, the Village shall have forty-five calendar (45) days from receipt of a bill or invoice to pay the same before it is considered late under the Contract. Interest, if any, charged for any late payments will be subject to the interest rate caps specified in the Prompt Payment Act.

**36. Certified Payroll Reports**

Pursuant to PA 100-1177 the Illinois Department of Labor (IDOL) has activated an electronic database (Payroll Portal) capable of accepting and retaining certified payrolls submitted under the State of Illinois Prevailing Wage Act (820 ILCS/130/1). All contractors and subcontractors completing work for the Village of Buffalo Grove pursuant to the Act must submit all certified payroll through the IDOL Payroll Portal.

The Village is an Illinois unit of local government and the Work hereunder is subject to the Illinois Prevailing Wage Act, 820 ILCS 130/0.01, et seq. Consequently, the Contractor and each subcontractor shall submit with their application for payment(s) the email certification received from their IDOL Payroll Portal submittal with each of their pay requests. Any delay in processing the payments due to a lack of aforementioned email certification shall not be an event of default by the Village and shall not excuse any delay by the Contractor who shall proceed with the Work as if no delay in payment has occurred. The Contractor and Village shall agree to take any further steps not outlined above to ensure compliance with the Prevailing Wage Act. Upon two business days' Notice, the Contractor and each subcontractor shall make available to the Village their records to confirm compliance with the Prevailing Wage Act. Finally, to ensure compliance with Prevailing Wage Act, the Contractor and each subcontractor shall keep for a period of not less than 5 years after the Work has been completed records of all laborers, mechanics, and other workers employed by them for the Work; the records shall include each worker's name, address, telephone number, classification or classifications, the hourly wages paid in each period, the number of hours worked each day, the starting and ending times of work each day and, when available, last four digits of the social security number. The Contractor shall provide a list of every name, address, phone number and email of every sub-contractor for the Work.

If the contractor must submit the payroll to the Village of Buffalo Grove for reasons outside of their control, the Village requests that the Contractor submit all certified payroll reports, including subcontractors, and EEO reporting be sent electronically in separate files for each respective Contractor/subcontractor with the weeks ending date in the file name to [tsianis@vbg.org](mailto:tsianis@vbg.org) (i.e. Contractor Name Week Ending.pdf) as shown in the sample letter in Exhibit D.

The Contractor is responsible for providing all records in accordance with the Illinois Department of Labor's (IDOL) requirements pertaining to the Prevailing Wage Act on the standard IDOL form. Only the last four (4) digits of the employee's social security number will be required; the remaining digits shall be "X" or redacted. To complete the certified payroll request for release of payment, the Contractor must supply a signed and notarized written statement that all necessary documentation has been turned over for the pay period pertaining to that payment requested.

Under P.A. 98-0328, the public body must retain copies of the certified payroll for 5 years rather than 3 years as was the case previously. The Illinois Department of Labor (IDOL) has created model certified payroll forms which can be found at the IDOL website [www.illinois.gov/idol](http://www.illinois.gov/idol). The new form consists of three pages identified as the "certified transcript of payroll affidavit" and "certified transcript of payroll instructions". The new forms on the IDOL website can be filled in online and then printed out. under P.A. 98-0482, contractors and subcontractors will have to provide additional information with respect to working hours, wage rates, overtime rates and fringe benefits. The IDOL's model certified payroll forms are the most current forms for compliance with P.A. 98-0482 and should be used in public works contracts.

**37. Monetary Penalties**

All work shall be completed in accordance with the Contract Documents in a reasonable and timely manner. For each occurrence that work is not completed in a reasonable and timely manner, a monetary penalty will be deducted from the final pay application. The Contractor shall make themselves and all subcontractors aware of the following deficiency and deductions:

Description	Penalty	Per Occurrence
Failure to Sweep Roadway	\$2,000	Calendar Day
Failure to Maintain Trench	\$250	Calendar Day
Failure to Adhere to Period of Establishment Requirements	\$250	Calendar Day
Distributing Unapproved Resident Notices	\$100	Household
Failure to Distribute Notices in a Timely Manner	\$100	Household
Failure to Distribute Notice to Resident	\$100	Household
Failure to Provide Access in a Timely Manner	\$250	Household Per Day
Failure to Provide Weekly Update to Engineer	\$1,000	Per Occurrence
Failure to Attend a Scheduled Weekly Meeting	\$1,000	Per Occurrence

Failure to Respond in a Timely Manner to a Resident	\$250	Calendar Day
Failure to Ramp Roadway or Driveway	\$250	Household/Roadway Per Day
Use of Fire Hydrant or Valve	\$1,000	Each
Failure to Provide Maintenance of Roadway in a Timely Manner as Determined by the Engineer	\$1,000	Calendar Day
Entering Private Property	\$500	Per Occurrence
Failure to Provide Portable Facilities	\$100	Calendar Day
Illicit Discharge of Silt or Construction Debris	\$1,000	Per Occurrence
Failure to Submit Shop Drawings on Time	\$500	Per Occurrence
Failure to Maintain Erosion and/or Sediment Control Devices	\$1,000	Per Occurrence
Working Outside Allowable Work Hours	\$1,000	Per Occurrence

At the discretion of the Engineer and without notice, the Contractor shall have deducted the monetary penalty amount as listed above for each occurrence on the final pay application.

### 38. Public Notification

The Contractor shall be required to provide and distribute letters to residents or business owners anytime access will be affected to a home or utility service is interrupted. This general condition shall only apply when access will be directly affected for greater than four (4) hours, or as directed by the Engineer. Public notification shall not be required for every residence within the project limits.

Letters shall be typed on standard 8.5" x 11" paper and an envelope may or may not be used. All letters, including those written and distributed by a subcontractor, shall be printed on the General Contractor's letterhead and shall include the name, address, and telephone number of the General Contractor's person in charge.

Letters shall be taped to a non-painted surface using painters tape or approved equal, and will be placed in as many locations as needed to ensure they will be visible to residents. Distributing letters via mailbox is discouraged, however, must be compliant with all United States Postal Service federal regulations. Notification letters shall include but is not limited to the following:

- Exact day and time work is to begin that will affect access (weather permitting).
- How the resident will know they may resume normal access to their property.
- The anticipated length of the closure (no more than one week will be permitted).
- Specific location where parking is permitted, both overnight and during the working day (as signed and normally permitted during daytime).
- The Village of Buffalo Grove Police Department has been notified that overnight parking will be permitted. (It shall be the responsibility of the Contractor to confirm this with the Village.)
- The Contractor will go door-to-door the moment prior to work is to begin to ensure all accommodations are made.
- General Contractor's person in charge name and contact information for additional information or specific requests.
- If applicable, provide Resident flushing procedures (following reconnection of the water service, resident to flush inside of the house via the bath or utility sink for ten minutes prior to consumption).

Notification letters shall be distributed a minimum of 24 hours prior to access being affected or otherwise. If this requirements is not met, work shall not commence. **All letters must be approved by the Village or Engineer prior to and for each individual distribution.** Additional letters may be required when weather or other unforeseen circumstances change the schedule. When requested, the Contractor is required to return or provide correspondence from a resident within 24 hours.

Under special circumstances, the Village, may choose to write a notification letter and the Contractor shall still be responsible for delivering the letter as specified herein. An example of a resident notification letter can be found in Appendix A.

The Contractor must comply with all of the above-mentioned statements otherwise a monetary penalty of \$100 per household, per calendar day shall be imposed.

**39. Maintenance Bond**

The Contractor will be required to post a Maintenance Bond for a period of One Year (1-yr) from date of final acceptance by the Village. Final acceptance will be the date the Final Payment is made to the Contractor. The bond shall be in a form acceptable to the Village in the amount of 10% (ten percent) of the awarded contract value. Unless under emergency situations, the Village will offer the Contractor the ability to fix or repair any item prior to the bond being called. If the Contractor elects to perform the repairs themselves, all work must be complete within 14 calendar days of notice from the Village or the Village reserves the right to perform the repairs themselves.

The Maintenance Bond shall cover all necessary repairs or replacements as deemed necessary by the Village due to poor workmanship, failed materials, settlement of trenches, excessively spalled, chert popped or cracked concrete, storm and water main failures, restoration establishment, and other items as completed by the Contractor.

All required pavement repairs shall be from curb line to the nearest cold joint. Pavement repairs shall have all joints routed and filled with crack seal material including along the edge of pavement 1 month after installation.

If the Contractor elects to not perform the repairs or does not perform them in the time allotted the Village will perform the work and collect from the bond any damages incurred by the Village to perform the repairs.

## Special Provisions

### 1. Portland Cement Concrete Sidewalk

This work shall include all labor, material, and equipment necessary to construct portland cement concrete sidewalk and sidewalk accessibility ramps, of the depth specified, on a prepared subgrade where marked by the Engineer and in accordance with Section 424 of the Standard Specifications and as specified herein.

The proposed concrete sidewalk shall be poured within 24 hours following the completion of removal operations at each respective location.

If no existing expansion joint exists within 50 ft in either direction of the spot repair location, a ½ in preformed expansion joint filler shall be installed at the direction of the Engineer. Transverse expansion joints shall be placed at maximum intervals of 50 ft in the sidewalk. The expansion joint filler shall extend the entire depth of the concrete driveway edging. #4 smooth epoxy coated dowel bars shall be installed at 24" on center at sidewalk accessibility ramps between the keystone and curb.

The proposed sidewalk material shall be portland cement concrete in accordance with Section 1020 of the Standard Specifications.

This work will be measured in place and paid for at the contract unit price per square foot (SF) for PORTLAND CEMENT CONCRETE SIDEWALK, of the depth specified, which shall include all labor, material, and equipment required to complete the work as specified herein.

### 2. Remove and Relocate Sign Panel and Pole Assembly

This work shall include all labor, material, and equipment necessary to remove, store, and re-erect existing regulatory and warning sign panel assembly and posts in accordance with Section 724 of the Standard Specifications and as specified herein.

The Contractor shall store the existing sign panel assembly and post in a location that won't promote vandalism or theft. The Contractor shall replace, at no additional cost to the Owner, any sign panel assembly or post which has been vandalized, stolen or damaged due to neglect, misconduct or poor workmanship.

The sign panel assembly and post shall be installed by a method approved by the Engineer and in accordance with application sections of the Manual on Uniform Traffic Control Devices. Construction equipment such as a backhoe or skid steer shall not be used to drive posts into the ground.

This work will be measured in place and paid for at the contract unit price per each (EA) for REMOVE AND RELOCATE SIGN PANEL AND POLE ASSEMBLY, which shall include all labor, material, and equipment required to complete the work as specified herein.

### 3. General Landscape Restoration

This work shall include all labor, material, and equipment necessary to furnish, place, and maintain pulverized topsoil, seed, fertilizer nutrients, and Mulch Method 3A in accordance with Section(s) 211, 250, and 251 of the Standard Specifications and as specified herein.

Pulverized topsoil shall be placed to a maximum depth of four (4) inches and not be placed until the area has been shaped, trimmed, and finished to the lines and grades as directed by the Engineer. All irregularities, depressions, or high points in the surface shall be filled or smoothed out before topsoil is placed. The surface of the topsoil shall be blended to match the existing terrain and adjacent hardscape, and be free from clods, stones, sticks, and debris.

The Contractor shall furnish and place IDOT Class 1A salt tolerant lawn mixture, produced and tested in the current year, be of good quality, and free of weeds. Nitrogen and potassium fertilizer nutrients shall be applied at a 1:1 ratio in accordance with Article 250.04 of the Standard Specifications (phosphorus is not permitted). Within 24 hours of seed placement, mulch shall be placed my method 3A in accordance with Article 251.03(d) of the Standard Specifications.

It is recommended that the Contractor water the area every other day at a rate of three (3) gallons per square yard, however, it is the sole and exclusive responsibility of the Contractor to make required adjustments to the watering rate or schedule.

To be acceptable for final payment, the landscaped areas shall undergo a 30-day period of establishment beginning on the last day that seed is sowed. During this period, the Contractor shall be responsible for, at no additional cost to the Village, watering, removing weeds and maintaining the seeded areas and repairing any damage to the seeded areas due to but not limited to, errant vehicles, severe weather or all

other causes. At the end of the 30-day period of establishment, the Owner or Engineer will inspect the landscaped area and if deemed unsatisfactory, the Contractor shall be required to provide means and methods necessary to establish a live, healthy turf area. Should the seed not germinate because of prevailing cool weather, the period of establishment may be adjusted as determined by the Engineer. It shall be the sole and exclusive responsibility of the Contractor, not the Engineer, for maintaining and monitoring the landscape restoration during the period of establishment. If the placed landscape restoration has not been approved by the Owner or Engineer sixty (60) calendar days following installation, the Contractor will incur a monetary penalty of \$250 per calendar day.

**Planting times shall be in accordance with the applicable 'Seeding' Bureau of Design and Environment special provision.**

The Contractor shall provide the Engineer with proper documentation on the landscaping materials supplied to the project such as topsoil source, topsoil certification, fertilizer bags, seed tags, and seed bags.

Upon placement of topsoil, seed, fertilizer nutrients, and mulch, 75 percent of each respective pay item will be paid. Upon final acceptance of the topsoil, seed, fertilizer nutrients, and mulch placed, the remaining 25 percent of each respective pay item will be paid.

The Village may postpone permanent seeding operations if deemed necessary. In such an event, the completion date may be extended accordingly.

This work will be measured in place and paid for at the contract unit price per square yard (SY) for GENERAL LANDSCAPE RESTORATION (SPECIAL), which shall include all labor, material, and equipment required to complete the work as specified herein.

#### **4. Aggregate Base Course, Type B Varies**

This work shall include all labor, material, and equipment necessary to furnish and place aggregate base courses on a prepared subgrade or subbase in accordance with Section(s) 311 and 351 of the Standard Specifications and as specified herein.

This work includes all new aggregate base course material for aggregate base repair, front fill for new concrete curb and gutter, temporary aggregate, and subbase granular material for sidewalk and driveway pavement, at the depths specified on the Engineering plans.

The material used for this item shall be exclusively IDOT certified Class B coarse aggregate material meeting the gradation of CA-6 in accordance with Section 1004 of the Standard Specifications. Mixing of aggregate from multiple sources is strictly prohibited. If it is determined that a different source is required for any reason, the new material must be approved by the Engineer prior to delivery or placement, and shall occur roadway to roadway. Crushed concrete may not be used for aggregate base repair. At the direction of the Engineer, crushed concrete may be used for driveway and sidewalk subbase granular material but shall be supplied from an IDOT approved source and material.

All aggregate shall be compacted to 95% modified proctor density conforming to ASTM D-1557 or AASHTO T-180.

This work will be measured in place and paid for at the contract unit price per ton (TN) for AGGREGATE BASE COURSE, TYPE B VARIES (SPECIAL), which shall include all labor, material, and equipment required to complete the work as specified herein.

#### **5. Combination Concrete Curb and Gutter**

This work shall include all labor, material, and equipment necessary to construct concrete curb, and combination concrete curb and gutter, of the type specified, as marked by the Engineer in accordance with Section 606 of the Standard Specifications and as specified herein.

The Contractor shall closely match the existing concrete curb and gutter style type of the adjacent existing curb and gutter. This work shall include the installation of two (2) #4 continuous reinforcing bars as shown on the Engineering plans along the full length of the new curb and gutter. At points where the proposed concrete curb and gutter abuts existing concrete, two (2) smooth epoxy coated #4 dowel bars shall be installed at 24" on center. The depth of the proposed concrete gutter shall match the existing adjacent depth, but not less than nine (9) inches.

The material used for this item shall be exclusively portland cement concrete in accordance with Section 1020 of the Standard Specifications and shall have polyurethane coated fiber in the mix. The fiber shall be mixed in the concrete at a rate of 1.5 lbs per cubic yard of concrete at the ready mix plant. Mixing of the concrete and fibers shall not be permitted on the project site.



This work will be measured in place and paid for at the contract unit price per foot (FT) for COMBINATION CONCRETE CURB AND GUTTER, of the type specified, (SPECIAL) which shall include all labor, material, and equipment required to complete the work as specified herein.

**6. Barrier Curb, Variable Height**

This work shall include all labor, material, and equipment necessary to construct concrete barrier curb, of the width and height specified, as marked by the Engineer in accordance with Section 606 of the Standard Specifications and as specified herein.

As shown on the Engineering plans, this work shall include the installation of two (2) #4 continuous reinforcing bars along the full length of the new curb, and two (2) smooth epoxy coated #6 dowel bars at expansion joints. The depth of the proposed concrete curb shall be variable per the Engineering plans.

The material used for this item shall be exclusively portland cement concrete in accordance with Section 1020 of the Standard Specifications.

This work will be measured in place and paid for at the contract unit price per foot (FT) for BARRIER CURB, of the width specified, (SPECIAL) which shall include all labor, material, and equipment required to complete the work as specified herein.

**7. Sanitary Manholes to be Adjusted**

This work shall include all labor, material, and equipment necessary to adjust existing sanitary manholes in accordance with Section 602 and 603 of the Standard Specifications and as specified herein.

This shall include existing manholes which are to be adjusted to proposed grade where two (2) feet or less of masonry will be either added, removed, or rebuilt to bring the specified casting to the finished grade of the proposed improvements.

Adjustment ring material type and method shall be in accordance with Exhibit No. 109 Materials List, as specified herein. Bricks, aggregate, lathe, or any other organic material shall not be used as shim materials or otherwise. The units shall be sealed with external sealing bands, preformed flexible joint sealant or mastic joint sealer, and shall be watertight. An external chimney seal shall be furnished in accordance with ASTM C-923 and installed according to the manufacturer's recommendation.

This work will be measured in place and paid for at the contract unit price per each (EA) for SANITARY MANHOLES TO BE ADJUSTED (SPECIAL), which shall include all labor, material, and equipment required to complete the work as specified herein.

**8. Sanitary Manholes to be Reconstructed**

This work shall include all labor, material, and equipment necessary to reconstruct existing sanitary manholes in accordance with Section 602 and 603 of the Standard Specifications and as specified herein.

This shall include existing manholes which are to be reconstructed to proposed grade where more than two (2) feet of masonry will be either added, removed, or rebuilt to bring the specified casting to the finished grade of the proposed improvements.

The exterior of barrel sections shall have a bituminous coating per ANSI A 21.4 (AWWA C104) applied and cured prior to backfilling of the structure.

Adjustment ring material type and method shall be in accordance with Exhibit No. 109 Materials List, as specified herein. Bricks, aggregate, lathe, or any other organic material shall not be used as shim materials or otherwise. The units shall be sealed with external sealing bands, preformed flexible joint sealant or mastic joint sealer, and shall be watertight. An external chimney seal shall be furnished in accordance with ASTM C-923 and installed according to the manufacturer's recommendation.

This work will be measured in place and paid for at the contract unit price per each (EA) for SANITARY MANHOLES TO BE RECONSTRUCTED (SPECIAL), which shall include all labor, material, and equipment required to complete the work as specified herein.

**9. Drainage and Utility Structures to be Adjusted**

This work shall include all labor, material, and equipment necessary to adjust existing drainage and utility structures in accordance with Section 602 and 603 of the Standard Specifications and as specified herein.

This shall include existing drainage and utility structures which are to be adjusted to proposed grade where two (2) feet or less of masonry will be either added, removed, or rebuilt to bring the specified casting to the finished grade of the proposed improvements.

Adjustment ring material type and method shall be in accordance with Exhibit No. 109 Materials List, as specified herein. Bricks, aggregate, lathe, or any other organic material shall not be used as shim materials or otherwise.

This work will be measured in place and paid for at the contract unit price per each (EA) for DRAINAGE STRUCTURES TO BE ADJUSTED (SPECIAL), which shall include all labor, material, and equipment required to complete the work as specified herein.

#### **10. Exploration Excavation**

This work shall include all labor, material, and equipment necessary to excavate an exploratory trench as directed by the Engineer and as specified herein.

Exploration excavations shall be completed as required to locate existing utility facilities within the proposed project limits. The excavation shall not be less than 48 inches in depth and the width shall be sufficient to allow proper investigation of the entire trench length. The Contractor shall not be paid this item without prior approval from the Engineer.

The excavation shall be backfilled in accordance with Section 208 of the Standard Specifications or as directed by the Engineer. Surplus excavated material shall be disposed of off-site according to Article 202.03 of the Standard Specifications.

This work will be measured in place and paid for at the contract unit price per each (EA) for EXPLORATION EXCAVATION (SPECIAL), which shall include all labor, material, and equipment required to complete the work as specified herein.

#### **11. Stump Removal**

This work shall include all labor, material, and equipment necessary to remove and dispose of existing stumps, regardless of diameter or size, as marked by the Engineer in accordance with Section 201 of the Standard Specifications and as specified herein.

All stumps shall be removed to a depth of not less than twelve (12) inches below the elevation of the subgrade, the finished earth surface, or the ground line. Materials shall be disposed of off-site in accordance with Article 202.03 of the Standard Specifications.

This work will be measured in place and paid for at the contract unit price per each (EA) for STUMP REMOVAL, which shall include all labor, material, and equipment required to complete the work as specified herein.

#### **12. PVC Sleeve**

This work shall include all labor, material, and equipment necessary to furnish and install a polyvinyl chloride sleeve, of the diameter specified, for a sign post and panel assembly in accordance with Section 724 and 730 of the Standard Specifications and as specified herein.

The PVC sleeve shall be installed in the subgrade material to a depth of one (1) foot from finished elevation and be flush with the proposed sidewalk. The material used for this item shall be PVC SDR 35, of the diameter specified.

Surplus excavated material shall be disposed of off-site according to Article 202.03 of the Standard Specifications.

This work will be measured in place and paid for at the contract unit price per each (EA) for PVC SLEEVE, of the diameter specified, which shall include all labor, material, and equipment required to complete the work as specified herein.

**BDE SPECIAL PROVISIONS**  
For the January 20, 2023 and March 10, 2023 Lettings

The following special provisions indicated by a "check mark" are applicable to this contract and will be included by the Project Coordination and Implementation Section of the Bureau of Design & Environment (BDE).

File Name	#	Special Provision Title	Effective	Revised		
	80099	1	<input type="checkbox"/>	Accessible Pedestrian Signals (APS)	April 1, 2003	Jan. 1, 2022
	80274	2	<input type="checkbox"/>	Aggregate Subgrade Improvement	April 1, 2012	April 1, 2022
	80192	3	<input type="checkbox"/>	Automated Flagger Assistance Device	Jan. 1, 2008	
	80173	4	<input type="checkbox"/>	Bituminous Materials Cost Adjustments	Nov. 2, 2006	Aug. 1, 2017
	80426	5	<input type="checkbox"/>	Bituminous Surface Treatment with Fog Seal	Jan. 1, 2020	Jan. 1, 2022
	80436	6	<input type="checkbox"/>	Blended Finely Divided Minerals	April 1, 2021	
*	80241	7	<input type="checkbox"/>	Bridge Demolition Debris	July 1, 2009	
*	50531	8	<input type="checkbox"/>	Building Removal	Sept. 1, 1990	Aug. 1, 2022
*	50261	9	<input type="checkbox"/>	Building Removal with Asbestos Abatement	Sept. 1, 1990	Aug. 1, 2022
	80384	10	<input checked="" type="checkbox"/>	Compensable Delay Costs	June 2, 2017	April 1, 2019
*	80198	11	<input type="checkbox"/>	Completion Date (via calendar days)	April 1, 2008	
*	80199	12	<input type="checkbox"/>	Completion Date (via calendar days) Plus Working Days	April 1, 2008	
	80261	13	<input checked="" type="checkbox"/>	Construction Air Quality – Diesel Retrofit	June 1, 2010	Nov. 1, 2014
	80434	14	<input type="checkbox"/>	Corrugated Plastic Pipe (Culvert and Storm Sewer)	Jan. 1, 2021	
*	80029	15	<input type="checkbox"/>	Disadvantaged Business Enterprise Participation	Sept. 1, 2000	Mar. 2, 2019
	80229	16	<input type="checkbox"/>	Fuel Cost Adjustment	April 1, 2009	Aug. 1, 2017
	80447	17	<input type="checkbox"/>	Grading and Shaping Ditches	Jan. 1, 2023	
	80433	18	<input type="checkbox"/>	Green Preformed Thermoplastic Pavement Markings	Jan. 1, 2021	Jan. 1, 2022
	80443	19	<input type="checkbox"/>	High Tension Cable Median Barrier Removal	April 1, 2022	
	80446	20	<input type="checkbox"/>	Hot-Mix Asphalt - Longitudinal Joint Sealant	Nov. 1, 2022	
	80438	21	<input type="checkbox"/>	Illinois Works Apprenticeship Initiative – State Funded Contracts	June 2, 2021	Sept. 2, 2021
	80045	22	<input type="checkbox"/>	Material Transfer Device	June 15, 1999	Jan. 1, 2022
	80441	23	<input type="checkbox"/>	Performance Graded Asphalt Binder	Jan. 1, 2023	
*	34261	24	<input type="checkbox"/>	Railroad Protective Liability Insurance	Dec. 1, 1986	Jan. 1, 2022
	80445	25	<input checked="" type="checkbox"/>	Seeding	Nov. 1, 2022	
	80340	26	<input type="checkbox"/>	Speed Display Trailer	April 2, 2014	Jan. 1, 2022
	80127	27	<input type="checkbox"/>	Steel Cost Adjustment	April 2, 2004	Jan. 1, 2022
	80397	28	<input type="checkbox"/>	Subcontractor and DBE Payment Reporting	April 2, 2018	
	80391	29	<input checked="" type="checkbox"/>	Subcontractor Mobilization Payments	Nov. 2, 2017	April 1, 2019
	80437	30	<input type="checkbox"/>	Submission of Payroll Records	April 1, 2021	Nov. 1, 2022
	80435	31	<input type="checkbox"/>	Surface Testing of Pavements – IRI	Jan. 1, 2021	Jan. 1, 2023
	80410	32	<input type="checkbox"/>	Traffic Spotters	Jan. 1, 2019	
*	20338	33	<input type="checkbox"/>	Training Special Provisions	Oct. 15, 1975	Sept. 2, 2021
	80429	34	<input type="checkbox"/>	Ultra-Thin Bonded Wearing Course	April 1, 2020	Jan. 1, 2022
	80439	35	<input checked="" type="checkbox"/>	Vehicle and Equipment Warning Lights	Nov. 1, 2021	Nov. 1, 2022
	80440	36	<input type="checkbox"/>	Waterproofing Membrane System	Nov. 1, 2021	
	80302	37	<input type="checkbox"/>	Weekly DBE Trucking Reports	June 2, 2012	Nov. 1, 2021
	80427	38	<input checked="" type="checkbox"/>	Work Zone Traffic Control Devices	Mar. 2, 2020	
*	80071	39	<input type="checkbox"/>	Working Days	Jan. 1, 2002	

Highlighted items indicate a new or revised special provision for the letting.

An \* indicates the special provision requires additional information from the designer, which needs to be submitted separately. The Project Coordination and Implementation Section will then include the information in the applicable special provision.

The following special provisions have been deleted from use.

<u>File Name</u>	<u>Special Provision Title</u>	<u>Effective</u>	<u>Revised</u>
5048I	Building Removal-Case II (Non-Friable Asbestos)	Sept. 1, 1990	April 1, 2010
5049I	Building Removal-Case III (Friable Asbestos)	Sept. 1, 1990	April 1, 2010

The following special provisions are in the 2023 Supplemental Specifications and Recurring Special Provisions.

<u>File Name</u>	<u>Special Provision Title</u>	<u>New Location(s)</u>	<u>Effective</u>	<u>Revised</u>
80293	Concrete Box Culverts with Skews > 30 Degrees and Design Fills ≤ 5 Feet	Articles 540.04 & 540.06	April 1, 2012	July 1, 2016
80311	Concrete End Sections for Pipe Culverts	Articles 540.07, 542.01, 542.02, 542.07, 542.11 & 542.12	Jan. 1, 2013	April 1, 2016
80422	High Tension Cable Median Barrier	Articles 644.02, 644.05, 782.01, 782.04, 782.07 & 1097.02	Jan. 1, 2020	Jan. 1, 2022
80442	Hot-Mix Asphalt	Articles 1030.09 & 1030.10	Jan. 1, 2022	Aug. 1, 2022
80444	Hot-Mix Asphalt – Patching	Errata – Article 442.08(b)	April 1, 2022	
80411	Luminaires, LED	Articles 801.05(a), 821.02(d), 821.03, 821.08 & 1067.01-1067.06	April 1, 2019	Jan. 1, 2022
80418	Mechanically Stabilized Earth Retaining Walls	Articles 1003.07 & 1004.06	Nov. 1, 2019	Nov. 1, 2020
80430	Portland Cement Concrete – Haul Time	Article 1020.11(a)(7)	July 1, 2020	
80395	Sloped Metal End Section for Pipe Culverts	Articles 540.07, 542.01, 542.02, 542.07, 542.11 & 542.12	Jan. 1, 2018	
80318	Traversable Pipe Grate for Concrete End Sections	Articles 540.04, 540.07, 540.08 & 542.01, 542.02, 542.07, 542.11 & 542.12	Jan. 1, 2013	Jan. 1, 2018

## COMPENSABLE DELAY COSTS (BDE)

Effective: June 2, 2017

Revised: April 1, 2019

Revise Article 107.40(b) of the Standard Specifications to read:

“(b) Compensation. Compensation will not be allowed for delays, inconveniences, or damages sustained by the Contractor from conflicts with facilities not meeting the above definition; or if a conflict with a utility in an unanticipated location does not cause a shutdown of the work or a documentable reduction in the rate of progress exceeding the limits set herein. The provisions of Article 104.03 notwithstanding, compensation for delays caused by a utility in an unanticipated location will be paid according to the provisions of this Article governing minor and major delays or reduced rate of production which are defined as follows.

- (1) Minor Delay. A minor delay occurs when the work in conflict with the utility in an unanticipated location is completely stopped for more than two hours, but not to exceed two weeks.
- (2) Major Delay. A major delay occurs when the work in conflict with the utility in an unanticipated location is completely stopped for more than two weeks.
- (3) Reduced Rate of Production Delay. A reduced rate of production delay occurs when the rate of production on the work in conflict with the utility in an unanticipated location decreases by more than 25 percent and lasts longer than seven calendar days.”

Revise Article 107.40(c) of the Standard Specifications to read:

“(c) Payment. Payment for Minor, Major, and Reduced Rate of Production Delays will be made as follows.

- (1) Minor Delay. Labor idled which cannot be used on other work will be paid for according to Article 109.04(b)(1) and (2) for the time between start of the delay and the minimum remaining hours in the work shift required by the prevailing practice in the area.

Equipment idled which cannot be used on other work, and which is authorized to standby on the project site by the Engineer, will be paid for according to Article 109.04(b)(4).

- (2) Major Delay. Labor will be the same as for a minor delay.

Equipment will be the same as for a minor delay, except Contractor-owned equipment will be limited to two weeks plus the cost of move-out to either the

Contractor's yard or another job and the cost to re-mobilize, whichever is less. Rental equipment may be paid for longer than two weeks provided the Contractor presents adequate support to the Department (including lease agreement) to show retaining equipment on the job is the most economical course to follow and in the public interest.

- (3) Reduced Rate of Production Delay. The Contractor will be compensated for the reduced productivity for labor and equipment time in excess of the 25 percent threshold for that portion of the delay in excess of seven calendar days. Determination of compensation will be in accordance with Article 104.02, except labor and material additives will not be permitted.

Payment for escalated material costs, escalated labor costs, extended project overhead, and extended traffic control will be determined according to Article 109.13."

Revise Article 108.04(b) of the Standard Specifications to read:

"(b) No working day will be charged under the following conditions.

- (1) When adverse weather prevents work on the controlling item.
- (2) When job conditions due to recent weather prevent work on the controlling item.
- (3) When conduct or lack of conduct by the Department or its consultants, representatives, officers, agents, or employees; delay by the Department in making the site available; or delay in furnishing any items required to be furnished to the Contractor by the Department prevents work on the controlling item.
- (4) When delays caused by utility or railroad adjustments prevent work on the controlling item.
- (5) When strikes, lock-outs, extraordinary delays in transportation, or inability to procure critical materials prevent work on the controlling item, as long as these delays are not due to any fault of the Contractor.
- (6) When any condition over which the Contractor has no control prevents work on the controlling item."

Revise Article 109.09(f) of the Standard Specifications to read:

"(f) Basis of Payment. After resolution of a claim in favor of the Contractor, any adjustment in time required for the work will be made according to Section 108. Any adjustment in the costs to be paid will be made for direct labor, direct materials, direct equipment, direct jobsite overhead, direct offsite overhead, and other direct costs allowed by the resolution. Adjustments in costs will not be made for interest charges, loss of anticipated profit, undocumented loss of efficiency, home office overhead and unabsorbed overhead

other than as allowed by Article 109.13, lost opportunity, preparation of claim expenses and other consequential indirect costs regardless of method of calculation.

The above Basis of Payment is an essential element of the contract and the claim cost recovery of the Contractor shall be so limited.”

Add the following to Section 109 of the Standard Specifications.

**“109.13 Payment for Contract Delay.** Compensation for escalated material costs, escalated labor costs, extended project overhead, and extended traffic control will be allowed when such costs result from a delay meeting the criteria in the following table.

Contract Type	Cause of Delay	Length of Delay
Working Days	Article 108.04(b)(3) or Article 108.04(b)(4)	No working days have been charged for two consecutive weeks.
Completion Date	Article 108.08(b)(1) or Article 108.08(b)(7)	The Contractor has been granted a minimum two week extension of contract time, according to Article 108.08.

Payment for each of the various costs will be according to the following.

- (a) Escalated Material and/or Labor Costs. When the delay causes work, which would have otherwise been completed, to be done after material and/or labor costs have increased, such increases will be paid. Payment for escalated material costs will be limited to the increased costs substantiated by documentation furnished by the Contractor. Payment for escalated labor costs will be limited to those items in Article 109.04(b)(1) and (2), except the 35 percent and 10 percent additives will not be permitted.
- (b) Extended Project Overhead. For the duration of the delay, payment for extended project overhead will be paid as follows.
  - (1) Direct Jobsite and Offsite Overhead. Payment for documented direct jobsite overhead and documented direct offsite overhead, including onsite supervisory and administrative personnel, will be allowed according to the following table.

Original Contract Amount	Supervisory and Administrative Personnel
Up to \$5,000,000	One Project Superintendent
Over \$ 5,000,000 - up to \$25,000,000	One Project Manager, One Project Superintendent or Engineer, and One Clerk
Over \$25,000,000 - up to \$50,000,000	One Project Manager, One Project Superintendent, One Engineer, and

	One Clerk
Over \$50,000,000	One Project Manager, Two Project Superintendents, One Engineer, and One Clerk

(2) Home Office and Unabsorbed Overhead. Payment for home office and unabsorbed overhead will be calculated as 8 percent of the total delay cost.

(c) Extended Traffic Control. Traffic control required for an extended period of time due to the delay will be paid for according to Article 109.04.

When an extended traffic control adjustment is paid under this provision, an adjusted unit price as provided for in Article 701.20(a) for increase or decrease in the value of work by more than ten percent will not be paid.

Upon payment for a contract delay under this provision, the Contractor shall assign subrogation rights to the Department for the Department's efforts of recovery from any other party for monies paid by the Department as a result of any claim under this provision. The Contractor shall fully cooperate with the Department in its efforts to recover from another party any money paid to the Contractor for delay damages under this provision."



**CONSTRUCTION AIR QUALITY – DIESEL RETROFIT (BDE)**

Effective: June 1, 2010

Revised: November 1, 2014

The reduction of emissions of particulate matter (PM) for off-road equipment shall be accomplished by installing retrofit emission control devices. The term “equipment” refers to diesel fuel powered devices rated at 50 hp and above, to be used on the jobsite in excess of seven calendar days over the course of the construction period on the jobsite (including rental equipment).

Contractor and subcontractor diesel powered off-road equipment assigned to the contract shall be retrofitted using the phased in approach shown below. Equipment that is of a model year older than the year given for that equipment’s respective horsepower range shall be retrofitted:

Effective Dates	Horsepower Range	Model Year
June 1, 2010 <sup>1/</sup>	600-749	2002
	750 and up	2006
June 1, 2011 <sup>2/</sup>	100-299	2003
	300-599	2001
	600-749	2002
	750 and up	2006
June 1, 2012 <sup>2/</sup>	50-99	2004
	100-299	2003
	300-599	2001
	600-749	2002
	750 and up	2006

1/ Effective dates apply to Contractor diesel powered off-road equipment assigned to the contract.

2/ Effective dates apply to Contractor and subcontractor diesel powered off-road equipment assigned to the contract.

The retrofit emission control devices shall achieve a minimum PM emission reduction of 50 percent and shall be:

- a) Included on the U.S. Environmental Protection Agency (USEPA) *Verified Retrofit Technology List* (<http://www.epa.gov/cleandiesel/verification/verif-list.htm>), or verified by the California Air Resources Board (CARB) (<http://www.arb.ca.gov/diesel/verdev/vt/cvt.htm>); or
- b) Retrofitted with a non-verified diesel retrofit emission control device if verified retrofit emission control devices are not available for equipment proposed to be used on the project, and if the Contractor has obtained a performance certification from the retrofit

device manufacturer that the emission control device provides a minimum PM emission reduction of 50 percent.

Note: Large cranes (Crawler mounted cranes) which are responsible for critical lift operations are exempt from installing retrofit emission control devices if such devices adversely affect equipment operation.

Diesel powered off-road equipment with engine ratings of 50 hp and above, which are unable to be retrofitted with verified emission control devices or if performance certifications are not available which will achieve a minimum 50 percent PM reduction, may be granted a waiver by the Department if documentation is provided showing good faith efforts were made by the Contractor to retrofit the equipment.

Construction shall not proceed until the Contractor submits a certified list of the diesel powered off-road equipment that will be used, and as necessary, retrofitted with emission control devices. The list(s) shall include (1) the equipment number, type, make, Contractor/rental company name; and (2) the emission control devices make, model, USEPA or CARB verification number, or performance certification from the retrofit device manufacturer. Equipment reported as fitted with emissions control devices shall be made available to the Engineer for visual inspection of the device installation, prior to being used on the jobsite.

The Contractor shall submit an updated list of retrofitted off-road construction equipment as retrofitted equipment changes or comes on to the jobsite. The addition or deletion of any diesel powered equipment shall be included on the updated list.

If any diesel powered off-road equipment is found to be in non-compliance with any portion of this special provision, the Engineer will issue the Contractor a diesel retrofit deficiency deduction.

Any costs associated with retrofitting any diesel powered off-road equipment with emission control devices shall be considered as included in the contract unit prices bid for the various items of work involved and no additional compensation will be allowed. The Contractor's compliance with this notice and any associated regulations shall not be grounds for a claim.

### **Diesel Retrofit Deficiency Deduction**

When the Engineer determines that a diesel retrofit deficiency exists, a daily monetary deduction will be imposed for each calendar day or fraction thereof the deficiency continues to exist. The calendar day(s) will begin when the time period for correction is exceeded and end with the Engineer's written acceptance of the correction. The daily monetary deduction will be \$1,000.00 for each deficiency identified.

The deficiency will be based on lack of diesel retrofit emissions control.

If a Contractor accumulates three diesel retrofit deficiency deductions for the same piece of equipment in a contract period, the Contractor will be shutdown until the deficiency is corrected.

Such a shutdown will not be grounds for any extension of the contract time, waiver of penalties, or be grounds for any claim.

80261

## **SEEDING (BDE)**

Effective: November 1, 2022

Revise Article 250.07 of the Standard Specifications to read:

**"250.07 Seeding Mixtures.** The classes of seeding mixtures and combinations of mixtures will be designated in the plans.

When an area is to be seeded with two or more seeding classes, those mixtures shall be applied separately on the designated area within a seven day period. Seeding shall occur prior to placement of mulch cover. A Class 7 mixture can be applied at any time prior to applying any seeding class or added to them and applied at the same time.

TABLE 1 - SEEDING MIXTURES		
Class - Type	Seeds	lb/acre (kg/hectare)
1	Lawn Mixture 1/	Kentucky Bluegrass 100 (110) Perennial Ryegrass 60 (70) <i>Festuca rubra</i> ssp. <i>rubra</i> (Creeping Red Fescue) 40 (50)
1A	Salt Tolerant Lawn Mixture 1/	Kentucky Bluegrass 60 (70) Perennial Ryegrass 20 (20) <i>Festuca rubra</i> ssp. <i>rubra</i> (Creeping Red Fescue) 20 (20) <i>Festuca brevipilla</i> (Hard Fescue) 20 (20) <i>Puccinellia distans</i> (Fults Saltgrass or Salty Alkaligrass) 60 (70)
1B	Low Maintenance Lawn Mixture 1/	Turf-Type Fine Fescue 3/ 150 (170) Perennial Ryegrass 20 (20) Red Top 10 (10) <i>Festuca rubra</i> ssp. <i>rubra</i> (Creeping Red Fescue) 20 (20)
2	Roadside Mixture 1/	<i>Lolium arundinaceum</i> (Tall Fescue) 100 (110) Perennial Ryegrass 50 (55) <i>Festuca rubra</i> ssp. <i>rubra</i> (Creeping Red Fescue) 40 (50) Red Top 10 (10)
2A	Salt Tolerant Roadside Mixture 1/	<i>Lolium arundinaceum</i> (Tall Fescue) 60 (70) Perennial Ryegrass 20 (20) <i>Festuca rubra</i> ssp. <i>rubra</i> (Creeping Red Fescue) 30 (20) <i>Festuca brevipilla</i> (Hard Fescue) 30 (20) <i>Puccinellia distans</i> (Fults Saltgrass or Salty Alkaligrass) 60 (70)
3	Northern Illinois Slope Mixture 1/	<i>Elymus canadensis</i> (Canada Wild Rye) 5/ 5 (5) Perennial Ryegrass 20 (20) Alsike Clover 4/ 5 (5) <i>Desmanthus illinoensis</i> (Illinois Bundleflower) 4/ 5/ 2 (2) <i>Schizachyrium scoparium</i> (Little Bluestem) 5/ 12 (12) <i>Bouteloua curtipendula</i> (Side-Oats Grama) 5/ 10 (10) <i>Puccinellia distans</i> (Fults Saltgrass or Salty Alkaligrass) 30 (35) Oats, Spring 50 (55) Slender Wheat Grass 5/ 15 (15) Buffalo Grass 5/ 7/ 5 (5)
3A	Southern Illinois Slope Mixture 1/	Perennial Ryegrass 20 (20) <i>Elymus canadensis</i> (Canada Wild Rye) 5/ 20 (20) <i>Panicum virgatum</i> (Switchgrass) 5/ 10 (10) <i>Schizachyrium scoparium</i> (Little Blue Stem) 5/ 12 (12) <i>Bouteloua curtipendula</i> (Side-Oats Grama) 5/ 10 (10) <i>Dalea candida</i> (White Prairie Clover) 4/ 5/ 5 (5) <i>Rudbeckia hirta</i> (Black-Eyed Susan) 5/ 5 (5) Oats, Spring 50 (55)

Class – Type	Seeds	lb/acre (kg/hectare)
4 Native Grass 2/ 6/	<i>Andropogon gerardi</i> (Big Blue Stem) 5/	4 (4)
	<i>Schizachyrium scoparium</i> (Little Blue Stem) 5/	5 (5)
	<i>Bouteloua curtipendula</i> (Side-Oats Grama) 5/	5 (5)
	<i>Elymus canadensis</i> (Canada Wild Rye) 5/	1 (1)
	<i>Panicum virgatum</i> (Switch Grass) 5/	1 (1)
	<i>Sorghastrum nutans</i> (Indian Grass) 5/	2 (2)
	Annual Ryegrass	25 (25)
	Oats, Spring	25 (25)
	Perennial Ryegrass	15 (15)
4A Low Profile Native Grass 2/ 6/	<i>Schizachyrium scoparium</i> (Little Blue Stem) 5/	5 (5)
	<i>Bouteloua curtipendula</i> (Side-Oats Grama) 5/	5 (5)
	<i>Elymus canadensis</i> (Canada Wild Rye) 5/	1 (1)
	<i>Sporobolus heterolepis</i> (Prairie Dropseed) 5/	0.5 (0.5)
	Annual Ryegrass	25 (25)
	Oats, Spring	25 (25)
	Perennial Ryegrass	15 (15)
4B Wetland Grass and Sedge Mixture 2/ 6/	Annual Ryegrass	25 (25)
	Oats, Spring	25 (25)
	Wetland Grasses (species below) 5/	6 (6)
<u>Species:</u>		<u>% By Weight</u>
<i>Calamagrostis canadensis</i> (Blue Joint Grass)		12
<i>Carex lacustris</i> (Lake-Bank Sedge)		6
<i>Carex slipata</i> (Awl-Fruited Sedge)		6
<i>Carex stricta</i> (Tussock Sedge)		6
<i>Carex vulpinoidea</i> (Fox Sedge)		6
<i>Eleocharis acicularis</i> (Needle Spike Rush)		3
<i>Eleocharis obtusa</i> (Blunt Spike Rush)		3
<i>Glyceria striata</i> (Fowl Manna Grass)		14
<i>Juncus effusus</i> (Common Rush)		6
<i>Juncus tenuis</i> (Slender Rush)		6
<i>Juncus torreyi</i> (Torrey's Rush)		6
<i>Leersia oryzoides</i> (Rice Cut Grass)		10
<i>Scirpus acutus</i> (Hard-Stemmed Bulrush)		3
<i>Scirpus atrovirens</i> (Dark Green Rush)		3
<i>Bolboschoenus fluviatilis</i> (River Bulrush)		3
<i>Schoenoplectus tabernaemontani</i> (Softstem Bulrush)		3
<i>Spartina pectinata</i> (Cord Grass)		4

Class – Type	Seeds	lb/acre (kg/hectare)
5	Forb with Annuals Mixture 2/ 5/ 6/	1 (1) 10 (10)
	Annuals Mixture - Mixture not exceeding 25 % by weight of any one species, of the following:	
	<i>Coreopsis lanceolata</i> (Sand Coreopsis)	
	<i>Leucanthemum maximum</i> (Shasta Daisy)	
	<i>Gaillardia pulchella</i> (Blanket Flower)	
	<i>Ratibida columnifera</i> (Prairie Coneflower)	
	<i>Rudbeckia hirta</i> (Black-Eyed Susan)	
	Forb Mixture - Mixture not exceeding 5 % by weight PLS of any one species, of the following:	
	<i>Amorpha canescens</i> (Lead Plant) 4/	
	<i>Anemone cylindrica</i> (Thimble Weed)	
	<i>Asclepias tuberosa</i> (Butterfly Weed)	
	<i>Aster azureus</i> (Sky Blue Aster)	
	<i>Symphotrichum leave</i> (Smooth Aster)	
	<i>Aster novae-angliae</i> (New England Aster)	
	<i>Baptisia leucantha</i> (White Wild Indigo) 4/	
	<i>Coreopsis palmata</i> (Prairie Coreopsis)	
	<i>Echinacea pallida</i> (Pale Purple Coneflower)	
	<i>Eryngium yuccifolium</i> (Rattlesnake Master)	
	<i>Helianthus mollis</i> (Downy Sunflower)	
	<i>Heliopsis helianthoides</i> (Ox-Eye)	
	<i>Liatris aspera</i> (Rough Blazing Star)	
	<i>Liatris pycnostachya</i> (Prairie Blazing Star)	
	<i>Monarda fistulosa</i> (Prairie Bergamot)	
	<i>Parthenium integrifolium</i> (Wild Quinine)	
	<i>Dalea candida</i> (White Prairie Clover) 4/	
	<i>Dalea purpurea</i> (Purple Prairie Clover) 4/	
	<i>Physostegia virginiana</i> (False Dragonhead)	
	<i>Potentilla arguta</i> (Prairie Cinquefoil)	
	<i>Ratibida pinnata</i> (Yellow Coneflower)	
	<i>Rudbeckia subtomentosa</i> (Fragrant Coneflower)	
	<i>Silphium laciniatum</i> (Compass Plant)	
	<i>Silphium terebinthinaceum</i> (Prairie Dock)	
	<i>Oligoneuron rigidum</i> (Rigid Goldenrod)	
	<i>Tradescantia ohiensis</i> (Spiderwort)	
	<i>Veronicastrum virginicum</i> (Culver's Root)	

Class – Type	Seeds	lb/acre (kg/hectare)	
5A	Large Flower Native Forb Mixture 2/ 5/ 6/	Forb Mixture (see below)	5 (5)
	<u>Species:</u>	<u>% By Weight</u>	
	<i>Aster novae-angliae</i> (New England Aster)		5
	<i>Echinacea pallida</i> (Pale Purple Coneflower)		10
	<i>Helianthus mollis</i> (Downy Sunflower)		10
	<i>Heliopsis helianthoides</i> (Ox-Eye)		10
	<i>Liatris pycnostachya</i> (Prairie Blazing Star)		10
	<i>Ratibida pinnata</i> (Yellow Coneflower)		5
	<i>Rudbeckia hirta</i> (Black-Eyed Susan)		10
	<i>Silphium laciniatum</i> (Compass Plant)		10
	<i>Silphium terebinthinaceum</i> (Prairie Dock)		20
	<i>Oligoneuron rigidum</i> (Rigid Goldenrod)		10
5B	Wetland Forb 2/ 5/ 6/	Forb Mixture (see below)	2 (2)
	<u>Species:</u>	<u>% By Weight</u>	
	<i>Acorus calamus</i> (Sweet Flag)		3
	<i>Angelica atropurpurea</i> (Angelica)		6
	<i>Asclepias incarnata</i> (Swamp Milkweed)		2
	<i>Aster puniceus</i> (Purple Stemmed Aster)		10
	<i>Bidens cernua</i> (Beggarticks)		7
	<i>Eutrochium maculatum</i> (Spotted Joe Pye Weed)		7
	<i>Eupatorium perfoliatum</i> (Boneset)		7
	<i>Helenium autumnale</i> (Autumn Sneezeweed)		2
	<i>Iris virginica shrevei</i> (Blue Flag Iris)		2
	<i>Lobelia cardinalis</i> (Cardinal Flower)		5
	<i>Lobelia siphilitica</i> (Great Blue Lobelia)		5
	<i>Lythrum alatum</i> (Winged Loosestrife)		2
	<i>Physostegia virginiana</i> (False Dragonhead)		5
	<i>Persicaria pensylvanica</i> (Pennsylvania Smartweed)		10
	<i>Persicaria lapathifolia</i> (Curlytop Knotweed)		10
	<i>Pycnanthemum virginianum</i> (Mountain Mint)		5
	<i>Rudbeckia laciniata</i> (Cut-leaf Coneflower)		5
	<i>Oligoneuron riddellii</i> (Riddell Goldenrod)		2
	<i>Sparganium eurycarpum</i> (Giant Burreed)		5
6	Conservation Mixture 2/ 6/	<i>Schizachyrium scoparium</i> (Little Blue Stem) 5/ <i>Elymus canadensis</i> (Canada Wild Rye) 5/ Buffalo Grass 5/ 7/ Vernal Alfalfa 4/ Oats, Spring	5 (5)  2 (2)  5 (5) 15 (15) 48 (55)
6A	Salt Tolerant Conservation Mixture 2/ 6/	<i>Schizachyrium scoparium</i> (Little Blue Stem) 5/ <i>Elymus canadensis</i> (Canada Wild Rye) 5/ Buffalo Grass 5/ 7/ Vernal Alfalfa 4/ Oats, Spring <i>Puccinellia distans</i> (Fults Saltgrass or Salty Alkaligrass)	5 (5)  2 (2)  5 (5) 15 (15) 48 (55) 20 (20)
7	Temporary Turf Cover Mixture	Perennial Ryegrass Oats, Spring	50 (55) 64 (70)



Notes:

- 1/ Seeding shall be performed when the ambient temperature has been between 45 °F (7 °C) and 80 °F (27 °C) for a minimum of seven (7) consecutive days and is forecasted to be the same for the next five (5) days according to the National Weather Service.
- 2/ Seeding shall be performed in late fall through spring beginning when the ambient temperature has been below 45 °F (7 °C) for a minimum of seven (7) consecutive days and ending when the ambient temperature exceeds 80 °F (27 °C) according to the National Weather Service.
- 3/ Specific variety as shown in the plans or approved by the Engineer.
- 4/ Inoculation required.
- 5/ Pure Live Seed (PLS) shall be used.
- 6/ Fertilizer shall not be used.
- 7/ Seed shall be primed with  $KNO_3$  to break dormancy and dyed to indicate such.

Seeding will be inspected after a period of establishment. The period of establishment shall be six (6) months minimum, but not to exceed nine (9) months. After the period of establishment, areas not exhibiting 75 percent uniform growth shall be interseeded or reseeded, as determined by the Engineer, at no additional cost to the Department.”

80445

**SUBCONTRACTOR MOBILIZATION PAYMENTS (BDE)**

Effective: November 2, 2017

Revised: April 1, 2019

Replace the second paragraph of Article 109.12 of the Standard Specifications with the following:

“This mobilization payment shall be made at least seven days prior to the subcontractor starting work. The amount paid shall be at the following percentage of the amount of the subcontract reported on form BC 260A submitted for the approval of the subcontractor’s work.

Value of Subcontract Reported on Form BC 260A	Mobilization Percentage
Less than \$10,000	25%
\$10,000 to less than \$20,000	20%
\$20,000 to less than \$40,000	18%
\$40,000 to less than \$60,000	16%
\$60,000 to less than \$80,000	14%
\$80,000 to less than \$100,000	12%
\$100,000 to less than \$250,000	10%
\$250,000 to less than \$500,000	9%
\$500,000 to \$750,000	8%
Over \$750,000	7%”

## **VEHICLE AND EQUIPMENT WARNING LIGHTS (BDE)**

Effective: November 1, 2021

Revised: November 1, 2022

Add the following paragraph after the first paragraph of Article 701.08 of the Standard Specifications:

“The Contractor shall equip all vehicles and equipment with high-intensity oscillating, rotating, or flashing, amber or amber-and-white, warning lights which are visible from all directions. In accordance with 625 ILCS 5/12-215, the lights may only be in operation while the vehicle or equipment is engaged in construction operations.”

80439

**WORK ZONE TRAFFIC CONTROL DEVICES (BDE)**

Effective: March 2, 2020

Add the following to Article 701.03 of the Standard Specifications:

“(q) Temporary Sign Supports ..... 1106.02”

Revise the third paragraph of Article 701.14 of the Standard Specifications to read:

“For temporary sign supports, the Contractor shall provide a FHWA eligibility letter for each device used on the contract. The letter shall provide information for the set-up and use of the device as well as a detailed drawing of the device. The signs shall be supported within 20 degrees of vertical. Weights used to stabilize signs shall be attached to the sign support per the manufacturer's specifications.”

Revise the first paragraph of Article 701.15 of the Standard Specifications to read:

“**701.15 Traffic Control Devices.** For devices that must meet crashworthiness standards, the Contractor shall provide a manufacturer's self-certification or a FHWA eligibility letter for each Category 1 device and a FHWA eligibility letter for each Category 2 and Category 3 device used on the contract. The self-certification or letter shall provide information for the set-up and use of the device as well as a detailed drawing of the device.”

Revise the first six paragraphs of Article 1106.02 of the Standard Specifications to read:

“**1106.02 Devices.** Work zone traffic control devices and combinations of devices shall meet crashworthiness standards for their respective categories. The categories are as follows.

Category 1 includes small, lightweight, channelizing and delineating devices that have been in common use for many years and are known to be crashworthy by crash testing of similar devices or years of demonstrable safe performance. These include cones, tubular markers, plastic drums, and delineators, with no attachments (e.g. lights). Category 1 devices manufactured after December 31, 2019 shall be MASH-16 compliant. Category 1 devices manufactured on or before December 31, 2019, and compliant with NCHRP 350 or MASH 2009, may be used on contracts let before December 31, 2024.

Category 2 includes devices that are not expected to produce significant vehicular velocity change but may otherwise be hazardous. These include vertical panels with lights, barricades, temporary sign supports, and Category 1 devices with attachments (e.g. drums with lights). Category 2 devices manufactured after December 31, 2019 shall be MASH-16 compliant. Category 2 devices manufactured on or before December 31, 2019, and compliant with NCHRP 350 or MASH 2009, may be used on contracts let before December 31, 2024.

Category 3 includes devices that are expected to cause significant velocity changes or other potentially harmful reactions to impacting vehicles. These include crash cushions (impact

attenuators), truck mounted attenuators, and other devices not meeting the definitions of Category 1 or 2. Category 3 devices manufactured after December 31, 2019 shall be MASH-16 compliant. Category 3 devices manufactured on or before December 31, 2019, and compliant with NCHRP 350 or MASH 2009, may be used on contracts let before December 31, 2029. Category 3 devices shall be crash tested for Test Level 3 or the test level specified.

Category 4 includes portable or trailer-mounted devices such as arrow boards, changeable message signs, temporary traffic signals, and area lighting supports. It is preferable for Category 4 devices manufactured after December 31, 2019 to be MASH-16 compliant; however, there are currently no crash tested devices in this category, so it remains exempt from the NCHRP 350 or MASH compliance requirement.

For each type of device, when no more than one MASH-16 compliant is available, an NCHRP 350 or MASH-2009 compliant device may be used, even if manufactured after December 31, 2019.”

Revise Articles 1106.02(g), 1106.02(k), and 1106.02(l) to read:

“(g) Truck Mounted/Trailer Mounted Attenuators. The attenuator shall be approved for use at Test Level 3. Test Level 2 may be used for normal posted speeds less than or equal to 45 mph.

(k) Temporary Water Filled Barrier. The water filled barrier shall be a lightweight plastic shell designed to accept water ballast and be on the Department’s qualified product list.

Shop drawings shall be furnished by the manufacturer and shall indicate the deflection of the barrier as determined by acceptance testing; the configuration of the barrier in that test; and the vehicle weight, velocity, and angle of impact of the deflection test. The Engineer shall be provided one copy of the shop drawings.

(l) Movable Traffic Barrier. The movable traffic barrier shall be on the Department’s qualified product list.

Shop drawings shall be furnished by the manufacturer and shall indicate the deflection of the barrier as determined by acceptance testing; the configuration of the barrier in that test; and the vehicle weight, velocity, and angle of impact of the deflection test. The Engineer shall be provided one copy of the shop drawings. The barrier shall be capable of being moved on and off the roadway on a daily basis.”

## Cook County Prevailing Wage Rates posted on 1/18/2023

Trade Title	Rg	Type	C	Base	Foreman	Overtime					Pension	Vac	Trng	Other Ins
						M-F	Sa	Su	Hol	H/W				
ASBESTOS ABT-GEN	All	ALL		47.40	48.40	1.5	1.5	2.0	2.0	17.05	15.21	0.00	0.90	
ASBESTOS ABT-MEC	All	BLD		39.60	42.77	1.5	1.5	2.0	2.0	14.77	13.59	0.00	0.86	
BOILERMAKER	All	BLD		53.66	58.48	2.0	2.0	2.0	2.0	6.97	23.69	0.00	2.67	
BRICK MASON	All	BLD		49.81	54.79	1.5	1.5	2.0	2.0	12.10	21.56	0.00	1.10	
CARPENTER	All	ALL		52.01	54.01	1.5	1.5	2.0	2.0	11.79	24.76	1.50	0.80	
CEMENT MASON	All	ALL		49.75	51.75	2.0	1.5	2.0	2.0	17.08	20.74	0.00	1.00	
CERAMIC TILE FINISHER	All	BLD		44.18	44.18	1.5	1.5	2.0	2.0	12.25	14.77	0.00	1.00	
CERAMIC TILE LAYER	All	BLD		51.44	55.44	1.5	1.5	2.0	2.0	12.25	18.48	0.00	1.08	
COMMUNICATION ELECTRICIAN	All	BLD		47.16	50.46	1.5	1.5	2.0	2.0	12.70	14.10	1.25	1.57	0.50
ELECTRIC PWR EQMT OP	All	ALL		58.25	63.91	1.5	1.5	2.0	2.0	13.08	19.67	0.00	3.19	
ELECTRIC PWR GRNDMAN	All	ALL		45.44	63.91	1.5	1.5	2.0	2.0	10.20	15.34	0.00	2.49	
ELECTRIC PWR LINEMAN	All	ALL		58.25	63.91	1.5	1.5	2.0	2.0	13.08	19.67	0.00	3.19	
ELECTRICIAN	All	ALL		52.05	55.69	1.5	1.5	2.0	2.0	17.65	18.30	1.25	1.92	1.50
ELEVATOR CONSTRUCTOR	All	BLD		62.47	70.28	2.0	2.0	2.0	2.0	16.03	20.21	5.00	0.65	
FENCE ERECTOR	All	ALL		46.89	48.89	1.5	1.5	2.0	2.0	13.68	17.42	0.00	0.75	
GLAZIER	All	BLD		48.75	50.25	1.5	2.0	2.0	2.0	15.19	24.43	0.00	1.70	
HEAT/FROST INSULATOR	All	BLD		52.80	55.97	1.5	1.5	2.0	2.0	14.77	16.76	0.00	0.86	
IRON WORKER	All	ALL		55.81	57.81	2.0	2.0	2.0	2.0	16.05	25.31	0.00	0.49	
LABORER	All	ALL		47.40	48.15	1.5	1.5	2.0	2.0	17.05	15.21	0.00	0.90	
LATHER	All	ALL		52.01	54.01	1.5	1.5	2.0	2.0	11.79	24.76	1.50	0.80	
MACHINIST	All	BLD		53.18	57.18	1.5	1.5	2.0	2.0	9.93	8.95	1.85	1.47	
MARBLE FINISHER	All	ALL		38.00	51.41	1.5	1.5	2.0	2.0	12.10	19.60	0.00	0.60	
MARBLE SETTER	All	BLD		48.96	53.86	1.5	1.5	2.0	2.0	12.10	21.03	0.00	0.78	
MATERIAL TESTER I	All	ALL		37.40		1.5	1.5	2.0	2.0	17.05	15.21	0.00	0.90	
MATERIALS TESTER II	All	ALL		42.40		1.5	1.5	2.0	2.0	17.05	15.21	0.00	0.90	
MILLWRIGHT	All	ALL		52.01	54.01	1.5	1.5	2.0	2.0	11.79	24.76	1.50	0.80	
OPERATING ENGINEER	All	BLD	1	55.10	59.10	2.0	2.0	2.0	2.0	22.15	19.30	2.00	2.55	
OPERATING ENGINEER	All	BLD	2	53.80	59.10	2.0	2.0	2.0	2.0	22.15	19.30	2.00	2.55	
OPERATING ENGINEER	All	BLD	3	51.25	59.10	2.0	2.0	2.0	2.0	22.15	19.30	2.00	2.55	
OPERATING ENGINEER	All	BLD	4	49.50	59.10	2.0	2.0	2.0	2.0	22.15	19.30	2.00	2.55	
OPERATING ENGINEER	All	BLD	5	58.85	59.10	2.0	2.0	2.0	2.0	22.15	19.30	2.00	2.55	

OPERATING ENGINEER	All	BLD	6	56.10	59.10	2.0	2.0	2.0	2.0	22.15	19.30	2.00	2.55
OPERATING ENGINEER	All	BLD	7	58.10	59.10	2.0	2.0	2.0	2.0	22.15	19.30	2.00	2.55
OPERATING ENGINEER	All	FLT	1	61.10	61.10	1.5	1.5	2.0	2.0	21.40	18.60	2.00	2.40
OPERATING ENGINEER	All	FLT	2	59.60	61.10	1.5	1.5	2.0	2.0	21.40	18.60	2.00	2.40
OPERATING ENGINEER	All	FLT	3	58.10	61.10	1.5	1.5	2.0	2.0	21.40	18.60	2.00	2.40
OPERATING ENGINEER	All	FLT	4	53.60	61.10	1.5	1.5	2.0	2.0	21.40	18.60	2.00	2.40
OPERATING ENGINEER	All	FLT	5	62.60	61.10	1.5	1.5	2.0	2.0	21.40	18.60	2.00	2.40
OPERATING ENGINEER	All	FLT	6	41.00	61.10	1.5	1.5	2.0	2.0	21.40	18.60	2.00	2.40
OPERATING ENGINEER	All	HWY	1	53.30	57.30	1.5	1.5	2.0	2.0	22.15	19.30	2.00	2.55
OPERATING ENGINEER	All	HWY	2	52.75	57.30	1.5	1.5	2.0	2.0	22.15	19.30	2.00	2.55
OPERATING ENGINEER	All	HWY	3	50.70	57.30	1.5	1.5	2.0	2.0	22.15	19.30	2.00	2.55
OPERATING ENGINEER	All	HWY	4	49.30	57.30	1.5	1.5	2.0	2.0	22.15	19.30	2.00	2.55
OPERATING ENGINEER	All	HWY	5	48.10	57.30	1.5	1.5	2.0	2.0	22.15	19.30	2.00	2.55
OPERATING ENGINEER	All	HWY	6	56.30	57.30	1.5	1.5	2.0	2.0	22.15	19.30	2.00	2.55
OPERATING ENGINEER	All	HWY	7	54.30	57.30	1.5	1.5	2.0	2.0	22.15	19.30	2.00	2.55
ORNAMENTAL IRON WORKER	All	ALL		53.32	55.82	2.0	2.0	2.0	2.0	14.23	25.00	0.00	1.75
PAINTER	All	ALL		50.30	56.59	1.5	1.5	1.5	2.0	14.26	14.99	0.00	1.72
PAINTER - SIGNS	All	BLD		41.55	46.67	1.5	1.5	2.0	2.0	3.04	3.90	0.00	0.00
PILEDRIIVER	All	ALL		52.01	54.01	1.5	1.5	2.0	2.0	11.79	24.76	1.50	0.80
PIPEFITTER	All	BLD		53.00	56.00	1.5	1.5	2.0	2.0	11.85	22.85	0.00	2.92
PLASTERER	All	BLD		47.75	50.62	1.5	1.5	2.0	2.0	17.08	19.18	0.00	1.00
PLUMBER	All	BLD		54.80	58.10	1.5	1.5	2.0	2.0	16.70	17.04	0.00	1.58
ROOFER	All	BLD		48.00	53.00	1.5	1.5	2.0	2.0	11.83	15.26	0.00	0.99
SHEETMETAL WORKER	All	BLD		49.10	53.03	1.5	1.5	2.0	2.0	13.53	28.20	0.00	1.00
SIGN HANGER	All	BLD		34.72	37.50	1.5	1.5	2.0	2.0	6.85	4.50	0.00	0.00
SPRINKLER FITTER	All	BLD		54.55	57.30	1.5	1.5	2.0	2.0	14.20	18.70	0.00	0.75
STEEL ERECTOR	All	ALL		55.81	57.81	2.0	2.0	2.0	2.0	16.05	25.31	0.00	0.49
STONE MASON	All	BLD		49.81	54.79	1.5	1.5	2.0	2.0	12.10	21.56	0.00	1.10
TERRAZZO FINISHER	All	BLD		45.57	45.57	1.5	1.5	2.0	2.0	12.25	17.14	0.00	1.03
TERRAZZO MECHANIC	All	BLD		49.41	52.91	1.5	1.5	2.0	2.0	12.25	18.60	0.00	1.07
TRAFFIC SAFETY WORKER I	All	HWY		39.30	40.90	1.5	1.5	2.0	2.0	9.65	9.10	0.00	0.10
TRAFFIC SAFETY WORKER II	All	HWY		40.30	41.90	1.5	1.5	2.0	2.0	9.65	9.10	0.00	0.10
TRUCK DRIVER	E	ALL	1	39.95	40.60	1.5	1.5	2.0	2.0	12.30	15.24	0.00	0.15
TRUCK DRIVER	E	ALL	2	40.20	40.60	1.5	1.5	2.0	2.0	12.30	15.24	0.00	0.15
TRUCK DRIVER	E	ALL	3	40.40	40.60	1.5	1.5	2.0	2.0	12.30	15.24	0.00	0.15
TRUCK DRIVER	E	ALL	4	40.60	40.60	1.5	1.5	2.0	2.0	12.30	15.24	0.00	0.15

TRUCK DRIVER	W	ALL	1	40.63	41.18	1.5	1.5	2.0	2.0	10.70	14.71	0.00	0.15
TRUCK DRIVER	W	ALL	2	40.78	41.18	1.5	1.5	2.0	2.0	10.70	14.71	0.00	0.15
TRUCK DRIVER	W	ALL	3	40.98	41.18	1.5	1.5	2.0	2.0	10.70	14.71	0.00	0.15
TRUCK DRIVER	W	ALL	4	41.18	41.18	1.5	1.5	2.0	2.0	10.70	14.71	0.00	0.15
TUCK POINTER	All	BLD		49.53	50.53	1.5	1.5	2.0	2.0	9.04	21.06	0.00	1.07

**Legend**

**Rg** Region

**Type** Trade Type - All,Highway,Building,Floating,Oil & Chip,Rivers

**C** Class

**Base** Base Wage Rate

**OT M-F** Unless otherwise noted, OT pay is required for any hour greater than 8 worked each day, Mon through Fri. The number listed is the multiple of the base wage.

**OT Sa** Overtime pay required for every hour worked on Saturdays

**OT Su** Overtime pay required for every hour worked on Sundays

**OT Hol** Overtime pay required for every hour worked on Holidays

**H/W** Health/Welfare benefit

**Vac** Vacation

**Trng** Training

**Other Ins** Employer hourly cost for any other type(s) of insurance provided for benefit of worker.

Explanations COOK COUNTY

The following list is considered as those days for which holiday rates of wages for work performed apply: New Years Day, Memorial Day, Fourth of July, Labor Day, Thanksgiving Day, Christmas Day and Veterans Day in some classifications/counties. Generally, any of these holidays which fall on a Sunday is celebrated on the following Monday. This then makes work performed on that Monday payable at the appropriate overtime rate for holiday pay. Common practice in a given local may alter certain days of celebration. If in doubt, please check with IDOL.

TRUCK DRIVERS (WEST) - That part of the county West of Barrington Road.

EXPLANATION OF CLASSES

ASBESTOS - GENERAL - removal of asbestos material/mold and hazardous materials from any place in a building, including mechanical systems where those mechanical systems are to be removed. This includes the removal of asbestos materials/mold and hazardous materials from ductwork or pipes in a building when the building is to be demolished at the time or at some close future date. ASBESTOS - MECHANICAL - removal of asbestos material from mechanical systems, such as pipes, ducts, and boilers, where the mechanical systems are to remain.

CERAMIC TILE FINISHER

The grouting, cleaning, and polishing of all classes of tile, whether for interior or exterior purposes, all burned, glazed or unglazed products; all composition materials, granite tiles, warning detectable tiles, cement tiles, epoxy composite materials, pavers, glass, mosaics, fiberglass, and all substitute materials, for tile made in tile-like units; all mixtures in tile like form of cement, metals, and other materials that are for and intended for use as a finished floor surface, stair treads, promenade roofs, walks, walls, ceilings, swimming pools, and all other places where tile is to form a finished interior or exterior. The mixing of all setting mortars including but not limited to thin-set mortars, epoxies, wall mud, and any other sand and cement mixtures or adhesives when



used in the preparation, installation, repair, or maintenance of tile and/or similar materials. The handling and unloading of all sand, cement, lime, tile, fixtures, equipment, adhesives, or any other materials to be used in the preparation, installation, repair, or maintenance of tile and/or similar materials. Ceramic Tile Finishers shall fill all joints and voids regardless of method on all tile work, particularly and especially after installation of said tile work. Application of any and all protective coverings to all types of tile installations including, but not be limited to, all soap compounds, paper products, tapes, and all polyethylene coverings, plywood, masonite, cardboard, and any new type of products that may be used to protect tile installations, Blastrac equipment, and all floor scarifying equipment used in preparing floors to receive tile. The clean up and removal of all waste and materials. All demolition of existing tile floors and walls to be re-tiled.

#### COMMUNICATIONS ELECTRICIAN

Installation, operation, inspection, maintenance, repair and service of radio, television, recording, voice sound vision production and reproduction, telephone and telephone interconnect, facsimile, data apparatus, coaxial, fibre optic and wireless equipment, appliances and systems used for the transmission and reception of signals of any nature, business, domestic, commercial, education, entertainment, and residential purposes, including but not limited to, communication and telephone, electronic and sound equipment, fibre optic and data communication systems, and the performance of any task directly related to such installation or service whether at new or existing sites, such tasks to include the placing of wire and cable and electrical power conduit or other raceway work within the equipment room and pulling wire and/or cable through conduit and the installation of any incidental conduit, such that the employees covered hereby can complete any job in full.

#### MARBLE FINISHER

Loading and unloading trucks, distribution of all materials (all stone, sand, etc.), stocking of floors with material, performing all rigging for heavy work, the handling of all material that may be needed for the installation of such materials, building of scaffolding, polishing if needed, patching, waxing of material if damaged, pointing up, caulking, grouting and cleaning of marble, holding water on diamond or Carborundum blade or saw for setters cutting, use of tub saw or any other saw needed for preparation of material, drilling of holes for wires that anchor material set by setters, mixing up of molding plaster for installation of material, mixing up thin set for the installation of material, mixing up of sand to cement for the installation of material and such other work as may be required in helping a Marble Setter in the handling of all material in the erection or installation of interior marble, slate, travertine, art marble, serpentine, alberene stone, blue stone, granite and other stones (meaning as to stone any foreign or domestic materials as are specified and used in building interiors and exteriors and customarily known as stone in the trade), carrara, sanionyx, vitrolite and similar opaque glass and the laying of all marble tile, terrazzo tile, slate tile and precast tile, steps, risers treads, base, or any other materials that may be used as substitutes for any of the aforementioned materials and which are used on interior and exterior which are installed in a similar manner.

MATERIAL TESTER I: Hand coring and drilling for testing of materials; field inspection of uncured concrete and asphalt.

MATERIAL TESTER II: Field inspection of welds, structural steel, fireproofing, masonry, soil, facade, reinforcing steel, formwork, cured concrete, and concrete and asphalt batch plants; adjusting proportions of bituminous mixtures.

#### OPERATING ENGINEER - BUILDING

Class 1. Asphalt Plant; Asphalt Spreader; Autograde; Backhoes with Caisson Attachment; Batch Plant; Benoto (requires Two Engineers); Boiler and Throttle Valve; Caisson Rigs; Central Redi-Mix Plant; Combination Back Hoe Front End-loader Machine; Compressor and Throttle Valve; Concrete Breaker (Truck Mounted); Concrete Conveyor; Concrete Conveyor (Truck Mounted); Concrete Paver Over 27E cu. ft; Concrete Paver 27E cu. ft. and Under: Concrete Placer; Concrete Placing Boom; Concrete Pump (Truck Mounted); Concrete Tower; Cranes, All; Cranes, Hammerhead; Cranes, (GCI and similar Type); Creter Crane; Spider Crane; Crusher, Stone, etc.; Derricks, All; Derricks, Traveling; Formless Curb and Gutter Machine; Grader, Elevating; Grouting Machines; Heavy Duty Self-Propelled Transporter or Prime Mover; Highlift Shovels or Front Endloader 2-1/4 yd. and over; Hoists, Elevators, outside type rack and pinion and similar machines; Hoists, One, Two and Three Drum; Hoists, Two Tugger One Floor; Hydraulic

Backhoes; Hydraulic Boom Trucks; Hydro Vac (and similar equipment); Locomotives, All; Motor Patrol; Lubrication Technician; Manipulators; Pile Drivers and Skid Rig; Post Hole Digger; Pre-Stress Machine; Pump Cretes Dual Ram; Pump Cretes: Squeeze Cretes-Screw Type Pumps; Gypsum Bulker and Pump; Raised and Blind Hole Drill; Roto Mill Grinder; Scoops - Tractor Drawn; Slip-Form Paver; Straddle Buggies; Operation of Tie Back Machine; Tournapull; Tractor with Boom and Side Boom; Trenching Machines.

Class 2. Boilers; Broom, All Power Propelled; Bulldozers; Concrete Mixer (Two Bag and Over); Conveyor, Portable; Forklift Trucks; Highlift Shovels or Front Endloaders under 2-1/4 yd.; Hoists, Automatic; Hoists, Inside Elevators; Hoists, Sewer Dragging Machine; Hoists, Tugger Single Drum; Laser Screed; Rock Drill (Self-Propelled); Rock Drill (Truck Mounted); Rollers, All; Steam Generators; Tractors, All; Tractor Drawn Vibratory Roller; Winch Trucks with "A" Frame.

Class 3. Air Compressor; Combination Small Equipment Operator; Generators; Heaters, Mechanical; Hoists, Inside Elevators (remodeling or renovation work); Hydraulic Power Units (Pile Driving, Extracting, and Drilling); Pumps, over 3" (1 to 3 not to exceed a total of 300 ft.); Low Boys; Pumps, Well Points; Welding Machines (2 through 5); Winches, 4 Small Electric Drill Winches.

Class 4. Bobcats and/or other Skid Steer Loaders; Oilers; and Brick Forklift.

Class 5. Assistant Craft Foreman.

Class 6. Gradall.

Class 7. Mechanics; Welders.

#### OPERATING ENGINEERS - HIGHWAY CONSTRUCTION

Class 1. Asphalt Plant; Asphalt Heater and Planer Combination; Asphalt Heater Scarfire; Asphalt Spreader; Autograder/GOMACO or other similar type machines; ABG Paver; Backhoes with Caisson Attachment; Ballast Regulator; Belt Loader; Caisson Rigs; Car Dumper; Central Redi-Mix Plant; Combination Backhoe Front Endloader Machine, (1 cu. yd. Backhoe Bucket or over or with attachments); Concrete Breaker (Truck Mounted); Concrete Conveyor; Concrete Paver over 27E cu. ft.; Concrete Placer; Concrete Tube Float; Cranes, all attachments; Cranes, Tower Cranes of all types: Creter Crane: Spider Crane; Crusher, Stone, etc.; Derricks, All; Derrick Boats; Derricks, Traveling; Dredges; Elevators, Outside type Rack & Pinion and Similar Machines; Formless Curb and Gutter Machine; Grader, Elevating; Grader, Motor Grader, Motor Patrol, Auto Patrol, Form Grader, Pull Grader, Subgrader; Guard Rail Post Driver Truck Mounted; Hoists, One, Two and Three Drum; Heavy Duty Self-Propelled Transporter or Prime Mover; Hydraulic Backhoes; Backhoes with shear attachments up to 40' of boom reach; Lubrication Technician; Manipulators; Mucking Machine; Pile Drivers and Skid Rig; Pre-Stress Machine; Pump Cretes Dual Ram; Rock Drill - Crawler or Skid Rig; Rock Drill - Truck Mounted; Rock/Track Tamper; Roto Mill Grinder; Slip-Form Paver; Snow Melters; Soil Test Drill Rig (Truck Mounted); Straddle Buggies; Hydraulic Telescoping Form (Tunnel); Operation of Tieback Machine; Tractor Drawn Belt Loader; Tractor Drawn Belt Loader (with attached pusher - two engineers); Tractor with Boom; Tractaire with Attachments; Traffic Barrier Transfer Machine; Trenching; Truck Mounted Concrete Pump with Boom; Raised or Blind Hole Drills (Tunnel Shaft); Underground Boring and/or Mining Machines 5 ft. in diameter and over tunnel, etc; Underground Boring and/or Mining Machines under 5 ft. in diameter; Wheel Excavator; Widener (APSCO).

Class 2. Batch Plant; Bituminous Mixer; Boiler and Throttle Valve; Bulldozers; Car Loader Trailing Conveyors; Combination Backhoe Front Endloader Machine (Less than 1 cu. yd. Backhoe Bucket or over or with attachments); Compressor and Throttle Valve; Compressor, Common Receiver (3); Concrete Breaker or Hydro Hammer; Concrete Grinding Machine; Concrete Mixer or Paver 7S Series to and including 27 cu. ft.; Concrete Spreader; Concrete Curing Machine, Burlap Machine, Belting Machine and Sealing Machine; Concrete Wheel Saw; Conveyor Muck Cars (Haglund or Similar Type); Drills, All; Finishing Machine - Concrete; Highlift Shovels or Front Endloader; Hoist - Sewer Dragging Machine; Hydraulic Boom Trucks (All Attachments); Hydro-Blaster; Hydro Excavating (excluding hose work); Laser Screed; All Locomotives, Dinky; Off-Road Hauling Units (including articulating) Non Self-Loading Ejection Dump; Pump Cretes: Squeeze Cretes - Screw Type Pumps, Gypsum Bulker and Pump; Roller, Asphalt; Rotary

Snow Plows; Rototiller, Seaman, etc., self-propelled; Self-Propelled Compactor; Spreader - Chip - Stone, etc.; Scraper - Single/Twin Engine/Push and Pull; Scraper - Prime Mover in Tandem (Regardless of Size); Tractors pulling attachments, Sheeps Foot, Disc, Compactor, etc.; Tug Boats.

Class 3. Boilers; Brooms, All Power Propelled; Cement Supply Tender; Compressor, Common Receiver (2); Concrete Mixer (Two Bag and Over); Conveyor, Portable; Farm-Type Tractors Used for Mowing, Seeding, etc.; Forklift Trucks; Grouting Machine; Hoists, Automatic; Hoists, All Elevators; Hoists, Tugger Single Drum; Jeep Diggers; Low Boys; Pipe Jacking Machines; Post-Hole Digger; Power Saw, Concrete Power Driven; Pug Mills; Rollers, other than Asphalt; Seed and Straw Blower; Steam Generators; Stump Machine; Winch Trucks with "A" Frame; Work Boats; Tamper-Form-Motor Driven.

Class 4. Air Compressor; Combination - Small Equipment Operator; Directional Boring Machine; Generators; Heaters, Mechanical; Hydraulic Power Unit (Pile Driving, Extracting, or Drilling); Light Plants, All (1 through 5); Pumps, over 3" (1 to 3 not to exceed a total of 300 ft.); Pumps, Well Points; Vacuum Trucks (excluding hose work); Welding Machines (2 through 5); Winches, 4 Small Electric Drill Winches.

Class 5. SkidSteer Loader (all); Brick Forklifts; Oilers.

Class 6. Field Mechanics and Field Welders

Class 7. Dowell Machine with Air Compressor; Gradall and machines of like nature.

#### OPERATING ENGINEER - FLOATING

Class 1. Craft Foreman; Master Mechanic; Diver/Wet Tender; Engineer; Engineer (Hydraulic Dredge).

Class 2. Crane/Backhoe Operator; Boat Operator with towing endorsement; Mechanic/Welder; Assistant Engineer (Hydraulic Dredge); Leverman (Hydraulic Dredge); Diver Tender.

Class 3. Deck Equipment Operator, Machineryman, Maintenance of Crane (over 50 ton capacity) or Backhoe (115,000 lbs. or more); Tug/Launch Operator; Loader/Dozer and like equipment on Barge, Breakwater Wall, Slip/Dock, or Scow, Deck Machinery, etc.

Class 4. Deck Equipment Operator, Machineryman/Fireman (4 Equipment Units or More); Off Road Trucks; Deck Hand, Tug Engineer, Crane Maintenance (50 Ton Capacity and Under) or Backhoe Weighing (115,000 pounds or less); Assistant Tug Operator.

Class 5. Friction or Lattice Boom Cranes.

Class 6. ROV Pilot, ROV Tender

#### TERRAZZO FINISHER

The handling of sand, cement, marble chips, and all other materials that may be used by the Mosaic Terrazzo Mechanic, and the mixing, grinding, grouting, cleaning and sealing of all Marble, Mosaic, and Terrazzo work, floors, base, stairs, and wainscoting by hand or machine, and in addition, assisting and aiding Marble, Masonic, and Terrazzo Mechanics.

#### TRAFFIC SAFETY Worker I

Traffic Safety Worker I - work associated with the delivery, installation, pick-up and servicing of safety devices during periods of roadway construction, including such work as set-up and maintenance of barricades, barrier wall reflectors, drums, cones, delineators, signs, crash attenuators, glare screen and other such items, and the layout and application or removal of conflicting and/or temporary roadway markings utilized to control traffic in construction zones, as well as flagging for these operations.

## TRAFFIC SAFETY WORKER II

Work associated with the installation and removal of permanent pavement markings and/or pavement markers including both installations performed by hand and installations performed by truck.

## TRUCK DRIVER - BUILDING, HEAVY AND HIGHWAY CONSTRUCTION - EAST & WEST

Class 1. Two or three Axle Trucks. A-frame Truck when used for transportation purposes; Air Compressors and Welding Machines, including those pulled by cars, pick-up trucks and tractors; Ambulances; Batch Gate Lockers; Batch Hopperman; Car and Truck Washers; Carry-alls; Fork Lifts and Hoisters; Helpers; Mechanics Helpers and Greasers; Oil Distributors 2-man operation; Pavement Breakers; Pole Trailer, up to 40 feet; Power Mower Tractors; Self-propelled Chip Spreader; Skipman; Slurry Trucks, 2-man operation; Slurry Truck Conveyor Operation, 2 or 3 man; Teamsters; Unskilled Dumpman; and Truck Drivers hauling warning lights, barricades, and portable toilets on the job site.

Class 2. Four axle trucks; Dump Crets and Adgetors under 7 yards; Dumpsters, Track Trucks, Euclids, Hug Bottom Dump Turnpulls or Turntrailers when pulling other than self-loading equipment or similar equipment under 16 cubic yards; Mixer Trucks under 7 yards; Ready-mix Plant Hopper Operator, and Winch Trucks, 2 Axles.

Class 3. Five axle trucks; Dump Crets and Adgetors 7 yards and over; Dumpsters, Track Trucks, Euclids, Hug Bottom Dump Turntrailers or turnpulls when pulling other than self-loading equipment or similar equipment over 16 cubic yards; Explosives and/or Fission Material Trucks; Mixer Trucks 7 yards or over; Mobile Cranes while in transit; Oil Distributors, 1-man operation; Pole Trailer, over 40 feet; Pole and Expandable Trailers hauling material over 50 feet long; Slurry trucks, 1-man operation; Winch trucks, 3 axles or more; Mechanic--Truck Welder and Truck Painter.

Class 4. Six axle trucks; Dual-purpose vehicles, such as mounted crane trucks with hoist and accessories; Foreman; Master Mechanic; Self-loading equipment like P.B. and trucks with scoops on the front.

### Other Classifications of Work:

For definitions of classifications not otherwise set out, the Department generally has on file such definitions which are available. If a task to be performed is not subject to one of the classifications of pay set out, the Department will upon being contacted state which neighboring county has such a classification and provide such rate, such rate being deemed to exist by reference in this document. If no neighboring county rate applies to the task, the Department shall undertake a special determination, such special determination being then deemed to have existed under this determination. If a project requires these, or any classification not listed, please contact IDOL at 217-782-1710 for wage rates or clarifications.

## LANDSCAPING

Landscaping work falls under the existing classifications for laborer, operating engineer and truck driver. The work performed by landscape plantsman and landscape laborer is covered by the existing classification of laborer. The work performed by landscape operators (regardless of equipment used or its size) is covered by the classifications of operating engineer. The work performed by landscape truck drivers (regardless of size of truck driven) is covered by the classifications of truck driver.

## MATERIAL TESTER & MATERIAL TESTER/INSPECTOR I AND II

Notwithstanding the difference in the classification title, the classification entitled "Material Tester I" involves the same job duties as the classification entitled "Material Tester/Inspector I". Likewise, the classification entitled "Material Tester II" involves the same job duties as the classification entitled "Material Tester/Inspector II".

## Lake County Prevailing Wage Rates posted on 1/18/2023

Trade Title	Rg	Type	C	Base	Foreman	Overtime					Pension	Vac	Trng	Other Ins
						M-F	Sa	Su	Hol	H/W				
ASBESTOS ABT-GEN	All	ALL		47.40	48.40	1.5	1.5	2.0	2.0	17.05	15.21	0.00	0.90	
ASBESTOS ABT-MEC	All	BLD		39.60	42.77	1.5	1.5	2.0	2.0	14.77	13.59	0.00	0.86	
BOILERMAKER	All	BLD		53.66	58.48	2.0	2.0	2.0	2.0	6.97	23.69	0.00	2.67	
BRICK MASON	All	BLD		49.81	54.79	1.5	1.5	2.0	2.0	12.10	21.56	0.00	1.10	
CARPENTER	All	ALL		52.01	54.01	1.5	1.5	2.0	2.0	11.79	24.76	1.50	0.80	
CEMENT MASON	All	ALL		48.00	50.00	2.0	1.5	2.0	2.0	11.65	28.36	0.00	0.55	
CERAMIC TILE FINISHER	All	BLD		44.18	44.18	1.5	1.5	2.0	2.0	12.25	14.77	0.00	1.00	
CERAMIC TILE LAYER	All	BLD		51.44	55.44	1.5	1.5	2.0	2.0	12.25	18.48	0.00	1.08	
COMMUNICATION TECHNICIAN	All	BLD		41.20	44.00	1.5	1.5	2.0	2.0	13.82	18.94	2.16	0.93	
ELECTRIC PWR EQMT OP	All	ALL		47.56	64.89	1.5	1.5	2.0	2.0	7.00	13.32	0.00	1.19	1.43
ELECTRIC PWR GRNDMAN	All	ALL		36.53	64.89	1.5	1.5	2.0	2.0	7.00	10.23	0.00	0.92	1.10
ELECTRIC PWR LINEMAN	All	ALL		57.17	64.89	1.5	1.5	2.0	2.0	7.00	16.01	0.00	1.43	1.72
ELECTRIC PWR TRK DRV	All	ALL		37.86	64.89	1.5	1.5	2.0	2.0	7.00	10.61	0.00	0.95	1.14
ELECTRICIAN	All	BLD		43.02	47.27	1.5	1.5	2.0	2.0	15.12	25.79	6.55	0.71	
ELEVATOR CONSTRUCTOR	All	BLD		62.47	70.28	2.0	2.0	2.0	2.0	16.03	20.21	5.00	0.65	
FENCE ERECTOR	All	ALL		46.89	48.89	1.5	1.5	2.0	2.0	13.68	17.42	0.00	0.75	
GLAZIER	All	BLD		48.75	50.25	1.5	2.0	2.0	2.0	15.19	24.43	0.00	1.70	
HEAT/FROST INSULATOR	All	BLD		52.80	55.97	1.5	1.5	2.0	2.0	14.77	16.76	0.00	0.86	
IRON WORKER	All	ALL		55.81	57.81	2.0	2.0	2.0	2.0	16.05	25.31	0.00	0.49	
LABORER	All	ALL		47.40	48.15	1.5	1.5	2.0	2.0	17.05	15.21	0.00	0.90	
LATHER	All	ALL		52.01	54.01	1.5	1.5	2.0	2.0	11.79	24.76	1.50	0.80	
MACHINIST	All	BLD		53.18	57.18	1.5	1.5	2.0	2.0	9.93	8.95	1.85	1.47	
MARBLE FINISHER	All	ALL		38.00	51.41	1.5	1.5	2.0	2.0	12.10	19.60	0.00	0.60	
MARBLE SETTER	All	BLD		48.96	53.86	1.5	1.5	2.0	2.0	12.10	21.03	0.00	0.78	
MATERIAL TESTER I	All	ALL		37.40		1.5	1.5	2.0	2.0	17.05	15.21	0.00	0.90	
MATERIALS TESTER II	All	ALL		42.40		1.5	1.5	2.0	2.0	17.05	15.21	0.00	0.90	
MILLWRIGHT	All	ALL		52.01	54.01	1.5	1.5	2.0	2.0	11.79	24.76	1.50	0.80	
OPERATING ENGINEER	All	BLD	1	55.10	59.10	2.0	2.0	2.0	2.0	22.15	19.30	2.00	2.55	
OPERATING ENGINEER	All	BLD	2	53.80	59.10	2.0	2.0	2.0	2.0	22.15	19.30	2.00	2.55	
OPERATING ENGINEER	All	BLD	3	51.25	59.10	2.0	2.0	2.0	2.0	22.15	19.30	2.00	2.55	
OPERATING ENGINEER	All	BLD	4	49.50	59.10	2.0	2.0	2.0	2.0	22.15	19.30	2.00	2.55	

OPERATING ENGINEER	All	BLD	5	58.85	59.10	2.0	2.0	2.0	2.0	22.15	19.30	2.00	2.55
OPERATING ENGINEER	All	BLD	6	56.10	59.10	2.0	2.0	2.0	2.0	22.15	19.30	2.00	2.55
OPERATING ENGINEER	All	BLD	7	58.10	59.10	2.0	2.0	2.0	2.0	22.15	19.30	2.00	2.55
OPERATING ENGINEER	All	FLT	1	61.10	61.10	1.5	1.5	2.0	2.0	21.40	18.60	2.00	2.40
OPERATING ENGINEER	All	FLT	2	59.60	61.10	1.5	1.5	2.0	2.0	21.40	18.60	2.00	2.40
OPERATING ENGINEER	All	FLT	3	58.10	61.10	1.5	1.5	2.0	2.0	21.40	18.60	2.00	2.40
OPERATING ENGINEER	All	FLT	4	53.60	61.10	1.5	1.5	2.0	2.0	21.40	18.60	2.00	2.40
OPERATING ENGINEER	All	FLT	5	62.60	61.10	1.5	1.5	2.0	2.0	21.40	18.60	2.00	2.40
OPERATING ENGINEER	All	FLT	6	41.00	61.10	1.5	1.5	2.0	2.0	21.40	18.60	2.00	2.40
OPERATING ENGINEER	All	HWY	1	53.30	57.30	1.5	1.5	2.0	2.0	22.15	19.30	2.00	2.55
OPERATING ENGINEER	All	HWY	2	52.75	57.30	1.5	1.5	2.0	2.0	22.15	19.30	2.00	2.55
OPERATING ENGINEER	All	HWY	3	50.70	57.30	1.5	1.5	2.0	2.0	22.15	19.30	2.00	2.55
OPERATING ENGINEER	All	HWY	4	49.30	57.30	1.5	1.5	2.0	2.0	22.15	19.30	2.00	2.55
OPERATING ENGINEER	All	HWY	5	48.10	57.30	1.5	1.5	2.0	2.0	22.15	19.30	2.00	2.55
OPERATING ENGINEER	All	HWY	6	56.30	57.30	1.5	1.5	2.0	2.0	22.15	19.30	2.00	2.55
OPERATING ENGINEER	All	HWY	7	54.30	57.30	1.5	1.5	2.0	2.0	22.15	19.30	2.00	2.55
ORNAMENTAL IRON WORKER	All	ALL		53.32	55.82	2.0	2.0	2.0	2.0	14.23	25.00	0.00	1.75
PAINTER	All	ALL		50.30	56.59	1.5	1.5	1.5	2.0	14.26	14.99	0.00	1.72
PAINTER - SIGNS	All	BLD		41.55	46.67	1.5	1.5	2.0	2.0	3.04	3.90	0.00	0.00
PILEDRIVER	All	ALL		52.01	54.01	1.5	1.5	2.0	2.0	11.79	24.76	1.50	0.80
PIPEFITTER	All	BLD		53.00	56.00	1.5	1.5	2.0	2.0	11.85	22.85	0.00	2.92
PLASTERER	All	BLD		48.65	51.57	2.0	1.5	2.0	2.0	11.65	28.21	0.00	0.55
PLUMBER	All	BLD		54.80	58.10	1.5	1.5	2.0	2.0	16.70	17.04	0.00	1.58
ROOFER	All	BLD		48.00	53.00	1.5	1.5	2.0	2.0	11.83	15.26	0.00	0.99
SHEETMETAL WORKER	All	BLD		49.10	53.03	1.5	1.5	2.0	2.0	13.53	28.20	0.00	1.00
SIGN HANGER	All	BLD		34.72	37.50	1.5	1.5	2.0	2.0	6.85	4.50	0.00	0.00
SPRINKLER FITTER	All	BLD		54.55	57.30	1.5	1.5	2.0	2.0	14.20	18.70	0.00	0.75
STEEL ERECTOR	All	ALL		55.81	57.81	2.0	2.0	2.0	2.0	16.05	25.31	0.00	0.49
STONE MASON	All	BLD		49.81	54.79	1.5	1.5	2.0	2.0	12.10	21.56	0.00	1.10
TERRAZZO FINISHER	All	BLD		45.57	45.57	1.5	1.5	2.0	2.0	12.25	17.14	0.00	1.03
TERRAZZO MECHANIC	All	BLD		49.41	52.91	1.5	1.5	2.0	2.0	12.25	18.60	0.00	1.07
TRAFFIC SAFETY WORKER I	All	HWY		39.30	40.90	1.5	1.5	2.0	2.0	9.65	9.10	0.00	0.10
TRAFFIC SAFETY WORKER II	All	HWY		40.30	41.90	1.5	1.5	2.0	2.0	9.65	9.10	0.00	0.10
TRUCK DRIVER	All	ALL	1	42.09	42.64	1.5	1.5	2.0	2.0	11.80	11.75	0.00	0.15
TRUCK DRIVER	All	ALL	2	42.24	42.64	1.5	1.5	2.0	2.0	11.80	11.75	0.00	0.15
TRUCK DRIVER	All	ALL	3	42.44	42.64	1.5	1.5	2.0	2.0	11.80	11.75	0.00	0.15

TRUCK DRIVER	All	ALL	4	42.64	42.64	1.5	1.5	2.0	2.0	11.80	11.75	0.00	0.15
TUCKPOINTER	All	BLD		49.53	50.53	1.5	1.5	2.0	2.0	9.04	21.06	0.00	1.07

**Legend**

**Rg** Region

**Type** Trade Type - All,Highway,Building,Floating,Oil & Chip,Rivers

**C** Class

**Base** Base Wage Rate

**OT M-F** Unless otherwise noted, OT pay is required for any hour greater than 8 worked each day, Mon through Fri. The number listed is the multiple of the base wage.

**OT Sa** Overtime pay required for every hour worked on Saturdays

**OT Su** Overtime pay required for every hour worked on Sundays

**OT Hol** Overtime pay required for every hour worked on Holidays

**H/W** Health/Welfare benefit

**Vac** Vacation

**Trng** Training

**Other Ins** Employer hourly cost for any other type(s) of insurance provided for benefit of worker.

Explanations LAKE COUNTY

The following list is considered as those days for which holiday rates of wages for work performed apply: New Years Day, Memorial Day, Fourth of July, Labor Day, Thanksgiving Day, Christmas Day and Veterans Day in some classifications/counties. Generally, any of these holidays which fall on a Sunday is celebrated on the following Monday. This then makes work performed on that Monday payable at the appropriate overtime rate for holiday pay. Common practice in a given local may alter certain days of celebration. If in doubt, please check with IDOL.

EXPLANATION OF CLASSES

ASBESTOS - GENERAL - removal of asbestos material/mold and hazardous materials from any place in a building, including mechanical systems where those mechanical systems are to be removed. This includes the removal of asbestos materials/mold and hazardous materials from ductwork or pipes in a building when the building is to be demolished at the time or at some close future date.

ASBESTOS - MECHANICAL - removal of asbestos material from mechanical systems, such as pipes, ducts, and boilers, where the mechanical systems are to remain.

CERAMIC TILE FINISHER

The grouting, cleaning, and polishing of all classes of tile, whether for interior or exterior purposes, all burned, glazed or unglazed products; all composition materials, granite tiles, warning detectable tiles, cement tiles, epoxy composite materials, pavers, glass, mosaics, fiberglass, and all substitute materials, for tile made in tile-like units; all mixtures in tile like form of cement, metals, and other materials that are for and intended for use as a finished floor surface, stair treads, promenade roofs, walks, walls, ceilings, swimming pools, and all other places where tile is to form a finished interior or exterior. The mixing of all setting mortars including but not limited to thin-set mortars, epoxies, wall mud, and any other sand and cement mixtures or adhesives when used in the preparation, installation, repair, or maintenance of tile and/or similar materials. The handling and unloading of all sand, cement, lime, tile, fixtures, equipment, adhesives, or any other materials to be used in the preparation, installation, repair, or maintenance of tile and/or similar materials. Ceramic Tile Finishers shall fill all joints and voids regardless of method on all tile work, particularly and especially after installation of said tile work. Application of any and all protective coverings to all types of

tile installations including, but not be limited to, all soap compounds, paper products, tapes, and all polyethylene coverings, plywood, masonite, cardboard, and any new type of products that may be used to protect tile installations, Blastrac equipment, and all floor scarifying equipment used in preparing floors to receive tile. The clean up and removal of all waste and materials. All demolition of existing tile floors and walls to be re-tiled.

#### COMMUNICATION TECHNICIAN

Low voltage construction, installation, maintenance and removal of telecommunication facilities (voice, sound, data and video) including outside plant, telephone, security systems and data inside wire, interconnect, terminal equipment, central offices, PABX, fiber optic cable and equipment, micro waves, V-SAT, bypass, CATV, WAN (wide area network), LAN (local area networks), and ISDN (integrated system digital network), pulling of wire in raceways, but not the installation of raceways.

#### MARBLE FINISHER

Loading and unloading trucks, distribution of all materials (all stone, sand, etc.), stocking of floors with material, performing all rigging for heavy work, the handling of all material that may be needed for the installation of such materials, building of scaffolding, polishing if needed, patching, waxing of material if damaged, pointing up, caulking, grouting and cleaning of marble, holding water on diamond or Carborundum blade or saw for setters cutting, use of tub saw or any other saw needed for preparation of material, drilling of holes for wires that anchor material set by setters, mixing up of molding plaster for installation of material, mixing up thin set for the installation of material, mixing up of sand to cement for the installation of material and such other work as may be required in helping a Marble Setter in the handling of all material in the erection or installation of interior marble, slate, travertine, art marble, serpentine, alberene stone, blue stone, granite and other stones (meaning as to stone any foreign or domestic materials as are specified and used in building interiors and exteriors and customarily known as stone in the trade), carrara, sanionyx, vitrolite and similar opaque glass and the laying of all marble tile, terrazzo tile, slate tile and precast tile, steps, risers treads, base, or any other materials that may be used as substitutes for any of the aforementioned materials and which are used on interior and exterior which are installed in a similar manner.

**MATERIAL TESTER I:** Hand coring and drilling for testing of materials; field inspection of uncured concrete and asphalt.

**MATERIAL TESTER II:** Field inspection of welds, structural steel, fireproofing, masonry, soil, facade, reinforcing steel, formwork, cured concrete, and concrete and asphalt batch plants; adjusting proportions of bituminous mixtures.

#### OPERATING ENGINEER - BUILDING

Class 1. Asphalt Plant; Asphalt Spreader; Autograde; Backhoes with Caisson Attachment; Batch Plant; Benoto (requires Two Engineers); Boiler and Throttle Valve; Caisson Rigs; Central Redi-Mix Plant; Combination Back Hoe Front End-loader Machine; Compressor and Throttle Valve; Concrete Breaker (Truck Mounted); Concrete Conveyor; Concrete Conveyor (Truck Mounted); Concrete Paver Over 27E cu. ft; Concrete Paver 27E cu. ft. and Under: Concrete Placer; Concrete Placing Boom; Concrete Pump (Truck Mounted); Concrete Tower; Cranes, All; Cranes, Hammerhead; Cranes, (GCI and similar Type); Creter Crane; Spider Crane; Crusher, Stone, etc.; Derricks, All; Derricks, Traveling; Formless Curb and Gutter Machine; Grader, Elevating; Grouting Machines; Heavy Duty Self-Propelled Transporter or Prime Mover; Highlift Shovels or Front Endloader 2-1/4 yd. and over; Hoists, Elevators, outside type rack and pinion and similar machines; Hoists, One, Two and Three Drum; Hoists, Two Tugger One Floor; Hydraulic Backhoes; Hydraulic Boom Trucks; Hydro Vac (and similar equipment); Locomotives, All; Motor Patrol; Lubrication Technician; Manipulators; Pile Drivers and Skid Rig; Post Hole Digger; Pre-Stress Machine; Pump Cretes Dual Ram; Pump Cretes: Squeeze Cretes-Screw Type Pumps; Gypsum Bulker and Pump; Raised and Blind Hole Drill; Roto Mill Grinder; Scoops - Tractor Drawn; Slip-Form Paver; Straddle Buggies; Operation of Tie Back Machine; Tournapull; Tractor with Boom and Side Boom; Trenching Machines.

Class 2. Boilers; Broom, All Power Propelled; Bulldozers; Concrete Mixer (Two Bag and Over); Conveyor, Portable; Forklift Trucks; Highlift Shovels or Front Endloaders under 2-1/4 yd.; Hoists, Automatic; Hoists, Inside Elevators; Hoists, Sewer Dragging Machine;



Hoists, Tugger Single Drum; Laser Screed; Rock Drill (Self-Propelled); Rock Drill (Truck Mounted); Rollers, All; Steam Generators; Tractors, All; Tractor Drawn Vibratory Roller; Winch Trucks with "A" Frame.

Class 3. Air Compressor; Combination Small Equipment Operator; Generators; Heaters, Mechanical; Hoists, Inside Elevators (remodeling or renovation work); Hydraulic Power Units (Pile Driving, Extracting, and Drilling); Pumps, over 3" (1 to 3 not to exceed a total of 300 ft.); Low Boys; Pumps, Well Points; Welding Machines (2 through 5); Winches, 4 Small Electric Drill Winches.

Class 4. Bobcats and/or other Skid Steer Loaders; Oilers; and Brick Forklift.

Class 5. Assistant Craft Foreman.

Class 6. Gradall.

Class 7. Mechanics; Welders.

#### OPERATING ENGINEERS - HIGHWAY CONSTRUCTION

Class 1. Asphalt Plant; Asphalt Heater and Planer Combination; Asphalt Heater Scarfire; Asphalt Spreader; Autograder/GOMACO or other similar type machines; ABG Paver; Backhoes with Caisson Attachment; Ballast Regulator; Belt Loader; Caisson Rigs; Car Dumper; Central Redi-Mix Plant; Combination Backhoe Front Endloader Machine, (1 cu. yd. Backhoe Bucket or over or with attachments); Concrete Breaker (Truck Mounted); Concrete Conveyor; Concrete Paver over 27E cu. ft.; Concrete Placer; Concrete Tube Float; Cranes, all attachments; Cranes, Tower Cranes of all types: Creter Crane; Spider Crane; Crusher, Stone, etc.; Derricks, All; Derrick Boats; Derricks, Traveling; Dredges; Elevators, Outside type Rack & Pinion and Similar Machines; Formless Curb and Gutter Machine; Grader, Elevating; Grader, Motor Grader, Motor Patrol, Auto Patrol, Form Grader, Pull Grader, Subgrader; Guard Rail Post Driver Truck Mounted; Hoists, One, Two and Three Drum; Heavy Duty Self-Propelled Transporter or Prime Mover; Hydraulic Backhoes; Backhoes with shear attachments up to 40' of boom reach; Lubrication Technician; Manipulators; Mucking Machine; Pile Drivers and Skid Rig; Pre-Stress Machine; Pump Cretes Dual Ram; Rock Drill - Crawler or Skid Rig; Rock Drill - Truck Mounted; Rock/Track Tamper; Roto Mill Grinder; Slip-Form Paver; Snow Melters; Soil Test Drill Rig (Truck Mounted); Straddle Buggies; Hydraulic Telescoping Form (Tunnel); Operation of Tieback Machine; Tractor Drawn Belt Loader; Tractor Drawn Belt Loader (with attached pusher - two engineers); Tractor with Boom; Tractaire with Attachments; Traffic Barrier Transfer Machine; Trenching; Truck Mounted Concrete Pump with Boom; Raised or Blind Hole Drills (Tunnel Shaft); Underground Boring and/or Mining Machines 5 ft. in diameter and over tunnel, etc; Underground Boring and/or Mining Machines under 5 ft. in diameter; Wheel Excavator; Widener (APSCO).

Class 2. Batch Plant; Bituminous Mixer; Boiler and Throttle Valve; Bulldozers; Car Loader Trailing Conveyors; Combination Backhoe Front Endloader Machine (Less than 1 cu. yd. Backhoe Bucket or over or with attachments); Compressor and Throttle Valve; Compressor, Common Receiver (3); Concrete Breaker or Hydro Hammer; Concrete Grinding Machine; Concrete Mixer or Paver 7S Series to and including 27 cu. ft.; Concrete Spreader; Concrete Curing Machine, Burlap Machine, Belting Machine and Sealing Machine; Concrete Wheel Saw; Conveyor Muck Cars (Haglund or Similar Type); Drills, All; Finishing Machine - Concrete; Highlift Shovels or Front Endloader; Hoist - Sewer Dragging Machine; Hydraulic Boom Trucks (All Attachments); Hydro-Blaster; Hydro Excavating (excluding hose work); Laser Screed; All Locomotives, Dinky; Off-Road Hauling Units (including articulating) Non Self-Loading Ejection Dump; Pump Cretes: Squeeze Cretes - Screw Type Pumps, Gypsum Bulker and Pump; Roller, Asphalt; Rotary Snow Plows; Rototiller, Seaman, etc., self-propelled; Self-Propelled Compactor; Spreader - Chip - Stone, etc.; Scraper - Single/Twin Engine/Push and Pull; Scraper - Prime Mover in Tandem (Regardless of Size); Tractors pulling attachments, Sheeps Foot, Disc, Compactor, etc.; Tug Boats.

Class 3. Boilers; Brooms, All Power Propelled; Cement Supply Tender; Compressor, Common Receiver (2); Concrete Mixer (Two Bag and Over); Conveyor, Portable; Farm-Type Tractors Used for Mowing, Seeding, etc.; Forklift Trucks; Grouting Machine; Hoists, Automatic; Hoists, All Elevators; Hoists, Tugger Single Drum; Jeep Diggers; Low Boys; Pipe Jacking Machines; Post-Hole Digger; Power Saw, Concrete Power Driven; Pug Mills; Rollers, other than Asphalt; Seed and Straw Blower; Steam Generators; Stump

Machine; Winch Trucks with "A" Frame; Work Boats; Tamper-Form-Motor Driven.

Class 4. Air Compressor; Combination - Small Equipment Operator; Directional Boring Machine; Generators; Heaters, Mechanical; Hydraulic Power Unit (Pile Driving, Extracting, or Drilling); Light Plants, All (1 through 5); Pumps, over 3" (1 to 3 not to exceed a total of 300 ft.); Pumps, Well Points; Vacuum Trucks (excluding hose work); Welding Machines (2 through 5); Winches, 4 Small Electric Drill Winches.

Class 5. SkidSteer Loader (all); Brick Forklifts; Oilers.

Class 6. Field Mechanics and Field Welders

Class 7. Dowell Machine with Air Compressor; Gradall and machines of like nature.

#### OPERATING ENGINEER - FLOATING

Class 1. Craft Foreman; Master Mechanic; Diver/Wet Tender; Engineer; Engineer (Hydraulic Dredge).

Class 2. Crane/Backhoe Operator; Boat Operator with towing endorsement; Mechanic/Welder; Assistant Engineer (Hydraulic Dredge); Leverman (Hydraulic Dredge); Diver Tender.

Class 3. Deck Equipment Operator, Machineryman, Maintenance of Crane (over 50 ton capacity) or Backhoe (115,000 lbs. or more); Tug/Launch Operator; Loader/Dozer and like equipment on Barge, Breakwater Wall, Slip/Dock, or Scow, Deck Machinery, etc.

Class 4. Deck Equipment Operator, Machineryman/Fireman (4 Equipment Units or More); Off Road Trucks; Deck Hand, Tug Engineer, Crane Maintenance (50 Ton Capacity and Under) or Backhoe Weighing (115,000 pounds or less); Assistant Tug Operator.

Class 5. Friction or Lattice Boom Cranes.

Class 6. ROV Pilot, ROV Tender

#### TRAFFIC SAFETY Worker I

Traffic Safety Worker I - work associated with the delivery, installation, pick-up and servicing of safety devices during periods of roadway construction, including such work as set-up and maintenance of barricades, barrier wall reflectors, drums, cones, delineators, signs, crash attenuators, glare screen and other such items, and the layout and application or removal of conflicting and/or temporary roadway markings utilized to control traffic in construction zones, as well as flagging for these operations.

#### TRAFFIC SAFETY WORKER II

Work associated with the installation and removal of permanent pavement markings and/or pavement markers including both installations performed by hand and installations performed by truck.

#### TRUCK DRIVER - BUILDING, HEAVY AND HIGHWAY CONSTRUCTION

Class 1. Two or three Axle Trucks. A-frame Truck when used for transportation purposes; Air Compressors and Welding Machines, including those pulled by cars, pick-up trucks and tractors; Ambulances; Batch Gate Lockers; Batch Hopperman; Car and Truck Washers; Carry-alls; Fork Lifts and Hoisters; Helpers; Mechanics Helpers and Greasers; Oil Distributors 2-man operation; Pavement Breakers; Pole Trailer, up to 40 feet; Power Mower Tractors; Self-propelled Chip Spreader; Skipman; Slurry Trucks, 2-man operation; Slurry Truck Conveyor Operation, 2 or 3 man; Teamsters; Unskilled Dumpman; and Truck Drivers hauling warning lights, barricades, and portable toilets on the job site.

Class 2. Four axle trucks; Dump Crets and Adgetors under 7 yards; Dumpsters, Track Trucks, Euclids, Hug Bottom Dump Turnapulls or Turntrailers when pulling other than self-loading equipment or similar equipment under 16 cubic yards; Mixer Trucks under 7 yards; Ready-mix Plant Hopper Operator, and Winch Trucks, 2 Axles.

Class 3. Five axle trucks; Dump Crets and Adgetors 7 yards and over; Dumpsters, Track Trucks, Euclids, Hug Bottom Dump Turntrailers or turnapulls when pulling other than self-loading equipment or similar equipment over 16 cubic yards; Explosives and/or Fission Material Trucks; Mixer Trucks 7 yards or over; Mobile Cranes while in transit; Oil Distributors, 1-man operation; Pole Trailer, over 40 feet; Pole and Expandable Trailers hauling material over 50 feet long; Slurry trucks, 1-man operation; Winch trucks, 3 axles or more; Mechanic--Truck Welder and Truck Painter.

Class 4. Six axle trucks; Dual-purpose vehicles, such as mounted crane trucks with hoist and accessories; Foreman; Master Mechanic; Self-loading equipment like P.B. and trucks with scoops on the front.

#### TERRAZZO FINISHER

The handling of sand, cement, marble chips, and all other materials that may be used by the Mosaic Terrazzo Mechanic, and the mixing, grinding, grouting, cleaning and sealing of all Marble, Mosaic, and Terrazzo work, floors, base, stairs, and wainscoting by hand or machine, and in addition, assisting and aiding Marble, Masonic, and Terrazzo Mechanics.

#### Other Classifications of Work:

For definitions of classifications not otherwise set out, the Department generally has on file such definitions which are available. If a task to be performed is not subject to one of the classifications of pay set out, the Department will upon being contacted state which neighboring county has such a classification and provide such rate, such rate being deemed to exist by reference in this document. If no neighboring county rate applies to the task, the Department shall undertake a special determination, such special determination being then deemed to have existed under this determination. If a project requires these, or any classification not listed, please contact IDOL at 217-782-1710 for wage rates or clarifications.

#### LANDSCAPING

Landscaping work falls under the existing classifications for laborer, operating engineer and truck driver. The work performed by landscape plantsman and landscape laborer is covered by the existing classification of laborer. The work performed by landscape operators (regardless of equipment used or its size) is covered by the classifications of operating engineer. The work performed by landscape truck drivers (regardless of size of truck driven) is covered by the classifications of truck driver.

#### MATERIAL TESTER & MATERIAL TESTER/INSPECTOR I AND II

Notwithstanding the difference in the classification title, the classification entitled "Material Tester I" involves the same job duties as the classification entitled "Material Tester/Inspector I". Likewise, the classification entitled "Material Tester II" involves the same job duties as the classification entitled "Material Tester/Inspector II".

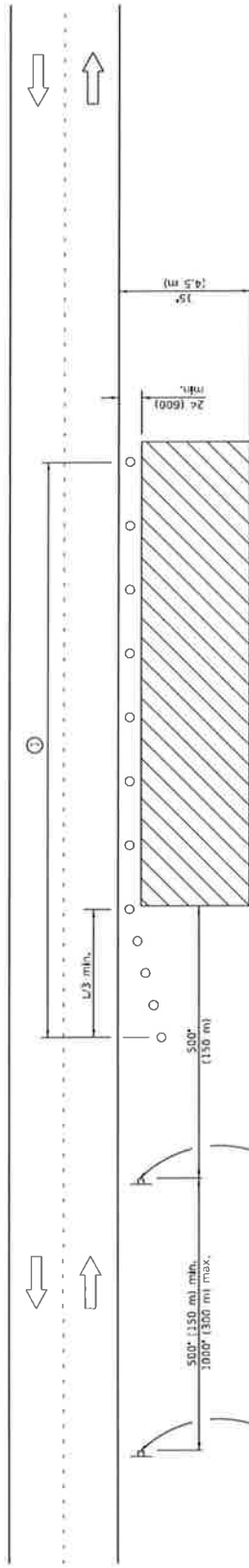

For contract construction projects

W20-1103)(0)-46

For maintenance and utility projects

W20-1101)-48

W21-1101)-48

① When the work operation exceeds one hour, cones, drums or barricades shall be placed at 25' (8 m) centers for L/3 distance, and all 50' (15 m) centers through the remainder of the work area.

**TYPICAL APPLICATIONS**

- Utility operations
- Culvert extensions
- Side slope changes
- Guardrail installation and maintenance
- Delimeter installation
- Landscaping operations
- Shoulder repair
- Sign installation and maintenance

**SYMBOLS**

- Work area
- Sign
- Cone, drum or barricade

**GENERAL NOTES**

This Standard is used where any vehicles, equipment, workers or their activities will encroach the area at 15' (4.5 m) to 24' (800) from the edge of pavement.

Calculate L as follows:

SPEED LIMIT

40 mph (70 km/h) or less:

45 mph (80 km/h) or greater:

W = Width of offset in feet (meters).

S = Normal posted speed mph (km/h).

All dimensions are in inches (millimeters) unless otherwise shown.

**FORMULAS**

English (Metric)

L = WS' / 60

L = (W)(S) / 0.65

**OFF-RD OPERATIONS, 2L, 2W, 15' (4.5 m) TO 24" (600 mm) FROM PAVEMENT EDGE**

STANDARD 70-1006-05

DATE	REVISIONS
1-1-14	Revised workers sign number to agree with current MUTCD.
1-1-13	Omitted text "WORKERS" sign.

Illinois Department of Transportation

ISSUED 1-1-14

APPROVED BY: [Signature]

APPROVED BY: [Signature]

DATE: 1-1-14

DATE: 1-1-14

ILLINOIS DEPARTMENT OF TRANSPORTATION



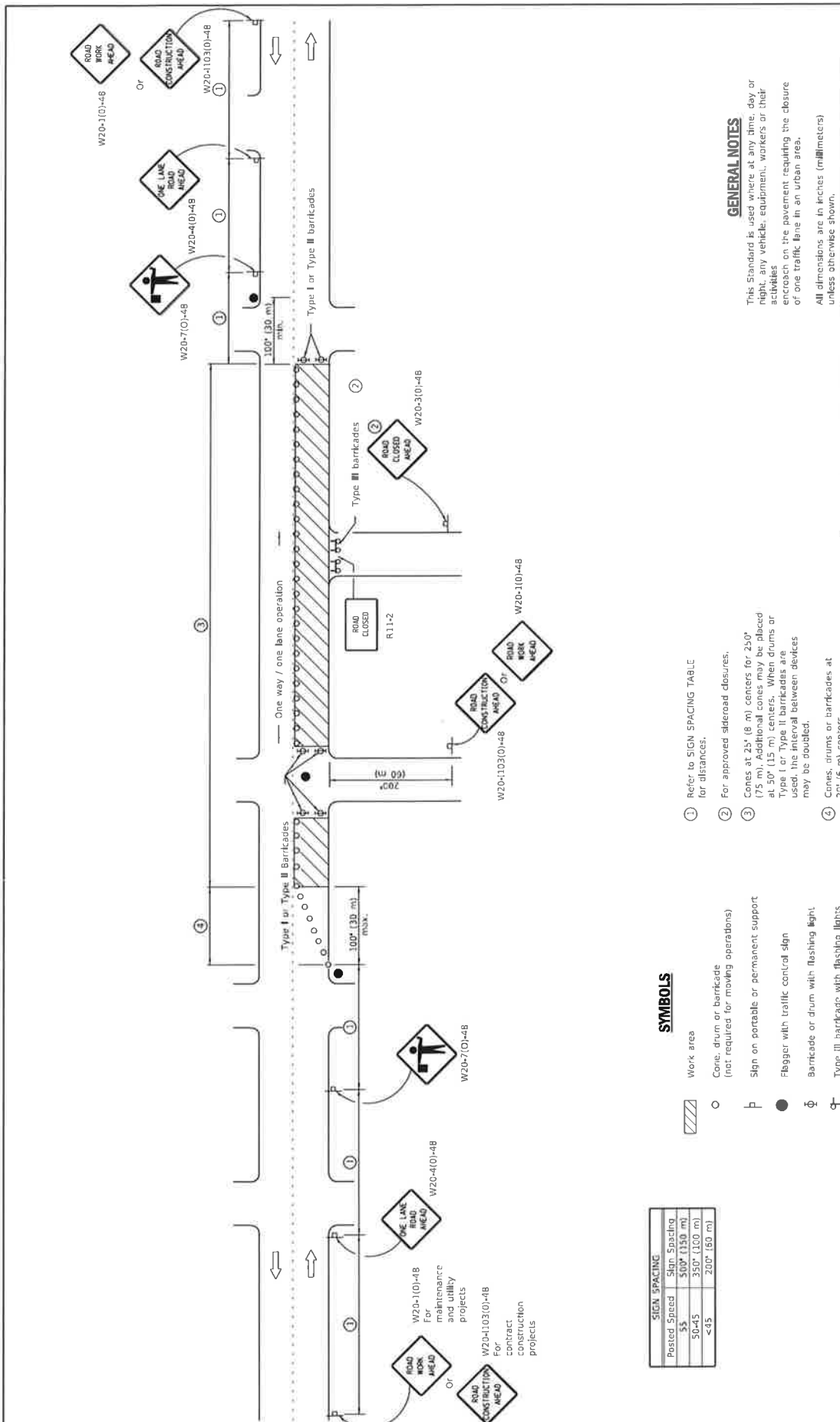

**GENERAL NOTES**

This Standard is used where, at any time, day or night, any vehicle, equipment, workers or their activities encroach on the pavement requiring the closure of one traffic lane in an urban area.

All dimensions are in inches (millimeters) unless otherwise shown.

① Refer to SIGN SPACING TABLE for distances.

② For approved sideroad closures.

③ Cones at 25' (8 m) centers for 250' (75 m). Additional cones may be placed at 50' (15 m) centers. When drums or Type I or Type II barricades are used, the interval between devices may be doubled.

④ Cones, drums or barricades at 20' (6 m) centers.

**SYMBOLS**

- Work area
- Cones, drum or barricade (not required for moving operations)
- Sign on portable or permanent support
- Flagger with traffic control sign
- Barricade or drum with flashing light
- Type III barricade with flashing lights

Posted Speed	Sign Spacing
55	500' (150 m)
50-45	350' (100 m)
<45	200' (60 m)

W20-1(0)-48 For maintenance and utility projects

W20-4(0)-48

W20-1(0)-48 For contact construction projects

W20-103(0)-48

W20-7(0)-48

W20-103(0)-48

DATE	REVISIONS
1-1-11	Revised flagger sign.
1-1-09	Switched units to English (metric).
	Corrected sign No.'s.

**URBAN LANE CLOSURE,  
2L, 2W, UNDIVIDED**

**STANDARD 701501-06**

Illinois Department of Transportation

ISSUED 11-1-11

APPROVED

REGISTERED PROFESSIONAL ENGINEER

REGISTERED PROFESSIONAL ENGINEER

REGISTERED PROFESSIONAL ENGINEER

REGISTERED PROFESSIONAL ENGINEER

① Omit whenever duplicated by road work traffic control.

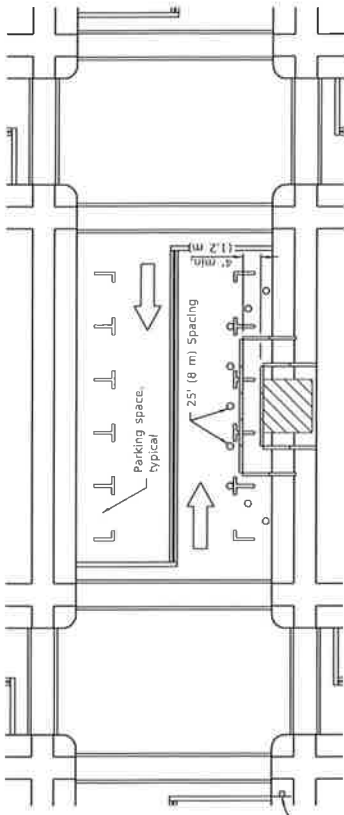

W20-1103(0)-48 for contract construction projects



or

W20-1101-48 for maintenance and utility projects



### SIDEWALK DIVERSION

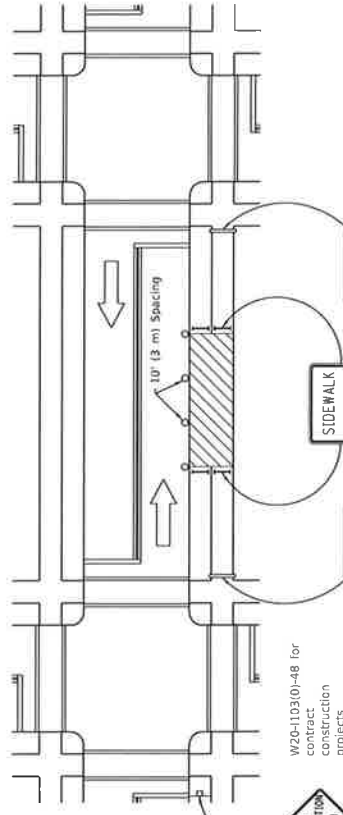

W20-1103(0)-48 for contract construction projects









or

W20-1101-48 for maintenance and utility projects



### SIDEWALK CLOSURE

### SYMBOLS

-  Work area
-  Sign on portable or permanent support
-  Barricade or drum
-  Cone, drum or barricade
-  Type III barricade
-  Detectable pedestrian channeling barricade

### GENERAL NOTES

This Standard is used where, at any time, pedestrian traffic must be rerouted due to work being performed.

This Standard must be used in conjunction with other Traffic Control & Protection Standards when roadway traffic is affected.

Temporary facilities shall be detectable and accessible.

The temporary pedestrian facilities shall be provided on the same side of the closed facilities whenever possible.

The SIDEWALK CLOSED / USE OTHER SIDE sign shall be placed at the nearest crosswalk or intersection to the closed sidewalk. The signs shall be erected on the corners across the street from the closure. The SIDEWALK CLOSED signs shall be used at the ends of the actual closures.

Type III barricades and R11-2-4830 signs shall be positioned as shown in "ROAD CLOSED TO ALL TRAFFIC" detail on Standard 701901.

All dimensions are in inches (millimeters) unless otherwise shown.

DATE	REVISIONS
4-1-16	Omitted orange safety fence from standard as this is covered in the sig. spec.
1-1-12	Added SIDEWALK DIVERSION. Modified appearance of plan views. Retained Sig.

## SIDEWALK, CORNER OR CROSSWALK CLOSURE

(Sheet 1 of 2)

STANDARD 701801-06

Illinois Department of Transportation  
 ISSUED 1-1-97  
 2/16  
 ENGINEER OF SAFETY ENGINEERING  
 APPROVED  
 REGISTERED PROFESSIONAL ENGINEER  
 REGISTERED PROFESSIONAL ENGINEER

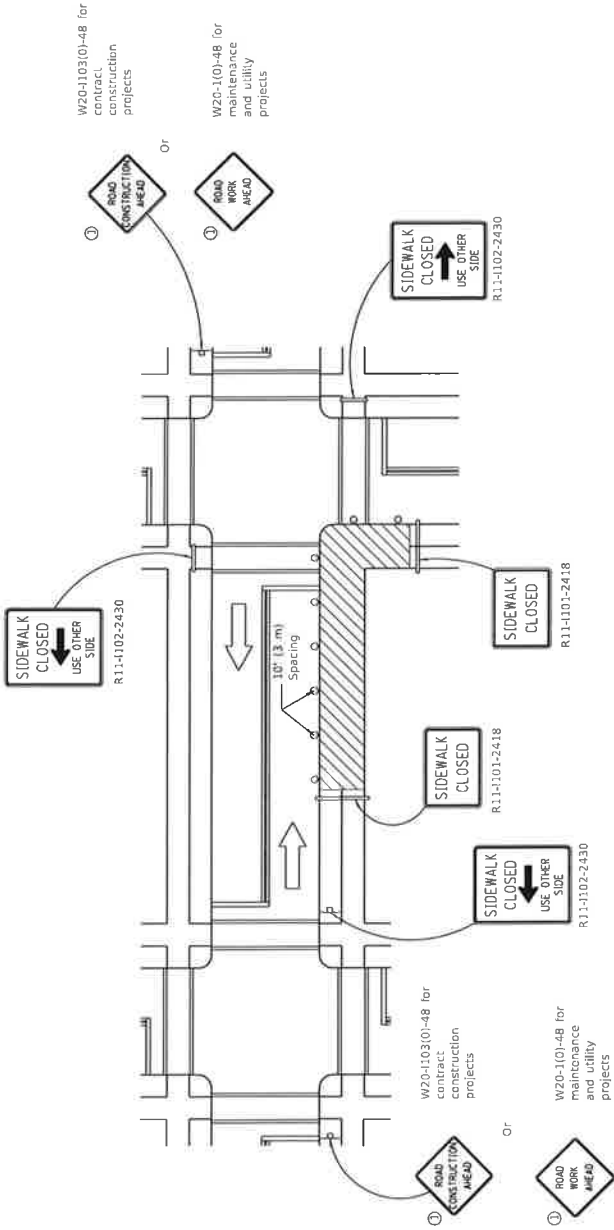

**CORNER CLOSURE**

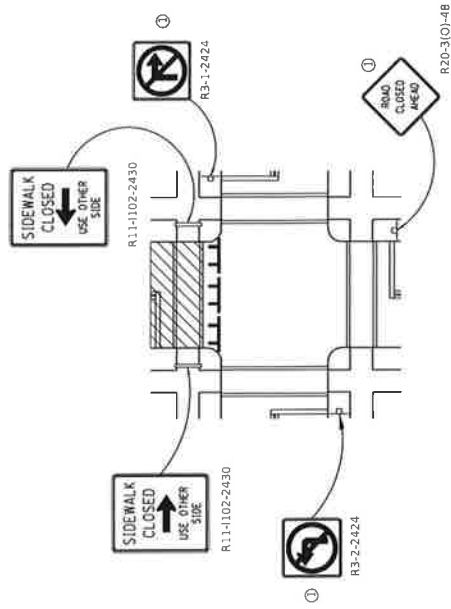

**CROSSWALK CLOSURE**

**SIDEWALK, CORNER OR CROSSWALK CLOSURE**

(Sheet 2 of 2)

**STANDARD 701801-06**

Illinois Department of Transportation

MSK/BL 2/15

APPROVED

ENGINEER OF SAFETY ENGINEERING

APPROVED

PROJECT OF INTEREST EXPERIMENTAL

WSPD 11-157



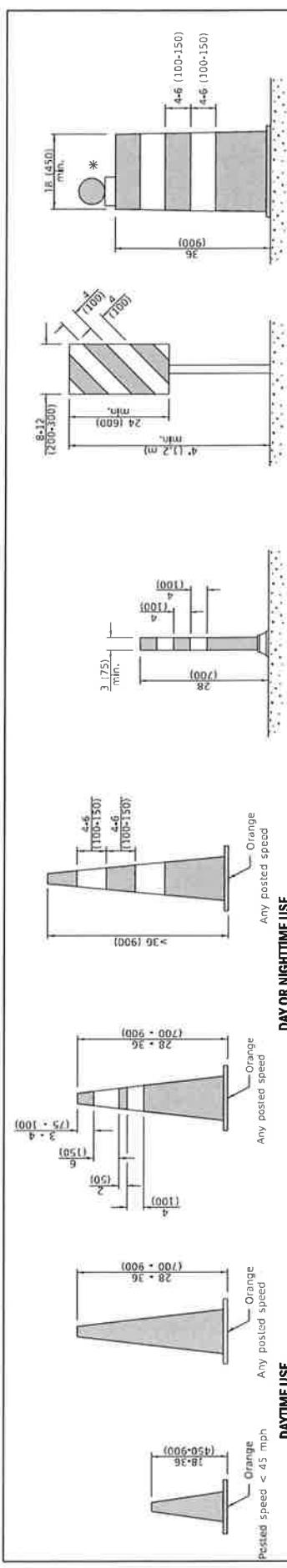

**CONES**  
**DAYTIME USE** Orange Posted speed < 45 mph  
**DAY OR NIGHTTIME USE** Orange Any posted speed

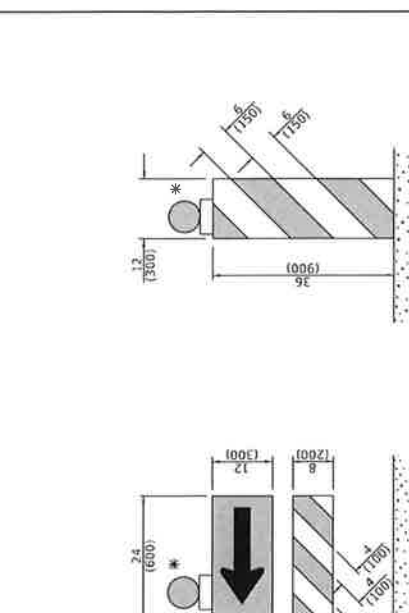

**TUBULAR MARKER**  
**VERTICAL PANEL**  
 POST MOUNTED

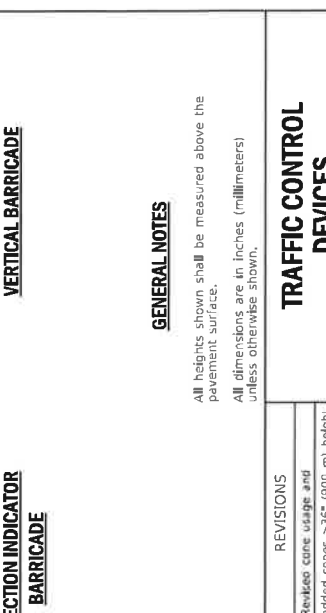

**TYPE I BARRICADE**  
**TYPE II BARRICADE**  
**TYPE III BARRICADE**

\* Warning Lights (if required)



**VERTICAL BARRICADE**  
**DIRECTION INDICATOR BARRICADE**



**DRUM**

**GENERAL NOTES**

All heights shown shall be measured above the pavement surface.  
 All dimensions are in inches (millimeters) unless otherwise shown.

DATE	REVISIONS
1-1-19	Revised cone usage and added cones >36" (900 mm) height.
1-1-18	Revised END WORK ZONE SPEED LIMIT sign from orange to white background.

**TRAFFIC CONTROL DEVICES**

STANDARD 701901-08  
 (Sheet 1 of 3)

**DETECTABLE PEDESTRIAN CHANNELIZING BARRICADE**



**DETECTABLE PEDESTRIAN CHANNELIZING BARRICADE**

Illinois Department of Transportation

APPROVED: [Signature] 2019  
 ENGINEER OF SAFETY PROC. AND ENGINEERING

APPROVED: [Signature] 2019  
 ENGINEER OF DESIGN AND CONSTRUCTION

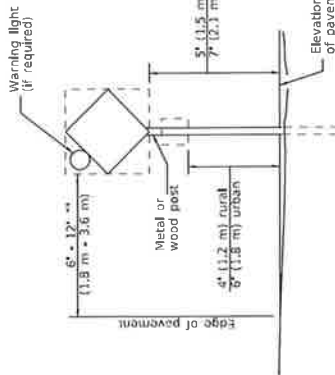

5" (1.3 m) min. embedment.

**POST MOUNTED SIGNS**

\*\* When curb or paved shoulder are present this dimension shall be 24 (600) to the face of curb or 6' (1.8 m) to the outside edge of the paved shoulder.

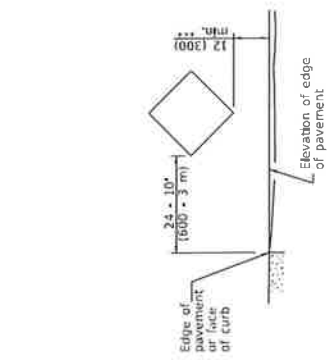

**SIGNS ON TEMPORARY SUPPORTS**

\*\*\* When work operations exceed four days, this dimension shall be 5' (1.5 m) min. If focused light shall be sufficient to be seen completely above the devices.

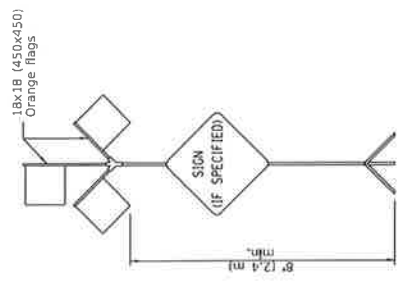

**HIGH LEVEL WARNING DEVICE**

ROAD CONSTRUCTION NEXT X MILES G20-1104(0)-6036

END CONSTRUCTION G20-1105(0)-6024

This signing is required for all projects 2 miles (3200 m) or more in length. ROAD CONSTRUCTION NEXT X MILES sign shall be placed 500' (150 m) in advance of project limits. END CONSTRUCTION sign shall be erected at the end of the job within another job is within 2 miles (3200 m). Dual sign displays shall be utilized on multi-lane highways.

**WORK LIMIT SIGNING**

WORK ZONE SPEED LIMIT	W21-1115(0)-3618
XX	R2-1-3648
PHOTO ENFORCED	R10-1108p-3618 ****
XXXX FINE MINIMUM	R2-1106p-3618
END WORK ZONE SPEED LIMIT	G20-1103-6036

Sign assembly as shown on Standards or as allowed by District Operations.

This sign shall be used when the above sign assembly is used.

**HIGHWAY CONSTRUCTION SPEED ZONE SIGNS**

\*\*\*\* R10-1108p shall only be used along roadways under the jurisdiction of the State.

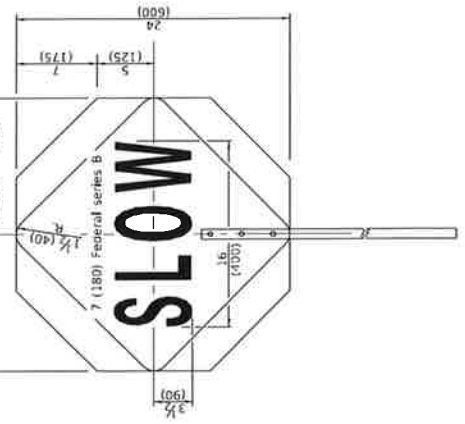
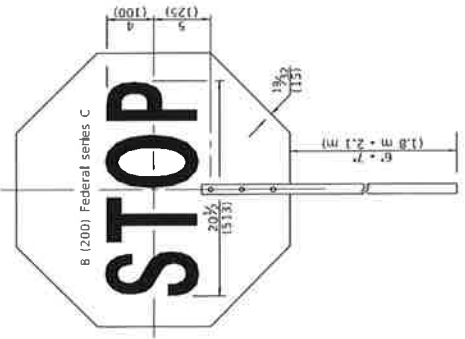

**FLAGGER TRAFFIC CONTROL SIGN**

MAX WIDTH	XX' - XX"
XX MILES	
AHEAD	

W12-1103-4848

**WIDTH RESTRICTION SIGN**

XX-XX" width and X miles are variable.

Illinois Department of Transportation

APPROVED: [Signature] 01/13

ENGINEER OF SAFETY, PUBLIC AND TRAFFIC SIGNING

APPROVED: [Signature] 01/13

ENGINEER OF TRAFFIC AND TRANSPORTATION

**TRAFFIC CONTROL DEVICES**

(Sheet 2 of 3)

**STANDARD 701901-08**

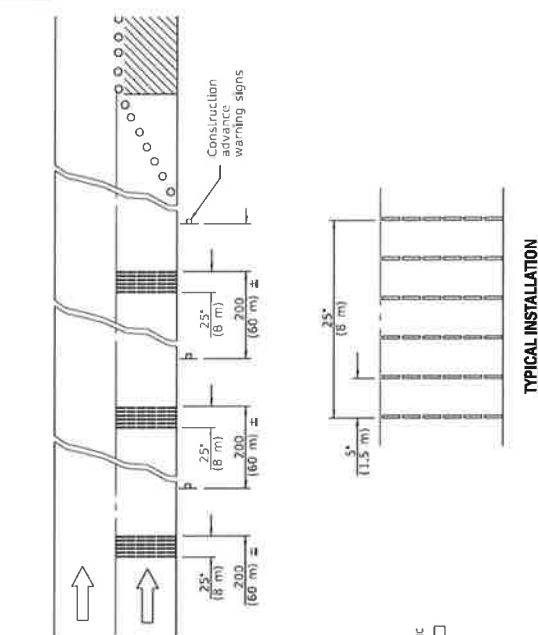

TYPICAL INSTALLATION

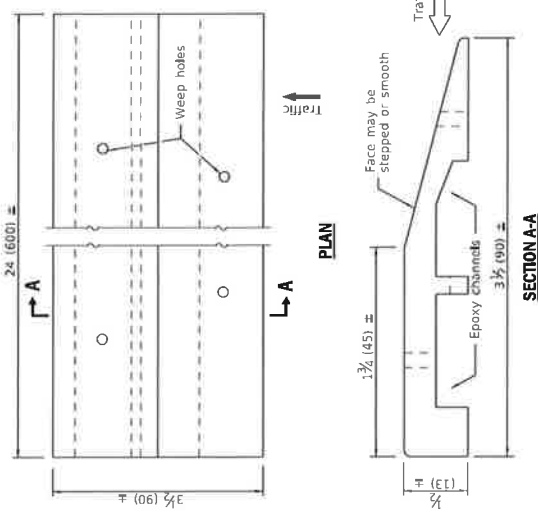

TEMPORARY RUMBLE STRIPS

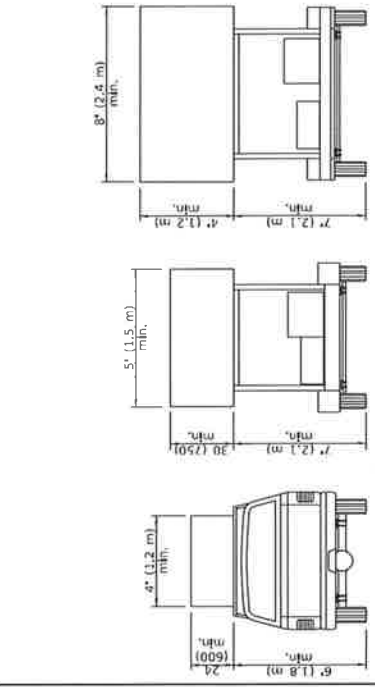

TYPE C TRAILER MOUNTED

TYPE B ROOF ON TRAILER MOUNTED

TYPE A ROOF MOUNTED

ARROW BOARDS

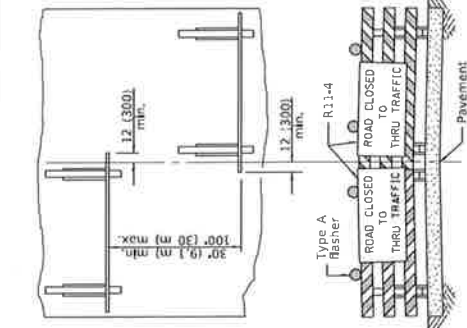

ROAD CLOSED TO THRU TRAFFIC

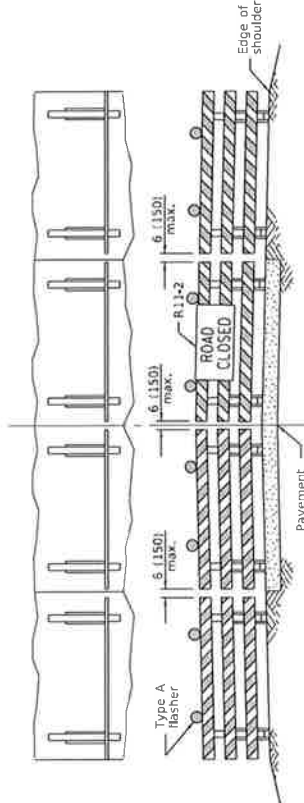

ROAD CLOSED TO ALL TRAFFIC

Reflectized striping may be omitted on the back side of the barricades. If a Type III barricade with an attached sign panel which meets NCHRP 350 is not available, the sign may be mounted on an NCHRP 350 temporary sign support directly in front of the barricade.

TYPICAL APPLICATIONS OF TYPE III BARRICADES CLOSING A ROAD

Illinois Department of Transportation

APPROVED: [Signature] DATE: [Date]

DESIGNED BY: [Signature] DATE: [Date]

PROJECT: [Project Name]

SCALE: [Scale]

DATE: [Date]

PROJECT: [Project Name]

SCALE: [Scale]

DATE: [Date]

TRAFFIC CONTROL DEVICES

(Sheet 3 of 3)

STANDARD 701901-08

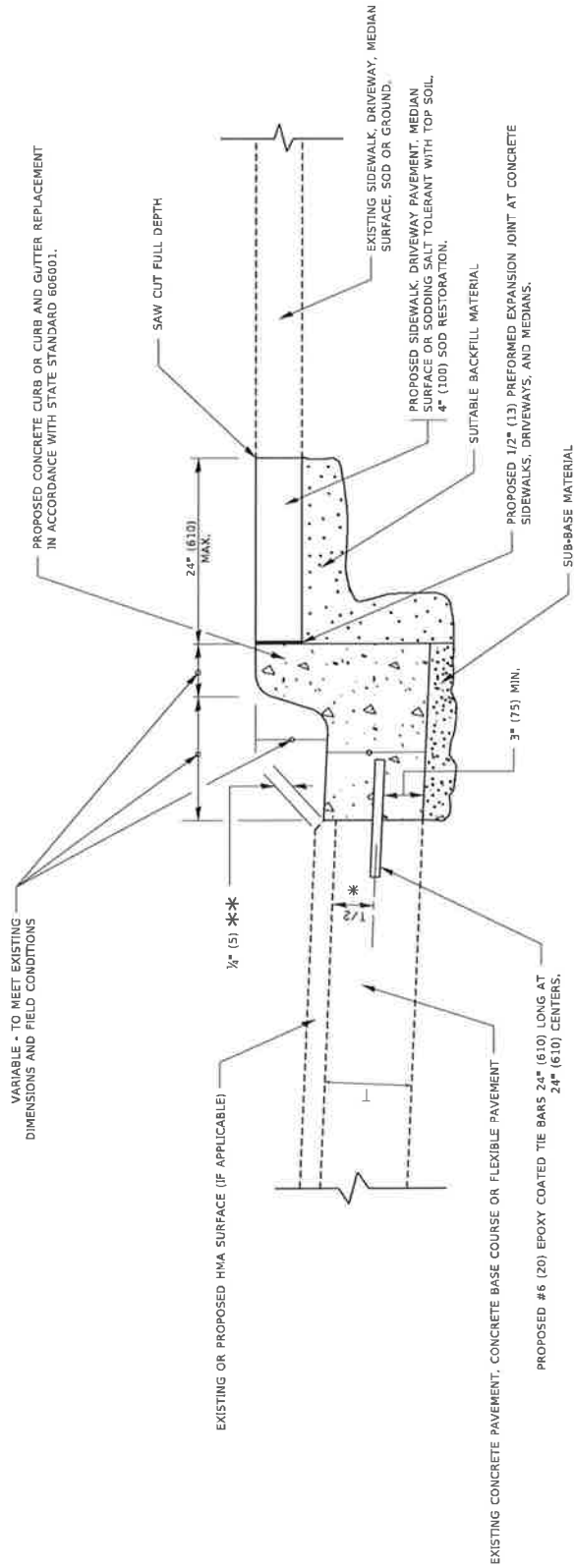

\* 3" (75) MINIMUM FROM TOP AND BOTTOM OF THE CONCRETE PAVEMENT OR BASE COURSE.

\*\* IF THE FINAL SURFACE OF THE PAVEMENT IS CONCRETE, THE GUTTER IS TO BE FLUSH WITH THE PAVEMENT.

# CURB OR CURB AND GUTTER REMOVAL AND REPLACEMENT

ALL DIMENSIONS ARE IN INCHES (MILLIMETERS) UNLESS OTHERWISE SHOWN.

DESIGNED BY	A. ARBAS (SIN/04)	SECTION	RD500-06 (RD-24)	SHEET NO.	1 OF 1
DRAWN BY	M. COMBE (SIN/02)	COUNTY	ILLINOIS	CONTRACT NO.	
CHECKED BY	E. BENT (SIN/08)	STATE OF ILLINOIS DEPARTMENT OF TRANSPORTATION			
DATE	03/1/04				
PROJECT NO.	03-11-04	CURE OR CURB AND GUTTER REMOVAL AND REPLACEMENT			
SCALE	AS SHOWN				



EXHIBIT NO.109  
MATERIALS LIST

Date of revision: 1/1/16

**Water Distribution Material Specifications:**

Water main pipe.	Ductile Iron Pipe. Pipe class thickness—AWWA C150, minimum thickness, Class 52. Pipe—AWWA C151. Pipe lining—AWWA C104. Fittings—AWWA C153. Joints—mechanical and push-on, AWWA C111. Wrap—4 mil. X-Lam conforming to AWWA C105.A21.5 and AWWA C600. No 90 degree bends allowed. All stainless steel trim.
Valves.	American Flow Control, Series 2500 resilient wedge gate valve. All sizes two inch to fourteen inch, counter clockwise to open, AWWA C500., AWWA C504. Clow AWWA C-504 Butterfly Valve for sixteen inch and above. Joint end—mechanical, AWWA C111. All stainless steel trim.
Valve Vault.	All structures shall be monolithically precast with designed openings or mechanically cored in the field and shall have rubber boots conforming to ASTM C-923. Dog house vaults are excluded from these requirements when permitted by Village Engineer. Size: For six and eight inch diameter valves, valve vaults shall have a forty-eight inch inside diameter; for pressure connections and valves ten inches and larger in diameter, valve vaults shall have a sixty inch inside diameter. All valve vault cones must be eccentric centers with valve properly aligned.
Castings.	East Jordan Iron Works 1022 Frame and Lid or Neenah R-1713, embossed per Exhibit No. 401 of Buffalo Grove Numerical Code Title 16.
Fire Hydrant.	Waterous Pacer Model WB67-250, AWWA C502, painted fire engine red above ground, with resilient wedge auxiliary gate valve. Nozzles, two at two and one half inch, one at four and one half inch, with threads conforming to National Standard Specifications. Frangible section (breakaway type) with the break line flange located one inch above finished grade. Joint end, six inch, mechanical or push-on. All stainless steel trim. Auxiliary boxes and hydrants shall be a direct flange-to-flange connection.
Fire hydrant extension	Fire hydrant extensions and parts to be manufactured by Waterous only. All stainless steel trim.
Hydrant Valve Box \ Valve boxes	Hydrant Valve Box Tyler 664-S. Lid embossed "WATER." Rubber valve box stabilizer required.
Service Pipe.	Copper tube, two inches and smaller, ASTM B88, Type K (1" minimum). Ductile iron, larger than two inches. Conform to Water main section above. Service upgrade for existing water main requires a stainless steel tap repair clamp. Ford model FS1-CC, minimum length 15" long.
Corporation Stop.	Mueller H15000, 1" minimum, AWWA C800. 1" Direct tap or 1 1/4" and larger shall use Ford FC202 stainless steel band, epoxy coated saddle.
Curb Stop.	Copper service, Mueller H-15154. Ductile iron service, Resilient wedge counter clockwise to open, AWWA C500. Joint end—mechanical, AWWA C111.
Curb box	Copper service, Mueller H-10302. Ductile iron service, conform to Hydrant Valve Box section above. Ductile iron service, 6" and larger, conform to Valve Vault section above.
Copper to Copper Fittings	Mueller Company Model #H-15400. An all flared coupling is required, no sweat joint or compression allowed.
Pressure Connections	Ford FTSS style tapping sleeve. American Flow Control Series 2500 tapping valve four inch minimum. All stainless steel trim.

**Sanitary Sewer Material Specifications:**

Sewer and Service Connection Pipe	Reinforced concrete pipe—circular reinforcement, minimum Class 3, ASTM C76, with epoxy lining. PVC solid wall (SDR-26H) pipe—ASTM D-3034 for six to fifteen inches in diameter.
Sewer and Service Connection Pipe Joints.	Reinforced concrete pipe—ASTM C443. PVC solid wall (SDR-26H) pipe—ASTM D-3212 for six to eighteen inches in diameter.
Sewer and Service Connection Pipe Fittings	PVC solid wall (SDR-26H) pipe—ASTM D3034 for six to fifteen inches in diameter.
Casing Pipes.	Steel pipe—ASTM A120, three-eighths inch minimum thickness.
Manholes	Size: For sewer eighteen inch diameter or less, manhole shall have a forty-eight inch inside diameter. For sewer twenty-one inch to thirty-six inch diameter, manhole shall have a sixty inch inside diameter. For sewer greater than thirty-six inch diameter, manhole shall have an offset riser pipe of forty-eight inch inside diameter. All structures shall be monolithically precast including bases and invert flow lines.
Castings.	East Jordan Iron Works Frame 1022 or Neenah R-1713, with self-sealing lid and recessed pick hole, embossed per Exhibit No. 301 of Buffalo Grove Numerical Code Title 16.

**Storm Sewer System Material Specifications:**

Structures.	All structures shall be precast with designed openings or mechanically cored in the field.
Castings.	Closed Lid, East Jordan Iron Works 1022 or Neenah R-1713, embossed per Exhibit No. 201., Open Lid, East Jordan Iron Works 1022 or Neenah R-1713, Standard B4.12 or any other barrier curb, Type 11— East Jordan Iron Works 7210 or Neenah 3281-A or Neenah 3170 on existing structures where required. Box height must be 6” minimum with 5’ tapers to match curb height., Depressed barrier curb, Type M3 Grate, Yard inlet, Type 8— East Jordan Iron Works 6517 or Neenah R-4340-B
Sewer Pipe Joints.	Reinforced concrete pipe—ASTM C443 or C361. PVC solid wall (SDR-26H) pipe—ASTM D-3212 for six to eighteen inches in diameter.
Sump pump service connection pipe/sub surface drain pipe.	4” PVC solid wall sewer pipe SDR-35. Blind connections must be cored in storm sewer and pipe connection shall be made with a rubber boot and stainless steel band. Sump pump per Exhibit No. 202 of Buffalo Grove Numerical Code Title 16 and underdrain per Exhibit No. 203.

**Material Specifications For All Utilities:**

Bedding	CA-11, Class B or better. All stone shall be crushed; rounded aggregate will not be permitted. The stone shall be compacted to 90% modified proctor density as required by ASTM D1557 or AASHTO T-180. Recycled materials permitted from IDOT approved sources meeting the correct gradations.
Trench Backfill	CA-11, Class B or better. This item shall meet the requirements of Class B CA-11, per the IDOT Standard Specifications for Road and Bridge Construction. All stone shall be crushed; rounded aggregate will not be permitted. The stone shall be compacted to 95% modified proctor density as required by ASTM D1557 or AASHTO T-180. Jetting of trenches is not permitted. Recycled materials permitted from IDOT approved sources meeting the correct gradations.
Adjustments	No more than two precast concrete adjusting rings with six inch maximum height adjustment shall be allowed, minimum one 2” ring installed on new structures. All adjustment rings less than 2” shall be HDPE rings. Only one HDPE may be used within the precast tolerances. Only precast concrete or

	HDPE adjustment rings permitted. ½” x 3.5” mastic to be used between all frames, rings and structures. Mortar around rings, but none between. Bed of mortar can be used on cone or flat top of structure.
--	---

**Miscellaneous Material Specifications:**

Detectable Warnings	East Jordan Iron Works or Neenah cast iron detectable warnings. Color shall be brick red.
Concrete	In accordance with IDOT Standard Specifications for Road and Bridge Construction
Asphalt	In accordance with IDOT Standard Specifications for Road and Bridge Construction and Section 16.50.070 of the Village of Buffalo Grove Municipal Code

\* The Village Engineer shall have the authority to approve the use of alternative materials than those specifically required by Exhibit 109 in the manner provided for in Title 16 of the Village of Buffalo Grove Numerical Code. The Village Engineer may approve alternative materials that are not specifically required by this title when:

1. The materials or their components required by this title are no longer manufactured and available for purchase; and
2. The alternative materials are generally consistent with requirements of this title, including but not limited to those standards relating to production, composition, safety and aesthetics.

**Testing Specifications:**

**(In addition to the requirements of IDOT’s Standard Specifications for Road and Bridge Construction or the Standard Specifications for Water and Sewer Construction in Illinois)**

Storm Sewer	Cleaning and televising, with reporting, as directed by the Village Engineer
Sanitary Sewer	Cleaning and televising, with reporting, as directed by the Village Engineer

\*When conflicting information exists between the plans specifications and this exhibit number 109 the information listed in exhibit number 109 shall govern. All castings on a project or development shall come from a single manufacturer.