

CONTRACT, LEASE, AGREEMENT CONTROL FORM

Date: 05/05/2021

Contract/Lease Control #: C21-3075-PW

Procurement#: ITB PW 27-21

Contract/Lease Type: AGREEMENT

Award To/Lessee: C.W. ROBERTS CONTRACTING, INC.

Owner/Lessor: OKALOOSA COUNTY

Effective Date: 05/04/2021

Expiration Date: 09/30/2021 W/2 1 YR RENEWALS

Description of: ROAD STABILIZATION

Department: PW

Department Monitor: AUTREY

Monitor's Telephone #: 850-689-5772

Monitor's FAX # or E-mail: JAUTREY@MYOKALOOSA.COM

Closed:

Cc: BCC RECORDS



CERTIFICATE OF LIABILITY INSURANCE

DATE (MM/DD/YYYY)
10/01/2021

THIS CERTIFICATE IS ISSUED AS A MATTER OF INFORMATION ONLY AND CONFERS NO RIGHTS UPON THE CERTIFICATE HOLDER. THIS CERTIFICATE DOES NOT AFFIRMATIVELY OR NEGATIVELY AMEND, EXTEND OR ALTER THE COVERAGE AFFORDED BY THE POLICIES BELOW. THIS CERTIFICATE OF INSURANCE DOES NOT CONSTITUTE A CONTRACT BETWEEN THE ISSUING INSURER(S), AUTHORIZED REPRESENTATIVE OR PRODUCER, AND THE CERTIFICATE HOLDER.

IMPORTANT: If the certificate holder is an ADDITIONAL INSURED, the policy(ies) must have ADDITIONAL INSURED provisions or be endorsed. If SUBROGATION IS WAIVED, subject to the terms and conditions of the policy, certain policies may require an endorsement. A statement on this certificate does not confer rights to the certificate holder in lieu of such endorsement(s).

| | | |
|---|---|-----------------------|
| PRODUCER McGriff Insurance Services, Inc. P.O. Box 10265 Birmingham, AL 35202 | CONTACT NAME: Martha Lee Hawkins PHONE (A/C, No, Ext): 800-476-2211 E-MAIL ADDRESS: mhawkins@mcgriff.com | FAX (A/C, No): |
| | INSURER(S) AFFORDING COVERAGE | |
| INSURED C.W. Roberts Contracting, Inc. P.O. Box 188 Hosford, FL 32334 | INSURER A : Arch Insurance Company NAIC # 11150 | |
| | INSURER B : Allied World National Assurance Company 10690 | |
| | INSURER C : | |
| | INSURER D : | |
| | INSURER E : | |
| | INSURER F : | |

COVERAGES CERTIFICATE NUMBER: PPWJVSM2 REVISION NUMBER:

THIS IS TO CERTIFY THAT THE POLICIES OF INSURANCE LISTED BELOW HAVE BEEN ISSUED TO THE INSURED NAMED ABOVE FOR THE POLICY PERIOD INDICATED. NOTWITHSTANDING ANY REQUIREMENT, TERM OR CONDITION OF ANY CONTRACT OR OTHER DOCUMENT WITH RESPECT TO WHICH THIS CERTIFICATE MAY BE ISSUED OR MAY PERTAIN, THE INSURANCE AFFORDED BY THE POLICIES DESCRIBED HEREIN IS SUBJECT TO ALL THE TERMS, EXCLUSIONS AND CONDITIONS OF SUCH POLICIES. LIMITS SHOWN MAY HAVE BEEN REDUCED BY PAID CLAIMS.

| INSR LTR | TYPE OF INSURANCE | ADDL INSD | SUBR WVD | POLICY NUMBER | POLICY EFF (MM/DD/YYYY) | POLICY EXP (MM/DD/YYYY) | LIMITS | | |
|----------|---|-----------|----------|---------------|-------------------------|-------------------------|------------|---|--|
| A | <input checked="" type="checkbox"/> COMMERCIAL GENERAL LIABILITY <input type="checkbox"/> CLAIMS-MADE <input checked="" type="checkbox"/> OCCUR GENL AGGREGATE LIMIT APPLIES PER: <input type="checkbox"/> POLICY <input checked="" type="checkbox"/> PROJECT <input type="checkbox"/> LOC OTHER: | | X | X | ZAGLB9247600 | 10/01/2021 | 10/01/2022 | EACH OCCURRENCE \$ 6,000,000 DAMAGE TO RENTED PREMISES (Ea occurrence) \$ 100,000 MED EXP (Any one person) \$ 10,000 PERSONAL & ADV INJURY \$ 6,000,000 GENERAL AGGREGATE \$ 12,000,000 PRODUCTS - COMP/OP AGG \$ 12,000,000 | |
| A | AUTOMOBILE LIABILITY <input checked="" type="checkbox"/> ANY AUTO <input type="checkbox"/> OWNED AUTOS ONLY <input type="checkbox"/> HIRED AUTOS ONLY <input type="checkbox"/> SCHEDULED AUTOS <input type="checkbox"/> NON-OWNED AUTOS ONLY | | X | X | ZACAT9276800 | 10/01/2021 | 10/01/2022 | COMBINED SINGLE LIMIT (Ea accident) \$ 6,000,000 BODILY INJURY (Per person) \$ BODILY INJURY (Per accident) \$ PROPERTY DAMAGE (Per accident) \$ | |
| B | <input type="checkbox"/> UMBRELLA LIAB <input checked="" type="checkbox"/> EXCESS LIAB <input checked="" type="checkbox"/> DED <input checked="" type="checkbox"/> RETENTION \$ 10,000 | | | | 03125099 | 10/01/2021 | 10/01/2022 | EACH OCCURRENCE \$ 5,000,000 AGGREGATE \$ 5,000,000 | |
| A | WORKERS COMPENSATION AND EMPLOYERS' LIABILITY ANY PROPRIETOR/PARTNER/EXECUTIVE OFFICER/MEMBER EXCLUDED? (Mandatory in NH) If yes, describe under DESCRIPTION OF OPERATIONS below | | Y/N | N/A | X | ZAWCI9966600 | 10/01/2021 | 10/01/2022 | <input checked="" type="checkbox"/> PER STATUTE <input type="checkbox"/> OTHER E.L. EACH ACCIDENT \$ 1,000,000 E.L. DISEASE - CA EMPLOYEE \$ 1,000,000 E.L. DISEASE - POLICY LIMIT \$ 1,000,000 |

DESCRIPTION OF OPERATIONS / LOCATIONS / VEHICLES (ACORD 101, Additional Remarks Schedule, may be attached)
Project: ITB PW 08-20, Henderson Beach/Commons Drive Signal & Roadway Improvements, Okaloosa

Okaloosa County Board of County Commissioners and Avcon, Inc. are Additional Insureds on a pri Liability and Excess Liability as required by written contract. A Waiver of Subrogation is included w/ Workers' Compensation & Employers Liability, and Excess Liability policies in favor of the aforesaid of cancellation by the insurance company(ies) the policies have been endorsed to provide 30 days shown below.

CONTRACT # C21-3075-PW
C.W. ROBERTS CONTRACTING, INC.
ROAD STABILIZATION PROJECT
EXPIRES: 09/30/2021 W/2 1 YR RENEWALS

CERTIFICATE HOLDER CANCELLATION

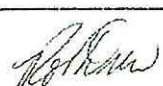
| | |
|--|---|
| Okaloosa County Board of County Commissioners 1250 N. Eglin Parkway Shalimar, FL 32579 | SHOULD ANY OF THE ABOVE DESCRIBED POLICIES BE CANCELLED BEFORE THE EXPIRATION DATE THEREOF, NOTICE WILL BE DELIVERED IN ACCORDANCE WITH THE POLICY PROVISIONS |
| | AUTHORIZED REPRESENTATIVE  |

THIS ENDORSEMENT CHANGES THE POLICY. PLEASE READ IT CAREFULLY.

**ADDITIONAL INSURED – OWNERS, LESSEES OR
CONTRACTORS – SCHEDULED PERSON OR
ORGANIZATION**

This endorsement modifies insurance provided under the following:

COMMERCIAL GENERAL LIABILITY COVERAGE PART

SCHEDULE

| Name Of Additional Insured Person(s) Or Organization(s): | Location(s) Of Covered Operations |
|---|--|
| <p>ALL PARTIES EXCEPT PARTICIPANTS OF CONTROLLED INSURANCE PROGRAMS, WHERE REQUIRED BY A WRITTEN CONTRACT. THIS INSURANCE IS PRIMARY AND NON-CONTRIBUTORY WITH ANY OTHER INSURANCE WHERE THE WRITTEN CONTRACT REQUIRES THIS INSURANCE BE PRIMARY AND NON-CONTRIBUTORY. WHEN THE INSURANCE PROVIDED BY THIS ENDORSEMENT IS PRIMARY AND NON-CONTRIBUTORY, WE WILL NOT SEEK ANY CONTRIBUTION FROM ANY OTHER INSURANCE POLICY AVAILABLE TO THE ADDITIONAL INSURED ON WHICH THE ADDITIONAL INSURED IS A NAMED INSURED.</p> | <p>ALL LOCATIONS OF COVERED OPERATIONS</p> |
| <p>Information required to complete this Schedule, if not shown above, will be shown in the Declarations.</p> | |

A. Section II – Who Is An Insured is amended to include as an additional insured the person(s) or organization(s) shown in the Schedule, but only with respect to liability for "bodily injury", "property damage" or "personal and advertising injury" caused, in whole or in part, by:

1. Your acts or omissions; or
2. The acts or omissions of those acting on your behalf.

in the performance of your ongoing operations for the additional insured(s) at the location(s) designated above.

B. With respect to the insurance afforded to these additional insureds, the following additional exclusions apply:

This insurance does not apply to "bodily injury" or "property damage" occurring after:

1. All work, including materials, parts or equipment furnished in connection with such work, on the project (other than service, maintenance or repairs) to be performed by or on behalf of the additional insured(s) at the location of the covered operations has been completed; or
2. That portion of "your work" out of which the injury or damage arises has been put to its intended use by any person or organization other than another contractor or subcontractor engaged in performing operations for a principal as a part of the same project.

THIS ENDORSEMENT CHANGES THE POLICY. PLEASE READ IT CAREFULLY.

ADDITIONAL INSURED – OWNERS, LESSEES OR CONTRACTORS – COMPLETED OPERATIONS

This endorsement modifies insurance provided under the following:

COMMERCIAL GENERAL LIABILITY COVERAGE PART

SCHEDULE

| Name Of Additional Insured Person(s) Or Organization(s): | Location And Description Of Completed Operations |
|---|--|
| <p>ALL PARTIES EXCEPT PARTICIPANTS OF CONTROLLED INSURANCE PROGRAMS, WHERE REQUIRED BY A WRITTEN CONTRACT. THIS INSURANCE IS PRIMARY AND NON-CONTRIBUTORY WITH ANY OTHER INSURANCE WHERE THE WRITTEN CONTRACT REQUIRES THIS INSURANCE BE PRIMARY AND NON-CONTRIBUTORY. WHEN THE INSURANCE PROVIDED BY THIS ENDORSEMENT IS PRIMARY AND NON-CONTRIBUTORY, WE WILL NOT SEEK ANY CONTRIBUTION FROM ANY OTHER INSURANCE POLICY AVAILABLE TO THE ADDITIONAL INSURED ON WHICH THE ADDITIONAL INSURED IS A NAMED INSURED.</p> | <p>ALL LOCATIONS OF COVERED OPERATIONS</p> |
| <p>Information required to complete this Schedule, if not shown above, will be shown in the Declarations.</p> | |

Section II – Who Is An Insured is amended to include as an additional insured the person(s) or organization(s) shown in the Schedule, but only with respect to liability for "bodily injury" or "property damage" caused, in whole or in part, by "your work" at the location designated and described in the schedule of this endorsement performed for that additional insured and included in the "products-completed operations hazard".

PROCUREMENT/CONTRACT/LEASE
INTERNAL COORDINATION SHEET

Procurement/Contract/Lease Number: TBD 27-21 Tracking Number: 4277-21
Procurement/Contractor/Lessee Name: CW. Roberts Contract Grant Funded: YES ___ NO X
Purpose: Road Stabilization
Date/Term: Sept 2021 - 2 1yr renewals 1. GREATER THAN \$100,000
Department #: 3301 2. GREATER THAN \$50,000
Account #: 563001 3. \$50,000 OR LESS
Amount: TBD by Task order
Department: PW Dept. Monitor Name: Auty

Purchasing Review
Procurement or Contract/Lease requirements are met:
DeRita Mason Date: 3-30-31
Purchasing Manager or designee Jeff Hyde, DeRita Mason, Jessica Darr, Angela Etheridge

2CFR Compliance Review (if required)
Approved as written: No Federal funds Grant Name: _____
_____ Date: _____
Grants Coordinator

Risk Management Review
Approved as written: see email attached Date: 3-30-21
_____ Lisa Price
Risk Manager or designee

County Attorney Review
Approved as written: see email attached Date: 4-9-21
_____ Lynn Hoshihara, Kerry Parsons or Designee
County Attorney

Department Funding Review
Approved as written: _____ Date: _____

IT Review (if applicable)
Approved as written: _____ Date: _____

Revised September 22, 2020

C21-3075 PW

DeRita Mason

From: Lynn Hoshihara
Sent: Friday, April 9, 2021 2:32 PM
To: DeRita Mason; 'Parsons, Kerry'
Cc: Lisa Price
Subject: Re: CW Roberts Draft Contract 27-21

This is approved for legal sufficiency.

Lynn M. Hoshihara
County Attorney
Okaloosa County, Florida

Please note: Due to Florida's very broad public records laws, most written communications to or from County employees regarding County business are public records, available to the public and media upon request. Therefore, this written e-mail communication, including your e-mail address, may be subject to public disclosure.

From: DeRita Mason
Sent: Friday, April 9, 2021 3:18:02 PM
To: Lynn Hoshihara; 'Parsons, Kerry'
Cc: Lisa Price
Subject: RE: CW Roberts Draft Contract 27-21

See attached with revisions. There is no Attachment "D".

DeRita Mason



DeRita Mason, CPPB, NIGP-CPP
Senior Contracts and Lease Coordinator
Okaloosa County Purchasing Department
5479A Old Bethel Road
Crestview, Florida 32536
(850) 689-5960
dmason@myokaloosa.com

"Please note: Due to Florida's very broad public records laws, most written communications to or from County employees regarding County business are public records, available to the public and media upon request. Therefore, this written e-mail communication, including your e-mail address, may be subject to public disclosure."

DeRita Mason

From: Lisa Price
Sent: Tuesday, March 30, 2021 8:02 AM
To: DeRita Mason
Subject: RE: CW Roberts Draft Contract 27-21

This is approved by Risk for insurance purposes.

Lisa Price
Public Records & Contracts Specialist
302 N Wilson Street, Suite 301
Crestview, FL. 32536
(850) 689-5979
lprice@myokaloosa.com



"Kindness is the language which the deaf can hear and the blind can see"
Mark Twain

For all things Wellness please visit:
<http://www.myokaloosa.com/wellness>

Due to Florida's very broad public records laws, most written communications to or from county employees regarding county business are public records, available to the public and media upon request. Therefore, this written e-mail communication, including your e-mail address, may be subject to public disclosure.

From: DeRita Mason <dmason@myokaloosa.com>
Sent: Tuesday, March 30, 2021 7:58 AM
To: 'Parsons, Kerry' <KParsons@ngn-tally.com>
Cc: Lynn Hoshihara <lhoshihara@myokaloosa.com>; Lisa Price <lprice@myokaloosa.com>
Subject: CW Roberts Draft Contract 27-21

Good morning ladies,
Please review and approve the attached.
I will have a total of three contracts for this ITB. Once this one is approved, I will prepare and send the other two your way.

Thank you,

DeRita Mason



Board of County Commissioners Purchasing Department

State of Florida

March 26, 2021

**OKALOOSA COUNTY PURCHASING DEPARTMENT
NOTICE OF AWARD
ITB PW 27-21**

Okaloosa County would like to thank all businesses that submitted bids for Road Stabilization (Lime-rock Placement & Compaction. (ITB PW 27-21)

After an in-depth examination of all responses and in accordance with the County's Purchasing Manual, the County announces its intent to award the contract to the following:

C.W. Roberts Contracting, Inc.
160 Industrial Park Road
Freeport, FL 32439

Mohawk Valley Materials, Inc.
P.O. Box 231
Rome, NY 13442

Bullard Excavating, Inc.
13264 Eva Drive
Andalusia, AL 36420

Any person/entity desiring to file a procurement protest must meet all the standards and criteria in accordance with Section 31 of the Okaloosa County Purchasing Manual. Failure to file a protest within the time prescribed in Section 31.02 of the Okaloosa County Purchasing Manual, shall constitute a waiver of protest proceedings.

Respectfully,

A handwritten signature in blue ink that reads "Jeffrey A Hyde".

Jeffrey Hyde
Purchasing Manager



Department of State / Division of Corporations / Search Records / Search by FEI/EIN Number /

Detail by FEI/EIN Number

Florida Profit Corporation

C. W. ROBERTS CONTRACTING, INCORPORATED

Filing Information

| | |
|-----------------------------|------------|
| Document Number | 493846 |
| FEI/EIN Number | 59-1683951 |
| Date Filed | 01/19/1976 |
| State | FL |
| Status | ACTIVE |
| Last Event | AMENDMENT |
| Event Date Filed | 05/08/2020 |
| Event Effective Date | NONE |

Principal Address

1603 BAY AVENUE
PANAMA CITY, FL 32405

Changed: 02/23/2017

Mailing Address

P.O. BOX 16279
TALLAHASSEE, FL 32317

Changed: 04/09/2007

Registered Agent Name & Address

FLOWERS, ROBERT P
3372 CAPITAL CIRCLE NE
TALLAHASSEE, FL 32308

Name Changed: 09/13/2013

Address Changed: 09/13/2013

Officer/Director Detail

Name & Address

Title President

FLOWERS, ROBERT P
3372 CAPITAL CIRCLE NE
TALLAHASSEE, FL 32308

Title Secretary, CFO

DELISLE, ROBERT
3372 CAPITAL CIRCLE NE
TALLAHASSEE, FL 32308

Title VP

Palmer, Alan
P.O. BOX 16279
TALLAHASSEE, FL 32317

Title VP

Fleming III, Ned N
P.O. BOX 16279
TALLAHASSEE, FL 32317

Title CEO

Owens, Charles E
P.O. BOX 16279
TALLAHASSEE, FL 32317

Title VP, Asst. Secretary, Treasurer

Matteson, Mark R
P.O. BOX 16279
TALLAHASSEE, FL 32317

Title VP

Savoy, Stuart
P.O. BOX 16279
TALLAHASSEE, FL 32317

Title VP

Riley, Chris
P.O. BOX 16279
TALLAHASSEE, FL 32317

Title VP

STRAIN, JAMES(JIMMY) A
P.O. BOX 16279
TALLAHASSEE, FL 32317

Title V.P.

CASTLEBERRY, WILLIAM T.
P.O. BOX 16279
TALLAHASSEE, FL 32317

TALLAHASSEE, FL 32317

Title V.P.

ARMSTRONG, M. BRETT
P.O. BOX 16279
TALLAHASSEE, FL 32317

Title Asst. Secretary

Steele, Matthew
P.O. BOX 16279
TALLAHASSEE, FL 32317

Annual Reports

| Report Year | Filed Date |
|--------------------|-------------------|
| 2019 | 01/10/2019 |
| 2020 | 01/07/2020 |
| 2021 | 01/04/2021 |

Document Images

| | |
|---|--|
| 01/04/2021 -- ANNUAL REPORT | View image in PDF format |
| 05/08/2020 -- Amendment | View image in PDF format |
| 01/07/2020 -- ANNUAL REPORT | View image in PDF format |
| 07/15/2019 -- Amendment | View image in PDF format |
| 04/02/2019 -- Amendment | View image in PDF format |
| 01/10/2019 -- ANNUAL REPORT | View image in PDF format |
| 08/14/2018 -- Amendment | View image in PDF format |
| 01/24/2018 -- ANNUAL REPORT | View image in PDF format |
| 03/28/2017 -- AMENDED ANNUAL REPORT | View image in PDF format |
| 01/24/2017 -- ANNUAL REPORT | View image in PDF format |
| 03/01/2016 -- ANNUAL REPORT | View image in PDF format |
| 01/23/2015 -- ANNUAL REPORT | View image in PDF format |
| 01/08/2014 -- ANNUAL REPORT | View image in PDF format |
| 09/13/2013 -- Amendment | View image in PDF format |
| 01/16/2013 -- ANNUAL REPORT | View image in PDF format |
| 03/16/2012 -- ANNUAL REPORT | View image in PDF format |
| 04/06/2011 -- ANNUAL REPORT | View image in PDF format |
| 03/02/2010 -- ANNUAL REPORT | View image in PDF format |
| 04/10/2009 -- ANNUAL REPORT | View image in PDF format |
| 03/11/2008 -- ANNUAL REPORT | View image in PDF format |
| 04/09/2007 -- ANNUAL REPORT | View image in PDF format |
| 02/23/2006 -- ANNUAL REPORT | View image in PDF format |
| 04/13/2005 -- ANNUAL REPORT | View image in PDF format |
| 02/18/2004 -- ANNUAL REPORT | View image in PDF format |
| 01/22/2003 -- ANNUAL REPORT | View image in PDF format |
| 03/14/2002 -- ANNUAL REPORT | View image in PDF format |
| 01/30/2002 -- Merger | View image in PDF format |
| 04/06/2001 -- ANNUAL REPORT | View image in PDF format |

03/24/2000 -- ANNUAL REPORT

[View image in PDF format](#)

02/17/1999 -- ANNUAL REPORT

[View image in PDF format](#)

02/03/1998 -- ANNUAL REPORT

[View image in PDF format](#)

02/03/1997 -- ANNUAL REPORT

[View image in PDF format](#)

02/22/1996 -- ANNUAL REPORT

[View image in PDF format](#)

04/07/1995 -- ANNUAL REPORT

[View image in PDF format](#)



A NEW WAY TO SIGN IN - If you already have a SAM account, use your SAM email for login.gov.

Log In

Login.gov FAQs

ALERT: SAM.gov will be down for scheduled maintenance Saturday, 03/20/2021 from 8:00 AM to 8:00 PM.

Search Results

Current Search Terms: C. W. Roberts Contracting, Incorporated*

Total records: 1

Save PDF Export Results Print

Result Page: 1

Sort by Relevance Order by Descending

Your search for C. W. Roberts Contracting, Incorporated* returned the following results...

| | | |
|--|--|------------------------------|
| Entity | C. W. Roberts Contracting, Incorporated | Status: Active |
| DUNS: 094593589 | CAGE Code: 0CHA7 | View Details |
| Has Active Exclusion?: No | DoDAAC: | |
| Expiration Date: 11/30/2021 | Debt Subject to Offset?: No | |
| Purpose of Registration: All Awards | | |

Save PDF Export Results Print

Result Page: 1



IBM-P-20210314-0800
WWW6

- Search Records
- Data Access
- Check Status
- About
- Help
- Disclaimers
- Accessibility
- Privacy Policy
- USA.gov
- FAPIS.gov
- GSA.gov/IAE
- GSA.gov
- USA.gov

**AGREEMENT BETWEEN OKALOOSA COUNTY, FLORIDA
AND C.W. ROBERTS CONTRACTING, INC.**

THIS AGREEMENT (hereinafter referred to as the "Agreement") is made this 4th day of May, 2021, by and between Okaloosa County, a political subdivision of the state of Florida, (hereinafter referred to as the "County"), with a mailing address of 1250 N. Eglin Parkway, Suite 100, Shalimar, Florida, 32579, and C.W. Roberts Contracting, Inc., a Florida Profit Corporation, whose mailing address is 160 Industrial Park Road, Freeport, FL 32439, authorized to do business in the State of Florida (hereinafter referred to as "Contractor") whose Federal I.D. # is 59-1683951.

RECITALS

WHEREAS, the County is in need of a contractor to provide Road Stabilization Lime-Rock Placement & Compaction ("Services"); and

WHEREAS, pursuant to the Okaloosa County Purchasing Manual, the County obtained bids from contractors to perform these Services. A copy of Contractor's proposal is included as Attachment "A"; and

WHEREAS, Contractor is a certified and insured entity with the necessary experience to provide the desired Services; and

WHEREAS, the County wishes to enter into this Agreement with Contractor to provide the Services to the County based on Exhibit "A" attached and per task order, as further detailed below.

NOW THEREFORE, in consideration of the promises and the mutual covenants herein, the parties agree as follows:

1. Recitals and Attachments. The Recitals set forth above are hereby incorporated into this Agreement and made part hereof for reference.

The following documents are attached to this Agreement and are incorporated herein.

Attachment "A" – ITB PW 27-21 and Contractor's Proposal;

Attachment "B" – Insurance Requirements;

Attachment "C" – Title VI list of pertinent nondiscrimination acts and authorities.

2. Services. Contractor agrees to perform the following services, Road Stabilization Project (Lime-rock Placement & Compaction). The Services to be provided are further detailed in the Contractor's proposal attached as Attachment "A" and incorporated herein by reference. The Services shall be performed by Contractor to the full satisfaction of the County. Contractor agrees to have a qualified representative to audit and inspect the Services provided on a regular basis to ensure all Services are being performed in accordance with the County's needs and pursuant to the terms of this Agreement and shall report to the County accordingly. Contractor

agrees to immediately inform the County via telephone and in writing of any problems that could cause damage to the County. Contractor will require its employees to perform their work in a manner befitting the type and scope of work to be performed.

3. Term and Renewal. The contract shall commence upon execution by both parties and extend through September 30, 2021. This contract may be renewed for two (2) additional one (1) year periods if in agreement with both parties. All work performed under this Contract shall be assigned by way of task orders. Fully executed task orders shall be considered the Notice to Proceed in accordance with the terms of this Contract and will remain in effect until completed. Upon work commencement, the contractor assumes responsibility for the maintenance of the road until successful completion.

4. Compensation. The Contractor agrees to provide the Services to the County, including materials and labor, per Attachment “A” attached and per task order issued.

Attachment “A”-Bid Tab is amended as follows:

| | |
|-----------|--|
| 1. | Cost per cubic yard of sand removed |
| 2. | Cost per cubic yard of sand removed and dropped at County Borrow Pits <u>or off site location</u> |

- a. Contractor shall submit an invoice to the County monthly. The invoice shall indicate that all services have been completed for that invoice period. In addition, Contractor agrees to provide the County with any additional documentation requested to process the invoices.
- b. Payment Schedule. Invoices received from the Contractor pursuant to this Agreement will be reviewed by the initiating County Department. Payment will be disbursed as set forth above. If services have been rendered in conformity with the Agreement, the invoice will be sent to the Finance Department for payment. Invoices must reference the contract number assigned by the County after execution of this Agreement. Invoices will be paid in accordance with the State of Florida Local Government Prompt Payment Act.
- c. Availability of Funds. The County’s performance and obligation to pay under this Agreement is contingent upon annual appropriation for its purpose by the County Commission.

Contractor shall make no other charges to the County for supplies, labor, taxes, licenses, permits, overhead or any other expenses or costs unless any such expenses or cost is incurred by Contractor with the prior written approval of the County. If the County disputes any charges on the invoices, it may make payment of the uncontested amounts and withhold payment on the contested amounts until they are resolved by agreement with the Contractor. Contractor shall not pledge the County’s credit or make it a guarantor of payment or surety for any contract, debt, obligation, judgment, lien, or any form of indebtedness. The Contractor further warrants and

represents that it has no obligation or indebtedness that would impair its ability to fulfill the terms of this Agreement.

5. Ownership of Documents and Equipment. All documents prepared by the Contractor pursuant to this Agreement and related Services to this Agreement are intended and represented for the ownership of the County only. Any other use by Contractor or other parties shall be approved in writing by the County. If requested, Contractor shall deliver the documents to the County within fifteen (15) calendar days.

6. Insurance. Contractor shall, at its sole cost and expense, during the period of any work being performed under this Agreement, procure and maintain the minimum insurance coverage required as set forth in Attachment "B" attached hereto and incorporated herein, to protect the County and Contractor against all loss, claims, damages and liabilities caused by Contractor, its agents, or employees.

7. Termination and Remedies for Breach.

- a. If, through any cause within its reasonable control, the Contractor shall fail to fulfill in a timely manner or otherwise violate any of the covenants, agreements or stipulations material to this Agreement, the County shall have the right to terminate the Services then remaining to be performed. Prior to the exercise of its option to terminate for cause, the County shall notify the Contractor of its violation of the particular terms of the Agreement and grant Contractor thirty (30) days to cure such default. If the default remains uncured after thirty (30) days the County may terminate this Agreement, and the County shall receive a refund from the Contractor in an amount equal to the actual cost of a third party to cure such failure. If Contractor fails, refuses or is unable to perform any term of this Agreement, County shall pay for services rendered as of the date of termination.
 - i. In the event of termination, all finished and unfinished documents, data and other work product prepared by Contractor (and sub-Contractor (s)) shall be delivered to the County and the County shall compensate the Contractor for all Services satisfactorily performed prior to the date of termination, as provided in Section 4 herein.
 - ii. Notwithstanding the foregoing, the Contractor shall not be relieved of liability to the County for damages sustained by it by virtue of a breach of the Agreement by Contractor and the County may reasonably withhold payment to Contractor for the purposes of set-off until such time as the exact amount of damages due the County from the Contractor is determined.
- b. Termination for Convenience of County. The County may, for its convenience and without cause immediately terminate the Services then remaining to be performed at any time by giving written notice. The terms of Section 7 Paragraphs a(i) and a(ii) above shall be applicable hereunder.

- c. Termination for Insolvency. The County also reserves the right to terminate the remaining Services to be performed in the event the Contractor is placed either in voluntary or involuntary bankruptcy or makes any assignment for the benefit of creditors.
- d. Termination for failure to adhere to the Public Records Law. Failure of the Contractor to adhere to the requirements of Chapter 119 of the Florida Statutes and Section 9 below, may result in immediate termination of this Agreement.

8. Governing Law, Venue and Waiver of Jury Trial. This Agreement shall be interpreted and construed in accordance with and governed by the laws of the State of Florida. All parties agree and accept that jurisdiction of any dispute or controversy arising out of this Agreement, and any action involving the enforcement or interpretation of any rights hereunder shall be brought exclusively in the First Judicial Circuit in and for Okaloosa County, Florida, and venue for litigation arising out of this Agreement shall be exclusively in such state courts, forsaking any other jurisdiction which either party may claim by virtue of its residency or other jurisdictional device. In the event it becomes necessary for the County to file a lawsuit to enforce any term or provision under this Agreement, then the County shall be entitled to its costs and attorney's fees at the pretrial, trial and appellate levels. BY ENTERING INTO THIS AGREEMENT, CONTRACTOR AND COUNTY HEREBY EXPRESSLY WAIVE ANY RIGHTS EITHER PARTY MAY HAVE TO A TRIAL BY JURY OF ANY CIVIL LITIGATION RELATED TO THIS AGREEMENT. Nothing in this Agreement is intended to serve as a waiver of sovereign immunity, or of any other immunity, defense, or privilege enjoyed by the County pursuant to Section 768.28, Florida Statutes.

9. Public Records. Any record created by either party in accordance with this Contract shall be retained and maintained in accordance with the public records law, Florida Statutes, Chapter 119. Contractor must comply with the public records laws, Florida Statute chapter 119, specifically Contractor must:

- a. Keep and maintain public records required by the County to perform the service.
- b. Upon request from the County's custodian of public records, provide the County with a copy of the requested records or allow the records to be inspected or copied within a reasonable time at a cost that does not exceed the cost provided in chapter 119 Florida Statutes or as otherwise provided by law.
- c. Ensure that public records that are exempt or confidential and exempt from public records disclosure requirements are not disclosed except as authorized by law for the duration of the contract term and following completion of the contract if the contractor does not transfer the records to the County.
- d. Upon completion of the contract, transfer, at no cost, to the County all public records in possession of the contractor or keep and maintain public records required by the County to perform the service. If the contractor transfers all public records to the public agency upon completion of the contract, the contractor shall destroy any

duplicate public records that are exempt or confidential and exempt from public records disclosure requirements. If the contractor keeps and maintains public records upon completion of the contract, the contractor shall meet all applicable requirements for retaining the public records. All records stored electronically must be provided to the public agency, upon the request from the public agency's custodian of public records, in a format that is compatible with the information technology systems of the public agency.

IF THE CONTRACTOR HAS QUESTIONS REGARDING THE APPLICATION OF CHAPTER 119, FLORIDA STATUTES, TO THE CONTRACTOR'S DUTY TO PROVIDE PUBLIC RECORDS RELATING TO THIS CONTRACT, CONTACT THE CUSTODIAN OF PUBLIC RECORDS AT OKALOOSA COUNTY RISK MANAGEMENT DEPARTMENT 302 WILSON ST., CRESTVIEW, FL 32536 PHONE: (850) 689-5977 riskinfo@myokaloosa.com.

10. Audit. The County and/or its designee shall have the right from time to time at its sole expense to audit the compliance by the Contractor with the terms, conditions, obligations, limitations, restrictions, and requirements of this Contract and such right shall extend for a period of three (3) years after termination of this Contract.

11. Notices. All notices and other communications required or permitted to be given under this Agreement by either party to the other shall be in writing and shall be sent (except as otherwise provided herein) (i) by certified mail, first class postage prepaid, return receipt requested, (ii) by guaranteed overnight delivery by a nationally recognized courier service, or (iii) by facsimile with confirmation receipt (with a copy simultaneously sent by certified mail, first class postage prepaid, return receipt requested or by overnight delivery by traditionally recognized courier service), addressed to such party as follows:

| | | |
|------------------------------|---|---|
| If to the County: | Jason Autrey, Director 1759 S. Ferdon Blvd Crestview, FL 32536 850-689-5772 jautrey@myokaloosa.com | With a copy to: County Attorney Office 1250 N. Eglin Pkwy, Suite 100 Shalimar, FL 32579 (850) 224-4070 |
| If to the Contractor: | Chris Riley C.W. Roberts Contracting, Inc. 160 Industrial Park Road Freeport, FL 32439 850-835-3500 criley@cwrcontracting.com | |

12. Assignment. Contractor shall not assign this Agreement or any part thereof, without the prior consent in writing of the County. If Contractor does, with approval, assign this Agreement or any part thereof, it shall require that its assignee be bound to it and to assume toward

Contractor all of the obligations and responsibilities that Contractor has assumed toward the County.

13. Subcontracting. Contractor shall not subcontract any services or work to be provided to County without the prior written approval of the County's Representative. The County reserves the right to accept the use of a subcontractor or to reject the selection of a particular subcontractor and to inspect all facilities of any subcontractors in order to make a determination as to the capability of the subcontractor to perform properly under this Agreement. The County's acceptance of a subcontractor shall not be unreasonably withheld. The Contractor is encouraged to seek minority and women business enterprises for participation in subcontracting opportunities. Additionally, any subcontract entered into between the Contractor and subcontractor will need to be approved by the County prior to it being entered into and said agreement shall incorporate in all required terms in accordance with local, state and Federal regulations.

14. Civil Rights. The Contractor agrees to comply with pertinent statutes, Executive Orders and such rules as are promulgated to ensure that no person shall, on the grounds of race, creed, color, national origin, sex, age, or disability be excluded from participating in any activity conducted with or benefiting from Federal assistance. This provision binds the Contractor and subcontractors from the formal quote solicitation period through the completion of the contract. This provision is in addition to that required by Title VI of the Civil Rights Act of 1964.

15. Compliance with Nondiscrimination Requirements. During the performance of this Agreement, the Contractor, for itself, its assignees, and successors in interest, agrees as follows:

- a. Compliance with Regulations: The Contractor will comply with the Title VI List of Pertinent Nondiscrimination Acts and Authorities, as they may be amended from time to time, which are herein incorporated and attached hereto as Attachment "C".
- b. Nondiscrimination: The Contractor, with regard to the work performed by it during the Agreement, will not discriminate on the grounds of race, color, or national origin in the selection and retention of subcontractors, including procurements of materials and leases of equipment. The Contractor will not participate directly or indirectly in the discrimination prohibited by the Nondiscrimination Acts and Authorities, including employment practices when the contract covers any activity, project, or program set forth in Appendix B of 49 CFR part 21.
- c. Solicitations for Subcontracts, including Procurements of Materials and Equipment: In all solicitations, either by competitive bidding or negotiation made by the Contractor for work to be performed under a subcontract, including procurements of materials, or leases of equipment, each potential subcontractor or supplier will be notified by the Contractor of the contractor's obligations under this contract and the Nondiscrimination Acts and Authorities on the grounds of race, color, or national origin.
- d. Information and Reports: The Contractor will provide all information and reports required by the Acts, the Regulations, and directives issued pursuant thereto and will

permit access to its books, records, accounts, other sources of information, and its facilities as may be determined by the County or other governmental entity to be pertinent to ascertain compliance with such Nondiscrimination Acts and Authorities and instructions. Where any information required of a contractor is in the exclusive possession of another who fails or refuses to furnish the information, the Contractor will so certify to the County or the other governmental entity, as appropriate, and will set forth what efforts it has made to obtain the information.

e. Sanctions for Noncompliance: In the event of a Contractor's noncompliance with the non-discrimination provisions of this contract, the County will impose such contract sanctions as it or another applicable state or federal governmental entity may determine to be appropriate, including, but not limited to:

- a. Withholding payments to the Contractor under the Agreement until the Contractor complies; and/or
- b. Cancelling, terminating, or suspending the Agreement, in whole or in part.

f. Incorporation of Provisions: The Contractor will include the provisions of paragraphs one through six in every subcontract, including procurements of materials and leases of equipment, unless exempt by the Acts, the Regulations, and directives issued pursuant thereto. The Contractor will take action with respect to any subcontract or procurement as the County may direct as a means of enforcing such provisions including sanctions for noncompliance. Provided, that if the Contractor becomes involved in, or is threatened with litigation by a subcontractor, or supplier because of such direction, the Contractor may request the County to enter into any litigation to protect the interests of the County. In addition, the Contractor may request the United States to enter into the litigation to protect the interests of the United States.

16. Compliance with Laws. Contractor shall secure any and all permits, licenses and approvals that may be required in order to perform the Services, shall exercise full and complete authority over Contractor's personnel, shall comply with all workers' compensation, employer's liability and all other federal, state, county, and municipal laws, ordinances, rules and regulations required of an employer performing services such as the Services, and shall make all reports and remit all withholdings or other deductions from the compensation paid to Contractor's personnel as may be required by any federal, state, county, or municipal law, ordinance, rule, or regulation.

17. Conflict of Interest. The Contractor covenants that it presently has no interest and shall not acquire any interest, directly or indirectly which could conflict in any manner or degree with the performance of the Services. The Contractor further covenants that in the performance of this Agreement, no person having any such interest shall knowingly be employed by the Contractor. The Contractor guarantees that he/she has not offered or given to any member of, delegate to the Congress of the United States, any or part of this contract or to any benefit arising therefrom.

18. Independent Contractor. Contractor enters into this Agreement as, and shall continue to be, an independent contractor. All services shall be performed only by Contractor and Contractor's employees. Under no circumstances shall Contractor or any of Contractor's employees look to the County as his/her employer, or as partner, agent or principal. Neither Contractor, nor any of Contractor's employees, shall be entitled to any benefits accorded to the County's employees, including without limitation worker's compensation, disability insurance, vacation or sick pay. Contractor shall be responsible for providing, at Contractor's expense, and in Contractor's name, unemployment, disability, worker's compensation and other insurance as well as licenses and permits usual and necessary for conducting the services to be provided under this Agreement.

19. Third Party Beneficiaries. It is specifically agreed between the parties executing this Agreement that it is not intended by any of the provisions of any part of the Agreement to create in the public or any member thereof, a third party beneficiary under this Agreement, or to authorize anyone not a party to this Agreement to maintain a suit for personal injuries or property damage pursuant to the terms or provisions of this Agreement.

20. Indemnification and Waiver of Liability. The Contractor agrees, to the fullest extent permitted by law, to defend, indemnify and hold harmless the County, its agents, representatives, officers, directors, officials and employees from and against claims, damages, losses and expenses (including but not limited to attorney's fees, court costs and costs of appellate proceedings) relating to, arising out of or resulting from the Contractor's negligent acts, errors, mistakes or omissions relating to professional Services performed under this Agreement. The Contractor's duty to defend, hold harmless and indemnify the County its agents, representatives, officers, directors, officials and employees shall arise in connection with any claim, damage, loss or expense that is attributable to bodily injury; sickness; disease; death; or injury to impairment, or destruction of tangible property including loss of use resulting therefrom, caused by any negligent acts, errors, mistakes or omissions related to Services in the performance of this Agreement including any person for whose acts, errors, mistakes or omissions the Contractor may be legally liable. The parties agree that TEN DOLLARS (\$10.00) represents specific consideration to the Contractor for the indemnification set forth herein.

The waiver by a party of any breach or default in performance shall not be deemed to constitute a waiver of any other or succeeding breach or default. The failure of the County to enforce any of the provisions hereof shall not be construed to be a waiver of the right of the County thereafter to enforce such provisions.

21. Taxes and Assessments. Contractor agrees to pay all sales, use, or other taxes, assessments and other similar charges when due now or in the future, required by any local, state or federal law, including but not limited to such taxes and assessments as may from time to time be imposed by the County in accordance with this Agreement. Contractor further agrees that it shall protect, reimburse and indemnify County from and assume all liability for its tax and assessment obligations under the terms of the Agreement.

The County is exempt from payment of Florida state sales and use taxes. The Contractor shall not be exempted from paying sales tax to its suppliers for materials used to fulfill

contractual obligations with the County, nor is the Contractor authorized to use the County's tax exemption number in securing such materials.

The Contractor shall be responsible for payment of its own and its share of its employees' payroll, payroll taxes, and benefits with respect to this Agreement.

22. Prohibition Against Contracting with Scrutinized Companies. Pursuant to Florida Statutes Section 215.4725, contracting with any entity that is listed on the Scrutinized Companies that Boycott Israel List or that is engaged in the boycott of Israel is prohibited. Contractors must certify that the company is not participating in a boycott of Israel. Any contract for goods or services of One Million Dollars (\$1,000,000) or more shall be terminated at the County's option if it is discovered that the entity submitted false documents of certification, is listed on the Scrutinized Companies with Activities in Sudan List, the Scrutinized Companies with Activities in the Iran Petroleum Energy Sector List, or has been engaged in business operations in Cuba or Syria after July 1, 2018.

Any contract entered into or renewed after July 1, 2018 shall be terminated at the County's option if the company is listed on the Scrutinized Companies that Boycott Israel List or engaged in the boycott of Israel. Submitting a false certification shall be deemed a material breach of contract. The County shall provide notice, in writing, to the Contractor of the County's determination concerning the false certification. The Contractor shall have ninety (90) days following receipt of the notice to respond in writing and demonstrate that the determination was in error. If the Contractor does not demonstrate that the County's determination of false certification was made in error, then the County shall have the right to terminate the contract and seek civil remedies pursuant to Florida Statute Section 215.4725.

23. Inconsistencies and Entire Agreement. If there is a conflict or inconsistency between any term, statement, requirement, or provision of any attachment attached hereto, any document or events referred to herein, or any document incorporated into this Agreement, the term, statement, requirement, or provision contained in this Agreement shall prevail and be given superior effect and priority over any conflicting or inconsistent term, statement, requirement or provision contained in any other document or attachment, including but not limited to Attachments "A", "B", and "C".

24. Severability. If any term or condition of this Contract shall be deemed, by a court having appropriate jurisdiction, invalid or unenforceable, the remainder of the terms and conditions of this Contract shall remain in full force and effect. This Contract shall not be more strictly construed against either party hereto by reason of the fact that one party may have drafted or prepared any or all the terms and provisions hereof.

25. Entire Agreement. This Agreement contains the entire agreement of the parties, and may be amended, waived, changed, modified, extended or rescinded only by in writing signed by the party against whom any such amendment, waiver, change, modification, extension and/or rescission is sought.

26. Representation of Authority to Contractor/Signatory. The individual signing this Agreement on behalf of Contractor represents and warrants that he or she is duly authorized and has legal capacity to execute and deliver this Agreement. The signatory represents and warrants to the County that the execution and delivery of this Agreement and the performance of the Services and obligations hereunder have been duly authorized and that the Agreement is a valid and legal agreement binding on the Contractor and enforceable in accordance with its terms.

IN WITNESS WHEREOF, the parties hereto have executed this Agreement in duplicate on the day and year first written above.

C.W. ROBERTS CONTRACTING, INC.:

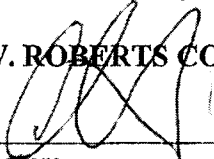

Signature
Chris Riley

Printed Name

TITLE: Vice President _____

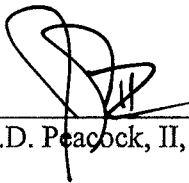

J.D. Peacock, II, Clerk

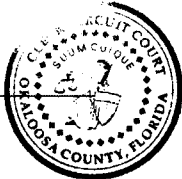

OKALOOSA COUNTY, FLORIDA

BY: 
Carolyn N. Ketchel, Chairman



Attachment "A"

ITB PW 27-21 and Bid from Vendor

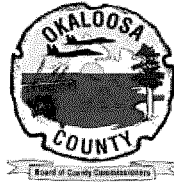

INVITATION TO BID (ITB) & RESPONDENT'S ACKNOWLEDGEMENT

ITB TITLE:
 Road Stabilization Project (Lime-rock Placement &
 Compaction)

ITB NUMBER:
 ITB PW 27-21

| | |
|--|------------------------------|
| <u>ISSUE DATE:</u> | February 22, 2021 |
| <u>LAST DAY FOR QUESTIONS:</u> | March 5, 2021 3:00 P.M. cst |
| <u>ITB OPENING DATE & TIME:</u> | March 17, 2021 3:00 P.M. cst |

NOTE: BIDS RECEIVED AFTER THE BID OPENING DATE & TIME WILL NOT BE CONSIDERED.

Okaloosa County, Florida solicits your company to submit a bid on the above referenced goods or services. All terms, specifications and conditions set forth in this ITB are incorporated into your response. A bid will not be accepted unless all conditions have been met. All bids must have an authorized signature in the space provided below. All envelopes containing sealed bids must reference the "ITB Title", "ITB Number" and the "ITB Opening Date & Time". Okaloosa County is not responsible for lost or late delivery of bids by the U.S. Postal Service or other delivery services used by the respondent. Neither faxed nor electronically submitted bids will be accepted. Bids may not be withdrawn for a period of sixty (60) days after the bid opening unless otherwise specified.

RESPONDENT ACKNOWLEDGEMENT FORM BELOW MUST BE COMPLETED, SIGNED, AND RETURNED AS PART OF YOUR BID. BIDS WILL NOT BE ACCEPTED WITHOUT THIS FORM, SIGNED BY AN AUTHORIZED AGENT OF THE RESPONDENT.

COMPANY NAME C.W. Roberts Contracting, Inc.

MAILING ADDRESS 160 Industrial Park Road

CITY, STATE, ZIP Freeport, Florida 32439

FEDERAL EMPLOYER'S IDENTIFICATION NUMBER (FEIN): 59-1683951

TELEPHONE NUMBER: 850-835-3500 EXT: 232 FAX: 850-835-3519

EMAIL: criley@cwrcontracting.com

I CERTIFY THAT THIS BID IS MADE WITHOUT PRIOR UNDERSTANDING, AGREEMENT, OR CONNECTION WITH ANY OTHER RESPONDENT SUBMITTING A BID FOR THE SAME MATERIALS, SUPPLIES, EQUIPMENT OR SERVICES, AND IS IN ALL RESPECTS FAIR AND WITHOUT COLLUSION OR FRAUD. I AGREE TO ABIDE BY ALL TERMS AND CONDITIONS OF THIS BID AND CERTIFY THAT I AM AUTHORIZED TO SIGN THIS BID FOR THE RESPONDENT.

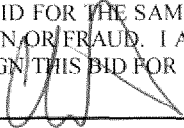
AUTHORIZED SIGNATURE:  TYPED OR PRINTED NAME Chris Riley

TITLE: Vice President DATE March 17, 2021

NOTICE TO RESPONDENTS
ITB PW 27-21

Notice is hereby given that the Board of County Commissioners of Okaloosa County, FL, will accept sealed bids until **3:00 p.m. (CST) March 17, 2021**, for the **Road Stabilization Project (Lime-rock Placement & Compaction)**.

Interested respondents desiring consideration shall provide one (1) original and two (2) copies (total of 3) of their Invitation to Bids (ITB) response with the respondent's areas of expertise identified. Submissions shall be portrait orientation, unbound, and 8 ½" x 11" where practical.

All originals must have original signatures in blue ink.

Bid documents are available for download by accessing the following sites:

<http://www.myokaloosa.com/purchasing/home>

<https://www.bidnetdirect.com/florida>

https://www.demandstar.com/supplier/bids/agency_inc/bid_list.asp?f=search&mi=2442519

At **3:00 p.m. CST March 17, 2021** all bids will be submitted will be opened and read aloud. All bids must be in sealed envelopes reflecting on the outside thereof the Respondent's name and "**Road Stabilization Project (Lime-rock Placement & Compaction)**". The County will consider all bids properly submitted at its scheduled bid opening in the **Okaloosa County Purchasing Department** located at 5479A Old Bethel Rd., Crestview, FL 32536. If delivering on the bid opening day, delivery must be in person to 5479A Old Bethel Rd, Crestview, FL 32536.

The County reserves the right to award the bid to the lowest responsive respondent and to waive any irregularity or technicality in bids received. Okaloosa County shall be the sole judge of the bid and the resulting Agreement that is in its best interest and its decision shall be final.

Any Respondent failing to mark outside of the envelope as set forth herein may not be entitled to have their bid considered.

All bids should be addressed as follows:

Road Stabilization Project (Lime-rock Placement & Compaction)

ITB PW 27-21

Okaloosa County Purchasing Department

5479A Old Bethel Rd.

Crestview FL 32536

Jeffrey Hyde
Purchasing Manager

Date

OKALOOSA COUNTY
BOARD OF COUNTY COMMISSIONERS
CAROLY N. KETCHEL, CHAIRMAN

**BID REQUIREMENTS
ITB PW 27-21
ROAD STABILIZATION
LIME-ROCK PLACEMENT & COMPACTION**

SPECIFICATIONS

Project Description

The purpose of this document is to secure quotes for the stabilization of approximately 1,314,701 square yards of dirt roads by placing approximately 327,397 tons (192,587 cubic yards) of Lime-Rock Base material. These are estimated numbers and are meant to represent the entirety of dirt (currently unstabilized) roads within the County road network.

The contract resulting from this bid shall commence upon agreement between all parties and terminate in accordance with the detailed term set forth below.

The County will provide a list of roads via task order, in order of priority, and will specify the following:

- Road name with expected limits of work (to and from)
- The minimum width to maintain on each road
- Whether the road will be mono sloped or crowned, marked areas of transition
 - Crowned road is preferred
- Location to dispose of the sand removed with be the County Baker Pit

The contractor will ensure the following:

- Load tickets for sand removed
- Load tickets of material placed (lime-rock)
- Roads remain passable/accessible by motorist during operations
- Invoices and load tickets appropriately marked with the Project # and Road Name

1.0 BACKGROUND

1.1 Okaloosa County Public Works, through the Road Division, maintains approximately 200 miles of sandy-clay “dirt” roads. Many of these roads remain in a dirt status today.

Using a sand-clay mix for repair and maintenance of dirt roads is no longer a sustainable practice. With limited to no Right-of-Way on dirt roads, a variety of challenges exist such as high, steep banks and narrow road widths. To combat this, Okaloosa County is soliciting bids to, in short, place lime-rock on pre-selected roads, shape and compact to an agreed upon cross section.

2.0 SCOPE OF WORK

2.1 The scope of work will include, but not be limited to, furnishing all materials, labor, tools, maintenance of traffic and machinery necessary to remove any loose sandy soils and uniformly apply the lime-rock base to a compacted depth of 5 inches with a 3.5 percent crown where applicable (see exhibit A). There is no annual guarantee of work volume. The contract will not preclude the County from seeking alternate contracts on a case by case basis for new construction and existing facilities.

2.2 The contractor will supply all material including, but not limited to, aggregate. The contractor will also be responsible for providing all labor, equipment, fuel, traffic control, placement of signs, resident notifications, sweeping/cleaning, construction and application procedures required for surface stabilizations.

2.3 The estimated area to be stabilized consists of approximately 1,314,701 square yards lime-rock base stabilization in Okaloosa County.

3.0 TERM

The contract resulting from this solicitation shall commence effective upon execution by both parties and extend through September 30, 2021. This contract may be renewed for two (2) additional one (1) year periods if in agreement with both parties. All work performed under this Contract shall be assigned by way of task orders. In addition, fully executed task orders shall be considered the Notice to Proceed in accordance with the terms of this Contract and will remain in effect until completed. Upon work commencement, the contractor assumes responsibility for the maintenance of the road until successful completion.

FDOT Standard Specification for Road & Bridge Construction
SECTION 230
LIMEROCK STABILIZED BASE

Description.

- Construct a base course composed of roadbed soil stabilized with lime-rock.

Materials

- Meet the lime-rock material requirements as specified in FDOT Standard Specification for Road and Bridge Construction Section 911.

Equipment

Compaction

- Select the equipment for compacting the stabilized material, except that for the final finish use a steel-wheeled roller.

Preparation of Roadbed

- Complete the area to be stabilized to the lines shown in the Plans and to a grade parallel to the finished elevation of the stabilized base, before adding the stabilizing material. Ensure that the elevation of the roadbed is such that the base will conform to the typical cross-section upon completing the work.

Incorporation of Stabilizing Material

- Spreading and Mixing: Place the lime-rock on the areas to be stabilized, and spread it uniformly to the loose depth shown in the Plans or ordered by the Engineer.

Shaping Surface:

- Shape the surface so it conforms to the grade and typical cross-section shown in the Plans after compacting

Basis of Payment:

- General: The quantities to be paid for will be the quantity, in square yards, completed and accepted

Payment will be made under:

- Lime-rock Stabilized Base - per square yard

UNPAVED ROADWAY SECTION RIGHT-OF-WAY VARIES

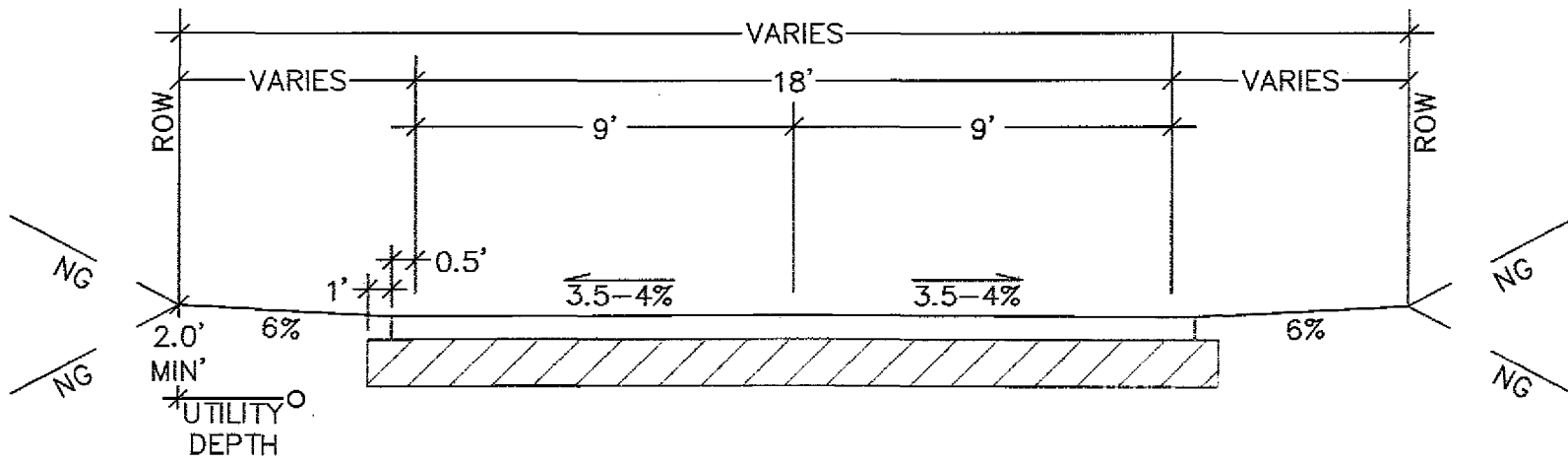

BASE 6" FDOT SECTION 200

| |
|--|
| Limerock Road (stabilize) Contracted Surtax 50 in 5 |
| Owens Road |
| Grimes Road |
| McCallum Road |
| County Line Road |
| Gilley Road |
| Bone Creek Road |
| Summertime Drive |
| Jack Stokes Road |
| Dodson Road |
| Harper Road |
| Gartman Road |
| Old Dorcas Road |
| O.B. Gatlin Road |
| Shockley Springs Road |
| Broxson Road |
| Roxy Lane |
| JB Lane |
| Calvin Carr Road |
| Olin Cotton Road |
| Henderson Lane E |
| Henderson Lane W |
| East Plympton Road |
| Walthall Road |
| Stokes Road |

GENERAL SERVICES INSURANCE REQUIREMENTS

REVISED: 01/2/2019

BONDING REQUIREMENTS

Performance and Payment bonds may be required if individual task orders exceed \$200,000.00.

CONTRACTORS INSURANCE

1. The Contractor shall not commence any work in connection with this Agreement until he has obtained all required insurance and the certificate of insurance has been approved by the Okaloosa County Risk Manager or designee.
2. All insurance policies shall be with insurers authorized to do business in the State of Florida. Insuring company is required to have a minimum rating of A, Class X in the Best Key Rating Guide published by A.M. Best & Co. Inc.
3. All insurance shall include the interest of all entities named and their respective officials, employees & volunteers of each and all other interests as may be reasonably required by Okaloosa County. The coverage afforded the Additional Insured under this policy shall be primary insurance. If the Additional Insured have other insurance that is applicable to the loss, such other insurance shall be on an excess or contingent basis. The amount of the company's liability under this policy shall not be reduced by the existence of such other insurance.
4. Where applicable the County shall be shown as an Additional Insured with a waiver of Subrogation on the Certificate of Insurance.
5. The County shall retain the right to reject all insurance policies that do not meet the requirement of this Agreement. Further, the County reserves the right to change these insurance requirements with 60-day prior written notice to the Contractor.
6. The County reserves the right at any time to require the Contractor to provide copies (redacted if necessary) of any insurance policies to document the insurance coverage specified in this Agreement.
7. Any subsidiaries used shall also be required to obtain and maintain the same insurance requirements as are being required herein of the Contractor.
8. Any exclusions or provisions in the insurance maintained by the Contractor that excludes coverage for work contemplated in this agreement shall be deemed unacceptable and shall be considered breach of contract.

WORKERS' COMPENSATION INSURANCE

1. The Contractor shall secure and maintain during the life of this Agreement Workers'

Compensation insurance for all of his employees employed for the project or any site connected with the work, including supervision, administration or management, of this project and in case any work is sublet, with the approval of the County, the Contractor shall require the Subcontractor similarly to provide Workers' Compensation insurance for all employees employed at the site of the project, and such evidence of insurance shall be furnished to the County not less than ten (10) days prior to the commencement of any and all sub-contractual Agreements which have been approved by the County.

2. Contractor must be in compliance with all applicable State and Federal workers' compensation laws, including the U.S. Longshore Harbor Workers' Act or Jones Act, if applicable.
3. No class of employee, including the Contractor himself, shall be excluded from the Workers' Compensation insurance coverage. The Workers' Compensation insurance shall also include Employer's Liability coverage.
4. Okaloosa County Board of County Commissioners shall be listed as an Additional Insured by policy endorsement on all policies applicable to this agreement except Worker's Compensation. A waiver of subrogation is required on all policies

BUSINESS AUTOMOBILE LIABILITY

Coverage must be afforded for all Owned, Hired, Scheduled, and Non-Owned vehicles for Bodily Injury and Property Damage in an amount not less than \$1,000,000 combined single limit each accident. If the contractor does not own vehicles, the contractor shall maintain coverage for Hired & Non-Owned Auto Liability, which may be satisfied by way of endorsement to the Commercial General Liability policy or separate Business Auto Policy. Contractor must maintain this insurance coverage throughout the life of this Agreement.

COMMERCIAL GENERAL LIABILITY INSURANCE

1. The Contractor shall carry Commercial General Liability insurance against all claims for Bodily Injury, Property Damage and Personal and Advertising Injury caused by the Contractor.
2. Commercial General Liability coverage shall include the following:
 - 1.) Premises & Operations Liability
 - 2.) Bodily Injury and Property Damage Liability
 - 3.) Independent Contractors Liability
 - 4.) Contractual Liability
 - 5.) Products and Completed Operations Liability
3. Contractor shall agree to keep in continuous force Commercial General Liability coverage for the length of the contract.

INSURANCE LIMITS OF LIABILITY

The insurance required shall be written for not less than the following, or greater if required by law and shall include Employer's liability with limits as prescribed in this contract:

| | <u>LIMIT</u> |
|------------------------------------|--|
| 1. Workers' Compensation | |
| 1.) State | Statutory |
| 2.) Employer's Liability | \$500,000 each accident |
| 2. Business Automobile | \$1,000,000 each accident (A combined single limit) |
| 3. Commercial General Liability | \$1,000,000 each occurrence for Bodily Injury & Property Damage \$1,000,000 each occurrence Products and completed operations |
| 4. Personal and Advertising Injury | \$1,000,000 each occurrence |

NOTICE OF CLAIMS OR LITIGATION

The Contractor agrees to report any incident or claim that results from performance of this Agreement. The County representative shall receive written notice in the form of a detailed written report describing the incident or claim within ten (10) days of the Contractor's knowledge. In the event such incident or claim involves injury and/or property damage to a third party, verbal notification shall be given the same day the Contractor becomes aware of the incident or claim followed by a written detailed report within ten (10) days of verbal notification.

INDEMNIFICATION & HOLD HARMLESS

Contractor shall indemnify and hold harmless the County, its officers and employees from liabilities, damages, losses, and costs including but not limited to reasonable attorney fees, to the extent caused by the negligence, recklessness, or wrongful conduct of the Contractor and other persons employed or utilized by the Contractor in the performance of this contract.

CERTIFICATE OF INSURANCE

1. Certificates of insurance indicating the job site and evidencing all required coverage must be submitted not less than 10 days prior to the commencement of any of the work. The certificate holder(s) shall be as follows: Okaloosa County, 5479A Old Bethel Road, Crestview, Florida, 32536.
2. The contractor shall provide a Certificate of Insurance to the County with a thirty (30) day prior written notice of cancellation; ten (10 days' prior written notice if cancellation is for nonpayment of premium).
3. In the event that the insurer is unable to accommodate the cancellation notice requirement, it shall be the responsibility of the contractor to provide the proper notice. Such notification shall be in writing by registered mail, return receipt requested, and

addressed to the Okaloosa County Purchasing Department at 5479-A Old Bethel Road, Crestview, FL 32536.

4. In the event the contract term goes beyond the expiration date of the insurance policy, the contractor shall provide the County with an updated Certificate of insurance no later than ten (10) days prior to the expiration of the insurance currently in effect. The County reserves the right to suspend the contract until this requirement is met.
5. The certificate shall indicate if coverage is provided under a claims-made or occurrence form. If any coverage is provided on a claims-made form, the certificate will show a retroactive date, which should be the same date of the initial contract or prior.
6. All certificates shall be subject to Okaloosa County's approval of adequacy of protection.
7. All deductibles or SIRs, whether approved by Okaloosa County or not, shall be the Contractor's full responsibility.
8. In no way will the entities listed as Additional Insured be responsible for, pay for, be damaged by, or limited to coverage required by this schedule due to the existence of a deductible or SIR.

GENERAL TERMS

Any type of insurance or increase of limits of liability not described above which, the Contractor required for its own protection or on account of statute shall be its own responsibility and at its own expense.

Any exclusions or provisions in the insurance maintained by the contractor that excludes coverage for work contemplated in this contract shall be deemed unacceptable and shall be considered breach of contract.

The carrying of the insurance described shall in no way be interpreted as relieving the Contractor of any responsibility under this contract.

Should the Contractor engage a subcontractor or sub-subcontractor, the same conditions will apply under this Agreement to each subcontractor and sub-subcontractor.

The Contractor hereby waives all rights of subrogation against Okaloosa County and its employees under all the foregoing policies of insurance.

EXCESS/UMBRELLA INSURANCE

The Contractor shall have the right to meet the liability insurance requirements with the purchase of an EXCESS/UMBRELLA insurance policy. In all instances, the combination of primary and EXCESS/UMBRELLA liability coverage must equal or exceed the minimum liability insurance limits stated in this Agreement.

GENERAL BID CONDITIONS

1. PRE-BID ACTIVITY -

Except as provided in this section, respondents are prohibited from contacting or lobbying the County, County Administrator, Commissioners, County staff, and Review Committee members, or any other person authorized on behalf of the County related or involved with the solicitation. All inquiries on the scope of work, specifications, additional requirements, attachments, terms and general conditions or instructions, or any issue must be directed in writing, by US mail or email to:

Okaloosa County Purchasing Department
5479A Old Bethel Road
Crestview, FL 32536
Email: dmason@myokaloosa.com
(850) 689-5960

All questions or inquiries must be received no later than the last day for questions (reference ITB & Respondent's Acknowledgement form). Any addenda or other modification to the bid documents will be issued by the County five (5) days prior to the date and time of bid closing, as written addenda, and will be posted to the following sites:

<http://www.myokaloosa.com/purchasing/home>

<https://www.bidnetdirect.com/florida>

https://www.demandstar.com/supplier/bids/agency_inc/bid_list.asp?f=search&mi=2442519

Such written addenda or modification shall be part of the bid documents and shall be binding upon each respondent. Each respondent is required to acknowledge receipt of any and all addenda in writing and submit with their bid. No respondent may rely upon any verbal modification or interpretation.

- 2. PREPARATION OF BID** – The bid form is included with the bid documents. Additional copies may be obtained from the County. The respondent shall submit bids in accordance with the public notice.

All blanks in the bid documents shall be completed by printing in ink or by typewriter in both words and numbers with the amounts extended, totaled and the bid signed. A bid price shall be indicated for each section, bid item, alternative, adjustment unit price item, and unit price item listed therein, or the words “No Bid”, “No Change”, or “Not Applicable” entered. No changes shall be made to the phraseology of the form or in the items mentioned therein. In case of any discrepancy between the written amount and the numerical figures, the written amount shall govern. Any bid which contains any omissions, erasures, alterations, additions, irregularities of any kind, or items not called for which shall in any manner fail to conform to the conditions of public notice inviting bids may be rejected.

A bid submitted by a partnership shall be executed in the partnership name and signed by a partner (whose title must appear under the signature). The official address of the partnership shall be shown below the signature.

A bid submitted by a limited liability company shall be executed in the name of the firm by a member and accompanied by evidence of authority to sign. The state of formation of the firm and the official address of the firm must be shown below the signature.

A bid submitted by an individual shall show the respondent's name and official address.

A bid submitted by a joint venture shall be executed by each joint venture in the manner indicated on the bid form. The official address of the joint venture must be shown below the signature. It is preferred that all signatures be in blue ink with the names type or printed below the signature. Okaloosa County does not accept electronic signatures.

The bid shall contain an acknowledgement of receipt of all Addenda, the numbers of which shall be filled in on the form. The address and telephone # for communications regarding the bid shall be shown.

If the respondent is an out-of-state corporation, the bid shall contain evidence of respondent's authority and qualification to do business as an out-of-state corporation in the State of Florida. A state contractor license # for the State of Florida shall also be included on the bid form. Respondent shall be licensed in accordance with the requirements of Chapter 489, Florida Statutes.

3. **INTEGRITY OF BID DOCUMENTS** - Respondents shall use the original Bid documents provided by the Purchasing Department and enter information only in the spaces where a response is requested. Respondents may use an attachment as an addendum to the Bid documents if sufficient space is not available. Any modifications or alterations to the original bid documents by the respondent, whether intentional or otherwise, will constitute grounds for rejection of a bid. Any such modification or alteration that a respondent wish to propose must be clearly stated in the respondent's response in the form of an addendum to the original bid documents.
4. **SUBMITTAL OF BID** – A bid shall be submitted no later than the date and time prescribed and at the place indicated in the advertisement or invitation to bid and shall be enclosed in an opaque sealed envelope plainly marked with the project title (and, if applicable, the designated portion of the project for which the bid is submitted), the name and address of the respondent, and shall be accompanied by the bid security and other required documents. It is the respondent's responsibility to assure that its bid is delivered at the proper time and place. Offers by telegram, facsimile, or telephone will **NOT** be accepted.

Note: Crestview is not a next day delivery site for overnight carriers.

5. **MODIFICATION & WITHDRAWAL OF BID** - A bid may be modified or withdrawn by an appropriate document duly executed in the manner that a bid must be executed and delivered to the place where bids are to be submitted prior to the date and time for the opening of bids.

If within 24 hours after bids are opened any respondent files a duly signed written notice with the County and promptly thereafter demonstrates to the reasonable satisfaction of the County that there

was a material substantial mistake in the preparation of its bid, that respondent may withdraw its bid, and the bid security may be returned. Thereafter, if the work is rebid, that respondent will be disqualified from 1) further bidding on the work, and 2) doing any work on the contract, either as a subcontractor or in any other capacity.

6. **BIDS TO REMAIN SUBJECT TO ACCEPTANCE** – All bids will remain subject to acceptance or rejection for sixty (60) calendar days after the day of the bid opening, but the County may, in its sole discretion, release any bid and return the bid security prior to the end of this period.
7. **IDENTICAL TIE BIDS** - – In cases of identical procurement responses, the award shall be determined either by lot or on the basis of factors deemed to serve the best interest of the County. In the case of the latter, there must be adequate documentation to support such a decision.
8. **CONDITIONAL & INCOMPLETE BIDS** - Okaloosa County specifically reserves the right to reject any conditional bid and bids which make it impossible to determine the true amount of the bid.
9. **PRICING** – The bid price shall include all equipment, labor, materials, freight, taxes etc. Okaloosa County reserves the right to select that bid most responsive to our needs.
10. **ADDITION/DELETION OF ITEM**– The County reserves the right to add or delete any item from this bid or resulting contract when deemed to be in the County’s best interest.
11. **SPECIFICATION EXCEPTIONS** – Specifications are based on the most current literature available. Respondent shall clearly list any change in the manufacturer’s specifications which conflict with the bid specifications. Respondent must also explain any deviation from the bid specification in writing, as a foot note on the applicable bid page and enclose a copy of the manufacturer’s specifications data detailing the changed item(s) with their bid. Failure of the respondent to comply with these provisions will result in respondents being held responsible for all costs required to bring the equipment in compliance with bid specifications.
12. **APPLICABLE LAWS & REGULATIONS** – All applicable Federal and State laws, County and municipal ordinances, orders, rules and regulations of all authorities having jurisdiction over the project shall apply to the bid throughout, and they will be deemed to be included in the contract the same as though they were written in full therein.
13. **DISQUALIFICATION OF RESPONDENTS** - Any of the following reasons may be considered as sufficient for the disqualification of a respondent and the rejection of its bid:
 - a. Submission of more than one proposal for the same work from an individual, firm or corporation under the same or different name.
 - b. Evidence that the respondent has a financial interest in the firm of another respondent for the same work.
 - c. Evidence of collusion among respondents. Participants in such collusion will receive no recognition as respondents for any future work of the County until such participant has been reinstated as a qualified respondent.

- d. Uncompleted work which in the judgment of the County might hinder or prevent the prompt completion of additional work if awarded.
- e. Failure to pay or satisfactorily settle all bills due for labor and material on former contracts in force at the time of advertisement of proposals.
- f. Default under previous contract.
- g. Listing of the respondent by any Local, State or Federal Government on its barred/suspended vendor list.

14. AWARD OF BID

- A. **Okaloosa County Review** - Okaloosa County designated Staff will review all bids and will participate in the Recommendation to Award.
- B. The County will award the bid to the responsive and responsible vendor(s) with the lowest responsive bid(s), and the County reserves the right to award the bid to the respondent submitting a responsive bid with a resulting negotiated agreement which is most advantageous and in the best interest of the County, and to reject any and all bids or to waive any irregularity or technicality in bids received. Okaloosa County shall be the sole judge of the bid and the resulting negotiated agreement that is in its best interest and its decision shall be final. The County reserves the right to award to multiple vendors.
- C. Okaloosa County reserves the right to waive any informalities or reject any and all bids, in whole or part, to utilize any applicable state contracts in lieu of or in addition to this bid and to accept the bid that in its judgment will best serve the interest of the County.
- D. Okaloosa County specifically reserves the right to reject any conditional bids and will normally reject those which made it impossible to determine the true amount of the bid. Each item must be bid separately and no attempt is to be made to tie any item or items to any other item or items.

15. PAYMENTS – The respondent shall be paid upon submission of invoices and approval of acceptance by Okaloosa County Board of County Commissioners, Finance Office, 302 N. Wilson St., #203, Crestview FL 32536, for the prices stipulated herein for articles delivered and accepted. Invoices must show Contract #.

16. DISCRIMINATION - An entity or affiliate who has been placed on the discriminatory vendor list may not submit a bid on a contract to provide goods or services to a public entity, may not submit a bid on a contract with a public entity for the construction or repair of a public building or public work, may not submit bids on leases of real property to a public entity, may not award or perform work as a contractor, supplier, subcontractor, or consultant under contract with any public entity, and may not transact business with any public entity.

17. PUBLIC ENTITY CRIME INFORMATION - Pursuant to Florida Statute 287.133, a respondent may not be awarded or perform work as a contractor, supplier, subcontractor, or consultant under a contract with any public entity; and may not transact business with any public entity in excess of

the threshold amount provided in s. 287.017 for CATEGORY TWO for a period of 36 months following the date of being placed on the convicted vendor list.

18. CONFLICT OF INTEREST - The award hereunder is subject to the provisions of Chapter 112, Florida Statutes. All respondents must disclose with their bids the name of any officer, director, or agent who is also a public officer or an employee of the Okaloosa Board of County Commissioners, or any of its agencies. Furthermore, all respondents must disclose the name of any County officer or employee who owns, directly or indirectly, an interest of five percent (5%) or more in the firm or any of its branches.

Note: For respondent's convenience, this certification form is enclosed and is made a part of the bid package.

19. REORGANIZATION OR BANKRUPTCY PROCEEDINGS – Bids will not be considered from respondents who are currently involved in official financial reorganization or bankruptcy proceedings.

20. INVESTIGATION OF RESPONDENT – The County may make such investigations, as it deems necessary to determine the stability of the respondent to perform the work and that there is no conflict of interest as it relates to the project. The respondent shall furnish to the Owner any additional information and financial data for this purpose as the County may request.

21. CONE OF SILENCE CLAUSE - The Okaloosa County Board of County Commissioners has established a solicitation silence policy (**Cone of Silence Clause**) that prohibits oral and written communication regarding all formal solicitations for goods and services (formal bids, Request for Proposals, Requests for Qualifications) issued by the Board through the County Purchasing Department. The period commences from the date of advertisement until award of contract.

All communications shall be directed to the Purchasing Department -see attached form.

Note: For respondent's convenience, this certification form is enclosed and is made a part of the bid package.

22. REVIEW OF PROCUREMENT DOCUMENTS - Per Florida Statute 119.071 (2) 2 sealed bids, proposals, or replies received by the County pursuant to a competitive solicitation are exempt from public disclosure until such time as the County provides notice of an intended decision or until 30 days after opening the bids, proposals, or final replies, whichever is earlier.

23. COMPLIANCE WITH FLORIDA STATUTE 119.0701 - The Respondent shall comply with all the provisions of section 119.0701, Florida Statutes relating to the public records which requires, among other things, that the Respondent: (a) Keep and maintain public records; (b) Provide the public with access to public records on the same terms and conditions that the public agency would provide the records; (c) ensure that public records that are exempt or confidential and exempt from public records disclosure requirements are not disclosed except as authorized by law; and (d) Meet all requirements for retaining public records and transfer, at no cost, to the public agency all public records in possession of the respondent upon termination of the contract.

24. PROTECTION OF RESIDENT WORKERS – The Okaloosa County Board of County Commissioners actively supports the Immigration and Nationality Act (INA) which includes provisions addressing employment eligibility, employment verifications, and nondiscrimination. Under the INA, employers may hire only persons who may legally work in the United States (i.e., citizens and nationals of the U.S.) and aliens authorized to work in the U.S. The employer must verify the identity and employment eligibility of anyone to be hired, which includes completing the Employment Eligibility Verifications. The respondent shall establish appropriate procedures and controls so no services or products under the Contract Documents will be performed or manufactured by any worker who is not legally eligible to perform such services or employment. Okaloosa County reserves the right to request documentation showing compliance with the requirements.

Respondents doing construction business with Okaloosa County are required to use the Federal Government Department of Homeland Security's website and use the E-Verify Employment Eligibility Verifications System to confirm eligibility of all employees to work in the United States.

25. SUSPENSION OR TERMINATION FOR CONVENIENCE - The County may, at any time, without cause, order Respondent in writing to suspend, delay or interrupt the work in whole or in part for such period of time as the County may determine, or to terminate all or a portion of the Contract for the County's convenience. Upon such termination, the Contract Price earned to the date of termination shall be paid to Respondent, but Respondent waives any claim for damages, including loss of profits arising out of or related to the early termination. Those Contract provisions which by their nature survive final acceptance shall remain in full force and effect. If the County orders a suspension, the Contract price and Contract time may be adjusted for increases in the cost and time caused by suspension, delay or interruption. No adjustment shall be made to the extent that performance is, was or would have been so suspended, delayed or interrupted by reason for which Respondent is responsible; or that an equitable adjustment is made or denied under another provision of this Contract.

26. FAILURE OF PERFORMANCE/DELIVERY - In case of default by the respondent, the County after due notice (oral or written) may procure the necessary supplies or services from other sources and hold the respondent responsible for difference in cost incurred. Continuous instances of default shall result in cancellation of the award and removal of the respondent from the bid list for duration of one (1) year, at the option of the County.

27. AUDIT - If requested, respondent shall permit the County or an authorized, independent audit agency to inspect all data and records of respondent relating to its performance and its subcontracts under this bid from the date of the award through three (3) years after the expiration of contract.

28. EQUAL EMPLOYMENT OPPORTUNITY; NON DISCRIMINATION – Respondent will not discriminate against any employee or an applicant for employment because of race, color, religion, gender, sexual orientation, national origin, age, familial status or handicap.

29. NON-COLLUSION – Respondent certifies that it has entered into no agreement to commit a fraudulent, deceitful, unlawful or wrongful act, or any act which may result in an unfair advantage over other respondents. See Florida Statute 838.22.

30. UNAUTHORIZED ALIENS/PATRIOT'S ACT – The knowing employment by respondent or its subcontractors of any alien not authorized to work by the immigration laws is prohibited and shall be a default of the contract. In the event that the respondent is notified or becomes aware of

such default, the respondent shall take steps as are necessary to terminate said employment with 24 hours of notification or actual knowledge that an alien is being employed. Respondent's failure to take such steps as are necessary to terminate the employment of any said alien within 24 hours of notification or actual knowledge that an alien is being employed shall be grounds for immediate termination of the contract. Respondent shall take all commercially reasonable precautions to ensure that it and its subcontractors do not employ persons who are not authorized to work by the immigration laws.

31. CERTIFICATE OF GOOD STANDING FOR STATE OF FLORIDA - Florida Statute 607.1501 requires that all vendors who wish to do business in the State of Florida be licensed to do business through the Department of State of Florida and be in good standing with the State of Florida. As such, to do business with Okaloosa County a vendor must provide a Certificate of Good Standing with their bid/proposal package to the County. For more information on doing business in the State of Florida, please refer to the Florida Department of State. The website to register is <https://dos.myflorida.com/sunbiz>

32. AUTHORITY TO PIGGYBACK – All respondents submitting a response to this Request for Bid agree that such response also constitutes a proposal to other Florida local governments under the same conditions, for the same contract price, and for the same effective period, should the respondent feel it is in their best interest to do so.

Each governmental agency desiring to accept this proposal and make and award thereof shall do so independently of any other governmental agency. Each agency shall be responsible for its own purchases and each shall be liable only for materials and/or services ordered and received by it, and no agency assumes any liability by virtue of the ITB. This provision in no way restricts or interferes with the right of any governmental agency to independently procure any or all items.

33. The following documents shall be submitted with the bid packet. Failure to provide required forms may result in contractor disqualification.

- A. Drug-Free Workplace Certification Form
- B. Conflict of Interest
- C. Federal E-Verify
- D. Cone of Silence Form
- E. Recycled Content Form
- F. Indemnification and Hold Harmless
- G. Prohibition to Lobbying
- H. Company Data
- I. System of Awards Management
- J. Addendum Acknowledgement
- K. Bid Sheet
- L. Anti-Collusion Statement
- M. Governmental Debarment & Suspension
- N. Vendors on Scrutinized Companies List
- O. References
- P. Certificate of Good Standing for State of Florida-see above*

DRUG-FREE WORKPLACE CERTIFICATION

THE BELOW SIGNED RESPONDENT CERTIFIES that it has implemented a drug-free workplace program. In order to have a drug-free workplace program, a business shall:

1. Publish a statement notifying employees that the unlawful manufacture, distribution, dispensing, possession, or use of a controlled substance is prohibited in the workplace and specifying the actions that will be taken against employees for violations of such prohibition.
2. Inform employees about the dangers of drug abuse in the workplace, the business's policy of maintaining a drug-free workplace, any available drug counseling, rehabilitation and employee assistance programs, and the penalties that may be imposed upon employees for drug abuse violations.
3. Give each employee engaged in providing the commodities or contractual services that are under quote a copy of the statement specified in subsection 1.
4. In the statement specified in subsection 1, notify the employees that, as a condition of working on the commodities or contractual services that are under quote, the employee will abide by the terms of the statement and will notify the employer of any conviction of, or plea of guilty or nolo contendere to, any violation of Chapter 893, Florida Statutes, or of any controlled substance law of the United States or any state, for a violation occurring in the workplace no later than five (5) days after such conviction.
5. Impose a sanction on, or require the satisfactory participation in, drug abuse assistance or rehabilitation program if such is available in employee's community, by any employee who is convicted.
6. Make a good faith effort to continue to maintain a drug-free workplace through implementation of this section.

As the person authorized to sign this statement, I certify that this firm complies fully with the above requirements.

DATE: March 17, 2021

SIGNATURE:  _____

COMPANY: C.W. Roberts Contracting, Inc.

NAME: Chris Riley
(Typed or Printed)

ADDRESS: 160 Industrial Park Road

Freeport, Florida 32439

TITLE: Vice President

E-MAIL: criley@cwrcontracting.com

PHONE #: 850-835-3500 x 232

CONFLICT OF INTEREST DISCLOSURE FORM

For purposes of determining any possible conflict of interest, all Respondents, must disclose if any Okaloosa Board of County Commissioner, employee(s), elected officials(s), or if any of its agencies is also an owner, corporate officer, agency, employee, etc., of their business.

Indicate either "yes" (a county employee, elected official, or agency is also associated with your business), or "no." If yes, give person(s) name(s) and position(s) with your business.

YES: _____ NO: ✓

| NAME(S) | POSITION(S) |
|---------|-------------|
| _____ | _____ |
| _____ | _____ |
| _____ | _____ |
| _____ | _____ |

FIRM NAME: C.W. Roberts Contracting, Inc.

BY (PRINTED): Chris Riley

BY (SIGNATURE):  _____

TITLE: Vice President

ADDRESS: 160 Industrial Park Road, Freeport, FL 32439

PHONE NO.: 850-835-3500 x 232

E-MAIL: criley@cwrcontracting.com

DATE: March 17, 2021

FEDERAL E-VERIFY COMPLIANCE CERTIFICATION

In accordance with Okaloosa County Policy and Executive Order Number 11-116 from the office of the Governor of the State of Florida, Respondent hereby certifies that the U.S. Department of Homeland Security's E-Verify system will be used to verify the employment eligibility of all new employees hired by the Respondent during the contract term, and shall expressly require any subcontractors performing work or providing services pursuant to the contact to likewise utilize the U.S. Department of Homeland Securities E-Verify system to verify the employment eligibility of all new employees hired by the subcontractor during the contract term; and shall provide documentation such verification to the COUNTY upon request.

As the person authorized to sign this statement, I certify that this company ~~complies~~ will comply fully with the above requirements.

DATE: March 17, 2021

SIGNATURE: 

COMPANY: C.W. Roberts Contracting, Inc.

NAME: Chris Riley

ADDRESS: 160 Industrial Park Road

TITLE: Vice President

Freeport, Florida 32439

E-MAIL: criley@cwrcontracting.com

PHONE NO.: 850-835-3500 x 232

CONE OF SILENCE

The Board of County Commissioners have established a solicitation silence policy (Cone of Silence) that prohibits oral and written communication regarding all formal solicitations for goods and services (ITB, RFP, ITQ, ITN, and RFQ) or other competitive solicitation between the bidder (or its agents or representatives) or other entity with the potential for a financial interest in the award (or their respective agents or representatives) regarding such competitive solicitation, and any County Commissioner or County employee, selection committee member or other persons authorized to act on behalf of the Board including the County's Architect, Engineer or their sub-consultants, or anyone designated to provide a recommendation to award a particular contract, other than the Purchasing Department Staff.

The period commences from the time of advertisement until contract award.

Any information thought to affect the committee or staff recommendation submitted after bids are due, should be directed to the Purchasing Manager or an appointed representative. It shall be the Purchasing Manager's decision whether to consider this information in the decision process.

Any violation of this policy shall be grounds to disqualify the Respondent from consideration during the selection process.

All Respondents must agree to comply with this policy by signing the following statement and including it with their submittal.

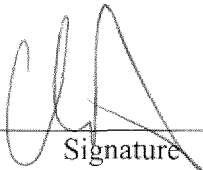
I  _____ representing C.W. Roberts Contracting, Inc.
Signature Company Name

On this 17th day of March 2021, I hereby agree to abide by the County's "Cone of Silence Clause" and understand violation of this policy shall result in disqualification of my proposal/submittal.

RECYCLED CONTENT FORM

RECYCLED CONTENT INFORMATION

1. Is the material in the above: Virgin N/A or Recycled N/A (Check the applicable blank). If recycled, what percentage N/A %.

Product Description: N/A

2. Is your product packaged and/or shipped in material containing recycled content?

Yes N/A No N/A

Specify: N/A

3. Is your product recyclable after it has reached its intended end use?

Yes N/A No N/A

Specify: N/A

The above is not applicable if there is only a personal service involved with no product involvement.

Name of Proposer: C.W. Roberts Contracting, Inc.

E-Mail: criley@cwrcontracting.com

INDEMNIFICATION AND HOLD HARMLESS

Respondent shall indemnify and hold harmless the County, its officers and employees from liabilities, damages, losses, and costs including but not limited to reasonable attorney fees, to the extent caused by the negligence, recklessness, or intentional wrongful conduct of the Respondent and other persons employed or utilized by the Respondent in the performance of this Agreement.

C.W. Roberts Contracting, Inc.
Respondent's Company Name

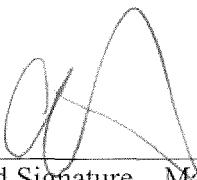

Authorized Signature – Manual

160 Industrial Park Road, Freeport, FL 32439
Physical Address

Chris Riley

Authorized Signature – Typed

160 Industrial Park Road, Freeport, FL 32439
Mailing Address

Vice President

Title

850-835-3500 x 232
Phone Number

850-835-3519

FAX Number

850-527-4126
Cellular Number

850-549-1122; 850-974-1525

After-Hours Number(s)

March 17, 2021
Date

criley@cwrcontracting.com

Email

LOBBYING - 31 U.S.C. 1352, 49 CFR Part 19, 49 CFR Part 20

APPENDIX A, 49 CFR PART 20--CERTIFICATION REGARDING LOBBYING

Certification for Contracts, Grants, Loans, and Cooperative Agreements

(To be submitted with each bid or offer exceeding \$100,000)

The undersigned [Contractor] certifies, to the best of his or her knowledge and belief, that:

1. No Federal appropriated funds have been paid or will be paid, by or on behalf of the undersigned, to any person for influencing or attempting to influence an officer or employee of an agency, a Member of Congress, an officer or employee of Congress, or an employee of a Member of Congress in connection with the awarding of any Federal contract, the making of any Federal grant, the making of any Federal loan, the entering into of any cooperative agreement, and the extension, continuation, renewal, amendment, or modification of any Federal contract, grant, loan, or cooperative agreement.
2. If any funds other than Federal appropriated funds have been paid or will be paid to any person for making lobbying contacts to an officer or employee of any agency, a Member of Congress, an officer or employee of Congress, or an employee of a Member of Congress in connection with this Federal contract, grant, loan, or cooperative agreement, the undersigned shall complete and submit Standard Form--LLL, "Disclosure Form to Report Lobbying," in accordance with its instructions [as amended by "Government wide Guidance for New Restrictions on Lobbying," 61 Fed. Reg. 1413 (1/19/96). Note: Language in paragraph (2) herein has been modified in accordance with Section 10 of the Lobbying Disclosure Act of 1995 (P.L. 104-65, to be codified at 2 U.S.C. 1601, *et seq.*)]
3. The undersigned shall require that the language of this certification be included in the award documents for all sub-awards at all tiers (including subcontracts, sub-grants, and contracts under grants, loans, and cooperative agreements) and that all sub-recipients shall certify and disclose accordingly.

This certification is a material representation of fact upon which reliance was placed when this transaction was made or entered into. Submission of this certification is a prerequisite for making or entering into this transaction imposed by 31, U.S.C. § 1352 (as amended by the Lobbying Disclosure Act of 1995). Any person who fails to file the required certification shall be subject to a civil penalty of not less than \$10,000 and not more than \$100,000 for each such failure.

[Note: Pursuant to 31 U.S.C. § 1352(c)(1) -(2)(A), any person who makes a prohibited expenditure or fails to file or amend a required certification or disclosure form shall be subject to a civil penalty of not less than \$10,000 and not more than \$100,000 for each such expenditure or failure.]

The Contractor, C.W. Roberts Contracting, Inc., certifies or affirms the truthfulness and accuracy of each statement of its certification and disclosure, if any. In addition, the Contractor understands and agrees that the provisions of 31 U.S.C. A 3801, *et seq.*, apply to this certification and disclosure, if any.

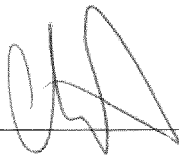

Chris Riley - Vice President

Signature of Contractor's Authorized Official

Name and Title of Contractor's Authorized Official

March 17, 2021

Date

COMPANY DATA

Respondent's Company Name: C.W. Roberts Contracting, Inc.

Physical Address & Phone #: 160 Industrial Park Road

Freeport, Florida 32439

850-835-3500

Contact Person (Typed-Printed): Chris Riley

Phone #: 850-835-3500

Cell #: 850-527-4126

Email: criley@cwrcontracting.com

Federal ID or SS #: 59-1683951

Respondent's License #: CGC1505785, CUC1225175

Respondent's DUNS #: 09 459 3589

Fax #: 850-835-3519

Emergency #'s After Hours,
Weekends & Holidays: 850-549-1122 Ed Miller; 850-974-1525 Bayn Powell;
850-545-0191 Tim Kruger; 850-533-6809 Michael Gilley

SYSTEM FOR AWARD MANAGEMENT (OCT 2016)

(a) Definitions. As used in this provision.

“Electronic Funds Transfer (EFT) indicator” means a four-character suffix to the unique entity identifier. The suffix is assigned at the discretion of the commercial, nonprofit, or Government entity to establish additional System for Award Management records for identifying alternative EFT accounts (see subpart 32.11) for the same entity.

“Registered in the System for Award Management (SAM) database” means that.

(1) The Offeror has entered all mandatory information, including the unique entity identifier and the EFT indicator, if applicable, the Commercial and Government Entity (CAGE) code, as well as data required by the Federal Funding Accountability and Transparency Act of 2006 (see subpart 4.14) into the SAM database;

(2) The offeror has completed the Core, Assertions, and Representations and Certifications, and Points of Contact sections of the registration in the SAM database;

(3) The Government has validated all mandatory data fields, to include validation of the Taxpayer Identification Number (TIN) with the Internal Revenue Service (IRS). The offeror will be required to provide consent for TIN validation to the Government as a part of the SAM registration process; and

(4) The Government has marked the record “Active”.

“Unique entity identifier” means a number or other identifier used to identify a specific commercial, nonprofit, or Government entity. See www.sam.gov for the designated entity for establishing unique entity identifiers.

(b)(1) By submission of an offer, the offeror acknowledges the requirement that a prospective awardee shall be registered in the SAM database prior to award, during performance, and through final payment of any contract, basic agreement, basic ordering agreement, or blanket purchasing agreement resulting from this solicitation.

(2) The Offeror shall enter, in the block with its name and address on the cover page of its offer, the annotation “Unique Entity Identifier” followed by the unique entity identifier that identifies the Offeror’s name and address exactly as stated in the offer. The Offeror also shall enter its EFT indicator, if applicable. The unique entity identifier will be used by the Contracting Officer to verify that the Offeror is registered in the SAM database.

(c) If the Offeror does not have a unique entity identifier, it should contact the entity designated at www.sam.gov for establishment of the unique entity identifier directly to obtain one. The Offeror should be prepared to provide the following information:

- (1) Company legal business name.
- (2) Tradestyle, doing business, or other name by which your entity is commonly recognized.
- (3) Company Physical Street Address, City, State, and Zip Code.
- (4) Company Mailing Address, City, State and Zip Code (if separate from physical).
- (5) Company telephone number.
- (6) Date the company was started.
- (7) Number of employees at your location.
- (8) Chief executive officer/key manager.

(9) Line of business (industry).

(10) Company Headquarters name and address (reporting relationship within your entity).

(d) If the Offeror does not become registered in the SAM database in the time prescribed by the Contracting Officer, the Contracting Officer will proceed to award to the next otherwise successful registered Offeror.

(e) Processing time, which normally takes 48 hours, should be taken into consideration when registering. Offerors who are not registered should consider applying for registration immediately upon receipt of this solicitation.

(f) Offerors may obtain information on registration at <https://www.acquisition.gov> .

Offerors SAM information:

Entity Name: C.W. Roberts Contracting, Inc.

Entity Address: criley@cwrcontracting.com

Duns Number: 09 459 3589

CAGE Code: OCHA7

**ADDENDUM ACKNOWLEDGEMENT
ITB PW 27-21**

Acknowledgment is hereby made of the following addenda (identified by number) received since issuance of solicitation:

ADDENDUM NO.

DATE

#01 - Q&A

03/09/2021

NOTE: Prior to submitting the response to this solicitation, it is the responsibility of the Respondent to confirm if any addenda have been issued. If such addenda have been issued, acknowledge receipt by noting number(s) and date(s) above.

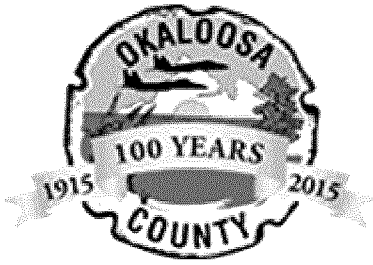

ADDENDUM 1

March 9, 2021

ITB PW 27-21

Road Stabilization Project (Lime-rock Placement & Compaction)

This addendum is being issued to provide the answers to questions submitted by the vendors.

Questions and Responses:

1. What volume of lime-rock does Okaloosa County expect to be delivered during the base year (Date of Bid Submission through September 30, 2021, per the RFP) and each additional one (1) year period? We anticipate approximately 15-20 miles of roadway to be stabilized over a course of 2 years.
 - The current demand for lime-rock is high and the small quantity of available lime-rock pits/producers are limited in their production/sales. We are currently experiencing contract delays and time extensions due to lime-rock availability. It is unrealistic to expect that 327,397 tons of Lime-Rock base shall be furnished in this time frame. 327,397 is the rough tonnage required to cover ALL current dirt roads. We are not expecting that in the time allotted.
2. Would Okaloosa County be willing to accept alternative base options if lime-rock is unavailable? No, FDOT approved lime-rock is the desired material
3. What is the address for the “County Baker Pit?” There is no physical address, but the parcel ID is 17-3N-24-0000-0004-0020, located about 2000’ west of Hwy 189 in Baker on Keyser Mill Road
4. Are the roads in the “Limerock Road (stabilize) Contracted Surtax 50 in 5” sheet the roadways that are intended to received lime-rock base? Are there any additional roads not listed in this sheet that are to receive lime-rock? The county has approximately 170 miles of dirt roads that need to be stabilized with lime-rock. This list is the starting point.
5. The Project Description, Scope of Work, and Typical Section in the ITB have discrepancies.
 - The Project Description calls for 1,314,701 square yards of roadway with 327,397 Tons of lime-rock to be installed. This is an average spread of 498 lbs/sy or 4.15” compacted thickness.
 - The Scope of Work then specifies a compacted depth of 5 inches, which is approximately 600 lbs/sy.
 - Then the typical section illustrates a 6 inch compacted thickness. Which is approximately 720 lbs/sy.
 - What is the specific compacted thickness to be? Compacted thickness should be 5”

6. How will individual Task Order time durations be determined? Task orders will be issued and expected to continue until successful completion OR September 30, 202* (county fiscal years end)
7. Will bid item #4 be a unit of square yard? Yes
8. What will be the compaction requirements for the lime rock base? There are no density requirements, practical compaction/rolling.
9. Will there be any compaction requirements for the existing road before the lime rock is placed? No. excess sand will need to be removed so lime-rock can conform to the cross-section
10. Will proctors and testing be required by an independent testing lab? If so what will be the frequency of the testing? Material certification will be required, but random testing will not be required by the contractor.
11. Will the contractor be required to fill and grade the adjacent shoulders to the finish elevation of the lime rock? Work outside the approved “roadway” will be taken care of by the County.
12. What is the available funding for this project? Currently stands at \$2M a year. Number of years depends on proposed cost.
13. Can you attend the bid opening in person? For those who cannot, will there be a conference line to dial into? Yes, you can attend in person, Purchasing will not have a conference line to dial into.
14. Is the recycled content form applicable to this bid? No, you just need to put NA
15. Is there an overview map available to show all of the roads? There is, and the vendor awarded will be given a task will all roads to be treated. All roads are north of the shoal river in rural areas near Baker, Holt, Blackman, and Laurel Hill.
16. How many roads / tons of material are expected for the first year contract that ends in September? Completely depends on the proposed bid, time and start date will be considered. There is no “minimum expected”
17. Is seeding / restoration required for the ditches? Ditches/ditch work will be completed by the County. Scope of services is focused on the driving surface of the road.
18. Can you please confirm that there is not a requirement to box out the road before installing the subbase material? I assume this is referring to subbing the road. No, we want to remove the excess accumulation of sand to place the limerock on a surface that can conform to the typical section provided. Please note that it is a typical and most areas will resemble it, but there will be some areas that just simple need a mono slope. County staff will be working with the contractor closely.

The bid opening date remains March 17, 2021 at 3:00 P.M. CST.

BID RESPONSE
ITB PW 27-21
ROAD STABILIZATION: LIME-ROCK PLACEMENT & COMPACTION

| | | |
|----|---|--------------|
| 1. | Cost per cubic yard of sand removed | \$ 13.60 |
| 2. | Cost per cubic yard of sand removed and dropped at County Borrow Pits | \$ 19.00 |
| 3. | Cost per square yard of placed (loose) lime-rock | \$ 9.80 |
| 4. | Cost of compaction/shaping to meet required cross-section | \$ 1.20 |
| 5. | Mobilization per task order | \$ 24,500.00 |

Date Submitted: March 17, 2021
Submitted By: C.W. Roberts Contracting, Inc.

ANTI-COLLUSION STATEMENT: The below signed bidder has not divulged to, discussed or compared his bid with other bidders and has not **colluded with any other bidder or parties to bid whatever.** Note: No premiums, rebates, or gratuities permitted either with, prior to, or after any delivery of materials. Any such violation will result in the cancellation and/or return of material (as applicable) and the removal from bid list(s).

C.W. Roberts Contracting, Inc.
Respondent's Company Name

160 Industrial Park Road
Address

Freeport, Florida 32439
City/State/Zip

850-835-3500
Phone #

59-1683951
Federal ID # or SS #

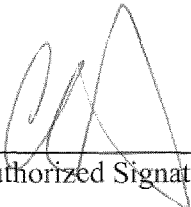
Authorized Signature – Manual

Chris Riley
Authorized Signature – Typed

Vice President
Title

850-835-3519
Fax #

Government Debarment & Suspension

Instructions

1. By signing and submitting this form, the prospective lower tier participant is providing the certification set out in accordance with these instructions.
2. The certification in this clause is a material representation of fact upon which reliance was placed when this transaction was entered into. If it is later determined that the prospective lower tier participant knowingly rendered an erroneous certification, in addition to other remedies available to the Federal Government, the department or agency with which this transaction originated may pursue available remedies, including suspension or debarment.
3. The prospective lower tier participant shall provide immediate written notice to the person(s) to which this proposal is submitted if at any time the prospective lower tier participant learns that its certification was erroneous when submitted or has become erroneous by reason of changed circumstances.
4. The terms "covered transaction," "debarred," "suspended," "ineligible," "lower tier covered transaction," "participant," "person," "primary covered transaction," "principal," "proposal," and "voluntarily excluded," as used in this clause, have the meanings set out in the Definitions and Coverage sections of the rules implementing Executive Orders 12549, at Subpart C of OMB 2 C.F.R. Part 180 and 3000.332. You may contact the department or agency to which this proposal is being submitted for assistance in obtaining a copy of those regulations.
5. The prospective lower tier participant agrees by submitting this form that, should the proposed covered transaction be entered into, it shall not knowingly enter into any lower tier covered transaction with a person who is debarred, suspended, declared ineligible, or voluntarily excluded from participation in this covered transaction, unless authorized by the department or agency with which this transaction originated.
6. The prospective lower tier participant further agrees by submitting this form that it will include this clause titled "Certification Regarding Debarment, Suspension, Ineligibility and Voluntary Exclusion - Lower Tier Covered Transactions," without modification, in all lower tier covered transactions and in all solicitations for lower tier covered transactions.
7. A participant in a covered transaction may rely upon a certification of a prospective participant in a lower tier covered transaction that is not debarred, suspended, ineligible, or voluntarily excluded from the covered transaction, unless it knows that the certification is erroneous. A participant may decide the method and frequency by which it determines the eligibility of its principals. Each participant may, but is not required to, check the System for Award Management (SAM) database.
8. Nothing contained in the foregoing shall be construed to require establishment of a system of records in order to render in good faith the certification required by this clause. The knowledge and information of a participant is not required to exceed that which is normally possessed by a prudent person in the ordinary course of business dealings.
9. Except for transactions authorized under paragraph (5) of these instructions, if a participant in a covered transaction knowingly enters into a lower tier covered transaction with a person who is suspended, debarred, ineligible, or voluntarily excluded from participation in this transaction, in addition to other remedies available to the Federal Government, the department or agency with which this transaction originated may pursue available remedies, including suspension and/or debarment.

**Certification Regarding Debarment, Suspension,
Ineligibility and Voluntary Exclusion
Lower Tier Covered Transactions**

The following statement is made in accordance with the Privacy Act of 1974 (5 U.S.C. § 552(a), as amended). This certification is required by the regulations implementing Executive Orders 12549, Debarment and Suspension, and OMB 2 C.F.R. Part 180, Participants' responsibilities. The regulations were amended and published on August 31, 2005, in 70 Fed. Reg. 51865-51880.

[READ INSTRUCTIONS ON PREVIOUS PAGE BEFORE COMPLETING CERTIFICATION]

1. The prospective lower tier participant certifies, by submission of this proposal, that neither it nor its principals is presently debarred, suspended, proposed for debarment, declared ineligible, or voluntarily excluded from participation in this transaction by any Federal or State department or agency;

2. Where the prospective lower tier participant is unable to certify to any of the statements in this certification, such prospective participant shall attach an explanation to this proposal

Printed Name and Title of Authorized Representative

Chris Riley - Vice President

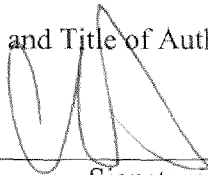

Signature

March 19, 2021

Date

VENDORS ON SCRUTINIZED COMPANIES LISTS

By executing this Certificate, the bid proposer, certifies that it is not: (1) listed on the Scrutinized Companies that Boycott Israel List, created pursuant to section 215.4725, Florida Statutes, (2) engaged in a boycott of Israel, (3) listed on the Scrutinized Companies with Activities in Sudan List or the Scrutinized Companies with Activities in the Iran Petroleum Energy Sector List, created pursuant to section 215.473, Florida Statutes, or (4) engaged in business operations in Cuba or Syria. Pursuant to section 287.135(5), Florida Statutes, the County may disqualify the bid proper immediately or immediately terminate any agreement entered into for cause if the bid proposer is found to have submitted a false certification as to the above or if the Contractor is placed on the Scrutinized Companies that Boycott Israel List, is engaged in a boycott of Israel, has been placed on the Scrutinized Companies with Activities in Sudan List or the Scrutinized Companies with Activities in the Iran Petroleum Energy Sector List, or has been engaged in business operations in Cuba or Syria, during the term of the Agreement. If the County determines that the bid proposer has submitted a false certification, the County will provide written notice to the bid proposer. Unless the bid proposer demonstrates in writing, within 90 calendar days of receipt of the notice, that the County's determination of false certification was made in error, the County shall bring a civil action against the bid proposer. If the County's determination is upheld, a civil penalty shall apply, and the bid proposer will be ineligible to bid on any Agreement with a Florida agency or local governmental entity for three years after the date of County's determination of false certification by bid proposer.

As the person authorized to sign this statement, I certify that this firm complies fully with the above requirements.

DATE: March 17, 2021

SIGNATURE: 

COMPANY: C.W. Roberts Contracting, Inc.

NAME: Chris Riley
(Typed or Printed)

ADDRESS: 160 Industrial Park Road
Freeport, Florida 32439

TITLE: Vice President

E-MAIL: criley@cwrcontracting.com

PHONE NO.: 850-835-3500

LIST OF REFERENCES

1. Owner's Name and Address: Department of the Air Force - Eglin AFB
Eglin IDIQ Contract
Contact Person: Scotty McCraney Telephone # (850) 850-883-1353
Email: scotty.mccraney@us.af.mil

2. Owner's Name and Address: Walton County Florida
CR883 Improvements
Contact Person: Clyde Cooper Telephone # (850) 814-9432
Email: Claude.Cooper@exp.com

3. Owner's Name and Address: Florida Department of Transportation
SR20 SR81 Walton County - T3695
Contact Person: Eric Broome Telephone # (850) 850-902-8459
Email: ebroome@ssr-inc.com

4. Owner's Name and Address: Florida Department of Transportation
Henderson Beach/Commons Drive Signal & Roadway Improvements
Contact Person: Brad Brenner Telephone # (850) 477-7485
Email: brad.brenner@volkert.com

5. Owner's Name and Address: Okaloosa County Florida
PJ Adams Parkway Widening
Contract Person: Asa Hunt Telephone # (850) 490-3362
Email: Asa.Hunt@mottmac.com

State of Florida

Department of State

I certify from the records of this office that C. W. ROBERTS CONTRACTING, INCORPORATED is a corporation organized under the laws of the State of Florida, filed on January 19, 1976.

The document number of this corporation is 493846.

I further certify that said corporation has paid all fees due this office through December 31, 2021, that its most recent annual report/uniform business report was filed on January 4, 2021, and that its status is active.

I further certify that said corporation has not filed Articles of Dissolution.

*Given under my hand and the
Great Seal of the State of Florida
at Tallahassee, the Capital, this
the Fourth day of January, 2021*



Ronald R. Bruce
Secretary of State

Tracking Number: 2899484244CC

To authenticate this certificate, visit the following site, enter this number, and then follow the instructions displayed.

<https://services.sunbiz.org/Filings/CertificateOfStatus/CertificateAuthentication>



ADDENDUM 1

March 9, 2021

ITB PW 27-21

Road Stabilization Project (Lime-rock Placement & Compaction)

This addendum is being issued to provide the answers to questions submitted by the vendors.

Questions and Responses:

1. What volume of lime-rock does Okaloosa County expect to be delivered during the base year (Date of Bid Submission through September 30, 2021, per the RFP) and each additional one (1) year period? We anticipate approximately 15-20 miles of roadway to be stabilized over a course of 2 years.
 - o The current demand for lime-rock is high and the small quantity of available lime-rock pits/producers are limited in their production/sales. We are currently experiencing contract delays and time extensions due to lime-rock availability. It is unrealistic to expect that 327,397 tons of Lime-Rock base shall be furnished in this time frame. 327,397 is the rough tonnage required to cover ALL current dirt roads. We are not expecting that in the time allotted.
2. Would Okaloosa County be willing to accept alternative base options if lime-rock is unavailable? No, FDOT approved lime-rock is the desired material
3. What is the address for the "County Baker Pit?" There is no physical address, but the parcel ID is 17-3N-24-0000-0004-0020, located about 2000' west of Hwy 189 in Baker on Keyser Mill Road
4. Are the roads in the "Limerock Road (stabilize) Contracted Surtax 50 in 5" sheet the roadways that are intended to received lime-rock base? Are there any additional roads not listed in this sheet that are to receive lime-rock? The county has approximately 170 miles of dirt roads that need to be stabilized with lime-rock. This list is the starting point.
5. The Project Description, Scope of Work, and Typical Section in the ITB have discrepancies.
 - o The Project Description calls for 1,314,701 square yards of roadway with 327,397 Tons of lime-rock to be installed. This is an average spread of 498 lbs/sy or 4.15" compacted thickness.
 - o The Scope of Work then specifies a compacted depth of 5 inches, which is approximately 600 lbs/sy.
 - o Then the typical section illustrates a 6 inch compacted thickness. Which is approximately 720 lbs/sy.
 - What is the specific compacted thickness to be? Compacted thickness should be 5"

6. How will individual Task Order time durations be determined? Task orders will be issued and expected to continue until successful completion OR September 30, 202* (county fiscal years end)
7. Will bid item #4 be a unit of square yard? Yes
8. What will be the compaction requirements for the lime rock base? There are no density requirements, practical compaction/rolling.
9. Will there be any compaction requirements for the existing road before the lime rock is placed? No. excess sand will need to be removed so lime-rock can conform to the cross-section
10. Will proctors and testing be required by an independent testing lab? If so what will be the frequency of the testing? Material certification will be required, but random testing will not be required by the contractor.
11. Will the contractor be required to fill and grade the adjacent shoulders to the finish elevation of the lime rock? Work outside the approved "roadway" will be taken care of by the County.
12. What is the available funding for this project? Currently stands at \$2M a year. Number of years depends on proposed cost.
13. Can you attend the bid opening in person? For those who cannot, will there be a conference line to dial into? Yes, you can attend in person, Purchasing will not have a conference line to dial into.
14. Is the recycled content form applicable to this bid? No, you just need to put NA
15. Is there an overview map available to show all of the roads? There is, and the vendor awarded will be given a task will all roads to be treated. All roads are north of the shoal river in rural areas near Baker, Holt, Blackman, and Laurel Hill.
16. How many roads / tons of material are expected for the first year contract that ends in September? Completely depends on the proposed bid, time and start date will be considered. There is no "minimum expected"
17. Is seeding / restoration required for the ditches? Ditches/ditch work will be completed by the County. Scope of services is focused on the driving surface of the road.
18. Can you please confirm that there is not a requirement to box out the road before installing the subbase material? I assume this is referring to subbing the road. No, we want to remove the excess accumulation of sand to place the limerock on a surface that can conform to the typical section provided. Please note that it is a typical and most areas will resemble it, but there will be some areas that just simple need a mono slope. County staff will be working with the contractor closely.

The bid opening date remains March 17, 2021 at 3:00 P.M. CST.

Attachment "B"
Insurance Requirements

GENERAL SERVICES INSURANCE REQUIREMENTS

REVISED: 01/2/2019

CONTRACTORS INSURANCE

1. The Contractor shall not commence any work in connection with this Agreement until he has obtained all required insurance and the certificate of insurance has been approved by the Okaloosa County Risk Manager or designee.
2. All insurance policies shall be with insurers authorized to do business in the State of Florida. Insuring company is required to have a minimum rating of A, Class X in the Best Key Rating Guide published by A.M. Best & Co. Inc.
3. All insurance shall include the interest of all entities named and their respective officials, employees & volunteers of each and all other interests as may be reasonably required by Okaloosa County. The coverage afforded the Additional Insured under this policy shall be primary insurance. If the Additional Insured have other insurance that is applicable to the loss, such other insurance shall be on an excess or contingent basis. The amount of the company's liability under this policy shall not be reduced by the existence of such other insurance.
4. Where applicable the County shall be shown as an Additional Insured with a waiver of Subrogation on the Certificate of Insurance on all Workers Compensation Clauses.
5. The County shall retain the right to reject all insurance policies that do not meet the requirement of this Agreement. Further, the County reserves the right to change these insurance requirements with 60-day prior written notice to the Contractor.
6. The County reserves the right at any time to require the Contractor to provide copies (redacted if necessary) of any insurance policies to document the insurance coverage specified in this Agreement.
7. Any subsidiaries used shall also be required to obtain and maintain the same insurance requirements as are being required herein of the Contractor.

8. Any exclusions or provisions in the insurance maintained by the Contractor that excludes coverage for work contemplated in this agreement shall be deemed unacceptable and shall be considered breach of contract.

WORKERS' COMPENSATION INSURANCE

1. The Contractor shall secure and maintain during the life of this Agreement Workers' Compensation insurance for all of his employees employed for the project or any site connected with the work, including supervision, administration or management, of this project and in case any work is sublet, with the approval of the County, the Contractor shall require the Subcontractor similarly to provide Workers' Compensation insurance for all employees employed at the site of the project, and such evidence of insurance shall be furnished to the County not less than ten (10) days prior to the commencement of any and all sub-contractual Agreements which have been approved by the County.
2. Contractor must be in compliance with all applicable State and Federal workers' compensation laws, including the U.S. Longshore Harbor Workers' Act or Jones Act, if applicable.
3. No class of employee, including the Contractor himself, shall be excluded from the Workers' Compensation insurance coverage. The Workers' Compensation insurance shall also include Employer's Liability coverage.
4. Okaloosa County Board of County Commissioners shall be listed as an Additional Insured by policy endorsement on all policies applicable to this agreement except Worker's Compensation. A waiver of subrogation is required on all policies

BUSINESS AUTOMOBILE LIABILITY

Coverage must be afforded for all Owned, Hired, Scheduled, and Non-Owned vehicles for Bodily Injury and Property Damage in an amount not less than \$1,000,000 combined single limit each accident. If the contractor does not own vehicles, the contractor shall maintain coverage for Hired & Non-Owned Auto Liability, which may be satisfied by way of endorsement to the Commercial General Liability policy or separate Business Auto Policy. Contractor must maintain this insurance coverage throughout the life of this Agreement.

COMMERCIAL GENERAL LIABILITY INSURANCE

1. The Contractor shall carry Commercial General Liability insurance against all claims for Bodily Injury, Property Damage and Personal and Advertising Injury caused by the Contractor.
2. Commercial General Liability coverage shall include the following:

- 1.) Premises & Operations Liability
 - 2.) Bodily Injury and Property Damage Liability
 - 3.) Independent Contractors Liability
 - 4.) Contractual Liability
 - 5.) Products and Completed Operations Liability
3. Contractor shall agree to keep in continuous force Commercial General Liability coverage for the length of the contract.

INSURANCE LIMITS OF LIABILITY

The insurance required shall be written for not less than the following, or greater if required by law and shall include Employer’s liability with limits as prescribed in this contract:

| | | <u>LIMIT</u> |
|----|---------------------------------|--|
| 1. | Workers’ Compensation | |
| | 1.) State | Statutory |
| | 2.) Employer’s Liability | \$500,000 each accident |
| 2. | Business Automobile | \$1,000,000 each accident (A combined single limit) |
| 3. | Commercial General Liability | \$1,000,000 each occurrence for Bodily Injury & Property Damage \$1,000,000 each occurrence Products and completed operations |
| 4. | Personal and Advertising Injury | \$1,000,000 each occurrence |

NOTICE OF CLAIMS OR LITIGATION

The Contractor agrees to report any incident or claim that results from performance of this Agreement. The County representative shall receive written notice in the form of a detailed written report describing the incident or claim within ten (10) days of the Contractor’s knowledge. In the event such incident or claim involves injury and/or property damage to a third party, verbal notification shall be given the same day the Contractor becomes aware of the incident or claim followed by a written detailed report within ten (10) days of verbal notification.

INDEMNIFICATION & HOLD HARMLESS

Contractor shall indemnify and hold harmless the County, its officers and employees from liabilities, damages, losses, and costs including but not limited to reasonable attorney fees,

to the extent caused by the negligence, recklessness, or wrongful conduct of the Contractor and other persons employed or utilized by the Contractor in the performance of this contract.

CERTIFICATE OF INSURANCE

1. Certificates of insurance indicating the job site and evidencing all required coverage must be submitted not less than 10 days prior to the commencement of any of the work. The certificate holder(s) shall be as follows: Okaloosa County Board of County Commissioners, 302 N. Wilson St., Crestview, Florida, 32536.
2. The contractor shall provide a Certificate of Insurance to the County with a thirty (30) day prior written notice of cancellation; ten (10 days' prior written notice if cancellation is for nonpayment of premium).
3. In the event that the insurer is unable to accommodate the cancellation notice requirement, it shall be the responsibility of the contractor to provide the proper notice. Such notification shall be in writing by registered mail, return receipt requested, and addressed to the Okaloosa County Purchasing Department at 5479-A Old Bethel Road, Crestview, FL 32536.
4. In the event the contract term goes beyond the expiration date of the insurance policy, the contractor shall provide the County with an updated Certificate of insurance no later than ten (10) days prior to the expiration of the insurance currently in effect. The County reserves the right to suspend the contract until this requirement is met.
5. The certificate shall indicate if coverage is provided under a claims-made or occurrence form. If any coverage is provided on a claims-made form, the certificate will show a retroactive date, which should be the same date of the initial contract or prior.
6. All certificates shall be subject to Okaloosa County's approval of adequacy of protection.
7. All deductibles or SIRs, whether approved by Okaloosa County or not, shall be the Contractor's full responsibility.
8. In no way will the entities listed as Additional Insured be responsible for, pay for, be damaged by, or limited to coverage required by this schedule due to the existence of a deductible or SIR.

GENERAL TERMS

Any type of insurance or increase of limits of liability not described above which, the Contractor required for its own protection or on account of statute shall be its own responsibility and at its own expense.

Any exclusions or provisions in the insurance maintained by the contractor that excludes coverage for work contemplated in this contract shall be deemed unacceptable and shall be considered breach of contract.

The carrying of the insurance described shall in no way be interpreted as relieving the Contractor of any responsibility under this contract.

Should the Contractor engage a subcontractor or sub-subcontractor, the same conditions will apply under this Agreement to each subcontractor and sub-subcontractor.

The Contractor hereby waives all rights of subrogation against Okaloosa County and its employees under all the foregoing policies of insurance.

EXCESS/UMBRELLA INSURANCE

The Contractor shall have the right to meet the liability insurance requirements with the purchase of an EXCESS/UMBRELLA insurance policy. In all instances, the combination of primary and EXCESS/UMBRELLA liability coverage must equal or exceed the minimum liability insurance limits stated in this Agreement.

Attachment “C”

Title VI List of Pertinent Nondiscrimination Acts and Authorities

During the performance of this Agreement, the Contractor, for itself, its assignees, and successors in interest (hereinafter referred to as the “Contractor”), as applicable, agrees to comply with the following non-discrimination statutes and authorities; including but not limited to:

- Title VI of the Civil Rights Act of 1964 (42 USC § 2000d *et seq.*, 78 stat. 252) (prohibits discrimination on the basis of race, color, national origin);
- 49 CFR part 21 (Non-discrimination in Federally-assisted programs of the Department of Transportation—Effectuation of Title VI of the Civil Rights Act of 1964);
- The Uniform Relocation Assistance and Real Property Acquisition Policies Act of 1970, (42 USC § 4601) (prohibits unfair treatment of persons displaced or whose property has been acquired because of Federal or Federal-aid programs and projects);
- Section 504 of the Rehabilitation Act of 1973 (29 USC § 794 *et seq.*), as amended (prohibits discrimination on the basis of disability); and 49 CFR part 27;
- The Age Discrimination Act of 1975, as amended (42 USC § 6101 *et seq.*) (prohibits discrimination on the basis of age);
- Airport and Airway Improvement Act of 1982 (49 USC § 471, Section 47123), as amended (prohibits discrimination based on race, creed, color, national origin, or sex);
- The Civil Rights Restoration Act of 1987 (PL 100-209) (broadened the scope, coverage and applicability of Title VI of the Civil Rights Act of 1964, the Age Discrimination Act of 1975 and Section 504 of the Rehabilitation Act of 1973, by expanding the definition of the terms “programs or activities” to include all of the programs or activities of the Federal-aid recipients, sub-recipients and contractors, whether such programs or activities are Federally funded or not);
- Titles II and III of the Americans with Disabilities Act of 1990, which prohibit discrimination on the basis of disability in the operation of public entities, public and private transportation systems, places of public accommodation, and certain testing entities (42 USC §§ 12131 – 12189) as implemented by U.S. Department of Transportation regulations at 49 CFR parts 37 and 38;
- The Federal Aviation Administration’s Nondiscrimination statute (49 USC § 47123) (prohibits discrimination on the basis of race, color, national origin, and sex);
- Executive Order 12898, Federal Actions to Address Environmental Justice in Minority Populations and Low-Income Populations, which ensures nondiscrimination against minority populations by discouraging programs, policies, and activities with disproportionately high and adverse human health or environmental effects on minority and low-income populations;
- Executive Order 13166, Improving Access to Services for Persons with Limited English Proficiency, and resulting agency guidance, national origin discrimination includes discrimination because of limited English proficiency (LEP). To ensure compliance with Title VI, you must take reasonable steps to ensure that LEP persons have meaningful access to your programs (70 Fed. Reg. at 74087 to 74100);
- Title IX of the Education Amendments of 1972, as amended, which prohibits you from discriminating because of sex in education programs or activities (20 USC 1681 *et seq.*).